

Build something great™

BORAL

YOUR GUIDE TO ROOF TILES

Helping you choose the Best
Roof Tiles for your Home

20
20



CONTENTS

Introduction	3
Why choose roof tiles	4
Types of roof tiles	6
How to choose a roof tile	8
Roof structure	10
Roof styles	13
Advantages of a new roof	14
Living energy-wise	18
Roofing terms	21
Frequently asked questions	22



INTRODUCTION

Your home is one of your most important assets. The roof protects and defines your home. It's also the single largest surface area of a house, making it one of the most important architectural features of the structure.

If you're building your dream home from scratch, extending, renovating or re-roofing, it's important to choose carefully. Your roof should be strong and resilient while perfectly complementing your home's architectural style.

This guide is designed to help you make the right choice. It introduces some basic roofing information and takes the guess work out of making decisions about your roof.

WHY CHOOSE ROOF TILES?

Roof tiles offer unsurpassed style, versatility and performance.



DESIGN
FLEXIBILITY

COLOUR
RETENTION (DESIGNER
CERAMIC,
TERRACOTTA)

LONG LASTING
BUILT TO LAST

LOW-
MAINTENANCE

SALT-SAFE &
FROST-RESISTANT

ACOUSTIC
PERFORMANCE

FIRE
RESISTANCE

THERMAL
PERFORMANCE

WIND
RESISTANCE

RAIN WATER
RETENTION

The extensive range and unique design of individual tile profiles mean enhanced flexibility in roof design to complement a wide range of architectural styles and specifications. Designer Ceramic, Terracotta and Concrete roof tiles each offer a different aesthetic and surface finish.

Designer Ceramic and Terracotta tiles are crafted from prepared natural clays that are kiln-fired to temperatures of 1100°C. This means the colour is locked in, so the tiles retain their original appearance as they age. Concrete tiles will weather with age to a matt finish and will lose some colour over time. This colour loss does not affect the tile's performance.

With a 60-year performance guarantee for Designer Ceramic tiles, 50-year performance guarantee for Terracotta tiles and 20-years for Concrete tiles, Boral roof tiles are built to last and withstand harsh climatic conditions and marine environments.

Once tiles are installed there is little maintenance required. Should a section of the roof ever be damaged, there is the added advantage of individual tile replacement. This is a cost-effective option compared with large steel sheets.

Designer Ceramic, Terracotta and Concrete tiles are salt-safe and frost-resistant, making them suitable for any location. Coastal homes can be more prone to salt attack, the process by which salt crystals break down the materials used in and around the home¹. All Boral tiles are exposure-grade and suitable for salt-exposed environments, including harsh marine areas.

The density of tiles helps reduce external sound, such as aircraft and road noise and, particularly, rain and hail. In fact, roof tiles have a sound reduction potential twice that of sheet steel roofing².

Designer Ceramic, Terracotta and Concrete roof tiles are made from non-combustible materials and can safely be used in bushfire prone areas, including the highest prone areas (BAL-FZ). When installed to the Australian Standards, they provide superior protection against radiant heat from bushfires.

Roof tiles can help you enjoy more comfortable living in summer and winter. The thermal mass of clay and concrete materials when used correctly can result in advantageous insulation properties, in addition to considerations such as sarking and overall solar design.

The weight of the roofing material itself impacts performance in high wind areas. The dead load of roof tiles reduces the impact of uplift pressures in comparison to lighter-weight materials such as steel sheeting³.

Boral roof tiles are made to Australian Standards and are suitable for the collection of rain water.

1. "A technical guide: Salt attack and rising damp," David Young, 2008.

2. "Roof Acoustic Performance- Noise Attenuation," Max Granger, Roof Tile Association of Australia, 2013.

3. "The Properties of Roof Tiles," Roof Tile Association of Australia, 2013.

TYPES OF ROOF TILES

Boral has an extensive range of designer ceramic, terracotta and concrete roof tiles manufactured in Australia for Australian conditions. We offer roofing solutions to suit almost any style of home.

DESIGNER CERAMIC

The Designer Ceramic range is elegant and shaped for design flexibility. Uniquely striking, with colour integrity and low maintenance. These state of the art tiles offer an exclusive streamlined look, with minimalist textures that compliment a modern home.

TERRACOTTA

Meaning 'baked earth' in Italian, terracotta is a natural clay product that has been used throughout the ages for protection against the elements.

Boral Designer Ceramic and Terracotta tiles are manufactured using carefully-selected clays that are kiln-fired to temperatures of 1100°C, resulting in a strong yet lightweight roofing material of exceptional quality.

The outstanding colour performance is achieved through the firing process known as vitrification. Clay and glaze materials fired at high temperatures melt and fuse together resulting in a finished tile resistant to harsh UV exposure.

Designer Ceramic: Shingle™ Fossil

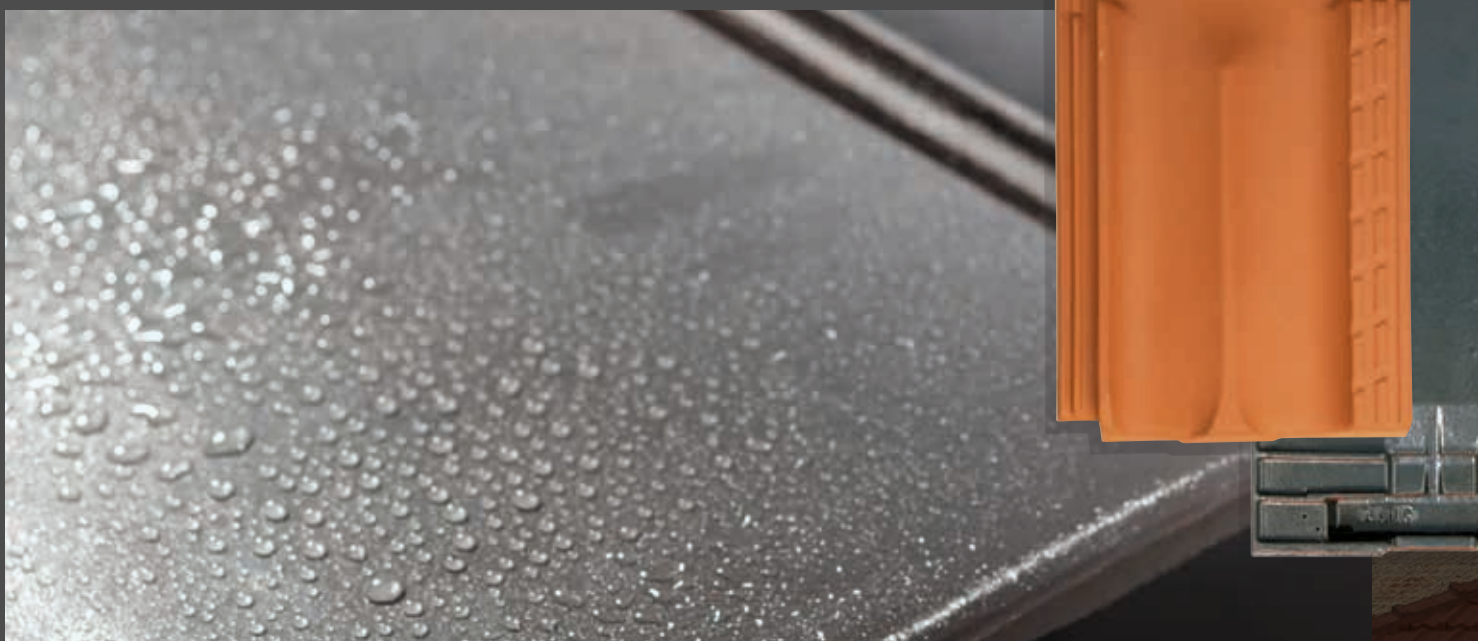

Although architectural styles and materials come and go, the roof tile has endured the test of time, remaining one of the most popular forms of roofing materials.

CONCRETE

Concrete tiles are made from sand and cement with a pigmented colour coat. This can replicate the appearance of a broad array of distinctive tile designs, while remaining relatively cost-effective.

Boral concrete tiles are manufactured using an extrusion process resulting in the utmost strength and density. After moulding and colouring we apply a sealant finish that protects against efflorescence, a salty white deposit that can form on masonry and concrete products.



HOW TO CHOOSE A ROOF TILE

Follow these five simple steps to choose the right Boral roof tile for your home:



Designer Ceramic Vertical Roof Tile

STEP 1: MATERIAL

Your choice of material will come down to personal preference in shape, colour and finish. All Boral roof tiles are built to last, with a 60-year performance guarantee for Designer Ceramic, 50-year guarantee for Terracotta and 20-years on concrete tiles. Some customers prefer the natural beauty of terracotta while others appreciate the versatility of concrete.

Designer Ceramic, Terracotta and Concrete tiles also differ in size and shape. This means there will be differences in the number of tiles per square metre, as well as in the system of aligning the tiles on the roof next to each other (called the bond).

Designer Ceramic, Terracotta tiles are slightly smaller than concrete tiles. Depending on the complexity of the roof design, an average of 11 tiles are needed per square metre. They are designed to interlock at both the head and the sides and are laid in either a cross-bond or straight-bond pattern, depending on the profile.

Because concrete tiles are slightly larger, an average of 9 concrete tiles are needed per square metre. These tiles are designed to interlock at the sides only but can also be laid cross-bond or straight-bond.

Remember, all Boral roof tiles are salt-safe, frost-resistant and non-combustible, making them suitable for any location, including coastal areas and bushfire-prone areas.

cross-bond pattern

straight-bond pattern

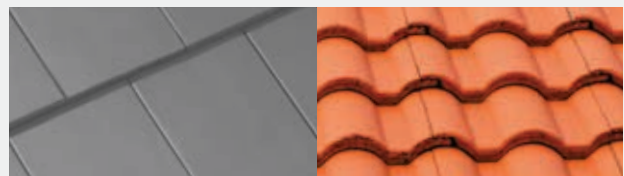

STEP 2: PROFILE

A tile's profile refers to its shape and design. Boral roof tile profiles range from smooth flat tiles to prominent undulations or waves on the surface of the tile. Key considerations when choosing a tile profile will be the pitch of your roof as well as its style. Below is a chart to help you choose a profile for your tiles. You will need to find out the pitch of your roof when selecting a profile as some tiles require a minimum pitch.

DESIGNER CERAMIC

CONTEMPORARY FLAT TILES



Shingle™

Minimum Pitch:
Without sarking 20°
With sarking 18°
All States



Artline®

Minimum Pitch:
Without sarking 20°
With sarking 18°
All States



Wave™

Minimum Pitch:
Without sarking 20°
With sarking 18°
All States

CLASSIC TERRACOTTA

SHAPED TILES



French™

Minimum Pitch:
Without sarking 20°
With sarking 15°
All States



Swiss™

Minimum Pitch:
With sarking 22°
Sarking is Mandatory
All States

CONCRETE

SHAPED TILES



***Contour™**

Minimum Pitch:
Without sarking 20°
With sarking 15°
NSW, VIC



Slimline™

Minimum Pitch:
Without sarking 20°
With sarking 15°
NSW, VIC, QLD



Macquarie™

Minimum Pitch:
Without sarking 20°
With sarking 15°
NSW, VIC, SA



Capri™

Minimum Pitch:
Without sarking 20°
With sarking 15°
SA

FLAT TILES



Vogue™

Minimum Pitch:
With sarking 20°
Sarking is Mandatory
All States



Linea™

Minimum Pitch:
Without sarking 20°
With sarking 20°#
All States



Striata™

Minimum Pitch:
Without sarking 20°
With sarking 20°#
SA, VIC

ROOF TILE PITCHES

Minimum Roof Pitch* (Degrees)								
Profile	Without Sarking				With Sarking			
	NSW	VIC	SA	QLD	NSW	VIC	SA	QLD
Designer Ceramic								
Artline®	20°	20°	20°	20°	18°	18°	18°	18°
Shingle™	20°	20°	20°	20°	18°	18°	18°	18°
Wave™	20°	20°	20°	20°	18°	18°	18°	18°
Terracotta								
French™	20°	20°	20°	20°	Sarking is Mandatory			
Swiss™	22°	22°	22°	22°				
Concrete								
Vogue™	Sarking is Mandatory		20°	Sarking is Mandatory	20°	20°	18°	20°
Linea™	-	20°	20°	-	-	20°	18°	-
Striata™	-	20°	20°	-	-	20°	18°	-
Capri™	-	-	20°	-	-	-	15°	-
Contour™	20°	20°*	-	-	15°	15°	-	-
Macquarie™	20°	20°	20°	20°	15°	15°	15°	15°
Slimline™	20°	20°	20°	20°	15°	15°	15°	15°

*To be laid in a cross bond pitches 20° or lower

STEP 3: COLOUR AND FINISH

Colour can have a fundamental influence on the style, character and essence of your home. It's easy to feel overwhelmed by the sheer number of options available but by planning well in advance and following a few simple guidelines, you can create a look you will admire for years to come.

Here are five tips to remember when choosing a roof tile colour for your home:

- 1.** A good place to start is by collecting reference material such as photos you've taken yourself or found online. Visiting builder display homes will also give you an abundance of colour ideas.
As a general rule, look for colours that together are either in harmony or contrast. Next are exterior walls, garage doors and window frames.
- 2.** The architectural style of your home and its environment (including surrounding homes) is a major factor.
- 3.** Primary considerations in selecting roof colour are the guttering and fascia finish of your home, as these are in closest proximity.
- 4.** Visit a display centre to see the products in real life and how all the exterior colours work together. Make a shortlist of your selections and ask to take a sample home with you so you can think about it.
- 5.** Trust your instincts and choose what's right for you, not your friends or family.

Boral offers a palette of warm, cool and neutral tones in its Designer Ceramic, Terracotta and Concrete ranges.



Un glazed



Random Glaze



Glazed



Matt



Satin - Designer only

Finish There is a large assortment of colours available across the Designer Ceramic and Terracotta collection. These are applied in four different finishes: full glazed (in either high-gloss or matt); semi-glazed, for a traditional mottled appearance; or unglazed for the look of natural clay.

There are two finish options in the concrete collection: Colour-On and Colour-Through. As the name suggests, Colour-On is a coating applied to the surface of each wet extruded tile, whereas in our Colour-Through tiles, the oxides are blended through the concrete mix for a smooth surface finish and longer-lasting colour. We apply to both options a tinted acrylic sealant that protects the tile during the initial curing stage.

STEP 4: ACCESSORIES

Finally, it's time to accessorise your roof and, when it comes to roofing, it's not merely a case of optional extras. Some accessories, such as sarking, have become essential to enhance functional performance. Others are designed for their aesthetic qualities and, like everything else in your home, the right accompaniments can turn a generic feature into a standout one.

Boral's roofing accessories include:

Sarking: This reflective foil insulation is recommended for all tiled roofs to enhance energy efficiency and weather-proofing (see page 17 for more details). It must be installed at the time of building.

Accent Ridge™ for Designer Ceramic tiles: Accent Ridge is a low-line ridge system to enhance tiles. Accent Ridge seamlessly aligns ridge capping end-to-end in one smooth line without steps.



Other accessories Depending on the style of your house and design of the roof, Boral offers other ways to finish off ridges and apices as well as some more traditional crests and finials.

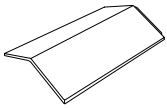

Accent Ridge

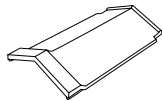

Vee Ridge

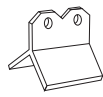

Ridge Crest

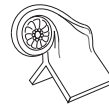

Gable Finial

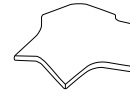

3 Way Apex

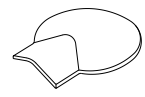

Spoon Apex

STEP 5: INSTALLATION

Getting a great roof is also dependent on good installation from a qualified installer. To be sure your roof is installed to Boral specifications we recommend our own supply-and-fix service, or an established installer.

Boral's supply-and-fix service for new homes means Boral organises all the materials required as well as the installation.

We can prepare an obligation-free quote, for services such as pre-handover roof inspections. For renovations, extensions and re-roofing, call us for an installer near you.

Boral's supply-and-fix service offers:

- Sales support
- Boral site supervisors
- Work Cover compliancy
- Technical support
- Fixing and product warranty
- Product estimates and quotations
- Trade qualified roof tilers
- Guard rail installation
- Pre-handover roof inspections available

Boral's supply-and-fix service is available in New South Wales, Victoria and South Australia.

ROOF STYLES

There are seven basic roof designs, often used in combination on the one house.

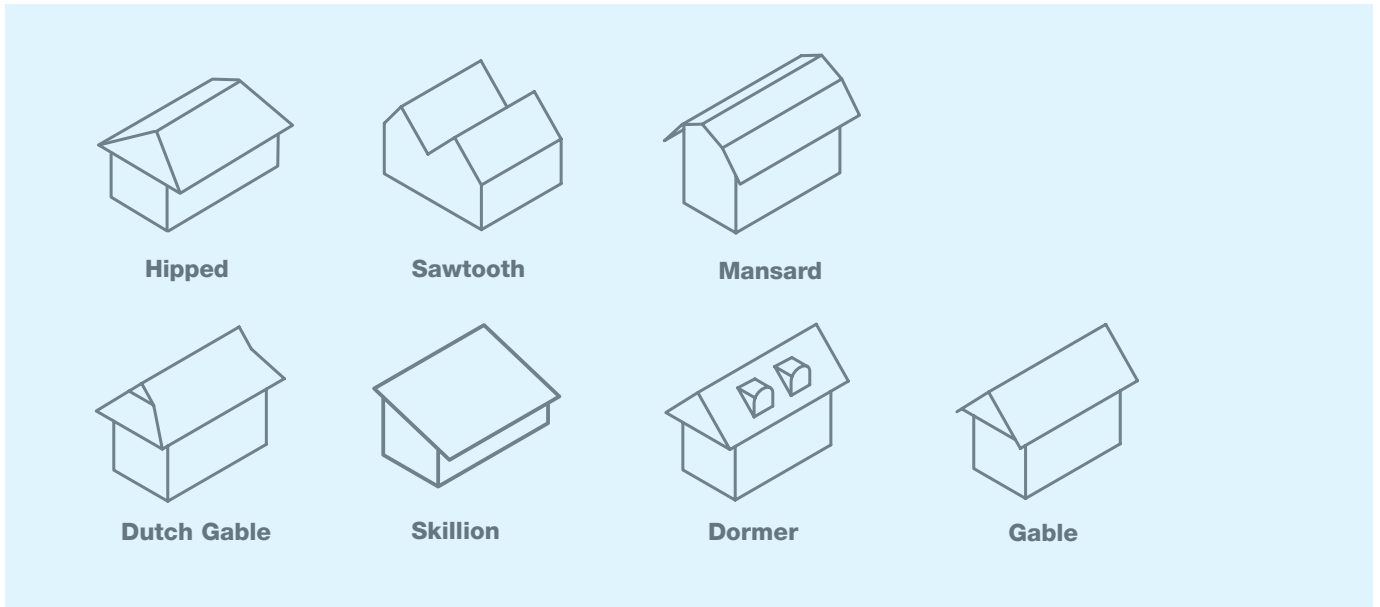

ROOF STRUCTURE

The design of a roof is expressed through two key elements: the supporting structure; and its covering material.

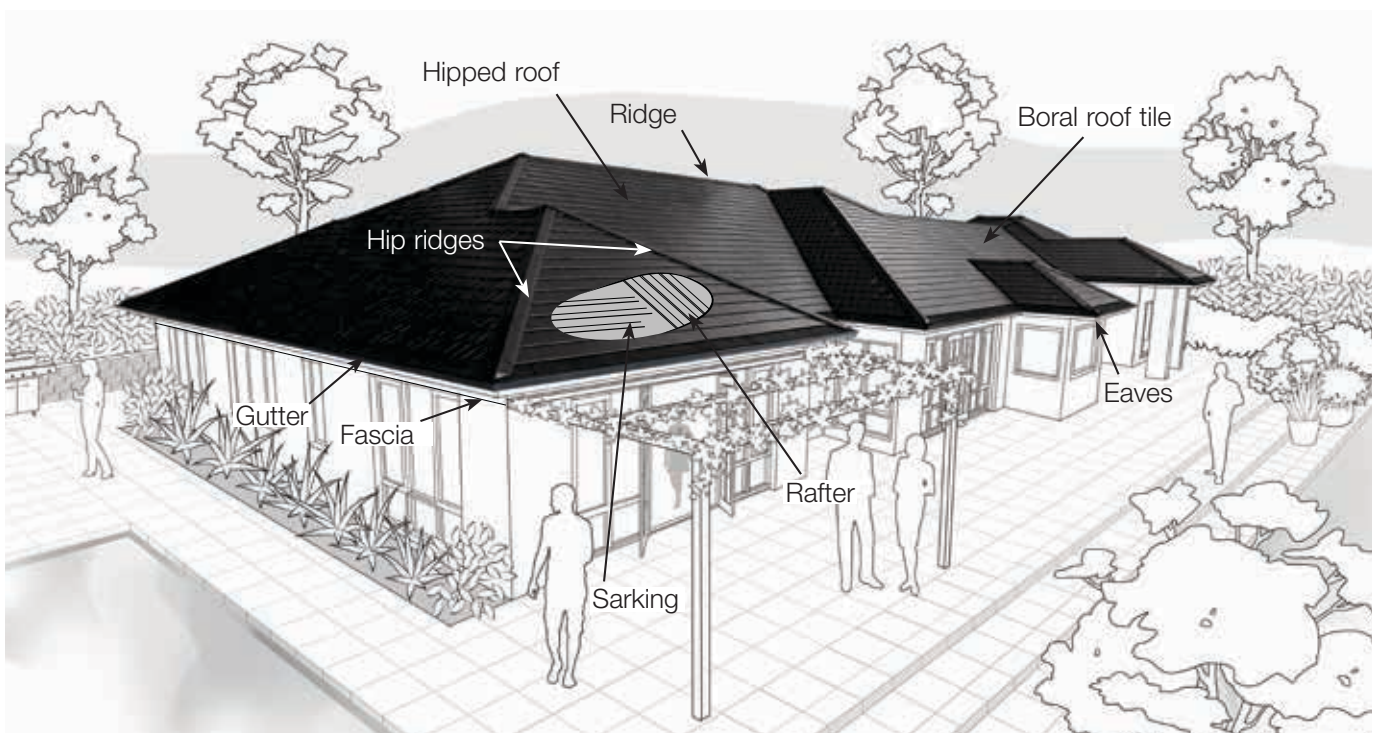

WHEN DOES IT MAKE SENSE TO RE-TILE?

- Rainwater is leaking into the roof space
- Gutters and downpipes aren't working the way they should
- You have an older home that requires a high level of general maintenance
- You are planning to extend the house or renovate

ADVANTAGES OF A NEW ROOF:

- Instantly update the look of your home and enhance your streetscape
- Fix any cracks or leaks and prevent them from recurring
- Forget the hassle of trying to match old tiles
- Install sarking if your roof doesn't already have it
- Incorporate better insulation and ventilation measures to improve indoor comfort



THE SEVEN STEP ROOF CHECK

A home renovation or extension is a good time to take a closer look at your existing roof. It's often easier than you think to completely update the look of your home while at the same time improving the comfort of your family. But before you can decide whether to replace tiles, re-spray or re-roof, a thorough roof assessment is required.

Boral always recommends that you use a qualified roofing tradesperson to undertake a roof assessment.



STEPS

1. Check roof for any cracked tiles, tile displacement or debris build-up
2. Check old cement mortar bedding
3. Check flashings, gutters and downpipes
4. Check whether sarking is installed as a barrier against dust, storms and bushfires
5. Check for sufficient ventilation to remove hot or damp air
6. Check for the need to re-insulate the ceiling with bulk insulation
7. Assess the need to replace individual tiles, re-spray or re-roof and sark



Designer Ceramic:
Artline® Onyx

DEMYSTIFYING ROOF RE-SPRAYS

Many companies offer roof re-coating or re-spraying as an option to rejuvenate concrete tiles.

The important point to remember is that roof re-sprays are for aesthetics only. A regular coating over your concrete tiles does not fix cracks or leaks and will not enhance the performance of your roof.

Alternatively, designer ceramic and terracotta tiles are glazed and kiln-fired and retain their colour. These tiles will never require a re-spray.



LIVING ENERGY WISE

An energy-wise home uses the best combination of sustainable building considerations such as site orientation, wall and ceiling insulation, ventilation, and materials to reduce overall energy consumption.

The Nationwide House Energy Rating Scheme (NatHERS) uses computer simulations to assess the potential thermal comfort of a home, delivering an energy rating. The aim is to integrate sustainability into design development from the outset. The position of a house relative to the sun will drive considerations to best utilise its natural energy for cool summers and warm winters indoors. This is called 'passive solar design'.

The principles are surprisingly simple, but the end result is a more comfortable home naturally, year-round, benefiting both the environment and your wallet.

LIVING ENERGY WISE

ENERGY EFFICIENT ROOF SYSTEMS

Concrete: Contour™ Gunmetal

THERMAL PERFORMANCE

Thermal mass can contribute to a roofs overall performance.

Thermal mass is the ability of a material to retain heat and is an important aspect in most Australian climates where low minimum temperatures and high maximum temperatures make it desirable to create a more comfortable middle ground.

High thermal mass materials such as clay and concrete, when used correctly, are able to even out the temperature by slowly absorbing heat energy during the day and slowly releasing it through the night. Another consideration to performance is the proportion of solar energy the roof takes in and transmits through the roof space, due to the colour of the roof. This is known as solar absorptance. A lower solar absorptance, generally lighter colours, can keep the roof space and dwelling cooler on a hot day. The amount not absorbed is reflected off the roofing material (solar reflectance) back into the atmosphere.

Colours, however, have a limited impact on thermal performance when elements such as sarking, insulation and ventilation are incorporated.

SHADING

Features like extended eaves are popular solar design attributes that provide desirable shading in summer while still letting in the low winter sun.



VENTILATION

Cross-ventilation, with at least two openings in each room, allows a breeze to circulate for a cooler home and is an important aspect in the passive design of a home. Ventilation is also of high importance in the roof space providing a buffer area between the inside and outside, helping regulate air flow all year round. Particularly in warmer climates, it helps to minimise radiant heat building up in the day while allowing it to escape in the evening.

WATER COLLECTION

The ability to efficiently collect rain water for tanks is directly affected by the roof's span. It is also important to ensure the guttering and downpipe system is of adequate size. Tiled roofs of greater pitch will more efficiently deliver rainwater to this system thanks to the pull of gravity.

SARKING

Insulating walls and ceilings is one of the best ways to efficiently regulate temperature. Equally important is the reflective, non-flammable foil insulation called sarking.

It is a thin blue membrane that sits between the rafters and roof tile battens and is recommended for all tiled roofs to maximise the energy efficiency of your home and to ensure your roof remains water tight.



Aside from the tiles themselves, sarking delivers front line protection against the elements and has two primary purposes.

One

The reflective foil finish minimises heat transmission into the roof space, which can dramatically reduce the temperature in the roof on hot days, allowing conventional insulation like fibreglass batts to work more effectively. In winter it works in the reverse by reducing heat loss through the roof.

Two

Sarking is also a secondary barrier to water entry, providing an extra level of security against unpredictable storms.

Sarking is **mandatory** in bush fire zones, in high wind areas and when roof pitches are less than 18° to protect against wind driven rain.

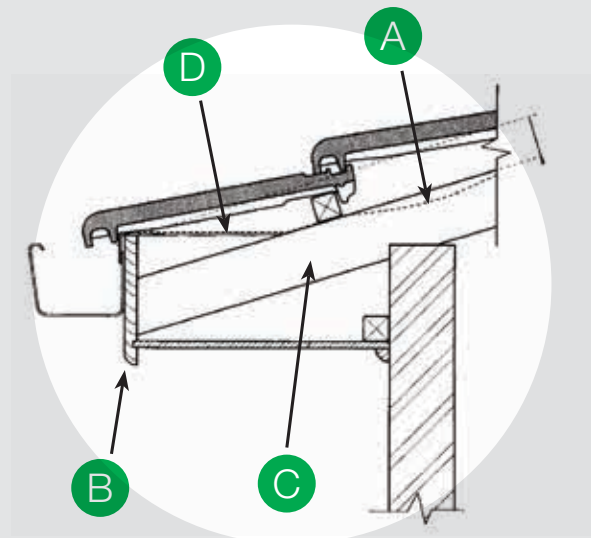

- A. Sarking
- B. Fascia Board
- C. Rafter
- D. Anti-ponding Board

FREQUENTLY ASKED QUESTIONS

How do I best maintain my roof?

Maintaining tiles requires minimal effort, however maintenance should still be done regularly.

To reduce the risk of leaks:

- Clean out blocked gutters, valleys and downpipes
- Re-bed or re-point hip and ridge capping if the cement mortar bedding is cracked or broken
- Replace any individual cracked or broken tiles and make sure all tiles are positioned correctly
- Remove any build-up of dirt or debris which may block the drainage channels under the 'side laps' on individual tiles
- Correct any blocked, damaged or displaced flashings

Boral always recommends contacting a roof maintenance specialist who can safely inspect, clean or fix your roof.

Can I respray tiled roofs?

Depending on the material and method used it is completely acceptable to respray concrete roof tiles. However, never respray terracotta as it would interfere with the natural quality of the clay and, over time, the coating will peel away from the glazed surface.

Why is concrete not as colour-fast as designer ceramic and terracotta?

Concrete tiles are not glazed so, like all exterior building materials, they are subject to UV radiation and atmospheric pollutants. As a result they will weather with age to a matt finish and will lose some colour over time. Ceramic & Terracotta tiles are kiln-fired with a vitreous coating that makes these tiles resistant to harsh UV exposure.

What is lichen?

Lichen or moss can start to grow on tiles after long periods but does not in any way indicate deterioration or affect the performance of tiles. It can be easily removed with a high pressure cleaner by a professional cleaning contractor.

What are the white streaks apparent on some roofs?

Sometimes the natural mineral salts in concrete can migrate to the surface in the form of whitish grey discolouration called efflorescence. This is not harmful, has no impact on the performance of the tile and will weather away over time.

I live near the water, is my warranty still valid?

The Boral roof tile guarantee is valid no matter where you build your home and not dependent on how close or far you are from the coast. All Boral roof tiles are salt-safe and can be used even in severe marine environments.

Can I choose Boral tiles even if my old tiles are another brand?

Possibly, your roof tiler might be able to work around different tile widths. If you are looking at re-tiling the whole roof, assess the condition of the existing timber battens, which support the tiles, as well as the sarking underlay that lies beneath. If either needs to be replaced or you don't have sarking, a re-roof is the recommended option. For extensions where you don't want to re-tile the whole roof, Boral tiles in the closest match can be installed on the new roof.

What if I have an old metal roof and would like to change to tile?

It all depends on the load capabilities of the existing roof frame, as tiles are heavier than metal sheeting. If you have a trussed roof frame, which comprises triangular units that are self-supporting to a pre-calculated load, an engineer's report will determine whether your roof can support tiles. Conventional roof frames are constructed on-site during the house framing phase of construction. They are more flexible, as they can shift the weight of the roof system to load-bearing walls. Tiled roofs require a load capacity of 60kg per square metre.

How can I make my roof as energy efficient as possible?

A major source of a home's heat gain or loss is through the roof, which in turn places a huge load on energy requirements for cooling and heating. The density of roof tiles combined with the use of effective insulation, ventilation and solar passive design principles creates a more effective barrier against the climate.





What is the sheen on new concrete tiles?

A tinted acrylic sealer is applied to concrete tiles for protection against efflorescence, which appears in the early stages as a whitish discolouration caused by mineral salts migrating to the surface. This has no impact on performance and weathers away over time, as does the sealer, which is designed to last only these initial years. Unlike Designer Ceramic and Terracotta tiles, Concrete tiles are not glazed, so as with other building materials subject to UV radiation, they will lose some colour over time.

Does Boral recommend spraying roofs with colour?

Depending on the material and method used it is acceptable to re-spray concrete roof tiles to enhance the colour. However, it must be understood that this will not enhance performance and if the roof is old, you could be much better off re-tiling. Never re-spray Designer Ceramic or Terracotta tiles, as the colour coat applied will peel away from the glazed surface over time.

I live in a high wind area; are tiles suitable?

Strong winds cause extensive damage to Australian roofs each year. Most people don't realise that the added weight of tiles actually helps to counteract uplifting wind forces during storms. Another consideration is the relative ease with which individual tiles can be refixed or replaced after a severe storm, compared to large metal sheets. Boral recommends sarking as an added protection barrier.

Do concrete tiles absorb moisture?

A common fallacy is that roof tiles are impacted by water absorption during severe downpours. However all Boral roof tiles comply with strict Australian Standards, which specify a maximum absorption of 10 per cent of their own weight.

What else do I need to know about roof maintenance?

It really does pay to regularly check gutters to clean out debris that can cause blockages and pooling on roofs. Blockages provide fuel for bushfires while pooled water can encourage mosquitoes to breed. Consider installing a mesh gutter guard to keep your gutters leaf-free, particularly if you harvest rainwater from the roof.

ROOFING TERMS

APEX	The intersection of all ascending hips where they meet either a ridge or another ascending hip.
BATTENS	Selected-sized timber fixed parallel to the eave line on which tiles are fixed.
BOND	The system of aligning tiles on the roof in relationship to each other. With straight-bond, the sides of tiles form straight lines from bottom to top. With staggered-, broken- or cross-bond, tiles in each alternate course overlap, by half, the tiles above and below them.
EAVES	The lowest overhanging part of a sloping roof, which projects beyond the external wall.
FASCIA BOARD	A wide board set vertically on edge, fixed to the rafter ends or wall plate or wall. It carries the gutter.
GABLE/ GABLE END	The triangular part of the end wall of a building with a sloping roof.
HIP	The edge formed by the meeting of two pitched roof surfaces.
HIP CAPPING	Or ridging. A shaped capping for hips to prevent water penetration.
PARAPET WALL	Usually a brick or timber structure rising above the roof line.
PITCH	The ratio of the height to the span of a roof, or its angle of inclination to the horizontal.
POINTING	A mixture of clean sand, cement and oxide colouring or a pre-mixed flexible material used for the completion of joints between ridge or hips and with roof tiles or tiles at gable ends.
RAFTER	A sloping timber extending from the eave to the ridge of a roof.
RIDGE	The apex of a roof, usually a horizontal line.
VALLEY	The intersection between two sloping surfaces of a roof, towards which water flows, the opposite of a hip.

For more information about Boral roof tiles

Call 1300 134 002

Visit boral.com.au/rooftiles or visit a display centre

New South Wales

Emu Plains - MacKellar Street Emu Plains 2750

Victoria

Springvale - 66-78 Tootal Road Dingley Village 3172

South Australia

Pooraka - 1161 Main North Road Pooraka 5095



Important Information: Product information contained in this leaflet is correct at the time of printing however is subject to change without notice. Some photos featured in this brochure are artist's impressions of how Boral roof tiles will look on a roof. Some images are computer generated. Please ensure you view a tile display before making a final decision. Colours shown are indicative only and should not be used for final selection. Roof tile colours may vary in shades throughout the manufacturing process therefore it is important that roof tiles are blended consistently across the roof. At Boral Roofing, all tiles are manufactured to the requirements of Australian Standard 2049 Roof tiles. Please ask for a copy of the Boral Roofing guarantee before making your purchase. During transportation and installation small blemishes such as scuffing and chip marks may occur. These are not considered a production fault and will not detract from the performance of the roof tile. © Copyright Boral Roofing – all rights reserved 2020. Boral, the Boral logo, Build something great, Shingle, Artline, Wave, French, Swiss, Contour, Slimline, Accent Ridge, Macquarie, Capri, Vogue, Linea, Striata are trade marks or registered trade marks of Boral Limited or one of its subsidiaries. Boral Roofing ABN 34 002 944 694. Correct as at June 2020.