

YAMAHA

Model Identification/ignition System



Model Description	Horsepower	Trim & Tilt/Starting Method	Shaft Length	Control Method	Model Year	Special Model Variation Code (Used on 25HP engines)
B = Inshore series C = C series model CV = C series D = Twin rotating propellers DX = Twin rotating propellers OX66 EFI E = Enduro series model F = Four stroke engine model LF = Left hand four stroke L = Left hand engine model LX = Left hand OX66 EFI LZ = Left hand HPDI P = Pro series model PX = Pro series OX66 EFI S = Saltwater series model SX = Saltwater series OX66 EFI T = Four stroke engine with high thrust V = V max series model VX = V max OX66 EFI VZ = V max HPDI Z = HPDI series	Example: 6 9.9 200 250	T = Power tilt or trim/tilt (1984-1990) P = Power tilt with electric start E = Electric start (1984-1990) M = Manual tilt with manual start	S = 15" L = 20" X = 25" U = 30"	R = Remote control H = Tiller handle J = Jet drive unit	N = 1984 K = 1985 J = 1986 H = 1987 G = 1988 F = 1989 D = 1990 P = 1991 Q = 1992 R = 1993 S = 1994 T = 1995 U = 1996 V = 1997 W = 1998 X = 1999 Y = 2000 Z = 2001 A = 2002 B = 2003 C = 2004 D = 2005	2 = 3 Cyl. 1997 3 = 3 Cyl.

Starting in April 2005 (2006 Model Year and newer) Yamaha no longer designated model years at the end of the model number identification. Beginning at this time any subsequent "new model" will have a letter designation between the Horsepower and the Control / Tilt Method.

Example:

VZ300TLRD = 2005

VZ300TLR = New model after April 2005.

VZ300BTLR = Newest Model and direct replacement for previous models.

EXAMPLE: SX150TLRY - Saltwater EFI, 150 HP, Trim & Tilt w/electric start, 20", Remote control, 2000 model

OUTBOARD

 <p>18-5110 IGNITION COIL Replaces: 6E5-85570-11-00 For: 115 (4 cyl.) 1985-91</p>	 <p>18-5111 IGNITION COIL Replaces: 697-85570-11-00 For: 55 (2 cyl.) 1989-94</p>	 <p>18-5112 IGNITION COIL Replaces: 6E7-85570-19-00, 680-85570-09-00 For: 9.9/15 1988-93</p>	 <p>18-5128 IGNITION COIL Replaces: 6R3-85570-01-00 For: 115/130/150HP (1994-04) 175HP (1994-95, 1997-98, 2000) 200HP (1994-98) 225HP (1997) B115HP 1998-99) C115HP (1997-98) for late model V4 & V6</p>
 <p>MP39160 MOMENTARY PUSH SWITCH For outboard installations.</p>	 <p>MP51020 – CLAMSHELL MP51022 – BULK 100 PCS/CTN IGNITION SWITCH Replaces: 703-82510-12-00 Yamaha Control Box 2 & 4 stroke Colors on wires match factory color codes</p>	 <p>MP51030 – CLAMSHELL MP51032 – BULK 100 PCS/CTN IGNITION SWITCH Replaces: 61B-82510-01-00 Yamaha Dash Mount 2 Stroke Dual Engine Application Colors on wires match factory color codes</p>	
 <p>MP51040 – CLAMSHELL MP51042 – BULK 100 PCS/CTN IGNITION SWITCH Replaces: 703-82510-43-00 Yamaha Control Box 2 & 4 stroke Push to Choke Colors on wires match factory color codes</p>	 <p>MP51050 – CLAMSHELL MP51052 – BULK 100 PCS/CTN IGNITION SWITCH Replaces: 6K1-82510-06-00 Yamaha Dash Mount 2 & 4 Stroke Dual Engine Application, Push to Choke Colors on wires match factory color codes</p>	 <p>18-5225 SPARK PLUG WIRE KIT Kit includes 25 ft. Roll of 7 MM Hypalon Ignition Wire With a Metallic Core and a Large Assortment of Three Different End Fittings to Fit Outboard Motors.</p>	

 <p>18-5226 IGNITION WIRE Metallic Core 100' Spool 7mm Hypalon</p>	<p>PKG. OF 10</p>  <p>18-5750 18-5750-9① UNIVERSAL SPARK PLUG BOOTS Supplied complete w/Terminal Connector Replaces: OMC 581027, 580339</p>	 <p>18-5752 UNIVERSAL SPARK PLUG BOOTS 8mm</p>
<p>PKG. OF 10</p>  <p>18-5224 18-5224-9① SPARK PLUG WIRE TERMINAL Replaces: Mercury 20121 OMC 510364</p>	 <p>18-5819 SOLENOID Replaces: 65W-81941-00-00 For: F25 (1998-04), F30 (2001-04), F40 (2000-04)</p>	 <p>18-5821 STARTER SOLENOID Replaces: 6G1-81941-10-00 Fits: 9.9/15(1988-97), 20(1996-97), 25(1985, 1988-99), 30(1985-87, 1989-93, 1996-99, 2001), 40(1989-90, 1992-01), 50(1989-97, 1999-02), 1990(1992-02), F15(1998-03), F40(1999), F50(1996-02), F60(2002-03), F75(2003-04), F80(1999-03), F90(2003-04), F100(1999-02)</p>
 <p>Standard Rotation CCW Rotation</p> <p>If flywheel rotates to the left & distributor rotor turns clockwise</p> <p>If flywheel rotates to the right & distributor rotor counter clockwise</p>	 <p>18-6410 OUTBOARD STARTER Replaces: Yamaha 689-81800-13-00, 689-81800-11, 689-81800-12 Fits: 25-40HP (11 tooth)</p>	 <p>18-6411 OUTBOARD STARTER Replaces: 6H3-81800-11-00, 6H3-81800-10 Fits: 60HP</p>
 <p>18-6412 OUTBOARD STARTER Replaces: 697-81800-12, 99999-03249-00 Fits: 55-60HP 2 cylinder (9 tooth)</p>	 <p>18-6413 OUTBOARD STARTER Replaces: 6E5-81800-11-00, 6E5-81800-12-00 Fits: 55-60HP 2 cylinder (9 tooth)</p>	

OUTBOARD

① Priced per Package

<p style="text-align: right;">CE</p>  <p style="text-align: center;">18-6415 OUTBOARD STARTER Replaces: 6N7-81800-10-00 Fits: 115-250HP (9 tooth)</p>	<p style="text-align: right;">CE</p>  <p style="text-align: center;">18-6420 OUTBOARD STARTER Replaces: 6L2-81800-20-00 Fits: 20HP MLHU & MSHU (1996), 20HP MLHV & MSHV 1997 25 (1988-98)</p>
<p style="text-align: right;">CE</p>  <p style="text-align: center;">18-6421 OUTBOARD STARTER Replaces: 6F5-81800-11, 6J4-81800-01-00 Fits: 25HP (1999&2001), 30HP (1996-99 & 2001), 40HP (1992-03) C40 1997-02, P40 (1998), 50 (1992-97 & 2000 & 2002-03) C50 (1998-01), P50 (1993-96)</p>	<p style="text-align: right;">CE</p>  <p style="text-align: center;">18-6422 OUTBOARD STARTER Replaces: 6H4-81800-12-00 Fits: 40HP (1984-86), 50HP (1986-88), Pro 50 (1987-88)</p>
<p style="text-align: right;">CE</p>  <p style="text-align: center;">18-6423 OUTBOARD STARTER Replaces: 688-81800-12-00 Fits: C75 (1994-96), (1998-99), P75 (1996-99), C80 TLRV (1997), C85 (1991-96), CV85 (1990), 90 (1984-03), B90 (1998-99) C90 (1997-01)</p>	<p style="text-align: right;">CE</p>  <p style="text-align: center;">18-6424 OUTBOARD STARTER Replaces: 61A-81800-00, 61A-81800-01 Fits: V200 (1998-99), VX200 & VX225 (2001-03) LX225 & LX250 (2000-03), S225 & S250 (1996-99) 225 (1994-96), 250 (1990-92) & (1994-95), L225 (1994-99) L250 (1990-99), SX225 & SX250 (2000-03)</p>
<p style="text-align: right;">CE</p>  <p style="text-align: center;">18-6425 OUTBOARD STARTER Replaces: 67F-81800-02-00 Fits: F75 (2003), F80 (2001-02), F90 (2003), F100 (2001-02)</p>	<p style="text-align: right;">CE</p>  <p style="text-align: center;">18-6426 OUTBOARD STARTER Replaces: 68F-81800-01-00 Fits: LZ&Z150 (2001-03), VZ&Z150 (2000-03), VZ & Z175 (2001-03), LZ200 (2000-03), Z200 (2000-02), VZ200 (2001-03)</p>

 <p>18-6427 OUTBOARD STARTER Replaces: 68V-81800-01-00 Fits: F115 2001-03</p>	<p>CE</p>  <p>18-56002 BRUSH HOLDER ASSY Replaces: 689-81840-11-00 Fits: F6/F8/T8 (2001-05), F9.9 (1985-90,1999-05), T9.9 (1991-97,1999,2001-05), 25 (1984-87)(1999-00), C25 (1991,1993-97), CV25 (1990), 30 (1984-01), C30 (1991-97), CV30 (1990), 40 (1984-05), P40 (1998), C40 (1991-01), CV40 (1990), 50 (1986-05), C50 (1998-01), P50 (1991-96), PRO50 (1987-90), 60 (2001-05), C60 (1996-01), P60 (1991-99), 70 (1984-05), C70(2000-01) Use with 18-6410 Starter</p>	
 <p>18-56004 BRUSH HOLDER ASSY Replaces: 663-81840-11-00 Fits starters: 689-81800-13-00(18-6410), 6H3-81800-11-00(18-6410), 6F5-81800-11-00,6J4-81800-01-00 (18-6421)6H4-81800-12-00(18-6422), 697-81800-12, 99999-03249-00-00 (18-6412)</p>	 <p>18-56005 BRUSH HOLDER ASSY Replaces: 6E5-81840-10-00 Fits starters: 689-81800-13-00(18-6410), 6H3-81800-11-00(18-6410), 6F5-81800-11-00,6J481800-01-00(18-6421) 6H4-81800-12-00(18-6422) 6E5-81800-11-00, 6E5-81800-12-00 (18-6413)</p>	
 <p>18-56006 BRUSH HOLDER ASSY Replaces: 6N7-81840-00-00 Fits:115,130,150 HP (1997-04), 175,200 HP (1997-98), 225 HP (1997) Use with 18-6415 Starter</p>	 <p>18-56007 BRUSH HOLDER ASSY Replaces: 61A-81840-00-00 Fits starters: 61A-81800-00-00, 61A-81800-01-00, 69L-81800-00-00,(18-6424) Fits:225 (1991-96), 250 (1990-95), L225 (1994-99), L250 (1990-99), LX225,LX250(2000-03), P150,P175 (1994-96), P200 1991-96, S225/S250 1996-99), SX225,SX250 (2000-03), V200/V225 (1998-99), VX200 (2000-05), VX225 (2000-04), VX250 (2002-04) Use with 18-6424 Starter</p>	
 <p>18-6798 TRIM MOTOR Replaces: 69J-43880-00-00, 60V-43880-00-00 Fits: F200, F225 (2004-06), F250 (2005-06), LF200, LF225, LF250, LZ200, LZ225, LZ250 (2004-06)</p>	 <p>18-6259 TILT/TRIM MOTOR Replaces: 6H1-43880-00-00 Fits:70/90HP (1987-91), C85/P60HP (1991)</p>	 <p>18-6787 TILT/TRIM MOTOR Replaces: 67F-43880-00-00 Fits: Yamaha 4-Stroke F75 (2003-04), F80 (1999-03), F90 (2003-04), F100 (1999-02)</p>

OUTBOARD



18-6788
TILT/TRIM MOTOR
Replaces: 6H5-43880-02-00
Fits: Yamaha 40-50hp (1985-92)



18-6789
TILT/TRIM MOTOR
Replaces: 62X-43880-09-00
Fits: Yamaha 40-100hp (1995-03)



18-6760
TRIM MOTOR
Replaces: 6G5-43880-02-00
For: 115-200HP (1987-96)



18-6781
TILT/TRIM MOTOR
Replaces: 6HI-43880-02-00
2-wire connection, 3 bolt mount
For: 40HP (1994) 50HP (1992-95) 60HP (1997-up) 70HP (1996-up) 90HP (1992-up)



18-6782
TILT/TRIM MOTOR
Replaces: 6IA-43880-01-00, 61A-43880-02-00
3-bolt mount, 4 wire connection For: 225-250HP



18-6783
TILT/TRIM MOTOR
Replaces: 64E-43880-00-00, 64E-43880-01-00
2-wire ring terminal connection 4-bolt mount
For: 115-225HP (1997-2002)



18-9802
TIMING LIGHT
Self-powered accurate
up to 10,000 RPM's



18-7002
CARBURETOR KIT
Replaces: 6E5-W0093-06-00
Fits: 115 (1986-88,1992-93, 1995), 130 (1988,1992-93, 1995), 150, 175 (1986-87, 1992-95), 200 (1986-87,1992-95), 225 (1992-93)

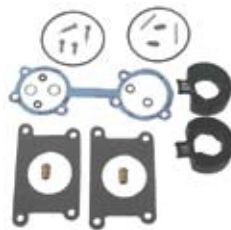

18-7290*
CARB KIT
Replaces: 696-W0093-02-00
*Kit contains enough components to rebuild 2 carburetors









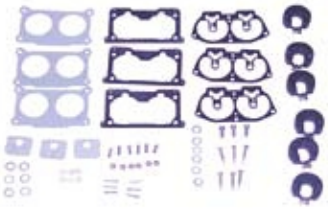

18-7291
CARB KIT
Replaces: 6H1-W0093-01-00
(3) of 18-7291 = (1) of 6H1-W0093-01-00

CARB KIT APPLICATION BEGINS ON PAGE 400

<p>18-7293 CARB KIT Replaces: 6A1-W0093-01-00</p>	<p>18-7736 CARB KIT Replaces: 67D-W0093-00-00 For: (1999-02) F4</p>	<p>18-7737 CARB KIT Replaces: 61N-W0093-00-00 For: (1993-97) C30</p>
<p>18-7738 CARB KIT Replaces: 66M-W0093-01-00 For: (1998-02) F15</p>	<p>18-7739 CARB KIT Replaces: 6L2-W0093-00-00 For: (1996-97) 20 (1988-02) 25 3 cyl</p>	<p>18-7740 CARB KIT Replaces: 6E9-W0093-02-00 For: (1990-94) C40 2 cyl</p>
<p>18-7741 CARB KIT Replaces: 6E9-W0093-03-00 For: (1995-98) C40 2 cyl</p>	<p>18-7742 CARB KIT Replaces: 6H0-W0093-00-00 For: (1997) C80</p>	<p>18-7743 CARB KIT Replaces: 67F-W0093-00-00 For: (1999-02) F80/F100</p>
<p>18-7744 CARB KIT Replaces: 6N6-W0093-02-00 For: (1990-91) 115, 130, L130</p>		<p>18-7747 CARB KIT Replaces: 6G5-W0093-08-00 For: (1985-86) 150/175/200, V6 Special</p>

CARB KIT APPLICATION BEGINS ON NEXT PAGE

 <p>18-7756 CARB KIT Replaces: 64D-W0093-00-00 For: (1996-01) 150/150L/175 (1996-99) 200/L200 (2000-01) 150/175 (1997-98) D150</p>				 <p>18-7759 CARB KIT Replaces: 6K7-W0093-09-00 For: (1990-91) 150/175/200 (1991-92) P200</p>				 <p>18-7765 CARB KIT Replaces: 6G1-W0093-00-00</p>			
 <p>18-7766 CARB KIT Replaces: 6H3-W0093-02-00 (3) of 18-7766 = (1) of 6H3-W0093-02-00</p>				 <p>18-7767 CARB KIT Replaces: 6H4-W0093-01-00 (3) of 18-7767 = (1) of 6H4-W0093-01-00</p>				 <p>18-7768 CARB KIT Replaces: 6H4-W0093-03-00 (3) 18-7768 = (1) 6H4-W0093-03-00</p>			
 <p>18-7769 CARB KIT Replaces: 6E7-W0093-04-00</p>				 <p>18-7770 CARB KIT Replaces: 689-W0093-02-00</p>				 <p>18-7772 CARB KIT Replaces: 61A-W0093-01-00 For: (1991-96) 225/250 3.1 liter, L225, L250</p>			
HP	Year	Carburetor Kits	Per Eng.	HP	Year	Carburetor Kits	Per Eng.	HP	Year	Carburetor Kits	Per Eng.
2	1984-88	18-7293	1	C40	1990-94	18-7740	1	E75	1995-00	18-7291	3
3	1988-02	18-7765	1	C40	1995-98	18-7741	1	C80	1997	18-7742	3
F4	1999-03	18-7736	1	C40	1997-02	18-7768	3	F80	1999-02	18-7743	4
6	1984-96	18-7765	1	P40	1998	18-7768	3	C85	1989-96	18-7291	3
8	1984-96	18-7765	1	E48	1995-00	18-7290 ①	2	90	1993-97	18-7291	3
9.9	1987-94	18-7769	1	50	1984-88	18-7767	3	F100	1999-02	18-7743	4
15	1985-92	18-7769	1	50	1989-04	18-7768	3	115	1990-91	18-7744	1
F15	1998-04	18-7738	1	C50	1998-01	18-7768	3	150	1985-86	18-7747	1
20	1996-97	18-7739	1	P50	1991-96	18-7768	3	150	1990-91	18-7759	1
25	1984-87	18-7770	1	C55	1990-95	18-7290 ①	2	150	1996-01	18-7756	1
25	1988-04	18-7739	1	C60	1996-01	18-7766	3	D150	1997-98	18-7756	1
C25	1990-97	18-7770	1	P60	1991	18-7766	3	L150	1996-01	18-7756	1
30	1984-86	18-7770	1	E60	1995-00	18-7766	3	P150	1996-99	18-7756	1
C30	1990-92	18-7770	1	70	1984-92	18-7766	3	V150	2000-01	18-7756	1
C30	1993-97	18-7737	1	C70	2000-01	18-7766	3	175	1985-86	18-7747	1
40	1984-88	18-7767	3	C75	1994-96	18-7291	3	175	1990-91	18-7759	1
40	1989-04	18-7768	3	C75	1998-99	18-7742	3	175	1996-01	18-7756	1

① Kit contains enough components to rebuild 2 carburetors

APPLICATION CONTINUED ON NEXT PAGE

HP	Year	Carburetor Kits	Per Eng.	HP	Year	Carburetor Kits	Per Eng.	HP	Year	Carburetor Kits	Per Eng.
P175	1996-99	18-7756	1	200	1996-99	18-7756	1	225 2.6L	1996-99	18-7756	1
V175	2000	18-7756	1	L200	1996-99	18-7756	1	225 3.1L	1990-96	18-7772	1
200	1985-86	18-7747	1	P200	1991-92	18-7759	1	250 3.1L	1990-96	18-7772	1
200	1990-91	18-7759	1	P200	1996-99	18-7756	1	V6 Excel	1987-89	18-7759	1



**18-7787
FUEL PUMP KIT**
For: 40-90 HP

— CONTAINS —

Part #	Description	O.E. #
18-7840	Diaphragm (Front)	663-24411-00-00



**18-7788
FUEL PUMP KIT**
For: V-4, V-6

— CONTAINS —

Part #	Description	O.E. #
18-7843	Gasket (Rear)	6E5-24411-00-00
18-7842	Diaphragm (Top)	6E5-24471-00-00



**18-7797
FUEL PUMP KIT**
Contains: 18-7839 & 18-7840



**18-7798
FUEL PUMP KIT**
Contains: 18-7838 & 18-7837



**18-7799
FUEL PUMP KIT**
Contains: 18-7842 & 18-7843



**18-7833
FUEL PUMP DIAPHRAGM**
Replaces: 6G1-24471-00-00
(6 & 8 HP)



**18-7834
FUEL PUMP DIAPHRAGM**
Replaces: 6E0-24471-00-00
(4 HP)



**18-7837
FUEL PUMP DIAPHRAGM**
Replaces: 677-24411-02-00
(9.9, 15 HP)



**18-7838
FUEL PUMP DIAPHRAGM**
Replaces: 677-24471-01-00
(9.9, 15 HP)



**18-7839
FUEL PUMP DIAPHRAGM**
Replaces: 648-24411-00-00
(25, 40, 50, 70, 90 HP)



**18-7840
FUEL PUMP DIAPHRAGM**
Replaces: 663-24411-00-00
(25, 40, 50, 70, 90 HP)



**18-7841
FUEL PUMP DIAPHRAGM**
Replaces: 6J8-24471-00-00
(30 HP)



**18-7842
FUEL PUMP DIAPHRAGM**
Replaces: 6E5-24471-00-00
(115, 150, 175, 200 HP)



**18-7843
FUEL PUMP DIAPHRAGM**
Replaces: 6E5-24411-00-00
(115, 150, 175, 200 HP)

Model	Year	Diaphragms/Kits	Model	Year	Diaphragms/Kits	Model	Year	Diaphragms/Kits	Model	Year	Diaphragms/Kits
3	1988-90	18-7833	25	1988-89	18-7837	55	1990	18-7798	175	1984-90	18-7799
4	1984-90	18-7834	CV25	1990	18-7798	70	1984-90	18-7798	200	1984-90	18-7799
5	1984-85	18-7834	25	1990	18-7837	85	1990	18-7798	225	1990	18-7799
6	1986-90	18-7833	30	1984-85	18-7798	90	1984-90	18-7798	250	1990	18-7799
8	1984-90	18-7833	30	1987-90	18-7841	115	1984-90	18-7799	V6		
9.9	1984-90	18-7797	CV30	1990	18-7798	130	1988-90	18-7799	Special	1984-85	18-7799
15	1984-90	18-7797	40	1984-90	18-7798	150	1984-90	18-7799	V6 Excel	1987-89	18-7799
25	1984-87	18-7798	50	1984-90	18-7798	PRO 150H	1987	18-7798			

OUTBOARD

- UNIVERSAL DESIGN -
FUEL WATER SEPARATOR BRACKETS



Bracket Type	Part #	Replaces	Bracket Type	Part #	Replaces
1/4" Stainless Steel	18-7777	MAR-FLTHD-SS-12	1/4" Aluminum	18-7853-1	MAR-FLTHD-AL-12
3/8" Stainless Steel	18-7776		3/8" Aluminum	18-7775	

FUEL WATER SEPARATOR KITS



21 Micron filter kits - for carbureted engines

Kit Type	Part #	Micron Rating	Contents	Replaces
1/4" Aluminum (Short Filter)	18-7848-1	21	1 - 18-7844 filter & 1 18-7853-1 bracket 2 - 18-4256 1/4" pipe plugs	
1/4" Aluminum Bonus Pack Contains spare filter	18-7848-2	21	2 - 18-7844 filter & 1 18-7853-1 bracket 2 - 18-4256 1/4" pipe plugs	
1/4" Aluminum (Tall Filter)	18-7852-1	21	1 - 18-7845 filter & 1 18-7853-1 bracket 2 - 18-4256 1/4" pipe plugs	ABB-SEPAR-AT-OR
1/4" Aluminum Bonus Pack Contains spare filter	18-7852-2	21	2 - 18-7845 filter & 1 18-7853-1 bracket 2 - 18-4256 1/4" pipe plugs	
3/8" Aluminum (Tall Filter)	18-7775-1	21	1 - 18-7845 filter & 1 18-7775 bracket 2 - 18-4264 3/8" pipe plugs	
1/4" Stainless Steel (Tall Filter)	18-7777-1	21	1 - 18-7845 filter & 1 18-7777 bracket 2 - 18-4256 1/4" pipe plugs	ABB-SPRTR-HD-SS
3/8" Stainless Steel (Tall Filter)	18-7776-1	21	1 - 18-7845 filter & 1 18-7776 bracket 2 - 18-4264 3/8" pipe plugs	



10 MICRON FILTER KITS FOR FUEL INJECTED ENGINES

Kit Type	Part #	Micron Rating	Contents	Replaces
1/4" Aluminum (Short Filter)	18-7983-1	10	1 - 18-7944 filter & 1 18-7853-1 bracket 2 - 18-4256 1/4" pipe plugs	
1/4" Aluminum Bonus Pack Contains spare filter	18-7983-2	10	2 - 18-7944 filter & 1 18-7853-1 bracket 2 - 18-4256 1/4" pipe plugs	

10 MICRON FILTER KITS FOR FUEL INJECTED ENGINES (Cont.)

Kit Type	Part #	Micron Rating	Contents	Replaces
1/4" Aluminum (Tall Filter)	18-7982-1	10	1 - 18-7945 filter & 1 18-7853-1 bracket 2 - 18-4256 1/4" pipe plugs	
1/4" Aluminum Bonus Pack Contains spare filter	18-7982-2	10	2 - 18-7945 filter & 1 18-7853-1 bracket 2 - 18-4256 1/4" pipe plugs	
1/4" Aluminum (High Capacity Filter)	18-7966-1	10	1 - 18-7866 filter & 1 18-7853-1 bracket 2 - 18-4256 1/4" pipe plugs	MAR-SEPAR-AT-OR
3/8" Aluminum (Tall Filter)	18-7986-1	10	1 - 18-7945 filter & 1 18-7775 bracket 2 - 18-4264 3/8" pipe plugs	
1/4" Stainless Steel (Tall Filter)	18-7984-1	10	1 - 18-7945 filter & 1 18-7777 bracket 2 - 18-4256 1/4" pipe plugs	MAR-SPRTR-HD-SS
3/8" Stainless Steel (Tall Filter)	18-7985-1	10	1 - 18-7945 filter & 1 18-7776 bracket 2 - 18-4264 3/8" pipe plugs	



10 MICRON FILTER KITS WITH DRAIN BOWLS

Sierra AquaVue™ and metal bowl separator filters allow water to be drained from the filter to extend service life. Use the AquaVue™ bowl for outboard, above deck installations. USCG regulations require the use of the flame resistant metal bowl below deck.

Kit Type	Part #	Micron Rating	Contents
1/4" Aluminum w/ AquaVue™ bowl	18-7932	10	1 - 18-7919 filter & 1 18-7853-1 bracket 1 - 18-7922 AquaVue™ bowl 2 - 18-4256 1/4" pipe plugs
1/4" Aluminum w/ metal drain bowl	18-7951	10	1 - 18-7919 filter & 1 18-7853-1 bracket 1 - 18-7924 metal bowl 2 - 18-4256 1/4" pipe plugs
1/4" Stainless Steel w/ AquaVue™ bowl	18-7937	10	1 - 18-7919 filter & 1 18-7777 bracket 1 - 18-7922 AquaVue™ bowl 2 - 18-4256 1/4" pipe plugs
1/4" Stainless Steel w/ metal drain bowl	18-7938	10	1 - 18-7919 filter & 1 18-7777 bracket 1 - 18-7924 metal bowl 2 - 18-4256 1/4" pipe plugs

COMPACT BRACKET AND SEPARATOR KIT - FOR SMALL OUTBOARDS AND FRESH WATER APPLICATIONS



18-7774
COMPACT ALUMINUM BRACKET



18-7965-1
10 MICRON COMPACT SEPARATOR KIT
Replaces: MAR-MINIF-LT-AS
Contains:
1 - 18-7774 bracket
1 - 18-7865 filter

REPLACEMENT FILTERS



UNIVERSAL DESIGN - DIRECT REPLACEMENT FOR MERCURY AND YAMAHA

10 MICRON REPLACEMENT FILTERS			21 MICRON REPLACEMENT FILTERS		
Part #	Description	Replaces	Part #	Description	Replaces
18-7944	Short - 3.875"		18-7844	Short - 3.875"	
18-7945	Long - 4.35"	ABB-FUELF-IL-TR			
18-7866	High Capacity - 6"	MAR-FUELF-IL-TR	18-7845	Long - 4.35"	ABB-FUELF-IL-TR
18-7865	Compact 10 Micron	MAR-MINIF-IL-TR			

OUTBOARD



10 Micron replacement filters and kits with drain bowls

REPLACEMENT FILTERS			REPLACEMENT BOWLS		
Part #	Description	Replaces	Part #	Description	Replaces
18-7919	Spin on replacement	MAR-24563-00-00 Racor S3213	18-7922	AquaVue™ Collection Bowl	
18-7920	Spin on replacement	Racor S3214	18-7924	Metal Collection Bowl	MAR-10171-00-10
18-7947	Spin on replacement Fits - 120RRAC01	Racor S3240	FILTER & BOWL KITS		
18-7948	Spin on replacement Fits - 320RRAC01	Racor S3227	Part #	Description	
18-7949	Spin on replacement Fits - 660RRAC02	Racor S3232	18-7928	Filter & AquaVue™ Bowl Mercury/Yamaha Style Contains: 18-7919 filter, 18-7922 bowl	
			18-7929	Filter & Metal Bowl Mercury/Yamaha Style Contains: 18-7919 filter, 18-7924 bowl	



18-7780
FUEL FILTER
Replaces:
6F5-24563-00-00
For: 9.9 - 225NR



18-7781
FUEL FILTER
Replaces:
61N-24563-00-00
For: 9.9/90° SX



18-7782
FUEL FILTER
Replaces:
61A-24563-00-00
For: V6, 3.1L, D-T



FUEL FILTERS

Part #	Application:
18-7828-1	1/4" Small Capacity (For 1/2" Fuel Line)
18-7829	1/4" Large Capacity (For 1/2" Fuel Line)
18-7830	5/16"
18-7831	3/8"



18-7979
FUEL FILTER
Replace: 68V-24563-00-00



18-79799
FUEL FILTER
Replaces: 6D8-WS24A-00-00
F50-F115 after April 2006
For filter housing marked "6D8" ONLY!



18-79809
FUEL FILTER
Replaces: 6P3-WS24A-00-00
F150, F200, F225, F250, Z-VZ 150 to
300 hp. after April 2006
For filter housing marked "6P3" ONLY!



18-7655
OXYGEN SENSOR
Replaces: 67H8592A0100



18-7656
OXYGEN SENSOR
Replaces: 68F8592A0000



18-7606
WATER SENSOR PROBE
Yamaha MAR-10171-30-00





<p>8' LENGTH COMPLETE FUEL LINE ASSEMBLIES</p>		
<p>3/8" FUEL LINE ASSEMBLY</p>  <p>18-8077-1 TANK CONNECTOR (SOLD SEPARATELY)</p> <p>*</p>	<p>NEW 18-8017EP SILVERADO 3000 Premium</p>  <p>18-80415 FUEL CONNECTOR</p> <p>18-8005 PRIMER BULB</p> <p>18-80415 FUEL CONNECTOR</p> <p>FUEL LINE ASSEMBLY COMPONENTS Fits: F75-F250 and 115-300 HP</p>	<p>OE# 6YL-24306-60-00</p>  <p>*</p>
 <p>18-4462 TANK CONNECTOR (Clip Style Fitting) (Female Twist-on)</p> <p><small>Display Package</small></p>	 <p>18-8005 18-8005-10^① PRIMER BULB 3/8" Large capacity bulb</p> <p><small>Display Package</small></p>	 <p>18-8040 FUEL TANK ELBOW Universal Fitting with 1/4" NPT Threads Replaces: ABA-FBARB-90-DG (Brass)</p> <p><small>Display Package</small></p>
 <p>18-8055 HOSE BARB 1/4" NPT threads for connection of 5/16" I.D. hose Replaces: ABA-FLINE-BA-RB (Brass)</p> <p><small>Display Package</small></p>	<p>18-80414 FUEL CONNECTOR (5/16") Replaces: 6G1-24305-05-00, 6G1-24305-04 Fits: 6(1989, 1992-93), 8(1984-85, 1989-93, 2001-02), 9.9(1984-93, 2000-03), 15(1984-93, 2000-03), 25(1984-85, 1988-93, 2000-03), 30(1984-87, 1989-93, 1999, 2001-02), 40(1984-86, 1988-90, 1992-93, 2000-03), 50(1986-93, 2000-03), 60(2001-03), 70(1984-93, 2000-03), 90(1984-93, 2000-03), C25(1991, 1993), C30(1991-93), C40(1991-93, 2000-02), C50(2000-01), C55(1991-93), C60(2000-01), C70(2000-01), C85(1991-93), C90(2000-01), E48(2000), F6(2001-03), F8(2001-03), F9.9(1985-93, 2001-03), F15(1998-99, 2000-01), F25(1998-99, 2000-03), F30(2001-03), F40(1999, 2000-03), F50(1999, 2000-03), F60(2002-03), T8(2001-03), T9.9(1991-93, 1999, 2001-03), T25(2001-03), T50(1999, 2000-03), T60(2003) Mates with 18-8077-1</p>  <p><small>Display Package</small></p>	
 <p>18-80413 FUEL CONNECTOR 1/4" Replaces: 6Y1-24305-04 Mates with 18-8077-1</p> <p><small>Display Package</small></p>	 <p>18-80415 FUEL CONNECTOR (3/8") Replaces: 6E5-24305-05, 6Y2-24305-05 Mates with 18-8077-1</p> <p><small>Display Package</small></p>	 <p>18-8077-1 18-8077-1-10^① TANK CONNECTOR (1/4" NPT) Fits: F75-F250 and 115-300HP Mates with 18-80413, 18-80414, 18-80415</p> <p><small>Display Package</small></p>
<p>18-9145 OETIKER CLAMP KIT Yamaha YB-6AW04-A Fits: All F115-F350 and HPDI Models. Kit includes 18-9146-9 (new product). Replaces: YB-6AW04-3 19.8 mm clamp and 18-9133-9 15.7 mm clamp. Package of 10, available individually.</p> 		

OUTBOARD

* Tanks and Engines for picture purpose only.





① Discount shop pack of 10 - Priced per package

OUTBOARD

 <p>18-3042 IMPELLER Replaces: 67F-44352-00-00 Fits: F75 (03-05), F80 Jet Drive (2001-02), F80 (1999-03), F100 (1999-02), F90 (2003-05), F90 Jet Drive (2003-04)</p>	 <p>18-8910 IMPELLER Replaces: 68T-44352-00-00 For: F6, F8 (2001-Up)</p>	 <p>18-3040 IMPELLER Replaces: 63V-44352-01-00 For: T8 (2001-Up) /9.9/15 (2-Stroke) (1996-Up)/F15 (1998-Up), F20 (2006-Up)</p>
 <p>18-3063 IMPELLER Replaces: 662-44352-01-00 (6/8 HP)</p>	 <p>18-3065 IMPELLER Replaces: 6L2-44352-00-00 (25 HP)</p>	 <p>18-3066 IMPELLER Replaces: 6G1-44352-00-00 (6 & 8 HP)</p>
 <p>18-3067 IMPELLER Replaces: 689-44352-02-00 (25 HP)</p>	 <p>18-3068 IMPELLER Replaces: 6H4-44352-00-00, 6H4-44352-02-00 (30,40,50 HP)</p>	 <p>18-3069 IMPELLER Replaces: 6H3-44352-00-00, 697-44352-00-00 55, 60, 70 HP F50, T50</p>
 <p>18-3070 IMPELLER Replaces: 688-44352-03-00 (C75, C85, 90 HP)</p>	 <p>18-3071 IMPELLER Replaces: 6E5-44352-00-00, 6E5-44352-01-00 (115, 150, 175, 200, 250 HP)</p>	 <p>18-3072 IMPELLER Replaces: 646-44352-01-00 (2 HP)</p>

IMPELLER APPLICATION BEGINS ON PAGE 414

 <p>18-3073 IMPELLER Replaces: 6E0-44352-00-00 (4 & 5 HP)</p>	 <p>18-3074 IMPELLER Replaces: 682-44352-01-00 (9.9,15 HP)</p>	 <p>18-3088 IMPELLER Replaces: 6F5-44352-00-00 (C40 HP)</p>
 <p>18-3162 CUP Replaces: 67F-44322-00-00 For: F75 (2003-04), F80(1999-03), F90(2003-04), F100(1999-02)</p>	 <p>18-3164 CUP Replaces: 6L5-44322-00-00 For: F2.5 (2003-04), 3 (1988-99, 2002)</p>	 <p>18-3328 CUP Replaces: 646-44322-00-00 Fits: 2 (1989,1991-99,2002)</p>
 <p>18-3456 CUP Replaces: 6G1-44322-00-00 Fits: 6 (1986-00), 8 (1984-05)</p>	 <p>18-3333 INSERT CUP Replaces: 61A-44322-00-00</p>	 <p>18-3435 INSERT CUP Replaces: 663-44322-00-00</p>
 <p>18-3443 INSERT CUP Replaces: 61N-44322-01-00 Fits: (1998-03) F25, (1993-97) C30</p>	 <p>18-3444 INSERT CUP Replaces: 63V-44322-00-00 Fits: 9.9/15 (1996-04), F15 (1998-04), F6/F8/T8 (20001-04)</p>	 <p>18-3449 INSERT CUP Replaces: 63D-44322-00-00 Fits: 40 (1995-04), 50 (1995-97, 1999-04)</p>

 <p>18-3185 WATER PUMP HOUSING Replaces: 61N-44311-01-00 Fits: C30 (1993-97), F25 (1998-06)</p>	 <p>18-3170 WATER PUMP HOUSING Replaces: 6E5-44311-00-00</p>	 <p>18-3171 WATER PUMP HOUSING Replaces: 688-44311-01-00</p>	 <p>18-3173 WATER PUMP HOUSING Replaces: 61A-44311-00-00</p>
--	---	--	---









BOLTS

Part #	O.E. #	Application
18-0256	97095-08045-00	8-1.25 x 45mm
18-2602	97080-08045-00	F6 (2001-05), F8 (2001-05) M8-1.25x45mm 18-8S/S
18-2605	90119-08M87-00	F80 (1999-03), F90 (2003-04), F100 (1999-02) M8-1.25x75mm 18-8 S/S
18-2606	90119-08M13-00	F80 (1999-03), F90 (2003-04), F100 (1999-02) M8-1.25x50mm 18-8 S/S
18-2607	97095-06040-00	For: 3HP (1988-99, 2002) M8-1.0x40mm 18-8 S/S
18-8400-9 ^{①②}	90119-08M15-00	8-1.25 x 29mm

IMPELLER KEYS













18-3297	90280-03M03-00
18-3305	90280-03024-00
18-3300	90280-04M00-00
18-3301	90280-04M04-00
18-3302	90280-04M05-00

OUTBOARD

 <p>18-3194 PLATE Replaces: 61N-44323-00 Fits: C30 (1993-97), F25 (1998-06)</p>	 <p>18-3357 PLATE Replaces: 646-44323-00-00 Fits: 2 (1989, 1991-99, 2002)</p>	 <p>18-3142 IMPELLER PLATE Replaces: 68T-44323-00-00 For: F6, F8 (2001-05)</p>
 <p>18-3143 IMPELLER PLATE Replaces: 67F-44323-00-00 For: F75 (2003-04), F80(1999-03), F90(2003-04), F100(1999-02)</p>	 <p>18-3163 IMPELLER PLATE Replaces: 6L5-44323-00-00 For: 3HP (1988-99, 2002)</p>	 <p>18-3344 WEAR PLATE Replaces: 6E5-44323-00-00</p>
 <p>18-3345 WEAR PLATE Replaces: 6G5-44323-00-00</p>	 <p>18-3186 IMPELLER PLATE Replaces: 63D-44323-00-00 Fits: 40 (1995-04), 50 (1995-97, 1999-04)</p>	 <p>18-3195 IMPELLER PLATE Replaces: 63V-44323-00-00 Fits: 9.9/15 (1996-04), F15 (1998-04)</p>

① Priced per Package

② PKG. of 4

 <p>18-3196 IMPELLER PLATE Replaces: 66T-44323-00-00 Fits: F30 (2001-04), F40 (2000-04), T25 (2001-04)</p>	 <p>18-3436 WEAR PLATE Replaces: 663-44323-00-00</p>	 <p>18-3166 WATER SEAL DAMPER Replaces: 6E0-44366-00-00 For: 2 (1984-85, 88-99, 2002), 3 (1988-99, 02), 4 (1984-85, 88-99), 5 (1984-85, 95-02), F2.5 (2003-05)</p>
 <p>18-3176 WATER SEAL DAMPER Replaces: 68T-44366-00-00 For: F6, F8 (2001-05), C30 (1993-97)</p>	 <p>18-3451 WATER PUMP KIT Yamaha 67F-W0078-00-00 Fits: F75 (2003-06), F80(1999-03), F90(2003-04), F100(1999-02)</p>	 <p>18-3432 WATER PUMP KIT Yamaha 61N-W0078-11-00 Fits: F25(1998-05)</p>
 <p>18-3460 WATER PUMP KIT Replaces: 6N0-W0078-A0-00, 6G1-W0078-A1 Fits: 6(1986-00), 8(1984-05),</p>	 <p>18-3462 WATER PUMP KIT Replaces: 6A1-W0078-02-00 Fits: 2(1988-02)</p>	 <p>18-3463 WATER PUMP KIT Replaces: 6A1-W0078-01-00 Fits: 2(1984-87)</p>
 <p>18-3464 WATER PUMP KIT Replaces: 6H3-W0078-01-00 Fits: C60(1996), E60(1995-96), P60(1992-96), 70(1992-96)</p>	 <p>18-3465 WATER PUMP KIT Replaces: 6H3-W0078-02-00 Fits: T50(1997-05), 60(2001-03), C60(1997-01), C70(2000-01), P60(1997-99), T60(2003-05), 70(1997-03)</p>	 <p>18-3450 WATER PUMP KIT Replaces: 68T-W0078-00-00 For: F6, F8 (2001-05)</p>



18-3148
WATER PUMP KIT
Without Housing
Replaces: 682-W0078-A1-00

— CONTAINS —

Part #	Desc.	O.E. #	Qty.
18-0768	Wear Plate Gasket	682-44315-A0-00	1
18-3074	Impeller	682-44352-01-00	1
18-3305	Woodruff Key	90280-03024	1



18-3310
WATER PUMP KIT
Without Housing
Replaces: 6G5-W0078-01-00

— CONTAINS —

Part #	Description	O.E. #	Qty.
18-3071	Impeller	6E5-44352-00	1
18-3345	Wear Plate	6G5-44323-00	1
18-3302	Woodruff Key	90280-04M05-00	1
18-0244	Water Pump Gasket	6E5-44315-A0-00	1
18-0256	Bolt	97395-08045-00	4
18-7483	O-Ring	93210-37M67-00	1
18-7485	O-Ring	93210-86M38-00	1



18-3311
WATER PUMP KIT
With Housing
Replaces: 6G5-W0078-A1-00

— CONTAINS —

Part #	Description	O.E. #	Qty.
18-3170	Water Pump Housing	6E5-44311-00	1
18-3071	Impeller	6E5-44352-00	1
18-3345	Wear Plate	6G5-44323-00	1
18-3302	Woodruff Key	90280-04M05-00	1
18-0244	Water Pump Gasket	6E5-44315-A0-00	1
18-0256	Bolt	97395-08045-00	4
18-7483	O-Ring	93210-37M67-00	1
18-7485	O-Ring	93210-86M38-00	1



18-3312
WATER PUMP KIT
Without Housing
Replaces: 6N6-W0078-00-00

— CONTAINS —

Part #	Description	O.E. #	Qty.
18-3301	Woodruff Key	90280-04M05-00	1
18-3333	Insert Cup	61A-44322-00	1
18-3071	Impeller	6E5-44352-00	1
18-3344	Wear Plate	6E5-44323-00	1
18-0244	Water Pump Gasket	6E5-44315-A0-00	1
18-0256	Bolt	97395-08045-00	4
18-7483	O-Ring	93210-37M67-00	1
18-7485	O-Ring	93210-86M38-00	1



18-3313
WATER PUMP KIT
With Housing
Replaces: 6N6-W0078-01-00

— CONTAINS —

Part #	Description	O.E. #	Qty.
18-3173	Water Pump Housing	61A-44311-00	1
18-3302	Woodruff Key	90280-04M05-00	1
18-3333	Insert Cup	61A-44322-00	1
18-3071	Impeller	6E5-44352-00	1
18-3344	Wear Plate	6E5-44323-00	1
18-0244	Water Pump Gasket	6E5-44315-A0-00	1
18-0256	Bolt	97395-08045-00	4
18-7483	O-Ring	93210-37M67-00	1
18-7485	O-Ring	93210-86M38-00	1



18-3370
WATER PUMP KIT
Without Housing
Replaces: 692-W0078-00-00, 692-W0078-01-00,
692-W0078-A0-00

— CONTAINS —

Part #	Description	O.E. #	Qty.
18-3301	Woodruff Key	90280-04M04-00	1
18-3070	Impeller	688-44352-03	1
18-0239	Wear Plate to Pump Housing Gasket	688-44315-A0-00	1
18-0240	Wear Plate to Gear Case Mounting Gasket	688-44316-A0-00	1
18-7436	O-Ring	93210-46044-00	1

APPLICATION BEGINS ON PAGE 414



18-3371
WATER PUMP KIT
With Housing
Replaces: 692-W0078-A0-00
— CONTAINS —

Part #	Description	O.E. #	Qty.
18-3171	Water Pump Housing	688-44311-01	1
18-3301	Woodruff Key	90280-04M04-00	1
18-3070	Impeller	688-44352-03	1
18-0239	Wear Plate to Pump Housing Gasket	688-44315-A0-00	1
18-0240	Wear Plate to Gear Case Mounting Gasket	688-44316-A0-00	1
18-7436	O-Ring	93210-46044-00	1



18-3372
WATER PUMP KIT
Without Housing
Replaces: 6E5-W0078-01-00
— CONTAINS —

Part #	Description	O.E. #	Qty.
18-3302	Woodruff Key	90280-04M05-00	1
18-3071	Impeller	6E5-44352-00	1
18-3344	Wear Plate	6E5-44323-00	1



18-3373
WATER PUMP KIT
With Housing
Replaces: 6E5-W0078-A1-00
— CONTAINS —

Part #	Description	O.E. #	Qty.
18-3170	Water Pump Housing	6E5-44311-00-00	1
18-3302	Woodruff Key	90280-04M05-00	1
18-3071	Impeller	6E5-44352-00	1
18-3344	Wear Plate	6E5-44323-00	1
18-0244	Water Pump Gasket	6E5-44315-A0-00	1
18-0256	Bolt	97395-08045-00	4
18-7483	O-Ring	93210-37M67-00	1
18-7485	O-Ring	93210-86M38-00	1



18-3374
WATER PUMP KIT
Without Housing
Replaces: 6F5-W0078-00-00
— CONTAINS —

Part #	Description	O.E. #	Qty.
18-3300	Woodruff Key	90280-04M00-00	1
18-3088	Impeller	6F5-44352-00	1
18-0256	Bolt	97395-08045-00	2



18-3375
WATER PUMP KIT
With Housing
— CONTAINS —

Part #	Description	O.E. #	Qty.
18-3300	Woodruff Key	90280-04M00	1
18-3088	Impeller	6F5-44352-00	1
18-0256	Bolt	97395-08045-00	2



18-3395
WATER PUMP KIT
Without Housing
Replaces: 61A-W0078-01-00
— CONTAINS —

Part #	Description	O.E. #	Qty.
18-3071	Impeller	6E5-44352-00	1
18-3345	Wear Plate	6G5-44323-00	1
18-3302	Woodruff Key	90280-04M05-00	1
18-3333	Insert Cup	61A-44322-00	1
18-0244	Water Pump Gasket	6E5-44315-A0-00	1
18-0256	Bolt	97395-08045-00	4
18-7483	O-Ring	93210-37M67-00	1
18-7485	O-Ring	93210-86M38-00	1



18-3396
WATER PUMP KIT
With Housing

Replaces: 61A-W0078-A2-00, 61A-W0078-A3-00

— CONTAINS —

Part #	Description	O.E. #	Qty.
18-3173	Water Pump Housing	61A-44311-00	1
18-3071	Impeller	6E5-44352-00	1
18-3345	Wear Plate	6G5-44323-00	1
18-3302	Woodruff Key	90280-04M05-00	1
18-3333	Insert Cup	61A-44322-00	1
18-0244	Water Pump Gasket	6E5-44315-A0-00	1
18-0256	Bolt	97395-08045-00	4
18-7483	O-Ring	93210-37M67-00	1
18-7485	O-Ring	93210-86M38-00	1



18-3397
WATER PUMP KIT
Without Housing

Replaces: 679-W0078-00-00, 679-W0078-A0-00

— CONTAINS —

Part #	Description	O.E. #	Qty.
18-3088	Impeller	6F5-44352-00	1
18-3300	Woodruff Key	90280-04M00-00	1
18-0256	Bolt	97395-08045-00	2



18-3398
WATER PUMP KIT
With Housing

Replaces: 6F5-W0078-A0-00

— CONTAINS —

Part #	Description	O.E. #	Qty.
18-3088	Impeller	6F5-44352-00	1
18-3300	Woodruff Key	90280-04M00-00	1
18-0256	Bolt	97395-08045-00	2



18-3425
WATER PUMP KIT
Without Housing

Replaces: 663-W0078-00-00, 663-W0078-A0-00

— CONTAINS —

Part #	Description	O.E. #	Qty.
18-0292	Wear Plate to Pump Housing Gasket	663-44315-A0-00-00	1
18-3435	Insert Cup	663-44322-00-00	1
18-0294	Wear Plate to Pump Base Gasket	663-44324-A0-00-00	1
18-3069	Impeller	6H3-44352-00-00	1
18-0256	Bolt	97395-08045-00	2
18-3436	Impeller Plate	663-44323-00-00	1



18-3426
WATER PUMP KIT
With Housing

Replaces: 689-W0078-04-00, 689-W0078-A4-00

— CONTAINS —

Part #	Description	O.E. #	Qty.
18-3067	Impeller	689-44352-02-00	1
18-3244	Impeller Key	664-44338-00	1
18-2730	Upper Water Tube Seal	664-44365-01	1



18-3427
WATER PUMP KIT
With Housing

Replaces: 689-W0078-A6-00

— CONTAINS —

Part #	Description	O.E. #	Qty.
18-0773	Wear Plate Gasket	689-44316-A0-00	1
18-3244	Impeller Key	664-44338-00	1
18-2730	Upper Water Tube Seal	664-44365-01	1
18-3067	Impeller	689-44352-02-00	1

APPLICATION BEGINS ON PAGE 414



18-3428-1
WATER PUMP KIT
Without Housing

Replaces: 6H3-W0078-00-00, 6H3-W0078-A0-00

Part #	Description	O.E. #	Qty.
18-0240	Water Pump Gasket	688-44316-A0-00	1
18-3069	Impeller	6H3-44352-00-00	1
18-7436	O-Ring	93210-46044-00	1
18-0256	Bolt	97395-08045-00	2
18-0756-1	Water Pump Gasket	6H3-44315-A0-00	1
18-0757	Outer Plate Gasket	6H3-44324-A0-00	1



18-3429
WATER PUMP KIT
Without Housing

Replaces: 6H4-W0078-00-00, 6H4-W0078-A0-00

Part #	Description	O.E. #	Qty.
18-0292	Wear Plate to Gear Case Mounting Gasket	688-44315-A0-00	1
18-3435	Insert Cup	663-44322-00-00	1
18-0294	Wear Plate to Pump Base Gasket	663-44324-A0-00	1
18-3068	Impeller	6H4-44352-02-00, 6H4-44352-00-00	1
18-0256	Bolt	97395-08045-00	2
18-3436	Impeller Plate	663-44323-00-00	1



18-3430
WATER PUMP REPAIR KIT
Without Housing

Replaces: 6J8-W0078-A1-00

Part #	Description	O.E. #	Qty.
18-0292	Wear Plate to Gear Case Mounting Gasket	688-44315-A0-00	1
18-3435	Insert Cup	663-44322-00-00	1
18-0294	Wear Plate to Pump Base Gasket	663-44324-A0-00	1
18-3068	Impeller	6H4-44352-02-00, 6H4-44352-00-00	1
18-0256	Bolt	97395-08045-00	2
18-3436	Impeller Plate	663-44323-00-00	1



18-3431
WATER PUMP KIT
Without Housing

Replaces: 6L2-W0078-00-00

Part #	Description	O.E. #	Qty.
18-3065	Impeller	6L2-44352-00-00	1
18-7483	O-Ring	93210-37M67-00	1

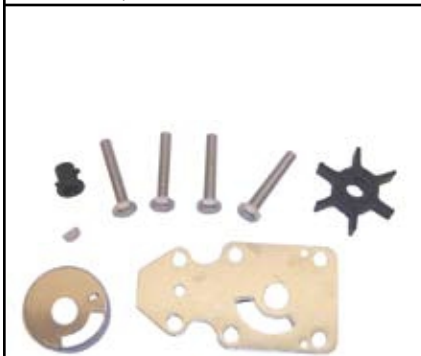

18-3433
WATER PUMP KIT

Replaces: 63V-W0078-01-00
Fits: 9.9/15(1996-04), F15 (1998-04)



18-3434
WATER PUMP KIT

Replaces: 63D-W0078-01-00
Fits: 40/50(1995-03), P40(1998), C40 3 cyl(1997-02), C50(1999-01), F40 2.6L(1999), F50(1995-03), P50 (1995-96), F60(2002-03)

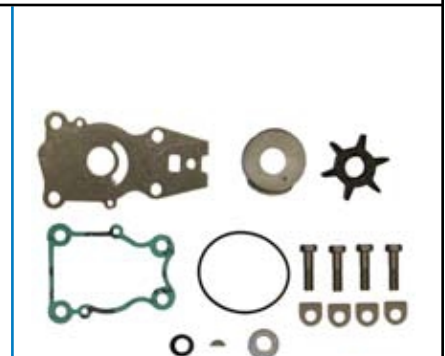

18-3440
WATER PUMP KIT

Replaces: 66T-W0078-00-00
Fits: T25 (2001-04), F30 (2001-04), F40 (2000-04)

YAMAHA

Cooling System



OUTBOARD

HPModel	Year	Impeller	Cup	Plate	Housing	Kit with Housing	Kit without Housing
2	1984-87	18-3072	18-3328	18-3357	—	18-3463	—
2	1988-02	18-3072	18-3328	18-3357	—	18-3462	—
4	1984-98	18-3073	—	—	—	—	—
5	1984-02	18-3073	—	—	—	—	—
6	1986-00	18-3066	18-3456	—	—	—	18-3460
F6	2001-05	18-8910	18-3444	18-3142	—	—	18-3450
8	1984-05	18-3066	18-3456	—	—	—	18-3460
F8	2001-05	18-8910	18-3444	18-3142	—	—	18-3450
T8	2001-02	18-3040	—	—	—	—	—
9.9	1984-90	18-3074	—	—	—	—	—
9.9/15	1984-95	18-3074	—	—	—	—	18-3148
9.9	1996-04	18-3040	18-3444	18-3195	—	—	18-3433
F/T9.9	1985-90	18-3074	—	—	—	—	18-3148
T9.9	1991-96	18-3074	—	—	—	—	18-3148
15	1984-95	18-3074	—	—	—	—	—
15	1996-04	18-3040	18-3444	18-3195	—	—	18-3433
F15	1996-04	18-3040	18-3444	18-3195	—	—	18-3433
20	1996-97	18-3065	—	—	—	—	18-3431
25	1984-85	18-3067	—	18-3436	—	18-3426	—
25	1986-87	18-3067	—	—	—	18-3427	—
25	1988-02	18-3065	—	—	—	—	18-3431
25	1996-02	18-3068	—	—	—	—	—
C25	1990-97	18-3067	—	—	—	18-3427	—
CV25	1990	18-3067	—	—	—	18-3427	—
F25	1998-05	18-3068	18-3443	18-3194	18-3185	18-3432	—
T25	2001-04	18-3068	18-3449	18-3196	—	—	18-3440
30	1984-85	18-3067	—	18-3436	—	18-3426	—
30	1986	18-3067	—	—	—	18-3427	—
30	1987-95	18-3068	18-3435	18-3436	—	—	18-3430
C30	1990-92	18-3067	—	18-3436	—	18-3427	—
C30	1993-97	18-3068	18-3443	18-3194	18-3185	18-3432	—
F30	2001-04	18-3068	18-3449	18-3196	—	—	18-3440
40	1984-94	18-3068	18-3435	18-3436	—	—	18-3429
40	1995-04	18-3069	18-3449	18-3186	—	—	18-3434
C40	1992-97	18-3088	—	—	—	18-3398	18-3397
C40	1997-02	18-3069	18-3449	18-3186	—	—	18-3434
C40	1990-91	18-3088	—	—	—	18-3375	18-3374
F40	1999	18-3069	—	—	—	—	—
F40	2000-04	18-3068	18-3449	18-3196	—	—	18-3440
P40	1998	18-3069	18-3449	18-3186	—	—	18-3434
F40 2.6L	1999	18-3069	18-3449	18-3186	—	—	18-3434
50	1984-94	18-3068	18-3435	18-3436	—	—	18-3429
50	1995-04	18-3069	18-3449	18-3186	—	—	18-3434
C50	1999-01	18-3069	18-3449	18-3186	—	—	18-3434
F50	1999-03	18-3069	18-3449	18-3186	—	—	18-3434
PRO 50	1987-94	18-3068	18-3435	18-3436	—	—	18-3429
P50	1991-93	18-3068	18-3435	18-3436	—	—	18-3429
P50	1995-96	18-3069	18-3449	18-3186	—	—	18-3434
50 Jet	1986-89	18-3068	—	—	—	—	—
T50	1996	18-3069	18-3435	—	—	—	18-3428-1
T50	1997-05	18-3069	18-3435	—	—	—	18-3465
C55	1991-94	18-3069	18-3435	18-3436	—	—	18-3425
CV55	1989	18-3069	18-3435	18-3436	—	—	18-3425
60	2001-03	18-3069	18-3435	—	—	—	18-3465
C60	1996	18-3069	18-3435	—	—	—	18-3464
C60	1997-01	18-3069	18-3435	—	—	—	18-3465
E60	1995-96	18-3069	18-3435	—	—	—	18-3464
E60	1997-00	18-3069	—	—	—	—	—
F60	2002-03	18-3069	18-3449	18-3186	—	—	18-3434
P60	1991	18-3069	18-3435	—	—	—	18-3428-1
P60	1997-99	18-3069	18-3435	—	—	—	18-3465
P60	1992-96	18-3069	18-3435	—	—	—	18-3464
T60	2003-05	18-3069	18-3435	—	—	—	18-3465
70	1984-91	18-3069	18-3435	—	—	—	18-3428-1
70	1997-03	18-3069	18-3435	—	—	—	18-3465
70	1992-96	18-3069	18-3435	—	—	—	18-3464
C70	2000-01	18-3069	18-3435	—	—	—	18-3465

① 2.6L engine

② 3.1L engine

HPModel	Year	Impeller	Cup	Plate	Housing	Kit with Housing	Kit without Housing
C75	1994-96	18-3070	—	—	18-3171	18-3371	18-3370
C75	1994-99	18-3070	—	—	—	—	—
E75	1995-00	18-3070	—	—	—	—	—
P75	1996-99	18-3070	—	—	—	—	—
C80	1997	18-3070	—	—	—	—	—
85	1985	18-3070	—	—	—	—	—
C85	1989-97	18-3070	—	—	18-3171	18-3371	18-3370
CV85	1989-91	18-3070	—	—	18-3171	18-3371	18-3370
90	1984-96	18-3070	—	—	18-3171	18-3371	18-3370
90	1984-02	18-3070	—	—	—	—	—
90 Jet	1986-89	18-3070	—	—	—	—	—
C90	1997-01	18-3070	—	—	—	—	—
B90	1997-99	18-3070	—	—	—	—	—
F115/LF115	2000-02	18-3071	—	—	—	—	—
C115	1991-92	18-3071	—	18-3344	18-3170	18-3373	18-3372
C115	1993-96	18-3071	18-3333	18-3344	18-3173	18-3313	18-3312
P115 (62A)	1993-96	18-3071	18-3333	18-3344	18-3173	18-3313	18-3312
115 (6N6), (6E5)	1989-94	18-3071	—	18-3344	18-3170	18-3373	18-3372
115 (6N6)	1994	18-3071	18-3333	18-3344	18-3173	18-3313	18-3312
130 (6L1), (6N7)	1988-92	18-3071	—	18-3344	18-3170	18-3373	18-3372
130 (6N7)	1993-96	18-3071	18-3333	18-3344	18-3173	18-3313	18-3312
L130 (6L6), (6N4)	1989-92	18-3071	—	18-3344	18-3170	18-3373	18-3372
L130 (6N4)	1993-96	18-3071	18-3333	18-3344	18-3173	18-3313	18-3312
C150 (6E5)	1994	18-3071	18-3333	18-3345	18-3173	—	18-3395
L150 (6R0), (6K0)	1986-91	18-3071	—	18-3344	18-3170	18-3311	18-3310
L150 (6R0)	1992-99	18-3071	18-3333	18-3345	18-3173	18-3396	18-3395
150 (6R2), (6G4)	1984-91	18-3071	—	18-3344	18-3170	18-3311	18-3310
150 (6R2)	1992-99	18-3071	18-3333	18-3345	18-3173	18-3396	18-3395
P150	1986-91	18-3071	—	18-3344	18-3170	18-3311	18-3310
P150	1992-99	18-3071	18-3333	18-3345	18-3173	18-3396	18-3395
150/175/200ETLN	1984	18-3071	—	18-3344	18-3170	18-3311	18-3310
PRO V150 (6J9)	1986-89	18-3071	—	18-3344	18-3170	18-3311	18-3310
PRO V150D (6N9)	1990	18-3071	—	18-3344	18-3170	18-3311	18-3310
PX150	1999	18-3071	18-3333	18-3345	18-3173	18-3396	18-3395
SX150	1999-02	18-3071	18-3333	18-3345	18-3173	18-3396	18-3395
V150	2000-02	18-3071	18-3333	18-3345	18-3173	18-3396	18-3395
VZ150	2001-02	18-3071	18-3333	18-3345	18-3173	18-3396	18-3395
Z150/LZ150	2001-02	18-3071	18-3333	18-3345	18-3173	18-3396	18-3395
175 (6G5)	1984-91	18-3071	—	18-3344	18-3170	18-3311	18-3310
175 (6R3)	1992-00	18-3071	18-3333	18-3345	18-3173	18-3396	18-3395
P175 (62H)	1994-99	18-3071	18-3333	18-3345	18-3173	18-3396	18-3395
VZ175	2001-02	18-3071	18-3333	18-3345	18-3173	18-3396	18-3395
Z175	2001-02	18-3071	18-3333	18-3345	18-3173	18-3396	18-3395
200 (6G6), (6R4)	1984-91	18-3071	—	18-3344	18-3170	18-3311	18-3310
200 (6R4)	1992-99	18-3071	18-3333	18-3345	18-3173	18-3396	18-3395
F200/LF200	2002	18-3071	18-3333	18-3345	18-3173	18-3396	18-3395
L200 (6K1), (6R1)	1986-91	18-3071	—	18-3344	18-3170	18-3311	18-3310
L200	1992-99	18-3071	18-3333	18-3345	18-3173	18-3396	18-3395
LX200	1999-02	18-3071	18-3333	18-3345	18-3173	18-3396	18-3395
P200	1991-99	18-3071	18-3333	18-3345	18-3173	18-3396	18-3395
SX200	1999-02	18-3071	18-3333	18-3345	18-3173	18-3396	18-3395
V200	1998-99	18-3071	18-3333	18-3345	18-3173	18-3396	18-3395
VZ200	2001-02	18-3071	18-3333	18-3345	18-3173	18-3396	18-3395
Z200/LZ200	2000-02	18-3071	18-3333	18-3345	18-3173	18-3396	18-3395
V6 Special (6G7)	1984-86	18-3071	—	18-3344	18-3170	18-3311	18-3310
V6 Excel (6K7)	1987-89	18-3071	—	18-3344	18-3170	18-3311	18-3310
225 (6R5)	1990-91	18-3071	—	18-3344	18-3170	18-3311	18-3310
225	① 1992-97	18-3071	18-3333	18-3345	18-3173	18-3396	18-3395
225/L225/S225	② 1994-99	18-3071	18-3333	18-3345	18-3173	18-3396	18-3395
F225/LF225	2002	18-3071	18-3333	18-3345	18-3173	18-3396	18-3395
LX225/SX225	2000-02	18-3071	18-3333	18-3345	18-3173	18-3396	18-3395
V225	1998-99	18-3071	18-3333	18-3345	18-3173	18-3396	18-3395
VX225	2000-02	18-3071	18-3333	18-3345	18-3173	18-3396	18-3395
250/L250	1990-96	18-3071	18-3333	18-3345	18-3173	18-3396	18-3395
L250/S250	1997-99	18-3071	18-3333	18-3345	18-3173	18-3396	18-3395
VX250	2002	18-3071	18-3333	18-3345	18-3173	18-3396	18-3395

① 2.6L engine ② 3.1L engine

NEW



18-3625 THERMOSTAT
(Seal Included)
Yamaha 6F5-12411-03-00
9.9EL, 9.9ES, 15EL, 15ES (1986-1995), 9.9L, 9.9S, 15L, 15S (1986-1990), 9.9M, 15ML, 15MS, C55EL (1991-1995), C25EL, C40EL (1991-1997), C25ML (1993-1997), C25MS, C40MS, C40PL (1992-1997), C30EL (1991-1992), CV30EL (1989-1990), C40ML (1994-1995), C55TL (1993-1995), CV25EL, CV25EM, CV40EL (1990), CV55EL (1989)

NEW



18-3623 THERMOSTAT
(Seal Included)
Yamaha 6E5-12411-02-00
8MSH-0405, 8MSH-0406, 8MSH-0407, 8MSH-0608, 8MSHD-2005



18-3540 THERMOSTAT
Replaces:
6E5-12411-30-00
Fits: 9.9-15 (1996-06), 20 (1996-97), 25 (1988-95), 30 3-cyl (1987-91), 40 (1986-05), C40 3-cyl (1998-02), 50 (1986-05), C50 (1998-01), P50 (1987-96), 115 (1984-05), B115 (1998-99), C115 (1991-00), P115 (1993-96), S115/S130 (1996-98), 130/L130 (1988-05), 150/175/200 (1986-05), C150 (1996-99), D150/DX150 (1997-05), L150/L200 (1986-99), LX150/LX200 (1999-01), P150 (1986-99), PX150 (1999), SX150/SX200 (1999-04), V150 (2000-05), VX150 (2000-05), VZ150/VZ175/VZ200 (2001-05), Z150/Z175/Z200 (2000-05), P200 (1991-93), V200/V225 (1998-99), VX200/VX225 (2000-05), V6 Special (1984-86), V6 Excel (1987-89), 225 2.6L (1990-97), S225/L225 3.1L (1994-99), SX225/LX225 3.1L (2000-02), 250/L250 2.6L (1990-95), S250/L250 3.1L (1996-99), SX250/LX250 3.1L (2000-02), VX250 3.1L (2002-04)



18-3541 THERMOSTAT
Replaces: 66M-12411-01-00
Fits: F6 (2001-05), F8 (2001-05), T8 (2001-05), F9.9 (1985-05), T9.9 (1985-05), T9.9 (1991-05), F15 (1998-05), F25 (1998-05), T25 (2001-05), F30 (2001-05), F40 4cyl (1999), F40 3cyl (2000-05), F50 (1995-05), T50 (1996-05), F60 (2002-05), T60 (2003-05), F80 (1999-00), F100 (1999-00)

NEW



18-3622 THERMOSTAT KIT
Yamaha 6H3-12411-11-00
60TLR-0405, 70TLR-0405, 70TLR-0406, 70TLR-0407, 70TLR-0408

NEW



18-3624 THERMOSTAT KIT
Yamaha 69M-12411-01-00
F2.5MSH-0405, F2.5MSH-0406, F2.5MSH-0407, F2.5MSH0608, F2.5MSHD-2005

① **18-3608D** 



18-3608 THERMOSTAT KIT
Fits: 115 (1991-02), C115 (1991-99), P115 (1993-96), S115 (1996-99), 130 (1991-02), L130 (1991-00), S130 (1996-99), 150 (1991-02), C150 (1996-99), L150 (1991-99), P150 (1991-99), S150 (1996-99), V150 (2000-02), Z150 (2001-02), 175 (1991-95, 97), P175 (1994-99), V175 (2000), Z175 (2001-02), 200 (1991-98), L200 (1991-99), P200 (1991-99), S200 (1996-99), V200 (1998-99), Z200 (2001-02), 225 (1991-97), V225 (1998-99)

— CONTAINS —			
Part #	Desc.	O.E. #	Qty.
18-3540	Thermostat	6E5-12411-30-00	1
18-0844	Gasket	688-12414-A1-00	1

① **18-3609D** 



18-3609 THERMOSTAT KIT
Fits: 25 (1996-98, 2001-02), 40 (1991-99, 01), C40 (1997-02), P40 (1998), 50 (1991-97, 1999-02), C50 (1998-01), P50 (1991-96), L225 (1994-99), S225 (1996-99), 250 (1991-95), L250 (1991-99), S250 (1996-99)

— CONTAINS —			
Part #	Desc.	O.E. #	Qty.
18-3540	Thermostat	6E5-12411-30-00	1
18-0829	Gasket	61A-12414-A0-00, 6J8-12414-A0-00	1



18-3611 THERMOSTAT KIT
Fits: 15 (2006), F15 (1998-06), F25 (1999-06), F30 (2001-06), F40 (1999-06), F50 (1996-06), F60 (2002-06), F9.9 (2005-06), T25 (2001-06), T50 (1996-06), T60 (2003-06), T9.9 (2005-06)

① Items ending in "D" are Display Packaged - Regular number is Non-Display

**ALL PISTONS
ARE SUPPLIED WITH PISTON RINGS, WRIST PIN AND CIRCLIPS**

Piston Rings are available individually



V-4 & V-6 Pistons and Rings

STANDARD			25mm O.S.		50mm O.S.		
18-4128 (Port) Replaces: 6G5-11642-00-93	18-4129 (Stbd.) Replaces: 6G5-11631-00-93	— CONTAINS —	18-4130 (Port)	18-4131 (Stbd.)	18-4132 (Port) Replaces: 6G5-11646-00-00	18-4133 (Stbd.) Replaces: 6G5-11636-00-00	— CONTAINS —
Part #	Rings	O.E. #			Part #	Rings	O.E. #
18-3934	Standard	6E5-11610-03-00			18-3936	Standard	6E5-11610-23-00

V-6 Loop Charged Engines (1992-2001)

18-4080 (Port) Replaces: 6R5-11642-11-93	18-4081 (Stbd.) Replaces: 6R5-11631-11-93	— CONTAINS —	18-4082 (Port) Replaces: 6R5-11645-11-00	18-4083 (Stbd.) Replaces: 6R5-11635-11-00	18-4084 (Port) Replaces: 6R5-11646-11-00	18-4085 (Stbd.) Replaces: 6R5-11636-11-00
Part #	Rings	O.E. #				
18-39320	Standard	6R5-11603-00				

Inline Pistons and Rings

STANDARD			25mm O.S.			50mm O.S.		
18-4091	Replaces: 6H3-11631-01-96 — CONTAINS —		18-4136	Replaces: 6E7-11635-00-00 — CONTAINS —		18-4093	Replaces: 6H3-11636-01-00	
Part #	Rings	O.E. #	Part #	Rings	O.E. #	Part #	Rings	O.E. #
18-3963	Standard	6K5-11601-02-00	18-3977	25mm O.S.	682-11610-11-00	18-4096	Replaces: 6K5-11636-03-00	
18-4135	Replaces: 6E7-11631-00-97 — CONTAINS —		18-4145	Replaces: 61N-11635-00-00		18-4137	Replaces: 6E7-11636-00-00 — CONTAINS —	
Part #	Rings	O.E. #	18-4142	Replaces: 6H4-11635-01-00 — CONTAINS —		Part #	Rings	O.E. #
18-3976	Standard	682-11610-01-00				18-3978	50mm O.S.	682-11610-21-00
18-4138	Replaces: 689-11631-00-95 — CONTAINS —		Part #	Rings	O.E. #	18-4146	Replaces: 61N-11636-00-00	
Part #	Rings	O.E. #	18-3961	25mm O.S.	6H4-11610-10-00	18-4143	Replaces: 6H4-11636-00-00 — CONTAINS —	
18-3954	Standard	689-11610-01-00				Part #	Rings	O.E. #
18-4144	Replaces: 61N-11631-00-95		Part #	Rings	O.E. #	18-3962	50mm O.S.	6H4-11610-20-00
18-4141	Replaces: 6H4-11631-00-96 — CONTAINS —		18-3970	25mm O.S.	688-11604-00-00	18-4099	Replaces: 6H1-11636-03-00	
Part #	Rings	O.E. #						
18-3960	Standard	6H4-11610-00-00						
18-4097	Replaces: 6H1-11631-03-95 — CONTAINS —							
Part #	Rings	O.E. #						
18-3969	Standard	688-11603-A0-00						

PISTON APPLICATION

HP/Model	Years	PISTON			RINGS		
		Std.	.25mm	.50mm	Std.	.25mm	.50mm
9.9/15	1984-95	18-4135	18-4136	18-4137	18-3976	18-3977	18-3978
9.9/15	1996-2003	18-4135	18-4136	18-4137	18-3976	18-3977	18-3978
25	1985	18-4138	—	—	18-3954	—	—
25	1988-Up	18-4141	18-4142	18-4143	18-3960	18-3961	—
30	1984-86	18-4138	—	—	18-3954	—	—
C30	1989-92	18-4138	—	—	18-3954	—	—
C30	1993-97	—	18-4145	18-4146	—	—	—
40	1984-88	18-4141	18-4142	18-4143	18-3960	18-3961	—
40	1992-94	18-4141	18-4142	18-4143	18-3960	18-3961	—
40	1996-2003	18-4141	18-4142	18-4143	18-3960	18-3961	—
C40	1997-99,2001-02	—	18-4142	18-4143	18-3960	18-3961	—

APPLICATION CONTINUED ON NEXT PAGE

PISTON APPLICATION (Cont.)

HP/Model	Years	PISTON			RINGS		
		Std.	.25mm	.50mm	Std.	.25mm	.50mm
P40	1998	—	—	18-4143	18-3960	18-3961	—
E48	1997	18-4097	18-4098	18-4099	18-3969	18-3970	—
50	1986-88	18-4141	18-4142	18-4143	18-3960	18-3961	—
50	1996-97, 1999, 2000, 2002-03	18-4141	18-4142	18-4143	18-3960	18-3961	—
C50	1998-99, 2001	—	18-4142	18-4143	18-3960	18-3961	—
P50	1996	—	18-4142	18-4143	18-3960	18-3961	—
P50	1987-88	18-4141	18-4142	18-4143	18-3960	18-3961	—
55	1993-95	18-4097	—	18-4099	18-3969	—	—
60	1984-98	18-4091	—	18-4093	18-3963	—	—
60	2002-03	18-4091	—	18-4093	18-3963	—	—
C60	1996-01	18-4091	—	18-4093	18-3963	—	—
E60 MLH,T,U,V	1995-97	18-4094	—	18-4096	18-3963	—	—
P60	1991-99	18-4091	—	18-4093	18-3963	—	—
70	1984-98	18-4091	—	18-4093	18-3963	—	—
70	1999-03	18-4091	—	18-4093	18-3963	—	—
C70	2000-01	18-4091	—	18-4093	18-3963	—	—
75	1994-98	18-4097	—	18-4099	18-3969	—	—
C75	1996	18-4097	—	18-4099	18-3969	—	—
C75	1998-99	18-4097	—	18-4099	18-3969	—	—
E75	1996	18-4097	—	18-4099	18-3969	—	—
E75	1997	18-4097	—	18-4099	18-3969	—	—
P75	1996-99	18-4097	—	18-4099	18-3969	—	—
C80	1997	18-4097	—	18-4099	18-3969	—	—
C85	1992-96	18-4097	—	18-4099	18-3969	—	—
90	1994-99	18-4097	—	18-4099	18-3969	—	—
C90	1997-01	18-4097	—	18-4099	18-3969	—	—

OUTBOARD

V4 & V-6 Engines	Years	PISTON						RINGS	
		Port Std.	Stbd. Std.	Port .25mm	Stbd. .25mm	Port .50mm	Stbd. .50mm	Std.	
115 w/22mm wrist pin	V-4	1984-86	18-4128	18-4129	18-4130	18-4131	18-4132	18-4133	18-3934
115 w/22mm wrist pin	V-4	1987-92	18-4128	18-4129	18-4130	18-4131	18-4132	18-4133	18-3934
115 w/23mm wrist pin	V-4	1993-03	18-4080	18-4081	18-4082	18-4083	18-4084	18-4085	18-39320
130 w/22mm wrist pin	V-4	1984-92	18-4128	18-4129	18-4130	18-4131	18-4132	18-4133	18-3934
130 w/23mm wrist pin	V-4	1993-03	18-4080	18-4081	18-4082	18-4083	18-4084	18-4085	18-39320
150, 175 w/22mm wrist pin	V-6	1984-92	18-4128	18-4129	18-4130	18-4131	18-4132	18-4133	18-3934
150, 175 w/23mm wrist pin	V-6	1993-99	18-4080	18-4081	18-4082	18-4083	18-4084	18-4085	18-39320
200, 225 w/22mm wrist pin	V-6	1984-92	18-4128	18-4129	18-4130	18-4131	18-4132	18-4133	18-3934
200, 225 w/22mm wrist pin	V-6	1993-99	18-4080	18-4081	18-4082	18-4083	18-4084	18-4085	18-39320
SPECIAL J,K,LN,XN (6G7)	V-6	1984-86	18-4128	18-4129	18-4130	18-4131	18-4132	18-4133	18-3934



18-1755
CONNECTING ROD
Replaces: 650-11651-04-00
Fits: 9.9, 15 (1996-97)



18-1756
CONNECTING ROD
Replaces: 688-11650-03-00
Fits: 55 (1991-95), 75 (1994-99), 80 (1997),
85 (1991-96), 90 (1997, 2000-01),



18-1755K
CONNECTING ROD KIT
Replaces: 650-11651-04-00
Fits: E336 9.9 (1996-97), 15 (1996-97)



18-4157
CONNECTING ROD
Replaces: 6R5-11650-10-00
For: V6 150/175/200 (1992-03)



18-4158
CONNECTING ROD
Replaces: 6E5-11650-01-00
For: V4, 115 (1984-92), 130 (1988-92), 150, 175,
& 200(1985-92), 225(1990-91), C115(1990-92),
L130(1989-92), L150(1987-92), L200(1986-92),
V150(1987-90), V6 Excel & Special(1985-89)



18-1410
ROD BEARING
Replaces: 93310-32337-00
Fits: 115 (1993-03), 130 (1993-00, 2002-03),
150 (1992-00, 2002-03), 175 (1992-98, 2000),
200 (1992-98), 225 (1992-93, 1997)



**18-1411
ROD BEARING**
Replaces: 93310-620V5-00
Fits: 9.9 (1996-97), 15 (1996-97)



**18-4077
ROD BEARING**
Replaces: 93310-730V8-00
For: 45, 55, 90 HP -3 Cyl.



**18-4078
ROD BEARING**
Replaces: 93310-836V2-00
For: V4 & V6 (1990 motors)



4 CYCLE OUTBOARD OIL FILTERS

Make-Model	Years	Replaces:	Part No
F/T9.9	1990-03	6G8-13440-00-00	18-7901
F/T50	1995-99	3FV-13440-00-00	18-7902
F15,F25	1998-99	3FV-13440-00-00	18-7902
F80/F100	1999	3FV-13440-00-00	18-7902
F40	1999-00	3FV-13440-00-00	18-7902
F200/F225	2002-06	69J-13440-00-00	18-7906-1
F150	2004-06	69J-13440-00-00	18-7906-1
F250	2005-06	69J-13440-00-00	18-7906-1
F350	2008-up	N26-13440-00-00	18-7954



**18-79111
OIL FILTER**
Replaces: 5GH-13440-00-00



**18-7954
OIL FILTER**
Replaces: N26-13440-00-00
Fits: F350



**18-4400
POWERHEAD GASKET SET**
Replaces: 61A-W0001-01-00, 61A-W0001-A1-00
— CONTAINS —

Part #	Desc.	O.E. #	Qty.
18-3891	Head Gasket	61A-11181-00-A0	2
18-7443	O-Ring	93210-81MA6-00	1

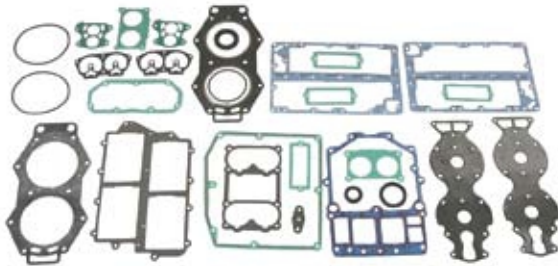

**18-4403
POWERHEAD GASKET SET**
Replaces: 6F3-W0001-04-00, 6F3-W0001-A4-00
— CONTAINS —

Part #	Desc.	O.E. #	Qty.
18-3832	Head Gasket	6E5-11181-02-00	2
18-0844	Thermostat Cover Gasket	688-12414-A1-00	2
18-2079	Oil Seal	93101-22M15-00	1
18-2085	Oil Seal	93102-35M13-00	1
18-7442	O-Ring	93210-74M35-00	1
18-7444	O-Ring	93211-04384-00	2

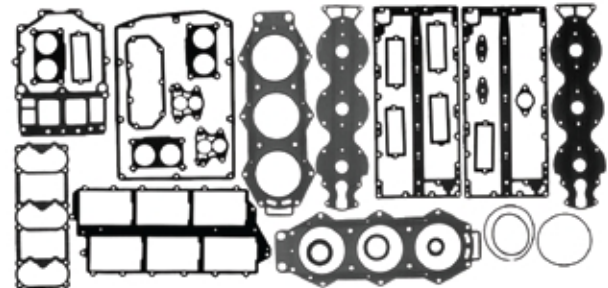

**18-4404
POWERHEAD GASKET SET**
Replaces: 6G5-W0001-03-00, 6G5-W0001-A3-00
— CONTAINS —

Part #	Desc.	O.E. #	Qty.
18-3894	Head Gasket	6G5-11181-A0-00	2
18-0844	Thermostat Cover Gasket	688-12414-A1-00	2
18-2079	Oil Seal	93101-22M15-00	1
18-2085	Oil Seal	93102-35M13-00	1
18-7442	O-Ring	93210-74M35-00	1
18-7444	O-Ring	93211-04384-00	2

OUTBOARD

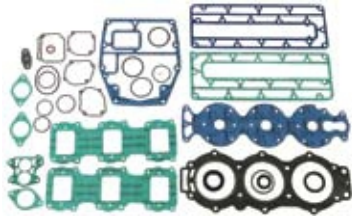

**18-4405
POWERHEAD GASKET SET**

Replaces: 6H1-W0001-00-00, 6H1-W0001-01-00,
6H1-W0001-A0-00
— CONTAINS—

Part #	Desc.	O.E. #	Qty.
18-3805	Head Gasket	688-11181-02-00	1
18-0840	O-Ring	676-14984-00-00	3
18-0844	Thermostat Cover Gasket	688-12414-A1-00	1
18-0845	Intake Manifold Reed Plate Gasket	688-13621-A1-00	2
18-0846	Carburetor Mounting Gasket	688-14198-A1-00	3
18-0847	Exhaust Cover Gasket	688-41112-A0-00	1
18-0826	Drain Screw Gasket	90430-14115-00	1
18-7434	O-Ring	93210-39ME4-00	3
18-7436	O-Ring	93210-46044-00	3
18-7441	O-Ring	93210-62269-00	1
18-0767	Water Jacket Cover Gasket	688-11193-01-00	1

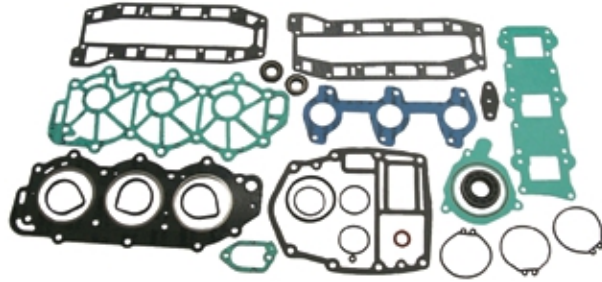

**18-4407
POWERHEAD GASKET SET**

Replaces: 6H4-W0001-01-00, 6H4-W0001-A1-00
— CONTAINS—

Part #	Desc.	O.E. #	Qty.
18-3830	Head Gasket	6H4-11181-00-00	1
18-0826	Drain Screw Gasket	90430-14115-00	1

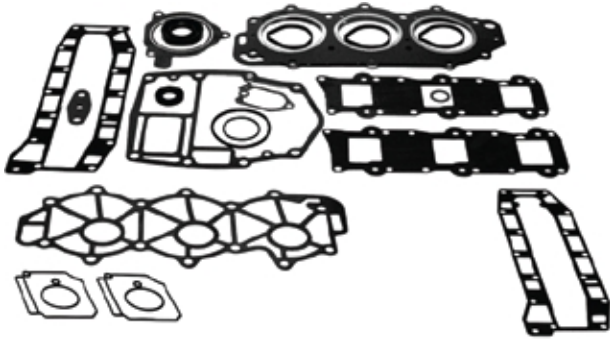

**18-4409
POWERHEAD GASKET SET**

Replaces: 6H4-W0001-03-00, 6H4-W0001-04-00
— CONTAINS—

Part #	Desc.	O.E.#	Qty.
18-3830	Head Gasket	6H4-11181-00-00	1
18-0826	Drain Screw Gasket	90430-14115-00	1
18-7432	O-Ring	93210-32768-00	1

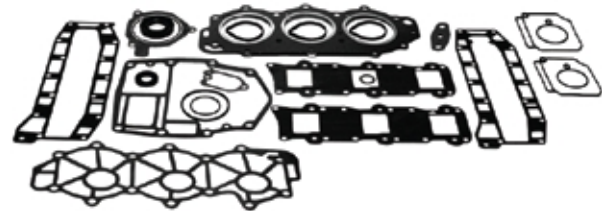

**18-4410
POWERHEAD GASKET SET**

Replaces: 6K7-W0001-04-00, 6K7-W0001-A4-00
— CONTAINS—

Part #	Desc.	O.E. #	Qty.
18-3894	Head Gasket	6G5-11181-A0-00	2
18-0844	Thermostat Cover Gasket	688-12414-A1-00	2
18-2079	Oil Seal	93101-22M18-00	1
18-2085	Oil Seal	93102-35M13-00	1
18-7442	O-Ring	93210-74M35-00	1
18-7444	O-Ring	93211-04384-00	2

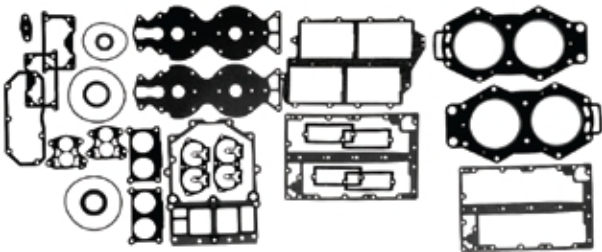

**18-4411
POWERHEAD GASKET SET**

Replaces: 6N6-W0001-03-00, 6N6-W0001-A3-00
— CONTAINS—

Part #	Desc.	O.E. #	Qty.
18-3832	Head Gasket	6E5-11181-02-00	2
18-0844	Thermostat Cover Gasket	688-12414-A1-00	2
18-2079	Oil Seal	93101-22M18-00	1
18-2085	Oil Seal	93102-35M13-00	1
18-7442	O-Ring	93210-74M35-00	1
18-7444	O-Ring	93211-04384-00	2

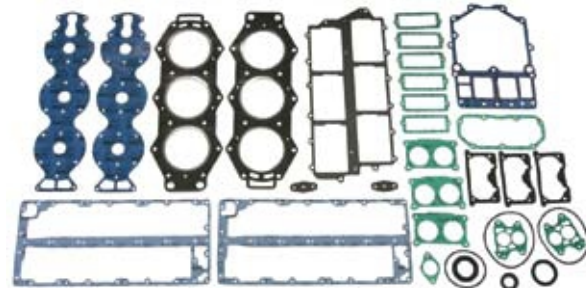

**18-4412
POWERHEAD GASKET SET**

Replaces: 6R3-W0001-03-00, 6R3-W0001-A3-00
— CONTAINS—

Part #	Desc.	O.E. #	Qty.
18-3894	Head Gasket	6G5-11181-A0-00	2
18-0844	Thermostat Cover Gasket	688-12414-A1-00	2
18-2079	Oil Seal	93101-22M18-00	1
18-2085	Oil Seal	93102-35M13-00	1
18-7442	O-Ring	93210-74M35-00	1
18-7444	O-Ring	93211-04384-00	2

APPLICATION BEGINS ON PAGE 423

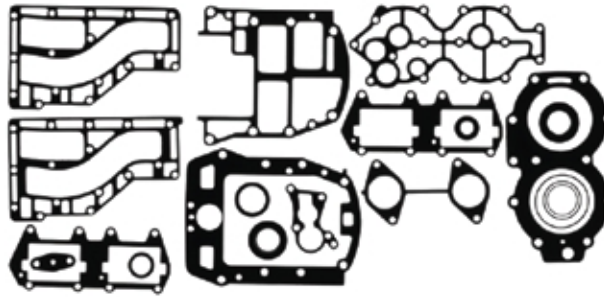

18-4413
POWERHEAD GASKET SET
Replaces: 6R6-W0001-01-00
— CONTAINS —

Part #	Desc.	O.E. #	Qty.
18-3892	Head Gasket	676-11181-00-A0	1
18-7441	O-Ring	93210-62269-00	1

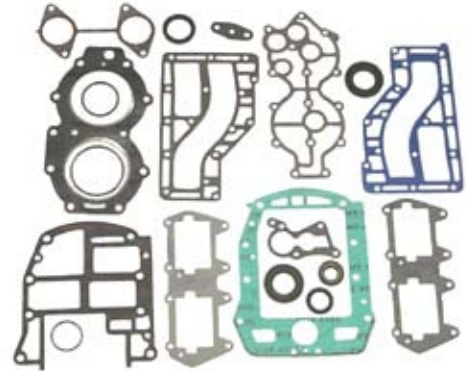

18-4414
POWERHEAD GASKET SET
Replaces: 6R6-W0001-02-00
— CONTAINS —

Part #	Desc.	O.E. #	Qty.
18-3892	Head Gasket	676-11181-00-A0	1
18-7432	O-Ring	93210-32768-00	1
18-7441	O-Ring	93210-62269-00	1

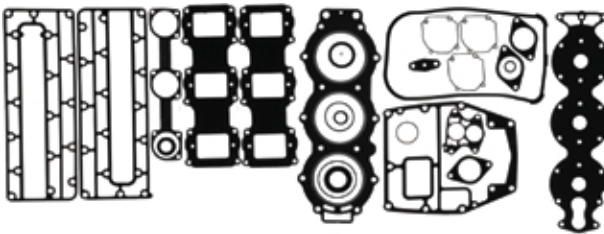

18-4415
POWERHEAD GASKET SET
Replaces: 688-W0001-00-00, 688-W0001-A0-00
— CONTAINS —

Part #	Desc.	O.E. #	Qty.
18-0840	Fuel Bowl Seal	676-14984-00-00	3
18-3805	Head Gasket	688-11181-02-00	1
18-0844	Thermostat Cover Gasket	688-12414-A1-00	1
18-0846	Carburetor Mounting Gasket	688-14198-A1-00	3
18-0847	Exhaust Cover Gasket	688-41112-A0-00	2
18-0826	Drain Screw Gasket	90430-14115-00-00	1
18-0767	Water Jacket Cover Gasket	688-11193-01-00	1
18-0845	Intake Manifold Reed Plate Gasket	688-13621-A1-00	2
18-7441	O-Ring	93210-62269-00	1

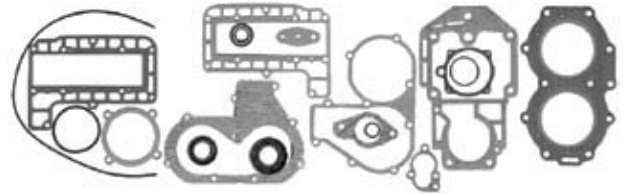

18-4417
POWERHEAD GASKET SET
Replaces: 695-W0001-01-00, 695-W0001-02-00,
695-W0001-A2-00
— CONTAINS —

Part #	Desc.	O.E. #	Qty.
18-0231	Packing Gasket	648-13621-A1-00	1
18-0771	Intake Manifold Gasket	648-13645-A0-00	1
18-0775	Carburetor Mounting Gasket	648-14198-A0-00	1
18-0769	Bowl Gasket	648-14384-01-00	1
18-0232	Cover Gasket	655-12414-A1-00	1
18-0250	Exhaust Cover Gasket	664-41114-A0-00	2
18-2078	Oil Seal	93101-16M36-00	1
18-0570	Oil Seal	93102-23096-00	1
18-3849	Head Gasket	695-11181-A0-00	1
18-0739	Upper Casing Gasket	689-45113-A1-00	1



18-4418
POWERHEAD GASKET SET
Replaces: 697-W0001-00-00, 697-E0001-A0-00
— CONTAINS —

Part #	Desc.	O.E. #	Qty.
18-0241	Valve Seat Gasket	663-13621-A0-00	2
18-0242	Valve Seat Gasket	663-13622-00-00	2
18-0246	Gasket	663-14483-A0-00	1
18-0247	Outer Cover Exhaust Gasket	663-41114-A0-00	1
18-3848	Head Gasket	695-11181-A0-00	1
18-7441	O-Ring	93210-62269-00-00	1

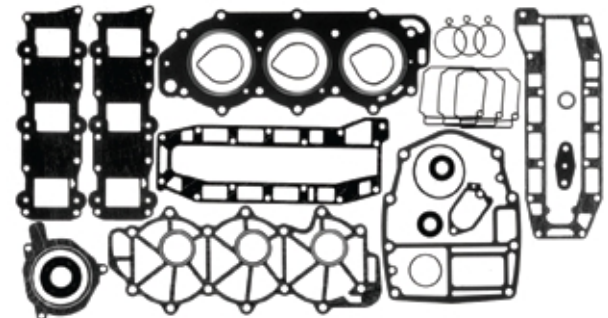

18-4419
POWERHEAD GASKET SET
Replaces: 6H4-W0001-02-00, 6H4-W0001-A2-00
— CONTAINS —

Part #	Desc.	O.E. #	Qty.
18-3830	Head Gasket	6H4-11181-00-00	1
18-0826	Drain Screw Gasket	90430-14115-00-00	1

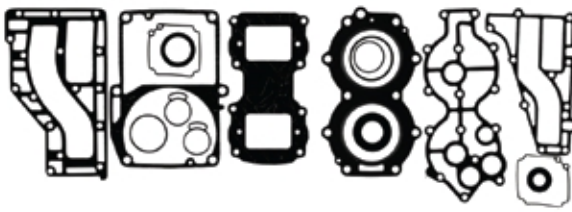

18-4422
POWERHEAD GASKET SET
Replaces: 6L2-W0001-01-00, 6L2-W0001-02-00,
6L2-W0001-A2-00
— CONTAINS —

Part #	Desc.	O.E. #	Qty.
18-3847	Head Gasket	6L2-11181-A1-00	1
18-0765	Flat Chamber Gasket	6L2-14384-00-00	1
18-0743	Exhaust Inner Cover Gasket	6L2-41112-A1-00	1
18-0744	Exhaust Outer Cover Gasket	6L2-41114-A1-00	1
18-0748	Upper Casing Gasket	6L2-45113-A1-00	1

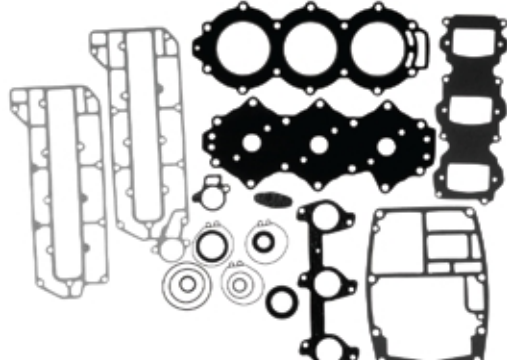

18-4427
POWERHEAD GASKET SET
Replaces: 6H3-W0001-A0-00

OUTBOARD

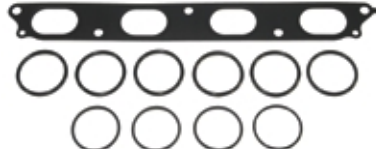

18-0663
PLENUM GASKET KIT
Fits: Yamaha F75 (2003-04), F80 (1999-03),
F90 (2003-04), F100 (1999-02)



18-3804
HEAD GASKET
Replaces: 689-11181-02-00,
689-11181-A1-00



18-3805
HEAD GASKET
Replaces: 688-11181-02-00,
688-11181-A1-00



18-3827
HEAD GASKET
Replaces: 6G8-11181-00-00,
6G8-11181-A1-00



18-3828
HEAD GASKET
Replaces: 6E7-11181-00-00,
6E7-11181-A1-00



18-3829
HEAD GASKET
Replaces: 6J8-11181-00-00,
6J8-11181-A1-001



18-3830
HEAD GASKET
Replaces: 6H4-11181-00-00,
6H4-11181-A1-00









18-3831
HEAD GASKET
Replaces: 6H3-11181-01-00,
6H3-11181-A1-00



18-3832
HEAD GASKET
Replaces: 6E5-11181-02-00,
6E5-11181-A1-00

SEE PAGES 117-118 FOR OUR COMPLETE LINE OF GASKET SEALANTS
APPLICATION BEGINS ON NEXT PAGE

 <p>18-3847 HEAD GASKET Replaces: 6L2-11181-A1-00, 6L2-11181-A2-00</p>	 <p>18-3848 HEAD GASKET Replaces: 697-11181-A0-00, 697-11181-A1-00</p>	 <p>18-3849 HEAD GASKET Replaces: 695-11181-A0-00, 695-11181-A1-00</p>
 <p>18-3891 HEAD GASKET Replaces: 61A-11181-A0-00, 61A-11181-A1-00</p>	 <p>18-3892 HEAD GASKET Replaces: 676-11181-A0-00, 676-11181-A1-00</p>	 <p>18-3894 HEAD GASKET Replaces: 6G5-11181-00-00, 6G5-11181-A0-00</p>

POWERHEAD GASKET SETS \ HEAD GASKETS APPLICATION

HP	Year	Powerhead Gasket Set	Head Gasket	HP	Year	Powerhead Gasket Set	Head Gasket
9.9 (4 Stroke)	1985-90	—	18-3827	70	1984-1991	18-4427	18-3831
9.9/15	1988-93	—	18-3828	C85	1989-91	18-4415	18-3805
25 two cylinder	1984-87	18-4416	18-3804	CV85	1989-93	18-4415	18-3805
25 two cylinder	1988-93	18-4422	18-3847	90	1984-93	18-4405	18-3805
C25	1990-93	18-4417	18-3849	115 (6E5)	1984	—	18-3832
CV25	1990	18-4417	18-3849	115	1986	—	18-3832
30	1984-86	18-4416	18-3804	115	1986-91	18-4403	18-3832
30	1987-93	—	18-3829	115 (6E5)	1987-91	18-4403	18-3832
30	1994-97	—	18-3829	115	1992-99	18-4411	18-3832
C30	1989-92	18-4416	18-3804	115 (6N6)	1992-97	18-4411	18-3832
CV30	1989	18-4416	18-3830	C115	1991-95	18-4403	18-3832
40	1984-88	18-4407	18-3830	P115	1993-96	18-4411	18-3832
40	1989-91	18-4419	18-3830	L130 (6L6) 130 (6L1)	1988-91	18-4403	18-3832
40	1992-93	18-4409	18-3830	L130 (6N4) 130 (6N7)	1994-99	18-4411	18-3832
C40 two cylinder	1990-91	18-4423	18-3892	C150	1996-99	18-4404	18-3894
C40 two cylinder	1992-93	18-4413	18-3892	L150	1986-89	18-4404	18-3894
C40 two cylinder	1994-97	18-4414	18-3892	P150	1986-89	18-4404	18-3894
CV40	1990	18-4423	18-3892	P150	1990-93	18-4412	18-3894
50	1984-88	18-4407	18-3830	P150	1994-95	18-4410	18-3894
50	1989-91	18-4419	18-3830	150/175/200 ETLN/ETXN	1984-89	18-4404	18-3894
50	1992-93	18-4409	18-3830	150, L150, P150, PRO V150D	1990-95	18-4412	18-3894
P50	1987-88	18-4407	18-3830	175 (6R3)	1990-94	18-4412	18-3894
P50	1989-91	18-4419	18-3830	P175 (62H)	1994	18-4410	18-3894
P50	1992-93	18-4409	18-3830	P200 (61H)	1991-94	18-4410	18-3894
C55	1989-91	18-4418	18-3848	L200 (6R4) 200 (6R1)	1990-95	18-4412	18-3894
CV55	1989	18-4418	18-3848	V6 Special (6G7)	1984-86	18-4404	18-3894
P60	1991	18-4427	18-3831	V6 Excel (6K7)	1987-89	18-4410	18-3894
				225	1990-95	18-4410	18-3894
				225/L225	1994-96	18-4400	18-3891
				250/L250	1990-96	18-4400	18-3891
		③ 2.6 litre engine					
		④ 3.1 litre engine					
① LJ:-357803/XJ:-700843							
② LJ: 357804/XJ: 700844							

PKG. OF 2



**18-0775
18-0775-9[©]
CARB MOUNTING GASKET**
Replaces: 648-14198-A0-00



**18-0785
CARB MOUNTING GASKET**
Replaces: 6E5-14198-A1-00

PKG. OF 2





















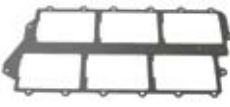

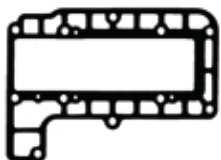

**18-0846
CARB MOUNTING GASKET**
Replaces: 688-14198-A1-00
90 HP



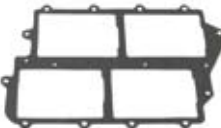
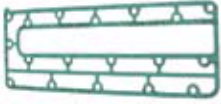

















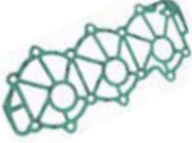



SEE PAGES 117-118 FOR OUR COMPLETE LINE OF GASKET SEALANTS

© Priced per Package

OUTBOARD

 <p>18-0765 FLOAT CHAMBER GASKET Replaces: 6L2-14384-00-00</p>	 <p>18-2592 FLOAT BOWL GASKET Replaces: 6E5-14384-03-00 For: V-4 Outboards: 115, 130, 150, 175, 200, 225 (1986-96) V-6 Special & Excel (1986-89)</p>	 <p>18-0769 FLOAT CHAMBER GASKET Replaces: 648-14384-01-00</p>	 <p>18-0786 FLOAT CHAMBER GASKET Replaces: 6E5-14384-02-00</p>	
 <p>18-0840-1 FLOAT CHAMBER GASKET Replaces: 676-14984-00-00</p>	 <p>18-0246 CARB TO AIR BOX GASKET Replaces: 663-14483-A0-00</p>	 <p>18-0789 CARB TO AIR BOX GASKET Replaces: 6E5-14483-A1-00</p>	 <p>18-0810 AIR CLEANER GASKET Replaces: 6G5-14416-A1-00</p>	 <p>18-0242 VALVE SEAT GASKET Replaces: 663-13622-00-00</p>
 <p>18-0807-1 REED PLATE GASKET Replaces: 6K7-13645-A1-00</p>	 <p>18-0809 REED BLOCK GASKET Replaces: 6G5-13645-A1-00</p>	 <p>18-0808 VALVE COVER GASKET Replaces: 6G5-11382-A1-00</p>	 <p>18-0247 EXHAUST COVER GASKET Replaces: 663-41114-A0-00</p>	 <p>18-0250 EXHAUST COVER GASKET Replaces: 664-41114-A0-00</p>
 <p>18-0743 INNER EXHAUST COVER GASKET Replaces: 6L2-41112-A1-00</p>	 <p>18-0744 OUTER EXHAUST COVER GASKET Replaces: 6L2-41114-A1-00</p>	 <p>18-0798 EXHAUST COVER GASKET Replaces: 6H4-41114-A0-00</p>	 <p>18-0799 EXHAUST COVER GASKET Replaces: 6E5-41112-A1-00</p>	 <p>18-0812 EXHAUST COVER GASKET Replaces: 6G5-41112-A1-00</p>
 <p>18-0823 EXHAUST MANIFOLD GASKET Replaces: 6E5-13645-A1-00</p>	 <p>18-0847 90 HP EXHAUST COVER GASKET Replaces: 688-41112-A0-00</p>	 <p>18-0739 UPPER CASING GASKET Replaces: 689-45113-A1-00</p>	 <p>18-0748 UPPER CASING GASKET Replaces: 6L2-45113-A1-00</p>	 <p>18-0813 POWERHEAD BASE GASKET Replaces: 6G5-45113-A0-00</p>





SEE PAGES 117-118 FOR OUR COMPLETE LINE OF GASKET SEALANTS

 <p>18-0232 COVER GASKET Replaces: 655-12414-A1-00</p>	 <p>18-0782 COVER GASKET Replaces: 6E5-11381-A1-00</p>	 <p>18-0829 COVER GASKET Replaces: 61A-12414-A0-00 6J8-12414-A0-00</p>	 <p>NEW</p> <p>18-0754 THERMOSTAT GASKET Replaces: 68D-E2414-A0-00 Fits: F2.5MSH-0405, F2.5MSH-0406, F2.5MSH-0407, F2.5MSH0608, F2.5MSHD-2007</p>	
 <p>18-0835 THERMOSTAT GASKET Replaces: 62Y-12414-00-00 Fits: F 9.9, T9.9 (2005-06), 15 (2006), F15, F25 (1998-06), T25, F30 (2001-06), F40 4cyl (1999), F40 3cyl (2000-06), F50 (1996-06), T50 (1996-06), F60 (2002-06), T60 (2003-06)</p>	 <p>18-0836 THERMOSTAT GASKET Replaces: 682-12414-A1-00 Fits: 9.9, 15 (1984-06)</p>	 <p>18-0844 THERMOSTAT GASKET Replaces: 688-12414-A1-00 90 HP V-4, V-6</p>	 <p>18-0767 WATER JACKET GASKET Replaces: 688-11193-01-00 90 HP</p>	 <p>18-0779 WATER JACKET GASKET Replaces: 6G5-11193-A0-00</p>
 <p>18-0781 WATER JACKET GASKET Replaces: 6E5-11193-A0-00</p>	 <p>18-0815 WATER JACKET GASKET Replaces: 6H4-11193-A1-00</p>	 <p>18-0483 PUMP CASE GASKET Replaces: 63D-44316-00-00 Fits: 40 (1995-04), 50 (1995-97, 1999-04)</p>	 <p>18-0753 WATER PUMP GASKET Replaces: 6G1-44315-A0-00 Fits: 6 (1986-00), 8 (1984-05)</p>	 <p>18-0239 WATER PUMP GASKET Replaces: 688-44315-A0-00</p>
 <p>18-0240 WATER PUMP GASKET Replaces: 688-44316-A0-00</p>	 <p>18-0244 WATER PUMP GASKET Replaces: 6E5-44315-A0-00</p>	 <p>18-0292 WEAR PLATE TO PUMP HOUSING GASKET Replaces: 663-44315-A0-00</p>	<p>PKG. OF 2</p>  <p>18-0294 18-0294-9① WEAR PLATE TO PUMP BASE GASKET Replaces: 663-44324-A0-00</p>	 <p>18-0756-1 WATER PUMP GASKET Replaces: 6H3-44315-A0-00</p>
 <p>18-0757 OUTER PLATE GASKET Replaces: 6H3-44324-A0-00</p>	<p>PKG. OF 2</p>  <p>18-0768 18-0768-9① WEAR PLATE GASKET Replaces: 682-44315-A0-00</p>	 <p>18-0747 WATER SEAL DAMPER GASKET Replaces: 6L2-44367-00-00</p>	 <p>18-0826 DRAIN SCREW GASKET Replaces: 90430-14115-00-00 40-90 HP</p>	 <p>18-1079 OIL SEAL PROTECTOR Replaces: 6A1-44325-00-00 Fits: 2(1984-85, 1988-99)</p>

OUTBOARD



SEE PAGES 117-118 FOR OUR COMPLETE LINE OF GASKET SEALANTS

© Priced per Package

 <p>18-4274 PROP SPACER Replaces: 688-45997-01-00</p>	 <p>18-4698 18-46981-9^① (PKG. OF 50) DRAIN FILL WASHER Replaces: 90430-08020-00</p>	 <p>18-2371 18-23711-9^① (PKG. OF 50) DRAIN SCREW Replaces: 90340-08002-00, 90340-08M04-00</p>	 <p>18-2374 18-23741-9^① (PKG. OF 50) MAGNETIC DRAIN SCREW Replaces: 688-45341-00-00, 688-45341-10-00</p>
--	--	--	---

 <p>18-2388 PROP SHAFT Replaces: 688-45611-00-00 For: F40 (1999) F50(1999-00) C60/C70/C90 (2000-01) C75 (1994) C85 (1991-94)</p>	 <p>18-2385 PROP SHAFT Replaces: 6E5-45611-01-00 For: 115/130HP</p>	 <p>18-2247 PROP SHAFT Replaces: 679-45611-01-00 For: 40-50HP</p>
---	--	--

Model No.	Year	Part #	Model No.	Year	Part #
40	1984-86, 89-90, 92-94	18-2247	C90	2000-2001	18-2388
C40	1991-93, 95-97	18-2247	115	1984-2000, 2002-2003	18-2385
CV40	1990	18-2247	C115	1991, 1993-2000	18-2385
50	1986-1994	18-2247	F115, LF115	2000-2003	18-2385
P50	1991-1994	18-2247	S115	1996-1999	18-2385
PRO50	1987-1990	18-2247	130	1984-2000, 2002-2003	18-2385
T50	1999-2000	18-2388	L130	1994-2000	18-2385
C60, C70	2000-2001	18-2388	S130	1996-1999	18-2385
C75	1994	18-2388	150	1985, 1997	18-2385
E75	2000	18-2388	175	1985	18-2385
C85	1991-1994	18-2388	200	1984-1985	18-2385
CV85	1990	18-2388	V6 Special	1985-1986	18-2385

 <p>18-2773 CARRIER BEARING Replaces: 663-45331-00-94 For: E48 (1995, 1997-00) / C55 (1991-95)</p>	 <p>18-2782 CARRIER BEARING Replaces: 688-45331-00-94 For: F40 (1999) F50/T50 (1996-00) 60 (2002-03) C60 (1996-01) E60 (1995-99) P60 (1991-99) 70 (1984-03) C70 (2000-01) C75 (1994-96 / 1998-99) E75 (1995-00) P75 (1996-99) C80 (1997) C85 (1991-96)</p>
---	---

Zinc is for saltwater only applications.
Magnesium is for fresh water only applications.
Aluminum is for brackish water, or if boat is used in both fresh and salt environments.







 <p>③ 18-6034 ① 18-6034A ANODE Replaces: 6K1-45371-00-00 For use on lower drive 150,200 HP (1986)</p>	 <p>② 18-6112 ③ 18-6035 ANODE Replaces: 6J9-45371-01-00 For: 150-200 HP</p>	 <p>② 18-6111 ③ 18-6070 ANODE Replaces: 688-45371-02-00 For use on lower casing drive For: 60, 70, 90HP (1984-04) C60, C75, C85, C90 (1994-01), E60, E75 (1995-00), F50 (1996-00), P60, P75 (1991-99), T50 (1996-00)</p>	 <p>③ 18-6090 ANODE Replaces: 6G5-45251-01-00 For use on transom bracket For: 115-225HP (1988-02)</p>
---	---	---	--

① Priced per Package

① Aluminum

② Magnesium

③ Zinc

 <p>③ 18-6091 ANODE Replaces: 6H1-45251-02-00 For: 40-90 HP</p>	 <p>③ 18-6096 ANODE Replaces: 664-45371-01-00 For: 20-50 HP</p>	 <p>③ 18-6097 ANODE Replaces: 6E5-45371-01-00 For use on lower casing drive For: 115, 130 HP(1984-04), V6 Special (1985-86)</p>	 <p>18-3726 PROP NUT Replaces: 90171-18M04 For: ALL V-4 & V-6 (Except D150)</p>	 <p>18-3732 PROP NUT Replaces: 90171-16011-00, 95307-16900-00</p>																																																																																																																																																																																																																																														
 <p>COTTER PINS</p> <table border="1"> <thead> <tr> <th>Part #</th> <th>O.E. #</th> <th>Pkg of</th> </tr> </thead> <tbody> <tr> <td>18-2380 ④</td> <td>91490-30030-00</td> <td>10</td> </tr> <tr> <td>18-3735 ④</td> <td>91490-40030-00</td> <td>10</td> </tr> <tr> <td>18-3748 ④</td> <td>91490-30045-00</td> <td>5</td> </tr> </tbody> </table>	Part #	O.E. #	Pkg of	18-2380 ④	91490-30030-00	10	18-3735 ④	91490-40030-00	10	18-3748 ④	91490-30045-00	5	 <p>① 18-3781D Display Package</p> <p>18-3781 PROP NUT KIT Replaces: 6H1-W4599-00-00 For: T50, C60, E60, P60, 70, C75, C80, C85, 90 — CONTAINS —</p> <table border="1"> <thead> <tr> <th>Part #</th> <th>O.E. #</th> <th>Desc.</th> </tr> </thead> <tbody> <tr> <td>18-4274</td> <td>688-45997-01</td> <td>Spacer</td> </tr> <tr> <td>18-2380</td> <td>91490-30030</td> <td>Cotter Pin</td> </tr> </tbody> </table>	Part #	O.E. #	Desc.	18-4274	688-45997-01	Spacer	18-2380	91490-30030	Cotter Pin	 <p>① 18-3782D Display Package</p> <p>18-3782 PROP NUT KIT Replaces: 6G5-W4599-00-00 — CONTAINS —</p> <table border="1"> <thead> <tr> <th>Part #</th> <th>O.E. #</th> <th>Desc.</th> </tr> </thead> <tbody> <tr> <td>18-3726</td> <td>90171-18M04</td> <td>Prop Nut</td> </tr> <tr> <td>18-4274</td> <td>688-45997-01</td> <td>Spacer</td> </tr> <tr> <td>18-3735</td> <td>91490-40030</td> <td>Cotter Pin</td> </tr> </tbody> </table> <p>ALL V-4 & V-6 (Except D150)</p>	Part #	O.E. #	Desc.	18-3726	90171-18M04	Prop Nut	18-4274	688-45997-01	Spacer	18-3735	91490-40030	Cotter Pin																																																																																																																																																																																																															
Part #	O.E. #	Pkg of																																																																																																																																																																																																																																																
18-2380 ④	91490-30030-00	10																																																																																																																																																																																																																																																
18-3735 ④	91490-40030-00	10																																																																																																																																																																																																																																																
18-3748 ④	91490-30045-00	5																																																																																																																																																																																																																																																
Part #	O.E. #	Desc.																																																																																																																																																																																																																																																
18-4274	688-45997-01	Spacer																																																																																																																																																																																																																																																
18-2380	91490-30030	Cotter Pin																																																																																																																																																																																																																																																
Part #	O.E. #	Desc.																																																																																																																																																																																																																																																
18-3726	90171-18M04	Prop Nut																																																																																																																																																																																																																																																
18-4274	688-45997-01	Spacer																																																																																																																																																																																																																																																
18-3735	91490-40030	Cotter Pin																																																																																																																																																																																																																																																
<table border="1"> <thead> <tr> <th>HP/Model</th> <th>Years</th> <th>Nut #</th> <th>Spacer #</th> <th>Cotter Pin #</th> <th>Kit #</th> </tr> </thead> <tbody> <tr><td>2(6A1)</td><td>1984-95</td><td>—</td><td>—</td><td>18-3748</td><td>—</td></tr> <tr><td>4(6E0)</td><td>1984-90</td><td>—</td><td>—</td><td>18-3748</td><td>—</td></tr> <tr><td>4(6E0)</td><td>1991</td><td>—</td><td>—</td><td>18-2380</td><td>—</td></tr> <tr><td>5</td><td>1984-85</td><td>—</td><td>—</td><td>18-3748</td><td>—</td></tr> <tr><td>9.9(6GB)</td><td>1984-85</td><td>—</td><td>—</td><td>18-3748</td><td>—</td></tr> <tr><td>25(6H7)(6L2)</td><td>1985-95</td><td>—</td><td>—</td><td>18-2380</td><td>—</td></tr> <tr><td>C25(695)</td><td>1990-94</td><td>—</td><td>—</td><td>18-2380</td><td>—</td></tr> <tr><td>30(689)(6J8)</td><td>1984-95</td><td>—</td><td>—</td><td>18-2380</td><td>—</td></tr> <tr><td>C30(689)(61T)</td><td>1989-94</td><td>—</td><td>—</td><td>18-2380/18-3748</td><td>—</td></tr> <tr><td>40(6H4)(63B,C,D)</td><td>1984-95</td><td>18-3732</td><td>—</td><td>18-2380</td><td>—</td></tr> <tr><td>C40(6R6)</td><td>1990-95</td><td>18-3732</td><td>—</td><td>18-2380/18-3748</td><td>—</td></tr> <tr><td>50(6H5)(62X)</td><td>1984-95</td><td>18-3732</td><td>—</td><td>18-2380/18-3748</td><td>—</td></tr> <tr><td>PRO50(6H5)(62X)</td><td>1987-90</td><td>18-3732</td><td>—</td><td>18-2380</td><td>—</td></tr> <tr><td>C55(697)</td><td>1991-95</td><td>18-3732</td><td>—</td><td>18-3735</td><td>—</td></tr> <tr><td>P60(6H2)</td><td>1991-95</td><td>18-3732</td><td>18-4274</td><td>18-3735</td><td>18-3781</td></tr> <tr><td>70(6H3)</td><td>1984-95</td><td>18-3732</td><td>18-4274</td><td>18-3735</td><td>18-3781</td></tr> <tr><td>C75(692)</td><td>1994-95</td><td>18-3732</td><td>18-4274</td><td>18-3735</td><td>18-3781</td></tr> <tr><td>C85(688)</td><td>1989-95</td><td>18-3732</td><td>18-4274</td><td>18-3735</td><td>18-3781</td></tr> <tr><td>90(6H1)</td><td>1984-95</td><td>18-3732</td><td>18-4274</td><td>18-3735</td><td>18-3781</td></tr> <tr><td>115(6E5)(6N6)</td><td>1984-95</td><td>18-3726</td><td>18-4274</td><td>18-3735</td><td>18-3782</td></tr> <tr><td>C115(6E5)</td><td>1991-95</td><td>18-3726</td><td>18-4274</td><td>18-3735</td><td>18-3782</td></tr> <tr><td>P115(62A)</td><td>1993-95</td><td>18-3726</td><td>18-4274</td><td>18-3735</td><td>18-3782</td></tr> <tr><td>130(6L1)(6N7)</td><td>1988-95</td><td>18-3726</td><td>18-4274</td><td>18-3735</td><td>18-3782</td></tr> <tr><td>L130(6L6)(6N4)</td><td>1989-95</td><td>18-3726</td><td>18-4274</td><td>18-3735</td><td>18-3782</td></tr> <tr><td>150(6G4)(6R2)</td><td>1984-95</td><td>18-3726</td><td>18-4274</td><td>18-3735</td><td>18-3782</td></tr> <tr><td>PRO V 150, (6J9)(6N9)</td><td>1986-90</td><td>18-3726</td><td>18-4274</td><td>18-3735</td><td>18-3782</td></tr> <tr><td>P150(6N9)</td><td>1991-95</td><td>18-3726</td><td>18-4274</td><td>18-3735</td><td>18-3782</td></tr> <tr><td>L150(6RO)</td><td>1994-95</td><td>18-3726</td><td>18-4274</td><td>18-3735</td><td>18-3782</td></tr> <tr><td>175(6G5)(6R3)</td><td>1984-95</td><td>18-3726</td><td>18-4274</td><td>18-3735</td><td>18-3782</td></tr> <tr><td>P175(62H)</td><td>1994-95</td><td>18-3726</td><td>18-4274</td><td>18-3735</td><td>18-3782</td></tr> <tr><td>200(6G6)(6R4)</td><td>1984-95</td><td>18-3726</td><td>18-4274</td><td>18-3735</td><td>18-3782</td></tr> <tr><td>L200(6K1)(6R1)</td><td>1986-95</td><td>18-3726</td><td>18-4274</td><td>18-3735</td><td>18-3782</td></tr> <tr><td>P200(61H)</td><td>1991-95</td><td>18-3726</td><td>18-4274</td><td>18-3735</td><td>18-3782</td></tr> <tr><td>225(6R5)(62J)</td><td>1990-95</td><td>18-3726</td><td>18-4274</td><td>18-3735</td><td>18-3782</td></tr> <tr><td>L225(62K)</td><td>1994-95</td><td>18-3726</td><td>18-4274</td><td>18-3735</td><td>18-3782</td></tr> <tr><td>250(61A)</td><td>1990-95</td><td>18-3726</td><td>18-4274</td><td>18-3735</td><td>18-3782</td></tr> <tr><td>L250(61B)</td><td>1990-95</td><td>18-3726</td><td>18-4274</td><td>18-3735</td><td>18-3782</td></tr> <tr><td>V6 SPECIAL(6G7)</td><td>1984-86</td><td>18-3726</td><td>18-4274</td><td>18-3735</td><td>18-3782</td></tr> <tr><td>V6 EXCEL(6K7)</td><td>1987-89</td><td>18-3726</td><td>18-4274</td><td>18-3735</td><td>18-3782</td></tr> </tbody> </table>	HP/Model	Years	Nut #	Spacer #	Cotter Pin #	Kit #	2(6A1)	1984-95	—	—	18-3748	—	4(6E0)	1984-90	—	—	18-3748	—	4(6E0)	1991	—	—	18-2380	—	5	1984-85	—	—	18-3748	—	9.9(6GB)	1984-85	—	—	18-3748	—	25(6H7)(6L2)	1985-95	—	—	18-2380	—	C25(695)	1990-94	—	—	18-2380	—	30(689)(6J8)	1984-95	—	—	18-2380	—	C30(689)(61T)	1989-94	—	—	18-2380/18-3748	—	40(6H4)(63B,C,D)	1984-95	18-3732	—	18-2380	—	C40(6R6)	1990-95	18-3732	—	18-2380/18-3748	—	50(6H5)(62X)	1984-95	18-3732	—	18-2380/18-3748	—	PRO50(6H5)(62X)	1987-90	18-3732	—	18-2380	—	C55(697)	1991-95	18-3732	—	18-3735	—	P60(6H2)	1991-95	18-3732	18-4274	18-3735	18-3781	70(6H3)	1984-95	18-3732	18-4274	18-3735	18-3781	C75(692)	1994-95	18-3732	18-4274	18-3735	18-3781	C85(688)	1989-95	18-3732	18-4274	18-3735	18-3781	90(6H1)	1984-95	18-3732	18-4274	18-3735	18-3781	115(6E5)(6N6)	1984-95	18-3726	18-4274	18-3735	18-3782	C115(6E5)	1991-95	18-3726	18-4274	18-3735	18-3782	P115(62A)	1993-95	18-3726	18-4274	18-3735	18-3782	130(6L1)(6N7)	1988-95	18-3726	18-4274	18-3735	18-3782	L130(6L6)(6N4)	1989-95	18-3726	18-4274	18-3735	18-3782	150(6G4)(6R2)	1984-95	18-3726	18-4274	18-3735	18-3782	PRO V 150, (6J9)(6N9)	1986-90	18-3726	18-4274	18-3735	18-3782	P150(6N9)	1991-95	18-3726	18-4274	18-3735	18-3782	L150(6RO)	1994-95	18-3726	18-4274	18-3735	18-3782	175(6G5)(6R3)	1984-95	18-3726	18-4274	18-3735	18-3782	P175(62H)	1994-95	18-3726	18-4274	18-3735	18-3782	200(6G6)(6R4)	1984-95	18-3726	18-4274	18-3735	18-3782	L200(6K1)(6R1)	1986-95	18-3726	18-4274	18-3735	18-3782	P200(61H)	1991-95	18-3726	18-4274	18-3735	18-3782	225(6R5)(62J)	1990-95	18-3726	18-4274	18-3735	18-3782	L225(62K)	1994-95	18-3726	18-4274	18-3735	18-3782	250(61A)	1990-95	18-3726	18-4274	18-3735	18-3782	L250(61B)	1990-95	18-3726	18-4274	18-3735	18-3782	V6 SPECIAL(6G7)	1984-86	18-3726	18-4274	18-3735	18-3782	V6 EXCEL(6K7)	1987-89	18-3726	18-4274	18-3735	18-3782		
HP/Model	Years	Nut #	Spacer #	Cotter Pin #	Kit #																																																																																																																																																																																																																																													
2(6A1)	1984-95	—	—	18-3748	—																																																																																																																																																																																																																																													
4(6E0)	1984-90	—	—	18-3748	—																																																																																																																																																																																																																																													
4(6E0)	1991	—	—	18-2380	—																																																																																																																																																																																																																																													
5	1984-85	—	—	18-3748	—																																																																																																																																																																																																																																													
9.9(6GB)	1984-85	—	—	18-3748	—																																																																																																																																																																																																																																													
25(6H7)(6L2)	1985-95	—	—	18-2380	—																																																																																																																																																																																																																																													
C25(695)	1990-94	—	—	18-2380	—																																																																																																																																																																																																																																													
30(689)(6J8)	1984-95	—	—	18-2380	—																																																																																																																																																																																																																																													
C30(689)(61T)	1989-94	—	—	18-2380/18-3748	—																																																																																																																																																																																																																																													
40(6H4)(63B,C,D)	1984-95	18-3732	—	18-2380	—																																																																																																																																																																																																																																													
C40(6R6)	1990-95	18-3732	—	18-2380/18-3748	—																																																																																																																																																																																																																																													
50(6H5)(62X)	1984-95	18-3732	—	18-2380/18-3748	—																																																																																																																																																																																																																																													
PRO50(6H5)(62X)	1987-90	18-3732	—	18-2380	—																																																																																																																																																																																																																																													
C55(697)	1991-95	18-3732	—	18-3735	—																																																																																																																																																																																																																																													
P60(6H2)	1991-95	18-3732	18-4274	18-3735	18-3781																																																																																																																																																																																																																																													
70(6H3)	1984-95	18-3732	18-4274	18-3735	18-3781																																																																																																																																																																																																																																													
C75(692)	1994-95	18-3732	18-4274	18-3735	18-3781																																																																																																																																																																																																																																													
C85(688)	1989-95	18-3732	18-4274	18-3735	18-3781																																																																																																																																																																																																																																													
90(6H1)	1984-95	18-3732	18-4274	18-3735	18-3781																																																																																																																																																																																																																																													
115(6E5)(6N6)	1984-95	18-3726	18-4274	18-3735	18-3782																																																																																																																																																																																																																																													
C115(6E5)	1991-95	18-3726	18-4274	18-3735	18-3782																																																																																																																																																																																																																																													
P115(62A)	1993-95	18-3726	18-4274	18-3735	18-3782																																																																																																																																																																																																																																													
130(6L1)(6N7)	1988-95	18-3726	18-4274	18-3735	18-3782																																																																																																																																																																																																																																													
L130(6L6)(6N4)	1989-95	18-3726	18-4274	18-3735	18-3782																																																																																																																																																																																																																																													
150(6G4)(6R2)	1984-95	18-3726	18-4274	18-3735	18-3782																																																																																																																																																																																																																																													
PRO V 150, (6J9)(6N9)	1986-90	18-3726	18-4274	18-3735	18-3782																																																																																																																																																																																																																																													
P150(6N9)	1991-95	18-3726	18-4274	18-3735	18-3782																																																																																																																																																																																																																																													
L150(6RO)	1994-95	18-3726	18-4274	18-3735	18-3782																																																																																																																																																																																																																																													
175(6G5)(6R3)	1984-95	18-3726	18-4274	18-3735	18-3782																																																																																																																																																																																																																																													
P175(62H)	1994-95	18-3726	18-4274	18-3735	18-3782																																																																																																																																																																																																																																													
200(6G6)(6R4)	1984-95	18-3726	18-4274	18-3735	18-3782																																																																																																																																																																																																																																													
L200(6K1)(6R1)	1986-95	18-3726	18-4274	18-3735	18-3782																																																																																																																																																																																																																																													
P200(61H)	1991-95	18-3726	18-4274	18-3735	18-3782																																																																																																																																																																																																																																													
225(6R5)(62J)	1990-95	18-3726	18-4274	18-3735	18-3782																																																																																																																																																																																																																																													
L225(62K)	1994-95	18-3726	18-4274	18-3735	18-3782																																																																																																																																																																																																																																													
250(61A)	1990-95	18-3726	18-4274	18-3735	18-3782																																																																																																																																																																																																																																													
L250(61B)	1990-95	18-3726	18-4274	18-3735	18-3782																																																																																																																																																																																																																																													
V6 SPECIAL(6G7)	1984-86	18-3726	18-4274	18-3735	18-3782																																																																																																																																																																																																																																													
V6 EXCEL(6K7)	1987-89	18-3726	18-4274	18-3735	18-3782																																																																																																																																																																																																																																													

① Items ending in "D" are Display Packaged - Regular number is Non-Display ③ Zinc
④ This product is priced per piece. To order price per package, please add -9 to the part number.

YAMAHA

Gearcase 25 HP (1986-87)

C25 HP (1990-91) C30 HP (1989-91)



OUTBOARD

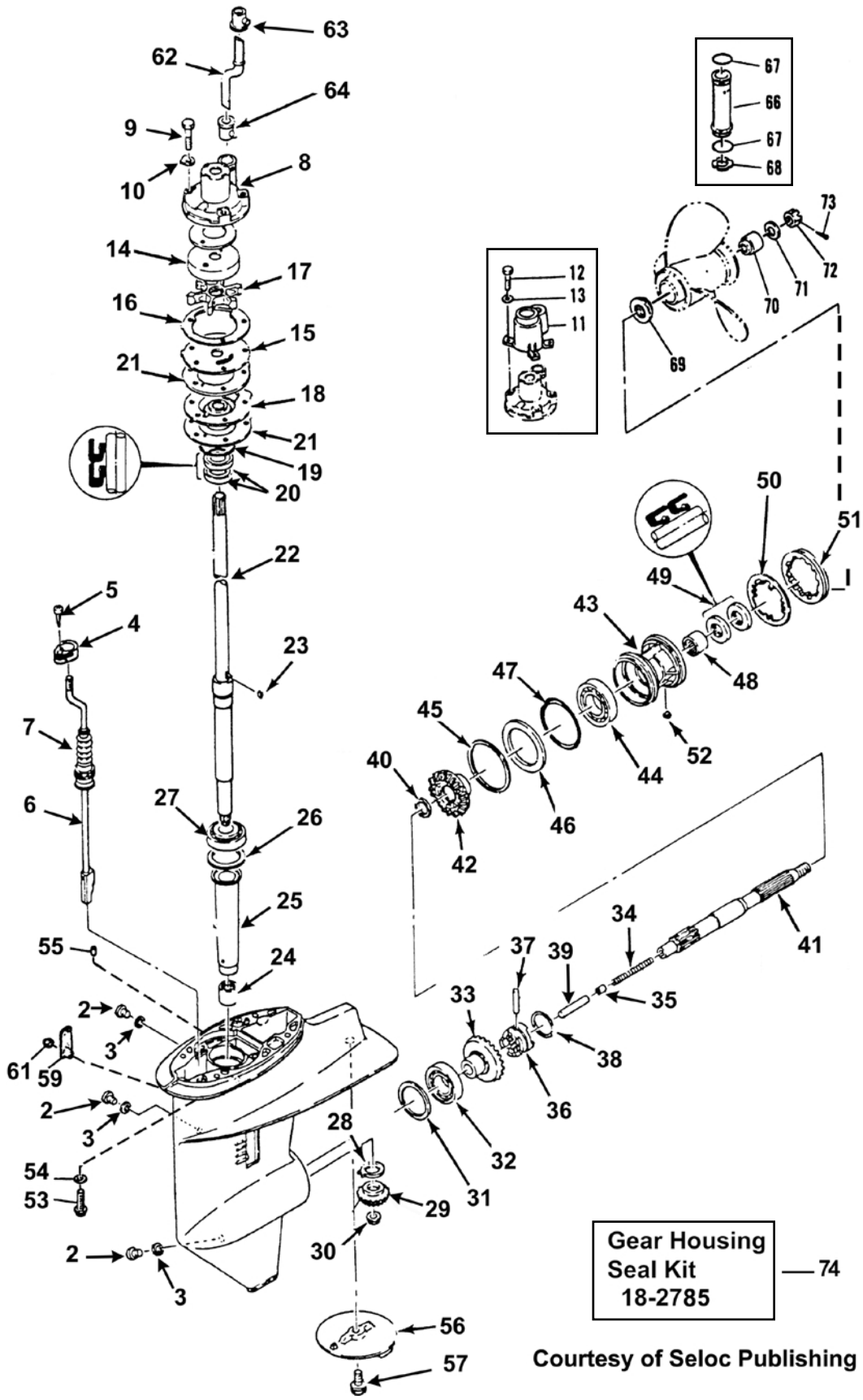

Courtesy of Seloc Publishing



YAMAHA

Gearcase 25 HP (1986-87)

C25 HP (1990-91) C30 HP (1989-91)

Figure #	Description	Part #	O.E.M. #	Qty.	Figure #	Description	Part #	O.E.M. #	Qty.
1.	Housing, Gearcase	—	689-45311-04-EK3	1	35.	Slide, Shift	—	648-45634-00-00	1
2.	Plug, Drain & Vent	—	90340-08M04-00	3	36.	Clutch, Dog	—	664-45631-01-00	1
3.	Gasket, Plug	—	90430-08020-00	3	37.	Pin, Clutch Dog	—	90250-05010-00	1
4.	Bracket, Shift Shaft	—	689-44176-01-00	1	38.	Ring, Cross Pin	—	648-45633-00-00	1
5.	Screw, Bracket	—	97780-50610-00	1	39.	Plunger, Shift	—	648-45635-00-00	1
6.	Shift Cam Assembly (short shaft)	—	664-44150-01-00	1	40.	Thrust, Washer, Prop Shaft	—	90201-20417-00	1
6.	Shift Cam Assembly (long shaft)	—	664-44150-11-00	1	41.	Shaft, Propeller	—	689-45611-00-00	1
7.	Boot, Shift Rod	—	664-44147-00-00	1	42.	Gear, Reverse	—	689-45571-00-00	1
8.	Housing, Water Pump	—	689-44311-03-00	1	43.	Bearing Carrier	—	689-45331-01-94	1
9.	Bolt, Pump Housing	—	90101-06M56-00	3	44.	Bearing, Reverse Gear	—	93306-00612-00	1
10.	Washer, Housing (short shaft)	—	90209-06M04-00	3	45.	Shim Reverse Gear (0.5mm)	—	664-45577-00-05	AR
11.	Extension, Housing (long shaft)	—	689-44312-00-5B	1	45.	Shim Reverse Gear (0.8mm)	—	664-45577-00-08	AR
12.	Bolt, Extension (long shaft)	—	97080-06035-00	3	45.	Shim Reverse Gear (0.12mm)	—	664-45577-01-12	AR
13.	Washer, Bolt (long shaft)	—	92990-06600-00	3	45.	Shim Reverse Gear (0.30mm)	—	664-45577-01-30	AR
14.	Insert Cup	18-3439	689-W4432-02-00.	1	45.	Shim Reverse Gear (0.50mm)	—	664-45577-01-50	AR
15.	Impeller Plate	—	689-44323-03-00	1	46.	Washer, Thrust	—	664-45576-00-00	1
16.	Gasket, Impeller Plate	—	689-44324-A0-00	1	47.	O-Ring, Bearing Carrier	—	93210-30MA3-00	1
17.	Impeller	18-3067	689-44352-02-00	1	48.	Bearing, Prop Shaft	—	93315-22004-00	1
18.	Base, Water Pump	—	689-44325-02-5B	1	49.	Seal, Prop Shaft	18-0554 ①	93101-20M07-00	2
19.	O-Ring, Pump Base	18-7405 ①	93210-40M10-00	1	50.	Tab Washer	—	90214-45M02-00	1
20.	Oil Seal, Pump Base	18-0296 ①	93101-22067-00	2	51.	Nut, Cover	—	664-45384-00-00	1
21.	Gasket, Base	18-0773 ①	689-44316-A0-00	1	52.	Key, Bearing Carrier	—	90282-04010-00	1
22.	Drive Shaft (short)	—	689-45501-00-00	1	53.	Bolt, Gearcase Mounting	—	90105-10059-00	2
22.	Drive Shaft (long)	—	689-45501-10-00	1	54.	Washer, Gearcase Mounting	—	92990-10600-00	4
23.	Key, Impeller	—	664-44338-00-00	1	55.	Pin, Dowel	—	93606-12019-00	2
24.	Bearing, Pinion	—	93315-017U4-00	1	56.	Trim Tab	18-6096A ② 18-6113 ③	664-45371-01-00	1
25.	Sleeve, Drive Shaft	—	689-45536-00-00	1	57.	Bolt, Trim Tab	—	90105-08M02-00	1
26.	Shim Pinion Gear (0.5mm)	—	664-45587-00-05	AR	58.	Cover, Water Inlet (port)	—	689-45214-01-00	1
26.	Shim Pinion Gear (0.8mm)	—	664-45587-00-08	AR	59.	Cover, Water Inlet (stbd)	—	689-45215-01-00	1
26.	Shim Pinion Gear (0.12mm)	—	664-45587-01-12	AR	60.	Screw, Inlet Cover	—	98780-05525-00	1
26.	Shim Pinion Gear (0.30mm)	—	664-45587-01-30	AR	61.	Nut, Nylock	—	90185-05904-00	1
26.	Shim Pinion Gear (0.50mm)	—	664-45587-01-50	AR	62.	Water Tube (short shaft)	—	664-44361-00-00	1
27.	Bearing, Drive Shaft	—	93332-000U4-00	1	62.	Water Tube (long shaft)	—	689-44361-10-00	1
28.	Bearing, Thrust	—	664-45552-09-00	1	63.	Seal, Upper Water Tube	18-0552 ①	689-44366-00-00	1
29.	Gear, Pinion	—	689-45551-00-00	1	64.	Seal, Lower Water Tube	—	626-44365-01-00	1
30.	Nut, Pinion	—	90179-09M02-00	1	65.	Spacer	—	689-44314-00-00	1
31.	Shim Forward Gear (0.5mm)	—	664-45567-00-05	AR	66.	Extension Tube (long shaft)	—	689-44362-00-94	1
31.	Shim Forward Gear (0.8mm)	—	664-45567-00-08	AR	67.	O-Ring, Extension Tube (long shaft)	—	93210-26240-00	2
31.	Shim Forward Gear (0.12mm)	—	664-45567-01-12	AR	68.	Plate (long shaft)	—	689-44328-03-00	1
31.	Shim Forward Gear (0.30mm)	—	664-45567-01-30	AR	69.	Prop Spacer (fore)	—	664-45987-01-00	1
31.	Shim Forward Gear (0.50mm)	—	664-45567-01-50	AR	70.	Prop Spacer (aft)	—	689-45997-00-00	1
32.	Bearing, Forward Gear	—	93332-00005-00	1	71.	Washer, Prop Mounting	—	92990-14200-00	1
33.	Gear, Forward	—	689-45560-00-00	1	72.	Nut, Propeller	—	90171-14013-00	1
34.	Spring, Compression	—	90501-10065-00	1	73.	Cotter Pin	18-2380	91490-30030-00	1
					74.	Gear Housing Seal Kit	18-2785	689-W0001-22-00	1

① Contents of Gear Housing Seal Kit 18-2785
③ Magnesium

② Aluminum
AR As required

OUTBOARD

YAMAHA
Gearcase 40 & 50 HP (1984-87)



OUTBOARD

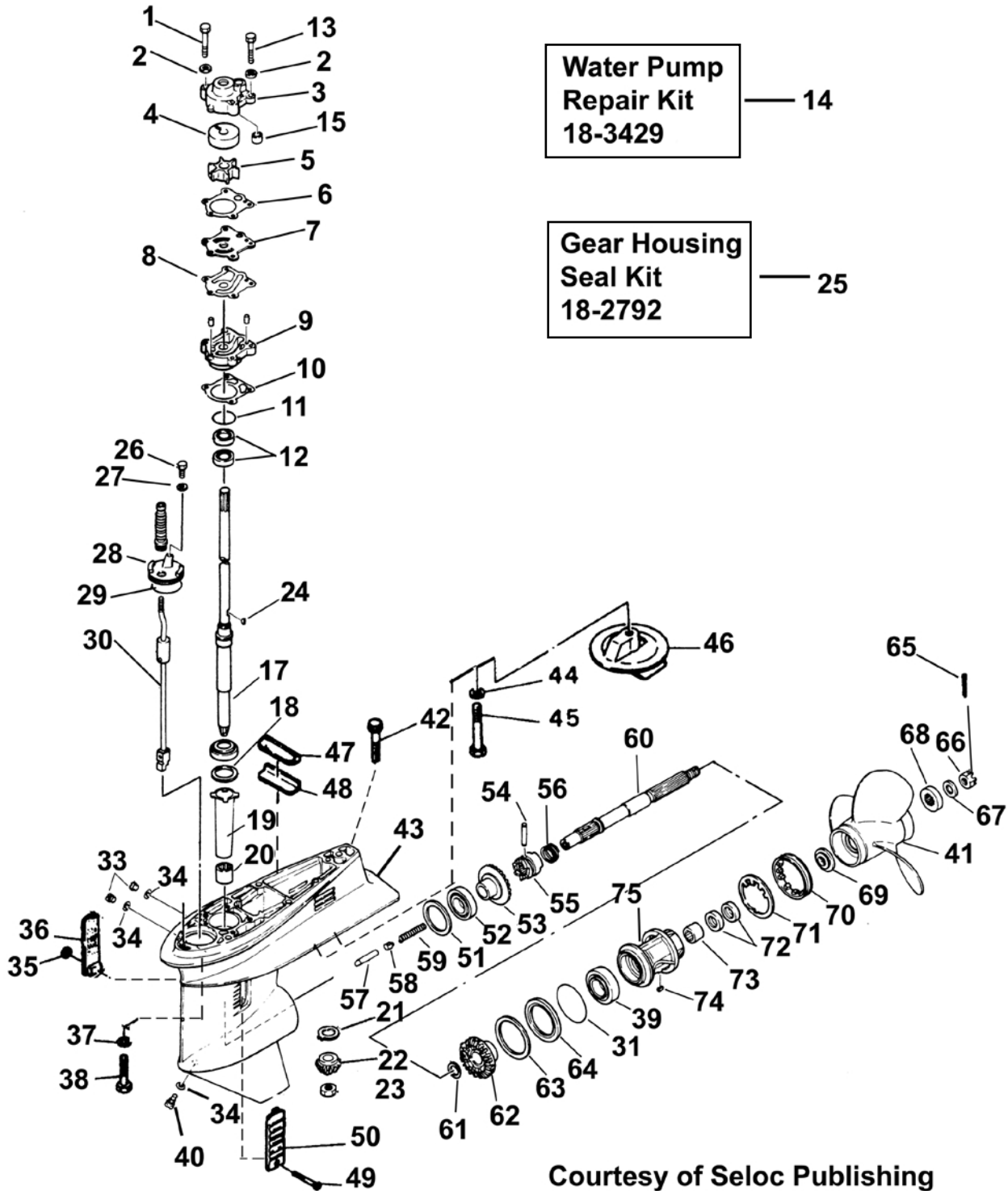

Courtesy of Seloc Publishing

Figure #	Description	Part #	O.E.M. #	Qty.	Figure #	Description	Part #	O.E.M. #	Qty.
1.	Bolt, Water Pump Housing	—	97395-08055-00	2	42.	Bolt, Trim Tab	—	97575-08675-00	1
2.	Washer, Water Pump Housing	—	92990-08600-00	4	43.	Casing, Lower	—	6H4-45301-01-EK	1
3.	Housing, Water Pump	—	663-44311-02-00	1	44.	Washer, Locking	—	92990-08100-00	1
4.	Insert, Water Pump	18-3435 ①	663-44322-00-00	1	45.	Bolt, Lower Casing	—	97095-08085-00	1
5.	Impeller	18-3068 ①	6H4-44352-02-00	1	46.	Tab, Trim	18-6096A ③ 18-6113 ④	664-45371-01-00	1
6.	Gasket, Wear Plate to Water Pump	18-0292 ① ②	663-44315-A0-00	1	47.	Seal, Rubber	—	688-45375-00-00	1
7.	Wear Plate, Water Pump	18-3436	663-44323-00-00	1	48.	Guide, Seal Rubber	—	663-45376-00-94	1
8.	Gasket, Wear Plate to Water Pump	18-0294 ① ②	663-44324-A0-00	1	49.	Screw Ovalhead	—	98780-05535-00	1
9.	Base, Water Pump	—	663-44341-00-94	1	50.	Cover, Water Inlet (port)	—	668-45214-02-00	1
10.	Gasket, Pump Base	—	663-44316-A0-00	1	51.	Shim Forward Gear (0.5mm)	—	6H4-45567-00-05	1
11.	O-Ring, Pump Base	18-0298 ②	93210-41042-00	1	51.	Shim Forward Gear (0.8mm)	—	6H4-45567-00-08	AR
12.	Oil Seal, Pump Base	18-0297 ②	93101-23070-00	2	51.	Shim Forward Gear (0.12mm)	—	6H4-45567-01-12	AR
13.	Bolt, Water Pump Housing	18-0256 ①	97095-08045-00	2	51.	Shim Forward Gear (0.30mm)	—	6H4-45567-01-30	AR
14.	Water Pump Repair Kit	18-3429	6H4-W0078-00-00	1	51.	Shim Forward Gear (0.50mm)	—	6H4-45567-01-50	AR
15.	Water Seal	—	663-44366-00-00	1	52.	Bearing, Tapered Roller	—	93332-000V4-00	1
16.	Bearing, Tapered Roller	—	93332-00079-00	1	53.	Gear, Forward	—	6H4-45560-00-00	1
17.	Drive Shaft (short)	—	6H4-45501-00-00	1	54.	Pin, Cross (clutch dog)	—	90250-06023-00	1
17.	Drive Shaft (long)	—	6H4-45501-10-00	1	55.	Clutch, Sliding	—	663-45631-01-00	1
18.	Shim (0.5mm)	—	663-45587-00-05	AR	56.	Retainer Ring, Cross Pin	—	663-45633-00-00	1
18.	Shim (0.8mm)	—	663-45587-00-08	AR	57.	Plunger, Shift	—	676-45635-00-00	1
18.	Shim (0.12mm)	—	663-45587-01-12	AR	58.	Slide, Shift	—	663-45634-00-00	1
18.	Shim (0.30mm)	—	663-45587-01-30	AR	59.	Spring, Compression	—	60501-16M01-00	1
18.	Shim (0.50mm)	—	663-45587-01-50	AR	60.	Shaft, Propeller	18-2247	679-45611-01-00	1
19.	Sleeve, Drive Shaft	—	6H4-45536-00-0	1	61.	Washer, Plate	—	90201-22429-00	1
20.	Bearing, Needle	—	93315-32224-00	1	62.	Gear, Reverse	—	6H4-45571-00-00	1
21.	Bearing (not used 1988 & later)	—	663-45552-00-00	1	63.	Shim Reverse Gear (0.5mm)	—	663-45577-00-05	AR
22.	Gear, Pinion	—	6H4-45551-00-00	1	63.	Shim Reverse Gear (0.8mm)	—	663-45577-00-08	AR
23.	Nut, Pinion Gear	—	90170-12138-00	1	63.	Shim Reverse Gear (0.12mm)	—	663-45577-01-12	AR
24.	Key, Woodruff	18-3305 ①	90280-03024-00	1	63.	Shim Reverse Gear (0.30mm)	—	663-45577-01-30	AR
25.	Gearcase Seal Kit	18-2792	6H4-W0001-20-00	1	63.	Shim Reverse Gear (0.50mm)	—	663-45577-01-50	AR
26.	Bolt, Plate	—	97095-06016-00	1	64.	Washer, Thrust	—	663-45576-00-00	1
27.	Washer, Plate	—	92990-06600-00	1	65.	Pin, Cotter	18-2380	91490-30030-00	1
28.	Plate	—	6H4-45321-01-00	1	66.	Nut, Castle	18-3732	90171-16011-00	1
29.	O-Ring, Plate	—	93210-49046-00	1	67.	Washer	—	92990-16200-00	1
30.	Shift Cam Assembly (short shaft)	—	6H4-44150-01-00	1	68.	Spacer, Prop Mounting (aft)	—	670-45997-02-00	1
30.	Shift Cam Assembly (long shaft)	—	6H4-44150-12-00	1	69.	Spacer, Prop Mounting (fore)	—	663-45987-02-00	1
31.	O-Ring, Bearing Housing	18-0299 ②	93210-66M98-00	1	70.	Nut, Cover	—	697-45384-00-00	1
32.	Plug, Vent	—	90340-08M04-00	2	71.	Washer, Tab	—	90214-48M03-00	1
33.	Pin, Dowel	—	93604-08062-00	2	72.	Oil Seal, Bearing Housing	18-0296 ②	93101-22067-00	2
34.	Gasket, Drain Plug	—	90430-08020-00	3	73.	Bearing, Needle	—	93317-22204-00	1
35.	Nut, Nylock	—	90185-05904-00	1	74.	Key, Bearing Housing	—	90282-04010-00	1
36.	Cover, Water Inlet (stbd)	—	688-45215-02-00	1	75.	Housing, Bearing	—	679-45331-00-94	1
37.	Washer, Locking	—	92990-10100-00	4					
38.	Bolt	—	97078-10040-00	4					
39.	Bearing, Ball	—	93306-00702-00	1					
40.	Plug, Drain	18-2374	688-45341-00-00	1					
41.	Propeller	—	various	1					

① Contents of Water Pump Repair Kit **18-3429**

② Contents of Gear Housing Seal Kit **18-2792**

AR As required

③ Aluminum

④ Magnesium

OUTBOARD

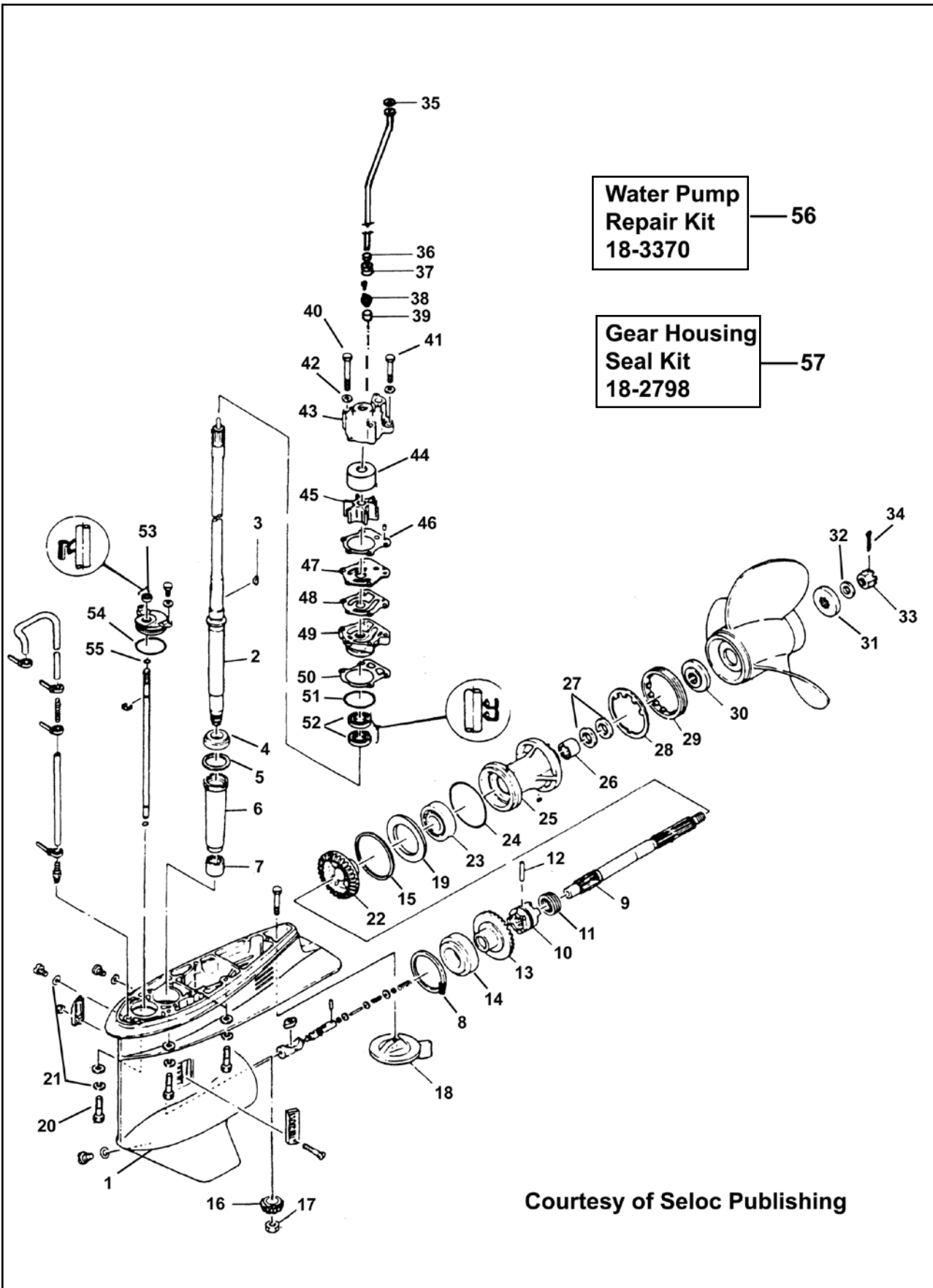

Courtesy of Seloc Publishing

Figure #	Description	Part #	O.E.M. #	Qty.	Figure #	Description	Part #	O.E.M. #	Qty.
1.	Gearcase	—	6H1-45301-04-EK	1	16.	Gear, Pinion	—	688-45551-01-00	1
2.	Drive Shaft	—	6H1-45501-11-00	1	17.	Nut, Pinion	—	90170-16M01-00	1
3.	Key, Impeller	18-3301 ①	90280-04M04-00	1	18.	Trim Tab	18-6070	988-45371-02-00	1
4.	Bearing, Upper Drive Shaft	—	93332-000U3-00	1	19.	Washer, Thrust	—	688-45576-00-00	1
5.	Shim Drive Shaft (0.10mm)	—	688-45587-01-10	AR	20.	Plug, Drain	18-2374	688-45341-00-00	1
5.	Shim Drive Shaft (0.12mm)	—	688-45587-01-12	AR	21.	Gasket, Vent & Drain Plugs	—	90430-08020-00	3
5.	Shim Drive Shaft (0.15mm)	—	688-45587-01-15	AR	22.	Gear, Reverse	—	6H1-45571-00-00	1
5.	Shim Drive Shaft (0.18mm)	—	688-45587-01-18	AR	23.	Bearing, Reverse Gear	—	93306-207U0-00	1
5.	Shim Drive Shaft (0.30mm)	—	688-45587-01-30	AR	24.	O-Ring, Bearing Housing	—	93210-85M97-00	1
5.	Shim Drive Shaft (0.40mm)	—	688-45587-01-40	AR	25.	Housing, Bearing	18-2782	688-45331-00-94	1
5.	Shim Drive Shaft (0.50mm)	—	688-45587-01-50	AR	26.	Bearing, Needle	—	93317-325U0-00	1
6.	Sleeve, Drive shaft	—	688-45536-01-00	1	27.	Oil Seal	18-0587 ②	93101-25M03-00	2
7.	Bearing, Pinion	—	93315-325V1-00	1	28.	Washer, Tab	—	688-45383-02-00	1
8.	Shim Forward Gear (0.10mm)	—	688-45567-01-10	AR	29.	Nut, Cover	—	688-45384-00-00	1
8.	Shim Forward Gear (0.12mm)	—	688-45567-01-12	AR	30.	Spacer, Forward	—	688-45987-01-00	1
8.	Shim Forward Gear (0.15mm)	—	688-45567-01-15	AR	31.	Spacer	18-4274	688-45997-01-00	1
8.	Shim Forward Gear (0.18mm)	—	688-45567-01-18	AR	32.	Washer, Propeller	—	90201-17M00-00	1
8.	Shim Forward Gear (0.30mm)	—	688-45567-01-30	AR	33.	Nut, Castle	18-3732	90171-16011-00	1
8.	Shim Forward Gear (0.40mm)	—	688-45567-01-40	AR	34.	Pin, Cotter	18-3735	91490-40030-00	1
8.	Shim Forward Gear (0.50mm)	—	688-45567-01-50	AR	35.	Washer	—	90202-12060-00	1
9.	Shaft, Propeller	—	6H1-45611-01-00	1	36.	Gasket	—	90430-12072-00	1
10.	Clutch, Dog	—	6H1-45631-01-00	1	37.	Damper, Water Seal	—	663-44367-00-00	1
11.	Spring, Cross Pin	—	688-45633-00-00	1	38.	Grommet	—	90480-19M06-00	1
12.	Pin, Cross	—	90250-07M02-00	1	39.	Damper, Water Seal	—	663-44366-00-00	2
13.	Gear, Forward	—	688-45560-00-00	1	40.	Bolt, Water Pump	—	97395-08070-00	2
14.	Bearing, Forward Gear	—	93332-000W7-00	1	41.	Bolt, Water Pump	—	97395-08050-00	2
15.	Shim Reverse Gear (0.10mm)	—	688-45577-01-10	AR	42.	Washer, Water Pump	—	90209-08M02-00	4
15.	Shim Reverse Gear (0.12mm)	—	688-45577-01-12	AR	43.	Housing, Water Pump	18-3171	688-44311-01-00	1
15.	Shim Reverse Gear (0.15mm)	—	688-45577-01-15	AR	44.	Insert, Water Pump	—	688-44322-00-00	1
15.	Shim Reverse Gear (0.18mm)	—	688-45577-01-18	AR	45.	Impeller	18-3070 ①	688-44352-03-00	1
15.	Shim Reverse Gear (0.30mm)	—	688-45577-01-30	AR	46.	Gasket, Wear Plate to Housing	18-0239 ① ②	688-44315-A0-00	1
15.	Shim Reverse Gear (0.40mm)	—	688-45577-01-40	AR	47.	Wear Plate	18-3341 ①	688-44323-00-00	1
15.	Shim Reverse Gear (0.50mm)	—	688-45577-01-50	AR	48.	Gasket, Wear Plate to Base	—	688-44324-A0-00	1
					49.	Base, Water Pump	—	688-44341-01-94	1
					50.	Gasket, Base	18-0240 ① ②	688-44316-A0-00	1
					51.	O-Ring, Base	18-7436 ① ②	9321-46044-00	1
					52.	Oil Seal, Pump Base	18-0587 ②	93101-25M03-00	2
					53.	Oil Seal, Shift Shaft	18-0267 ②	93106-09014-00	1
					54.	O-Ring	—	93210-49046-00	1
					55.	O-Ring	—	93210-07540-00	1
					56.	Water Pump Repair Kit	18-3370	692-W0078-00-00	1
					57.	Gear Housing Seal Kit	18-2798	688-W0001-20-00	1

① Contents of Gear Housing Seal Kit **18-2798** AR As required

② Contents of Water Pump Repair Kit **18-3370**

OUTBOARD

OUTBOARD

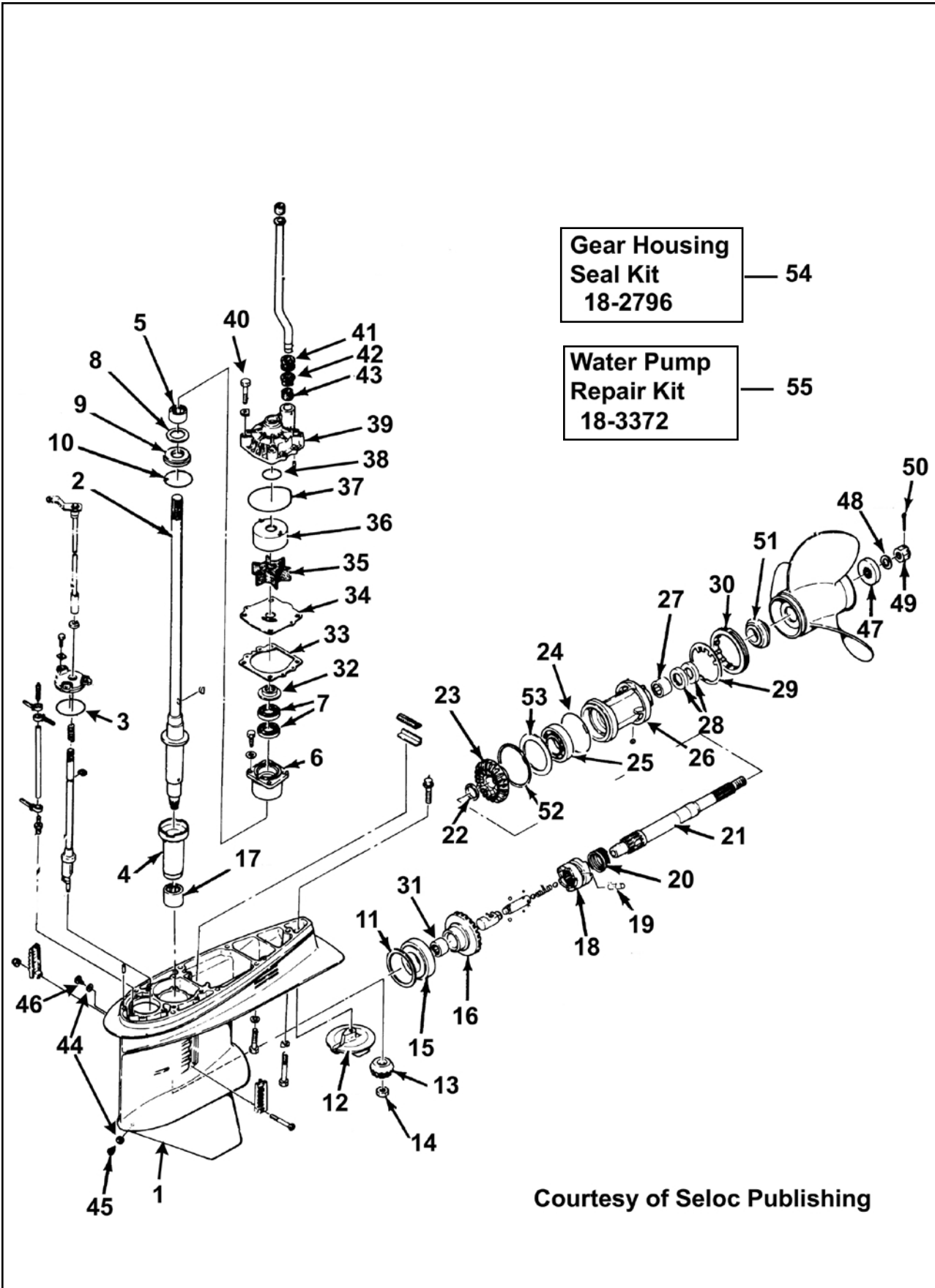

Courtesy of Seloc Publishing

Figure #	Description	Part #	O.E.M. #	Qty.	Figure #	Description	Part #	O.E.M. #	Qty.
1.	Housing, Gearcase	—	6E5-45301-03EK	1	25.	Bearing, Reverse Gear	—	93306-208U0-00	1
2.	Drive Shaft (long)	—	6E5-45501-01-00	1	26.	Housing, Bearing	—	6E5-45332-00-94	1
2.	Drive Shaft (x-long)	—	6E5-45501-21-00	1	27.	Bearing, Needle	—	93315-430U8-00	1
3.	O-Ring, Cover	—	93210-5867-00	1	28.	Seal, Prop Shaft	18-0266 ①	93101-30M17-00	2
4.	Sleeve, Drive shaft	—	6E5-45536-00-00	1	29.	Washer, Tab	—	688-45383-02-00	1
5.	Bearing, Needle	—	93315-430V5-00	1	30.	Nut, Cover	—	688-45384-00-00	1
6.	Housing, Bearing	—	6E5-45331-0094	1	31.	Bearing, Forward Gear	—	93315-425U7-00	1
7.	Seal Drive Shaft	18-0265 ①	93101-28M16-00	2	32.	Cover, Oil Seal	—	6E5-45344-00-00	1
8.	Shim (0.10mm)	—	6E5-45587-01-10	AR	33.	Gasket, Water Pump	18-0244 ① ②	6E5-44315-A0-00	1
8.	Shim (0.12mm)	—	6E5-45587-01-12	AR	34.	Wear Plate, Water Pump	18-3344 ②	6E5-44323-00-00	1
8.	Shim (0.15mm)	—	6E5-45587-01-15	AR	35.	Impeller	18-3071 ②	6E5-44352-00-00	1
8.	Shim (0.18mm)	—	6E5-45587-01-18	AR	36.	Insert, Water Pump	—	6E5-44322-00-00	1
8.	Shim (0.30mm)	—	6E5-45587-01-30	AR	37.	O-Ring, Water Pump	18-7485 ① ②	93210-86M38-00	1
8.	Shim (0.40mm)	—	6E5-45587-01-40	AR	38.	O-Ring, Water Pump	18-7483 ① ②	93210-37M67-00	1
8.	Shim (0.50mm)	—	6E5-45587-01-50	AR	39.	Housing, Water Pump	18-3170	6E5-44311-00-00	1
9.	Bearing, Taper	—	93341-930U0-00	1	40.	Bolt, Water Pump	—	97080-08045-00	4
10.	O-Ring, Housing	—	93210-54534-00	1	41.	Damper, Water Seal	—	6E5-44366-00-00	1
11.	Shim (0.10mm)	—	6E5-45567-01-10	AR	42.	Cover, Pump Housing	—	6E5-44312-00-0	1
11.	Shim (0.12mm)	—	6E5-45567-01-12	AR	43.	Damper, Water Seal	—	6E5-44365-00-00	1
11.	Shim (0.15mm)	—	6E5-45567-01-15	AR	44.	Gasket, Drain Plug	—	90430-08020-00	2
11.	Shim (0.18mm)	—	6E5-45567-01-18	AR	45.	Drain Plug, Lower	18-2374	688-45341-00-00	1
11.	Shim (0.30mm)	—	6E5-45567-01-30	AR	46.	Drain Plug, Upper	—	90340-08M04-00	1
11.	Shim (0.40mm)	—	6E5-45567-01-40	AR	47.	Spacer, Prop	18-4274	688-45997-01-00	1
11.	Shim (0.50mm)	—	6E5-45567-01-50	AR	48.	Washer, Prop Nut	—	92990-18200-00	1
12.	Trim Tab	18-6097A ③	6E5-45371-01-00	1	49.	Nut, Prop	18-3726	90171-18M04-00	1
13.	Gear, Pinion	—	6E5-45551-02-00	1	50.	Pin, Cotter	18-3735	91490-40030-00	1
14.	Nut, Pinion	—	90170-16M01-00	1	51.	Washer, Thrust	—	6E5-45987-01-00	1
15.	Bearing, Forward Gear	—	93332-000U7-00	1	52.	Shim (0.10mm)	—	6L6-45577-00-10	AR
16.	Gear, Forward	—	6E5-45560-01-00	1	52.	Shim (0.12mm)	—	6L6-45577-00-12	AR
17.	Bearing, Needle	—	93315-628U9-00	1	52.	Shim (0.15mm)	—	6L6-45577-00-15	AR
18.	Clutch Dog	—	6R5-45631-01-00	1	52.	Shim (0.18mm)	—	6L6-45577-00-18	AR
19.	Cross, Pin Clutch	—	90250-08M07-00	1	52.	Shim (0.30mm)	—	6L6-45577-00-30	AR
20.	Retainer, Cross Pin	—	6E5-45631-01-00	1	52.	Shim (0.40mm)	—	6L6-45577-00-40	AR
21.	Shaft, Propeller	18-2385	6E5-45611-01-00	1	52.	Shim (0.50mm)	—	6L6-45577-00-50	AR
22.	Washer, Thrust	—	90201-30M92-00	1	53.	Washer, Thrust	—	6E5-45576-00-00	1
23.	Gear, Reverse	—	6E5-45571-04-00	1	54.	Gear Housing Seal Kit	18-2796	6E5-W0001-51-00	1
24.	O-Ring, Bearing Housing	—	93210-86M39-00	1	55.	Water Pump Repair Kit	18-3372	6E5-W0078-00-00	1

① Contents of Gear Housing Seal Kit **18-2796**

② Contents of Water Pump Repair Kit **18-3372**

AR As required

③ Aluminum

YAMAHA

Gearcase V-6 (1984-91)



OUTBOARD

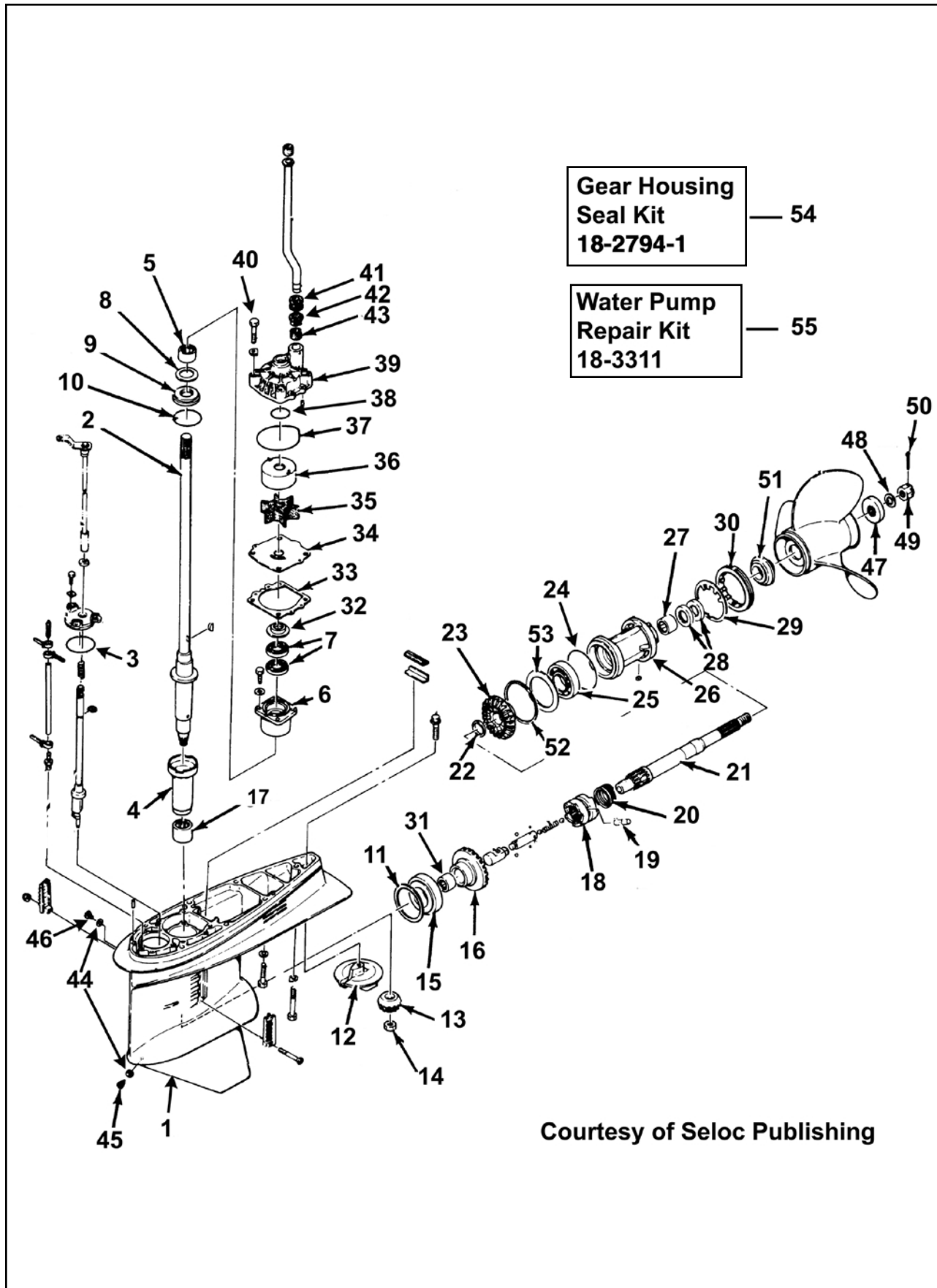

Courtesy of Seloc Publishing

Figure #	Description	Part #	O.E.M. #	Qty.	Figure #	Description	Part #	O.E.M. #	Qty.
1.	Housing, Gearcase	—	6J9-45301-02-EK	1	25.	Bearing, Reverse Gear	—	93306-209U0-00	1
2.	Drive Shaft (long)	—	6G5-45501-01-00	1	26.	Bearing Housing Assembly	—	6J9-45332-00-94	1
2.	Drive Shaft (x-long)	—	6G5-45501-21-00	1	27.	Bearing, Needle	—	93315-430U8-00	1
3.	O-Ring, Plate	—	93210-58677-00	1	28.	Seal, Prop Shaft	18-0266 ①	93101-30M17-00	2
4.	Sleeve, Drive Shaft	—	6G5-45536-01-00	1	29.	Washer, Tab	—	9G5-45383-01-00	1
5.	Bearing, Needle	—	93315-430V5-00	1	30.	Nut, Cover	—	6G5-45384-00-00	1
6.	Housing, Bearing	—	6E5-45331-00-94	1	31.	Bearing, Needle	—	93315-425V3-00	2
7.	Seal, Drive Shaft	18-0265 ①	93101-28M16-00	2	32.	Cover, Oil Seal	—	6E5-45344-00-00	1
8.	Shim (0.10mm)	—	6E5-45587-01-10	AR	33.	Gasket, Wear Plate	18-0244 ① ②	6E5-44315-A0-00	1
8.	Shim (0.12mm)	—	6E5-45587-01-12	AR	34.	Wear Plate	18-3345 ②	6G5-44323-00-00	1
8.	Shim (0.15mm)	—	6E5-45587-01-15	AR	35.	Impeller	18-3071 ②	6E5-44352-00-00	1
8.	Shim (0.18mm)	—	6E5-45587-01-18	AR	36.	Insert, Water Pump	—	6E5-44322-00-00	1
8.	Shim (0.30mm)	—	6E5-45587-01-30	AR	37.	O-Ring, Water Pump	18-7485 ① ②	93210-86M38-00	1
8.	Shim (0.40mm)	—	6E5-45587-01-40	AR	38.	O-Ring, Water Pump	18-7483 ① ②	93210-37M67-00	1
8.	Shim (0.50mm)	—	6E5-45587-01-50	AR	39.	Housing, Water Pump	18-3170	6E5-44311-00-00	1
9.	Bearing, Tapered	—	93341-930U0-00	1	40.	Bolt, Water Pump	—	97080-08045-00	4
10.	O-Ring, Housing	—	93210-54534-00	1	41.	Damper, Water Seal	—	6E5-44366-00-00	1
11.	Shim (0.10mm)	—	6G5-45567-01-10	AR	42.	Cover, Pump Housing	—	6E5-44312-00-00	1
11.	Shim (0.12mm)	—	6G5-45567-01-12	AR	43.	Damper, Water Seal	—	6E5-44365-00-00	1
11.	Shim (0.15mm)	—	6G5-45567-01-15	AR	44.	Gasket, Drain Plugs	—	90430-08020-00	2
11.	Shim (0.18mm)	—	6G5-45567-01-18	AR	45.	Drain, Plug, Lower	18-2374	688-45341-00-00	1
11.	Shim (0.30mm)	—	6G5-45567-01-30	AR	46.	Drain Plug, Upper	—	90340-08M04-00	1
11.	Shim (0.40mm)	—	6G5-45567-01-40	AR	47.	Spacer, Prop	18-4274	688-45997-01-00	1
11.	Shim (0.50mm)	—	6G5-45567-01-50	AR	48.	Washer, Prop	—	92990-18200-00	1
12.	Trim Tab	18-6035	6J9-45371-01-00	1	49.	Nut, Prop	18-3726	90171-18M04-00	1
13.	Gear, Pinion	—	6G5-45551-01-00	1	50.	Pin, Cotter	18-3735	91490-40030-00	1
14.	Nut, Pinion	—	90170-16M01-00	1	51.	Washer, Thrust	—	6E5-45987-00-00	1
15.	Bearing, Forward Gear	—	93332-000V3-00	1	52.	Shim (0.10mm)	—	6G5-45577-02-10	AR
16.	Gear, Forward	—	6G5-45631-00-00	1	52.	Shim (0.12mm)	—	6G5-45577-02-12	AR
17.	Bearing, Needle	—	90250-08M07-00	1	52.	Shim (0.15mm)	—	6G5-45577-02-15	AR
18.	Clutch, Dog	—	6E5-45633-01-00	1	52.	Shim (0.18mm)	—	6G5-45577-02-18	AR
19.	Cross Pin, Clutch	—	90250-08M07-00	1	52.	Shim (0.30mm)	—	6G5-45577-02-30	AR
20.	Retainer, Cross Pin	—	6E5-45633-01-00	1	52.	Shim (0.40mm)	—	6G5-45577-02-40	AR
21.	Shaft, Propeller	—	6J9-45611-01-00	1	52.	Shim (0.50mm)	—	6G5-45577-02-50	AR
22.	Washer, Thrust	—	90201-30M92-00	1	53.	Washer, Thrust	—	6G5-45576-00-00	1
23.	Gear, Reverse	—	6G5-45571-02-00	1	54.	Gear Housing Seal Kit	18-2794-1	6G5-W0001-21-00	1
24.	O-Ring, Bearing Housing	18-0275 ①	93210-97M55-00	1	55.	Water Pump Repair Kit	18-3311	6G5-W0078-00-00	1

① Contents of Gear Housing Seal Kit **18-2794-1**

② Contents of Water Pump Repair Kit **18-3311**

AR As required

OUTBOARD

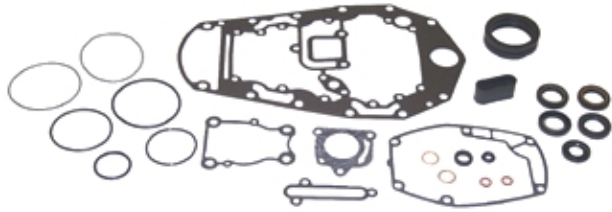

18-0020
GEAR HOUSING SEAL KIT
Replaces: 67C-W0001-21-00

For: T25 (2001-02) / F30 (2002) F40 (2002) 3 cyl model
— CONTAINS —

Part #	Desc.	O.E.#	Qty.
18-0296	Seal, Propshaft	93101-22067	2



18-0021
GEAR HOUSING SEAL KIT
Replaces: 688-W0001-22-00

For: C75 (1994-99) / E75 (1995-00) / P75 (1996-99)
C80 (1997) / C85 (1992-96) / 90 (1992-02) B90(1998-99) / C90 (1997-01)
— CONTAINS —

Part #	Desc.	O.E.#	Qty.
18-0239	Gasket	688-44315-A0	1
18-0240	Gasket	688-44316-A0	1
18-0267	Oil Seal	93106-09014	1
18-0587	Oil Seal	93101-25M03	4
18-4698	Plug, Drain	90430-08020	2



18-0022
GEAR HOUSING SEAL KIT
Replaces: 689-W0001-23-00

For: C25 (1992-97) / C30 (1992)
— CONTAINS —

Part #	Desc.	O.E.#	Qty.
18-0296	Seal, Propshaft	93101-22067	2
18-0554	Seal	93101-20M07	2
18-7405	O-Ring	93210-40M10	1
18-0773	Gasket	689-44316-A0	1
18-4698	Plug, Drain	90430-08020	3



18-0023
GEAR HOUSING SEAL KIT
Replaces: 689-W0001-C2-00

For: C25 (1986-87) C25 (1990-91) 30 (1986) C30 (1990-91)
— CONTAINS —

Part #	Desc.	O.E.#	Qty.
18-0554	Seal	93101-20M07	2
18-7405	O-Ring	93210-40M10	1
18-0773	Gasket	689-44316-A0	1
18-4698	Plug, Drain	90430-08020	3



18-0024
GEAR HOUSING SEAL KIT
Replaces: 698-W0001-21-00

For: E48 (1995-00) / C55 (1989-94)
— CONTAINS —

Part #	Desc.	O.E.#	Qty.
18-0292	Gasket	663-44315-A0	1
18-0294	Gasket	663-44324-A0	1
18-0297	Seal, Drive Shaft	93101-23070	2
18-0296	Seal, Propshaft	93101-22067	2
18-0298	O-Ring	93210-41042	1
18-7160	O-Ring	93210-66M98	1
18-4698	Plug, Drain	90430-08020	3



18-0025
GEAR HOUSING SEAL KIT
Replaces: 69G-W0001-20-00

For: T 8 (2001-04)
— CONTAINS —

Part #	Desc.	O.E.#	Qty.
18-7442	O-Ring	93210-74M68	1
18-4698	Plug, Drain	90430-08020	2

APPLICATION BEGINS ON PAGE 442



18-0026
GEAR HOUSING SEAL KIT
Replaces: 6A1-W0001-22-00
For: 2HP (1986-88)
— CONTAINS —

Part #	Desc.	O.E.#	Qty.
18-4698	Plug, Drain	90430-08020	2



18-0027
GEAR HOUSING SEAL KIT
Replaces: 6A1-W0001-23-00
For: 2HP (1989-02)
— CONTAINS —

Part #	Desc.	O.E.#	Qty.
18-4698	Plug, Drain	90430-08020	2



18-0028
GEAR HOUSING SEAL KIT
Replaces: 6E0-W0001-C1-00
For: 4HP (1984-99) / F4 (1999-02) / 5HP (1984-02)
— CONTAINS —

Part #	Desc.	O.E.#	Qty.
18-4698	Plug, Drain	90430-08020	3



18-0029
GEAR HOUSING SEAL KIT
Replaces: 6G1-W0001-C1-00
For: 6HP (1986-96) 8HP (1984-96)
— CONTAINS —

Part #	Desc.	O.E.#	Qty.
18-4698	Plug, Drain	90430-08020	1



18-0030
GEAR HOUSING SEAL KIT
Replaces: 6L2-W0001-C3-00
For: 20HP (1996-97) 25HP (1988-02) 2 cyl model
— CONTAINS —

Part #	Desc.	O.E.#	Qty.
18-0554	Seal	93101-20M07	2
18-0747	Damper, Water Seal	6L2-44367-00	1
18-4698	Plug, Drain	90430-08020	2



18-0031
GEAR HOUSING SEAL KIT
Replaces: 6N0-W0001-C0-00
For: 6HP (1997-00), 8HP (1997-04)
— CONTAINS —

Part #	Desc.	O.E.#	Qty.
18-4698	Plug, Drain	90430-08020	3



18-2785
GEAR HOUSING SEAL KIT
Replaces: 689-W0001-21-00, 689-W0001-C1-00
— CONTAINS —

Part #	Desc.	O.E. #	Qty.
18-0776	Grommet	682-44365-00-00	1
18-0552	Grommet	689-44366-00-00	1
18-4698	Drain or Fill Washer Gasket	YSG-14090-90-8G	3
18-0554	Oil Seal	93101-20M07-00	1
18-0296	Oil Seal	93101-22067-00	2
18-7405	O-Ring	93210-40M10-00	1
18-0766	Exhaust Tube Gasket	664-41134-A0-00	1
18-0773	Wear Plate Gasket	689-44316-A0-00	1

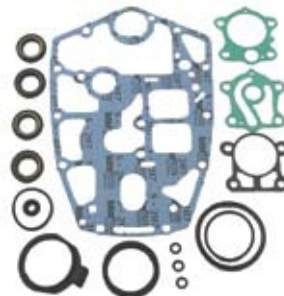

18-2787
GEAR HOUSING SEAL KIT
Replaces: 698-W0001-20-00, 698-W0001-C0-00
— CONTAINS —

Part #	Desc.	O.E. #	Qty.
18-4698	Drain or Fill Washer Gasket	YSG-14090-90-8G	3
18-0296	Oil Seal	93101-22067-00	2
18-0297	Oil Seal	93101-23070-00	2
18-0298	O-Ring	93210-41042-00	1
18-0299	O-Ring	93210-66M98-00	1
18-0292	Wear Plate to Pump Housing Gasket	663-44315-A0-00	1
18-0267	Oil Seal	93106-09014-00	1
18-0294	Wear Plate to Pump Base Gasket	663-44324-A0-00	1

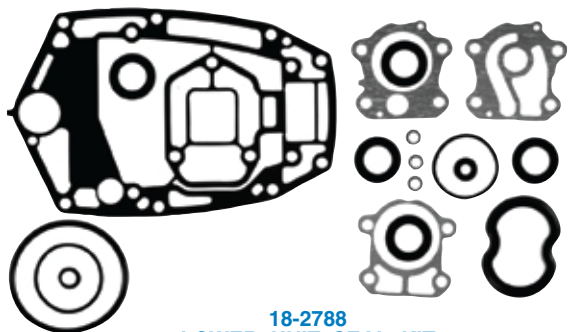

18-2788
LOWER UNIT SEAL KIT
Replaces: 6H3-W0001-21-00, 6H3-W0001-C1-00
— CONTAINS —

Part #	Desc.	O.E. #	Qty.
18-0240	Wear Plate to Gear Case Mounting Gasket	688-44316-A0-00	1
18-0756	Water Pump Gasket	6H3-44315-A0-00	1
18-0757	Outer Plate Gasket	6H3-44324-A0-00	1
18-4698	Drain or Fill Washer	YSG-14090-90-8G	3
18-0297	Oil Seal	93101-23070-00	2
18-0267	Oil Seal	93106-09014-00	1
18-7436	O-Ring	93210-46044-00	1

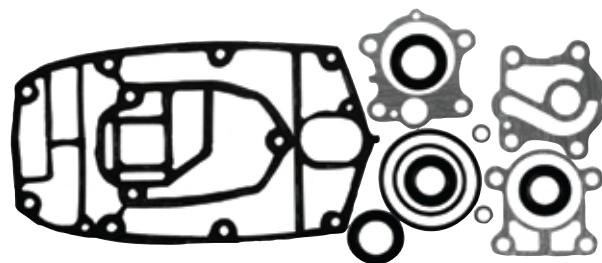

18-2789
LOWER UNIT SEAL KIT
Replaces: 6J8-W0001-21-00, 6J8-W0001-C2-00
— CONTAINS —

Part #	Desc.	O.E. #	Qty.
18-0292	Wear Plate to Pump Housing Gasket	663-44315-A0-00	1
18-0294	Wear Plate to Pump Base Gasket	663-44324-A0-00	1
18-4698	Drain or Fill Washer	YSG-14090-90-8G	2
18-0554	Oil Seal	93101-20M07-00	2
18-0297	Oil Seal	93101-23070-00	2
18-0298	O-Ring	93210-41042-00	1

18-2792
LOWER UNIT SEAL KIT
Replaces: 6H4-W0001-21-00, 6H4-W0001-20-00
— CONTAINS —

Part #	Desc.	O.E. #	Qty.
18-0292	Wear Plate to Pump Housing Gasket	663-44315-A0-00	1
18-0294	Wear Plate to Pump Base Gasket	663-44324-A0-00	1
18-4698	Drain or Fill Washer Gasket	YSG-14090-90-8G	2
18-0296	Oil Seal	93101-22067-00	2
18-0297	Oil Seal	93101-23070-00	2
18-0298	O-Ring	93210-41042-00	1
18-0299	O-Ring	93210-66M98-00	1
18-0293	Pump Base to Gearcase Gasket	663-44316-A0-00	1

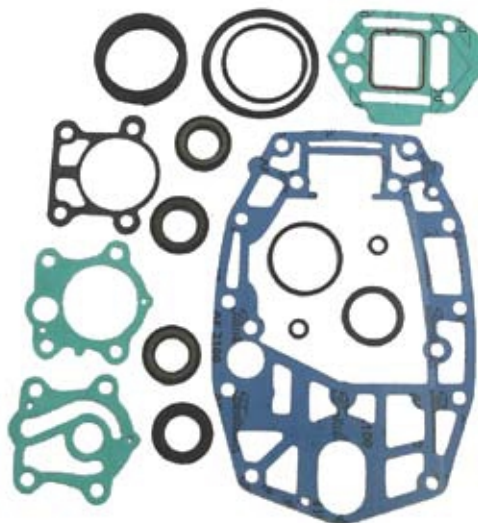

APPLICATION BEGINS ON PAGE 442

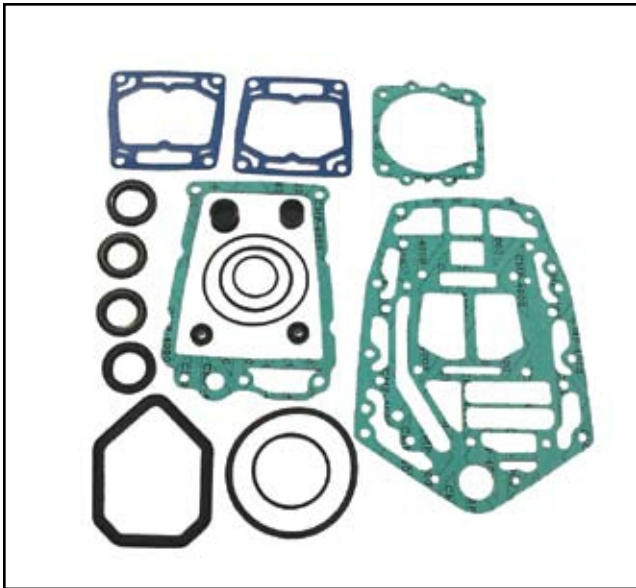

18-2794-1
LOWER UNIT SEAL KIT
Replaces: 6F3-W0001-21-00, 6F3-W0001-C1-00
6E5-W0001-51-00, 6E5-W0001-F1-00
6G5-W0001-21-00, 6G5-W0001-C1-00
— CONTAINS —

Part #	Desc.	O.E. #	Qty.
18-0244	Water Pump Gasket	6E5-44315-A0-00	1
18-4698	Drain or Fill Washer Gasket	YSG-14090-90-8G	2
18-0265	Oil Seal	93101-28M16-00	2
18-0266	Oil Seal	93101-30M17-00	2
18-0267	Oil Seal	93106-09014-00	1
18-7483	O-Ring	93210-37M67-00	1
18-7485	O-Ring	93210-86M38-00	1
18-0275	O-Ring	93210-97M55-00	1

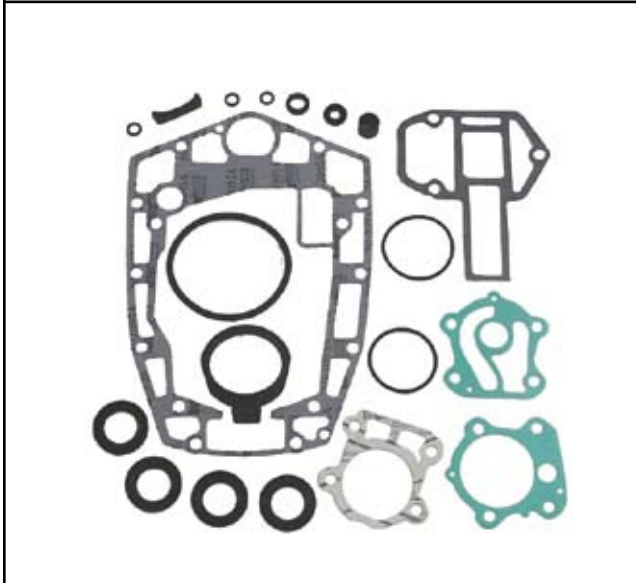

18-2798
LOWER UNIT SEAL KIT
Replaces: 688-W0001-20-00, 688-W0001-C0-00
— CONTAINS —

Part #	Desc.	O.E. #	Qty.
18-0240	Wear Plate to Gear Case Mounting Gasket	688-44316-A0-00	1
18-4698	Drain or Fill Washer Gasket	YSG-14040-90-8G	3
18-7436	O-Ring	93210-46044-00	1
18-0239	Wear Plate to Pump Housing Gasket	688-44315-A0-00	1
18-0267	Oil Seal	93106-09014-00	1

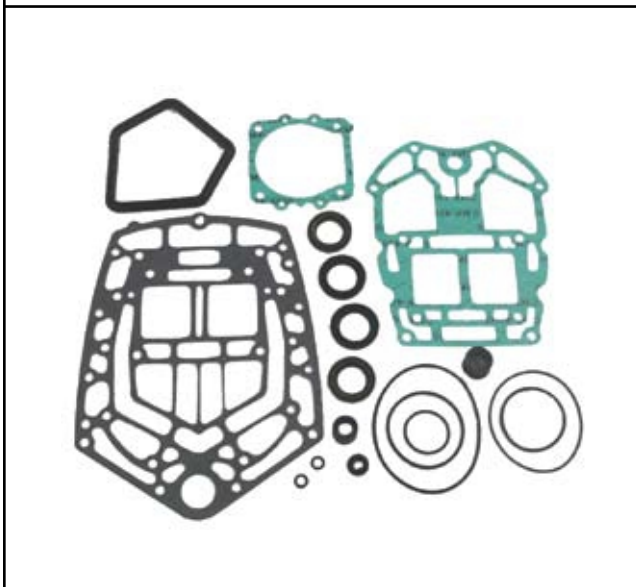

18-2799
LOWER UNIT SEAL KIT
Replaces: 61A-W0001-21-00, 61A-W0001-C1-00
— CONTAINS —

Part #	Desc.	O.E. #	Qty.
18-0244	Water Pump Gasket	6E5-44315-A0-00	1
18-4698	Drain or Fill Washer Gasket	YSG-14040-90-8G	2
18-0265	Oil Seal	93101-28M16-00	2
18-0266	Oil Seal	93101-30M17-00	1
18-0267	Oil Seal	93106-09014-00	1
18-7483	O-Ring	93210-37M67-00	1
18-7485	O-Ring	93210-86M38-00	1
18-7444	O-Ring	93210-04384-00	1

APPLICATION BEGINS ON NEXT PAGE

GEAR HOUSING SEAL KIT APPLICATION

Model #	Year	Lower Unit Gasket Kit	Model #	Year	Lower Unit Gasket Kit	Model #	Year	Lower Unit Gasket Kit
2	1986-88	18-0026	C55	1992-95	18-0024	P150	1986-99	18-2794-1
2	1989-02	18-0027	CV55	1989	18-2787	Pro V 150	1986-90	18-2794-1
4	1984-99	18-0028	P60	1991	18-2788	S150	1996-99	18-2794-1
F4	1999-06	18-0028	70	1984-91	18-2788	SX150	1999-04	18-2794-1
5	1984-02	18-0028	C75	1994-99	18-0021	V150	2000-06	18-2794-1
6	1988-96	18-0029	E75	1995-00	18-0021	VX150	2000-04	18-2794-1
6	1997-99	18-0031	P75	1996-99	18-0021	VZ150	2000-06	18-2794-1
8	1984-96	18-0029	S75	1996	18-2794-1	Z150	2000-06	18-2794-1
8	1997-06	18-0031	C80	1997	18-0021	175	1985-00	18-2794-1
T8	2001-06	18-0025	C85	1991	18-2798	P175	1994-99	18-2794-1
20	1996-97	18-0030	C85	1992-96	18-0021	S175	1996-99	18-2794-1
25	① 1984-85	18-2785	CV85	1985-90	18-2798	V175	2000	18-2794-1
25	① 1986-87	18-0023	90	1984-91	18-2798	VZ175	2001-06	18-2794-1
25	① 1988-06	18-0030	90	1992-06	18-0021	Z175	2001-06	18-2794-1
25	② 1997-02	18-2789	B90	1998-99	18-0021	200	1984-98	18-2794-1
C25	1991	18-0023	C90	1997-01	18-0021	P200	1991-99	18-2794-1
C25	① 1993-97	18-0022	115	1986-06	18-2794-1	S200	1996-99	18-2794-1
CV25	1990	18-0023	C115	1991-00	18-2794-1	SX200	1999-05	18-2794-1
T25	① 2002	18-0020	P115	1993-96	18-2794-1	L200	1986-99	18-2794-1
30	1984-85	18-2785	S115	1996-99	18-2794-1	LX200	2000-06	18-2794-1
30	1986	18-0023	130 (6N7)			LZ200	2000-06	18-2794-1
30	1987-02	18-2789	(6L1)	1988-04	18-2794-1	VZ200	2001-04	18-2794-1
C30	1991	18-0023	L130 (6N4)			V6 Special	1985-86	18-2794-1
C30	1992	18-0022	(6L6)	1989-01	18-2794-1	V6 Excel	1987-89	18-2794-1
F30	② 2002	18-0020	S130	1996-99	18-2794-1	225	③ 1990-93, 97	18-2794-1
CV30	1989-90	18-0023	150 (6R2)			225	④ 1994-96	18-2799
40	1984-94	18-2792	(6G4)	1985-05	18-2794-1	L225	④ 1994-96	18-2799
F40	② 2002	18-0020	C150	1996-99	18-2794-1	S225	1996	18-2799
E48	1995-00	18-0024	L150 (6R0)			250	1990-96	18-2799
50	1986-94	18-2792	(6K0)	1986-99	18-2794-1	L250	1990-96	18-2799
P50	1987-94	18-2792	LX150	1999-01	18-2794-1	S250	1996	18-2799
C55	1991	18-2787	LZ150	2000-06	18-2794-1			

① 2 cylinder model ② 3 cylinder model ③ 2.6 liter engine ④ 3.1 liter engine

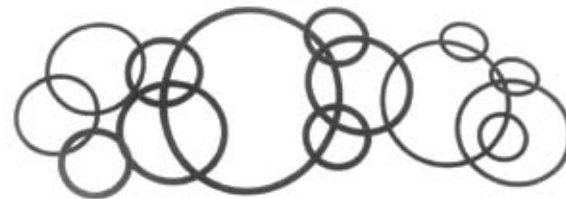

OIL SEALS

Part #	O.E. #	I.D.	Dimensions	
			O.D. (mm)	Width
18-0265	93101-28M16-00	27	43.25	7
18-0266	93101-30M17-00	28.5	45.25	7
18-0267	93106-09014-00	8.75	19.2	5.25
18-0296	93101-22067-00	23	36.25	6
18-0297	93101-23070-00	22.75	37.25	6
18-0554	93101-20M07-00	21.5	34	6.25
18-0570	93102-23096-00	22.75	38.25	7
18-0587	93101-25M03-00	24	40.25	6
18-0588	93102-25M28-00	24.5	48.4	8
18-2079	93101-22M15-00	21.75	35.2	6
18-2085	93102-35M13-00	34	52.25	8
18-2087	93102-40M36-00	39.5	58.25	8.5
18-2088	93102-40M38-00	38.75	52.25	6
18-2091	93104-22M07-00	22	29.25	5

O-RINGS

Part #	Std. Pkg.	O.E. #	Part #	Std. Pkg.	O.E. #
18-0275	1	93210-97M55-00	18-7436	1	93210-46044-00
18-0298	1	93210-41042-00	18-7442	1	93210-74M35-00
18-0299	1	93210-66M98-00	18-7443	1	93210-81MA6-00
18-7119	1	93210-33M85-00	18-7444	1	93211-04384-00
18-7431	5	93210-22M02-00	18-7463	1	93210-19123-00
18-7432	⑤ 2	93210-32738-00	18-7483	1	93210-37M67-00
18-7435	5	93210-42159-00	18-7485	1	93210-86M38-00

⑤ This product is priced per piece. To order priced per package, please add -9 to the part number.