

# IEC/EN 60204-1

## Appliance of reference designations on machinery in accordance with ISO/IEC/EN 81346

September 2010

EU Directive 2006/42/EC on machinery

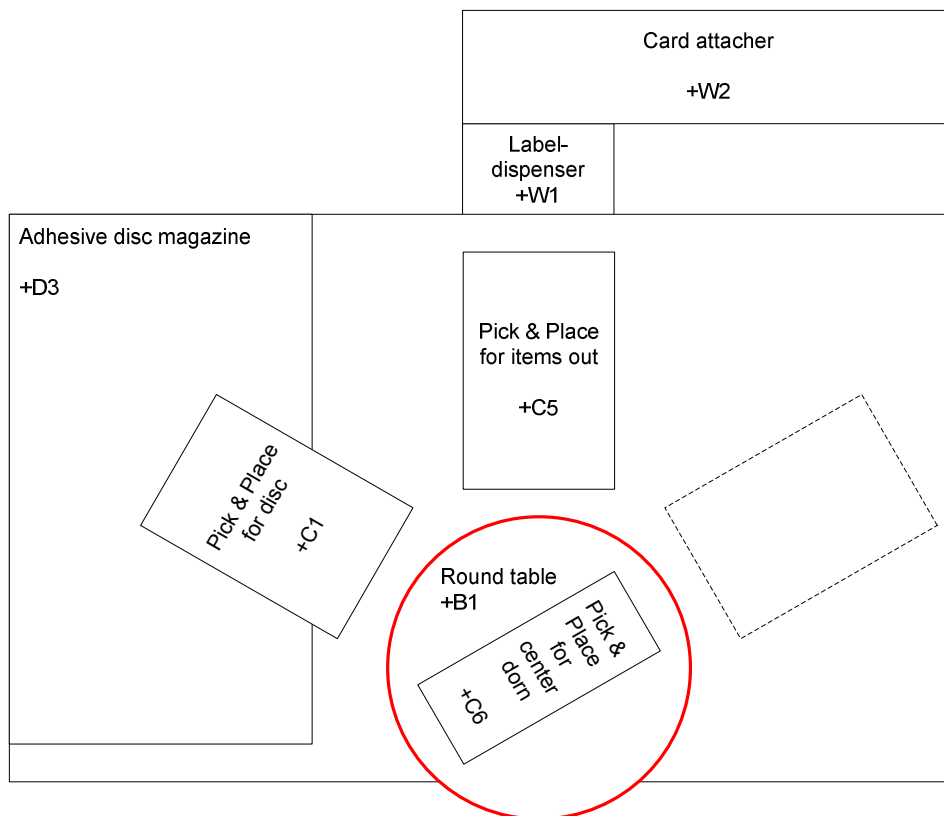



# Table of content

<b>1</b>	<b>Introduction</b>	<b>1-1</b>
1.1	General.....	1-1
1.2	IEC 60204-1 versus EN 60204-1 .....	1-1
<b>2</b>	<b>Review of EN 60204-1</b>	<b>2-3</b>
2.1	Introduction.....	2-3
2.2	[1] - Introduction.....	2-5
2.3	[2] - Normative references.....	2-5
2.4	[3] - Definitions.....	2-6
2.5	[5.1] – Incoming supply conductor.....	2-7
2.6	[11.2] – Placing and assembling .....	2-8
2.7	[13] – Execution of wiring.....	2-8
2.8	[17] – Technical documentation .....	2-8
2.9	[Annex B item 12] – Identification.....	2-12
<b>3</b>	<b>Practical examples</b>	<b>3-1</b>
3.1	Placing of identifier .....	3-1
3.2	Arrangement drawing.....	3-2
3.3	Simplification rules .....	3-4
3.4	Handling of different numbering systems .....	3-5
<b>4</b>	<b>Index</b>	<b>4-1</b>



# 1 Introduction

---

## 1.1 General

### **Synopsis: The relation between the EU Machinery Directive and ISO/IEC 81346**

This document describes identification and marking of components in the form of reference designations prepared in accordance with ISO/IEC/EN 81346, viewed in relation to the requirements in EN 60204-1:2006 '*Safety of machinery – Electrical equipment of machines. Part 1: General requirements*'.

In this document references to *EN 60204-1* are in italics. Other references are written in normal font.

- This document is free of charge. It has the main purpose to explain the requirements of marking equipment on machinery in accordance with the European Machinery Directive no. 2006/42/EC. The technique and requirements for establishing identifiers (e.g. TAG's) shall be in accordance with ISO/IEC 81346 standard series: "Industrial systems, installations and equipment and industrial products – Structuring principles and reference designations".
- The DS-Handbook no. 166 from Danish Standard Association (available from Danish Standard Webshop September 2010) is the easy-to-read guideline og how to apply the ISO/IEC/EN 81346 standard. Please refer to [www.81346.com](http://www.81346.com) for more information and purchase.

#### Disclaimer

The usage and appliance of this document is at your own risk as the author cannot be held responsible for any damage whatsoever due to mismatch or misunderstanding in relation to the content of this document.

---

## 1.2 IEC 60204-1 versus EN 60204-1

### **Synopsis: Short introduction to the difference between IEC and EN 60204-1.**

Normally the IEC/ISO edition of a standard is no different from the following harmonized European edition (EN) of the same standard.

For machinery to be installed in Europe, the EU directive 2006/42/EC on machinery applies. European norm EN 60204-1 applies to the electrical equipment of the machine. However, as

indicated in the *Foreword* to EN 60204-1 there are minor variations between IEC 60204-1 and EN 60204-1. In the EN edition a right border indicates a deviation from the IEC edition.

A review of the IEC versus the EN standard shows that there is no difference between the items relevant for documentation, marking and identification. Consequently, this document applies to IEC 60204-1 as well as EN 60204-1 in relation to documentation, marking and identification.

Please note the vertical mark in the margin, when EN 60204-1 is used:



# 2 Review of EN 60204-1

---

## 2.1 Introduction

**Synopsis: About electrical equipment, documentation and marking on machinery.**

EN 60204-1 deals with electrical equipment on machines. The edition in force is from 2006, and typically it has a local designation from the member country in the European Union, e.g. 'DS/EN 60204-1' (Denmark), 'DIN/EN 60204-1' (Germany) etc.

The standard is used for design of the electrical equipment of machines, and is the standard typically used when the European Machinery Directive 2006/42/EC shall be fulfilled in terms of safety for the electrical circuits.

Reference designation systems according to ISO/IEC 81346-1 are relevant especially in relation to documentation and identification and safety aspects derived from this. In brief, the assumption is that when the identification of the components (called 'reference designations' according to 81346-1) complies with the technical documentation, handling of the machine becomes safer. This seems evident on paper, in practice, however, it is far from correct on all machines.

For most manufacturers of machines, the challenge is that the machines become more and more complex, and consequently also the electrical and mechanical equipment becomes more complex and extensive. For most people it is natural to continue to develop the way of preparing the documentation, but sooner or later most of us will find that something is wrong: More errors occur, new employees have problems with the documentation form, so do the buyers of the machines, and the outcome is a major time consumption or even a machine that must be described as dangerous.

The solution is to introduce a reference designation system according to ISO/IEC 81346-1 describing how to create a structured overview of the installation or machine. The technique from 81346 provides an excellent overview of the composition of the machine, and in the end a safer machine. The use of a reference designation system provides many other advantages, e.g. the possible reuse of documentation during design and consequent reduce design costs.

Naturally, it may seem impossible to structure data (it is easier to do as usual), and often it requires the support of the management before implementation. However, this is a long-term investment in overview and reuse, and experience from companies working with the subject shows that the technique in ISO/IEC 81346-1 is outstanding and capable of handling even very large amounts of complex information.

EN 60204-1 is known as a B-standard, so it makes no sense for a manufacturer to indicate that he 'complies with the standard'. EN 60204-1 indicates various options to be stated, and this is done e.g. by using *Annex B* including in total 13 items.

The standard ISO/IEC 81346-1 (2009) is a combination of ISO TS 16952-1 (2005) and IEC 61346 (1996). The new common standards are a major progress in common understanding of the design of identifiers (ID-codes) for the electrical and mechanical systems - also on machines.

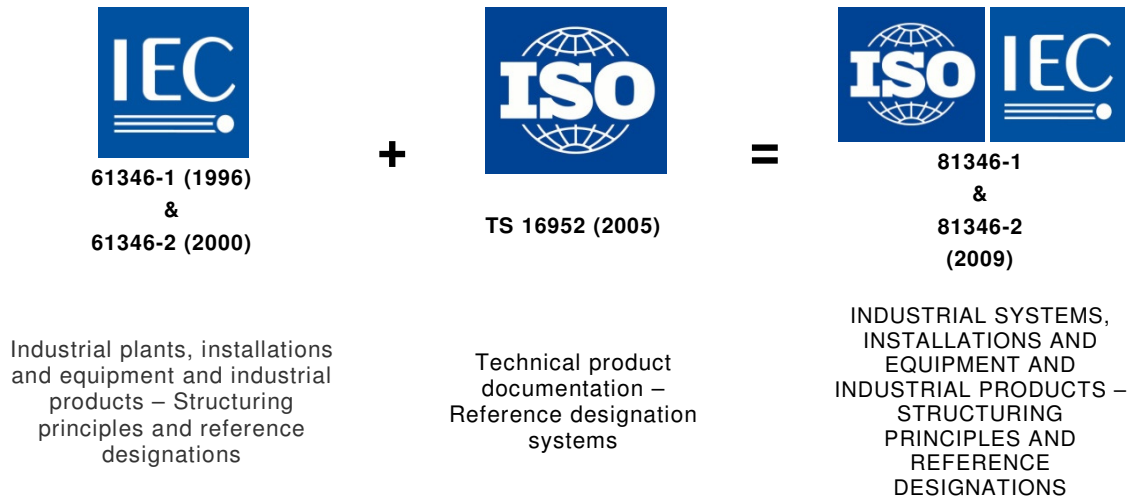

Figure 1- Basis for the common publication ISO/IEC 81346.



---

## 2.2 [1] - Introduction

**Synopsis:** Reference designations and documentation are part of the machine.

[Figure 1] – block diagram of a typical machine illustrates a fine overview of most aspects of a machine.

Reference designations (16) and Technical documentation (17) appear at the top of Figure 1, and indicate that both are essential parts of a machine.

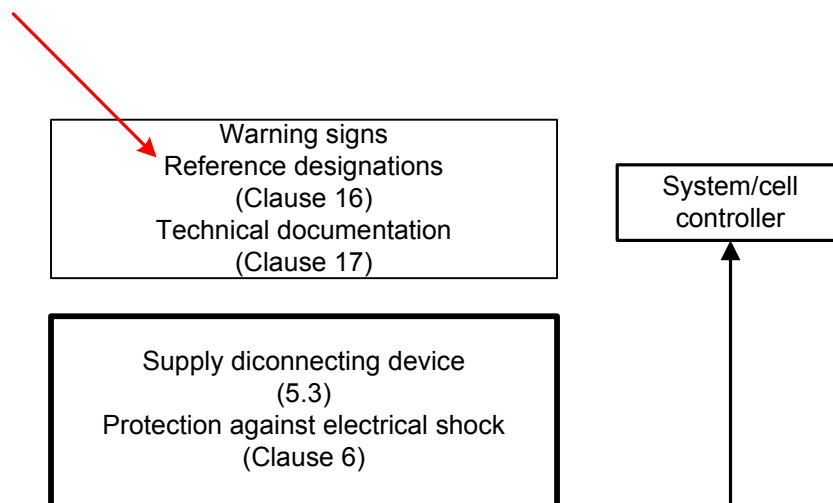

Figure 2 – Extract from IEC/EN 60204-1 figure 1, block diagram of a typical machine.

---

## 2.3 [2] - Normative references

**Synopsis:** ISO/IEC 81346 is indicated as a normative reference in 60204-1

In general, normative references are indicated in the beginning of international standards. A normative reference means that the standard indicated as a normative reference is used in the actual standard. IEC 60204-1 indicates IEC 61346 (now IEC 81346) as a normative reference to IEC 60204-1.

---

## 2.4 [3] - Definitions

### Synopsis: Definitions from 60204-1

As an important element in most standards, *chapter [3]* includes a list of definitions. You are recommended to read these thoroughly, because they are an important element in the correct understanding of the rest of the text.

If no definition of a word is indicated in a standard, it is common practice to find and use the definition in the English 'Oxford English Dictionary' instead.

The most important definitions relevant to this report are:

*[3.35] Machinery / machine – assembly of linked parts or components, at least one of which moves, with the appropriate machine actuators, control and power circuits, joined together for a specific application, in particular for the processing, treatment, moving or packing of a material.*

*The term 'machinery' also covers an assembly of machines which, in order to achieve the same end, are arranged and controlled so that they function as an integral whole.*

*[3.36] Identification – signs or inscriptions primarily for the purpose of identifying equipment, components and/or devices, which can include certain features thereof.*

*[3.47] Reference designation – distinctive code which serves to identify an object in the documentation and on the equipment.*

As will appear from [3.47] the code on the equipment and in the documentation shall be identical to create the link between the components of the machinery and the related technical documentation.

## 2.5 [5.1] – Incoming supply conductor

**Synopsis: Terminals (terminations) and terminal blocks shall be correctly identified.**

It is stated that *All terminals for the incoming supply shall be clearly identified in accordance with IEC 60445 and 16.1.*

For information, please see below short extract from IEC/EN 60445. For full reference, please see the complete standard.

Designated conductor	Identification of conductors and conductor terminations	Equipment terminal identification	Graphical symbols IEC 60417
AC conductors Line 1 Line 2 Line 3 Neutral conductor	L1 L2 L3 N	U V W N	-
DC conductors Positive  Negative  Mid-point conductor	L+  L-  M	C or +  D or -	+  -
...			

Figure 3 – Short extract from IEC 60445 table 1.

The terminals will often be a part of a terminal block. The terminal block is identified by a reference designation prepared according to the ISO/IEC 81346 standard series, e.g. '-X1'.

Cf. IEC 61666 the designation of the terminal block differs from the designations of the terminals by a colon ':', so for instance terminal number 34 in -X1 is written as **-X1:34**.

---

## **2.6 [11.2] – Placing and assembling**

**Synopsis: Placing and assembling of controlgear**

[11.2.1] indicates that *All items of controlgear shall be placed and oriented so that they can be identified without moving them or the wiring.* In relation to identification this means in practice that the identifier (the reference designation) shall be placed preferably next to or close to the component identified by the identifier. This way it will not be necessary to produce new identifiers to replace a component (typically in the form of signs). See also section 3.1 - Placing of identifier.

[11.2.1] indicates that *Test points for connection of test equipment, where provided, shall be ... clearly identified to correspond with the documentation (see 17.3).* This means that measuring points shall also be identified in the documentation, typically in the form of special terminals, or in the form of components appropriate for the purpose.

Terminal blocks as well as components shall be labelled according to the ISO/IEC 81346 standard series.

---

## **2.7 [13] – Execution of wiring**

**Synopsis: Identification of wires and conductors**

[13.1.1] *General requirements* states e.g. that *terminals on terminal blocks shall be plainly marked or labelled to correspond with markings on the diagrams.*

IEC 62491 (2008), *Industrial systems, installations and equipment and industrial products - Labelling of conductors and cores*, indicates methods for labelling of conductors and cores. ISO/IEC 81346 is a normative reference to IEC 62491.

---

## **2.8 [17] – Technical documentation**

**Synopsis: About technical documentation**

[17.2] - *Information to be provided* states a list of the minimum requirement for documentation of electrical equipment of machines. Though the list includes only the requirements for the electrical documentation, preparation of corresponding documentation should be considered for other mechanical parts of the system forming part of the functionality of the machine.

The main issue is that all components can be retrieved in the documentation, and that the identification (i.e. the reference designation) in the documentation and on the machine are identical, in order to allow retrieving of the components.

It is common for electro technicians to consider the electrical circuit diagrams the most important document, and thus try to incorporate e.g. a page number as a part of the identifier. However, this is not recommended, partly because there are other documents than circuit diagrams which could rightly be used on this ground, partly because by definition the preparation of a reference designation system is independent of the documentation. The identifiers in the reference designation system are reflected in the documentation rather than the other way round. See Figure 4 on the next page.

*[17.3] Requirements applicable to all documentation states that unless otherwise agreed between manufacturer and user: ... reference designations shall be in accordance with relevant parts of IEC 61346 (now ISO/IEC 81346). For a manufacturer of machines this involves the problem that the manufacturer must supply different codes for different clients, and as a consequence the manufacturer cannot make own modular thinking. For the user there is also a misunderstood modification in 'forcing' a manufacturer to supply codes suiting the user better than the manufacturer.*

The solution for the manufacturer as well as the user lies in the technology of reference designation systems, because the problem can be solved either by use of double codes or by applying a combination of two reference designation systems as described in ISO/IEC 81346.

Read more about double coding and combination of reference designations in ISO/IEC 81346-1 and in the supporting DS-Handbook no. 166 to be found on [www.81346.com](http://www.81346.com) (available in English from September 2010).

Reference designation system (product aspect):

- G1 Pump control
- B1 pt-100
- B2 Roller sensor
- F1 Motor starter
- M1 Motor
- W1 Cable

Reference designation: **-G1-M1**

Properties of motor object

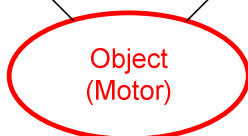
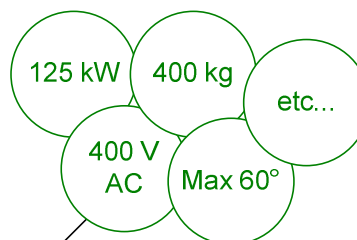

Project documentation

Ordre number BV-785698

Flow diagrams &PFB

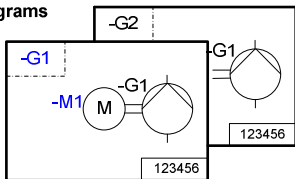

Circuit diagrams &EFS

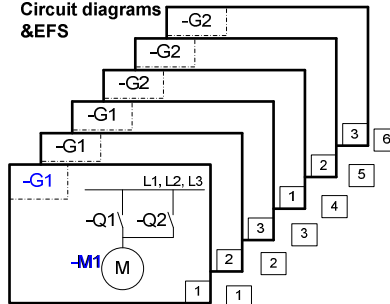

Product lists &MPB

-G1-G1	Fan	
-G1-M1	Motor	
-G2-G1	Fan	234567
etc.		234567

Technical calculations &BED

Power calculation for -G1-M1:  
 $P = \sqrt{3} \cdot U \cdot I \cdot \cos\phi$   
 At 400 V ...  
 ...  
 ...  
 Xx-789-8

Arrangement drawing &ELD

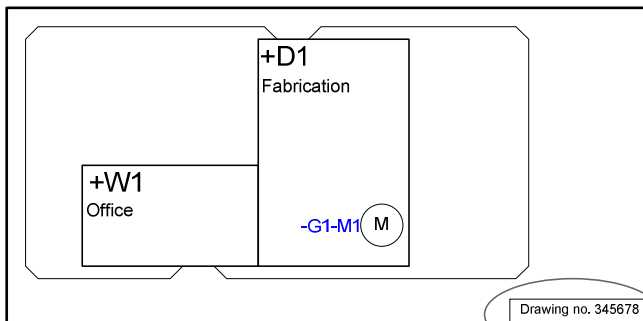

Identification area with title block and meta data (all drawings)

Drawing no. 345678

Copyright © by Henrik Balslev

Figure 4 – Connection between object, reference designation system and technical documentation.

Figure 4 illustrates the connection between an object, reference designation system, property data and examples of the typical project documentation:

In the example shown the object is a motor. The motor has a number of properties that are either imaginary or, as illustrated in the figure, actual properties (125 kW, 400 kg etc.). A reference designation system unambiguously identifying the object has been prepared: The designer has structured the reference designation system so that the motor is a part of a pump control. Because we work in the product aspect the reference designation will be '-G1-M1'. This reference designation is used as identifier for the object 'Motor' everywhere in the technical documentation showing the motor.

The project documentation includes flow diagrams, circuit diagrams, product lists, arrangement drawings, technical calculations etc. The shown classifications '&PFB' etc. comply with IEC 61355.

In the tables and diagrams simplification technology is used in accordance with relevant ISO and IEC standards. The possible common part of a reference designation is placed 'outside parenthesis' – or as shown in the documentation in the top left corner.

Note that the reference designation system is independent of the project documentation. This means that the project documentation is used to document objects and the properties of these. The identification '-G1-M1' protects the unambiguous identification across the documents.

The documentation can with advantage be created on the basis of the modular thinking, which is one of the advantages of a reference designation system. This allows the preparation of basic documents well suited for reuse. The idea is to prepare the project documentation on the basis of these basic documents, possibly with a few adjustments.

All electrical documentation shall be prepared according to IEC 61082:2006. ISO/IEC 81346 is a normative reference to IEC 61082.

---

## **2.9 [Annex B item 12] – Identification**

**Synopsis:** In Annex B the form of identification is agreed

*Annex B* is used as a checklist, e.g. between manufacturer and user of the machine, where a number of practical issues can be decided before manufacture. As mentioned in section 2.8 - [17] – *Technical documentation* the use of different reference designation systems can be agreed.

It is highly recommended to use the ISO/IEC 81346 standard series as a common reference frame for preparation of reference designations.



# 3 Practical examples

## 3.1 Placing of identifier

**Synopsis:** The identifier ('number') should be placed next to the object

In practice, the identifier shall be placed preferably next to the component, so as to keep the identification by replacement:

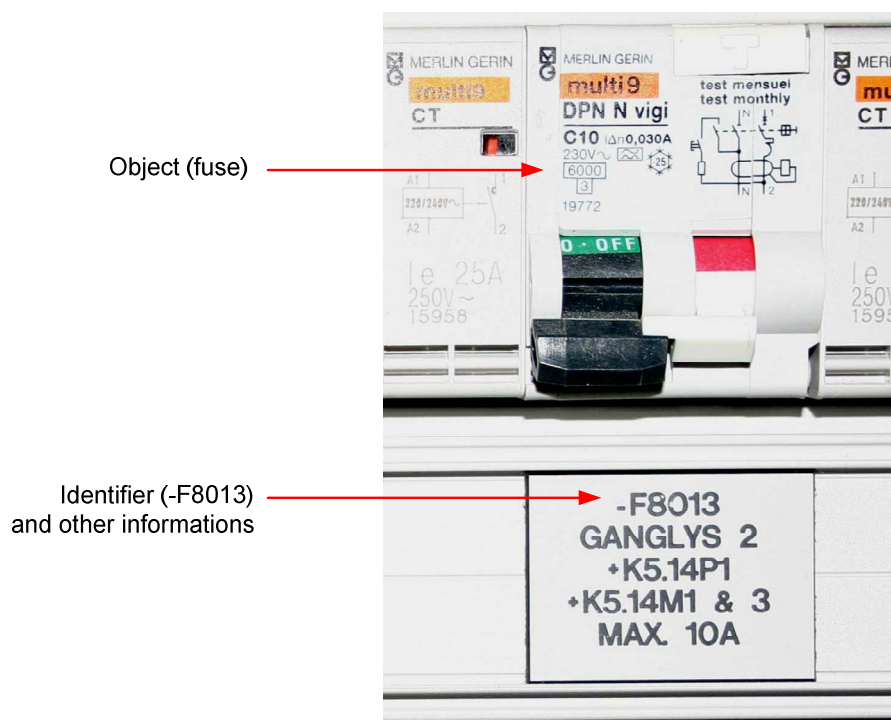

Figure 5: Preferably reference designation should be placed next to the object.

---

## 3.2 Arrangement drawing

**Synopsis:** An arrangement drawing provides the necessary overview.

An arrangement drawing is a drawing providing information of the relative or absolute placing of objects.

Below is an example from IEC 61082-1:2006 (figure 83d) of an arrangement drawing illustrating the placing of various components. The identification of the components is prepared in the product aspect.

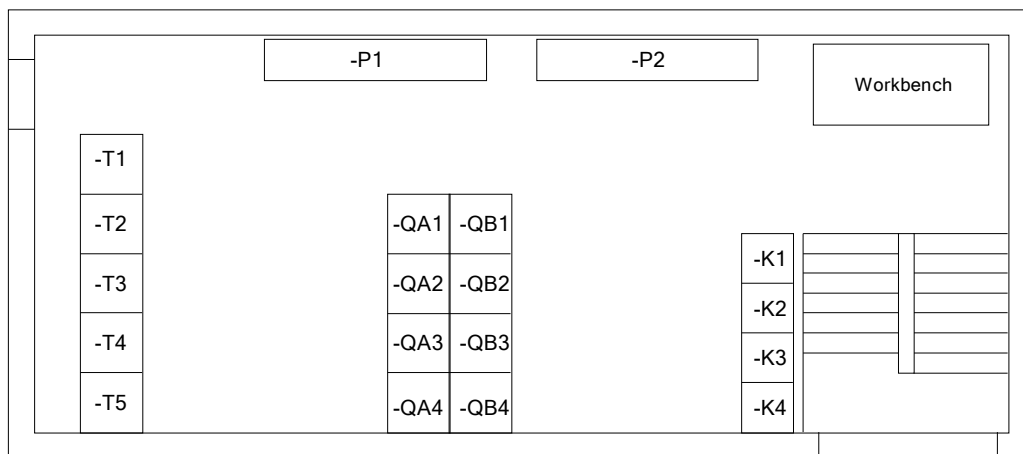

Figure 6 – Arrangement drawing showing controlgear.

The next page shows another example of an arrangement drawing of layout of a machine, where the location aspect is used to divide the machine into well defined areas:

**NOTE:**

- +A** Outside machine
- +B** Roundtable
- +C** Sections on machine
- +D** Discs and couplings
- +U** Front side of machine
- +W** Back side of machine

Other letter codes do not apply.

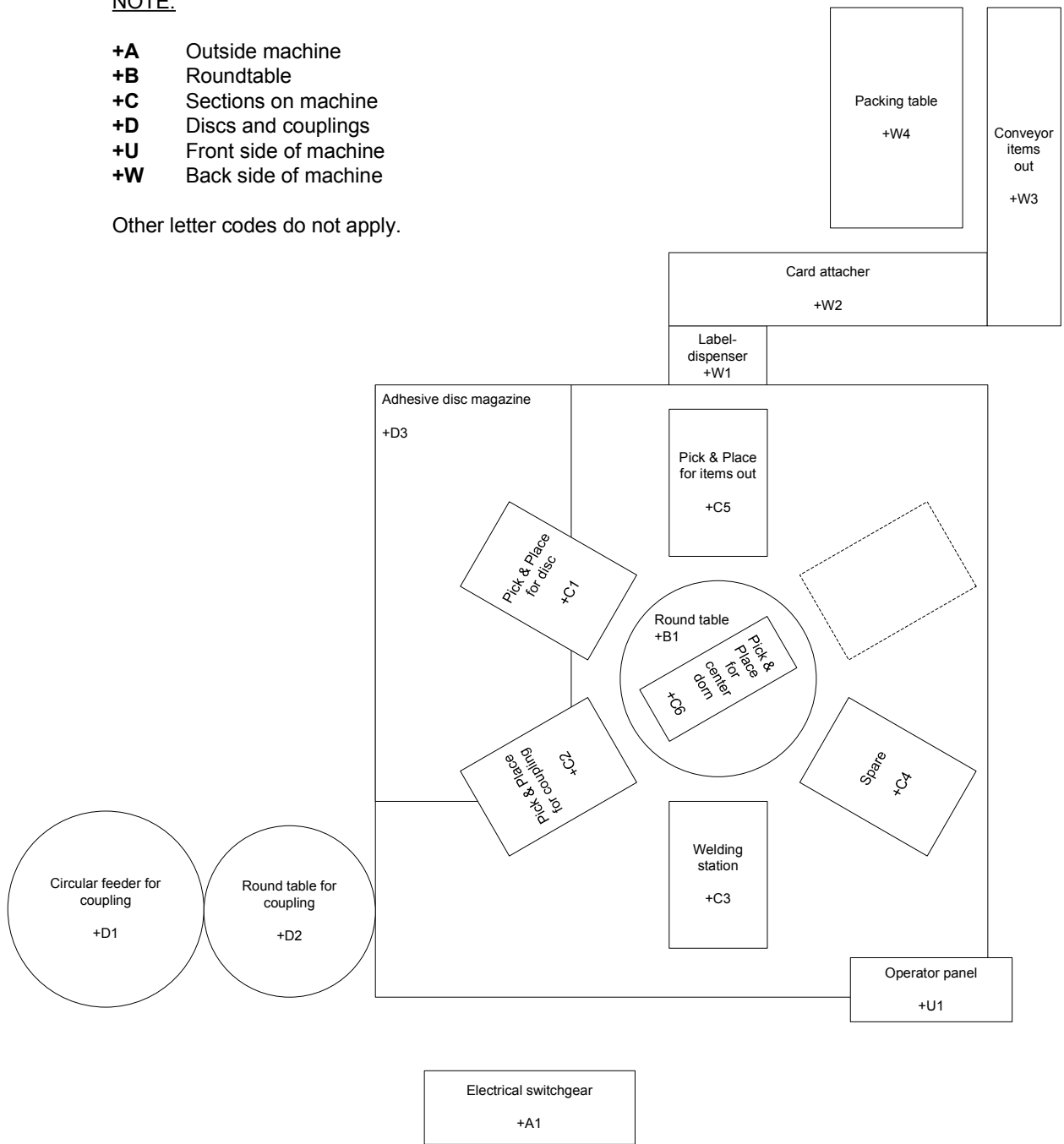

Figure 7 – Example layout of a machine using location aspect.

### 3.3 Simplification rules

**Synopsis:** You can 'place outside a parenthesis'.

IEC 61082 (electrical) and ISO 15519 (mechanical) indicate simplification rules for reference designations, which allow you to place the common part of the reference designation 'outside' - in practice by placing the common part separately:

Figure 8 shows an example of an assembly plate, where all the components on the plate shall be leading with '-A1' to get the full reference. E.g. the full reference for the first fuse (-F1) will be '-A1-F1' and so on.

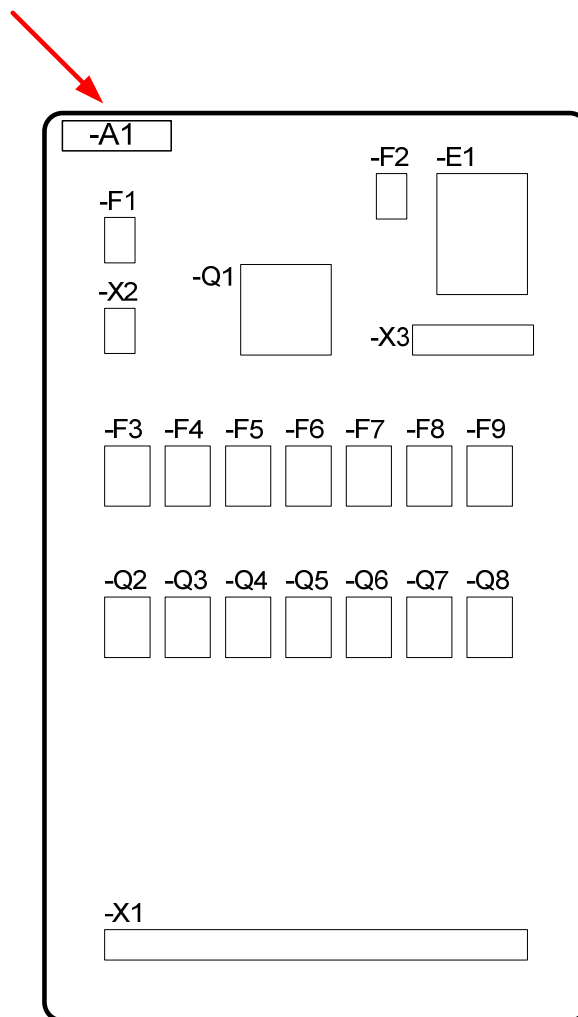

Figure 8 - An arrangement drawing for an assembly plate in a cabinet. The common part is '-A1'.

---

## 3.4 Handling of different numbering systems

**Synopsis:** You may use more than one numbering system for machines.

The technology in a reference designation system in accordance with ISO/IEC 81346-1 allows more than one identifier (number) for identification of an object. It may often be a good idea to use this technique, because it allows the various parties (e.g. manufacturer and customer) to maintain the numbering systems they are used to and at the same time consider the other party.

Figure 9 shows an example of labelling in a case with two possible identifications of the object: '-103.3.5' and 'A1A-A1R'. Naturally you need to see in the relevant technical documentation to understand the context.

NOTE: The example is hypothetical and intended only as an illustration of possible different numbering systems.

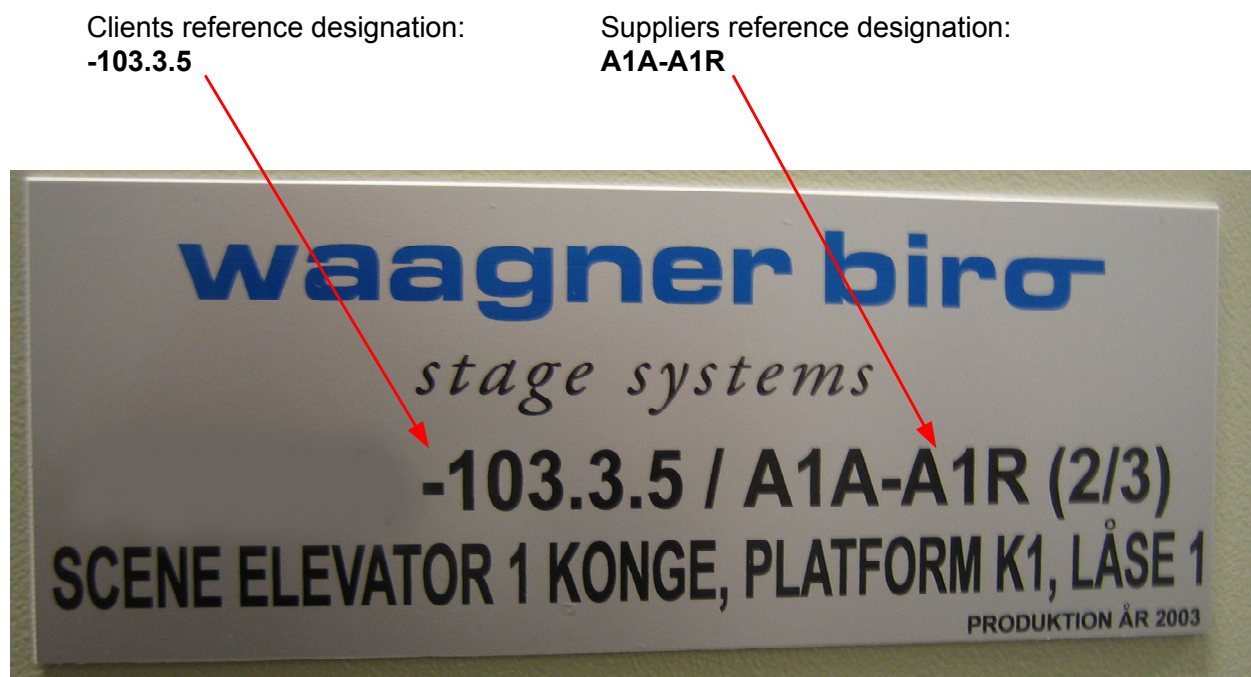

Figure 9 – Example of identification with two numbering systems  
NOTE: Clients reference designation is in accordance with ISO/IEC 81346.



# 4 Index

## A

Arrangement drawing, 3-2

## C

Complex machines, 2-3

## D

Definitions, 2-6

Documentation, 2-3, 2-8

Documentation of objects, 2-11

## E

Electrical systems, 2-4

## I

ID-codes, 2-4

Identification, 2-3, 2-6, 2-8, 2-12

Identification of terminals, 2-7

Identification of wires, 2-8

Investment, 2-3

## L

Layout of machine, 3-3

## M

Machinery, 2-6

Machinery Directive, 2-3

Mechanical systems, 2-4

## N

Normative reference, 2-5

Numbering systems, 3-5

## O

Overview, 2-5

## P

Placing of identifier, 3-1

## R

Reading instructions, 1-1

Reference designation, 2-6

Reference designation system, 2-3

## S

Safety, 2-3

Simplification rules, 3-4

## T

Terminal block, 2-7, 2-8

**NEW** handbook available from September 2010 – see [www.81346.com](http://www.81346.com) for more:

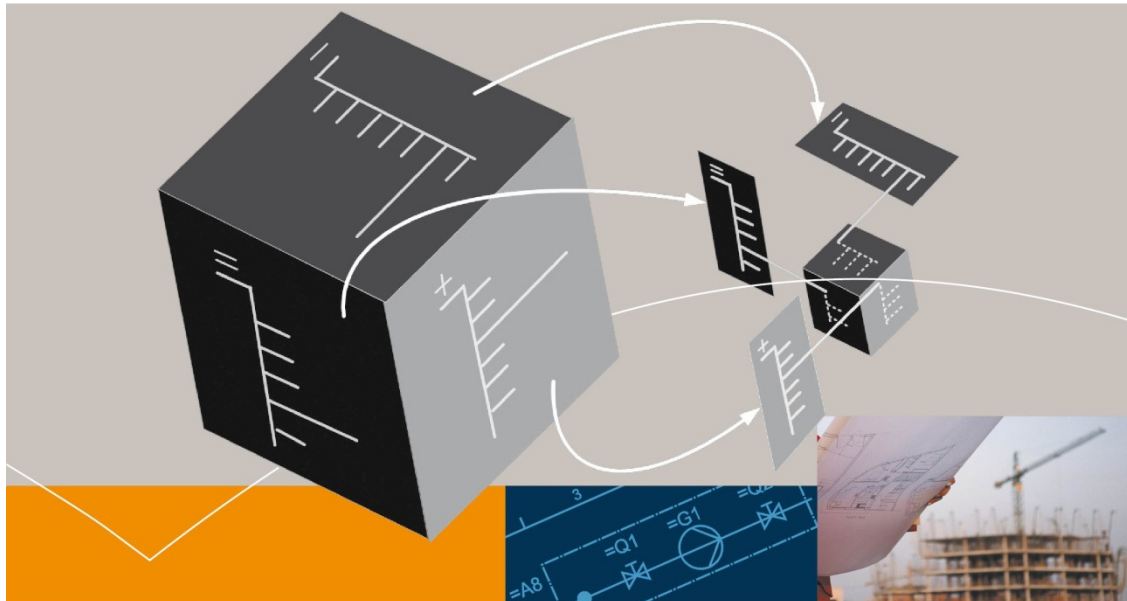

DS HANDBOOK 166:2010

1<sup>ST</sup> EDITION



## **A Guide to Reference Designations**

Preparation of TAG Numbers,  
Letter Codes, Modularization and  
Interfaces between Objects