

# Welding — Recommendations for welding of metallic materials —

## Part 2: Arc welding of ferritic steels

The European Standard EN 1011-2:2001, with the incorporation of amendment A1:2003 has the status of a British Standard

ICS 25.160.10

## National foreword

This British Standard is the official English language version of EN 1011-2:2001 including amendment A1:2003. Together with BS EN 1011-1:1998 it supersedes BS 5135:1984 which is withdrawn.

It is important to that the BS EN 1011 series of standards uses the concept of heat input to the weld where as BS 5135 used arc energy. These two terms are not interchangeable and care should be taken when transposing data from BS 5135 to the BS EN 1011 standards.

Attention is also drawn to the fact that annex C of this standard details two methods for predicting preheat temperatures to avoid hydrogen cracking. The differences in origin and experience used to develop these two methods are detailed in C.1 and this can be used as a guide to their application.

Traditionally in the UK the method detailed in BS 5135 has been used in conjunction with weld procedure approval in accordance with the BS EN 288 series. The method detailed in C.2 is that given in BS 5135, in an updated form.

The UK participation in its preparation was entrusted to Technical Committee WEE/17, Metal-arc welding of steel, which has the responsibility to

- aid enquirers to understand the text;
- present to the responsible European committee any enquiries on the interpretation, or proposals for change, and keep the UK interests informed;
- monitor related international and European developments and promulgate them in the UK.

A list of organizations represented on this committee can be obtained on request to its secretary.

### Cross-references

The British Standards which implement international or European publications referred to in this document may be found in the *BSI Catalogue* under the section entitled "International Standards Correspondence Index", or by using the "Search" facility of the *BSI Electronic Catalogue* or of British Standards Online.

This publication does not purport to include all the necessary provisions of a contract. Users are responsible for its correct application.

**Compliance with a British Standard does not of itself confer immunity from legal obligations.**

### Summary of pages

This document comprises a front cover, an inside front cover, the EN title page, pages 2 to 58, an inside back cover and a back cover.

The BSI copyright date displayed in this document indicates when the document was last issued.

### Amendments issued since publication

Amd. No.	Date	Comments
14926	12 February 2004	Deletion of Annex ZA

This British Standard, having been prepared under the direction of the Engineering Sector Committee, was published under the authority of the Standards Committee and comes into effect on 15 March 2001

© BSI 12 February 2004

ICS 25.160.10

English version

**Welding — Recommendations for welding of metallic  
materials — Part 2: Arc welding of ferritic steels**  
(includes amendment A1:2003)

Soudage — Recommandations pour le soudage des  
matériaux métalliques — Partie 2: Soudage à l'arc des  
aciers ferritiques  
(inclut l'amendement A1:2003)

Schweißen — Empfehlungen zum Schweißen metallischer  
Werkstoffe — Teil 2: Lichtbogenschweißen von ferritischen  
Stählen  
(enthält Änderung A1:2003)

This European Standard was approved by CEN on 6 July 2000 and amendment A1 was approved by CEN on 20 November 2003..

CEN members are bound to comply with the CEN/CENELEC Internal Regulations which stipulate the conditions for giving this European Standard the status of a national standard without any alteration. Up-to-date lists and bibliographical references concerning such national standards may be obtained on application to the Management Centre or to any CEN member.

This European Standard exists in three official versions (English, French, German). A version in any other language made by translation under the responsibility of a CEN member into its own language and notified to the Management Centre has the same status as the official versions.

CEN members are the national standards bodies of Austria, Belgium, Czech Republic, Denmark, Finland, France, Germany, Greece, Hungary, Iceland, Ireland, Italy, Luxembourg, Malta, Netherlands, Norway, Portugal, Slovakia, Sweden, Switzerland and United Kingdom.



EUROPEAN COMMITTEE FOR STANDARDIZATION  
COMITÉ EUROPÉEN DE NORMALISATION  
EUROPÄISCHES KOMITEE FÜR NORMUNG

**Management Centre: rue de Stassart, 36 B-1050 Brussels**

## Contents

### Page

Foreword .....	3
Introduction .....	4
1 Scope .....	4
2 Normative references .....	4
3 Terms and definitions .....	4
4 Symbols and abbreviations .....	5
5 Parent metal .....	6
6 Weldability factors .....	6
7 Handling of welding consumables .....	6
8 Weld details .....	6
9 Welds in holes or slots .....	7
10 Preparation of joint face .....	7
11 Alignment of butt welds before welding .....	8
12 Preheating .....	8
13 Tack welds .....	8
14 Temporary attachments .....	8
15 Heat input .....	9
16 Welding procedure specification .....	9
17 Identification .....	9
18 Inspection and testing .....	9
19 Correction of non-conforming welds .....	9
20 Correction of distortion .....	10
21 Post weld heat treatment .....	10
<b>Annex A (informative) Possible detrimental phenomena resulting from welding of steels, not covered by other annexes .....</b>	<b>11</b>
<b>Annex B (informative) Guidance on joint detail design (when there is no application standard) .....</b>	<b>12</b>
<b>Annex C (informative) Avoidance of hydrogen cracking (also known as cold cracking) .....</b>	<b>15</b>
<b>Annex D (informative) Heat affected zone toughness and hardness .....</b>	<b>42</b>
<b>Annex E (informative) Avoidance of solidification cracking .....</b>	<b>49</b>
<b>Annex F (informative) Avoidance of lamellar tearing .....</b>	<b>51</b>
<b>Annex G (informative) References in the annexes .....</b>	<b>57</b>
<b>Bibliography .....</b>	<b>58</b>

## Foreword

This European Standard has been prepared by Technical Committee CEN/TC 121, Welding, the Secretariat of which is held by DS.

This European Standard shall be given the status of a national standard, either by publication of an identical text or by endorsement, at the latest by July 2001, and conflicting national standards shall be withdrawn at the latest by July 2001.

This document has been prepared under a mandate given to CEN by the European Commission and the European Free Trade Association.

For relationship with EU Directive(s), see informative annex ZA, which is an integral part of this standard.

According to the CEN/CENELEC Internal Regulations, the national standards organizations of the following countries are bound to implement this European Standard: Austria, Belgium, Czech Republic, Denmark, Finland, France, Germany, Greece, Iceland, Ireland, Italy, Luxembourg, Netherlands, Norway, Portugal, Spain, Sweden, Switzerland and the United Kingdom.

## Foreword to amendment A1

This document EN 1011-2:2001/A1:2003 has been prepared by Technical Committee CEN/TC 121 Welding, the secretariat of which is held by DS.

This Amendment to the European Standard EN 1011-2:2001 shall be given the status of a national standard, either by publication of an identical text or by endorsement, at the latest by June 2004, and conflicting national standards shall be withdrawn at the latest by June 2004.

This document has been prepared under a mandate given to CEN by the European Commission and the European Free Trade Association.

According to the CEN/CENELEC Internal Regulations, the national standards organizations of the following countries are bound to implement this European Standard: Austria, Belgium, Czech Republic, Denmark, Finland, France, Germany, Greece, Hungary, Iceland, Ireland, Italy, Luxembourg, Malta, Netherlands, Norway, Portugal, Slovakia, Spain, Sweden, Switzerland and the United Kingdom.

## Introduction

This European Standard supplements EN 1011-1. It is issued with several annexes in order that it can be extended to cover the different types of steel which are produced to all the European steel standards for ferritic steels (see clause 5).

This standard gives general guidance for the satisfactory production and control of welds in ferritic steels. Details concerning the possible detrimental phenomena which can occur are given with advice on methods by which they can be avoided. This standard is generally applicable to all ferritic steels and is appropriate regardless of the type of fabrication involved, although the application standard can have additional requirements.

## 1 Scope

This European Standard gives guidance for manual, semi-mechanized, mechanized and automatic arc welding of ferritic steels (see clause 5), excluding ferritic stainless steels, in all product forms.

## 2 Normative references

This European Standard incorporates by dated or undated reference, provisions from other publications. These normative references are cited at the appropriate places in the text and the publications are listed hereafter. For dated references, subsequent amendments to or revisions of any of these publications apply to this European Standard only when incorporated in it by amendment or revision. For undated references the latest edition of the publication referred to applies (including amendments).

EN 288-2:1997, *Specification and approval of welding procedures for metallic materials — Part 2: Welding procedure specification for arc welding*.

EN 1011-1:1998, *Welding — Recommendations for welding of metallic materials — Part 1: General guidance for arc welding*.

EN 29692, *Metal-arc welding with covered electrode, gas-shielded metal-arc — Welding and gas welding — Joint preparations for steel (ISO 9692:1992)*.

EN ISO 13916, *Welding — Guidance for the measurement of preheating temperature, interpass temperature and preheat maintenance temperature (ISO 13916:1996)*.

CR ISO 15608, *Welding — Guidelines for a metallic material grouping system (ISO/TR 15608:2000)*.

## 3 Terms and definitions

For the purposes of this European Standard, the terms and definitions listed in EN 1011-1:1998 and the following apply.

### 3.1

#### **cooling time $t_{8/5}$**

time taken, during cooling, for a weld run and its heat affected zone to pass through the temperature range from 800 °C to 500 °C

### 3.2

#### **run out length**

length of a run produced by the melting of a covered electrode

### 3.3

#### **run out ratio $R_r$**

ratio of the run out length to the length of electrode consumed

### 3.4

#### shape factor $F_x$

describes the influence of the form of a weld on the cooling time  $t_{8/5}$ . In the case of two-dimensional heat flow it is called  $F_2$  and in the case of three-dimensional heat flow it is called  $F_3$

### 3.5

#### three-dimensional heat flow

heat introduced during welding which flows parallel and perpendicular to the plate surface

### 3.6

#### transition thickness $d_t$

plate thickness at which the transition from three-dimensional to two-dimensional heat flow takes place

### 3.7

#### two-dimensional heat flow

heat introduced during welding which flows only parallel to the plate surface

### 3.8

#### preheat maintenance temperature $T_m$

minimum temperature in the weld zone which should be maintained if welding is interrupted

## 4 Symbols and abbreviations

Table 1 — Symbols and abbreviation

Symbols/Abbreviations	Terms	Units
$CE$	Carbon equivalent (see C.2.1)	%
$CET$	Carbon equivalent (see C.3.2)	%
$D$	Diameter	mm
$d$	Thickness of plate	mm
$d_t$	Transition thickness	mm
$F_2$	Shape factor for two-dimensional heat flow	—
$F_3$	Shape factor for three-dimensional heat flow	—
$HAZ$	Heat affected zone	—
$HD$	Diffusible hydrogen content	ml/100g deposited weld metal
$Q$	Heat input	kJ/mm
$R_r$	Run out ratio	—
$t_{8/5}$	Cooling time (from 800 °C to 500 °C)	s
$t$	Melting time of an electrode	s
$T_i$	Interpass temperature	°C
$T_m$	Preheat maintenance temperature	°C
$T_o$	Initial plate temperature	°C
$T_p$	Preheat temperature	°C
$T_t$	Impact transition temperature	°C
$UCS$	Unit of crack susceptibility	—
$\lambda$	Thermal conductivity	J/cm K s
$\rho$	Density	kg/m <sup>3</sup>
$C$	Specific heat capacity	J/kg K

## 5 Parent metal

This standard applies to ferritic steels excluding ferritic stainless steels. This includes steels referenced in groups 1 to 7 of CR ISO 15608. When ordering steel it may be necessary to specify requirements concerning weldability, which can involve specifying additional requirements to those given in the relevant steel standard.

## 6 Weldability factors

The properties and the quality of welds are particularly influenced by the welding conditions. Thus, the following factors should be taken into consideration:

- joint design;
- hydrogen induced cracking;
- toughness and hardness of the heat affected zone (*HAZ*);
- solidification cracking;
- lamellar tearing;
- corrosion.

The mechanical and technological properties, in particular the hardness and toughness of the heat affected zone in a narrowly delineated area, can be influenced to a greater or lesser degree, compared with the properties of the parent metal and depend on the welding conditions. Experience and tests indicate that not only the properties of the narrow affected zone of lower strength and better flexibility, but also the load distribution effect of the tougher adjacent zones should be taken into account when assessing the ductility and safety against fracture of welded joints as this could affect the choice of steel.

## 7 Handling of welding consumables

When special protection or other treatment during storage or immediately prior to use is recommended by the consumable manufacturer, these consumables should be treated in accordance with the conditions detailed by the manufacturer.

When drying or baking, consumables should be removed from their original containers. After removal from the oven, the consumables should be protected from exposure to conditions conducive to moisture absorption. In the case of welding consumables that have been specially packaged, e.g. vacuum or other moisture resistance means, advice from the consumable manufacturer should be sought as to further steps required for drying and baking.

If controlled hydrogen levels are required, it is recommended that welders be issued with electrodes in heated quivers or sealed containers.

Drying ovens, e.g. for welding consumables, shall be provided with means of measuring the oven temperature.

## 8 Weld details

### 8.1 Butt welds

Butt joints between parts of unequal cross-section should be made and subsequently shaped such that a severe stress concentration at the junction is avoided.



Some examples of joint preparations for use with metal arc welding with covered electrodes and gas-shielded metal arc welding are given in EN 29692.

Partial penetration butt joints may be permitted dependant on the design specification. Consideration should be given to the choice of weld preparation and welding consumables in order to achieve the specified throat thickness.

Under fatigue conditions, partial penetration joints or the use of permanent backing material may be undesirable.

Backing material may consist of another steel part of the structure when this is appropriate.

When it is not appropriate to use part of the structure as backing material, the material to be used shall be such that detrimental effects on the structure are avoided and shall be agreed in the design specification.

Care shall be taken when using copper as a backing material as there is a risk of copper pick-up in the weld metal.

Where temporary or permanent backing material is employed, the joint shall be arranged in such a way as to ensure that complete fusion of the parts to be joined is readily achieved.

Wherever the fabrication sequence allows, tack welds attaching permanent backing should be positioned for subsequent incorporation into the weld (see clause 14 of EN 1011-1:1998).

## **8.2 Fillet welds**

Unless otherwise specified, the edges and surfaces to be joined by fillet welding shall be in as close contact as possible since any gap may increase the risk of cracking. Unless otherwise specified, the gap shall not exceed 3 mm. Consideration shall be given to the need to increase the throat of the fillet weld to compensate for a large gap.

Unless otherwise specified, welding should not start/stop near corners, instead, it should be continued around the corners.

## **9 Welds in holes or slots**

Due to the risk of cracking, holes or slots should not be filled with weld metal unless required by the design specification. Holes or slots that are required to be filled with weld metal shall only be filled after the first run has been found to be acceptable (see also B.4).

## **10 Preparation of joint face**

### **10.1 General**

Any large notches or any other errors in joint geometry which might occur shall be corrected by applying a weld deposit according to an approved welding procedure. Subsequently, they shall be ground smooth and flush with the adjacent surface to produce an acceptable finish.

Prefabrication primers (shop primers) may be left on the joint faces provided that it is demonstrated they do not adversely affect the welding.

### **10.2 Fusion faces**

When shearing is used, the effect of work hardening should be taken into account and precautions shall be taken to ensure that there is no cracking of the edges.

Single-U and double-U and single-J weld preparations usually have to be machined. In assessing the methods of preparation and type of joint, the requirements of the chosen welding process should be taken into account.

### **10.3 Un-welded faces**

Where a cut edge is not a fusion face, the effect of embrittlement from shearing, thermal cutting or gouging shall not be such as to adversely affect the workpiece.

Local hardening can be reduced by suitable thermal treatment or removed by mechanical treatment. The removal of 1 mm to 2 mm from a cut face normally eliminates the hardened layer. When using thermal cutting, local hardening can be lessened by a reduction in usual cutting speed or by preheating before cutting. If necessary the steel supplier should be consulted for recommendations on achieving a reduction in hardness.

U and J weld preparations as compared with V and bevel weld preparations serve to reduce distortion by virtue of the smaller amount of weld metal required. Likewise, double preparations are better than single preparations in that the weld metal can be deposited in alternate runs on each side of the joint. In the control of distortion, accuracy of preparation and fit-up of parts are important considerations, as well as a carefully planned and controlled welding procedure.

## **11 Alignment of butt welds before welding**

Unless specified otherwise (e.g. in a welding procedure specification or an application standard), the root edges or root faces of butt joints shall not be out of alignment by more than 25 % of the thickness of the thinner material for material up to and including 12 mm thick, or by more than 3 mm for material thicker than 12 mm.

For certain applications and welding processes, closer tolerances may be necessary.

NOTE For the purposes of Directive 97/23/EC, an application standard means a relevant product standard.

## **12 Preheating**

The points of temperature measurement shall be in accordance with EN ISO 13916 except that for all thicknesses the distance for measurement shall be at least 75 mm from the weld centre-line.

Particular attention should be paid to the need for preheating when making low heat input welds, e.g. tack welds.

## **13 Tack welds**

It is recommended that the minimum length of a tack weld should be 50 mm, but for material thicknesses less than 12 mm the minimum length of a tack weld shall be four times the thicker part. For materials of thickness greater than 50 mm or of yield strength over 500 N/mm<sup>2</sup> consideration should be given to increasing the length and size of tack welds, which may involve the use of a two run technique. Consideration should also be given to the use of lower strength and/or higher ductility consumables when welding higher alloy steel.

## **14 Temporary attachments**

If a thermal process is used to remove a temporary attachment or run on/off pieces after welding, sufficient attachment or run on/off piece shall be left to allow subsequent removal of the heat affected material by careful grinding.

## 15 Heat input

Heat input is calculated from the weld travel speed (see clause 19 of EN 1011-1:1998). When weaving with manual metal arc welding, the weave width should be restricted to three times the diameter of the core rod.

For multi-wire arc welding, the heat input is calculated as the sum of the heat input for each individual wire using the individual current and voltage parameters.

## 16 Welding procedure specification

The welding procedure specification shall comply with EN 288-2 and shall include the following:

- a) whether shop or site welding;
- b) maximum combined thickness (see C.2.4), if annex C.2 is applied; plate thickness, if annex C.3 is applied;
- c) heat input (see clause 15);
- d) hydrogen scale (see C.2.3 and C.3.2);
- e) tack welds (see clause 13).

## 17 Identification

Where the use of hard stamp marks is required by the contract, guidance on their location and size shall be given. Indentations used for marking in radiographic examination require equal consideration.

## 18 Inspection and testing

Due to the risk of delayed cracking, a period of at least 16 h is generally required before the final inspection is made of as-welded fabrications. The minimum time may be reduced for thin materials below 500 N/mm<sup>2</sup> yield strength or increased for materials of thickness greater than 50 mm or of yield strength over 500 N/mm<sup>2</sup>. Whatever period is used it shall be stated in the inspection records.

Welds that have been heat-treated to reduce the hydrogen content or which have been stress relieved, need no additional time interval following the heat treatment before final inspection is made.

Tungsten inert gas welding (TIG) and other re-melting processes, if required for post weld treatment, shall be performed before final inspection.

Welds which are to be inspected and approved shall not be painted or otherwise treated until they have been accepted.

## 19 Correction of non-conforming welds

All welds which do not conform to the design specification shall be corrected.

NOTE Fracture mechanics or other assessment techniques may be used to determine whether a non-conforming weld needs to be corrected.

## **20 Correction of distortion**

The temperature of heated areas, measured by appropriate methods, should be in accordance with the recommendations of the material supplier or the design specification.

## **21 Post weld heat treatment**

When post weld heat treatment of welds is required but no application standard exists, the heat treatment details shall be stated in the design specification taking account of the effect on the properties of the parent metal, *HAZ* and weld metal.

## Annex A (informative)

### Possible detrimental phenomena resulting from welding of steels, not covered by other annexes

Possible detrimental phenomena resulting from welding	Causes	Counter measures
Stress relief heat treatment cracks	Carbide or nitride precipitation can occur during stress relief heat treatment if the stress relief heat treatment and/or steel composition are unfavourable. This can reduce the ductility of the steel such that relaxation of stress leads not only to plastic deformation but also to crack formation.	<p>Reduce stress concentrations by grinding the toes of welds.</p> <p>Minimize the amount of coarse-grained <i>HAZ</i> by correct weld run sequence.</p> <p>Use optimum heat treatment procedures.</p>
Corrosion a) General attack  b) Stress corrosion cracking	<p>Differences in chemical composition, grain size and stress levels between the weld and the parent material can lead to different corrosion rates. In most cases the weld and heat affected zone are attacked preferentially.</p> <p>Caused by a critical combination of stress, microstructure and environment.</p>	<p>Avoid large differences in plate and weld metal compositions.</p> <p>Avoid stress concentrations.</p> <p>Minimize weld stress levels.</p> <p>Reduce hardness levels.</p>

## Annex B (informative)

### Guidance on joint detail design (when there is no application standard)

#### B.1 General

This annex may be used where no guidance from an application standard exists. Further information is given in other documents, e.g. EN 1708-1:1999, EN 1708-2. Particular guidance on design to avoid lamellar tearing is given by annex F.

#### B.2 Butt joints

Butt joints between parts of unequal cross-section, arranged in line, will result in a local increase in stress in addition to the stress concentration caused by the profile of the weld itself. If the centre planes of the two parts joined do not coincide, local bending also will be induced at the joint. If the stresses induced by these effects are unacceptable, then the parts should be shaped before welding by a slope of not greater than 1 in 4 so as to reduce the stresses. Examples of plain and shaped parts are shown in Figure B.1, where a) and b) are the more common types with c) being a special configuration to facilitate non-destructive testing.

A partial penetration butt weld which is welded from one side only should not be subjected to a bending moment about the longitudinal axis of a weld. It would cause the root of the weld to be in tension. Therefore it should be avoided and only used when permitted by the design. Under such circumstances it may be allowed by an application standard or contract.

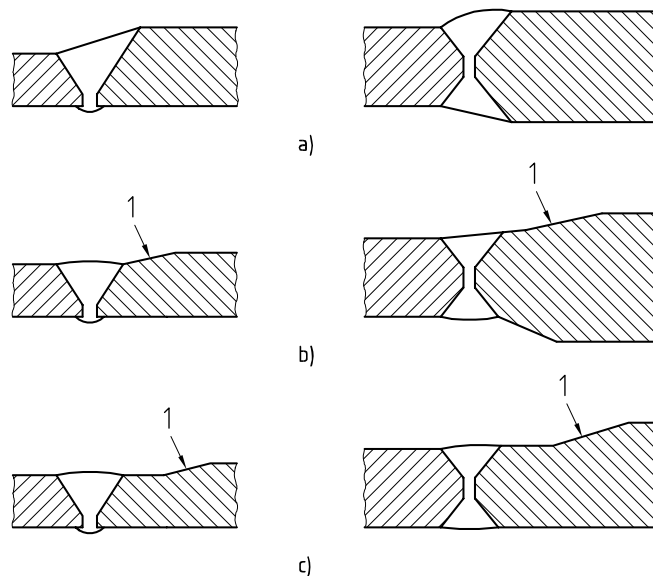

#### Key

- 1 Slope approximately 1 in 4
- a) Slope in the weld
- b) Slope in the thicker plate
- c) Special configuration to facilitate non-destructive testing

Figure B.1 — Butt joints of unequal cross-section

### B.3 Fillet welds

The effective length of an open ended fillet weld should be taken as the overall length less twice the leg length. In any case, the effective length should be not less than 25 mm or four times the leg length whichever is the greater.

For fillet welded joints carrying a compressive load, it should not be assumed that the parts joined are in contact under the joint. For critical applications the use of a partial or even a full penetration butt weld should be considered.

Where the specified leg length of a fillet weld, at the edge of a plate or section, is such that the parent metal does not project beyond the weld, melting of the outer corner or corners, which reduces the throat thickness, is not allowed (see Figure B.2).

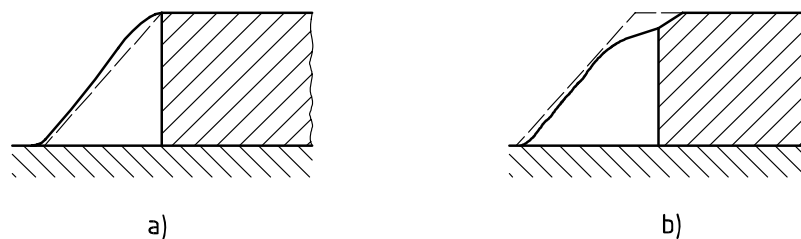

- a) Desirable
- b) Not acceptable because of reduced throat thickness

**Figure B.2 — Fillet welds applied to the edge of a part**

A single fillet weld should not be subjected to a bending moment about the longitudinal axis of the joint which would cause the root of the weld to be in tension.

Fillet welds connecting parts, where the fusion faces form an angle of more than 120° or less than 60°, should not be relied upon to transmit calculated loads at the full working stresses unless permitted to do so by the application standard.

The design throat thickness of a flat or convex fillet weld connecting parts, where the fusion faces form an angle between 60° and 120°, can be derived by multiplying the leg length by the appropriate factor as given in Table B.1.

**Table B.1 — Factors for deriving design throat thickness of flat or convex fillet welds based on leg angle**

Angle between fusion faces (degrees)	Factor
60 to 90	0,7
91 to 100	0,65
101 to 106	0,60
107 to 113	0,55
114 to 120	0,50

Due account should be taken of fabrication, transport, and erection stresses particularly for those fillet welds which have been designed to carry only a light load during service.

## **B.4 Holes and slots**

In order to provide access for welding, the diameter of a hole or the width of a slot should be not less than three times the material thickness or 25 mm, whichever is the greater. Ends of slots should be rounded with a radius of not less than 1,5 times the material thickness or 12 mm, whichever is the greater. The distance between the edge of the part and the edge of the hole or slot, or between the adjacent slots or holes, should be not less than twice the thickness and not less than 25 mm for holes (see also clause 9).



## **Annex C** (informative)

### **Avoidance of hydrogen cracking (also known as cold cracking)**

#### **C.1 General**

This annex gives recommendations for the avoidance of hydrogen cracking.

In preparing this annex, full account was taken of the fact that many methods have been proposed for predicting preheat temperatures to avoid hydrogen cracking in non-alloyed, fine grained and low alloy steel weldments. Examples are given in IIW documents IX-1602-90 and IX-1631-91. Two methods are included in this annex as C.2 and C.3. Method A given in C.2 is based on extensive experience and data which is mainly, but not exclusively, for carbon manganese type steels. Method B given in C.3 is based on experience and data which is mainly, but not exclusively, for low alloy high strength steels. The differences in origin and experience used to develop these two methods can be used as a guide as to their application.

The method described under C.4 shall be used for creep resisting and low temperature steels.

The recommendations apply only to normal fabrication restraint conditions. Higher restraint situations may need higher preheat temperature or other precautions to prevent hydrogen cracking.

Clauses C.2 and C.3 refer to welding of parent metal at temperatures above 0 °C. When welding is carried out below this temperature it is possible that special requirements will be needed.

Alternative procedures to those derived from this annex may be used, for example lower preheat temperatures, provided they are supported by evidence of their effectiveness. The evidence should include all the factors also considered for the welding procedures as given in this annex.

#### **C.2 Method A for the avoidance of hydrogen cracking in non-alloyed, fine grained and low alloy steels**

##### **C.2.1 Parent metal**

Clause C.2 covers non-alloyed, fine grained and low alloy steels.

The range of chemical composition in percentage by weight of the main alloy constituents is:

— Carbon	0,05 to 0,25
— Silicon	0,8 max.
— Manganese	1,7 max.
— Chromium	0,9 max.
— Copper	1,0 max.
— Nickel	2,5 max.
— Molybdenum	0,75 max.
— Vanadium	0,20 max.

The determination of safe, but economic, preheating levels for the prevention of hydrogen cracking is critically dependent on an accurate knowledge of parent metal composition and carbon equivalent,  $CE$ , and on the weld metal composition (see C.2.9).

Carbon equivalent ( $CE$ ) values for parent material are calculated using the following formula:

$$CE = C + \frac{Mn}{6} + \frac{Cr+Mo+V}{5} + \frac{Ni+Cu}{15} \quad \text{in \%} \quad (C.1)$$

Clause C.2 is applicable to steels with a carbon equivalent ( $CE$ ) in the range 0,30 to 0,70.

If, of the elements in this formula, only carbon and manganese are stated on the mill sheet for carbon and carbon manganese steels, then 0,03 should be added to the calculated value to allow for residual elements. Where steels of different carbon equivalent or grade are being joined, the higher carbon equivalent value should be used.

This carbon equivalent formula may not be suitable for boron-containing steels.

### C.2.2 Factors affecting cracking

The occurrence of hydrogen cracking depends on a number of factors: composition of the steel, the welding procedure, welding consumables and the stress involved. If the  $t_{8/5}$  time (cooling time from 800 °C to 500 °C) associated with welding is too short, excessive hardening can occur in the heat affected zone. When the hydrogen in the weld is above a critical level the hardened zone can crack spontaneously under the influence of residual stress after the weld has cooled to near ambient temperature. Welding conditions may be selected to avoid cracking by ensuring that the heat affected zone cools sufficiently slowly, by control of weld run dimensions in relation to metal thickness, and if necessary, by applying preheat and controlling interpass temperature. Procedures for avoiding hydrogen cracking, as well as selecting cooling times through the transformation temperature range to avoid hardened and susceptible microstructures, may involve controlling cooling in the lower temperature part of the thermal cycle, typically from 300 °C to 100 °C, thereby beneficially influencing the evolution of hydrogen from the welded joint. In particular, this can be achieved by the application of a post-heat on completion of welding which is typically a maintenance of the preheat temperature.

The hydrogen content of the weld can be controlled by using hydrogen controlled welding processes and consumables, and also to some extent, by the application of post-heat as described previously.

Similar considerations apply to hydrogen cracking in the weld metal, where although hardening will be on a reduced scale, actual hydrogen and stress levels are likely to be higher than in the heat affected zone. In general, welding procedures selected to avoid heat affected zone hydrogen cracking will also avoid cracking in the weld metal. However, under some conditions such as high restraint, low  $CE$  steels, thick sections, or alloyed weld metal, weld metal hydrogen cracking can become the dominant mechanism.

The most effective assurance of avoiding hydrogen cracking is to reduce the hydrogen input to the weld metal from the welding consumables. The benefits resulting from a growing number of possibilities where no preheat temperature > 20 °C is required, can (as shown by examples in Table C.1) be increased by using filler materials with lower hydrogen content.

**Table C.1 — Examples of maximum combined thickness (see C.2.4) weldable without preheat**

Diffusible hydrogen content <sup>a</sup>  ml/100 g of deposited metal	Maximum combined thickness			
	CE of 0,49		CE of 0,43	
	Heat input 1,0 kJ/mm	Heat input 2,0 kJ/mm	Heat input 1,0 kJ/mm	Heat input 2,0 kJ/mm
	mm	mm	mm	mm
> 15	25	50	40	80
10 ≤ 15	30	55	50	90
5 ≤ 10	35	65	60	100
3 ≤ 5	50	100	100	100
≤ 3	60	100	100	100

<sup>a</sup> Measured in accordance with ISO 3690

Welding conditions for avoiding hydrogen cracking in carbon manganese steels have been drawn up in graphical form in Figure C.2 for the normal range of compositions, expressed as carbon equivalent, covered by this standard and these conditions should be followed for all types of joint whenever practicable.

The conditions have been drawn up to take account of differences in behaviour between different steels of the same carbon equivalent (making allowances for scatter in hardness) and of normal variations between ladle and product analysis. They are valid for the avoidance of both heat affected zone and weld metal cracking in the majority of welding situations (see also C.2.9).

### C.2.3 Hydrogen content of welding consumables

#### C.2.3.1 General

The manufacturer should be able to demonstrate that he has used the consumables in the manner recommended by the consumable manufacturer and that the consumables have been stored and dried or baked to the appropriate temperature levels and times.

#### C.2.3.2 Hydrogen scales

The hydrogen scale to be used for any arc welding process depends principally on the weld diffusible hydrogen content and should be as given in Table C.2. The value used should be stated by the consumable manufacturer in accordance with the relevant standard where it exists (or as independently determined) in conjunction with a specified condition of supply and treatment.

**Table C.2 — Hydrogen scales**

Diffusible hydrogen content ml/100 g of deposited metal	Hydrogen scale
> 15	A
10 ≤ 15	B
5 ≤ 10	C
3 ≤ 5	D
≤ 3	E

### **C.2.3.3 Selection of hydrogen scales**

The following gives general guidance on the selection of the appropriate hydrogen scale for various welding processes.

Manual metal arc basic covered electrodes can be used with scales B to D depending on the electrode manufacturer's classification of the consumable. Manual metal arc rutile or cellulosic electrodes should be used with scale A.

Flux-cored or metal-cored consumables can be used with scales B to D depending on the manufacturer's classification of the wire. Submerged-arc wire and flux consumable combinations can have hydrogen levels corresponding to scales B to D, although most typically these will be scale C but therefore need assessing in the case of each named product combination and condition. Submerged-arc fluxes can be classified by the manufacturer but this does not necessarily confirm that a practical flux/wire combination also meets the same classification.

Solid wires for gas-shielded arc welding and for TIG welding may be used with scale D unless specifically assessed and shown to meet scale E. Scale E may also be found to be appropriate for some cored wires and some manual metal arc basic covered electrodes, but only after specific assessment. On achieving these low levels of hydrogen, consideration should be given to the contribution of hydrogen from the shielding gas composition and atmospheric humidity from welding.

For plasma arc welding, specific assessment should be made.

### **C.2.4 Combined thickness**

Combined thickness should be determined as the sum of the parent metal thicknesses averaged over a distance of 75 mm from the weld line (see Figure C.1).

Combined thickness is used to assess the heat sink of a joint for the purpose of determining the cooling rate.

If the thickness increases greatly just beyond 75 mm from the weld line, it may be necessary to use a higher combined thickness value.

For the same metal thickness, the preheating temperature is higher in a fillet weld than in a butt weld because the combined thickness, and therefore the heat sink, is greater.

Dimensions in millimetres

$d_1$  = average thickness over a length of 75 mm

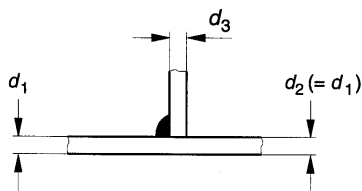
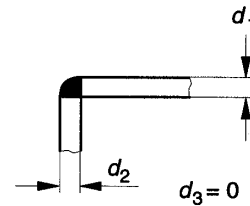
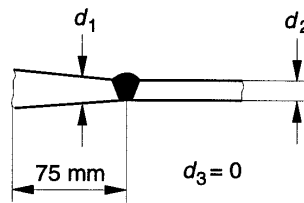

For simultaneously deposited directly opposed twin fillet welds, combined thickness =  $\frac{1}{2} (d_1 + d_2 + d_3)$

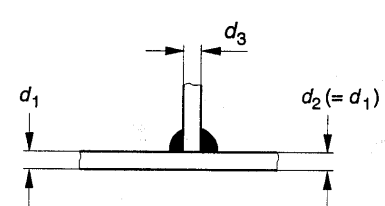

Combined thickness =  $d_1 + d_2 + d_3$

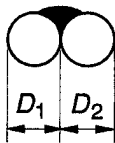

Combined thickness =  $\frac{1}{2} (D_1 + D_2)$  Maximum diameter 40 mm

The limited heat sink has to be considered [see C.2.10 b)].

Figure C.1 — Examples for the determination of combined thickness

### C.2.5 Preheat temperature

The preheating temperature to be used should be obtained from Figure C.2 a) to m) by reading the preheat line immediately above or to the left of the co-ordinated point for heat input and combined thickness.

### C.2.6 Interpass temperature

The minimum recommended interpass temperature is frequently used as the preheat temperature for multi-run welds. However, multi-run welds may have a lower permitted interpass temperature than the preheat temperature where subsequent runs are of higher heat input than the root run. In these cases the interpass temperature should be determined from Figure C.2 a) to m) for the larger run. Recommendations relating to maximum interpass temperature for creep resisting and low temperature steels are given in Table C.5 and Table C.6.

### C.2.7 Heat input

Heat input values (in kJ/mm) for use with Figure C.2 should be calculated in accordance with EN 1011-1:1998 and clause 15.

### **C.2.8 Hydrogen reduction by post-heating**

When there is a higher risk of cold cracking, hydrogen release should be accelerated by either maintaining the minimum interpass temperature or raising the temperature to 200 °C to 300 °C immediately after welding and before the weld region cools to below the minimum interpass temperature. The duration of post-heating should be at least 2 h and is a function of the thickness. Large thicknesses require temperatures at the upper end of the stated range as well as prolonged post-heating times.

Post-heating is also appropriate where a partially filled weld cross-section is to be cooled.

### **C.2.9 Conditions which may require more stringent procedures**

The preheating conditions presented in Figure C.2 have been found from experience to provide a satisfactory basis for deriving safe welding procedures for many welded fabrications. However, the risk of hydrogen cracking is influenced by several parameters and these can sometimes exert an adverse influence greater than accounted for in Figure C.2 a) to m). The following paragraphs cover some factors which can increase the risk of cracking above that envisaged in drawing up the data in Figure C.2. Precise quantification of the effects of these factors on the need for a more stringent procedure and on the change to the welding procedure required to avoid cracking cannot be made at the present time. The following factors should therefore be considered for guidance only.

Joint restraint is a complex function of section thickness, weld preparation, joint geometry, and the stiffness of the fabrication. Welds made in section thicknesses above approximately 50 mm and root runs in double bevel butt joints may require more stringent procedures.

Certain welding procedures may not be adequate for avoiding weld metal hydrogen cracking when welding steels of low carbon equivalent. This is more likely to be the case when welding thick sections (i.e. greater than about 50 mm) and with higher heat inputs.

The use of higher strength alloyed weld metal or carbon manganese weld metal with a manganese content above approximately 1,5 % can lead to higher operative stresses. Whether or not this causes an increased risk of heat affected zone cracking, the weld deposit would generally be harder and more susceptible to cracking itself.

Experience and research has indicated that lowering the inclusion content of the steel, principally by lowering the sulphur content (but also the oxygen content) can increase the hardenability of the steel. From a practical point of view this effect can result in an increase in the hardness of the heat affected zone and possibly a small increase in the risk of heat affected zone hydrogen cracking. Accurate quantification of the effect is presently not practicable.

Although modifications to the procedures to deal with welds involving the above factors can, in principle, be obtained through a change in heat input, preheating or other influencing factors, the most effective modification is to lower the weld hydrogen level. This can be done either directly, by lowering the weld hydrogen input to the weld (use of lower hydrogen welding processes or consumables), or by increasing hydrogen loss from the weld by diffusion through the use of higher post-heat for a period of time after welding. The required post-heat time will depend on many factors, but a period of 2 h to 3 h has been found to be beneficial in many instances. It is recommended that the required modifications to the procedures be derived by the use of adequate joint simulation weld testing.

### **C.2.10 Relaxations**

Relaxations of the welding procedures may be permissible under the following conditions:

a) General preheating.

If the whole component or a width more than twice that stated in clause 12 is preheated, it is generally possible to reduce the preheating temperature by a limited amount.

b) Limited heat sink.

If the heat sink is limited in one or more directions (e.g. when the shortest heat path is less than 10 times the fillet leg length) especially in the thicker plate (e.g. in the case of a lap joint where the outstand is only marginally greater than the fillet weld leg length), it is possible to reduce preheating levels.

c) Austenitic consumables.

In some circumstances where sufficient preheating to ensure crack-free welds is impracticable, an advantage can be gained by using certain austenitic or high nickel alloy consumables. In such cases preheat is not always necessary, especially if the condition of the consumable is such as to deposit weld metal containing very low levels of hydrogen.

d) Joint fit up.

Close fit fillet welds (where the gap is 0,5 mm or less) may justify relaxations in the welding procedure.

### C.2.11 Simplified conditions for manual metal arc welding

Where single run minimum leg length fillet welds are specified in the design, Table C.3 can be used to determine the approximate heat input values for use in determining preheat temperatures from Figure C.2.

These values are appropriate for practical situations when a manufacturer is required to make single run fillet welds of specified dimensions related to the minimum leg length of the fillet welds. In practice, one leg will be longer than the minimum, as for example in a horizontal-vertical fillet weld and the data is therefore not appropriate for direct conversion to welds of specified throat dimension.

In other cases heat input should be controlled by control of electrode run out length (see Table C.4) or directly through welding parameters.

**Table C.3 — Values of heat input for manual metal arc welding of single run fillet welds**

Minimum leg length mm	Heat input for electrodes with different covering types <sup>a</sup> and electrode efficiencies		
	R and RR < 110 % kJ/mm	B < 130 % kJ/mm	R and RR > 130 % kJ/mm
4	0,8	1,0	—
5	1,1	1,4	0,6
6	1,6	1,8	0,9
8	2,2	2,7	1,3

<sup>a</sup> Covering types in accordance with EN 499

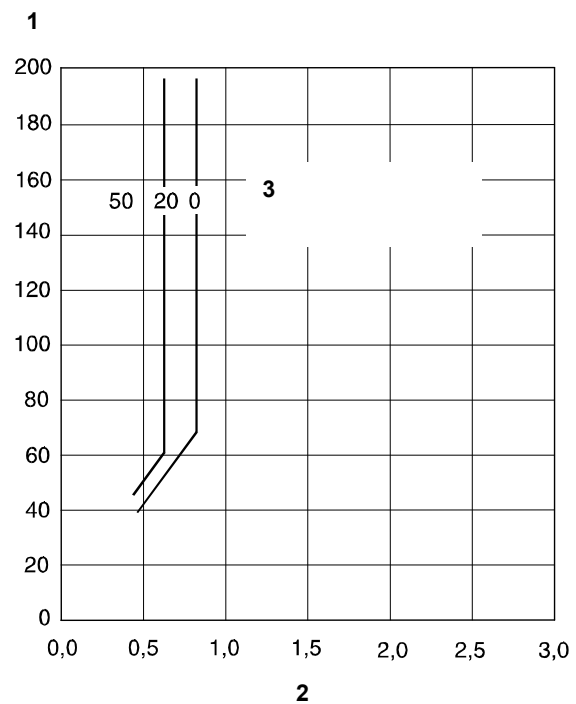

4	A	B	C	D	E
5	0,30	0,34	0,38	0,44	0,46

Figure C.2 a)

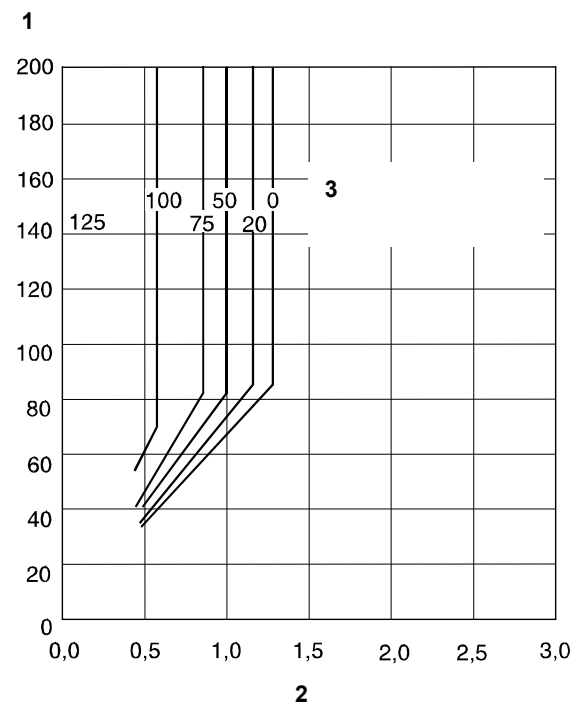

4	A	B	C	D	E
5	0,34	0,39	0,41	0,46	0,48

Figure C.2 b)

**Key**

- 1 Combined thickness, mm
- 2 Heat input, kJ/mm
- 3 Minimum preheating temperature, °C
- 4 Scale
- 5 To be used for carbon equivalent not exceeding

Figure C.2 — Conditions for welding steels with defined carbon equivalents



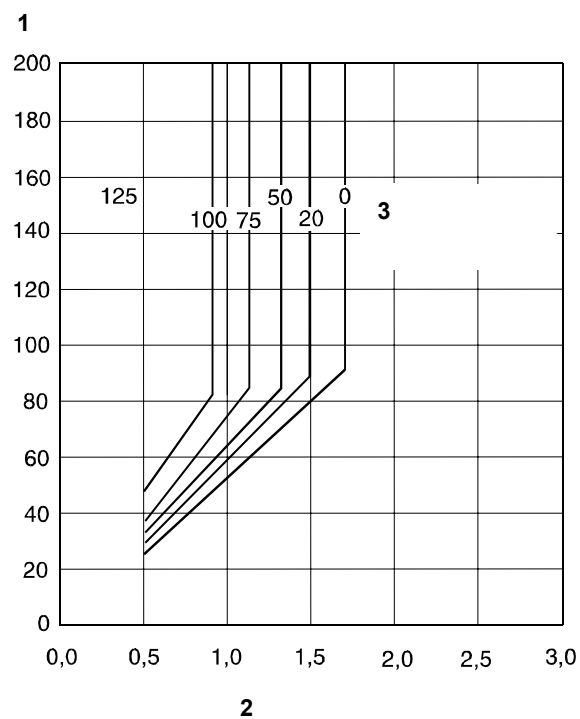

<b>4</b>	A	B	C	D	E
<b>5</b>	0,38	0,41	0,43	0,48	0,50

Figure C.2 c)

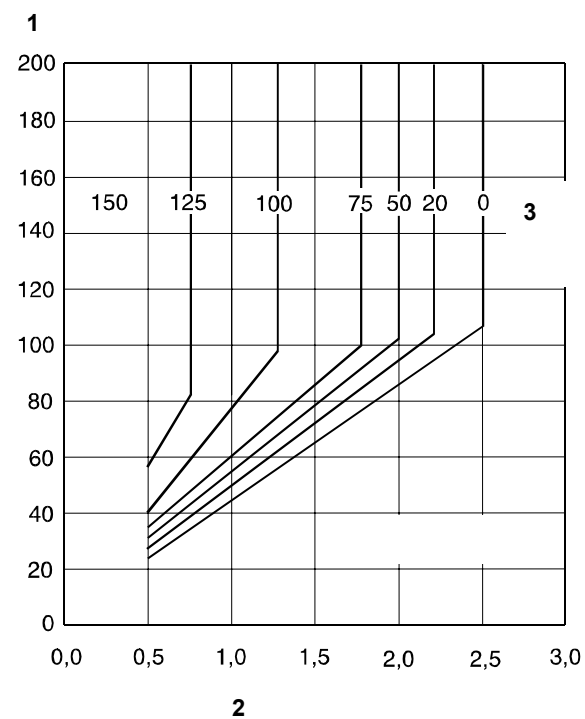

<b>4</b>	A	B	C	D	E
<b>5</b>	0,41	0,43	0,45	0,50	0,52

Figure C.2 d)

**Key**

- 1 Combined thickness, mm
- 2 Heat input, kJ/mm
- 3 Minimum preheating temperature, °C
- 4 Scale
- 5 To be used for carbon equivalent not exceeding

Figure C.2 — Conditions for welding steels with defined carbon equivalents

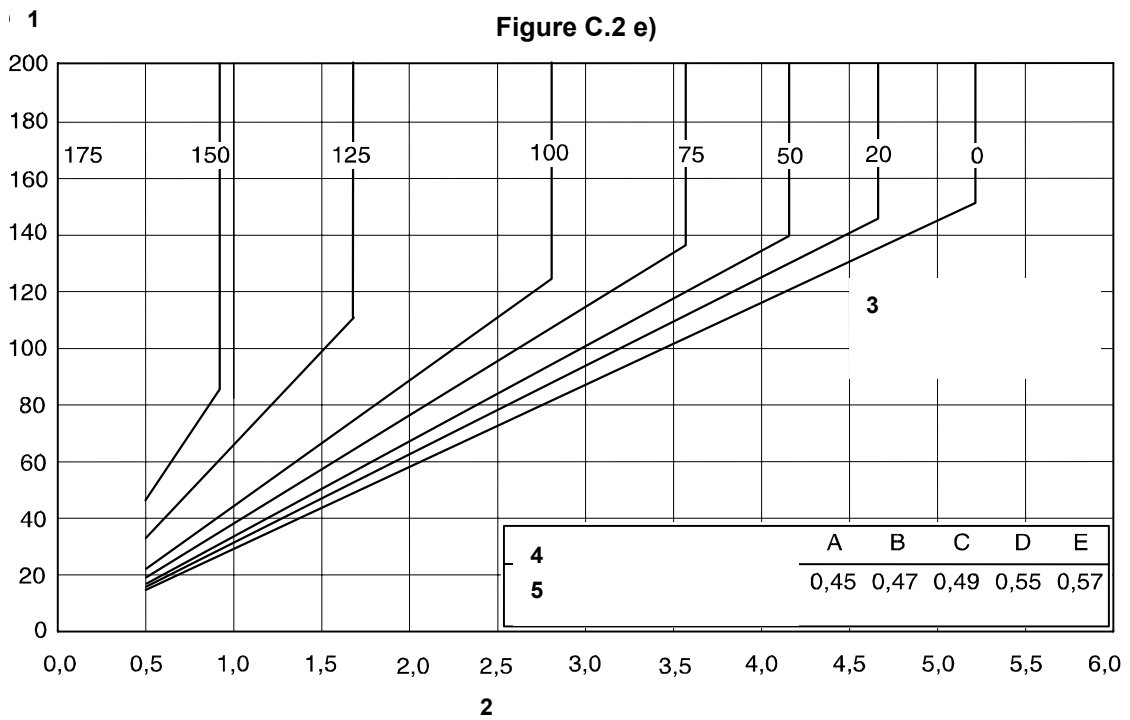
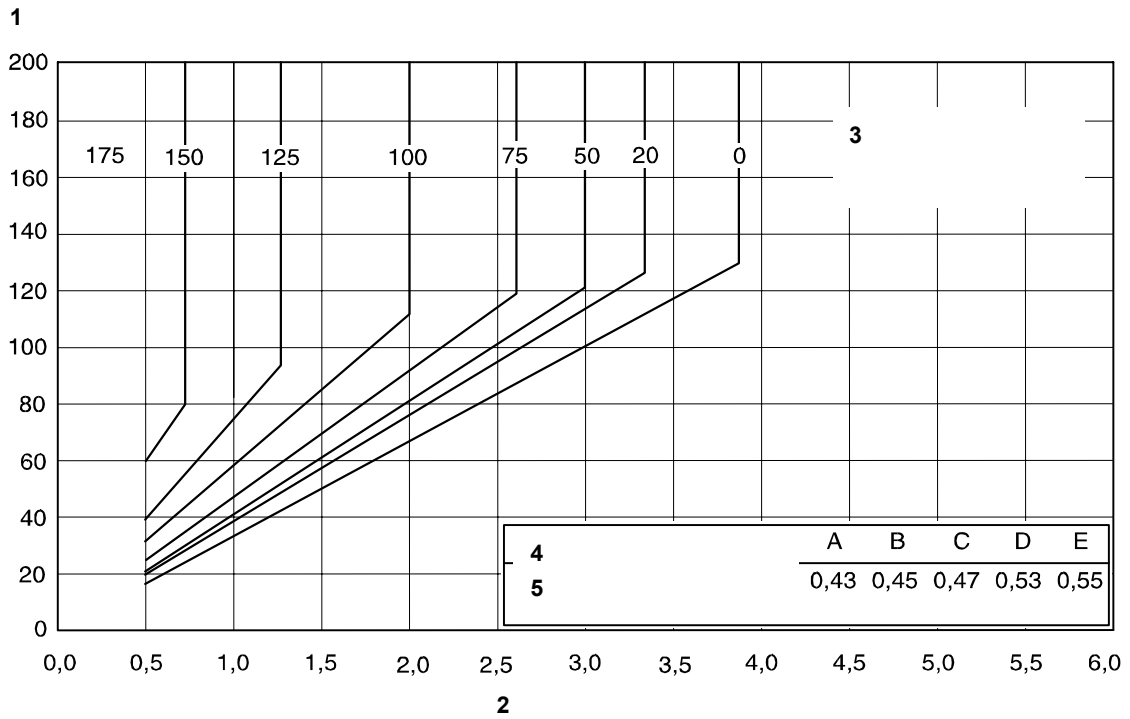

**Figure C.2 f)**

**Key**

- 1 Combined thickness, mm
- 2 Heat input, kJ/mm
- 3 Minimum preheating temperature, °C
- 4 Scale
- 5 To be used for carbon equivalent not exceeding

**Figure C.2 — Conditions for welding steels with defined carbon equivalents**

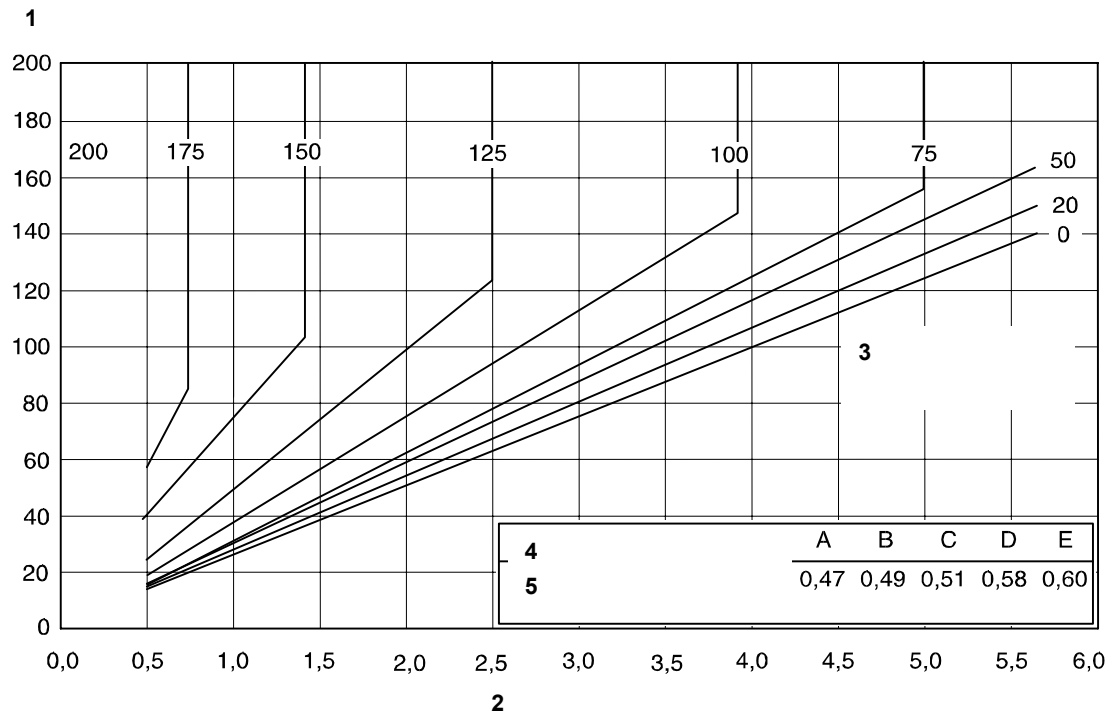

Figure C.2 g)

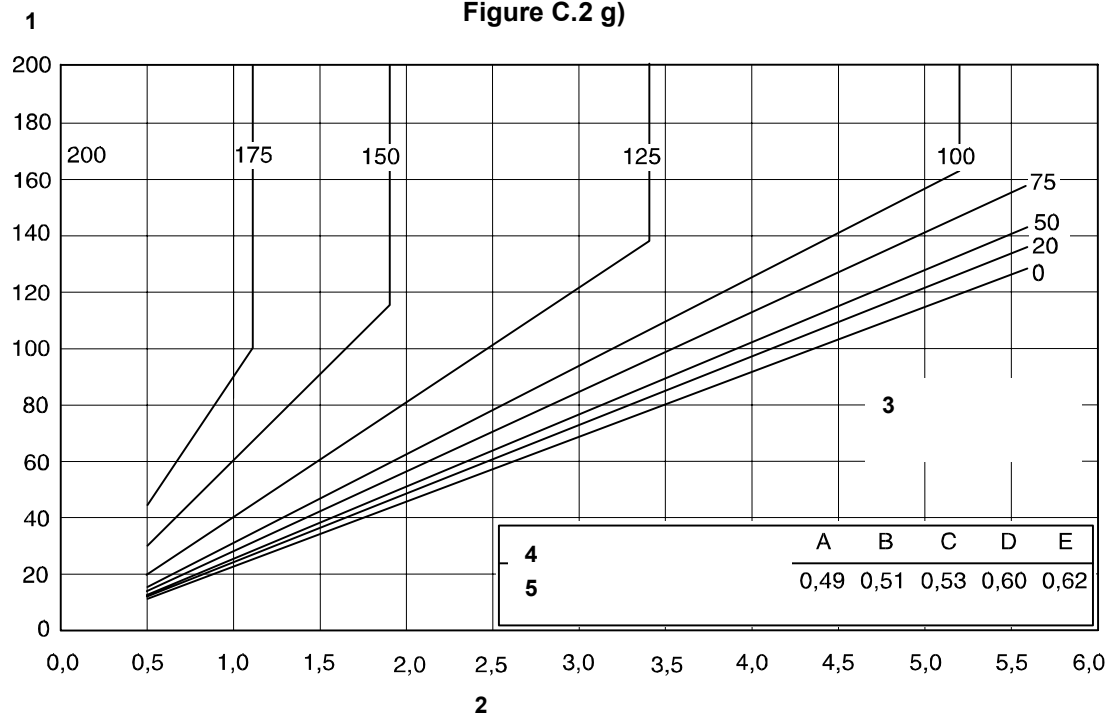

Figure C.2 h)

**Key**

- 1 Combined thickness, mm
- 2 Heat input, kJ/mm
- 3 Minimum preheating temperature, °C
- 4 Scale
- 5 To be used for carbon equivalent not exceeding

**Figure C.2 — Conditions for welding steels with defined carbon equivalents**

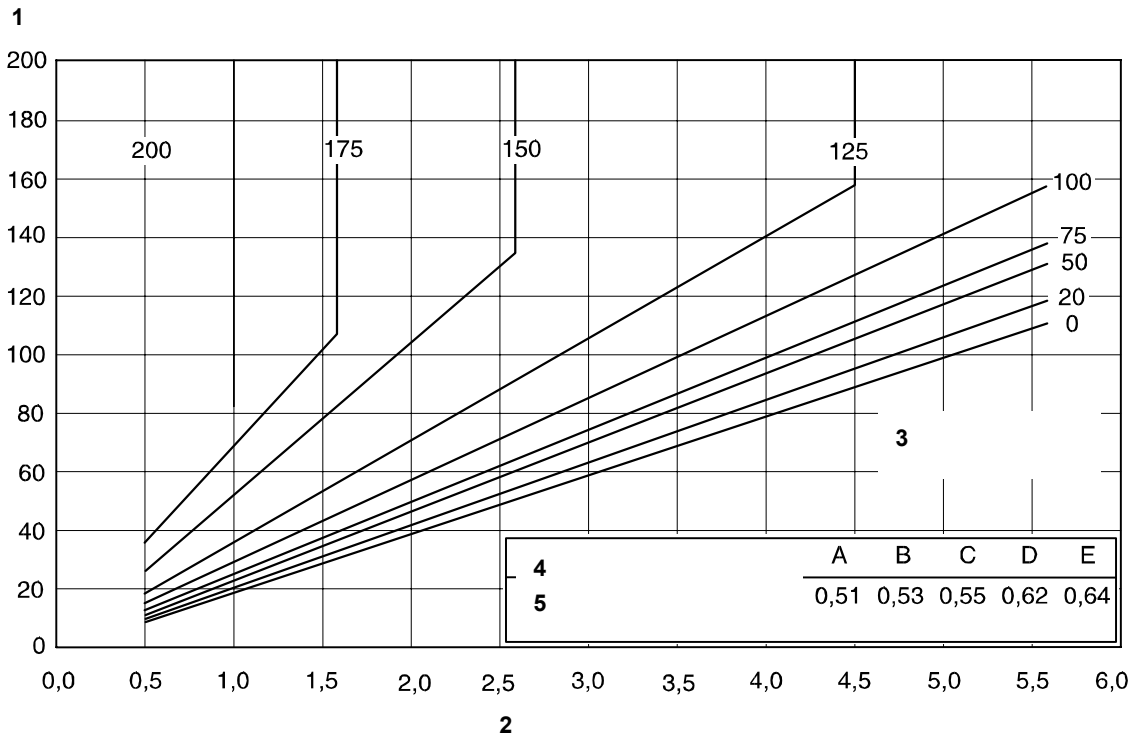

Figure C.2 i)

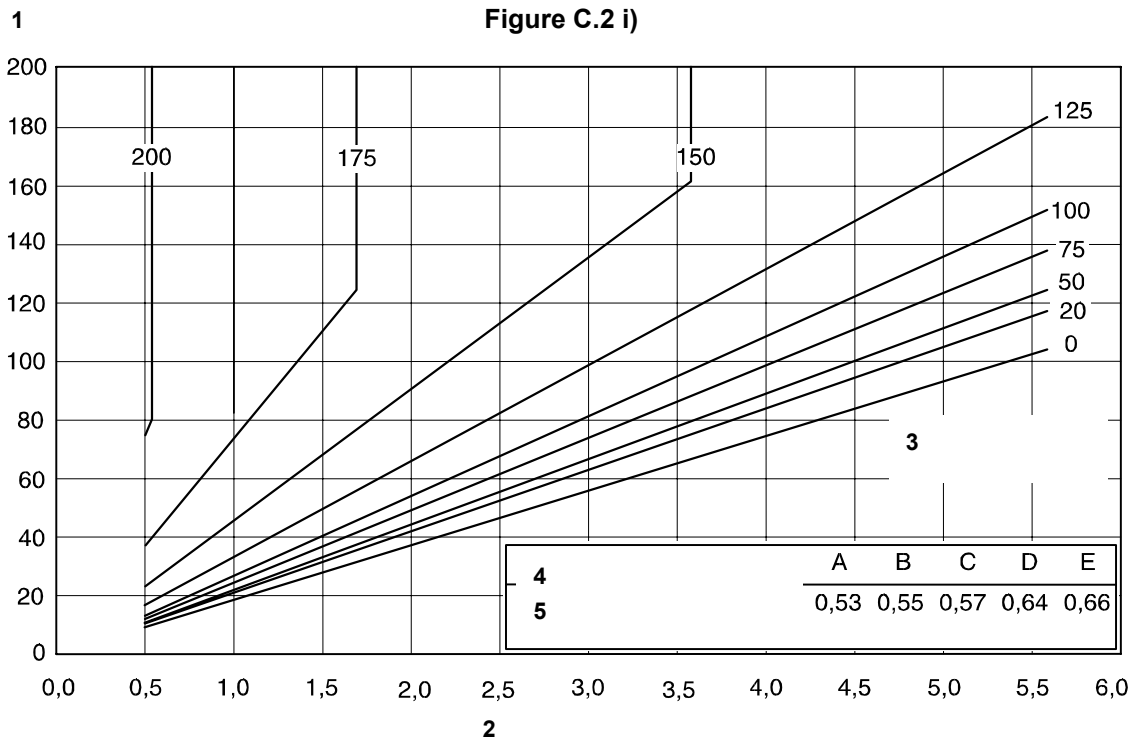

Figure C.2 j)

**Key**

- 1 Combined thickness, mm
- 2 Heat input, kJ/mm
- 3 Minimum preheating temperature, °C
- 4 Scale
- 5 To be used for carbon equivalent not exceeding

**Figure C.2 — Conditions for welding steels with defined carbon equivalents**

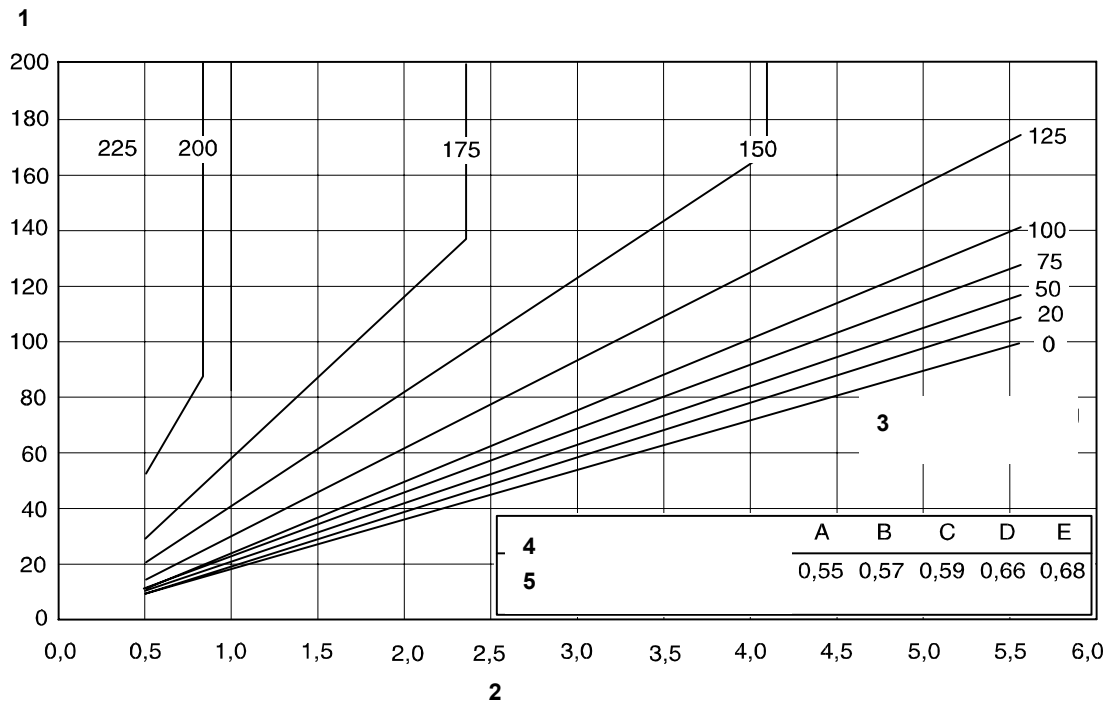

Figure C.2 k)

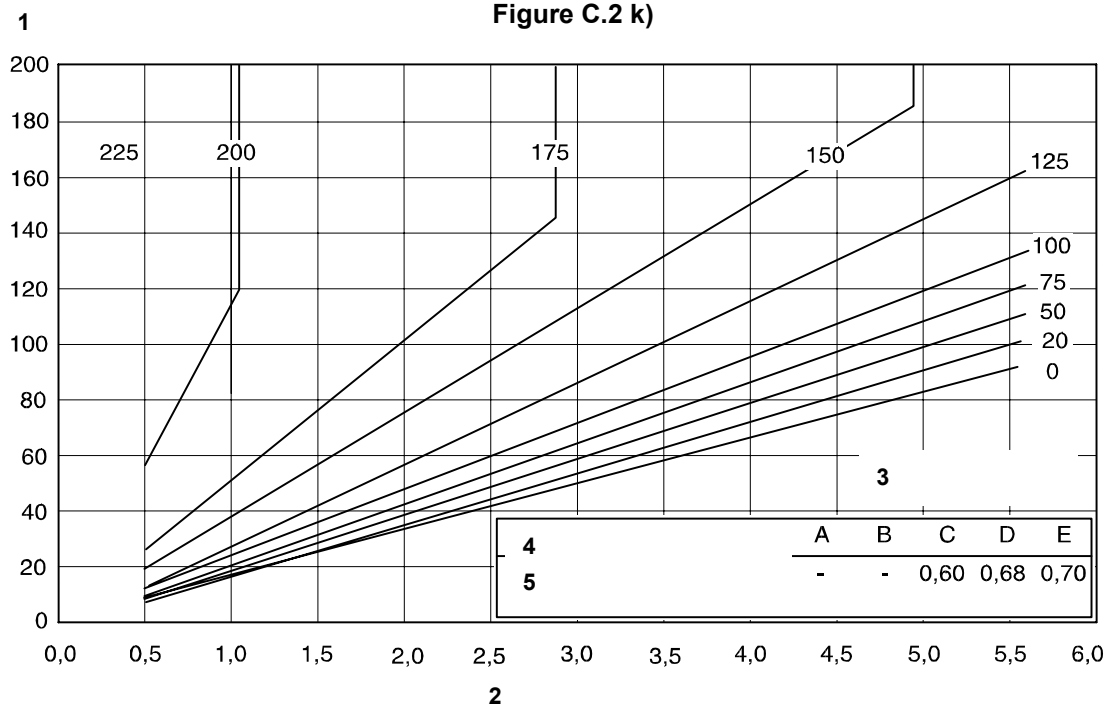

Figure C.2 l)

**Key**

- 1 Combined thickness, mm
- 2 Heat input, kJ/mm
- 3 Minimum preheating temperature, °C
- 4 Scale
- 5 To be used for carbon equivalent not exceeding

Figure C.2 — Conditions for welding steels with defined carbon equivalents

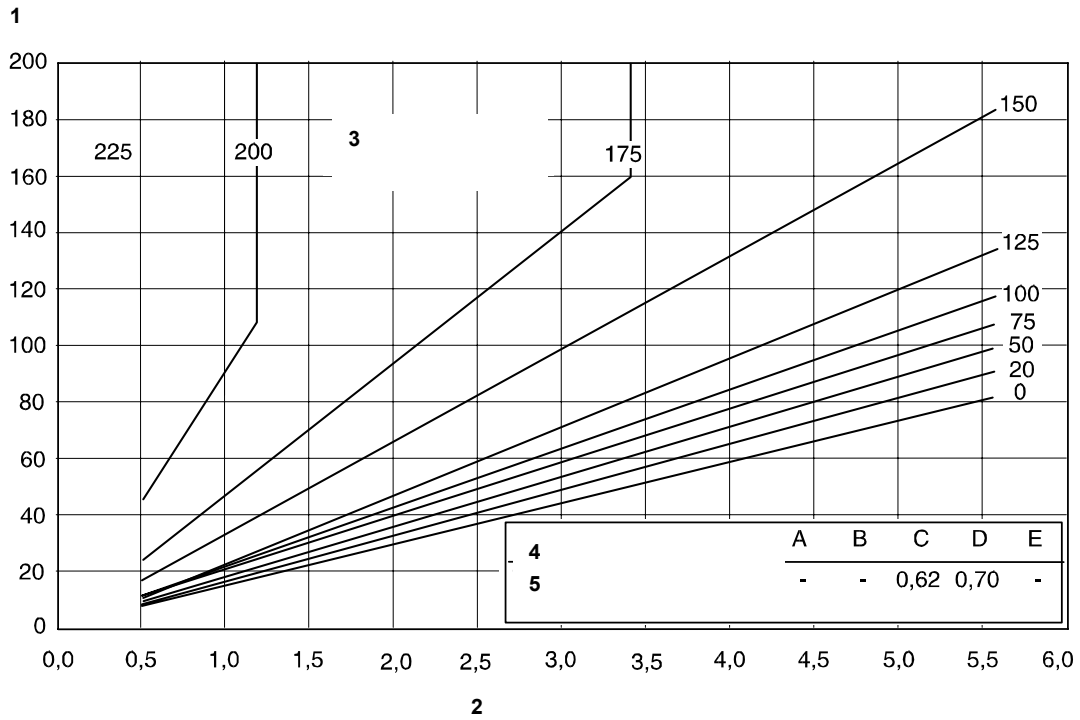

Figure C.2 m)

**Key**

- 1 Combined thickness, mm
- 2 Heat input, kJ/mm
- 3 Minimum preheating temperature, °C
- 4 Scale
- 5 To be used for carbon equivalent not exceeding

**Figure C.2 — Conditions for welding steels with defined carbon equivalents**

**Table C.4 — Run out length for manual metal arc welding**

**Table C.4.1 — Electrode efficiency 95 % approximately**

Heat input kJ/mm	Run out length from 410 mm of a 450 mm electrode of diameter:					
	2,5 mm	3,2 mm	4 mm	5 mm	6 mm	6,3 mm
0,8	120	195	300	470	—	—
1,0	95	155	240	375	545	600
1,2	—	130	200	315	450	500
1,4	—	110	170	270	390	430
1,6	—	95	150	235	340	375
1,8	—	85	135	210	300	335
2,0	—	—	120	190	270	300
2,2	—	—	110	170	245	270
2,5	—	—	95	150	215	240
3,0	—	—	80	125	180	200
3,5	—	—	—	110	155	170
4,0	—	—	—	95	135	150
4,5	—	—	—	84	120	135
5,0	—	—	—	—	110	120
5,5	—	—	—	—	100	110

**Table C.4.2 — 95 % < efficiency ≤ 110 %**

Heat input kJ/mm	Run out length from 410 mm of a 450 mm electrode of diameter:					
	2,5 mm	3,2 mm	4 mm	5 mm	6 mm	6,3 mm
0,8	130	215	335	525	—	—
1,0	105	170	270	420	600	—
1,2	85	145	225	350	500	555
1,4	—	120	190	300	430	475
1,6	—	105	165	260	375	415
1,8	—	95	150	230	335	370
2,0	—	85	135	210	300	330
2,2	—	—	120	190	275	300
2,5	—	—	105	165	240	265
3,0	—	—	90	140	200	220
3,5	—	—	—	120	170	190
4,0	—	—	—	105	150	165
4,5	—	—	—	95	135	150
5,0	—	—	—	85	120	135
5,5	—	—	—	—	110	120

**Table C.4.3 — 110 % < efficiency ≤ 130 %**

Heat input kJ/mm	Run out length from 410 mm of a 450 mm electrode of diameter:					
	2,5 mm	3,2 mm	4 mm	5 mm	6 mm	6,3 mm
0,8	150	250	385	605	—	—
1,0	120	200	310	485	—	—
1,2	100	165	260	405	580	—
1,4	85	140	220	345	500	550
1,6	—	125	195	300	435	480
1,8	—	110	170	270	385	425
2,0	—	100	155	240	350	385
2,2	—	90	140	220	315	350
2,5	—	—	125	195	280	305
3,0	—	—	105	160	230	255
3,5	—	—	90	140	200	220
4,0	—	—	—	120	175	190
4,5	—	—	—	110	155	170
5,0	—	—	—	95	140	155
5,5	—	—	—	90	125	140



**Table C.4.4 — Electrode efficiency > 130 %**

Heat input kJ/mm	Run out length from 410 mm of a 450 mm electrode of diameter:				
	3,2 mm	4 mm	5 mm	6 mm	6,3 mm
0,8	320	500	—	—	—
1,0	255	400	625	—	—
1,2	215	330	520	—	—
1,4	180	285	445	—	—
1,6	160	250	390	560	620
1,8	140	220	345	500	550
2,0	130	200	310	450	495
2,2	115	180	285	410	450
2,5	100	160	250	360	395
3,0	85	135	210	300	330
3,5	—	115	180	255	285
4,0	—	100	155	225	245
4,5	—	90	140	200	220
5,0	—	—	125	180	200
5,5	—	—	115	165	180

NOTE The values given in Table C.4 relate to electrodes having an original length of 450 mm. For other electrode lengths the following expression may be used:

$$\text{Run out length (mm)} = \frac{(\text{Electrode diameter})^2 \times L \times F}{\text{Heat input}}$$

where

$L$  is the consumed length of electrode (in mm) (normally the original length less 40 mm for the stub end)

and

$F$  is a factor in  $\text{kJ/mm}^3$  having a value depending on the electrode efficiency, as follows:

— efficiency approximately 95 %  $F = 0,0368$

— 95 % < efficiency ≤ 110 %  $F = 0,0408$

— 110 % < efficiency ≤ 130 %  $F = 0,0472$

— efficiency > 130 %  $F = 0,0608$

### C.2.12 Examples of use of C.2

Step 1: Decide which carbon equivalent value is to be used either by reference to the mill certificates or the maximum carbon equivalent in the steel standard. A steel with a carbon equivalent of 0,45 will be assumed for this example.

Step 2: Decide provisionally which welding process and consumables are to be used. Classify the consumables using the hydrogen scale A, B, C, D or E according to C.2.3 and Table C.2.

Assume that manual metal arc welding is to be used and that the weld hydrogen level corresponds to scale B in Table C.2.

Step 3: Determine whether the joint is to be fillet or butt welded.

Assume that butt-welding is to be used.

Step 4: From Figure C.2, select the appropriate graph for hydrogen scale B and a carbon equivalent of 0,45, i.e. Figure C.2 e). When a graph for the selected hydrogen scale and carbon equivalent is not available use the graph appropriate to the next highest carbon equivalent value.

Step 5: Determine the minimum run dimension to be used in making the butt weld. This will most often be the root run.

Assume that this will be deposited with a 4 mm electrode with 120 % efficiency to be run out in about 260 mm.

Refer to Table C.4.3 which gives the minimum heat input for individual runs forming the butt weld of at least 1,2 kJ/mm.

Step 6: Determine the combined thickness of the butt joint, referring to C.2.4. Assume that the calculated combined thickness is 50 mm.

Step 7: Using Figure C.2 e) plot the co-ordinates of 1,2 kJ/mm heat input and 50 mm combined thickness. Read off the minimum preheating and interpass temperature required, which in this example is 75 °C.

Variation at step 7. In the event that preheat is undesirable, proceed as follows.

Step 8: Re-examine Figure C.2 e) to determine the minimum heat input for no preheat (20 °C line, normally).

For the butt-weld example this is 1,4 kJ/mm.

Step 9: If by reference to Table C.4.3 and consideration of the welding position this heat input is feasible, proceed using the electrode diameter and run length chosen from Table C.4.3.

If this is not feasible, proceed to step 10.

Step 10: Using Figures C.2 a) and C.2 d) examine the feasibility of using lower hydrogen levels (by the use of higher electrode drying temperatures or change of consumables or change of welding process) to avoid the need for preheat at the acceptable heat input levels.

### C.3 Method B for the avoidance of hydrogen cracking in non-alloyed, fine grained and low alloy steels

#### C.3.1 General

This method covers the arc welding of steels of the groups 1 to 4 as specified in CR ISO 15608. The recommendations given in this annex should be considered in the relevant WPS.

A very effective means to avoid cold cracking is preheating of the weld to higher temperatures to delay the cooling of the weld region and thereby promote hydrogen effusion in a shorter time to a higher extent after welding than without preheating. Preheating furthermore reduces the state of internal stresses. For multilayer welds it is possible to start without preheating if a sufficiently high interpass temperature can be reached and maintained by a suitable welding sequence.

The basis of this recommendation is extensive examinations of cold cracking behaviour of steels in welding, performed on the weld itself or using special cold cracking tests. Fillet welds have also been examined. It was found out that single layer fillet welds have a lower internal stress than butt welds. The preheat temperatures determined for butt welds therefore can be about 60 °C too high for fillet welds. Depending on his experience, it is up to the manufacturer to make use of this advantage. In terms of determining the preheat temperatures for fillet and butt welds with different plate thicknesses, the preheat temperature shall be calculated on the basis of the thicker plate. Multi-layer fillet welds and butt welds have similar stress conditions. Therefore, the same preheat temperature as for butt welds shall be used to avoid cold cracks.

The lowest temperature before starting the first run and below which the weld region shall not fall during welding, in the interest of avoiding cold cracking, is designated the preheat temperature  $T_p$ . In case of multipass welding, the term also used for this temperature in reference to the second and all ensuing runs is the minimum interpass temperature  $T_i$ . Both temperatures are generally identical. For reasons of simplicity, therefore, only the term "preheat temperature" is used in the following.

#### C.3.2 Factors influencing the cold cracking behaviour of welds

The cold cracking behaviour of welded joints is influenced by the chemical composition of the parent metal and weld metal, the plate thickness, the hydrogen content of weld metal, the heat input during the welding, and the stress level. An increase of alloy content, plate thickness and hydrogen content increases the risk of cold cracking. An increase of heat input, in contrast, reduces it.

##### C.3.2.1 Base material

The influence of the chemical composition on the cold cracking behaviour of steels is characterized by means of carbon equivalents ( $CET$ ). This formula provides information on the effect on the individual alloying elements on these properties in relation to that of the carbon.

$$CET = C + \frac{Mn+Mo}{10} + \frac{Cr+Cu}{20} + \frac{Ni}{40} \quad \text{in \%} \quad (C.2)$$

It applies to the following range of concentrations (percentage by weight):

— Carbon	0,05 to 0,32
— Silicon	0,8 max.
— Manganese	0,5 to 1,9
— Chromium	1,5 max.
— Copper	0,7 max.
— Molybdenum	0,75 max.

— Niobium	0,06 max.
— Nickel	2,5 max.
— Titanium	0,12 max.
— Vanadium	0,18 max.
— Boron	0,005 max.

A linear relationship exists between the carbon equivalent,  $CET$ , and the preheat temperature,  $T_p$ , (or interpass temperature,  $T_i$ ) as shown in Figure C.3. It can be seen that an increase of around 0,01 % in the carbon equivalent,  $CET$ , leads to an increase of around 7,5 °C in the preheat temperature.

$$T_{pCET} = 750 \times CET - 150 \text{ (}^\circ\text{C)} \quad (\text{C.3})$$

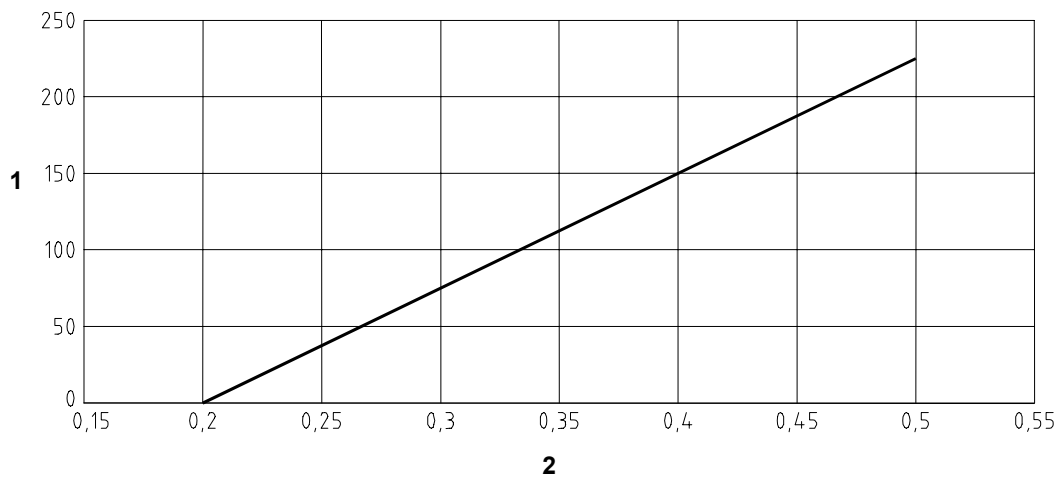

### Key

- 1  $T_{pCET}$  in °C
- 2 Carbon equivalent,  $CET$ , in %

**Figure C.3 — Preheat temperature as a function of carbon equivalent,  $CET$**

### C.3.2.2 Plate thickness

The relationship between plate thickness,  $d$ , and preheat temperature,  $T_p$ , can be seen in Figure C.4. It can be seen that for thinner material, a change in the plate thickness results in a greater change in preheat temperature. However, with increasing material thickness the effect is reduced and is only very minor above 60 mm.

$$T_{pd} = 160 \times \tanh(d/35) - 110 \text{ (}^\circ\text{C)} \quad (\text{C.4})$$

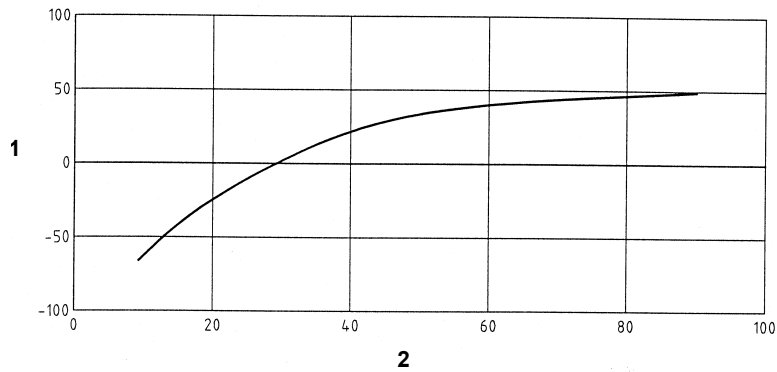

**Key**

- 1  $T_{pd}$  in °C
- 2 Plate thickness,  $d$ , in mm

**Figure C.4 — Preheat temperature as a function of plate thickness,  $d$**

**C.3.2.3 Hydrogen content**

The effect of hydrogen content,  $HD$ , of the weld metal in accordance with ISO 3690 on preheat temperature is shown in Figure C.5. It can be seen that an increase of the hydrogen content requires an increase of the preheat temperature. A change in the hydrogen content has a greater effect on the preheat temperature for lower concentrations than high ones.

$$T_{pHD} = 62 \times HD^{0,35} - 100 \text{ (°C)} \quad (C.5)$$

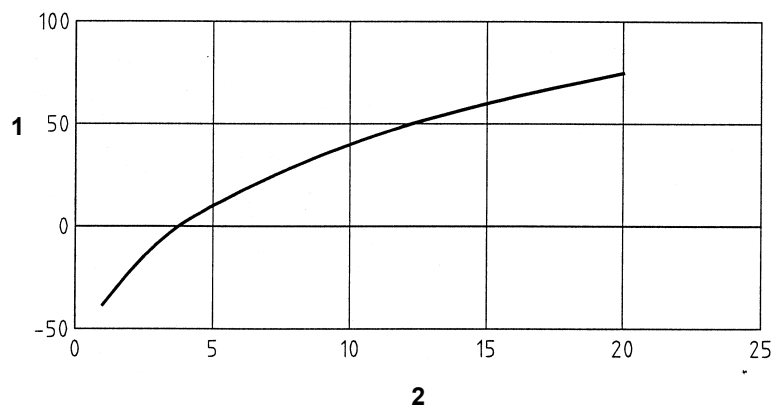

**Key**

- 1  $T_{pHD}$  in °C
- 2 Hydrogen content  $HD$  in ml/100 g

**Figure C.5 — Preheat temperature as a function of weld metal hydrogen content**

**C.3.2.4 Heat input**

The influence of the heat input,  $Q$ , on the preheat temperature can be seen in Figure C.6. It can be seen that an increased heat input during welding permits a reduction of preheat temperature. Furthermore, the influence is dependent on alloy content and is more pronounced for a low carbon equivalent than for a high one.

$$T_{pQ} = (53 \times CET - 32) \times Q - 53 \times CET + 32 \text{ (°C)} \quad (C.6)$$

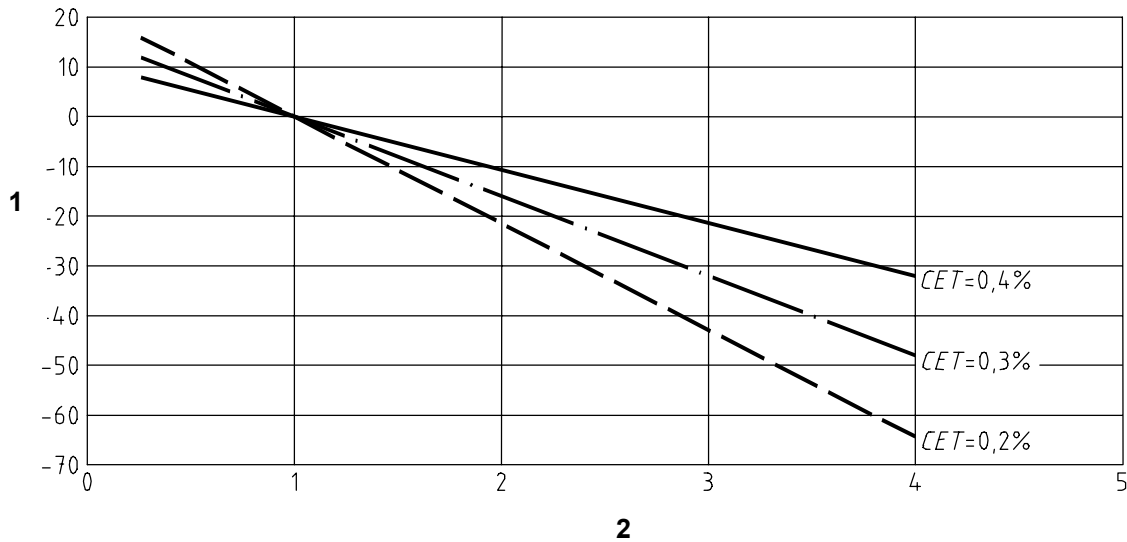

**Key**

- 1  $T_{pQ}$  in °C
- 2 Heat input in kJ/mm

**Figure C.6 — Preheat temperature as a function of heat input**

**C.3.2.5 Internal stress**

At present, the relationship between the internal stress level and the preheat temperature is known only to a certain qualitative extent. An increase of the internal stresses and of the tri-axiality of the stress state results in an increase of the preheat temperature. In deriving equation C.8 for calculating the preheat temperature, it has been assumed that the internal stresses present in the weld region are equal to the yield strength of the parent material and the weld metal respectively.

**C.3.3 Calculation of the preheat temperature**

The effects of chemical composition, characterized by the carbon equivalent,  $CET$ , the plate thickness,  $d$ , the hydrogen content of the weld metal,  $HD$ , and the heat input,  $Q$ , can be combined by the formula given below to calculate the preheat temperature,  $T_p$ .

$$T_p = T_{pCET} + T_{pd} + T_{pHD} + T_{pQ} \quad (°C) \tag{C.7}$$

The preheat temperature can also be calculated according to the following formula:

$$T_p = 697 \times CET + 160 \times \tanh(d/35) + 62 \times HD^{0,35} + (53 \times CET - 32) \times Q - 328 \quad (°C) \tag{C.8}$$

This relationship is valid for structural steels with a yield strength up to 1 000 N/mm<sup>2</sup> and

- $CET$  = 0,2 % to 0,5 %
- $d$  = 10 mm to 90 mm
- $HD$  = 1 ml/100g to 20 ml/100g
- $Q$  = 0,5 kJ/mm to 4,0 kJ/mm

According to experience, the preheat temperatures calculated with the aid of equation C.7 or C.8, respectively, apply, provided that the following conditions are fulfilled:

- a) The carbon equivalent,  $CET$ , of the parent metal exceeds that of the weld metal by at least 0,03 %. Otherwise, the calculation of the preheat temperature has to be based on the  $CET$  of the weld metal increased by 0,03 %.
- b) Single-pass fillet, tack and root welds have a minimum length of 50 mm. If the plate thickness exceeds 25 mm, tack and root passes are deposited in two layers using a mild ductile weld metal.
- c) In the case of filler pass welding, which also includes multipass fillet welds, no interpass cooling takes place as long as the weld thickness has not yet attained one third of the plate thickness. Otherwise, it is necessary to reduce the hydrogen content by means of a post-heating treatment.
- d) The welding sequence shall be selected in such a way that the strong plastic deformations of the only partly filled welds are avoided.

### C.3.4 Graphical determination of preheat temperatures

The relationship between preheat temperature,  $T_p$ , and plate thickness,  $d$ , for selected combinations of the carbon equivalent,  $CET$ , and the heat input,  $Q$ , can be seen in Figure C.7 based on equation C.8. The curves displayed in the individual diagrams apply in each case to different hydrogen concentrations of the weld metal.

If the preheat temperature is to be determined for a certain steel or a weld metal, characterized by its carbon equivalent,  $CET$ , then the diagram with the nearest possible  $CET$  and heat input has to be selected. The preheat temperature is obtained from this diagram for the plate thickness and hydrogen content in question.

If the carbon equivalent and the heat input in the diagram do not agree with the actual values, the inferred preheat temperature shall be corrected. A correction of 7,5 °C has to be made for every 0,01 % difference in the  $CET$ . The correction regarding the heat input can be obtained from Figure C.6.

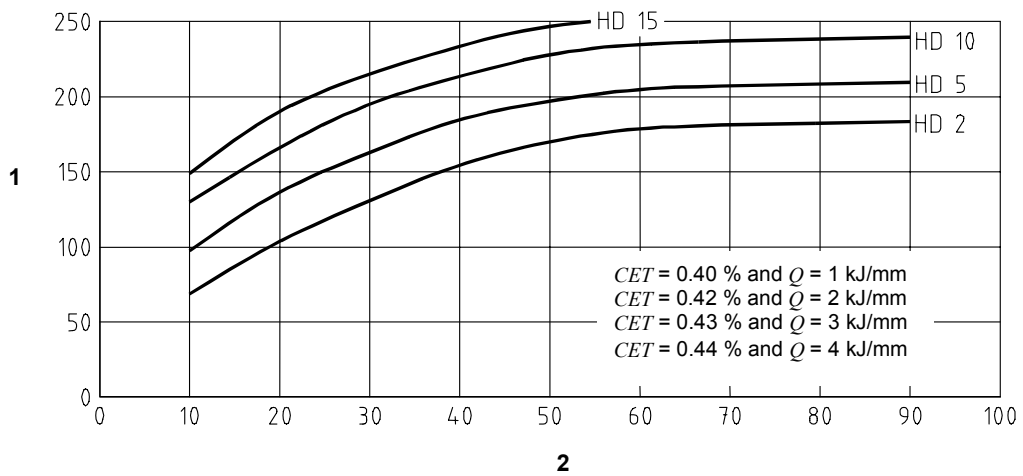
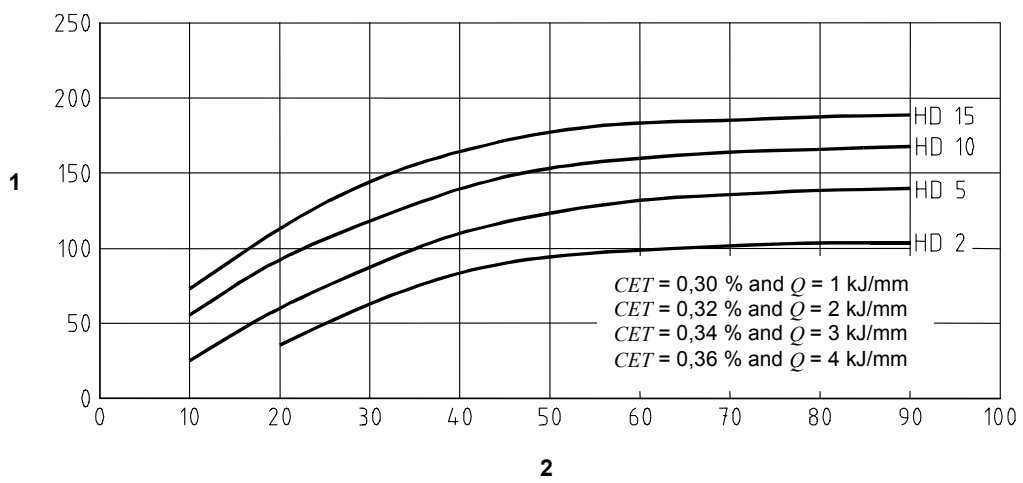
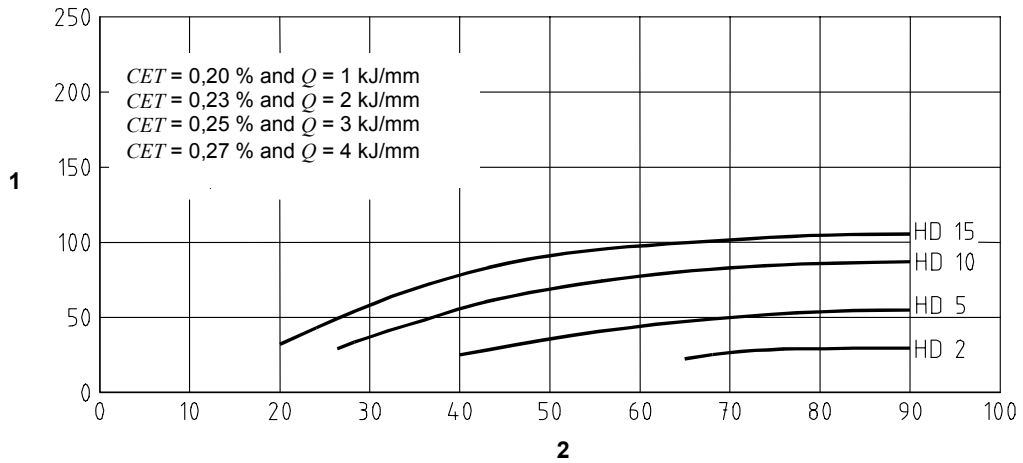

**Key**

- 1  $T_p$  in °C
- 2 Plate thickness,  $d$ , in mm

**Figure C.7 — Preheat temperature  $T_p$  as a function of plate thickness**



### C.3.5 Reduction of the hydrogen content by means of post-heating

When there is an increased risk of cold cracking, e.g. when steels with a yield strength of more than 460 N/mm<sup>2</sup> and in thicknesses greater than 30 mm are submerged-arc welded, it is advisable to reduce the hydrogen content by means of soaking, e.g. 2 h/250 °C, immediately after the welding.

### C.3.6 Welding without preheating

If multipass welding is performed, preheating may be avoided by maintaining an adequately high interpass temperature,  $T_i$ , through the use of a suitable welding sequence. The possibility of avoiding the use of preheat by maintaining a high interpass temperature depends not only on the restraint conditions of fabrication but also on the chemical composition of the steel to be welded, i.e. on the  $CET$  and the preheat temperature. It should also be noticed that the evaluation of the elements compared to carbon is remarkably different between the  $CE$  and  $CET$ . Therefore it is not advisable to convert  $CET$  values into  $CE$  values or vice versa.

Figure C.8 provides information about the plate thickness up to which it is possible, depending on the alloy content of the steel and hydrogen content of the weld metal, normally to avoid preheating by maintaining an interpass temperature of 50 °C or 100 °C by an appropriate weld sequence.

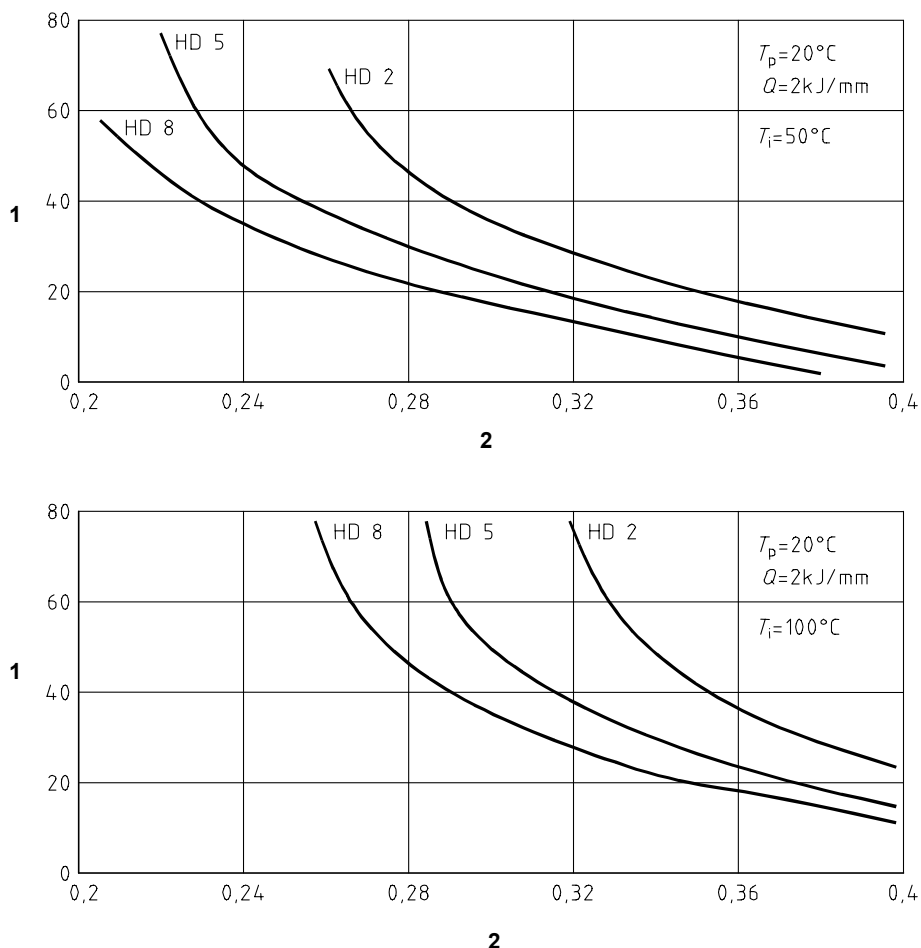

#### Key

- 1 Plate thickness,  $d$ , in mm
- 2 Carbon equivalent,  $CET$ , in %

**Figure C.8 — Limiting plate thickness for welding without preheating as a function of  $CET$  for minimum interpass temperatures  $T_i$  of 50 °C and 100 °C**

In cases where adequate preheating is impracticable, it is advisable to use austenitic or Ni-based consumables. It is then possible to avoid the use of preheating because of the comparatively low internal stress level of the welded joints and the better solubility of the hydrogen in austenitic weld metal.

## **C.4 Avoidance of hydrogen cracking for creep resisting and low temperature steels**

### **C.4.1 Parent metal**

The parent metals covered by this annex are certain creep resisting and low temperature steels, in groups 4, 5, 6 and 7 in CR ISO 15608.

### **C.4.2 Preheating and interpass temperatures**

The limits for preheating and interpass temperatures, which are applicable for plates, strips, pipes and forgings, are given in Table C.5 for creep resisting steels and in Table C.6 for low temperature steels. Alterations might be necessary with respect to special requirements, experience or applications (e.g. fillet welds, partially filled welds, nozzle weldments or site weldments). Welding procedure approval tests should be carried out even if there is no requirement in the design specification.

### **C.4.3 Choice of preheating and interpass temperature**

The minimum preheating and interpass temperature is dependent on:

- chemical composition of parent metal and weld metal;
- thickness of the weldment and type of joint;
- welding process and parameters;
- weld hydrogen scale.

The maximum interpass temperature should be as given in Tables C.5 or C.6 as appropriate.

The preheating and interpass temperatures of Tables C.5 and C.6 are valid for butt welds. Fillet welds due to their increased heat sink or partially filled welds sometimes require higher minimum temperatures. Site welding can require additional precautions. In order to avoid hydrogen cracking it is advisable:

- to hold the minimum temperature given in Tables C.5 or C.6 during the whole welding process;
- to cool down slowly;
- to perform a soaking treatment especially in cases where partially filled welds have to be cooled down;
- to consider whether to perform the post weld heat treatment immediately after welding (not in the case of the 12 % Cr-steel).

**Table C.5 — Creep resisting steels — Minimum preheating and interpass temperature**

Steel type	Thickness mm	Minimum preheating and interpass temperature			Maximum interpass temperature °C
		Scale – D Hydrogen ≤ 5 ml/100 g °C	Scale – C Hydrogen 5 ≤ 10 ml/100 g °C	Scale – A Hydrogen > 15 ml/100 g °C	
0,3 Mo	≤ 15 > 15 ≤ 30 > 30	20 75 75	20 75 100	100 100 Not applicable	250
1 Cr 0,5 Mo 1,25 Cr 0,5 Mo	≤ 15 > 15	20 100	100 150	150 Not applicable	300
0,5 Cr 0,5 Mo 0,25 V	≤ 15 > 15	100 100	150 200	Not applicable Not applicable	300
2,25 Cr 1 Mo	≤ 15 > 15	75 100	150 200	200 Not applicable	350
5 Cr 0,5 Mo 7 Cr 0,5 Mo 9 Cr 1 Mo	All	150	200	Not applicable	350
12 Cr Mo V	≤ 8 > 8	150 200 <sup>a</sup> 350 <sup>b</sup>	Not applicable Not applicable	Not applicable Not applicable	300 <sup>a</sup> 450 <sup>b</sup>
<sup>a</sup> Martensitic method where the preheat temperature is below the Martensite start ( $M_s$ ) temperature and transformation to martensite occurs during welding. <sup>b</sup> Austenitic method where the preheat temperature is above the $M_s$ and the joint shall be allowed to cool to below the $M_s$ to ensure transformation to martensite occurs before any post weld heat treatment is applied.					

**Table C.6 — Low temperature steels**

Steel type % element	Material thickness mm	Minimum preheating and interpass temperature		Maximum interpass temperature °C
		Scale – D Hydrogen ≤ 5 ml/100 g °C	Scale – C Hydrogen 5 ml ≤ 10 ml/100 g °C	
3,5 Ni	Over 10	100 <sup>a</sup>	150 <sup>a</sup>	
5,0 Ni	Over 10	100 <sup>b</sup>	Not applicable	250
5,5 Ni	Over 10	100 <sup>b</sup>	Not applicable	250
9,0 Ni	Over 10	100 <sup>b</sup>	Not applicable	250
<sup>a</sup> The values for minimum preheat given are typical of normal production using matching composition consumables. <sup>b</sup> The level of preheat specified refers to those instances where near matching consumables or autogenous welding is involved. The 5 % Ni to 9 % Ni steels are usually welded using nickel based welding consumables and preheat is not normally required up to plate thicknesses of 50 mm.				

## Annex D (informative)

### Heat affected zone toughness and hardness

#### D.1 General

This annex describes the influence of welding conditions on the temperature/time cycles occurring during welding and on the mechanical properties in the *HAZ*.

#### D.2 Fundamental behaviour of ferritic steels

The welding of ferritic steels produces a zone in which the original microstructure is changed by the heat producing the weld. Depending on the microstructure, the toughness and hardness will also be changed.

The change of the microstructure in the *HAZ* depends mainly on the chemical composition of the parent metal and on the temperature/time cycles which occur during welding.

#### D.3 Influence of the steel type

The relationship between the *HAZ* microstructure and toughness is considered to be as follows: the toughness decreases with an increase of the grain size and an increase of the fraction of hard martensitic and bainitic microstructure constituents.

In the case of C and C-Mn steels, which do not contain any element that limits the austenite grain growth during welding, frequently only strict control of the cooling time is necessary to ensure adequate toughness in the *HAZ*.

For micro-alloyed C-Mn steels, a carefully selected combination of elements that are able to form carbide and nitride precipitates, which are stable at elevated temperature, makes it possible to limit the austenite grain growth and to promote an intragranular ferrite nucleation during the transformation of the austenite. The control of the austenite grain growth depends on the type and amount of carbide and nitride forming elements. Such steels are therefore less sensitive to deterioration of toughness in the *HAZ*.

Low alloy ferritic steels, for example quenched and tempered, creep resisting and low temperature steels, as well as Ni alloyed steels, will react according to their chemical composition, but no common behaviour can be expected.

#### D.4 Influence of the welding conditions on the mechanical properties

The temperature/time cycles during welding have a significant effect on the mechanical properties of a welded joint. These are particularly influenced by the material thickness, the form of weld, the heat input during welding (see EN 1011-1:1998) and the preheating temperature. Generally, the cooling time,  $t_{8/5}$ , is chosen to characterize the temperature/time cycle of an individual weld run during welding and is the time taken, during cooling, for a weld run and its heat affected zone to pass through the temperature range from 800 °C to 500 °C (see D.5).

Increasing values of cooling time,  $t_{8/5}$ , generally lead to a reduction of the impact energy and a rise in the impact transition temperature of the *HAZ* (see Figure D.1). The extent of deterioration of the toughness depends on the steel type and its chemical composition.

The hardness in the *HAZ* decreases with an increasing cooling time,  $t_{8/5}$ , (see Figure D.2).

## D.5 Cooling time concept

If the impact energy in the *HAZ* for a particular steel is not to fall below a prescribed minimum value, then the welding conditions have to be selected in such a way that the cooling time,  $t_{8/5}$ , is not exceeded. If a prescribed minimum hardness in the *HAZ* for a particular steel is not to be exceeded, then the welding conditions have to be selected in such a way that the cooling time,  $t_{8/5}$ , does not fall below a certain value. For this approach, the curves for impact energy, impact transition temperature and hardness as a function of the  $t_{8/5}$  should be known for the relevant steel.

For high strength unalloyed and low alloy ferritic steels, the appropriate cooling times,  $t_{8/5}$ , of the filler and capping passes generally lie within the range 10 s to 25 s. There is nothing to prevent welds being made in these steels with other cooling times,  $t_{8/5}$ , provided that for each individual case appropriate checks have been made on the basis of a welding procedure test according to EN 288-3:1997 or pre-production tests according to EN 288-8:1995 and provided that the structural requirements for the component are satisfied.

If no curves for the relationship of impact energy, impact transition temperature and hardness as a function of  $t_{8/5}$  are available, welding procedure tests in accordance with EN 288-3:1997 or EN 288-8:1995 are recommended.

## D.6 Calculation of cooling time

The relationship between the welding conditions and the cooling time can be described by equations, but a differentiation shall be made between two- and three-dimensional heat flow (see Figures D.3 and D.4).

Figure D.4 is a diagram which provides information regarding the relationship between the transition thickness,  $d_t$ , heat input,  $Q$ , and preheat temperature,  $T_p$ , for any type of weld and any welding process. This diagram indicates whether the heat flow is two- or three-dimensional for a particular combination of material thickness, heat input and preheat temperature.

When the heat flow is three-dimensional and the cooling time is independent of the material thickness it is calculated using equation D.1.

$$t_{8/5} = \frac{Q}{2\pi\lambda} \times \left( \frac{1}{500 - T_o} - \frac{1}{800 - T_o} \right) \quad (\text{D.1})$$

For unalloyed and low alloyed steels the equation D.1 changes to approximately (see equation D.2) (using the appropriate shape factors,  $F_3$ , given in Table D.1):

$$t_{8/5} = (6700 - 5T_o) \times Q \times \left( \frac{1}{500 - T_o} - \frac{1}{800 - T_o} \right) \times F_3 \quad (\text{D.2})$$

When the heat flow is two-dimensional and the cooling time is dependent upon the material thickness it is calculated using equation D.3.

$$t_{8/5} = \frac{Q^2}{4\pi\lambda\rho cd^2} \times \left( \frac{1}{(500 - T_o)^2} - \frac{1}{(800 - T_o)^2} \right) \quad (\text{D.3})$$

For unalloyed and low alloyed steels the equation D.3 changes to approximately (see equation D.4) (using the appropriate shape factors,  $F_2$ , given in Table D.1):

$$t_{8/5} = (4300 - 4,3 T_o) \times 10^5 \times \frac{Q^2}{d^2} \times \left[ \left( \frac{1}{500 - T_o} \right)^2 - \left( \frac{1}{800 - T_o} \right)^2 \right] \times F_2 \quad (\text{D.4})$$

whereby:  $Q = \varepsilon \times E = \varepsilon \times U \times (I / v) \times 1\,000$  (kJ/mm)

$U$  in Volt

$I$  in Ampere

$v$  in mm/sec

$\varepsilon$  thermal efficiency of the welding procedure

UP (121)  $\varepsilon = 1,0$

E (111)  $\varepsilon = 0,85$

MAG (135)  $\varepsilon = 0,85$

**Table D.1 — Influence of the form of weld on the cooling time,  $t_{8/5}$**

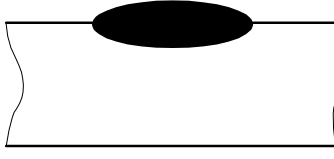
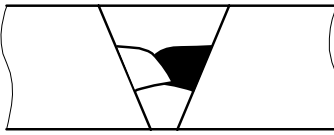
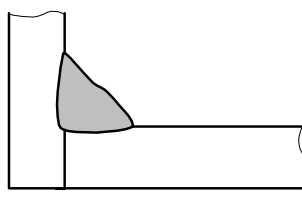
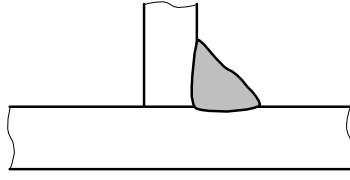
Form of weld		Shape factor	
		$F_2$ two-dimensional heat flow	$F_3$ three-dimensional heat flow
Run on plate		1	1
Between runs in butt welds		0,9	0,9
Single run fillet weld on a corner-joint		0,9 to 0,67	0,67
Single run fillet weld on a T-joint		0,45 to 0,67	0,67

## D.7 Diagrams for determining the cooling time $t_{8/5}$

The cooling time  $t_{8/5}$  for a prescribed heat input,  $Q$ , or the heat input for a prescribed cooling time can also be determined on the basis of Figures D.5 and D.6, having first established the type of heat flow using Figure D.4.

For three-dimensional heat flow, the relationship between the cooling time,  $t_{8/5}$ , the heat input,  $Q$ , and the preheat temperature,  $T_p$ , is given, in the case of runs on a plate, in Figure D.5 of which equation D.1 forms the basis. If this diagram is applied to other types of welds, consideration should be given to the corresponding shape factor,  $F_3$ . If the cooling time is to be determined for a particular combination of heat input and preheat temperature then the heat input should first be multiplied by  $F_3$ . If, however, the heat input is conversely taken from the diagram for a prescribed cooling time and preheat temperature, then it should be divided by  $F_3$ .

Information regarding the relationship between the cooling time and  $Q_{t_0}$  at two-dimensional heat flow is given for different material thicknesses in Figure D.6 of which equation D.2 forms the basis. If these diagrams are to be applied to other types of weld, consideration should be given to the corresponding shape factor,  $F_2$ . For example, if the cooling time is to be determined for a particular combination of heat input and preheat temperature, then the heat input should first be multiplied by  $(F_2)^{1/2}$ . If, however, the heat input is conversely taken from the diagram for a prescribed cooling time and preheat temperature, then it should be divided by  $(F_2)^{1/2}$ .

If in the case of two-dimensional heat flow, the plate thickness in question does not correspond exactly with those shown in Figure D.6, the diagram closest to the actual plate thickness is used. The cooling time is then corrected in accordance with the plate thickness ratio. To do this the cooling time taken from the diagram is multiplied by the square of the plate thickness taken from the diagram and divided by the square of the plate thickness in question.

## D.8 Measurement of cooling time

To measure the cooling time of a weld, a thermocouple is normally immersed in the weld metal while it is still molten and the temperature/time cycle is recorded. From the  $T/t$  curve the cooling time is derived.

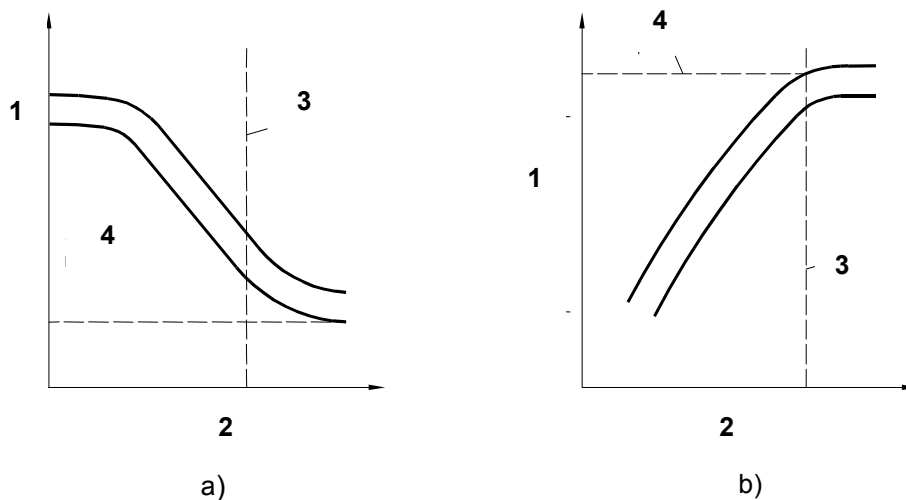

### Key

- 1 Impact energy
- 2 Cooling time,  $t_{8/5}$
- 3 Upper limiting value of applicable cooling time,  $t_{8/5}$
- 4 Admissible minimum impact energy value

### Key

- 1 Impact transition temperature
- 2 Cooling time,  $t_{8/5}$
- 3 Upper limiting value of applicable cooling time,  $t_{8/5}$
- 4 Admissible maximum impact transition temperature value

**Figure D.1 — Influence of the welding conditions on  
a) the notch toughness and b) the transition temperature  $T_t$  in the HAZ**

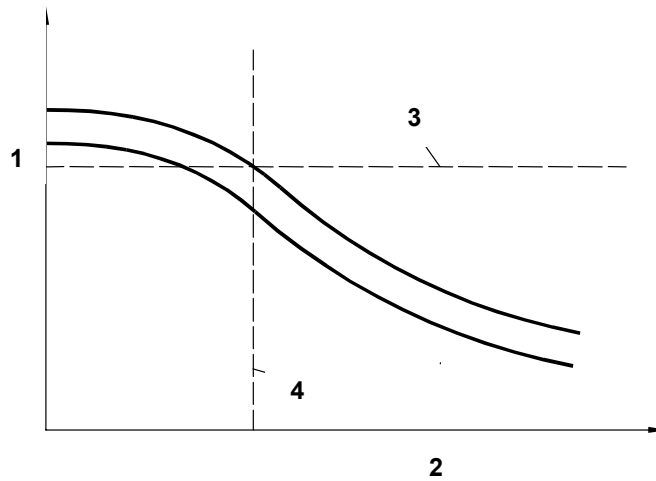

**Key**

- 1 Hardness
- 2 Cooling time,  $t_{8/5}$
- 3 Admissible maximum hardness
- 4 Lower limiting value of applicable cooling time,  $t_{8/5}$

**Figure D.2 — Influence of the welding conditions on the maximum hardness in the HAZ**

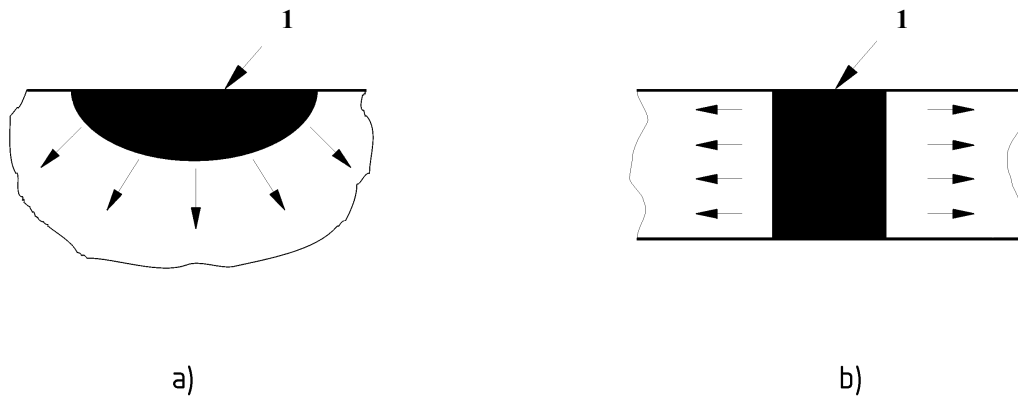

**Key**

- 1 Run
- a) Three-dimensional heat flow. Relatively thick plates; plate thickness does not affect cooling time.
- b) Two-dimensional heat flow. Relatively thin plates; plate thickness has a decisive influence on cooling time.

**Figure D.3 — Types of heat flow during welding**



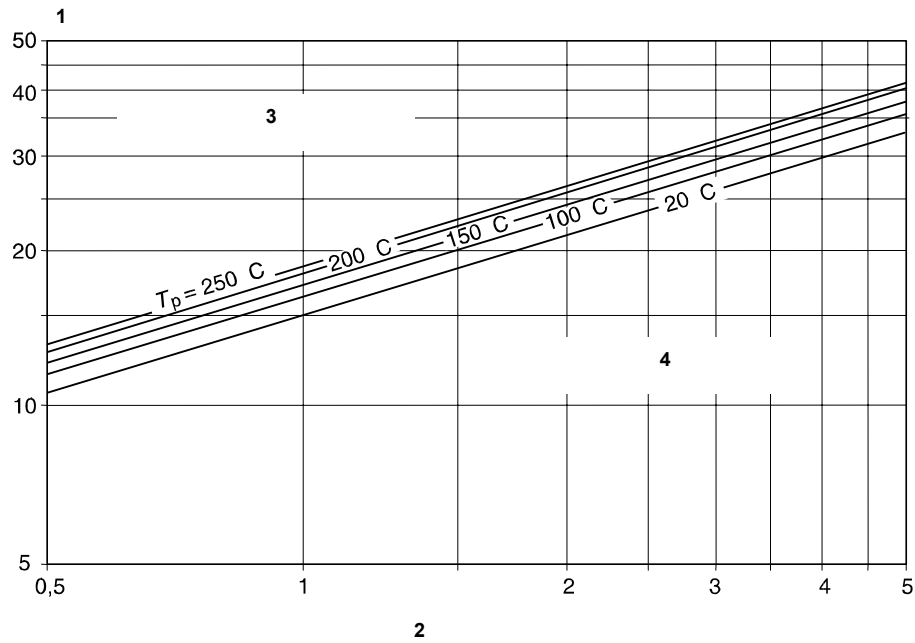

**Key**

- 1 Transition thickness,  $d_t$  (mm)
- 2 Heat input (kJ/mm)
- 3 Three-dimensional heat flow
- 4 Two-dimensional heat flow

**Figure D.4 — Transition plate thickness from three-dimensional to two-dimensional heat flow as a function of heat input for different preheat temperatures**

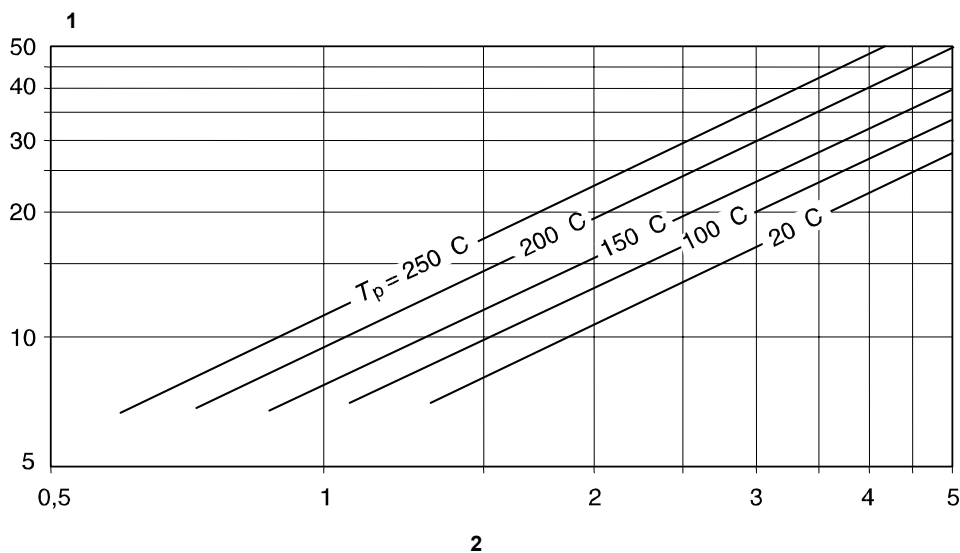

**Key**

- 1 Cooling time,  $t_{8/5}$  (s)
- 2 Heat input (kJ/mm)

**Figure D.5 — Cooling time  $t_{8/5}$  for three-dimensional heat flow as a function of heat input for different preheat temperatures**

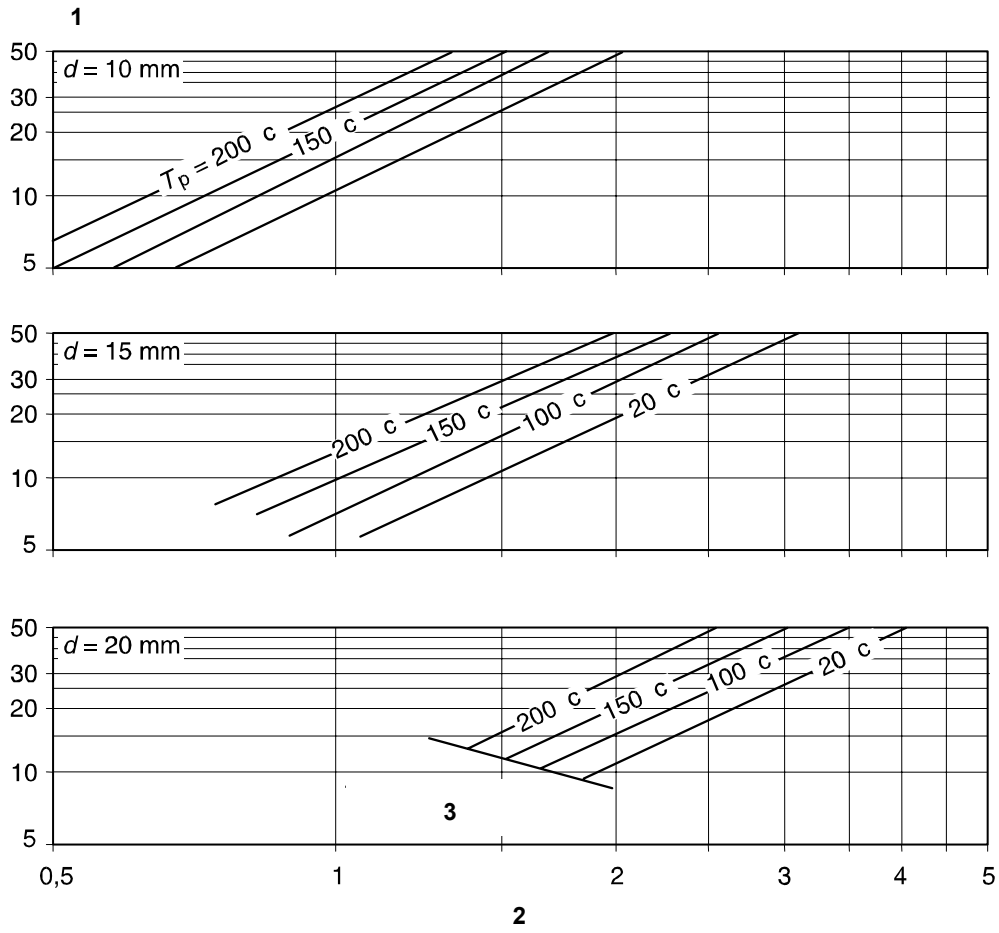

**Key**

- 1 Cooling time,  $t_{8/5}$  (s)
- 2 Heat input (kJ/mm)
- 3 Three-dimensional heat flow

**Figure D.6 — Cooling time  $t_{8/5}$  for two-dimensional heat flow as a function of heat input for different preheat temperatures**

## Annex E (informative)

### Avoidance of solidification cracking

Solidification cracking of the weld metal is usually found as centreline cracking. It is more often found in root runs and, although frequently open at the surface and visible after deslagging, can be just below the surface and covered by up to 0,5 mm of sound metal. Solidification cracks can be deep and can seriously reduce the efficiency of a joint. When welding carbon manganese steels, this type of cracking is most commonly found in submerged-arc welds, rarely with manual metal arc welding but it can sometimes be a problem with gas-shielded and self-shielded processes.

Solidification cracking is associated with impurities, particularly sulphur and phosphorus, and is promoted by carbon picked up from the parent metal at high dilution levels while manganese reduces the risk of cracking.

Impurity levels and crack susceptibilities are usually greatest in weld runs of high dilution, e.g. root runs of butt welds. To minimize the risk of cracking, consumables are preferred with low carbon and impurity levels and relatively high manganese contents. A reduction in welding speed can be helpful in overcoming cracking.

The solidification crack susceptibility of weld metal is affected by both its composition and weld run geometry (depth/width ratio). The chemical composition of weld metal is determined by the composition of the filler material and the parent metal and the degree of dilution. The degree of dilution, as well as weld run geometry, both depend on the joint geometry (angle of bevel, root face and gap) and the welding parameters (current and voltage).

For submerged-arc welds a formula has been developed for carbon and carbon manganese steels in which the solidification crack susceptibility in arbitrary units known as units of crack susceptibility (*UCS*) has been related to the composition of the weld metal [in % (m/m)]. Although developed for submerged-arc welding, the use of the formula can be helpful in assessing the risk of solidification cracking for other welding processes and other ferritic steels. The formula is as follows:

$$UCS = 230 C + 190 S + 75 P + 45 Nb - 12,3 Si - 5,4 Mn - 1$$

This formula is valid for the weld metal compositions given in Table E.1.

Alloying elements and impurities in the weld metal up to the limits given in Table E.2 do not exert a marked effect on values of *UCS*.

Values of less than 10 *UCS* indicate a high resistance to cracking and above 30 a low resistance. Within these approximate limits the risk of cracking is higher in weld runs with a high depth/width ratio, made at high welding speeds or where fit-up is near the maximum allowable.

**Table E.1 — Validity of the UCS formula for solidification cracking**

Element	Content in %
C	0,03 <sup>a</sup> to 0,23
S	0,010 to 0,050
P	0,010 to 0,045
Si	0,15 to 0,65
Mn	0,45 to 1,6
Nb	0 to 0,07
<sup>a</sup> Contents of less than 0,08 % to be taken as equal to 0,08 %.	

**Table E.2 — Limits of alloying elements and impurities on validity of the *UCS* formula**

Element	Content max. in %
Ni	1
Cr	0,5
Mo	0,4
V	0,07
Cu	0,3
Ti	0,02
Al	0,03
B	0,002
Pb	0,01
Co	0,03

Although up to 1 % nickel has no effect on *UCS* values, higher levels of nickel can increase the susceptibility to solidification cracking.

For fillet weld runs having a depth/width ratio of about 1,0, *UCS* values of 20 and above indicate a risk of cracking whilst for butt welds the values of about 25 *UCS* are critical. Decreasing the depth/width ratio from 1,0 to 0,8 in fillet welds can increase the allowable *UCS* by about 9. However, very low depth/width ratios, such as are obtained when penetration into the root is not achieved, also promote cracking.

## **Annex F** **(informative)**

### **Avoidance of lamellar tearing**

#### **F.1 General**

In certain types of joint, where the welding contraction strains act in the through-thickness (transverse) direction of a plate, lamellar tearing may occur. Lamellar tearing is a parent metal phenomenon which occurs mainly in plate material. The risk of cracking is influenced by two factors: plate susceptibility and strain across the joint. With very susceptible plate material, tearing can occur even if strains are low, i.e. in a joint of low restraint. More resistant materials might not tear unless used in situations which impose very high through-thickness strains.

Lamellar tearing occurs mainly during production and not during service. In the latter case periodic loads or impact loads are the main reasons.

#### **F.2 Plate susceptibility**

Since lamellar tearing occurs when the non-metallic inclusions in a plate link up under the influence of welding strains, plate susceptibility is controlled by the quantity and distribution of the inclusions. At present there is no reliable non-destructive technique for detecting these inclusions. The short transverse tensile test can be used to assess susceptibility (see EN 10164) and the short transverse reduction of area (STRA) has been correlated with the incidence of lamellar tearing in different types of fabrication (see Figure F.1). In the case of low oxygen steels (aluminium treated or vacuum degassed types) sulphur content has been found to be a useful guide to the inclusion content and thus to the STRA. Figure F.2 gives the likely lowest and highest values of STRA to be expected in aluminium treated steel of a given sulphur content. The data is for plates 12,5 mm to 50 mm thick but it should be noted that the relationship of STRA (in %) to sulphur content (in %) is to some extent thickness dependent.

Steel giving STRA values of over 20 % are considered lamellar tearing resistant and materials with guaranteed STRA values are available (see EN 10164). These are usually aluminium treated steels with low sulphur content, although additions of rare earth or calcium compounds can also be made both to reduce the inclusion content and to alter favourably the inclusion shapes.

#### **F.3 Joint configuration, fabrication and through-thickness strains**

The risk of lamellar tearing for a given steel increases with through-thickness strain which is usually high in joints of high tensile restraint. However, tearing can also occur if the bending restraint is low since angular distortion can increase the strain in weld root or toe areas (see Figure F.3). In some cases, design changes can be made which reduce the through-thickness strain. Examples of the types of detail and joint configuration in which lamellar tearing is possible are shown in Figure F.4, typical locations of the cracks being illustrated. If the plate susceptibility is considered to be high, susceptible joints and details should be modified or avoided.

The following general statements should be noted:

- a) For a given weld strength, joints should be made such that the attachment area is enlarged (see Figure F.5).

- b) The shrinkage stresses should be minimized:
  - by reducing the volume of weld metal;
  - by welding with the minimum number of runs;
  - by using a buttering layer sequence (see Figure F.6);
  - by a balanced layer sequence in symmetric welds.
- c) The weldment should be made such that as much of the through-thickness of the rolled plate as possible is in contact with the weld metal (see Figures F.7 to F.9).
- d) The weldment should be made such that restraint in the through-thickness direction is minimized.
- e) The weldment can be made less sensitive to lamellar tearing by buttering with a low strength material (see Figure F.9).

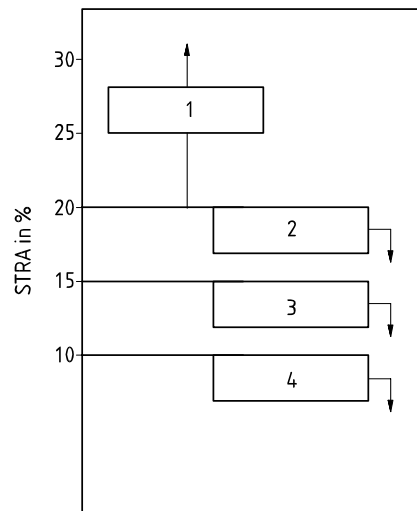

**Key**

- 1 Probable freedom from tearing in any type of joint
- 2 Some risk in highly restrained joints, e.g. node joints
- 3 Some risk in moderately restrained joints, e.g. box columns
- 4 Some risk in lightly restrained T-joints, e.g. I-beams

**Figure F.1 — Suggested STRA values appropriate to the risk of lamellar tearing in joints of differing restraint**

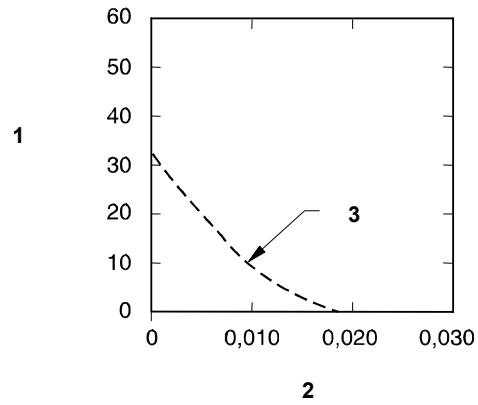

**Key**

- 1 STRA %
- 2 Sulphur content % (m/m)
- 3 Lower bound

**Figure F.2 — STRA as a function of sulphur content for plates 12,5 mm to 50 mm thick (inclusive)**

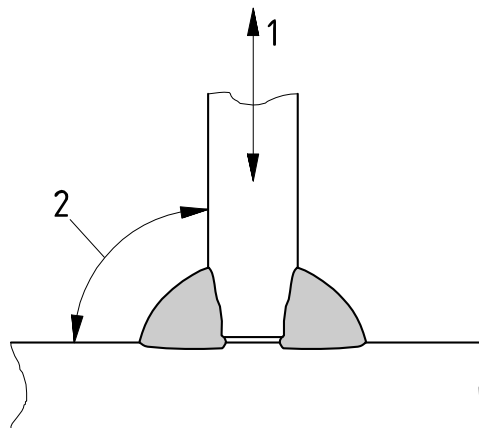

**Key**

- 1 Tensile restraint
- 2 Bending restraint

**Figure F.3 — Example of restraints in T-joints with fillet welds**

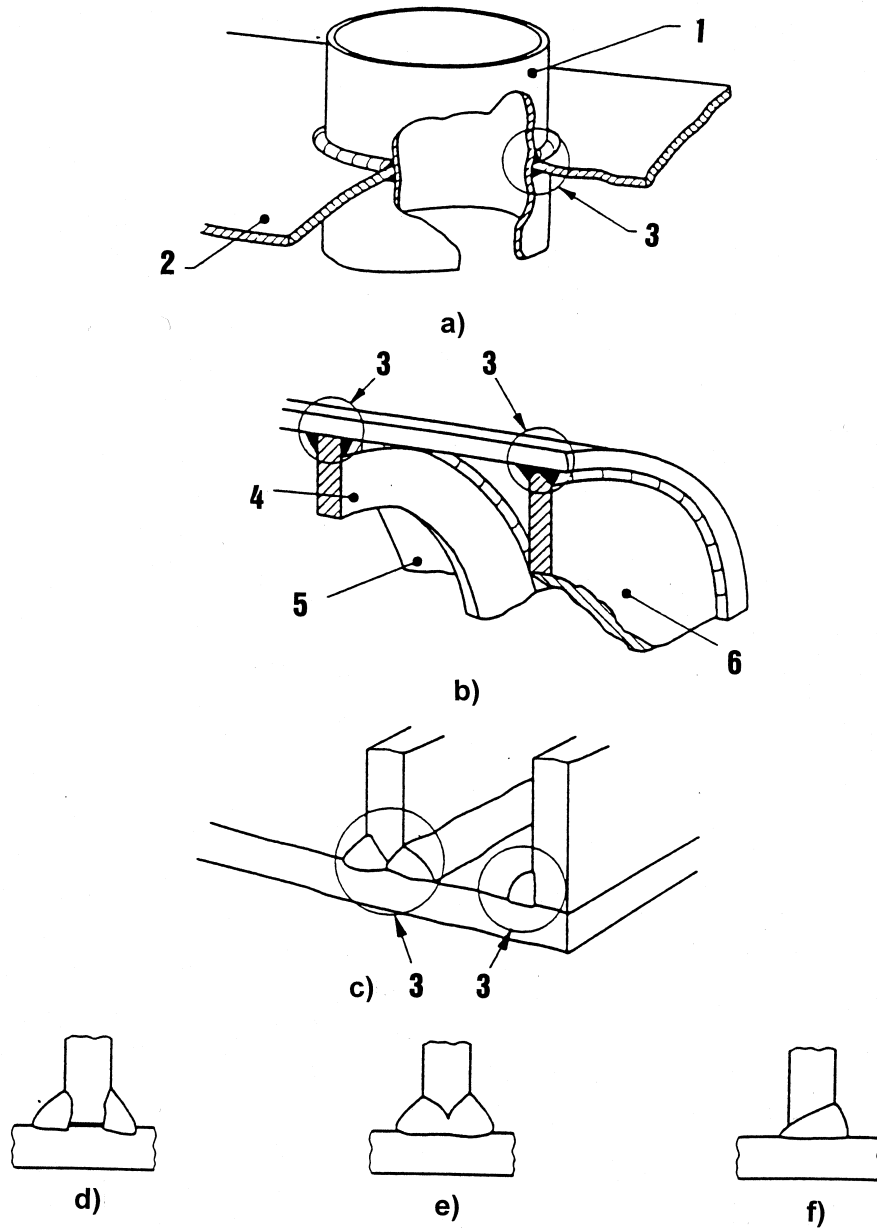

**Key**

- 1 Nozzle fabricated from rolled plate
  - 2 Rigid plate
  - 3 Critical joint
  - 4 Circumferential stiffener
  - 5 Cylindrical vessel
  - 6 Rigid ends
- 
- a) Nozzle through a rigid plate
  - b) Stiffener or rigid end in a cylindrical fabrication
  - c) Rigid box section
  - d) T-joint with fillet welds
  - e) T-joint with compound butt and fillet welds
  - f) Corner joint with butt weld

**Figure F.4 — Details and joint configurations in which lamellar tearing is possible when fabricating large structures with a high degree of restraint**



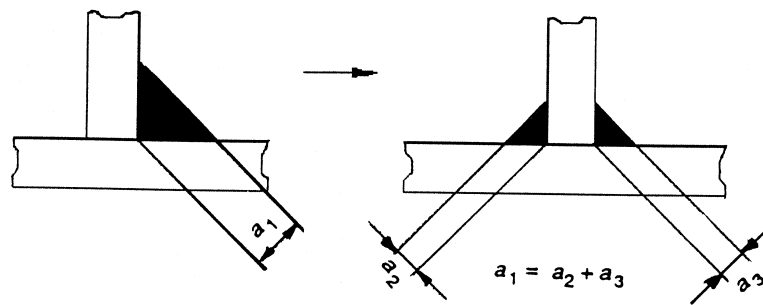

Figure F.5 — Reduction of sensitivity to lamellar tearing by enlargement of the fusion face

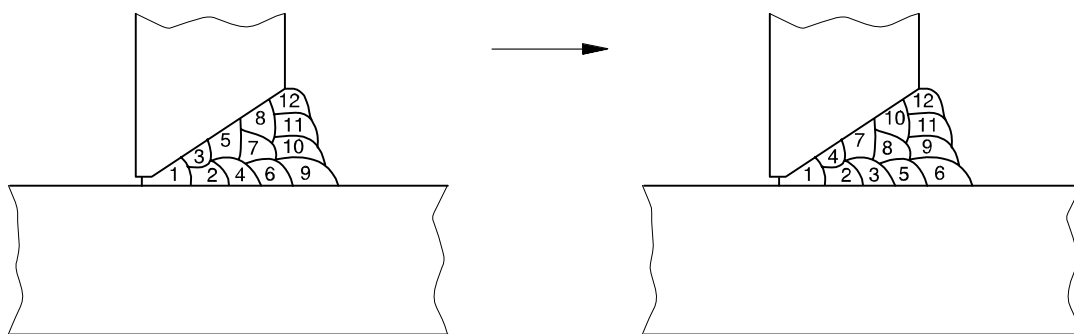
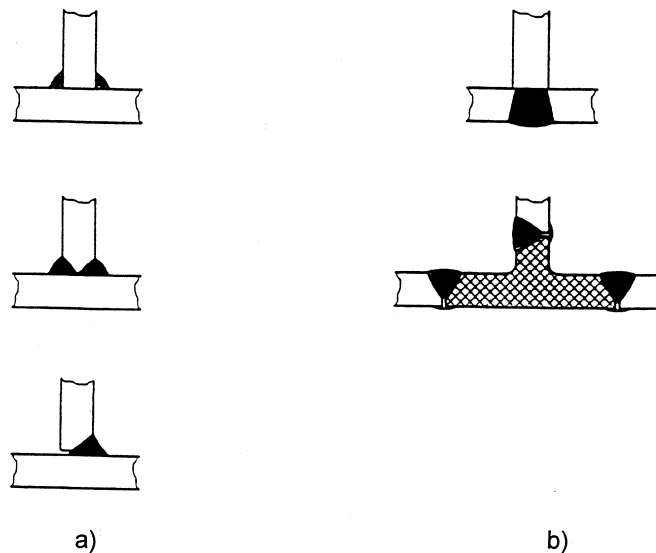

Figure F.6 — Reduction of sensitivity to lamellar tearing by layer sequence



**Key**

- a) Sensitive
- b) Not sensitive

Figure F.7 — Reduction of sensitivity to lamellar tearing by welding the full thickness of the rolled plate

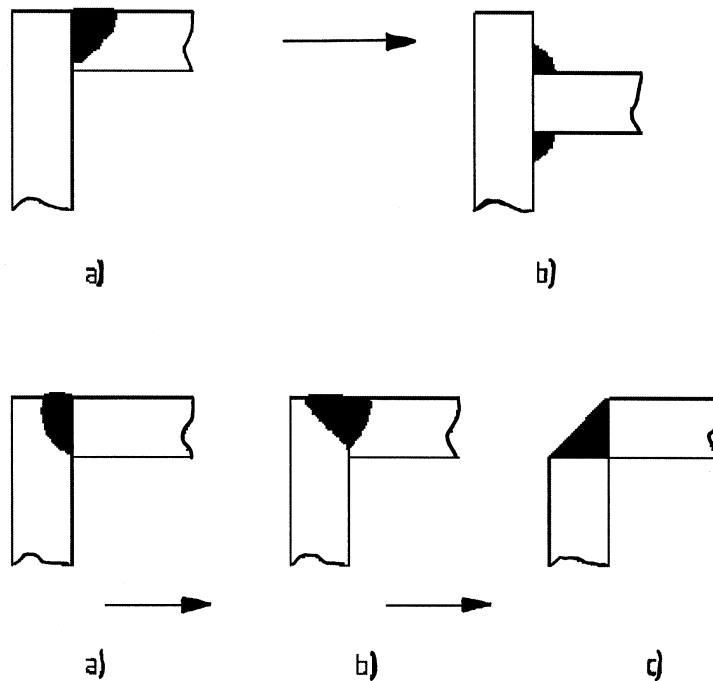

**Key**

- a) Sensitive
- b) Less sensitive
- c) Not sensitive

**Figure F.8 — Reduction of sensitivity to lamellar tearing**

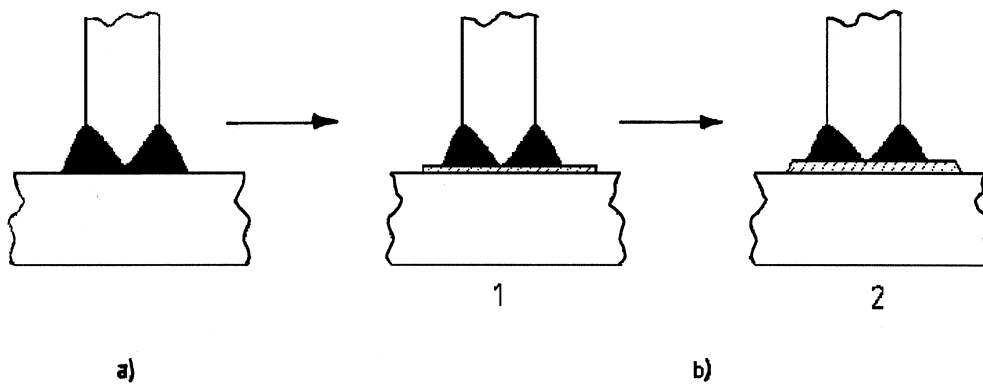

**Key**

- 1 Single layer buttering
- 2 Double layer buttering

- a) Sensitive
- b) Less sensitive

**Figure F.9 — Reduction of sensitivity to lamellar tearing by buttering preferably with low strength high ductility weld metal**

## **Annex G** **(informative)**

### **References in the annexes**

EN 288-3:1997, *Specification and approval of welding procedures for metallic materials — Part 3: Welding procedure tests for the arc welding of steels.*

EN 288-8:1995, *Specification and approval of welding procedures for metallic materials — Part 8: Approval by a pre-production welding test.*

EN 499, *Welding consumables — Covered electrodes for manual metal arc welding of non alloy and fine grain steels — Classification.*

EN 1011-1:1998, *Welding — Recommendations for welding of metallic materials — Part 1: General guidance for arc welding.*

EN 1708-1:1999, *Welding — Basic weld joint details in steel — Part 1: Pressurized components.*

EN 1708-2, *Welding — Basic weld joint details in steel — Part 2: None internal pressurized components.*

EN 10164, *Steel products with improved deformation properties perpendicular to the surface of the product — Technical delivery conditions.*

ISO 3690:1983, *Welding — Determination of hydrogen in deposited weld metal arising from the use of covered electrodes for welding mild and low alloy steels.*

CR ISO 15608, *Welding — Guidelines for a metallic material grouping system (ISO/TR 15608:2000).*

## **Bibliography**

Hart P.H.M, Pargetter R.J and Wright M.D, *Comparison of methods for determining weld procedures for the avoidance of hydrogen cracking in fabrication*. Document IX-1602-90. IIW.

Uwer D and Hoehne H, *Determination of the lowest preheat temperature for cold cracking / safe welding of steels*. Document IX-1631-91. IIW.



---

---

## BSI — British Standards Institution

BSI is the independent national body responsible for preparing British Standards. It presents the UK view on standards in Europe and at the international level. It is incorporated by Royal Charter.

### Revisions

British Standards are updated by amendment or revision. Users of British Standards should make sure that they possess the latest amendments or editions.

It is the constant aim of BSI to improve the quality of our products and services. We would be grateful if anyone finding an inaccuracy or ambiguity while using this British Standard would inform the Secretary of the technical committee responsible, the identity of which can be found on the inside front cover. Tel: +44 (0)20 8996 9000. Fax: +44 (0)20 8996 7400.

BSI offers members an individual updating service called PLUS which ensures that subscribers automatically receive the latest editions of standards.

### Buying standards

Orders for all BSI, international and foreign standards publications should be addressed to Customer Services. Tel: +44 (0)20 8996 9001. Fax: +44 (0)20 8996 7001. Email: [orders@bsi-global.com](mailto:orders@bsi-global.com). Standards are also available from the BSI website at <http://www.bsi-global.com>.

In response to orders for international standards, it is BSI policy to supply the BSI implementation of those that have been published as British Standards, unless otherwise requested.

### Information on standards

BSI provides a wide range of information on national, European and international standards through its Library and its Technical Help to Exporters Service. Various BSI electronic information services are also available which give details on all its products and services. Contact the Information Centre. Tel: +44 (0)20 8996 7111. Fax: +44 (0)20 8996 7048. Email: [info@bsi-global.com](mailto:info@bsi-global.com).

Subscribing members of BSI are kept up to date with standards developments and receive substantial discounts on the purchase price of standards. For details of these and other benefits contact Membership Administration. Tel: +44 (0)20 8996 7002. Fax: +44 (0)20 8996 7001. Email: [membership@bsi-global.com](mailto:membership@bsi-global.com).

Information regarding online access to British Standards via British Standards Online can be found at <http://www.bsi-global.com/bsonline>.

Further information about BSI is available on the BSI website at <http://www.bsi-global.com>.

### Copyright

Copyright subsists in all BSI publications. BSI also holds the copyright, in the UK, of the publications of the international standardization bodies. Except as permitted under the Copyright, Designs and Patents Act 1988 no extract may be reproduced, stored in a retrieval system or transmitted in any form or by any means – electronic, photocopying, recording or otherwise – without prior written permission from BSI.

This does not preclude the free use, in the course of implementing the standard, of necessary details such as symbols, and size, type or grade designations. If these details are to be used for any other purpose than implementation then the prior written permission of BSI must be obtained.

Details and advice can be obtained from the Copyright & Licensing Manager. Tel: +44 (0)20 8996 7070. Fax: +44 (0)20 8996 7553. Email: [copyright@bsi-global.com](mailto:copyright@bsi-global.com).