



# Trabon Divider Valves

312497A

*- For series progressive, oil and grease lubrication -*



### Important Safety Instructions

Read all warnings and instructions in this manual. Keep these instructions.

## Models/Maximum Pressure

**Table 1: Maximum Pressure Lube Points**





Divider Type	Maximum Operating Pressure kPSI (MPa, bar)	Maximum Sections
MD	3.0 (20.7, 207)	2
MJ	2.0 (13.8, 138)	8
MJSS	2.0 (13.8, 138)	8
MSP	3.5 (24.1, 241)	8
MHP	6.0 (41.4, 414)	8
MHH	7.5 (51.7, 517)	8
ZMSP	3.0 (20.7, 207)	6
MX	3.0 (20.7, 207)	10
MXP	3.0 (20.7, 207)	10
MGO	See Table 2	11

**Table 2: MGO Series-Flo Divider Maximum Operating Pressures**

Maximum Operating Pressure kPSI (MPa, bar)	Number of Sections
6.0 (41.4, 414)	3 to 7
5.5 (37.9, 379)	8
4.0 (27.6, 276)	9
4.5 (31.0, 310)	10
4.0 (27.6, 276)	11

# Warnings

The following Warnings are for the setup, use, grounding, maintenance and repair of this equipment. The exclamation point symbol alerts you to a general warning and hazard symbols refer to procedure-specific risks. Refer back to these Warnings. Additional, product-specific warnings may be found throughout the body of this manual where applicable.

 <b>WARNING</b>	
	<p><b>EQUIPMENT MISUSE HAZARD</b></p> <p>Misuse can cause death or serious injury.</p> <ul style="list-style-type: none"> <li>• Do not operate the unit when fatigued or under the influence of drugs or alcohol.</li> <li>• Do not exceed the maximum working pressure or temperature rating of the lowest rated system component. See <b>Technical Data</b> in all equipment manuals.</li> <li>• Use fluids and solvents that are compatible with equipment wetted parts. See <b>Technical Data</b> in all equipment manuals. Read fluid and solvent manufacturer's warnings. For complete information about your material, request MSDS forms from distributor or retailer.</li> <li>• Check equipment daily. Repair or replace worn or damaged parts immediately with genuine manufacturer's replacement parts only.</li> <li>• Do not alter or modify equipment.</li> <li>• Use equipment only for its intended purpose. Call your distributor for information.</li> <li>• Keep children and animals away from work area.</li> <li>• Comply with all applicable safety regulations.</li> </ul>
 	<p><b>SKIN INJECTION HAZARD</b></p> <p>High-pressure fluid from dispense valve, hose leaks, or ruptured components will pierce skin. This may look like just a cut, but it is a serious injury that can result in amputation. <b>Get immediate surgical treatment.</b></p> <ul style="list-style-type: none"> <li>• Do not point dispense valve at anyone or at any part of the body.</li> <li>• Do not put your hand over the end of the dispense nozzle.</li> <li>• Do not stop or deflect leaks with your hand, body, glove, or rag.</li> <li>• Follow <b>Pressure Relief Procedure</b> in this manual, when you stop spraying and before cleaning, checking, or servicing equipment.</li> </ul>

## Pressure Relief Procedure



Follow this **Pressure Relief Procedure** whenever you are instructed to relieve pressure or check or service equipment.

1. Using a wrench, slowly loosen inlet nut.
2. Then, using a wrench, slowly loosen each port nut.

## Setup

The divider valve should be ready to install in your system. It has been factory-tested and should not require any additional modification.

1. Install the divider valve in your system.
2. Torque. See Table 1, page 12.

As long as lubricant is supplied under pressure to the inlet section of the divider assembly, valves sections will continue to operate in a progressive manner. Divider assemblies always follow a constant discharge pattern. Whenever lubricant flow ceases, the valving pistons will stop. When flow resumes, it will start again at the same point in the discharge cycle.

## Component Identification

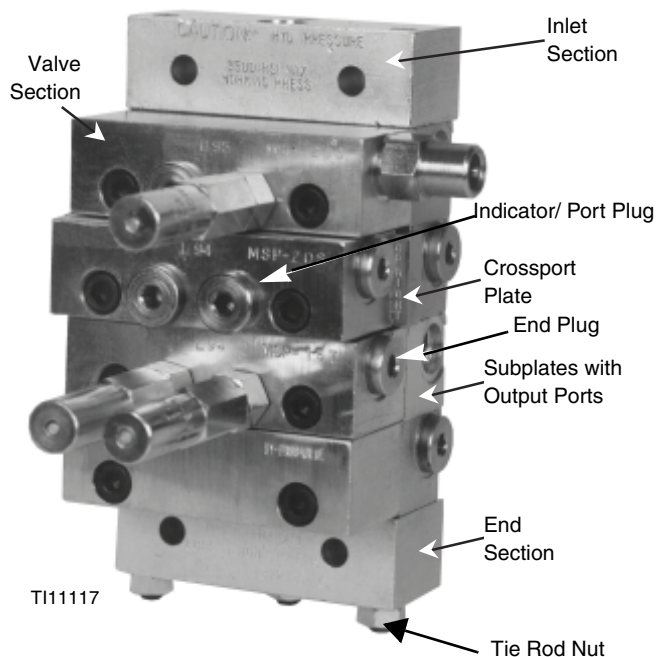

**FIG. 1**

**Table 3: Typical Divider Valve Combinations**

MASTER	SECONDARY	TYPE OF APPLICATION
MJ	MD	Machine tools, Printing, Wire Forging & Packaging Machinery
MSP	MJ, MSP	Machine tools, Textile, Glass & Can Machinery, Mobile Equipment
MX, MXP	MX, MXP, MSP	Cranes, Presses, Steel Mills, etc.
MGO	MX	Levellers, Shears, Conveyors, etc.

## Divider Valves

A Series-Flo type divider valve is a manifold proportioning device consisting of an inlet and end section plus a minimum of three valve sections. The divider valve is manifolded together with tie rods and nuts. A master divider valve is the first divider valve downstream from the lube pump. A secondary divider valve is any divider valve receiving lubricant from the master divider valve.

## Valve Sections (MSP, MHP, MHH, ZMSP and MXP modular-type, divider valves, only)

Valve sections (three or more required per manifold) contain a piston specially fitted to that section, built in outlet check valves and various passageways that, working with the piston, meters and valves the flow of lubricant (FIG. 2).

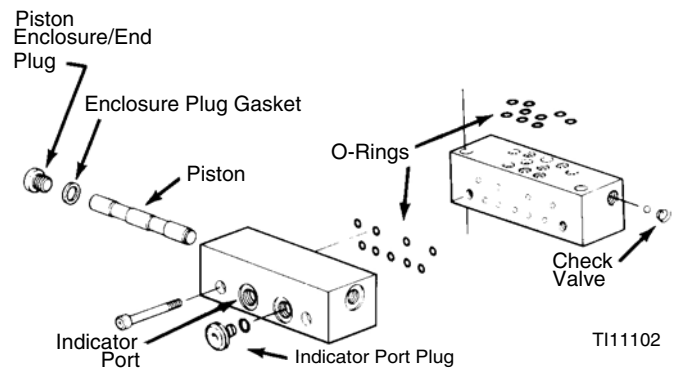

**FIG. 2**

Valve sections may be manufactured to require one or two lube outlets. Stamping located on the face of each section indicates:

- the style of divider valve section, i.e., MSP, MX, etc.,
- the discharge per piston stroke expressed in thousandths of cubic inches ( $35 = .035 \text{ in}^3$ ) and,
- the number of lube outlets required (S = single, one outlet only; T = twin, two lube outlets required).

## Prefilling Lubricant Distributor Lines

Follow the following procedure *exactly* as written, in the order written.

### CAUTION

- The initial startup and operation is the most critical operating period for a newly installed machine in terms of potential for being damaged by unremoved/unfiltered lubricant contaminants and lack of adequate lubrication. Proper prefilling of lubrication system ensures that lubricant is immediately available to every lube point during machine startup, protecting them from damage.
- Use only clean oil filtered to the SAE -recommended cleanliness level of ISO 18/14 (ISO Standard 4406) when prefilling a system. The manufacturers of the machine tool and its component bearings should be consulted to ensure that the ISO 18/14 cleanliness level is adequate.

## 1. Filling Secondary-to-Lube Point Lines

Refer to FIG. 3. when performing this procedure

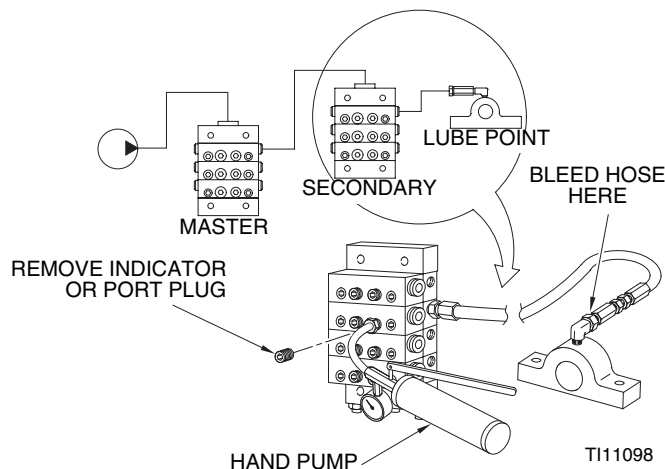

FIG. 3

1. Remove port plugs or performance indicators from all of the indicator ports on front of secondary divider valves.
2. Connect a hand pump filled with clean, filtered lubricant to the indicator port closest to the first line to be filled that corresponds to the output port that is feeding the line to be filled.
3. In order to verify when lubricant is flowing and has reached the end of the lube line, loosen the connector at the lube point of the line that is to be filled.
4. Stroke the hand pump until air-free lubricant is observed flowing from the end of the lube line.
5. Tighten the lube line connector at the lube point, but do not replace the port plugs or performance indicators into the ports on the front of the working section.

6. Repeat steps 1-5 for each of the other lube lines connected to the other outlet ports in the secondary divider valve assembly and for any other secondary divider assemblies in the system.

Do not replace any of the performance indicators or port plugs removed in Step 1 until the line-filling procedure described in Section 2 (Filling Master -to-Secondary Lube Lines) has been completed.

## 2. Filling Master-to-Secondary Lube Lines

Refer to FIG. 4. when performing this procedure.

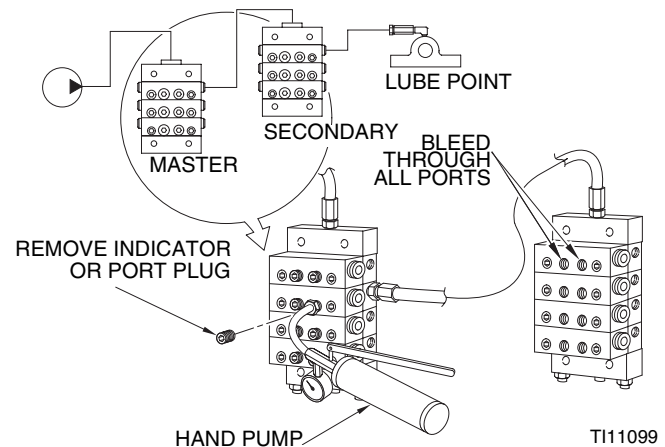

FIG. 4

1. Remove the port plugs or performance indicators from all the indicator ports on the front of the master divider valve.
2. Connect a hand pump filled with clean, filtered lubricant to the indicator port closest to the lube output port that is feeding the line to the secondary divider valve.
3. Stroke the hand pump to fill the line between the master divider valve and secondary divider valve.
4. Continue to stroke the pump until the lubricant purges all the air out of the internal passages of the secondary divider valve and lubricant flows freely from all indicator ports with no evidence of included air.
5. Reinstall the port plugs or performance indicators in their respective positions in the secondary divider valve. Do not replace the port plugs or performance indicators in the master divider valve yet.
6. Repeat Steps 1-5 for each of the other lube lines between the master divider valve and all other secondary divider valves.

Do not replace any of the performance indicators or port plugs removed in Step 1 from the master divider valve assembly until the air-purging procedure described in Section 3 (Filling Master Divider Valve) has been completed.

### 3. Filling Master Divider Valve

Refer to FIG. 5. when performing this procedure.

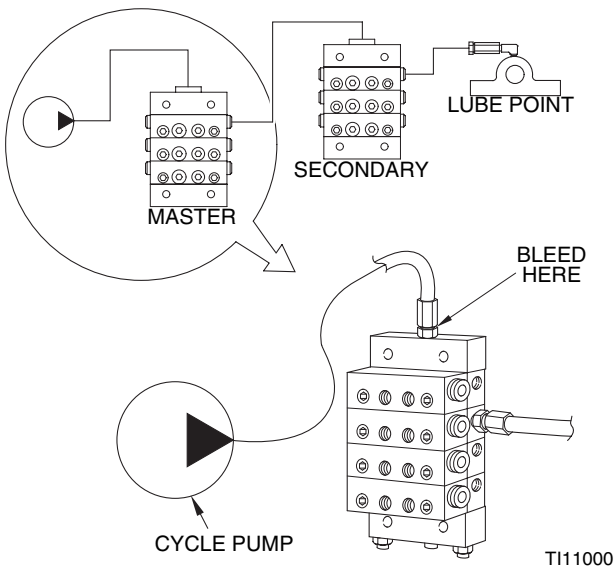

**FIG. 5**

1. Verify that all port plugs or performance indicators have been removed from all indicator ports in the master divider valve.
2. Verify that the system pump is properly connected to the inlet port of the master divider valve.
3. Cycle the system pump sufficiently to fill the main feeder line between the pump and the master divider valve and the lubricant is observed being discharged from all of the indicator ports on the front of the master divider valve with no evidence of included air.
4. Reinstall the master divider valve port plugs or performance indicators into their respective positions.

# Repair

## Purging Air From the System

Before machine operation is resumed following maintenance or repair, manual system air purging must be performed.

There are several air purging procedures available depending upon the maintenance or repair procedure.

<b>CAUTION</b>	
•	Use only clean oil filtered to the SAE -recommended cleanliness level of ISO 18/14 (ISO Standard 4406) when prefilling a system. The manufacturers of the machine tool and its component bearings should be consulted to ensure that the ISO 18/14 cleanliness level is adequate.

SECTION/ Page	Air purging after:
1/page 6	Replacing line between a secondary divider valve and lube point.
2/page 7	Replacing a line between the master divider valve and a secondary divider valve.
3/page 8	Replacing a line between pump and master divider valve.
4/page 9	Adding or replacing any component in a master divider valve assembly.
5/page 10	Adding or replacing any component in module in a secondary divider valve assembly.

### Section 1: Purging Air from Secondary Divider Valve Lube-to-Lube Point Lines

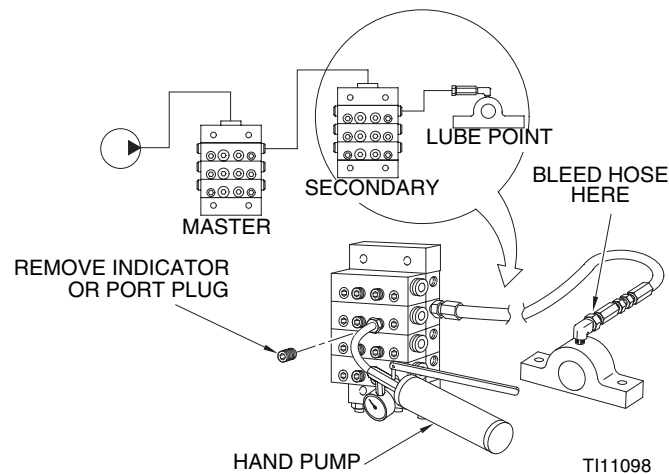



FIG. 6

Steps 1-6, refer to FIG. 6.

1. Install the line from the secondary divider valve to the lube point, but do not completely tighten the connection at the lube point.
2. Remove the performance indicator port plug or the performance indicator from the working valve section on the secondary divider valve assembly corresponding to the outlet port and the line connected to the lube point.
3. Attach a hand pump filled with clean, filtered lubricant to the port on the secondary divider valve that was opened in Step 2.
4. Operate the hand pump until air-free lubricant is observed flowing from the line at the lubrication point.
5. Tighten the fitting at the lubrication point while lubricant is still flowing.
6. Remove the hand pump and reinstall the performance indicator or indicator port plug removed in Step 2.

 If check valves were not installed at the lubrication point, lubricant may continually drain out of the line when the secondary port is open. Therefore, when check valves are not used, the method for bleeding this line is to tighten the line at both ends and repeatedly cycle the secondary divider valve via hand pump operation until lubricant, free of air, flows from the lubrication point.

## Section 2: Purging Air from Master to Secondary Divider Valve Lube Lines

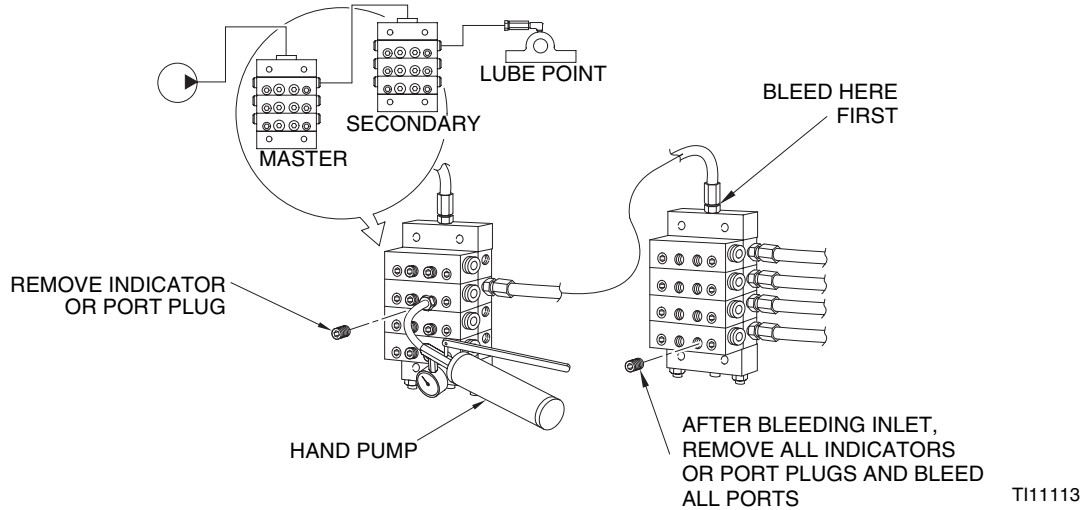

**FIG. 7**

Steps 1- 9, refer to FIG. 7.

1. Install the lines from the master divider valve to the secondary divider valve, but do not completely tighten the connection at the secondary divider valve's inlet.
2. Remove the performance indicator port plug or the performance indicator from the working valve section on the master divider valve assembly corresponding to the outlet port and the line connected to the secondary valve.
3. Attach a hand pump filled with clean, filtered lubricant on the master divider valve that was opened in Step 2.
4. Operate the hand pump until air-free lubricant is observed flowing freely from the secondary valve's lube inlet connector.
5. Tighten the fitting at the secondary valve's inlet while lubricant is still flowing.
6. Remove all of the indicators or indicator port plugs from the secondary divider valve's working sections.
7. Operate the hand pump again until air-free lubricant is observed flowing out of all the secondary divider valve's indicator ports.
8. Reinstall all of the performance indicators or port plugs in the secondary divider valve while lubricant is still flowing from the ports.
9. Remove the hand pump and reinstall the performance indicator or indicator plug removed in Step 2 into the master divider working valve's open port.

The system is now ready for operation.

### Section 3: Purging Air from Pump to Master Divider Valve Lines

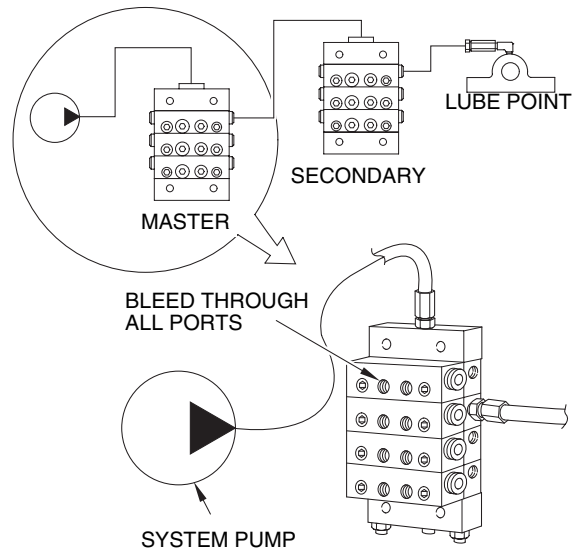

TI11114

**FIG. 8**

Steps 1-3, refer to FIG. 8.

1. Install the line from the system pump to the master divider valve, but do not completely tighten the connection at the master valve's lube inlet.
2. Cycle the system pump until air-free lubricant is observed flowing from the line at the master divider valve's lube inlet.
3. Tighten the fitting at the lube inlet port while lubricant is still flowing.

The system is now ready for operation.



## Section 4: Purging Air After Adding or Replacing a Master Divider Valve Module

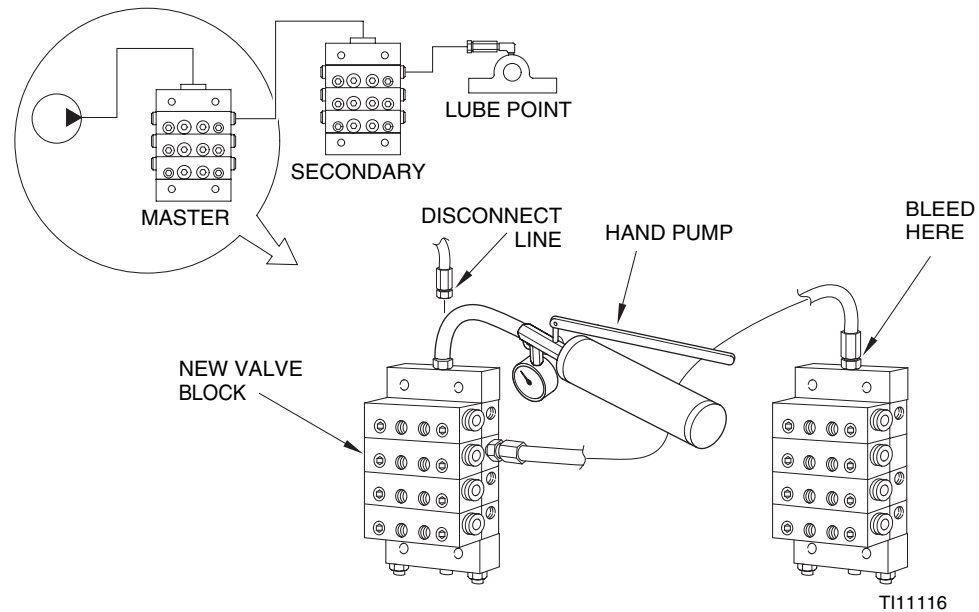

**FIG. 9**

Steps 1-7, refer to FIG. 9.

1. Install the new or replacement module into the master divider valve assembly. Also connect the tubing or hoses to the appropriate secondary divider valve(s) or lubrication point(s) if the new/replacement module is a base section.
2. Do not completely tighten the connection(s) at the secondary divider valve's inlet or at lubrication points.
3. Disconnect and remove the line from the pump at the inlet of the master divider valve.
4. Attach a hand pump filled with clean, filtered lubricant to the inlet port on the master divider valve.
5. Operate the hand pump until air-free lubricant is observed flowing from each secondary valve's lube inlet connector and/or each lubrication point's connector.
6. Tighten the fitting at the secondary valve inlet or at the lubrication port while lubricant is still flowing.
7. Remove the hand pump and reconnect the system pump to the inlet of the master divider valve.

The system is now ready for operation.

## Section 5: Purging Air After Adding or Replacing a Secondary Divider Valve Module

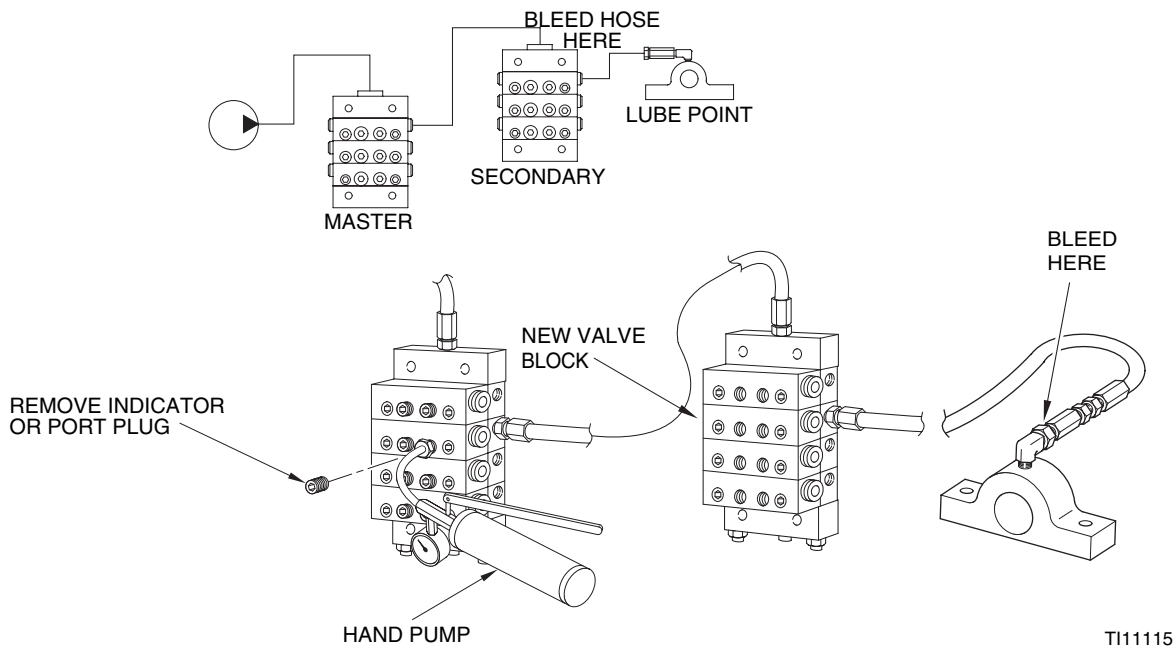

TI11115

**FIG. 10**

Steps 1-8, refer to FIG. 10.

1. Install the new or replacement module to the secondary divider valve assembly. Also connect the tubing or hoses to the appropriate lubrication point if the new/replacement module is a base section.
2. Do not completely tighten the connection(s) at the lubrication point.
3. Remove the performance indicator or indicator port plug from the working valve section on the secondary divider valve assembly corresponding to the outlet port and line connected to a particular lube point.
4. Attach a hand pump filled with clean, filtered lubricant to the port on the secondary divider valve that was opened in Step 3.
5. Operate the hand pump until air-free lubricant is observed flowing from the loosened connector at the lube point.
6. Tighten the fitting at the lube point while lubricant is still flowing.
7. Repeat Steps 3 - 6 for any additional lubrication points connected to the new module.
8. Remove the hand pump and reinstall the performance indicator or port plug removed in Step 3 into the secondary divider valve's open port.

The system is now ready for operation.

## Locating and Repairing Blockages

Blocks will cause a higher than normal pumping pressure. Depending on the application or system design, this blockage will usually result in a complete loss of lubricant flow into the total system and no bearing will be receiving lubrication.

The loss of flow due to a blockage is first indicated with the higher than normal system pressure that is developed by the pump as it attempts to overcome this blockage. Higher pressure is limited, isolated and signaled through the use of various performance indicators, reset and relief, incorporated into the system design.

### Performance Indicators

<b>CAUTION</b>
Never block a lube outlet that is designed to discharge lubricant.

Performance indicators are pressure-sensitive devices that pinpoint excessive pressure in the lubricating system.

These devices are installed in the indicator ports of divider valves, signal a fault either by causing an indicator pin to protrude or by releasing lubricant into the atmosphere.

### Reset Indicator with Memory

Reset indicators stop lube system operation when a fault occurs. These devices can be used in either master or secondary divider valves.

When a lube line becomes blocked, the resultant high pressure pushes the indicator pin through the opening in the cap. The high pressure prevents the affected divider valve piston from completing its cycle, causing a pressure backup through the divider valve which trips a pressure switch upstream from the valve and shuts off the pump.

The indicator pin remains extended until it is reset manually. This helps locate the lube line that is blocked.

### Rupture Indicator

Rupture indicators are used on MSP/MH divider valve applications where lube system pressure exceed 2500 psi. The high pressure from the lube line blockage causes a disc to rupture. The lubricant then forces an indicator to protrude, locating the blockage. The high pressure backs up through the system and trips a switch to shut the system off. When the fault is corrected, the disc must be replaced and the pin reset manually.

### Automatic Relief Indicator

An automatic relief indicator pinpoints lube line blockage but allows the lube system to continue supplying lubricant to points that are not blocked. They are used primarily in secondary divider valves. The excessive pressure created by line blockage moves a piston, enabling the lubricant to escape through a vent. When the pressure is relieved, the spring resets the piston. Because these devices permit the lube system to keep operating when a lube point is blocked, a separate pressure switch connected to an audible alarm should be used to warn of high pressure.

## Locating and Repairing Blockages

### CAUTION

Use only clean oil filtered to the SAE -recommended cleanliness level of ISO 18/14 (ISO Standard 4406) when prefilling a system. The manufacturers of the machine tool and its component bearings should be consulted to ensure that the ISO 18/14 cleanliness level is adequate.

1. Make a visual inspection of the system. Check for crushed lines or improper divider valve installation.
2. Verify that each divider valve outlet required to discharge lubricant can do so and that no pipe plugs have been installed in an outlet designed to serve a bearing or another divider valve.
3. Use a manual pump with a gauge. Fill the pump with clean, filtered lubricant. Connect the manual pump to the inlet of the master divider valve and slowly operate pump. If system will not cycle freely, below 1500 psi, see Master Divider Valve Equipped with Performance Indicator [Step 4a (below)].

#### 4a. Master Divider Valve Equipped With Performance Indicator

With manual pump connected to the master divider valve as outlined in Locating Blockages, Step 3, raise pressure to 2000 psi. The indicators in the indicator ports will signal the location of the blockage. An indicator in the up position indicates pressure is in that outgoing line and signals the blockage is in the area being served from this outlet (FIG. 11).

If no indicator pins are protruding, the blockage is in the master divider valve.

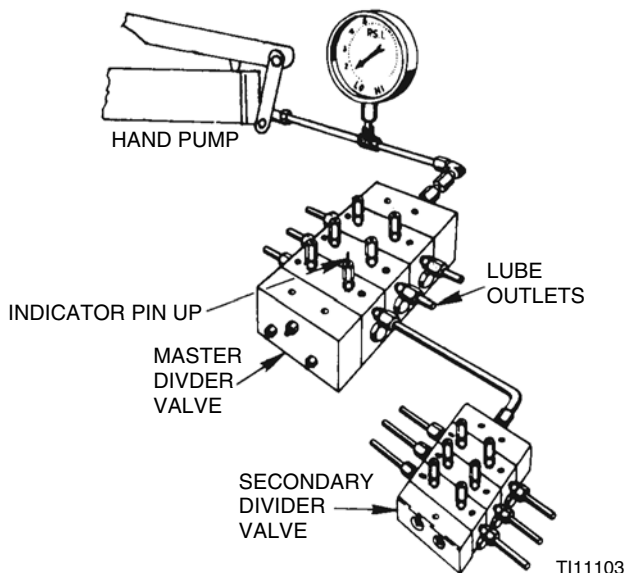

FIG. 11

#### 4b. Master Divider Valve Equipped Without Performance Indicator

- 1) With manual pump connected to the master divider valve as outlined in Locating Blockages, Step 3, raise pressure to 2000 psi.
- 2) Remove, one at a time, each indicator port plug and attempt to operate manual pump after each plug is removed. Do not exceed 2000 psi.
- 3) If pressure drops and the master cycles freely after an indicator port plug is removed, then blockage is downstream in the area that is being served from that outlet. See Locating Blockages, Step 3.

- If all indicator port plugs are removed, the master will not cycle. Blockage is in this divider valve.
- When indicator port plug of a blocked area is removed, a small shot of trapped lubricant will usually surge out of this outlet as the inlet pressure on the divider valve drops.
- If testing (Step 4) indicates a blockage in the master divider valve, this divider valve must be disassembled and cleaned. See Clean Divider Valve, Step 7, page 13.

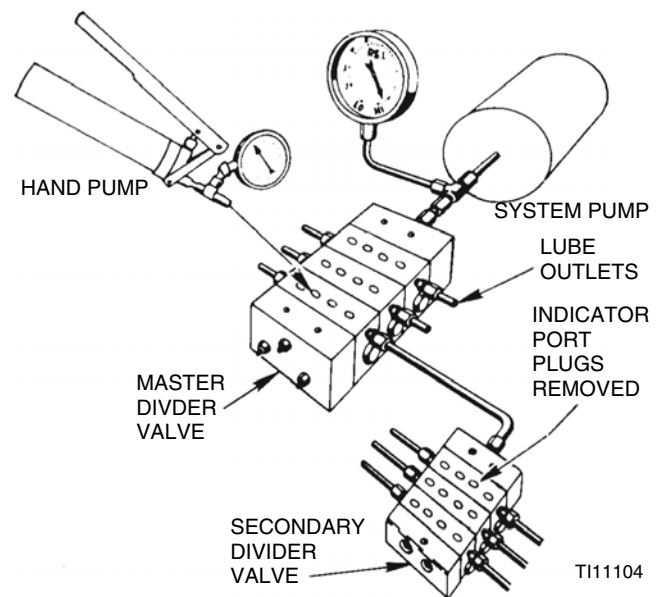

FIG. 12

5. If in Step 4, a blockage has been indicated downstream of the master divider valve, install a manual pump in the indicator port of the master divider valve that is common to the blocked area. (See FIG. 12).

- a. Proceed to downstream secondary divider valve and remove all indicator port plugs.
- b. Slowly operate manual pump. If lubricant can be discharged freely through each of the indicator ports of this divider valve, the blockage is not in the supply line or the divider valve. Go to step 6.

If lubricant is not freely discharged through open indicator ports of the second divider valve, the blockage is in this divider valve or its supply line. Disconnect supply line at secondary inlet fitting and slowly operate manual pump to verify location. If blockage is in this divider valve, go to step 7.

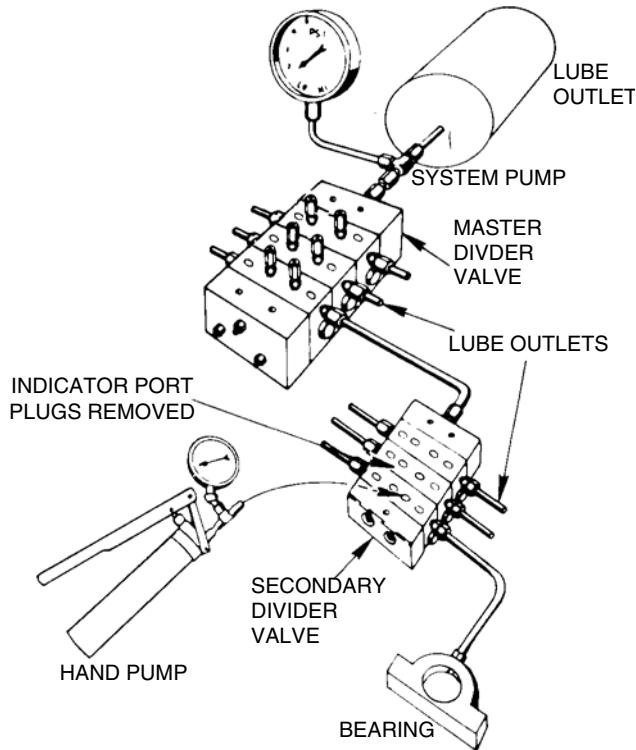

FIG. 13

- 6. Install manual pump into each indicator port of secondary divider valve in turn and slowly operate pump (FIG. 13). If high pressure exists, blockage has been located. Look for **crushed line, tight bearing, improperly drilled fittings and/or lube inlet port**. Correct as necessary.
- 7. Clean Divider Valve

Dirt and foreign material will damage lubricating equipment. Perform all service and disassembly under the cleanest possible conditions.

- a. Before disassembling any divider valve, make a sketch and note the arrangement of the Valve Sections. For example: INLET 10T - 20S - 10T - 30S - END (FIG. 14). Also remove end plugs only and try to move each piston back and forth without removing the piston from the valve section.

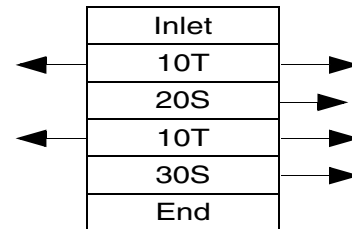

FIG. 14

**CAUTION**

Do not insert hard metal objects into piston bore (i.e., punches, screwdrivers, etc.). Use a brass rod and hand pressure only.

- b. If all pistons move freely and there is no indication of a more serious problem, replace end plugs.
- c. Using a new gasket, tighten and torque as indicated in Table 1 (page 11).

**Table 4: Torque Values (\*see FIG. 1, page 3)**

	Assembly Torque (ft-lbs)							
	MJ	MD	MV	MVH	MSP/MH	MX	MXP	MGO
Tie Rod Nuts	12		20	24	5-8	23	6-9	12
Indicator Plugs*	6-7	15	15	15	8-9	18	12-15	6-8
End Plugs*	11-13		15	15	12-15	46	46-50	15
Valve Section Mounting Screw	-	-	-	-	8-9	-	12-13	-

## Repair

- d. Clean sections and pistons in suitable clean solvent until all lubricant has been removed.
- e. Use compressed air to dry and blow out all ports thoroughly.

A small metal probe should be used to make sure all passages are clean and open.

Inspect cylinder bore and piston carefully for scratches, score marks or other damage.

 If either piston or cylinder bore is damaged, a new section must be installed. All pistons are selectively fitted to the bore for proper clearance. Be sure to reinstall piston only into the valve section from which it was removed.

- f. If divider valve section and piston both appear in good condition, reassemble section making certain piston slides smoothly but snugly in cylinder bore.
- g. Repeat cleaning and inspection of each section. After all sections have been cleaned, blown out, inspected and found to be in good condition, reassemble divider valve using notes and sketches (Step 7) as a reference.

- Always use new gaskets.
-  Test operation of divider valve using manual pump.

### **Contamination Blockage**

If dirt, foreign material or any other form of contamination is found in a divider valve, cleaning that divider valve will only temporarily solve contamination blockage problems. The source of the contamination must be eliminated for satisfactory service.

The system filtering method must be investigated, filter elements should be inspected and cleaned if necessary.

The reservoir filling method should be reviewed to eliminate any chance of foreign material entering the reservoir during filling.

### **Separation Blockage**

If a hard wax or soap-like material is found in the Valve Section, grease separation is occurring. This means that the oil is being squeezed from the grease at normal system operating pressure and the grease thickener is being deposited in the divider valve. Cleaning the divider valve will only temporarily solve the problem. Consult your lubricant supplier for recommendations on alternate lubricants and your local Graco/Trabon distributor to verify compatibility with centralized lubricating systems.

If all indicator port plugs are removed, master will not cycle. Blockage is in this divider valve.(FIG. 11).

# Parts

Part Numbers							
Divider Valve	MJ	MJ-SS	MS/MH	MS (Nickel)	MX	MXP	MGO
<b>Intermediate Gasket</b> 1 Per Section	510-998-002	510-998-002	--	--	510-933-001	--	--
<b>Enclosure †</b>			O-ring (Buna) 422-210-040	O-ring (Buna) 422-210-040	O-ring (fluorocarbon) 422-240-080	O-ring (fluorocarbon) 422-240-080	
<b>Plug Seals</b> 2 Per Section	Gasket 510-681-000	Gasket 439-007-235	Gasket 527-000-240	Gasket 527-000-240	Gasket 527-776-000	Gasket 527-776-000	O-ring 422-012-170
<b>O-rings</b> 9 per section Except MGO	--	--	Std. (Buna-N) 422-010-060	Buna-N 422-010-060	--	Std. (fluorocarbon) 527-300-510 (90 Duro)	Fluorocarbon and Buna-N O-rings 422-040-110 (4) 422-040-120 (2) 422-040-130 (2) 422-040-150 (1) 423-700-086 (1) Repair kit 560-001-950 contains all o-rings listed above for one valve section
<b>Tie Rods</b> Qty per divider valve assembly	2	2	3	3	4	3	2
Number of Sections in Divider Valve							Upper Rods 510-665-030 through 510-665-100
3	510-999-030	510-999-130	527-001-930	527-003-290	510-505-030	527-300-270	
4	510-999-040	510-999-140	527-001-940	527-003-300	510-505-040	527-300-280	
5	510-999-050	510-999-150	527-001-950	527-003-310	510-505-050	527-300-290	
6	510-999-060	510-999-160	527-001-960	527-003-320	510-505-060	527-300-300	Lower Rods 510-666-030 through 510-666-100
7	510-999-070	510-999-170	527-001-970	527-003-330	510-505-070	527-300-310	
8	510-999-080	510-999-180	527-001-980	527-003-340	510-505-080	527-300-320	
9	--	--	--	--	510-505-090	527-300-330	
10	--	--	--	--	510-505-100	527-300-340	
<b>Tie Rod Nuts</b> Qty per divider valve assembly	410-440-010	410-702-002	410-440-010	410-702-002	510-506-001	410-440-020	510-506-001
	2	2	3	3	8	3	8
<b>Mounting Screws</b> 2 Per Section	--	--	419-140-070	419-700-020	--	419-160-080	--
<b>Mounting Bars and Plates</b>	See 15126	--	See 15126	--	See 15126	--	--
<b>Cycle Indicator Plug Repair Kit</b> †	-- Gasket 560-002-987	--	O-ring (Buna-N) 560-002-055 Gasket 560-002-050	--	O-ring (fluorocarbon) 560-001-720* Gasket 506-001-710	O-ring (fluorocarbon) 560-001-720 (Ind. Body) 527-300-830	-- 510-612-001 (Ind. Body)

† MS/MH dated L94 and later use o-ring seal; K94 and earlier use metal gasket.  
MXP dated K94 and later use o-ring seal; J94 and earlier use metal gasket.  
\*1985 and later

# Specifications

## MD Series

### Dimensions

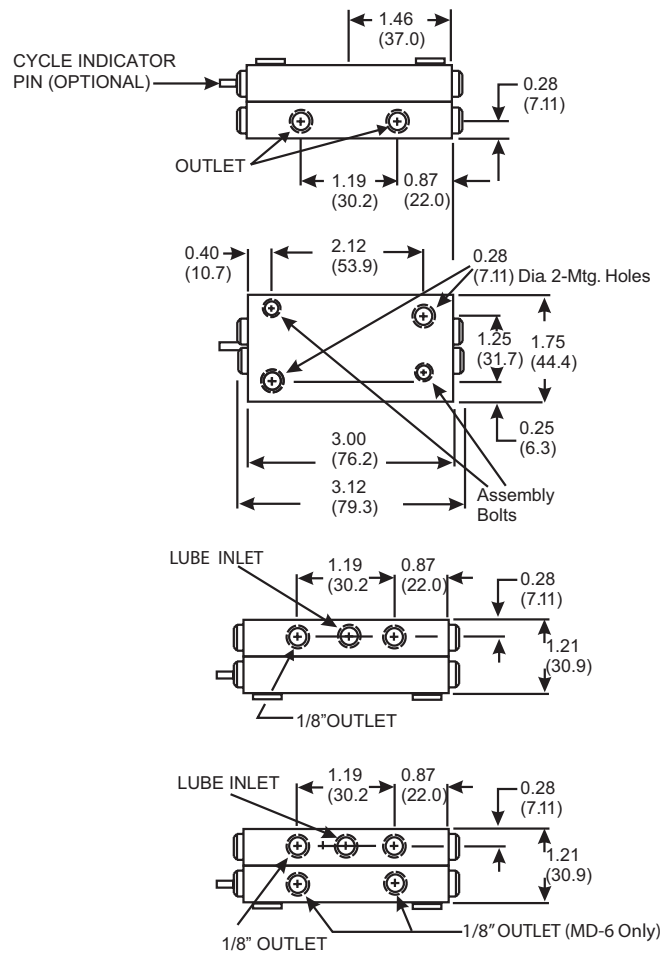

ti11472

### Technical Data

Material	Steel
Pressure (max)	3,000 psi (207 bar)
Lubricant	Oil or grease
Net Weight (approx.)	1-lb. 8 oz (0.68 kg)
Volume (Lubricant to cycle divider valve one complete cycle)	
MD-2, MD-3, MD-4	0.080 in. <sup>3</sup> (1.31 ccm)
MD-6	0.060 in. <sup>3</sup> (0.98 ccm)
Torque Ratings	
Assembly Bolts	8-9 ft. lbs
Enclosure Plugs	11-13 ft. lbs
Indicator Plug	15 ft. lbs
Outlet Plugs	6-7 ft. lbs.



# Specifications

## MJ Series

### Dimensions

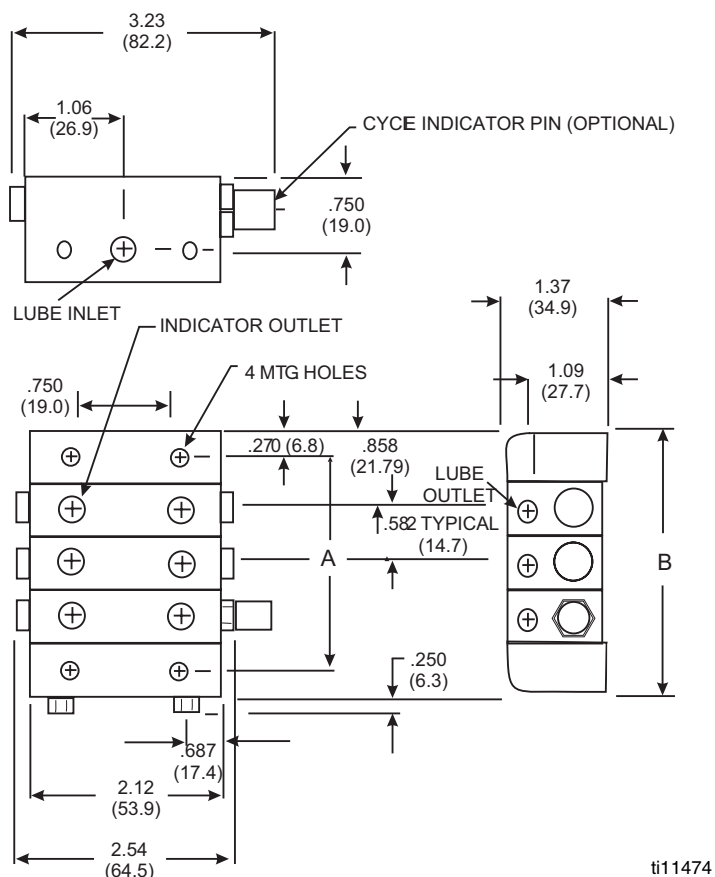

### Technical Data

Material	Plated or Stainless Steel
Pressure (max)	2,000 psi (138 bar)
Lubricant	Oil or grease up to NLGI Grade 1
Maximum Operating Temperature	200°F (93°C)
Maximum Cycle Rate With Cycle Pin	60 CPM
Net Weight (approx.)	
3 section divider valve assembly	1-lb. 15 oz (0.88 kg)
4 section divider valve assembly	2 lbs. 5 oz (1.04 kg)
5 section divider valve assembly	2 lbs. 11 oz (1.21 kg)
6 section divider valve assembly	3 lbs. 1 oz (1.38 kg)
7 section divider valve assembly	3 lbs. 7 oz (1.55 kg)
8 section divider valve assembly	3 lbs. 13 oz (1.72 kg)
Torque Ratings	
Tie Rod Nut	12 ft. lbs
Enclosure Plug	11-13 ft. lbs
Outlet Port Plugs	6-7 ft. lbs.

# MH Series

## Dimensions

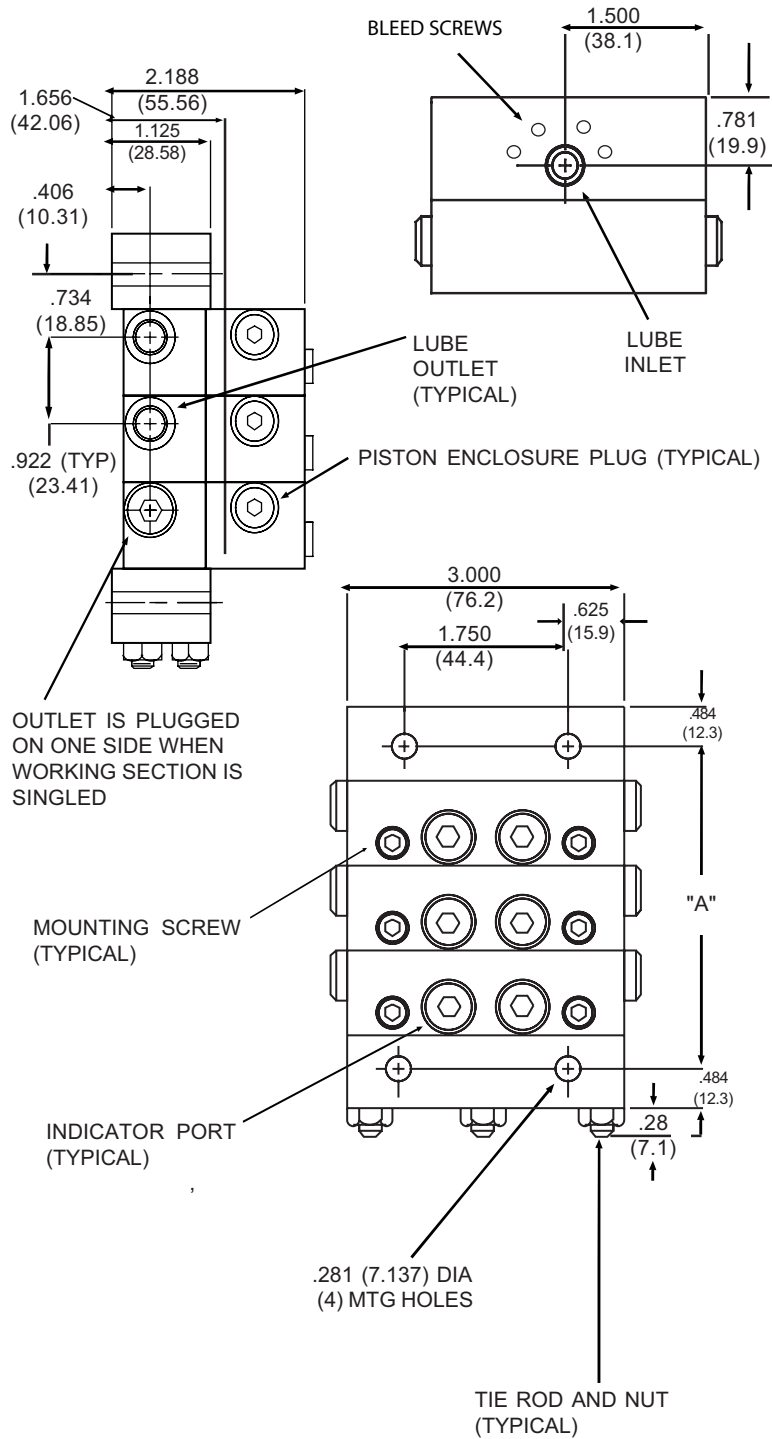

ti11480

**Technical Data**

Material	Steel Body (corrosion protected) Steel Piston (honed fit)
Pressure (max)	6,000 psi (414 bar) for Petroleum Oil only - Buna O-rings 7,500 psi (517 bar) for Petroleum or Synthetic Oil - Viton O-rings
Lubricant	Petroleum or synthetic oil only
Maximum Operating Temperature	
Buna-N O-rings (422-010-060)	200°F (93°C)
Viton O-rings (527-000-840)	350°F (163°C)
Maximum Cycle Rate Without Cycle Pin	200 CPM
Net Weight (approx.)	
3 section divider valve assembly	5.9 lbs (2.7 kg)
4 section divider valve assembly	7.3 lbs (3.3 kg)
5 section divider valve assembly	8.7 lbs (4.0 kg)
6 section divider valve assembly	10.2 lbs (4.6 kg)
7 section divider valve assembly	11.6 lbs (5.6 kg)
8 section divider valve assembly	13.0 lbs (5.9 kg)
Torque Ratings	
Mounting Screw	8-9 ft. lbs
Enclosure Plugs	12-15 ft. lbs
Indicator Port Plug	8-9 ft. lbs
Bleed Screws	1-2 ft. lbs.
Tie Rod Nut	5-8 ft. lbs

# MSP Series

## Dimensions

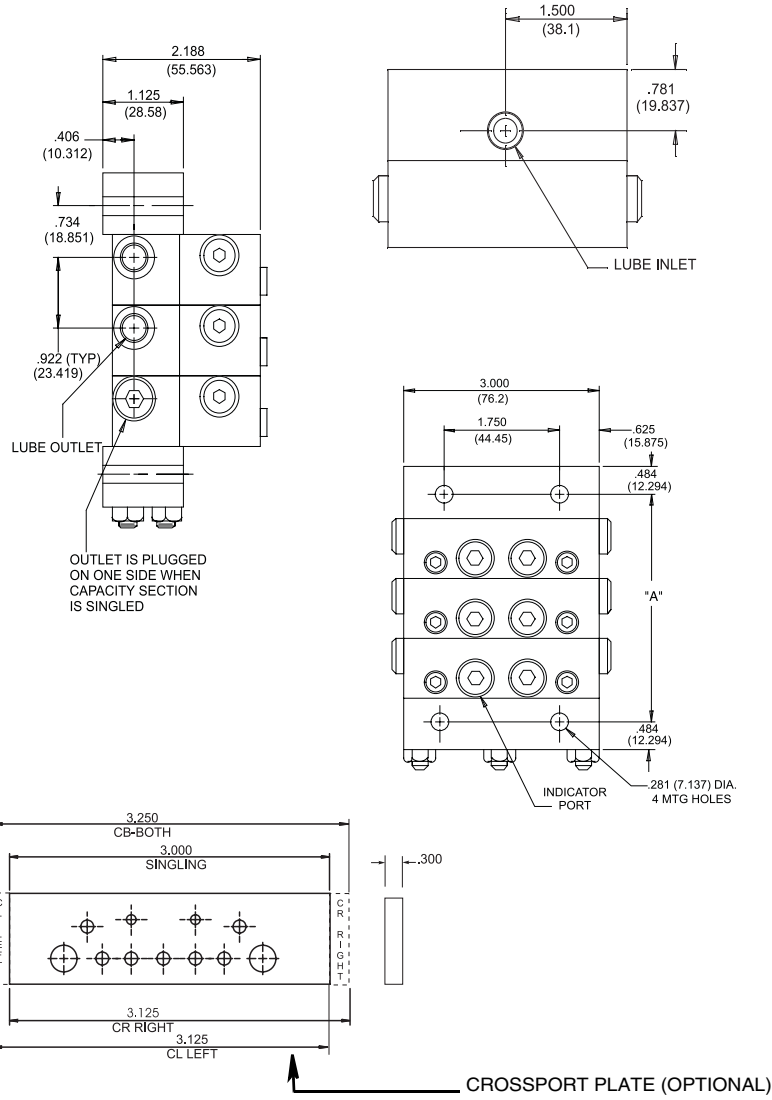

ti11478

**Technical Data**

Material	Corrosion Protected Steel (optional: Type 316 Stainless Steel)
Pressure (max)	
Zero Leak Inlet	1500 psi (104 bar)
Shunt/Shutoff Inlet	3000 psi (207 bar)
Ambient Temperature (max)	140°F (60°C)
Lubricant	
Zero Leak Inlet	Oil Only - up to 5000 SUS, requires 25 micron (min) filtration
Shunt/Shutoff Inlet	Oil and fluid grease - filter oil through 25 micron filter and grease through 100 micron mesh strainer
New Weight (approx.)	
3 section divider valve assembly	5.9 lbs (2.7 kg)
4 section divider valve assembly	7.3 lbs (3.3 kg)
5 section divider valve assembly	8.7 lbs (4.0 kg)
6 section divider valve assembly	10.2 lbs (4.6 kg)
7 section divider valve assembly	11.6 lbs (5.6 kg)
8 section divider valve assembly	13.0 lbs (5.9 kg)
Torque Ratings	
Mounting Screw	8-9 ft. lbs
Enclosure Plugs	12-15 ft. lbs
Indicator Port Plug	8-9 ft. lbs
Bleed Screws	1-2 ft. lbs.
Tie Rod Nut	5-8 ft. lbs.

# Specifications

## MX Series

### Dimensions

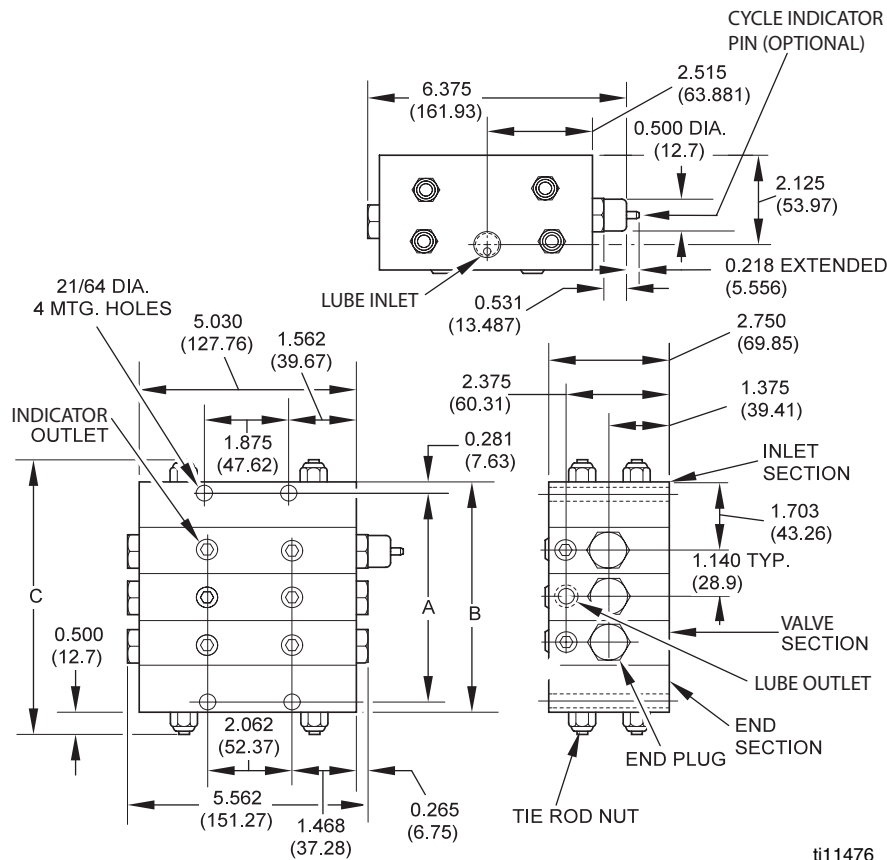

ti11476

### Technical Data

Material	Plated Steel
Pressure (max)	3,000 psi (207 bar)
Lubricant	Oil or grease
Maximum Operating Temperature	200°F (93°C)
Maximum Cycle Rate With Cycle Pin	60 CPM
Maximum Cycle Rate Without Cycle Pin	200 CPM
Net Weight (approx.)	
3 section divider valve assembly	21-lb. 6 oz (9.69 kg)
4 section divider valve assembly	25 lbs. 10 oz (11.62 kg)
5 section divider valve assembly	29 lbs. 14 oz (13.55 kg)
6 section divider valve assembly	34 lbs. 2 oz (15.47 kg)
7 section divider valve assembly	38 lbs. 6 oz (17.40 kg)
8 section divider valve assembly	42 lbs. 12 oz (19.39 kg)
9 section divider valve assembly	47 lbs. 2 oz (21.37 kg)
10 section divider valve assembly	51 lbs. 8 oz (23.26 kg)
Torque Ratings	
Tie Rod Nut	30 ft. lbs
Enclosure Plug	48 ft. lbs
Outlet Port Plugs	18 ft. lbs.



# MXP Series

## Dimensions

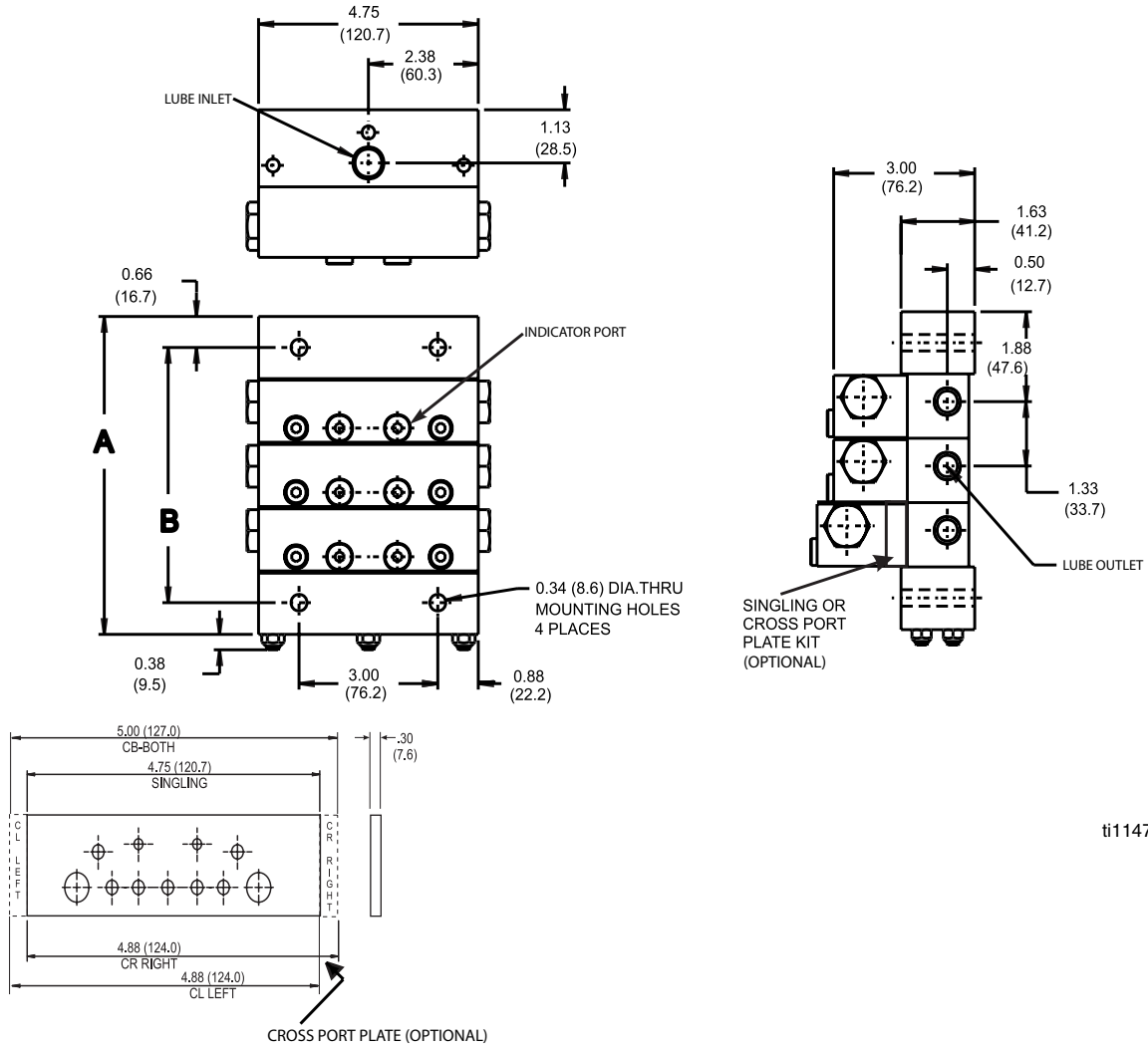

ti11477



**Technical Data**

Material	Zinc Plated Steel
Pressure (max)	3,000 psi (207 bar)
Lubricant	Oil or grease
Maximum Operating Temperature	350°F (177°C)
Maximum Cycle Rate With Cycle Pin	60 CPM
Maximum Cycle Rate Without Cycle Pin or With Prox Cycle Switch	200 CPM
Net Weight (approx.)	
3 section divider valve assembly	18-lb. 2 oz (8.3 kg)
4 section divider valve assembly	22 lbs. 6 oz (10.2 kg)
5 section divider valve assembly	26 lbs. 9 oz (12.2 kg)
6 section divider valve assembly	31 lbs. 3 oz (14.2 kg)
7 section divider valve assembly	35 lbs. 6 oz (16.2 kg)
8 section divider valve assembly	39 lbs. 9 oz (18.1 kg)
9 section divider valve assembly	44 lbs. 3 oz (20.1 kg)
10 section divider valve assembly	48 lbs. 6 oz (22.1 kg)
Torque Ratings	
Tie Rod Nut	6-9 ft. lbs
Enclosure Plugs	48 +/- 2 ft. lbs
Indicator Plug	12 -15 ft. lbs
Valve Section Mounting Screw	12-13 ft. lbs.

# MGO Series

## Dimensions

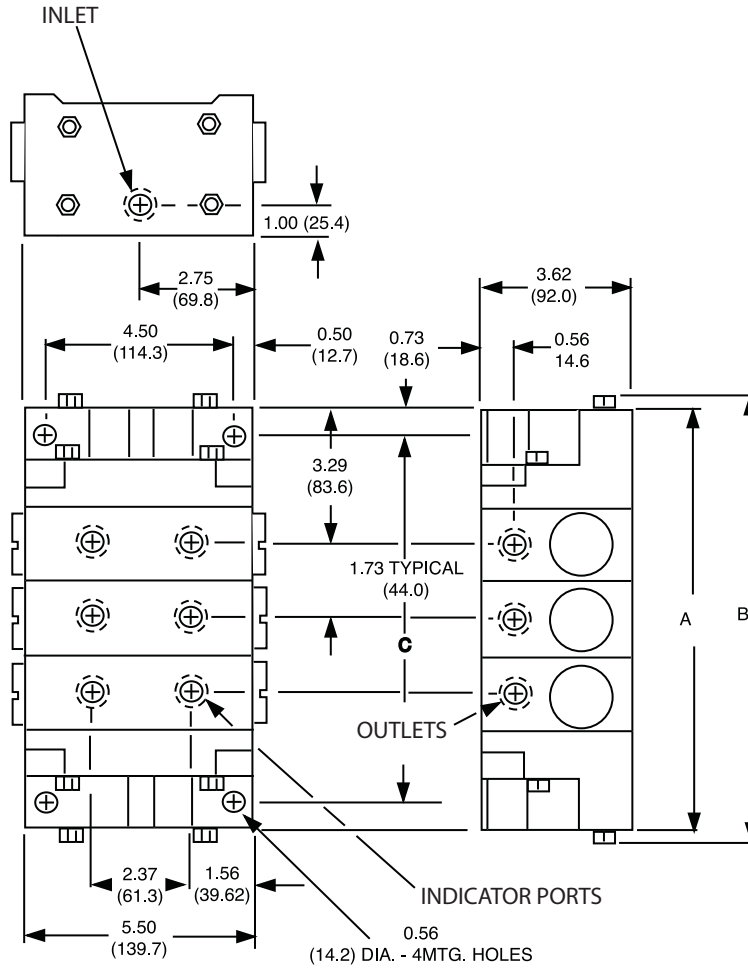

## Technical Data

Material	Zinc Plated Steel and Phosphate Coated Cast Iron
Pressure (max)	
3-7 section divider valve assembly	6000 psi (414 bar)
8 section divider valve assembly	5500 psi (380 bar)
9 section divider valve assembly	5000 psi (345 bar)
10 section divider valve assembly	4500 psi (311 bar)
11 section divider valve assembly	4000 psi (276 bar)
Lubricant	Oil or grease
Maximum Operating Temperature	200°F (93°C)
Maximum Cycle Rate With Cycle Pin	60 CPM
Maximum Cycle Rate Without Cycle Pin or With Prox Cycle Switch	200 CPM
Net Weight (approx.)	
3 section divider valve assembly	45-lb. (20.41 kg)
4 section divider valve assembly	53 lbs. 5 oz (24.18 kg)
5 section divider valve assembly	61 lbs. 10 oz (27.95 kg)
6 section divider valve assembly	70 lbs. 15 oz (32.17 kg)
7 section divider valve assembly	80 lbs. 4 oz (36.40 kg)
8 section divider valve assembly	89 lbs. 9 oz (40.62 kg)
9 section divider valve assembly	98 lbs. 14 oz (44.84 kg)
10 section divider valve assembly	108 lbs. 3 oz (49.07 kg)
11 section divider valve assembly	117 lbs. 8 oz (53.40 kg)
Torque Ratings	
Tie Rod Nut	12 ft. lbs
Enclosure Plug	15 ft. lbs
Outlet Port Plug	6-8 ft. lbs
Valve Section Mounting Screw	12-13 ft. lbs.

# STANDARD LUBRIQUIP WARRANTY

Lubriquip, Inc., a subsidiary of Graco Inc. (hereinafter called Lubriquip), warrants all equipment manufactured by Lubriquip and bearing its name to be free from defects in material and workmanship on the date of sale by an authorized Lubriquip distributor to the original purchaser for use. With the exception of any special, extended, or limited warranty published by Lubriquip, Lubriquip will, for a period of twelve month from the date of sale, repair or replace any part of the equipment determined by Lubriquip to be defective. This warranty applies only when the equipment is installed, operated and maintained in accordance with Lubriquip's written recommendations.

This warranty does not cover, and Lubriquip shall not be liable for general wear and tear, or any malfunction, damage or wear caused by faulty installation, misapplication, abrasion, corrosion, inadequate or improper maintenance, negligence, accident, tampering, or substitution of non-Lubriquip component parts. Nor shall Lubriquip be liable for malfunction, damage or wear caused by the incompatibility of Lubriquip equipment with structures, accessories, equipment or materials not supplied by Lubriquip, or the improper design, manufacture, installation, operation or maintenance of structures, accessories, equipment or materials not supplied by Lubriquip.

This warranty is conditioned upon the prepaid return of the equipment claimed to be defective to an authorized Lubriquip distributor for verification of the claimed defect. If the claimed defect is verified, Lubriquip will repair or replace free of charge any defective parts. The equipment will be returned to the original purchaser transportation prepaid. If inspection of the equipment does not disclose any defect in material or workmanship, repairs will be made at a reasonable charge, which charges may include the costs of parts, labor, and transportation.

**THIS WARRANTY IS EXCLUSIVE, AND IS IN LIEU OF ANY OTHER WARRANTIES, EXPRESS OR IMPLIED, INCLUDING BUT NOT LIMITED TO WARRANTY OF MERCHANTABILITY OR WARRANTY OF FITNESS FOR A PARTICULAR PURPOSE.**

Lubriquip's sole obligation and buyer's sole remedy for any breach of warranty shall be as set forth above. The buyer agrees that no other remedy (including, but not limited to, incidental or consequential damages for lost profits, lost sales, injury to person or property, or any other incidental or consequential loss) shall be available. Any action for breach of warranty must be brought within two (2) years of the date of sale.

Lubriquip makes no warranty, and disclaims all implied warranties of merchantability and fitness for a particular purpose in connection with accessories, equipment, materials or components sold but not manufactured by Lubriquip. These items sold, but not manufactured by Lubriquip (such as electric motors, switches, hose, etc.), are subject to the warranty, if any, of their manufacturer. Lubriquip will provide purchaser with reasonable assistance in making any claim for breach of these warranties.

In no event will Lubriquip be liable for indirect, incidental, special or consequential damages resulting from Lubriquip supplying equipment hereunder, or the furnishing, performance, or use of any products or other goods sold hereto, whether due to a breach of contract, breach of warranty, the negligence of Lubriquip, or otherwise.

## **FOR LUBRIQUIP CANADA CUSTOMERS**

The parties acknowledge that they have required that the present document, as well as all documents, notices and legal proceedings entered into, given or instituted pursuant hereto or relating directly or indirectly hereto, be drawn up in English. Les parties reconnaissent avoir convenu que la rédaction du présente document sera en Anglais, ainsi que tous documents, avis et procédures judiciaires exécutés, donnés ou intentés à la suite de ou en rapport, directement ou indirectement, avec les procédures concernées.

For complete warranty information contact your local Graco distributor, call Graco customer service at 1-800-690-2894 or visit our website: [www.graco.com](http://www.graco.com)

*All written and visual data contained in this document reflects the latest product information available at the time of publication.  
Graco reserves the right to make changes at any time without notice.*

*This manual contains English. MM 312497*

**Graco Headquarters:** Minneapolis  
**International Offices:** Belgium, China, Japan, Korea

**GRACO INC. P.O. BOX 1441 MINNEAPOLIS, MN 55440-1441**

Copyright 2007, Graco Inc. is registered to I.S. EN ISO 9001

[www.graco.com](http://www.graco.com)

12/2007