**The U.S. Army Concept for Multi-Domain
Combined Arms Operations at Echelons Above Brigade
2025-2045**
Versatile, Agile, and Lethal

**Version 1.0
September 2018**

DISTRIBUTION INSTRUCTIONS: Distribution Statement A: Approved for public release.
Distribution unlimited.

(This page intentionally blank.)

Preface

From the Commander

United States (U.S.) Army Combined Arms Center

The emerging operational environment presents more complex challenges to the Army and Joint Force than any experienced in Iraq and Afghanistan. While the Army learned invaluable and enduring lessons over the last 17 years, that experience, sustained over almost two decades, culturally imprinted a generation of Army leaders and the institution for one type of warfare—counter insurgency and other stability operations. Now, counter to this recent experience, we find ourselves entering a new era where the threat of large-scale ground combat is more likely than at any point since the end of the Cold War.

To meet the challenges of this new and evolving security environment, requiring both conventional and irregular warfare at much higher scale and intensity, our Army must prepare for the most lethal and challenging threat to our nation: the increasing likelihood of highly contested great power conflict. This requires changes in how we man, equip, train, and employ Army forces, especially those forces at echelons above brigade. The Echelons Above Brigade (EAB) Concept, nested within the higher Multi-Domain Operations Concept, provides the intellectual foundation to drive this change.

As the Army transformed from a division to a brigade-based force, echelons above brigade transitioned from being large, highly capable formations to mere headquarters, devoid of fixed structure but tailorable to accomplish a variety of missions. While appropriate at the time, this transition now leaves us potentially unprepared. In the future environment, characterized by intensive peer and near-peer competition and possible conflict, the U.S. Army must evolve and adapt both its culture and capabilities to stay ahead of our adversaries. It must recast the current EAB headquarters into interdependent, echeloned multi-domain warfighting formations armed with the persistent, resident capabilities necessary to prevail against the complex and capable threats that challenge us across the competition continuum.

With the reemergence of peer-capable threats, the future battlefield will rely on divisions, corps, field armies, and theater armies to shape the security environment, prevent conflict, prevail in large-scale combat, and consolidate gains for enduring stability. These EAB formations must seize and retain the initiative now—well before armed conflict—in order to win in the future. We must arm them with the essential capabilities and authorities, and with sufficient capacity, to see & understand, decide, shape, and strike faster than our adversaries, across all domains, to endure and sustain favorable outcomes. The time is now to prepare our Army for these demands and adapt to the multi-domain battlefield of tomorrow. Only through enhancing EAB formations and evolving its warfighting culture can the U.S. Army remain the world's most lethal ground combat force capable of winning anywhere, anytime.



MICHAEL D. LUNDY
Lieutenant General, U.S. Army
Commander, Combined Arms Center

(This page intentionally blank.)

Foreword

From the Director

U.S. Army Capabilities Integration Center

Our near-peer competitors, leveraging emerging trends in science, technology, and the information environment, have invested in strategies and capabilities to challenge the United States and remake the global order. They employ innovative approaches to contest U.S. and allies' interests in all domains, often seeking to attain their goals through ambiguous actions taken below the threshold of armed conflict. In armed conflict, advances in weapons technology, sensors, communications, and information processing allow future adversaries to generate stand-off intended to separate the Joint Force in time, space, and function. To fulfill the U.S. Army's landpower roles in protecting the Nation and securing its vital interests, the Army must adapt the way it organizes, trains, educates, mans, and equips to fight these future threats.

To that end, the Army developed and continues to refine the *U.S. Army in Multi-Domain Operations* (MDO) Concept, which outlines the way our Army counters and defeats a near-peer adversary in competition and armed conflict. The *U.S. Army Concept for Multi-Domain Combined Arms Operations at Echelons Above Brigade* was developed in parallel and is nested with the evolving MDO Concept. As part of MDO development, the Army identified three overarching and overlapping themes to guide subsequent concept and capability development efforts. First, the Army needs to compete below the threshold of armed conflict to deter an adversary from viewing war as the best approach to achieving strategic objectives. But just as important, the Army must think differently about competition and actively engage in the operational environment with appropriate authorities to enable rapid transition to conflict if necessary. Second, to defeat a near-peer adversary in armed conflict, the Army and Joint Force must be able to converge capabilities across all domains (air, land, maritime, space, cyberspace), and environments (electromagnetic spectrum, information) continuously and rapidly. Finally, the Army cannot win wars alone. A whole-of-government approach incorporating the power of joint, interorganizational, and multinational partners is essential to winning future wars and creating lasting outcomes.

Our echelons above brigade—theater armies, field armies, corps, and divisions—are the linchpin for all of these actions, and must be resourced as such. These are more than headquarters. They are multi-domain capable formations that converge capabilities in all domains and environments during competition and armed conflict, focused on near-peer threats able to win in large-scale ground combat. Our current force, although lethal and experienced after almost two decades of war, requires broad-based modernization if it is to accomplish the tasks required to win in future conflict. This concept is integral in developing and testing the capabilities, doctrine, organizations, Soldiers, and leaders needed to conduct MDO at echelon to defeat future near-peer adversaries. Its publication represents the first step toward the development of the future Army force.



ERIC J. WESLEY
Lieutenant General, U.S. Army
Director, Army Capabilities
Integration Center

Executive Summary

This concept describes six challenges in the expanded multi-domain operations framework and how future *Army forces gain and maintain the initiative* across the competition continuum, the full range of military operations, and each unique AOR to meet those challenges. The concept is nested and congruent with the current draft version 1.5 of the Multi-Domain Operations concept.

The Army's four strategic roles—shape security environments, prevent conflict, prevail in large-scale ground combat, and consolidate gains—clarify the enduring reasons for which the Army organizes, trains, and equips, and provide a lens to focus development of future EAB capabilities. To enable these roles against complex near-peer threats across the continuum of competition, EAB formations and commanders must be able to *see and understand* the depth of the battlespace, including across all domains, the EMS, and the information environment; *decide* on a course of action that converges multi-domain capabilities at a decisive point with increased speed and tempo to *shape* the battlespace for success through cross-domain action and maneuver and *strike* the enemy at multiple decisive points or spaces; and possess the *endurance* to maintain positions of advantage while consolidating gains.

This concept explains how enabled EAB *formations* provide essential linkages to the expanded instruments of national power, and operate seamlessly with partners to overmatch any future threat.

These enabled EAB formations possess the necessary capabilities and capacities to—

- 1) *Gain and maintain contact* to reveal threat areas of influence and enemy dispositions,
- 2) *Persistently compete* below the threshold of armed conflict,
- 3) *Posture* to reduce vulnerability and rapidly transition to large-scale ground combat,
- 4) *Converge multi-domain effects* in depth to create windows of superiority,
- 5) *Exploit the initiative* at tempo against critical vulnerabilities to dis-integrate threat systems, and enable maneuver forces to defeat enemy formations in close combat, and
- 6) *Consolidate gains* to develop and retain an enduring initiative.

To achieve this, future enabled EAB formations must include:

uniquely tailored theater armies that set conditions for the employment of landpower in their AORs and the defeat of adversary aggression in competition below armed conflict;

threat-focused field armies that provide credible deterrence, execute the competition below armed conflict against near-peer threats, and enable rapid transition to win in large-scale ground combat operations (LSGCO);

versatile corps that rapidly tailor to multiple missions and roles, coordinate deep cross-domain maneuver, shape the deep maneuver area in support of close areas, execute operational deep fires, and follow through to consolidate tactical gains for lasting success; and

tactically focused divisions that command brigade combat teams (BCT) and enablers, converge multi-domain capabilities, shape the close areas, execute deep maneuver and fires, and dominate the close fight through expert employment of those BCTs and enablers.

Together, these EAB formations enable Army forces to quickly respond to crisis, compete below the threshold of conflict, defeat aggression, and prevail in LSGCO against capable near-peer threats. This concept begins the dialogue to optimize EAB headquarters as robust fighting formations with resident capabilities and capacities focused primarily on defeating near-peer adversaries and threats in LSGCO while still retaining the flexibility needed for limited contingency operations.

U.S. Army Concept for Multi-Domain Combined Arms Operations at Echelons Above Brigade

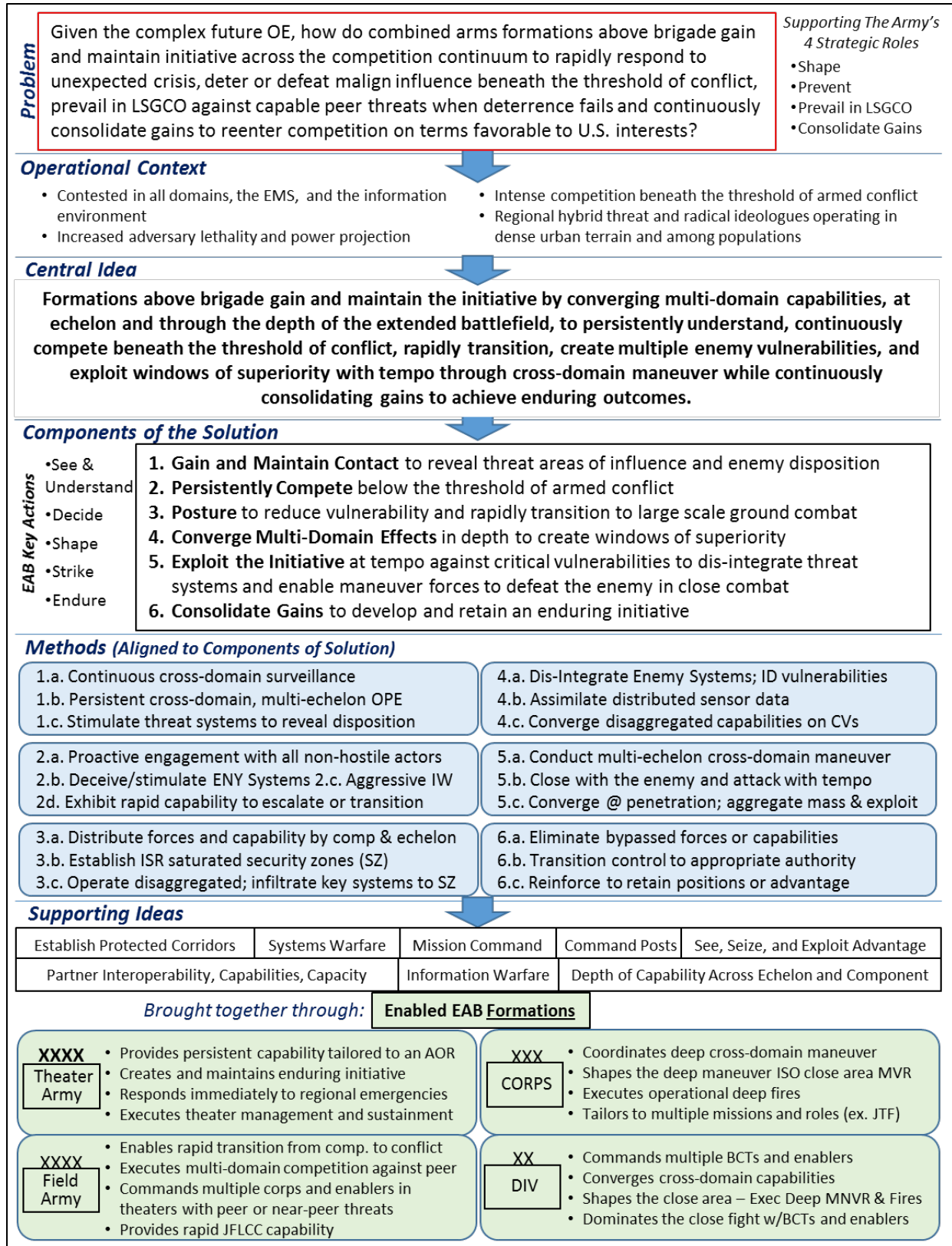

Figure 1. EABC logic diagram

Department of the Army
Headquarters, United States Army
Training and Doctrine Command
Fort Eustis, VA 23604

24 September 2018

**THE U.S. ARMY CONCEPT FOR MULTI-DOMAIN COMBINED ARMS
OPERATIONS AT ECHELONS ABOVE BRIGADE 2025-2045**

History. This document is a new Department of the Army concept.

Summary. This concept describes how senior Army warfighting formations at echelons above brigade (EAB) operate throughout the competition continuum to support the Army's four strategic roles; proposes how EAB formations might be structured and employed in the future; and identifies the changes and capabilities required at these echelons to meet the landpower demands of the future operational environment and prospective threats.

Applicability. This document applies to all Department of the Army activities that develop doctrine, organizations, training, materiel, leadership, education, personnel, and facilities capabilities. It guides future force development and informs the Joint Capabilities Integration and Development System process. It also supports the Army capabilities processes and functions as a conceptual basis for developing supporting concepts related to the future force and provides a future vision to guide near-, mid-, and far-term capability development efforts.

Proponent and supplementation authority. The proponent of this document is TRADOC Headquarters, Director, ARCIC. The proponent has the authority to approve exceptions or waivers to this pamphlet that are consistent with controlling law and regulations. Do not supplement this document without prior approval from Director, TRADOC ARCIC (ATFC-ED), 950 Jefferson Avenue, Fort Eustis, VA 23604-5763.

Suggested improvements. Users are invited to submit comments and suggested improvements via DA Form 2028 (Recommended Changes to Publications and Blank Forms) to Director, TRADOC ARCIC (ATFC-ED), 950 Jefferson Avenue, Fort Eustis, VA 23604-5763. Suggested improvements may also be submitted using DA Form 1045 (Army Ideas for Excellence Program Proposal).

Availability. This pamphlet is available on the Combined Arms Command webpage at <https://usacac.army.mil/sites/default/files/documents/ArmyEABConcept.pdf> and on JACD's DODTechSpace at <https://www.dtic.mil/dodtechspace/groups/army-capabilities-integration-center/projects/joint-and-army-concepts-division>

Contents

	Page
Preface	i
Forward	iii
Executive Summary	iv
Chapter 1 Introduction	1
1-1. Purpose	1
1-2. References	2
1-3. Explanation of abbreviations and terms	2
1-4. Background.....	2
1-5. Assumptions	2
1-6. Linkage to Army and joint concepts	4
Chapter 2 Operational Context	5
2-1. Introduction	5
2-2. Emerging OE and threats.....	6
2-3. MDO framework, competition continuum, and problem set	9
2-4. Six future challenges confronting EAB.....	12
Chapter 3 Military Problem and Components of the Solution	13
3-1. Military problem.....	13
3-2. Central idea.....	13
3-3. Solution synopsis.....	13
3-4. Components of the solution.....	14
3-5. Supporting ideas	22
Chapter 4 Operationalizing the Concept	28
4-1. Posturing EAB formations	28
4-2. Systems warfare approach.....	28
4-3. EAB operations against a near-peer threat: Rising to the challenges.....	32
4-4. Building capability at echelon	47
Chapter 5 Conclusion	51
Appendix A References	52
Appendix B Required Capabilities	58
Appendix C Science and Technology (S&T) to Support Future EAB Formations	61
Appendix D Risks of Adopting This Concept	69
Appendix E EAB Formations	70
Glossary	79
Endnotes	Error! Bookmark not defined.

Figure List

Figure 1. EABC logic diagram	v
Figure 2-1. MDO framework.....	10
Figure 2-2. MDO competition continuum	11
Figure 2-3. Six challenges confronting EAB formations.....	12
Figure 4-1. Composite system of systems	29
Figure 4-2. Attacking multiple system components	30
Figure 4-3. IADS and IFC complexity and density	32
Figure 4-4. Subordinate IADS subsystem visualization	38

U.S. Army Concept for Multi-Domain Combined Arms Operations at Echelons Above Brigade

Figure 4-5. Subordinate IFC subsystem visualization	38
Figure E-1. Future EAB headquarters command roles	71
Figure E-2. Factors affecting military span of control.....	74

Chapter 1

Introduction

1-1. Purpose

a. *The U.S. Army Concept for Multi-Domain Combined Arms Operations at Echelons Above Brigade 2025-2045 (EABC)* describes how senior Army warfighting formations at echelons above brigade (EAB) operate throughout the competition continuum to support the Army's four strategic roles; proposes how EAB formations might be structured and employed in the future; and identifies the changes and capabilities required at these echelons to meet the landpower demands of the future operational environment (OE) and prospective threats. The EABC provides a future vision to guide near-, mid-, and far-term capability development efforts.

b. The EABC poses the following questions to guide its development:

- (1) How does the past and present inform future Army EAB formations?¹
- (2) What are the main challenges and conditions of the future OE that influence how Army commanders at echelons above brigade exercise authority, direct action, control the employment of Army forces; enable subordinate units' operations across the entire operational framework; and gain and maintain the initiative in future multi-domain combined arms operations?²
- (3) What key command roles and functions must be accomplished by Army EAB formations in the future to ensure the Army is prepared for and can successfully execute its four strategic roles across the competition continuum in support of the unified action team?
- (4) How do formations above the brigade combat team (BCT) gain and maintain the initiative across the competition continuum and each geographic area of responsibility (AOR)?
- (5) How do future EAB formations see and understand the depth and breadth of their battlespace in and across all domains, the electromagnetic spectrum (EMS), and the information environment, and decide on a converged, multi-domain course of action that quickly creates windows of superiority in which to act decisively?
- (6) How do EAB formations shape the multi-domain battlespace for operational and tactical success and take cross-domain action and maneuver to strike the enemy rapidly at multiple decisive points and succeed across the entire competition continuum?
- (7) What enables EAB formations to continuously consolidate gains and endure throughout the length of future campaigns of competition.³
- (8) Based on the answers to the previous questions, how are future Army EAB formations structured and employed to conduct multi-domain combined arms operations and prevail in large-scale ground combat operations (LSGCO) against highly capable near-peer threats?

1-2. References

[Appendix A](#) lists required and related publications.

1-3. Explanation of abbreviations and terms

The [glossary](#) explains abbreviations and special terms used in this pamphlet.

1-4. Background

a. Historical transformations at EAB.

(1) *Transitioning from a division- to a brigade-based force.* Throughout much of the 20th century, the Army's largest tactical-fixed organization was the division echelon. In both the Reorganization of Army Division (ROAD) and the Army of Excellence (AOE) design constructs, a division generally consisted of three maneuver brigades, an artillery brigade, an aviation brigade, a division support command, and a division base of specialty troops (intelligence, engineer, signal, and air defense). Under ROAD and AOE, theater armies and corps provided additional capability and capacity to divisions and brigades but often rigidly commanded at those higher echelons with limited decentralization of their enabling capabilities to directly support lower echelons.

(2) *Seeking greater agility, versatility, and deployability through modularity.* Modularity shifted the stand-alone, combined arms building blocks from divisions to BCTs. Under the modular force concept, the Army divested the division structure of its organic or assigned functional battalions, and the corps of many of its separate brigades. The Army used the divestiture of these critical enablers—traditionally required to conduct LSGCO against near-peer threats—as the bill payers to build organic combined arms capabilities into the BCTs, and to create functional and multifunctional brigades and theater commands.

(3) *Determining the number of EAB headquarters needed for large-scale combat operations.* During the modular concept's early development, the Army sought to determine the minimum number of EAB headquarters required to command and control land forces effectively during LSGCO. This early modular concept relied, in large measure, on attaining and maintaining sea, air, space, cyberspace, and information superiority throughout the employment of future, technologically advanced BCTs.⁴ However, based on the increasing complexity of the future OE, including a multitude of joint, interorganizational, and multinational operational considerations; a continental U.S. (CONUS)-based force posture; and the anticipated lethality of future battlefields necessitating greater dispersion and decentralization; Army experimentation has continued to validate the need for *at least three* EAB formations during the conduct of LSGCO.⁵

1-5. Assumptions

a. The assumptions from hierarchical joint and Army concepts apply equally to this concept. The following additional (or modified) assumptions are required for this concept.⁶

b. Domain and information superiority or supremacy is not guaranteed as the land, air, maritime, space, and cyberspace domains, the EMS, and the information environment will become even more congested, contested, competitive, and combative during this concept's timeframe.⁷

U.S. Army Concept for Multi-Domain Combined Arms Operations at Echelons Above Brigade

c. While lower probability of occurrence, the risks associated with unpreparedness for LSGCO against a near-peer enemy are unacceptably high.⁸

d. Credible conflict deterrence requires credible large-scale warfighting capabilities at all echelons and in all domains. Future EAB formations must be optimized for warfighting at the upper end of the conflict continuum.

e. Future EAB headquarters will continue to fulfill five key command roles as Army Service component command (ASCC) to a geographic or functional combatant command; joint task force (JTF) command; joint force land component command (JFLCC); intermediate tactical command; and the senior Army command—the ARFOR—in a joint force command. Additionally, dual-command roles as a JTF and ARFOR are unmanageable without additional resources and normally will not be assigned to a single Army echelon. (See [appendix E](#) for discussion of these roles.)

f. Even with future repositioning and persistent rotational engagement of Army forces in overseas areas vital to U.S. security interests, the largest percentage of the force will remain based in CONUS.⁹ Therefore, to gain and maintain the initiative in competition below armed conflict and later, CONUS-based forces must become highly expeditionary—in capability and mindset.¹⁰

g. Army forces will always plan, train, and operate with joint, interorganizational, or multinational partners, or any combination, to conduct multi-domain combined arms operations and to integrate the national power (U.S. and coalition) needed to mitigate or overcome threat parity or overmatch, and consolidate gains to achieve lasting outcomes.

h. Alliance headquarters and forces may be available but, because of geopolitical reasons, other nations may not commit forces in time or in sufficient numbers to seize the initiative in transition to and during the initial stages of LSGCO.¹¹

i. U.S. government and other interorganizational partners may be available for planning and coordination but, because of lack of capacity, security concerns, or other reasons, may not commit necessary capabilities during armed conflict.

j. The U.S. will maintain the unified command plan construct and the Army will maintain (at a minimum) its current statutory composition and functions, as well as its Title 10, Army support to other Services (ASOS), and Department of Defense (DOD) executive agent (EA) authorities and responsibilities.

k. The ability to tailor, task organize, and deploy the force rapidly and expertly remains critical to achieving the level of agility and versatility required in future operations.

l. BCTs endure as the principal, cohesive, combined-arms building blocks in generating and maintaining unmatched lethal combat power for future close fights.¹²

m. Functional and multifunctional formations will be attached or assigned to the appropriate echelon based on the situation, the mission, and the role(s) that each EAB headquarters fulfills.

n. Information technology and artificial intelligence (AI) may enhance staff productivity, lower staff personnel requirements, and speed and improve decision making in the future, but will not significantly increase an EAB commander's span of control in LSGCO.

o. Army organizations manned, equipped, and trained to operate best in highly decentralized operations can operate under centralized control when required. However, the reverse is less likely to be true. Army organizations that are manned, equipped, and trained to operate best under centralized control will be unable to operate dispersed and decentralized to the degree and speed necessary for future operations in dense urban and other complex environments.

p. An intelligent, learning, and adaptive enemy will be able to counter or degrade the Army's current and future technological advantages.¹³ Similarly, Army forces, as learning organizations, will be able to counter or degrade future threat capabilities, strategies, and tactics.¹⁴

q. Army organizations that habitually train and operate together under clear command and support relationships are better able to identify opportunities, converge capabilities, seize the initiative, present increased cross-domain dilemmas, and develop the cohesion and trust needed to overmatch future threats.

r. Sufficient resources will be available to realize this concept through growth of enabling formations, rebalancing of active and reserve components, or a combination of both.

1-6. Linkage to Army and joint concepts

a. The EABC builds on the ideas presented in the U.S. Army Training and Doctrine Command (TRADOC) Pamphlet (TP) 525-3-0, *The U.S. Army Capstone Concept (ACC)*, TP 525-3-1, *The U.S. Army Operating Concept: Win in a Complex World (AOC)*, and the concurrently developing *The U.S. Army in Multi-Domain Operations (MDO) Concept* to further define what the future Army must do and how it operates across multiple domains to accomplish strategic, operational, or tactical objectives as the dominant landpower component of the Joint Force.¹⁵

b. *The ACC*. The ACC states that the Army provides decisive landpower through credible, robust capacity to win while maintaining the depth and resilience to support combatant commanders across a range of military operations. Through this lens, the EABC describes how future EAB formations support theater campaign plans through their execution of security cooperation, ASOS, and DOD EA responsibilities while maintaining an operational focus that supports the Joint Force in winning the Nation's wars.

c. *The AOC*. The AOC envisions globally responsive combined arms teams that maneuver from multiple locations and across all domains to present multiple dilemmas to the enemy, limit enemy options, avoid enemy strengths, and attack enemy weaknesses. In this context, the EABC describes how future EAB formations—in concert with the rest of the Joint Force—integrate joint, interorganizational, and multinational partner capabilities and adapt quickly to defeat enemy organizations, control terrain, secure populations, consolidate gains, and preserve Joint Force freedom of action in and across multiple domains.¹⁶

d. *The Joint Concept for Integrated Campaigning (JCIC)*. The JCIC identifies ways to challenge near-peer rivals' activities short of armed conflict. The JCIC replaces the binary peace-war paradigm with one of cooperation, competition below armed conflict, and armed conflict.¹⁷ The idea of continual versus discrete campaigns highlights that near-peer rivals are contesting U.S. forces and partners continuously during periods traditionally considered peace. These ideas are central to the MDO Concept and drive U.S. forces to contest threats actively, persistently, and aggressively in competition short of armed conflict. The EABC describes how future EAB formations support these ideas through activities and operations within the JCIC's overarching competition continuum and the MDO Concept's more narrowly focused one. Additionally, the EABC identifies the necessity of rapidly transitioning to and from armed conflict in order to maintain freedom of action and positions of advantage while denying adversaries the same.

e. *The MDO Concept*. The MDO Concept describes how the Joint Force and its partners converge capabilities to create windows of superiority that enable cross-domain maneuver. Maneuver—physically, virtually, cognitively, or any combination—executed simultaneously across the expanded battlespace, seeks to directly attack critical vulnerabilities in the adversary's systems and foil his campaign plans in different ways to create multiple dilemmas for the enemy. Creating multiple physical, virtual, and cognitive dilemmas for the enemy overwhelms the adversary's systematic approach to fracturing friendly forces' cohesion, and allows the Joint Force and partners to achieve friendly objectives at acceptable levels of risk. In addition to the use and modification of the JCIC's competition periods, the MDO Concept contains another key construct particularly applicable to future EAB formations—an extended operational framework. Both of these constructs and the MDO Concept's future problem set are described at the end of the next chapter.

Chapter 2

Operational Context

2-1. Introduction

a. Future Army forces, as part of joint, interorganizational, and multinational teams, contend with dramatic advances in science and technology (artificial intelligence, hypersonics, robotics, directed energy, precision long-range fires, electronic warfare, advanced cyberspace, and others) that are advancing and proliferating through increased speed of human interaction and societal changes. Future enemies threaten U.S. interests in uncertain, complex, highly competitive, politically volatile, and lethal OEs. These enemies contest the U.S. and its allies in all domains and throughout the continuum of competition to gain advantage and achieve decisive effects.

b. Enemies and adversaries employ a mix of capabilities to create hybrid threats with significantly higher capabilities and lethality levels that exploit U.S. vulnerabilities and ability to transition to armed conflict. Threat lethality is driven by the merger of information and sensor technology overlaid on both old and new weapons systems. Using advanced long-range weapons, future threats seek to deny U.S. forces operational and strategic freedom of action in—and during the transition to—armed conflict. Future EAB formations face enemies that employ information

warfare and cyber capabilities at a level short of traditional conflict to generate social, political, and economic disorder for their operational advantage. EAB formations' ability to execute operations that mitigate adversary successes during competition below armed conflict, coupled with their demonstrated ability to transition to—and prevail in—armed conflict, is essential to protecting U.S. national interests. The following trends frame the context of EAB operations in the future.

2-2. Emerging OE and threats

a. *Contested in all domains.* By 2025, the proliferation of technology propelled by the explosion of available information enables enemies or adversaries, including non-state actors and super-empowered individuals, to aggressively contest operations across all domains and environments.¹⁸ A growing global interconnectivity fueled by advances in electronics increases rapid access to information and, consequently, increases the velocity and momentum of human interaction and events.¹⁹ Technology previously unavailable to less-resourced nations and individuals are now available on the internet and used with little regard for the moral or ethical consequences. Weapon and explosive fabrication instructions as well as necessary raw materials are only a mouse click away, potentially negating huge national investments in research and development through such easy network access. Overall, lethal and nonlethal systems are easier to afford, gain access to, and manufacture, providing asymmetric opportunities across the whole competition continuum.

(1) Future enemy forces use ground-based, long-range, precision anti-surface and air defense systems—integrated with air, maritime, cyberspace, and space strike capabilities—to deny U.S. forces access to the conflict zone. If entry is achieved, enemy extended-range, massed fires, augmented with precision munitions engaging high payoff targets, challenge traditional large-scale land assembly, maneuver, and sustainment. Gaining and maintaining freedom of movement and maneuver is increasingly difficult. Future advanced enemy and adversary unmanned systems threaten U.S. formations at depth and provide the enemy with dynamic situational understanding and precision targeting. In space, cyberspace, and the EMS, adversaries take advantage of U.S. and coalition reliance on space-based intelligence, surveillance, and reconnaissance and positioning, navigation, and timing (PNT); networked mission command information systems, including secure satellite communications; and other network-enabled weapon systems.

(2) Future threats contend aggressively in the information environment throughout the entire competition continuum, seeking to deny support from civilian, political, and military audiences. Increasingly, they use propaganda, disinformation, misinformation, and deception to shape the environment to present an inaccurate or uncertain picture. Future enemies attempt to distort and prevent accurate situational understanding by and between military and civilian audiences. To accomplish their objectives, they develop and employ sophisticated computer bots and algorithms to affect how individuals and groups process, perceive, judge, and make decisions. By affecting the other dimensions of the information environment, future enemies reach into the most important of the three dimensions, the cognitive dimension. Overall, future threats and adversaries seek to fracture the Joint Force's coherence along the "seams" between operational domains and Service functions, alliance members, and civilian and political support for military operations. In the future, the truth is increasingly more difficult to ascertain, and the opponent that is able to drive their narrative most effectively maintains a continuous cognitive position of advantage.

b. *Lethality.* Advancements in weapons technology, sensors, communications, and information-processing capabilities dramatically increase lethality.²⁰ Future enemies detect, track, and target Army forces and activities throughout the depth of the expanded battlefield, across all domains, and within the EMS and seek to gain direct and indirect fires overmatch with increasingly capable conventional and unconventional forces. They integrate directed-energy weapons (lethal and nonlethal), guided missiles, direct-fire platforms, and autonomous weapon systems. As threat human-computer interfaces and AI mature, future EAB formations become potentially vulnerable to faster kill chains with devastating firepower. Future enemies employ AI and autonomous systems to expedite targeting unconstrained by ethical norms that would require a human decision maker in the loop.²¹ The proliferation of weapons of mass destruction presents an increasing threat to ground forces and civilians overseas and in the United States. Rogue states, radical ideologues, and criminals may gain access to chemical, biological, radiological, and nuclear (CBRN) weapons, along with technologies to employ them, such as guided missiles and remotely piloted aircraft.

c. *Degraded operations.* Future threat weapons technologies place mission command information systems at direct risk of disruption. Advanced informatics, datamining, and AI enable threats to develop innovative heuristics for conceptualizing and managing engagements across domains. The enemy interrupts, denies, and destroys friendly communications networks as a central part of their operational concept. Army command posts (CP) are vulnerable to attacks in and through cyberspace and the EMS, as well as conventional indirect and air-delivered fires and CBRN attacks. Future threats attack space systems and supporting communications nodes from cyberspace and by ground- or air-launched anti-satellite weapons—both ballistic and directed-energy. Enemies and adversaries leverage electronic warfare (EW) capabilities to disrupt and degrade EAB formations' and Joint Force capabilities and digital networks. They time these attacks to maximize the effects of other actions on the battlefield. For instance, enemies and adversaries seek to simultaneously degrade sensors and information systems used to create a multi-domain common operational picture, disrupting or preventing the flow of logistics, full use of all joint fires, and employment of precision munitions.

d. *Regional hybrid threats and radical ideologues operating in dense urban terrain and among populations.*

(1) Urbanization and the proliferation of communications technology increase the probability of operating in highly congested and contested information environments, under continuous surveillance, and within complex human terrain. Enemies' willingness to employ lethal capabilities in close proximity of populations, contrasted with the U.S. and allied reluctance to endanger noncombatants, compound the task of threat identification and targeting. Constricting topography and poor infrastructure of many dense urban areas expose friendly movement, allowing enemies to disrupt forces operating from or into these areas. These same characteristics pose significant challenges for communications, reconnaissance, surveillance, and achieving surprise.

(2) Social media help enemies expand their influence and build support in domestic, neutral, and allied nations while radical ideologues hide in and among sympathetic populations within dense urban terrain to conceal their identities and intentions. They use the interconnected world to

spread their radical ideas and manipulate social media to present only their version of events. Globally networked populations react to biased versions of events at the speed of the internet, complicating friendly ability to discern an accurate, intelligence-driven understanding of the situation. Future hybrid threats mix ideological, political, and criminal activities to gain positions of advantage against friendly forces. They develop and employ tactics and methods that prevent U.S. forces from directly attacking their organizational capabilities. Two primary methods are preventing attribution and shielding to create deniability, and exploiting U.S. policy to deter U.S. engagement.

*e. Competition below the threshold of armed conflict.*²²

(1) Future enemies and adversaries see themselves in a constant competition with the U.S. and its allies. Because of the high political and economic costs of armed conflict with the U.S. and its allies, future threats try to achieve their political objectives without triggering military action and war. Future threats utilize sophisticated asymmetric or hybrid tactics to challenge the U.S. and its allies' security interests.²³ These tactics leverage combinations of information warfare, cyberspace operations, EW, nonlethal directed-energy weapons, unattributable CBRN attacks, and unconventional warfare to prepare, infiltrate, isolate, and incite dissent and disruption in nations that are a target of their aggression.²⁴

(2) Against Russian "New Type War," the U.S is confronted with Russian state information warfare that is combined artfully with conventional and unconventional military operations. Russian use of information warfare obfuscates the true intent of ground and special purpose forces operating near their borders or in a neighboring nation. Russian actions in Ukraine and Crimea provide a prime example. Future threat approaches include advanced weapons and technology applied and mixed innovatively with crude, simple, and unsophisticated means to create parity or overmatch against Army forces.²⁵ Future enemies and adversaries skirt ambiguous aspects of international law and capitalize on war-averse attitudes that make countries hesitant to enter conflict when legitimacy questions persist. Threats use information and psychological warfare to cause populations to support or allow aggression even to the detriment of their own country.²⁶

f. Most dangerous and most likely threats.

(1) The *most dangerous* threat to future EAB formations is a near-peer threat with nuclear capabilities and modernized, integrated, cross-domain-capable, anti-access and area denial (A2/AD) capabilities operating within interior lines.²⁷ Use of these threat capabilities challenge future EAB operations across the competition continuum, with emphasis on preventing employment of joint reconnaissance, surveillance, intelligence, and fires, and denying ground forces freedom of entry, movement, and action. In the air domain and the EMS, future threats place EAB operations at risk in depth with robust extended-range theater ballistic missiles, cruise missiles, special purpose forces' direct action, and strikes with advanced, fifth-generation aircraft. Due to the operational impact of these attacks, future EAB formations are challenged to fully plan and execute converged operations, particularly with partners. This type of threat may also preclude intergovernmental agency participation until Army forces can establish adequate security. Consequently, Army forces must be prepared to assume many interagency functions during initial and post-campaign periods.

(2) The *most likely* future threat EAB formations face is a radical ideologue engaged in a local or regional insurgency, supported by a near-peer nation-state, challenging international order and U.S. interests. This type of threat establishes militarized organizations among sympathetic populations and uses information technology to connect and recruit followers in the region and worldwide, including within the U.S. homeland. Though radical ideologues' primary military emphasis are ground operations in sympathetic areas, they seek to attack U.S. military, political, and economic targets at home and in other areas of the world.²⁸ These groups organize for combat in small, highly adaptable elements and employ fluid and adaptive tactics. Radical ideologues employ remotely piloted aircraft, advanced weapons obtained through the black market or from their state sponsors, and armor and artillery provided by their state patrons or made available through the surrender of enemy forces. Radical ideologues use fear as a primary tool to coerce unsympathetic populations to either remain neutral during a U.S. intervention or, at worst, actively support the radical ideologue against U.S. forces.

g. *Alternate most likely: Nuclear regional hegemon.* These future adversaries employ combinations of extended-range missile forces, second-generation air defense systems, and late-generation EW systems that operate under an explicit threat of nuclear escalation. They rely heavily on surprise, mass, unconventional forces, and asymmetric tactics. The possession of nuclear weapons adds a dimension to the conflict that any entity choosing to intervene must consider. Deterrence of these threats requires a careful balance in the application of U.S. forces so that miscalculations or misperceptions do not lead to use of nuclear weapons in a political context that prevents a U.S. proportional response.

2-3. MDO framework, competition continuum, and problem set

a. The MDO operational framework provides an expanded physical, virtual, and temporal perspective and accounts for the ability of future adversaries to contest U.S. forces in all domains to achieve effects in both their near abroad and, in some cases, strategic abroad. This multi-domain operational framework accounts for an extended strategic, operational, and tactical battlespace, and aids in identifying where multi-domain capabilities are required across a campaign.

(1) MDO describes friendly forces' actions across domains, linked in time, function, and physical space to defeat the adversary's systems in competition below armed conflict, armed conflict, and a return to competition below armed conflict. Competition below armed conflict occurs when two or more actors in the international system have incompatible interests but neither seeks to escalate to open conflict. Armed conflict occurs when the use of violence is the primary means by which an actor seeks to achieve its political outcomes. Return to competition below armed conflict occurs when fighting ceases and one or both combatants find it impossible to gain a decisive result.

(2) Spaces in the extended operational framework are: deep fires (strategic and operational), deep maneuver, close, tactical support, operational support, and strategic support areas (see figure 2-1). This operational framework has four layers: physical, temporal, virtual, and cognitive.²⁹ Both the MDO Concept and EABC postulate how future Army EAB formations—working together—might overlay on this framework to help determine capabilities (including authorities) required at

U.S. Army Concept for Multi-Domain Combined Arms Operations at Echelons Above Brigade

echelon, across the competition continuum, and throughout each layer of the framework to see and understand, decide, shape, strike, and endure to win in LSGCO and achieve lasting outcomes. [Chapter 4](#) describes a systems warfare approach and operational approach to the six challenges that conclude this chapter.

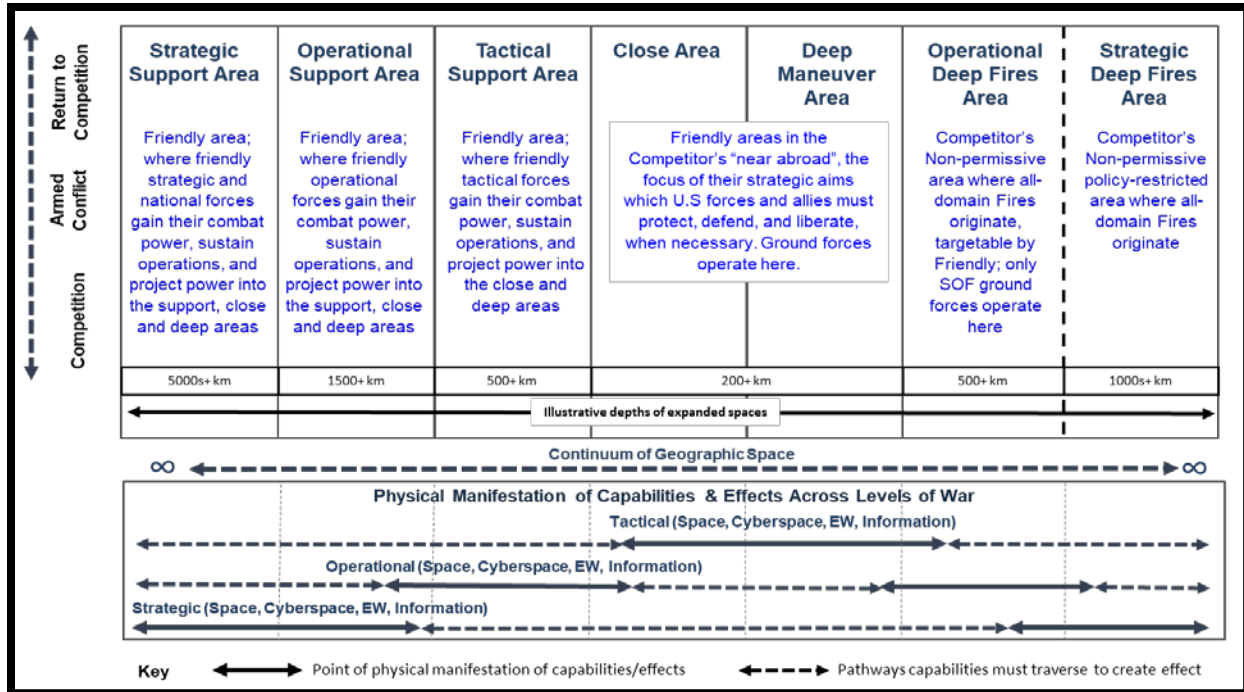

Figure 2-1. MDO framework

(3) The operational framework portrayed in figure 2-1 illustrates the breadth and depth of activities, spaces, distances, and interrelationships for which future multi-domain operations must account. While it may appear linear and static, this is not the case. In fact, these areas are defined primarily by conditions and, at times, some areas may be nonexistent. For example, the close area is where friendly and enemy formations, forces, and systems are in imminent physical contact. When friendly and enemy forces are not in “imminent physical contact,” the close area of the expanded battlespace collapses into a simpler construct. In this way, the conceptual “boundaries” within the MDO’s operational framework ebb and flow over time.

b. The competition continuum. The MDO Concept modifies the JCIC competition continuum to encompass three campaign activities: competition below armed conflict, armed conflict, and a return to competition below armed conflict.³⁰

(1) *Competition below armed conflict* occurs when two or more actors in the international system have incompatible interests but neither seeks to escalate to open conflict. During competition below armed conflict, Army forces will support U.S. interests through the theater campaign plan. Additionally, the MDO Concept envisions defeating adversary aggression by countering destabilization campaigns, deterring escalation through rigorous deployment and training exercises, building strong interorganizational partnerships through routine planning and integration in training exercises and deployments, and building strong multinational partners through security cooperation and security force assistance. Each of these are executed while

simultaneously conducting basic, intermediate, and advanced target development to enable the immediate transition to armed conflict should the adversary attack.

(2) *Armed conflict* occurs when the use of violence becomes the primary means by which an actor seeks to achieve its political outcomes. During armed conflict, the MDO Concept envisions the defeat of the enemy’s conventional forces in a rapid campaign of maneuver across all areas of the expanded battlespace in multiple domains and locations simultaneously, denying the enemy its strategic objectives without further escalation. The Joint Force and its partners succeed by repulsing the enemy’s initial attacks, denying *fait accompli* objectives, protecting populations, and setting conditions for a negotiated solution on favorable terms.³¹ As this occurs, competition below armed conflict likely continues in peripheral parts of the theater.

(3) *Return to competition below armed conflict* occurs when fighting ceases and one or both combatants find it impossible to gain a decisive result. During the return to competition below armed conflict, a still-capable near-peer adversary seeks to actively subvert and attack the U.S., partners, and alliances lethally and nonlethally. During the return to competition below armed conflict, the MDO Concept envisions success as protecting partners (internally and externally) and renewing the competition on terms favorable to the U.S. and its partners, while preventing a return to armed conflict. See figure 2-2 for these campaign activities and how they might generally relate to the Army’s four enduring strategic roles.

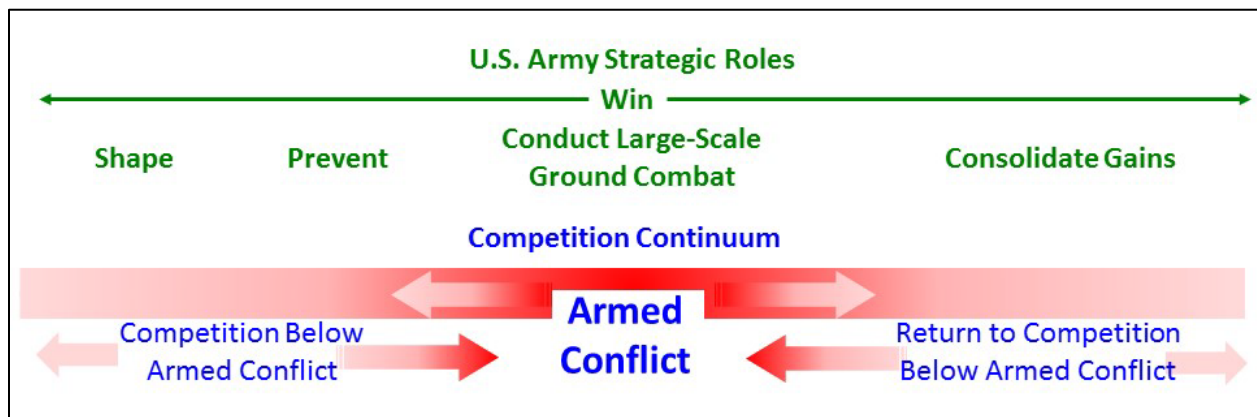

Figure 2-2. MDO competition continuum

c. The MDO Concept assessed the emerging OE and identified five main problems for the *Joint Force* in competition and armed conflict.³² These five problems are:

(1) How does the Joint Force compete to enable the defeat an adversary’s operations to destabilize the region, deter the escalation of violence, and, should violence escalate, enable a rapid transition to armed conflict?

(2) How does the Joint Force penetrate enemy anti-access and area denial systems throughout the depth of the Support Areas to enable strategic and operational maneuver?

(3) How does the Joint Force dis-integrate enemy anti-access and area denial systems in the Deep Areas to enable operational and tactical maneuver?

(4) How does the Joint Force exploit the resulting freedom of maneuver to achieve operational and strategic objectives through the defeat of the enemy in the Close and Deep Maneuver Areas?

(5) How does the Joint Force re-compete to consolidate gains and produce sustainable outcomes, set conditions for long-term deterrence, and adapt to the new security environment?

2-4. Six future challenges confronting EAB

a. The emerging OE, threat capabilities, and enemy operational methods reveal six distinct challenges for future forces operating across the various, diverse, and distinct theaters. Ultimately, U.S. forces within a theater seek to prevent conflict allowing other means to achieve objectives. To do this, future Army forces must possess specific capabilities for the multitude of potential tasks short of conflict as well as those necessary to prevent conflict. However, if prevention fails, they must also be able to quickly transition to armed conflict, penetrate enemy denial efforts, defeat capable near-peer forces, consolidate gains, and return the theater to a more stable environment. These six challenges are shown templated across the competition continuum and range of military operations in figure 2-3. These challenges are enumerated below and further addressed in the [chapter 4](#) discussion of operationalizing this

disintegrate vs. dis-integrate

Disintegrate (without a hyphen) is one of four defeat mechanisms (isolate, dislocate, disintegrate, and destroy) used by friendly forces against enemy opposition. In this context, disintegrate means to disrupt the enemy's command and control (C2) system, degrading its ability to conduct operations while leading to a rapid collapse of the enemy's capabilities or will to fight. Dis-integrate (with a hyphen) is used throughout the EAB concept in a broader systems warfare context to express the convergence of multi-domain capabilities against specific nodes and pathways of a system or subsystem (including C2). Sequentially degrading parts of the system creates additional vulnerability ultimately leading to the overall defeat of the larger system.

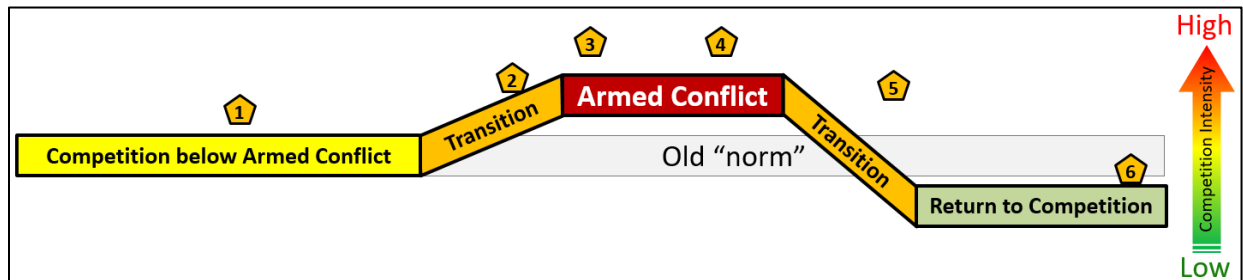

concept.

Figure 2-3. Six challenges confronting EAB formations

- (1) Maintain a persistent theater campaign of competition to understand and shape the security environment.
- (2) Rapidly transition to disrupt adversary risk calculus, deny freedom of action, and prevent conflict.
- (3) If prevention fails, dis-integrate the enemy's integrated air defense system (IADS) and integrated fires complex (IFC) to create windows of superiority in which to take decisive action.
- (4) Maneuver across and within all domains to defeat the enemy in LSGCO.
- (5) Defeat enemy resistance and means to protract conflict and consolidate gains.
- (6) Reestablish the campaign of competition at a lower level of competition intensity.

b. To address these challenges, future Army forces must be prepared to operate in perpetual competition while sustaining the readiness to fight across and through contested domains in depth. Recognizing the unique characteristics of each theater, formations at all echelons must configure

appropriately and capitalize on the strengths of all three Army components to generate a campaign-quality force able to gain and maintain an enduring initiative before armed conflict, prevail during conflict, and succeed during subsequent consolidation of gains in order to return to more favorable competition conditions.

Chapter 3

Military Problem and Components of the Solution

3-1. Military problem

Given the complex future OE, how do combined arms formations above brigade gain and maintain the initiative across the competition continuum to rapidly respond to unexpected crisis, deter or defeat malign influences below the threshold of conflict, prevail in LSGCO against capable near-peer threats, and continuously consolidate gains to reenter competition on terms favorable to U.S. interests?³³

3-2. Central idea

Formations above brigade gain and maintain the initiative by converging multi-domain capabilities at echelon and through the depth and breadth of the extended battlefield to develop and maintain a more accurate understanding of the operational environment and threats, continuously compete below the threshold of conflict, rapidly transition to conflict when necessary, discover or create multiple enemy vulnerabilities, exploit windows of superiority with tempo through cross-domain maneuver, and continuously consolidate gains to achieve enduring outcomes.³⁴

3-3. Solution synopsis

a. Future EAB formations *never cede the initiative* and always seek to be anticipatory versus reactive. They recognize that enemies strive continuously to impose their will upon U.S. forces, allies, and other partners. Consequently, EAB formations must persistently *see and understand* the environment across all the domains to identify adversary or enemy influence, whatever they may be—whether the adversary is poised on a border in conventional military units, conducting conventional and snap training exercises to build their readiness or influence neighbors, attempting to create political discord through diasporic populations, conducting covert cyberspace activities, or opining in unattributed newspaper editorials. Future EAB forces continually compete throughout the extended multi-domain environment to understand all actions that may shape the environment to an adversary’s advantage. Seeing where and how an adversary operates allows EAB commanders and staffs to discern hidden intentions and predict possible future actions. This persistent monitoring also reveals changes in adversary capabilities and orders of battle—both conventional and hybrid—which informs friendly force posture and escalation or de-escalation decisions. Future EAB formations’ ability to see and understand with persistence and accuracy is a crucial factor in enabling agile and timely multinational partner consensus for collective action.

b. This constant *seeing and understanding* reveals options for friendly forces to influence and intervene—in concert with the joint force commander’s intent—to impose or re-impose an EAB commander’s will against adversaries. Options coalesce as *decisions* where EAB commanders may employ forces and capabilities to either *shape* the environment to advantage and limit threat

options, or *strike* enemy systems at decisive points through cross-domain maneuver or fires. As formations continuously consolidate gains, they maintain a persistent focus toward retaining the initiative for a return to competition on more favorable terms. This initiative must be focused and *endure* against ever-adapting adversaries who will continue to resist through all possible means.

c. Shaping and striking actions are not always physical; more often, they may be virtual and cognitive (non-physical), particularly at higher echelons. Critical shaping and striking actions may take place during periods of relative calm, beneath public or general media visibility. However, even virtual and cognitive actions in non-physical domains and environments may produce very real effects in the physical environment—destructive and lethal effects traditionally associated with kinetic weapon systems. In the future OE, the lethal and nonlethal distinctions between physical, virtual, and cognitive effects, as well as differences between shaping and striking actions, become blurred. Synchronized and converged shaping and striking through both physical and non-physical means, in and through multiple domains, concentrate effects at decisive spaces and create multiple dilemmas for enemies leading to their isolation, dislocation, disintegration, or destruction.

d. Regardless of where friendly and adversary forces are positioned along the competition continuum, future EAB formations have a perpetual requirement to gain and maintain contact throughout all domains—and their various physical, virtual, temporal, and cognitive dimensions—in order to understand enemy dispositions and intentions. To achieve this, EAB forces conduct persistent reconnaissance, surveillance, and intelligence operations across all domains. As EAB forces purposefully and aggressively reconnoiter each domain, they gain the intelligence and insights necessary for commanders and staffs to discern patterns to understand the adversary, resident populations, and institution activities within an area. Similarly, EAB forces conduct persistent security operations in all domains to prevent an adversary or enemy from gaining positions of advantage. Armed with this understanding and the protection, early warning, and freedom of action gained from maintaining persistent contact, commanders converge friendly capabilities in a manner that forces adversaries to respond favorably without fully revealing friendly positions of advantage. These actions create known and predictable windows of superiority, allowing proactive forces to maintain an enduring initiative and capitalize on the gains achieved throughout the region while continuing to negate adversary influence.

3-4. Components of the solution

a. The EAB concept proposes six key components to address the military problem. These do not prescribe specific DOTMLPF-P solutions, but identify broad interrelated capabilities needed for the future force. These six overarching solution components encompass collective warfighting capabilities and apply to all echelons at all times. They are:

- | | |
|--|-----------------------------|
| (1) Gain and maintain contact. | (4) Converge effects. |
| (2) Persistently compete. | (5) Exploit the initiative. |
| (3) Calibrate force posture for LSGCO. | (6) Consolidate gains. |

b. *Gain and maintain contact to reveal adversary areas of influence and dispositions.* Future EAB formations aggressively and continuously conduct reconnaissance and surveillance in all domains to identify threat activities that reveal intentions, strategies, capabilities, and tactics. By

seeing and understanding the depth, breadth, and layers (physical, virtual, temporal, and cognitive) of the multi-domain battlespace, future EAB formations more easily maintain enemy contact and identify likely decisive points where the enemy attempts to gain positions of advantage. EAB formations achieve this battlefield understanding through proactive physical and virtual methods, including persistent cross-domain reconnaissance and surveillance; continuous security operations; perpetual, multi-domain, and multi-echelon operational preparation of the environment; and targeted deception and stimulation of threat systems at the right time and in a manner that cause enemies to react, displace, or reveal their physical, virtual, and cognitive dispositions.

(1) Persistent, cross-domain reconnaissance, surveillance, and counterintelligence. EAB formations converge joint, Army, and national-level human and technological reconnaissance, surveillance, and counterintelligence assets to detect—over time—adversary and resident population and institution strengths and weaknesses across all domains, the EMS, and the information environment. This allows Army forces to gain insights and maintain understanding of adversary and resident population and institution intentions, strategies, capabilities, and tactics—avoiding potential strategic surprise. EAB formations employ counterintelligence capabilities to identify threat sympathizers, informants, and agents to deny the threat these important sources of information on friendly dispositions and intentions.

(2) Continuous security operations. Continuous security operations include the protection tasks and systems required to mitigate threat actions designed to penetrate and exploit potential seams or gaps within the Joint Force, and lessen or eliminate human security threats.

(a) To deny threats from gaining positions of advantage, EAB formations continuously execute both passive and active security operations across all domains by gaining and maintaining enemy contact, orienting on the protected force or space, performing continuous cross-domain reconnaissance, providing early and accurate warning, and providing reaction time and maneuver space through physical, virtual and cognitive security-related tasks. Future security operations include traditional security tasks of screen, guard, cover, area security, and local security, which not only remain valid but are increasingly more important in the future extended and competitive battlespace. In the virtual space, security tasks focus on network protection and defensive cyberspace operations. In the cognitive space, security operations focus on informing and influencing friendly and neutral audiences and conducting information environment operations to counter malign narratives.

(b) Simultaneously, EAB formations influence and deny threat situational understanding through imaginative deception activities, physical and electromagnetic obscuration and camouflage, counterintelligence, and tenacious operations security measures to protect friendly information and activities. EAB formations are able to expertly employ camouflage, concealment, cover, deception, and decoys (C3D2) and operations security to such a high degree that adversaries doubt their own capabilities to find, track, and accurately engage friendly forces and equipment. Additionally, hardening of multi-domain systems in layers throughout all levels, integrated with deception and obscuration operations, degrade the threat's ability to gain friendly situational understanding.

(3) Perpetual, multi-domain, and multi-echelon operational preparation of the environment. Theater-level formations continuously manage the theater to establish and maintain the diplomatic, military, and infrastructure conditions for joint entry, freedom of action, and endurance to last throughout a campaign.³⁵ EAB formations sustain alliances and achieve cooperative interoperability that thwart adversary attempts to fracture partnerships. Further, EAB formations conduct security cooperation to build partner capabilities needed by the alliance as a whole, and in the countries and areas they are most needed. EAB formations map and constantly update cyberspace and electromagnetic activity across both physical and virtual domains. Additionally, EAB formations monitor social media across the spectrum of platforms in adversary nations and, when necessary, utilize these same platforms to foment disorder and attack the adversary's political, economic and informational systems. Similarly, EAB formations conduct physical, virtual, and cognitive demonstrations, training exercises, and shows of force across all domains to exhibit capability and resolve, and to deter adversaries.

(4) Reveal physical, virtual, and cognitive dispositions. EAB formations maneuver disaggregated and possess increased speed, mobility, C3D2, improved jam-resistant networks, and longer weapons and acquisition system ranges to facilitate greater dispersion, while still allowing EAB forces to mass effects and provide mutual support when and where required. Reconnaissance, security, intelligence, and fires elements are able to infiltrate into position at small-unit or entity level; emplace remotely activated ground and air deception decoys (physical and electronic); stimulate adversary intelligence, reconnaissance, and surveillance systems physically or electronically; and move rapidly to other concealed locations under physical or electronic C3D2. In this manner, adversaries are presented with the dilemma of either allowing friendly forces unimpeded freedom of movement, or risk exposing key components of their fires or air defense systems to counterfires if they choose to engage deceptive decoys, small units, or other elements of seemingly low tactical or operational significance.

(a) EAB formations employ cyberspace deception, forensically analyze cyberspace attacks for attribution, and conduct cyberspace reconnaissance and surveillance to see and understand threat cyberspace. EAB formations also position cyberspace tools to hold adversaries at risk, defeat cyberspace intrusions, and conduct cyberspace attacks to influence adversary cyberspace behavior and gain cyberspace positions of advantage.

(b) To determine an adversary's cognitive disposition, EAB formations gain superior understanding of the information environment and the combined effects of ubiquitous media, social networks, personal interactions, civil-military operations, political movements, and adversary tactical actions.

c. Persistently compete below the threshold of armed conflict from positions of advantage. EAB formations compete below the threshold of armed conflict through proactive engagement with non-hostile actors, deceiving or stimulating adversary systems, conducting aggressive information environment operations, and demonstrating the capability to rapidly escalate along the competition continuum. Such actions aim to deter aggression or, if deterrence fails, set the conditions necessary to prevail and win decisively. EAB formations compete by deciding what conditions can be created and exploited, aligning partner objectives, and, at the same time, shaping competitor behaviors. Through continuous information environment operations, future EAB formations effectively

monitor the information environment, counter malign narratives, generate an overwhelming friendly narrative, and ubiquitously participate in public forums to accurately gauge the cognitive effect such initiatives have on the perceptions and behaviors of friendly, hostile, and neutral actors in the AOR.

(1) Proactive engagement with all non-hostile actors. By seeking out allies and other partners, neutrals, and non-hostile influencers within a region, EAB formations can outpace adversary actions. Relationships with allies and existing friendly parties are reinforced through partnering, exercises, and persistent civil engagement. Additionally, EAB forces strive to find common interests to align neutrals and increase the probability that they and other non-hostile actors will sympathize and align with friendly forces if hostilities should ensue. Engagement takes place tactically, operationally, and strategically. Engagement can take the form of repositioning rotational forces based on a need to reassure allies and partners and provide deterrence to adversaries, or by changing deployment timelines or reorienting regionally aligned forces to support other actions. Prepositioned stocks, never-ending set-the-theater operations, focused security force assistance, continuous theater security cooperation, and perpetual multinational interoperability activities contribute to proactive engagement to maintain access and assurance, and deter adversaries.

(2) Deceive and stimulate adversary systems. Throughout the competition continuum, EAB formations establish the means to uncover or expose enemy systems and gain greater understanding of their locations, strengths, weaknesses, and employment tactics and techniques. Multi-domain deception operations may force adversaries to adjust their plans and timelines, enabling EAB forces to outpace enemy planning and decision cycles. Using realistic deception (physical, electronic, and informational) may stimulate the adversary to react, exposing their locations, and increase ambiguity so that threats do not trust their own information. This deception allows friendly momentum and initiative and creates windows of superiority in which EAB formations can strike vulnerable targets.

(3) Conduct aggressive information environment operations. The employment of aggressive and sustained information environment operations generates favorable cognitive conditions to support achievement of strategic, operational, and tactical objectives. With a well-developed understanding of the information environment and cultures, EAB formations plan the appropriate messaging strategies and delivery methods throughout the competition continuum to neutralize threat efforts, create favorable conditions for friendly activities, and dominate the information environment.

(4) Exhibit the capability to escalate or transition rapidly. EAB formations require a dynamic mix of forward presence forces, expeditionary forces, and partner forces to respond rapidly to the adversary's escalations throughout all domains. EAB formations are equipped with the necessary headquarters, units, and capabilities to persistently compete below armed conflict but, in order to prevent escalation, additional forces, prepositioned equipment and stocks, and capabilities are postured appropriately to rapidly transition to combat at a tempo the adversary cannot match. Competition activities beneath armed conflict serve to delay and disrupt adversary escalation timelines to friendly advantage. In order to maintain the ability to endure preemptive threat action,

formations operating in theaters with a near-peer threat couple a dispersed force posture with hardened networks and distributed, survivable, fixed and mobile CPs.

d. *Properly calibrate force posture for rapid transition to LSGCO.* Army forces posture for LSGCO across all three Army components by aligning and positioning units in a manner responsive to escalation timelines and distributing capabilities at the appropriate echelon. Properly calibrated force posture sets conditions for formations to promptly oppose aggression, strike decisively, sustain forces, and endure throughout a campaign. To accomplish this, Army forces establish reconnaissance, surveillance, and deception-saturated offensive or defensive covering force security zones based on the mission variables. In support areas and forward locations, EAB formations employ C3D2 coupled with operations security and hardening of static positions to reduce vulnerability. During the transition to LSGCO, Army forces operate physically and virtually disaggregated, while deploying key systems into physically and electronically dispersed hide-sites to gain improved situational understanding, establish protected positions of advantage, and set conditions to transition rapidly to offensive operations.

(1) Distributed force posture and capability at echelon. Force posture encompasses forward-postured forces, rapidly deployable formations, sufficient and swift transport means, and integration of joint, interorganizational, and multinational partner capabilities, as well as the relationships, activities, facilities, legal arrangements, and sustainment necessary for proper employment. EAB formations require a dynamic and agile force posture to compete with adversaries by creating multiple dilemmas through periods of domain superiority and then exploiting revealed cross-domain vulnerabilities rather than simply reacting to an adversary's actions. EAB formations must be tailored throughout each echelon appropriately to provide the formations and capabilities required to operate across the entire multi-domain battlefield, and, if necessary, rapidly transition to and win in armed conflict.

(2) Establish and saturate offensive or defensive covering force security zones with meshed reconnaissance, surveillance, security, long-range fires, and deception capabilities.³⁶ EAB formations integrate a dispersed combination of sensors and remotely activated emitters, and semi-autonomous and remotely piloted ground (including subterranean) and aerial systems infused and enabled with various levels of AI. Simultaneously, EAB formations integrate cyberspace and space-based systems (including high-altitude), redundant ground and airborne tactical reconnaissance and security forces, and special operations forces (SOF). Establishment of security zones and integration of these multi-domain capabilities enable EAB formations to deceive, stimulate, locate, and strike the enemy's IADS and IFC from multiple disaggregated points of presence while maintaining survivability and freedom of action.

(3) Operate disaggregated and infiltrate key systems into security zones. As conditions are set to achieve windows of superiority for cross-domain maneuver into the close fight, EAB formations operate disaggregated to make friendly decisive operations ambiguous and cause the enemy to orient in multiple directions. Friendly forces aggregate rapidly and unpredictably, and disaggregate quickly to maintain pressure on the adversary. Enemy forces in the defense are stretched, creating weak points for penetration or envelopment. Enemy forces on the offense are diffused, which reduces their mass and enables friendly forces to block advances while creating or exposing assailable flanks for divisions and their subordinate BCTs to exploit.

(a) EAB formations use a combined arms, cross-domain systems warfare approach to locate and destroy key enemy capabilities that cause dislocation, disintegration, or isolation of threat air defense and fires complexes. To do this, disaggregated EAB forces infiltrate and disperse along multiple axes, evade enemy attacks, deceive the enemy, and reduce vulnerability to massed fires and attacks by superior forces through advanced deception, protection, mobility, and shared situational understanding.

(b) Seeking to avoid U.S. strengths, such as long-range surveillance and precision strike, adversaries attempt traditional countermeasures, such as dispersion and intermingling with civilian populations, that stretch their own support structure and isolate or expose key nodes or pathways of critical systems. Disaggregated friendly forces—down to the entity level—converge physical and virtual effects from multiple points of presence against vulnerabilities through ground, aerial, and space reconnaissance and surveillance capabilities, managed and disseminated through the use of AI, and distributed by secure, jam-resistant, burst and directional communications systems that provide only the essential targeting information from sensor to shooter. AI-enabled information systems permit the rapid and autonomous deconfliction of air and ground maneuver and of friendly lethal and nonlethal fires operating and firing from anywhere on the battlefield. Swift air-ground deconfliction facilitates EAB formations' ability to strike, reposition, and restrike decisive points continuously, from multiple locations simultaneously, and at increased tempo.

e. *Converge multi-domain effects in depth to create windows of superiority and gain the initiative.* Convergence is the act of applying a combination of fully integrated capabilities in time and space for a single purpose. Army forces employ a *systems warfare methodology* to reveal opportunities where effects within multiple domains converge to dis-integrate threat systems at multiple break points, while creating or exposing additional vulnerabilities.

A *systems warfare methodology* exploits the interconnectedness and expansiveness of a system-of-systems. It identifies critical nodes and pathways of subordinate systems that, when targeted, substantially weaken the larger system. Simultaneous attacks on multiple dependent subsystem nodes can create a cascading effect that leads to the collapse of the larger system as a whole. EAB commanders and their staffs conduct threat analysis to determine key nodes to attack, as well as friendly analysis to identify critical nodes to protect.

As EAB formations conduct force-oriented reconnaissance through all domains, AI and machine learning aid in recognizing complex patterns buried within data collected from both military and civilian sensors within the battlespace. This formerly distributed data is then assimilated and analyzed to provide targetable information. To take advantage of this information at tempo, EAB formations must be ready to quickly converge disaggregated friendly capabilities against identified threat critical vulnerabilities before they can be protected. AI-enabled network systems and sensors enable this converge-strike-disperse cycle by providing automated targeting and clearance of fires, increasing decision speeds and improving the simultaneity of effects through convergence with—not just deconfliction from—maneuver.

(1) Challenge enemy systems to identify vulnerabilities. Presenting enemy systems with multiple dilemmas or defeat mechanisms physically, virtually, and cognitively seizes the initiative, places the enemy on the defensive, and allows the Joint Force and its partners to rapidly and continuously identify vulnerabilities and converge capabilities to create and exploit windows of superiority faster than the enemy can react.³⁷

(2) Assimilate distributed sensor data. EAB formations, enabled by AI and improved rapid decision-making processes and staff organizations, quickly analyze sensor data that is received through the vast array of multi-domain systems, and transmit only the critical information required by friendly forces to take decisive action. This allows commanders to make faster decisions than the adversary or enemy throughout the competition continuum. U.S. forces leverage persistent, redundant, and complementary multi-domain sensors—active, passive, manned, unmanned, remote, and tethered—to identify and analyze threats throughout the depth of the operational framework and use that information to engage critical vulnerabilities across all domains.

(3) Converge disaggregated capabilities against critical vulnerabilities. Converging multiple capabilities from different domains on critical vulnerabilities creates multiple dilemmas within enemy systems and formations throughout the competition continuum and in other domains, ultimately allowing U.S. forces to exploit these same vulnerabilities during armed conflict. For example, converging capabilities in the littoral areas opens physical, virtual, and cognitive windows of superiority for naval, air, and ground forces throughout the operational area to maneuver against enemy critical vulnerabilities.³⁸

f. Exploit the initiative at tempo against critical vulnerabilities to dis-integrate threat systems and enable maneuver forces to defeat the enemy in close combat. EAB formations reinforce their successful shaping activities and employ windows of superiority to relentlessly strike critical enemy vulnerabilities across multiple domains. EAB forces then exploit the initiative by conducting multi-echelon, cross-domain maneuver to rapidly close with and attack enemy forces and capabilities at tempo from distributed positions. In doing so, EAB formations converge physical, virtual, and cognitive capabilities at the decisive space and time to exploit momentum and enable follow-through.

(1) Conduct multi-echelon, cross-domain maneuver. Cross-domain maneuver is the employment of mutually supporting lethal and nonlethal capabilities in multiple domains to generate overmatch, present multiple dilemmas, and enable freedom of movement and action. Cross-domain maneuver leverages, integrates, and synchronizes multi-domain effects. EAB formations operate across multiple domains to provide freedom of maneuver for BCTs operating disaggregated across all aspects of the OE. This includes positioning key capabilities forward to create positions of advantage to defeat enemy capabilities. EAB formations' long-range capabilities, to include deep aerial maneuver and lethal and nonlethal fires or threats of fire, allow the Army to transition from shaping to decisive combat operations from a position of relative advantage and with increased shared understanding. In conjunction with lethal fires, EAB formations employ cyberspace attacks; electronic warfare; electronic and physical deception, physical feints, and ruses; and persistent information environment operations to cause enemy forces to miscalculate the strength and location of friendly forces, lose the will to fight, surrender in an engagement or battle, and, ultimately, capitulate the entire conflict.³⁹

(2) Close with and attack with tempo from protected positions of advantage. During the transitory period between competition below armed conflict and armed conflict, EAB formations, in concert with host nations, distribute friendly forces in areas of protected tactical advantage (outside the threat's divisional organic indirect fires) and protected operational advantage (outside

the IFC) to preclude engagement of high-payoff targets. Integrated air and missile defense limits the effectiveness of enemy theater tactical ballistic missiles and long-range interdiction aircraft, reinforcing and protecting areas of operational and tactical positions of advantage. EAB formations conduct continuous counter-reconnaissance activities across all domains to prevent the enemy from identifying weaknesses, targeting key friendly nodes, and fixing disaggregated friendly units. This allows BCT and below forces the ability to close with, aggregate, and attack with tempo from their protected positions of advantage at a pace the enemy cannot counter.

(3) Converged penetration through aggregation, mass, and exploitation. During LSGCO, EAB formations converge capabilities across all domains to create windows of superiority. During penetration, greater control of their BCTs—that previously may have been operating semi-independently—is required to facilitate the transition from disaggregated to aggregated operations, massing of effects, and exploitation of windows of superiority at the decisive space and time. To delay aggregation until the close fight is joined, EAB formations are able to execute multiple unmanned obstacle breaches and wet gap crossings in stride simultaneously (including breaches as part of deception operations). Similarly, autonomous resupply and the ability to infiltrate remote and autonomous sensors progressively deeper into the enemy zone enable EAB formations to maintain tempo and momentum. Deep and close aerial maneuver places key threat systems at risk, allowing ground forces the ability to exploit and penetrate defensive protective bands. EAB forces plan for success maintaining the momentum to attack and defeat enemy capabilities in depth.

g. Consolidate gains to develop and retain an enduring initiative. EAB forces consolidate gains in all domains by tracking and eliminating bypassed forces or capabilities, transitioning control to appropriate authorities, and reinforcing to retain positions of advantage. Ultimately, future EAB forces shape conditions to restore order, deter conflict, and create an enduring collective security environment through innovative multi-domain combined arms operations.

(1) Eliminate bypassed enemy forces or capabilities. EAB forces generally designate a maneuver force responsible for consolidation areas in the land domain. Forces assigned the mission of consolidating gains initially conduct offensive tasks to reduce bypassed enemy elements, then transition to area security and stability tasks. This enables freedom of action for units conducting the close fight and deep maneuver to maintain tempo and exploit success. Initially, the focus for consolidating gains is operations against bypassed forces, defeated remnants, and irregular forces that may threaten friendly forces in the support and consolidation areas, as well as areas short of the close area's rear boundary. While maneuver forces focus on the enemy's combined arms forces throughout the AO, EAB formations must continue to compete throughout multiple domains during the transition to return to competition. To accomplish this, EAB formations can designate a functional unit or organization to consolidate gains in other physical or constructed domains or environments. For example, cyber support teams take similar action in the cyberspace domain to defeat, destroy, or isolate threat influence and secure key cyberspace terrain for friendly advantage.

(2) Transition control to legitimate and appropriate authorities. In the event of local government collapse, EAB formations support the establishment of transitional public security and governance, and the restoration of essential services. EAB formations are essential to the orderly transition of authority to appropriate U.S., international, interagency, or host-nation forces or

agencies. EAB and subordinate commanders emphasize the establishment of transitional military authority that promotes or enhances post-conflict or post-crisis stabilization, resilience, civil security, and governance until the transfer of these activities to appropriate authority.

(3) Reinforce to retain positions of advantage. Positions of advantage are more than key terrain, as they include ideas relating to time, capability, and purpose. EAB formations must focus on transitioning rapidly to reinforce and retain positions of advantage gained during armed conflict. Positions of advantage also exist in the non-physical areas of cyberspace and the cognitive dimension of the information environment. During the consolidation of gains, friendly forces must retain these positions of advantage throughout all domains to deter the return to armed conflict.

3-5. Supporting ideas

a. *EAB formations as the orchestrators of multi-domain combined arms operations.* The challenges of the future OE and the factors affecting span of control continue to reinforce the need for at least three—and sometimes four—echelons above brigade to compete across the entire competition continuum at the theater strategic, operational, and senior tactical levels. Assuming a predominately CONUS-based force, the limited number of forward-postured formations must also include the essential capabilities to effectively compete below armed conflict, as well as the capabilities required to transition to and conduct armed conflict.

(1) Up to four different EAB formations may operate within these echelons to fulfill distinct and complementary roles for the Joint Force. To accomplish these roles, EAB formations must have the necessary capabilities to see and understand, decide, shape, strike (lethally and nonlethally), and endure across the depth of the battlespace at their respective echelon, across all domains, and in dense urban and other complex environments.⁴⁰ The historic titles of theater army, corps, and division succinctly describe these formations. Nevertheless, future roles, functions, responsibilities, and capabilities must be determined, validated, and distributed appropriately across echelons for best result.⁴¹ In the envisioned future, some theaters have sufficiently dangerous and capable adversaries presenting a realistic risk of LSGCO to require an additional in-theater command component. This formation focuses solely on that threat to successfully compete, deter, and, if necessary, prepare for and transition to combat operations as a land component command. This has historically been a field army commanding two or more corps.

(2) Future EAB formations must aid dynamic force posturing and facilitate competition with future adversaries through the creation of multiple dilemmas and the rapid exploitation of critical vulnerabilities. Future EAB formations are globally arrayed as prudent combinations of forward-presence and expeditionary forces carefully integrated with partner nations. The Army balances capabilities across the active and reserve components to create a sustainable force that is responsive to operational timelines and able to endure throughout a campaign. Crucially, all future EAB formations are tailored to conduct multi-echelon cross-domain actions to enable the Army's four strategic roles in support of the Joint Force.

(3) Future EAB formations and their enablers are specifically designed to create the agility and versatility necessary to form, dissolve, and reform teams rapidly to allow the Joint Force to succeed throughout the entire competition continuum. As victory favors an agile force able to quickly reinforce and task organize without loss of momentum, future EAB formations are

specifically designed to rapidly form, dissolve, and reform teams with multinational and joint partners. These combined arms formations balance assigned enablers to create cohesive and ready formations needed to succeed in LSGCO, while avoiding the rigidity of past formations. Overall, future EAB formations are designed to support—

- (a) Continuous competition.
- (b) Expeditionary, disaggregated, and decentralized operations.
- (c) Ease of force tailoring and rapid changes to task organization based on the mission.
- (d) Unity of command and unambiguous command and support relationships.
- (e) Multi-domain convergence.
- (f) Interoperability with joint, interorganizational, and multinational partners.
- (g) Training readiness.

(4) Future multi-domain combined arms operations include multiple partners, necessitating their methodical integration into Army-led formations. When integrating multinational forces, senior-leader rank and formation size frequently matter—many partners are reluctant to cross-attach and subordinate to formations perceived as merely a near-peer. ***In theaters with highly capable threats, EAB formations must be prepared to rapidly form larger multinational combined arms formations.*** To accommodate the socio-political caveats of partner nations, the Army must provide the appropriate command echelon, and the echelon selected must possess the required grade plate and commensurate experience that allow for seamless partner force integration when placed under the operational control of a U.S.-led formation.

b. *Mission command philosophy must become intrinsic to the Army Profession.* The extended distances across an AOR and prevalence of multiple U.S., coalition, and interorganizational partners magnify the already complex challenges of integration, communications, and collective cooperation. Additionally, formations will likely encounter varying degrees of degraded communications due to threat attacks against command and control (C2) infrastructure. Consequently, EAB commanders and their formations must be comfortable continuing to operate within the higher commander's intent to achieve objectives semi-independently even when virtually isolated. Under these conditions, employing the proper level of command and the appropriate amount of control, coupled with an intrinsic bias toward action, plays a pivotal role to the overall success of dispersed and disaggregated operations.

c. *Create the depth of capabilities across echelons and components.* Future Army EAB formations must be organized and primed for LSGCO. Optimization for LSGCO enables EAB formations to shape security environments to advantage, prevent conflict, or, if prevention fails, defeat near-peer threats while still providing the versatility to support more-likely and less-risky limited contingency operations. Posturing units and capabilities across the three components and distributing forces appropriately across the diverse AORs, including CONUS, achieves the necessary balance between readiness and responsiveness to oppose aggression and, if necessary, endure throughout a campaign. When adversaries know the Army can win in LSGCO, operations to shape and prevent are enhanced and enable the Joint Force to compete more favorably below armed conflict.

(1) Future EAB formations must be able to rapidly tailor and scale forces for specific missions and threats, and adapt to fluid environments anywhere along the competition continuum. Attached

forces must be able to immediately interoperate (technically and procedurally) with the unit to which it is task organized. To the greatest degree possible, they must also be adequately sustained during the entire time that they are task organized. Future EAB formations, with the appropriate mission command capacity and warfighting capabilities, must be able to see, understand, and shape across the breadth and depth of the multi-domain battlespace; conduct multi-domain combined arms operations to prevent conflict or prevail in LSGCO; consolidate gains to achieve strategic, operational, and tactical objectives with lasting and more-favorable outcomes; and endure throughout never-ending campaigns of competition.

(2) Possessing the appropriate authorities at the correct echelon is essential to the conduct of future multi-domain combined arms operations. Senior political and military leaders have repeatedly identified the lack of authorities at lower echelons to conduct space, cyberspace, information, and EW operations as a matter of critical concern.⁴² While the MDO Concept includes an assumption that these authorities exist in the future timeframe of this concept, the difficult work of making this happen must begin sooner rather than later.⁴³ More time is necessary to experiment and practice with these authorities to develop the doctrine, expertise, capacities, processes, procedures, and techniques to ensure that these capabilities can be rapidly brought to bear as an integral part of multi-domain combined arms operations conducted throughout the entire competition continuum.⁴⁴

d. *Partner interoperability, capabilities, and capacity.* Future EAB formations are designed to support the swift forming and reforming of networks and cohesive teams among joint, interorganizational, and multinational partners to achieve unified action. Interoperability must be a fundamental, measured component of EAB equipping, training, and readiness. Such interoperability, extended across our partners, gives EAB formations the ability to partner with friendly and neutral nations while maintaining and persistently competing below the threshold of armed conflict. These partnerships enable EAB formations to rapidly posture friendly forces with the ability to transition to armed conflict, effectively challenging an adversary's risk calculus in any given situation.

(1) Army forces must integrate with partners early in mission planning, training, and rehearsals; gain thorough understanding of joint (including SOF), interagency, and other partner capabilities; and encourage mission partners to advocate for their competencies and capabilities where they best serve the mission. Correspondingly, Army forces must be proactive in determining how to apply land combat capabilities to joint warfighting or adapt warfighting capabilities to any stability or civil support situation they face.⁴⁵ Partner command and support relationships, agreements, standards, and procedures must be cultivated and solidified well before the onset of operations as a persistent and enduring effort.⁴⁶

(2) The Army's future communications network and information systems must enable senior Army headquarters, in highly contested space, cyberspace, and electromagnetic environments, to work, operate, and plan within a joint and coalition environment and facilitate the rapid transition to a JTF or JFLCC.⁴⁷ The communications network and information systems must also allow Army forces to share information rapidly, liaise, collaborate, and establish a secure, releasable common operational picture with mission partners. Improving network interoperability and creating a true mission partner environment must have priority over improving individual system capabilities.

(3) Beyond the ability to technically and procedurally interoperate and integrate, EAB forces must build a cooperative security environment in which regional partners have both the capacity and willingness to participate with the U.S. and its allies to achieve mutually beneficial security objectives. Consequently, a significant corollary to partner interoperability is partner assurance—assurance that the U.S. will abide by commitments and obligations, and that regional partners can and will act and respond together in a coalition when needed. Therefore, while developing interoperable capabilities, EAB leadership and organizations seek to foster credibility, confidence, and trust through forward presence and persistent engagement.

e. Persistent information environment operations. Army EAB warfighting formations must be capable of expertly planning, integrating, synchronizing, and converging multi-domain capabilities throughout the entire competition continuum to influence foreign neutrals, counter propaganda, affect threat decision making, and shape the larger information environment. Aligning the information environment against enemies to counter their disinformation and gain operational advantage allows Army, joint, and coalition forces to gain or maintain the cognitive initiative. Future Army formations require the ability to conduct target audience analysis to identify relevant foreign audiences and their critical psychological vulnerabilities. Additionally, EAB formations require the ability to develop and staff the influence plan that provides EAB commanders with the appropriate authorities and senior-level guidance.

(1) Aggressive information environment operations are particularly important to each geographic combatant command's (GCC's) long-term theater security plans and, hence, imminently important to theater and field armies.⁴⁸ Information environment operations are a capability the theater army provides the Joint Force. Although there is often a strong influence to use any means available to accomplish a mission, EAB forces employ information environment operations lawfully to influence threat decision making and win the battle of the narrative. Future theater armies must seek to dominate the information environment within their AOR and lead assigned Army forces in the conduct of persistent, expert, and aggressive information environment operations against enemies and adversaries across the competition continuum—while also informing friendly and neutral audiences with the required mass and validity to defeat malign enemy narratives.⁴⁹ For the future, Army forces must increase their ability to monitor and participate in public media forums and accurately measure or gauge the impact of their information environment operations activities on the population's perception and behavior.

(2) The use of AI, better linkages to supporting national assets, organic information environment operations staff and units, as well as education, training, and experience, must enable leaders, Soldiers, and Army Civilians to apply an acute social and cultural understanding to determine key individuals and audiences and, as appropriate, the most effective ways and means of engaging, informing, persuading, or influencing them, both physically and virtually.⁵⁰ Aggressive information environment operations are an essential component to winning the contest of wills.

f. Agile, expeditionary, and survivable CPs. To meet the demands of future threats and the OE, EAB CPs must orchestrate operations and create synergy among disaggregated forces operating throughout the expanded multi-domain battlespace and across the entire competition continuum.

The Army maintains critical CP functions through redundancy and diversification among distributed command nodes that utilize dispersion, tactical positioning, and innovative employment techniques. CPs become survivable through the use of camouflage, concealment, integrated cross-domain deception, and physical and electronic hardening. These measures are enhanced by decreasing, masking, obscuring, or otherwise managing signatures (physical, virtual, electronic, or cognitive), as well as by decreasing their size through the use of AI and data management, remoting directionally controlled emitters, and increasing mobility. EAB CPs must survive while orchestrating warfighting across echelons and all domains.

(1) EAB CPs should be arrayed as interconnected command nodes extending from home station, enroute, and forward to deployed locations that operate in concert to maintain uninterrupted mission command during steady-state operations and throughout deployment, entry, and subsequent combined arms operations in all areas of the multi-domain battlespace. Home-station and forward-deployed garrison headquarters locations must be considered initial CP nodes. Home-station and forward-deployed garrison headquarters, as integral nodes of the mission command network, require additional protection and survivability.⁵¹ Smaller, highly mobile command nodes are easier to conceal (physically and electronically) and move and, therefore, more survivable. A command group node remains essential to command and control in future dispersed and decentralized operations. A mobile, protected command group node (ground and air) is required to enable future EAB commanders—at each echelon—the ability to command from any location and assess the situation firsthand, make decisions rapidly, and influence people and operations to maintain or regain the initiative.

(2) Connected by the Army's future communications network and supported by AI, machine learning, and effective information and data management, future EAB CPs must be able to ensure that the right information is available to the right person or organization at the right time, increasing the speed and quality of decision making and, consequently, the speed and relevance of action.⁵² Future EAB CPs must be agile, expeditionary, and survivable, and allow Army forces to seize, retain, and exploit the initiative; endure throughout the length of the campaign or operation; and win future multi-domain battles.

(3) Command nodes remain lucrative, high-payoff targets for threats, particularly those possessing advanced intelligence, surveillance, reconnaissance, long-range fires, special operations, and offensive space, cyberspace, and EW capabilities. The Army ensures the continuity and survivability of critical CP functions and capabilities by balancing multiple materiel and non-materiel considerations, to include simpler and leaner designs; hardening and protection from enemy, weather, and terrain effects (component information systems as well as CP infrastructure); and advanced space, cyberspace, and EW capabilities to sense indicators of an attack and enable the defense of the Army communications network and network- and spectrum-dependent weapons and equipment. The Army also achieves continuity and survivability of future command nodes through camouflage (physical and electronic), concealment, and integrated cross-domain deception; decreasing, masking, obscuring, or otherwise managing visual, cyberspace, electromagnetic, acoustic, and thermal signatures; remoting directionally controlled emitters; and increasing mobility. Finally, the Army realizes continuity and survivability of critical CP functions through appropriate redundancy and diversification of capabilities within and among nodes and

across echelons, and through dispersion, tactical node positioning, and other innovative employment tactics and techniques.⁵³

g. Establish maneuver corridors beneath enemy engagement threshold. EAB forces posture outside of, or concealed from, the full physical, virtual, or cognitive reach of an adversary. They operate beneath enemy engagement thresholds by physically or electronically masking locations and movements, and disaggregating key capabilities to the smallest possible elements. By careful positioning and disaggregating capabilities, friendly forces create temporary protected corridors and positions of advantage that allow freedom of maneuver and protect friendly capabilities while simultaneously restricting an adversary's freedom of action.

(1) During LSGCO, future EAB formations use both active and passive measures to protect key elements of combat power, particularly from air and missile capabilities. From distributed positions and along temporary protected corridors or distributed areas of operations, EAB forces strike critical enemy nodes that reduce their ability to respond and expand friendly maneuver options. To create temporarily protected positions of advantage, both physical and non-physical means can be used in combination to shield key interests, including camouflage, concealment, and decoys and other deceptive measures; EW jamming; information environment operations; long-range fires; hardened facilities and fortifications; and dispersion.

(2) In general, formations seek to establish protected tactical positions of advantage beyond the reach of the threat's divisional organic indirect fires, and establish protected operational positions of advantage beyond the reach of the enemy's IFC. Friendly air defense and long-range precision fires reinforce protected tactical and operational positions of advantage by limiting the effectiveness of enemy missiles and placing enemy aircraft and surface-to-surface systems at risk.

h. See, seize, and exploit positions of advantage across all domains. EAB headquarters and enabling formation units must be organized, manned, trained, and equipped to skillfully converge capabilities across all domains and warfighting functions and other elements of national power so as to rapidly see, seize, create, maintain, and exploit positions of advantage.

(1) Future EAB headquarters must assist the joint force in identifying, innovatively converging political and military capabilities to create, and maneuvering to exploit, temporary windows of superiority across multiple domains and the information environment. To accomplish this, all EAB commanders and staffs must be progressively trained, educated, and developed to think, plan, and act simultaneously across all physical and virtual domains and the cognitive dimension of the information environment, understand the conditions required to create domain windows of superiority, and see (or sense) and recognize those conditions as they occur.⁵⁴ As a fundamental component of future EAB headquarters, the Army must resource key theater army, field army, and corps command and staff positions with the right security clearance and appropriate grade plate of joint professional military educated and trained personnel.⁵⁵

(2) In the future, all Army echelons face increased levels of complexity. Future EAB headquarters must assume as much of the cognitive and logistics burden—planning and coordination—to allow lower tactical echelons to focus their available combat power on outmaneuvering and destroying highly capable enemy forces, and seizing and exploiting the

initiative to accomplish the mission. Future EAB headquarters must project future operations over longer time periods and make decisions earlier at each higher level of command. Commanders must empower subordinates by focusing on larger, longer-term goals instead of subordinates' tactical decision space.⁵⁶

i. *Employ systems warfare.* In the future, wars are not just a contest of attrition between opposing military forces, but also a battle among increasingly complicated and complex operational systems. This requires EAB formations to place greater emphasis on the employment of systems warfare analysis and methods to isolate, dislocate, dis-integrate, or destroy enemy systems—physical, virtual, social, and cognitive—throughout the continuum of competition. EAB formations identify vulnerable friendly systems that are critical to enable positions of advantage, and allocate protection and survivability assets. Systems warfare analysis allows EAB formations to determine the best means and methods for creating the effects necessary to open domain windows of superiority in which subordinate units can conduct cross-domain maneuver to accomplish their objectives. Systems warfare analysis allows EAB units to identify specific critical capabilities that, when isolated, dis-integrated, dislocated, or destroyed, cause failure of the larger adversary system.

Chapter 4

Operationalizing the Concept

4-1. Posturing EAB formations

Properly postured EAB formations are the principal orchestrators that bring multi-domain capabilities to bear against adversaries and enemies within an AOR. They are the Army's linkage to joint, national, and coalition capabilities and the catalysts for partner cooperation and interoperability within and across theaters to accomplish strategic, operational, and tactical objectives. This chapter defines a systems warfare approach for contesting adversaries' systems to create windows of superiority, describes how EAB formations are enabled to achieve the six overarching warfighting capabilities outlined in the previous chapter, discusses how those formations might be employed to address the six challenges confronting EAB formations across the competition continuum and, as a result, supports the development of solutions to the MDO problem set. It provides essential information for combat developers to determine the required DOTMLPF-P requirements for each of the formations to win in multi-domain operations. While this section is limited to the essential, [appendix E](#) provides more detail to support the assertions in this chapter and facilitate follow-on capability development analyses and assessments.

4-2. Systems warfare approach

a. A systems warfare approach enables friendly forces to exploit the interconnectedness and expansiveness of future threat systems. By this approach, friendly forces develop a thorough understanding of threat systems and how they are employed in order to determine the friendly actions necessary to reduce or collapse key threat systems or align friendly systems in a manner that reduces vulnerability and renders the threat system less effective. Underpinned by extensive intelligence collection and analysis, this system-of-systems examination identifies critical nodes or pathways within combined systems that may be individually exploited to reduce overall system functioning, or detects the multiple interdependent pathways and nodes of composite systems that may be engaged simultaneously, thereby creating multiple dilemmas and a cascading effect that degrades or collapses the larger system as a whole (see figure 4-1).

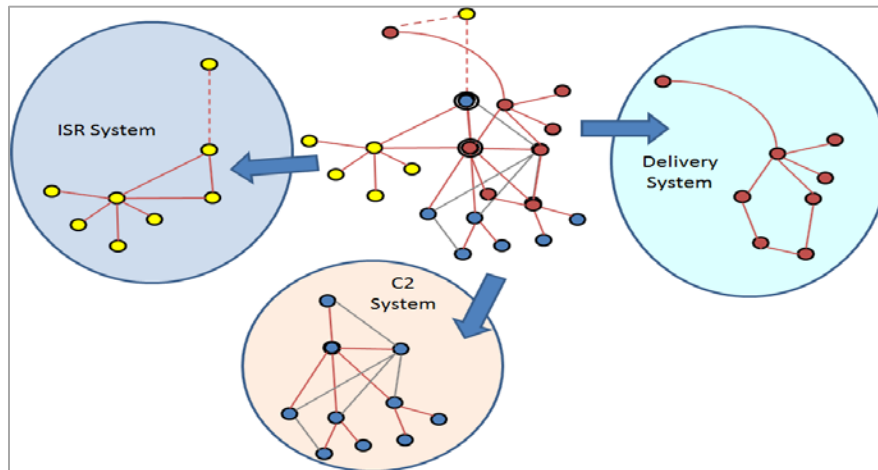

Figure 4-1. Composite system of systems

b. An important aspect of system warfare analysis is the determination of decisive points or spaces and then, with further refined analysis, those points or spaces that are most closely linked to the key systems or subsystems supporting the threat's center of gravity. Through targeting, EAB formations develop, locate, and engage targets of key nodes (decisive points or spaces), and through cross-domain operations (maneuver and fires), they create windows of superiority. Through these windows of superiority, EAB formations then work together to converge increasingly greater combat power from across all the domains, ultimately leading to the defeat (isolation, dislocation, dis-integration, or destruction) of the larger system.

decisive point – a geographic place, specific key event, critical factor, or function that, when acted upon, allows commanders to gain a marked advantage over an adversary or contributes materially to achieving the operation's purpose.

center of gravity – the source of power that provides moral or physical strength, freedom of action, or the will to act. Within an adversary's or enemy's center of gravity are systems—groupings of interacting, interrelated, and interdependent components or subsystems that form a complex and unified whole.

c. Because the proliferation of technology is an integral part of future operational environments, system warfare analysis is important to developing understanding, defining problems sets, and formulating the operational art bringing about the defeat of the enemy. However, system warfare is just one method—albeit of greater importance in the future—to developing strategic, operational, and tactical approaches that reduce an enemy's will to resist and cause the enemy to abandon or modify aims or objectives. Many future technological systems are complicated systems that behave in a linear, predictable fashion. For these, EAB headquarters staffs can apply deductive methods to determine critical vulnerabilities causing the system (or key portions of the system) to

collapse or fail, which in turn creates windows of superiority to maneuver (physically, cognitively, and virtually) against, close with, and defeat enemy forces.

d. As an example, the complicated composite system depicted earlier in figure 4-1 may be further deconstructed and analyzed by isolating the critical pathways for a single notional weapon system dependent upon the larger system (see figure 4-2). As in this example, friendly forces can then allocate specific capabilities (cross-domain maneuver, cross-domain fires, cyberspace, information environment operations, etc.) to isolate, degrade, dis-integrate, or destroy the specific combination of nodes and pathways to defeat the system as a whole. Allocation of capabilities through multiple domains and echelons reduces the adversary's ability to effectively counter

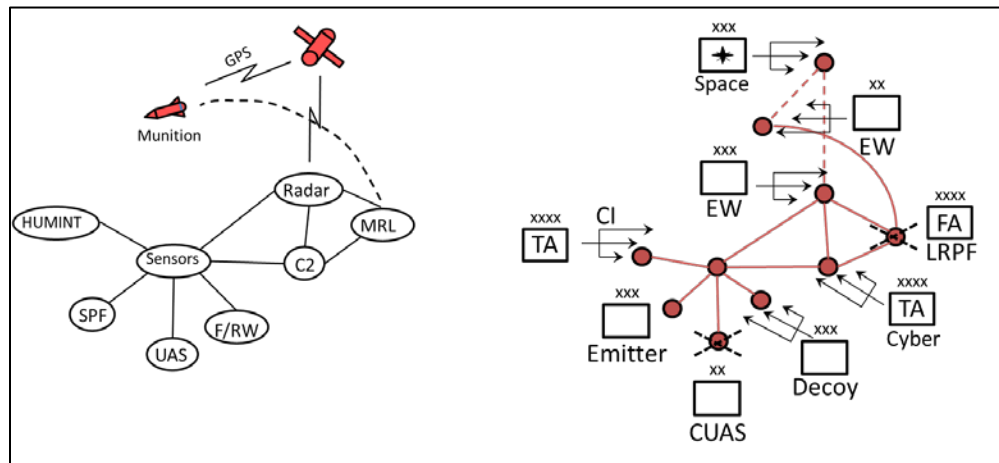

friendly actions.

Figure 4-2. Attacking multiple system components

e. Interconnected threat systems of systems in support of area defense and denial.

(1) The combination of an integrated air defense system (IADS) and an integrated fires complex (IFC) creates a mutually supporting network protecting threat air and ground maneuver forces while denying friendly freedom of action. This network is multi-layered across echelons to protect and support the next higher and lower echelon. Tactical air defense subsystems provide protection of point defense and ground forces, while operational air defense subsystems utilize extended ranges to complement and overlap the maneuver tactical air defense zones. Strategic air defense protects fixed airspace and high-value political, military, and economic targets, including military bases or other critical infrastructure, utilizing fixed or mobile air defense platforms operating out of peacetime garrisons. A significant feature of an adversary's strategic air defense is centralized control. Each echelon of air defense expands a "stand-off circle" that enlarges as each echelon aligns in the battlespace. In addition to reinforcing stand-off, these systems are dispersed across the battlespace with subsystems placed in protected areas and interspersed with decoys, creating a cluttered engagement area requiring increased time to analyze data and determine which pieces are real for targeting purposes—in other words, targetable data.

(2) By adopting a multi-layered defensive approach, the adversary creates challenges that forces must overcome in order to successfully compete with adversary IADS and IFC. Adversary long-range capabilities include short-range ballistic missiles supported by surface-to-air missiles and long-range multiple rocket launchers. Mid-range capabilities include massed cannon artillery and multiple rocket launchers supported by an extensive counter-battery network of sensors. The adversary also relies heavily on mid-range air surveillance and acquisition radars, and surface-to-air missiles integrated within strategic systems. As part of an overall joint effort, EAB echelons must identify high-priority targets on a “cluttered battlefield” filled with hundreds, if not thousands, of signatures. The ensuing battlefield, with the dense distribution of denial capabilities, results in a complicated system (as portrayed in figure 4-3) that requires increased capability at echelon for U.S. forces to see and understand, defend against, penetrate, and destroy.

Dismantling Enemy Systems: from the Complicated to the Complex

Many future technological systems are complicated systems that behave in a linear, predictable fashion. For these, EAB headquarters staffs can apply deductive methods to determine critical vulnerabilities causing the system (or key portions of the system) to collapse or fail which in turn creates windows of superiority to maneuver (physically, cognitively, and virtually) against, close with, and defeat enemy forces.

Other systems are complex (versus complicated). The most significant element to this complexity are people and their beliefs, interactions, and relationships. Complex systems are not mechanistically predictable and, therefore, do not lend themselves solely to a system-of-systems approach—these frequently present ill-defined problems that require multiple and redundant approaches. Complex systems and ambiguous problem sets often require alternative methods to develop provisional theories necessary to form approaches to guide action. As EAB formations take action, they learn more about the environment, gain understanding, and adapt in order to achieve their objectives. Complex systems require EAB commanders to remain skeptical of their own understanding throughout the campaign or operation.

(3) Figure 4-3 illustrates only a portion of the intricate, redundant, and overlapping nature of this system where each icon still represents multiple weapon systems. No figure can simply and accurately demonstrate the full depth and breadth of this system of systems. The labyrinthine appearance of what is actually a well-thought-out organization and structure requires a multi-echelon, multi-domain combined arms approach to penetrate, dis-integrate, and destroy key system nodes and pathways to open temporary domain windows of superiority. These windows of superiority must support ground and air maneuver.

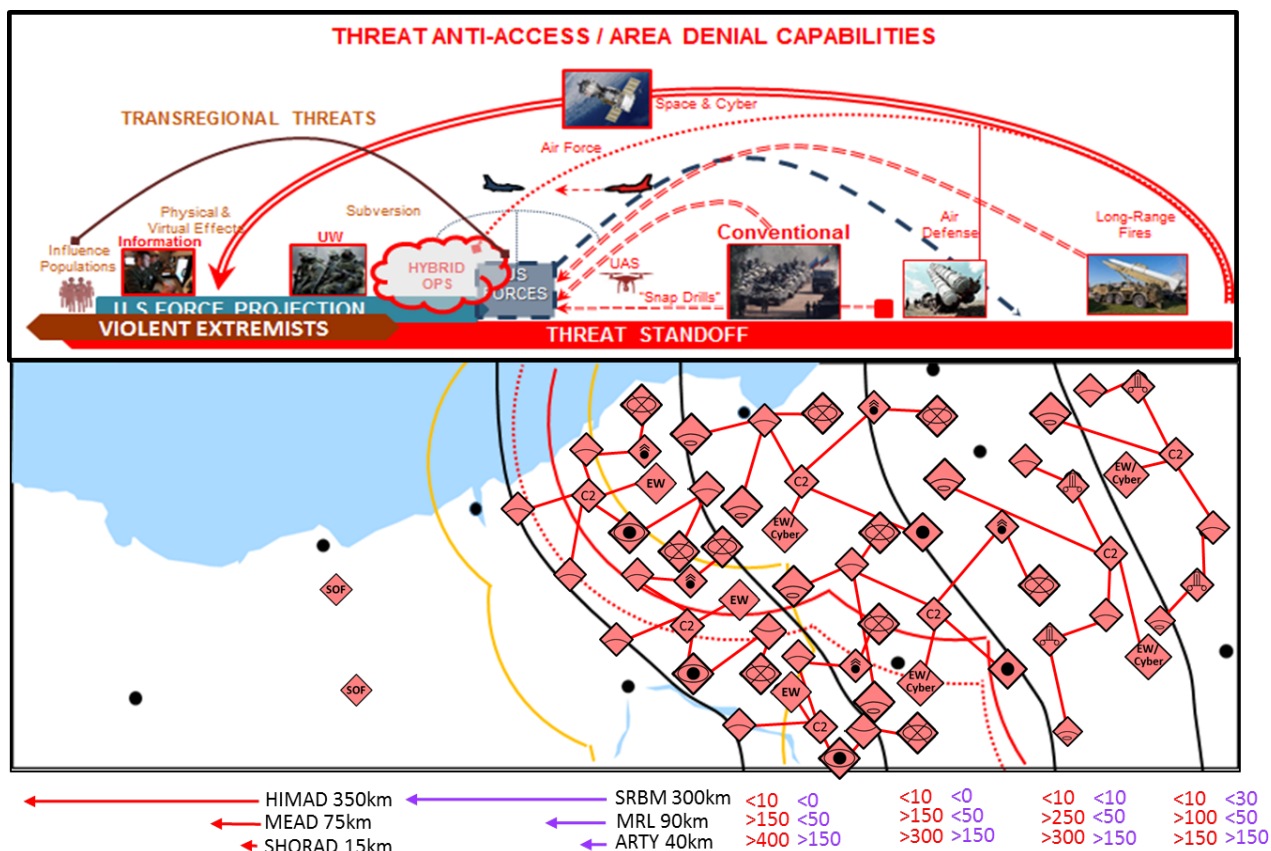

Figure 4-3. IADS and IFC complexity and density

f. System warfare analysis to defeat threat technological systems is not the “silver bullet” to winning across the future competition continuum. However, without a systems approach as one of the primary methods focused on achieving one of the four defeat mechanisms (isolation, dislocation, disintegration, or destruction), the probability of achieving the intended purpose of the operation is unlikely. Systems analysis and warfare are essential to the establishment of the conditions that will enable operational EAB formations to compete below the threshold of armed conflict effectively and, if necessary, shape the area of operations lethally and nonlethally to facilitate tactical EAB formations’ and their subordinate BCTs’ ability to maneuver and defeat enemy forces in close combat. While theater (and field) armies seek to win during competition and avoid escalation to armed conflict, deterrence of armed conflict with near-peer threats can only be realized if backed by highly lethal tactical formations (corps, divisions, and brigades) that can apply lethal and nonlethal systems warfare in the tactical environment to set the conditions necessary to enable the defeat of enemy maneuver forces in close combat.

4-3. EAB operations against a near-peer threat: Rising to the challenges

a. As EAB formations reshape to face a new threat paradigm, they must be organized, trained, and equipped to address the six primary challenges introduced in [chapter 2](#) to ensure that the U.S., allies, and other partners maintain an enduring initiative and a real competitive advantage. Adversaries craft specific strategies and use different systems to gain advantage based on where

the challenge falls within the intensity of competition—that is, whether competition is taking place before, during, or after overt conflict.

(1) In competition, adversaries carefully operate beneath a level that would provoke an open military response, seeking to separate or isolate friendly forces politically and achieve objectives before the U.S. can facilitate a coordinated response. Adversaries integrate the interrelated systems of intelligence, reconnaissance, unconventional warfare, information warfare, and conventional forces in innovative combinations to fracture alliances, isolate targets, and achieve political objectives without crossing the threshold that would lead to armed conflict.

(2) During conflict, enemies rely more on their conventional systems, IADS, IFC, ground maneuver formations, and complementary air and maritime forces to achieve military objectives that support their diplomatic objectives. Adversaries attempt to overwhelm friendly headquarters, ground maneuver formations, naval concentrations, embarkation and debarkation airports and seaports, and other critical sustainment facilities in the strategic and operational support areas.

b. Each EAB formation plays an integral, overlapping, and complementary role to countering adversary systems and maintaining the initiative across the competition continuum. While the operational emphasis may shift, each echelon—and its respective formation—tackles each challenge by converging capabilities to create and exploit windows of superiority against the threat. Each of these challenges is examined in greater detail below. This concept has identified four EAB echelons that are fundamental to overcoming these challenges throughout the entire competition continuum. These four echelons are the theater army, field army (only in near-peer “fight tonight” theaters), corps, and division.

(1) The theater army is the only persistent Army echelon within a geographic AOR. Each, therefore, is tailored to account for the peculiarities of the specific theater and provide the requisite amount of Army support to the geographic combatant command (GCC). The theater army is composed of a main command component, which manages Army forces to create and maintain enduring initiative, and a contingency command component that can respond immediately to regional emergencies.

(2) The field army is an echelon that provides additional operational capacity to a GCC that has a near-peer adversary within its AOR. The field army can conduct a land-based campaign of competition against that adversary on behalf of the GCC and, due to its presence, is postured to transition to a warfighting headquarters should conflict arise. The field army is also tailored in its capability and capacity as determined by the nature and capabilities of the near-peer adversary. As the near-peer adversary’s capabilities change, so do those of the field army.

(3) The corps is the linchpin of EAB versatility and agility. It consists of a main command component that is optimized to be a senior tactical headquarters during LSGCO, and an expeditionary command component that can act in an operational role during limited contingency operations that exceed the theater army’s capacity in duration or scale. Additionally, the corps retains and improves its capability to perform the role of JTF in limited contingencies.

(4) The division is a tactical headquarters that commands multiple BCTs and enablers. It dominates the close fight by converging internal and external multi-domain capabilities.

c. *Competition below armed conflict.* During competition, EAB formations shape the environment and defeat adversary aggression below armed conflict by:

- conducting continuous multi-domain operational preparation of the environment;
- countering destabilizing information warfare campaigns;
- deterring escalation through deployment and training exercises;
- maintaining resilient allies and building strong partners through security cooperation and security force assistance; and
- setting the conditions for rapid transition to armed conflict should deterrence fail.

(1) If shaping activities do not change an adversary's behavior back to favorable modes of competition, EAB formations enhance deterrence through overt demonstrations and further posturing of forces to create positions of strategic advantage while denying near-peer adversaries the ability to achieve political objectives short of a war they cannot win. To enable continuous shaping and the ability to transition quickly to prevention or conflict, theaters with near-peer threats require an operationally and threat-focused subordinate field army to enable the theater army to focus on its broad Title 10, ASOS, and DOD EA responsibilities across the entire theater. Theater and field armies, in conjunction with partners, prepare for potential armed conflict by conducting detailed analysis of critical adversary systems in order to identify vulnerabilities and posture capabilities to hold those systems at risk—overtly, covertly, or both.

(2) Theater army. As the foundation for Army presence in a theater, the theater army is configured with persistent capabilities tailored to the respective AOR to maximize responsiveness to the GCC. The theater army is the principal Army formation responsible for deterring or defeating an adversary's malign influences and overt aggression below armed conflict within the theater. Among its many tasks, the theater army manages security cooperation activities in coordination with the Department of State (DOS); conducts operational preparation of the environment (physical, virtual, and cognitive) and multi-domain reconnaissance and surveillance across the theater to build threat patterns of life and order of battle; serves as the primary conduit for strategic reachback to national assets and resources, non-geographically aligned ASCCs (ARCYBER, SDDC, and SMDC), AMC, and the Theater Special Operations Command; manages the theater; and establishes and maintains agreements for rapid information sharing and coalition response to contingencies and emergency situations.

(a) The theater army counters threat reconnaissance and information warfare systems through continuous multi-source and multi-domain intelligence, reconnaissance, counter-reconnaissance, counterintelligence, surveillance, and security operations as part of a comprehensive operational preparation of the environment to gain and maintain contact with enemy forces, thwart enemy information collection activities, strengthen friendly understanding, and avoid strategic surprise. Coordinating across the AOR, the theater army monitors threat efforts to influence the information environment and synchronizes an information environment operations campaign that weakens threat efforts while strengthening friendly partnerships. Integrated operations in the information environment, through the careful synchronization of themes and messages as part of

comprehensive public affairs and information environment operations campaign, counters threat-focused information warfare and inoculates local populations against enemy influence.

(b) To support regional training programs and operational force posturing, the theater army maintains theater pre-positioned stocks of equipment and supplies. In theaters with near-peer threats, war stocks and prepositioned equipment must be of adequate scale and in protected facilities with associated dispersal sites to ensure credible and rapid transition to armed conflict. This serves to assure allies by showing long-term commitment to agreements; deter threats by demonstrating a forward warfighting stance and readiness to rapidly transition to armed conflict at the required tempo to deter an adversary's actions and achieve positions of advantage below threshold; and set the conditions necessary to prevail at the least cost, if required, in large-scale combat.

(c) As part of setting the theater, the theater army establishes and maintains critical lines of communication in consort with partner nation security forces. Partnering and the establishment of key habitual relationships and agreements impedes threat unconventional warfare efforts, ensures friendly access and freedom of movement, and maintains freedom of action in response to unexpected crises. Immersive relationships within the theater strengthen U.S. ties to partner nations and opens the pathways for collaborative security strategies providing access to the timely indications and warnings necessary for rapid coalition decision making. These habitual relationships with partners also strengthen confidence, increase interoperability, and create a willingness to commit when an adversary begins to transition to armed conflict.

(d) The theater army sets the theater using many capabilities outside the AOR and not under its immediate operational control. To gain the support of these critical capabilities, the theater army must coordinate with other joint and partner forces, homeland-based interorganizational agencies in the strategic support area for their supporting capabilities, as well as those forces, organizations, and agencies located within adjacent geographic regions. The theater army establishes the baseline linkage to these capabilities, such as cyberspace, space, and psychological operations, to meet the necessary requirements during competition and ensure that the theater can rapidly accept and integrate functional units that expand capabilities when and where needed.

(3) Field army. In theaters in which a near-peer threat exists, a subordinate field army is necessary to relieve the operational burden on the theater army and facilitate focused opposition toward that specific threat within a distinct AO. Similar to the theater army's campaign across the AOR, the field army conducts an aggressive campaign of competition to counter and contain the near-peer threat as an integral part of the theater campaign. This unencumbers the theater army and enables the integrated theater plan. While the theater army continues to shape the entire theater and address aggression outside this designated AO, the field army maintains the necessary formations and other capabilities to provide credible deterrence and ensure the ability to quickly respond to escalation within the AO. The field army and other forward-postured Army forces utilize dispersion, hardened facilities, deception, and multi-domain obscuration to create protected positions of advantage in time and space in which enemy forces are unwilling to engage due to the threat—real or perceived—to their own forces.

U.S. Army Concept for Multi-Domain Combined Arms Operations at Echelons Above Brigade

(a) The field army wages the multi-domain campaign of competition, manages the AO focused on the near-peer threat, provides mission command for any forces (whether forward deployed or rotational units), and conducts contingency planning and the intelligence preparation of the battlefield (IPB) against the near-peer threat during competition below armed conflict. The field army integrates with joint, interagency, and other partners to help synchronize and deconflict operations, actions, and influencing activities within the AO. As the field army assumes these near-peer, threat-focused tasks, the theater army becomes unburdened and better able to concentrate on the rest of the AOR and its broader responsibilities as an ASCC.

(b) The field army strengthens security cooperation while physically, virtually, and cognitively preparing to rapidly transition to armed conflict should the adversary attack or the decision is made for the coalition to initiate armed conflict. The field army engages forward to preserve and improve partners' abilities for self-defense, sets conditions for greater access, increases partner interoperability, and develops specific operational approaches to identified changes in their subordinate AO.

(c) Utilizing a systems warfare approach, the field army maintains focused attention on the capable near-peer threat and develops detailed understanding necessary to determine options to extend competition, disrupt the threat risk calculus, and slow or prevent escalation. The field army's fires, intelligence, reconnaissance, and surveillance capabilities provide options to persistently threaten adversary targets and reduce confidence in its supposed sanctuary positions. Due to the nature of near-peer threat theaters and the presence of large numbers of coalition forces, the field army provides the GCC the ability to rapidly provide mission command for multiple U.S. and coalition corps formations in large-scale combat. This, in turn, disrupts threat calculus and allows the U.S., its allies, and other partners the time necessary to bring additional capabilities to bear should escalation continue, and sets the stage for the field army to assume responsibility as a land component command (LCC) for a multi-corps land force under the GCC.

(4) Corps. If forward deployed or strategically postured within the theater, the corps supports security cooperation and conducts military-to-military training exercises and other engagement activities to build partnerships. The agility of the corps allows it to serve as the focal point for integrating and testing new concepts and technological prototypes to determine their potential to create overmatch against adversaries. As tensions rise, forward-presence corps and divisions reposition to dispersal locations and establish multi-domain deception operations.

(5) Division. During competition, divisions ensure subordinate units are conducting security force assistance in consonance with the field army's campaign plan and conduct military-to-military training with partners to improve interoperability and coordination. They are focused on understanding the adversary's short- and medium-range weapon systems and their tactical maneuver and employment capabilities. Should escalation occur, divisions relocate to their initial dispersal positions and prepare for multi-domain operations.

d. ***Rapidly transition from competition to conflict.*** During the transition to conflict, EAB forces continue to aggressively oppose enemy efforts in all domains to extend escalation timelines and allow the integration of additional forces into theater. They take action through hybrid forms of irregular warfare to deny *fait accompli* objectives, upset enemy risk calculus, and set conditions

for a negotiated solution on favorable U.S. terms. If escalatory events continue, the field army transitions to the role of LCC subordinate to the GCC. As the LCC, the field army initially deploys resident in-theater forces into a disaggregated defensive covering force to enable the arrival and tactical deployment of follow-on forces while simultaneously initiating operations to deny the enemy freedom of action. The theater army maintains its integrated air and missile defense capabilities to provide protection and freedom of maneuver while intensifying area security operations and information environment operations to increase the population's support and prevent or weaken enemy influence.

(1) Theater army. The theater army continues to monitor and conduct actions to maintain stability across the theater in all domains and opposes threat efforts to create multiple crisis elsewhere in the AOR. It maintains aerial and sea ports of debarkation, operational dispersal areas, and lines of communication to facilitate reception, staging, onward movement, and integration (RSOI) of forces. The theater army counters and weakens enemy information warfare with an integrated friendly information environment operations campaign. The role of the theater army's influence plan is to attack the adversary's will to resist, and establish and defend the coalition's legitimacy to operate and support maneuver warfare. The theater army can delegate the conduct of the information environment operations campaign against the specific threat to the field army.

(2) Field army. As the field army transitions to a LCC, it receives necessary joint and coalition headquarters augmentation, incorporates additional multinational units, and designates subordinate corps' areas of operation. The field army operates day-to-day from protected CPs based on its forward position within the geographic AOR and likelihood of operating within range of threat ground-based indirect fire and missile systems. CP protection and survivability is achieved through a combination of hardened and dispersed facilities, redundancy across command nodes and echelons, highly mobile command nodes (including the mobile command group), physical and electronic signature reduction or obscuration, and multi-domain deception. Similarly, critical communications nodes and other infrastructure and equipment must be hardened, hidden, redundant, and, where possible, highly mobile.

(3) Corps. The corps continues to shape the environment, while also conducting RSOI of its subordinate divisions as combat power continues to build. As the field army assumes the LCC role, its scope widens to facilitate multiple corps. The corps must plan and prepare to become the primary integrator and synchronizer of multi-domain capability to defeat enemy systems and enable tactical maneuver. The corps also establishes liaisons with adjacent, higher, and subordinate units to facilitate communication and convergence as operations are initiated. As units move to initial staging positions, the corps ensures subordinate units are dispersed and in the best positions of protected operational positions of advantage to support maneuver.

(4) Division. Divisions operate from positions of dispersed and protected operational positions of advantage and continue to build combat power. Divisions employ information protection, operations security, and military deception to dis-integrate adversary target acquisition and intelligence gathering while protecting their own intelligence and information systems.

e. Penetrate and defeat the enemy IADS and IFC systems. If de-escalation efforts fail, and when adequate expeditionary forces arrive in theater, EAB forces transition from a defensive to an

offensive covering force. They integrate with unified action partners to destroy key system nodes that lead to the defeat of the enemy's anti-access and long-range denial capabilities. This sets conditions for tactical maneuver forces (corps and below) to penetrate the close area on favorable terms. It is crucial that sufficient enemy air defense and fires components are defeated at the onset of hostilities to allow tactical maneuver forces the freedom of action and protection necessary to achieve their initial objectives. As EAB echelons engage with long-range and other joint fires to isolate or dis-integrate enemy IADS and IFC, divisions and BCTs are subsequently able to maneuver to close with and destroy enemy maneuver forces and subsystems. Together with other GCC resources (joint force air component command, cyberspace, etc.), the field army's long-range systems engage identified targets in the deep maneuver and operational deep fires areas. (See figures 4-4 and 4-5 for a depiction of IADS and IFC subsystems, respectively.)

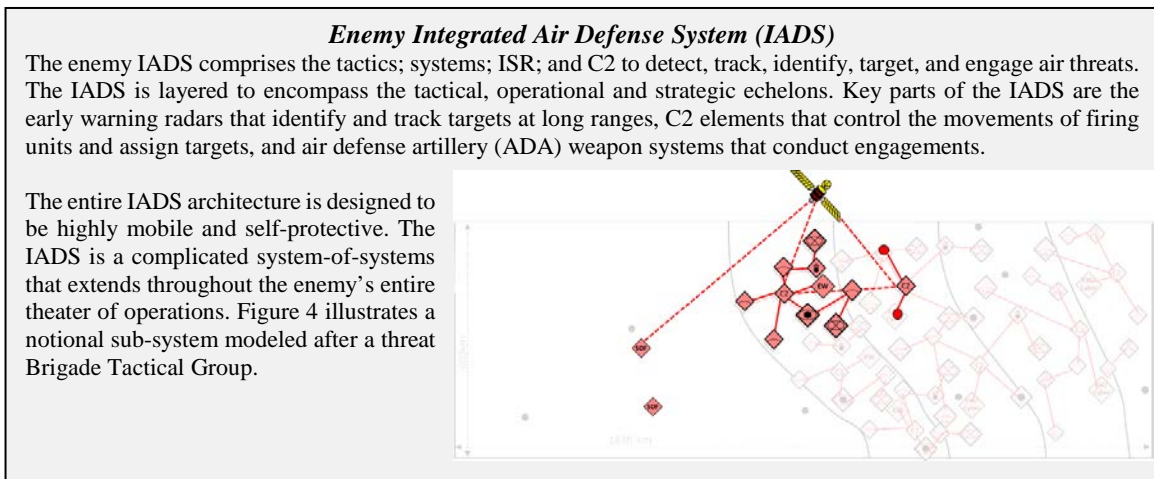

Figure 4-4. Subordinate IADS subsystem visualization

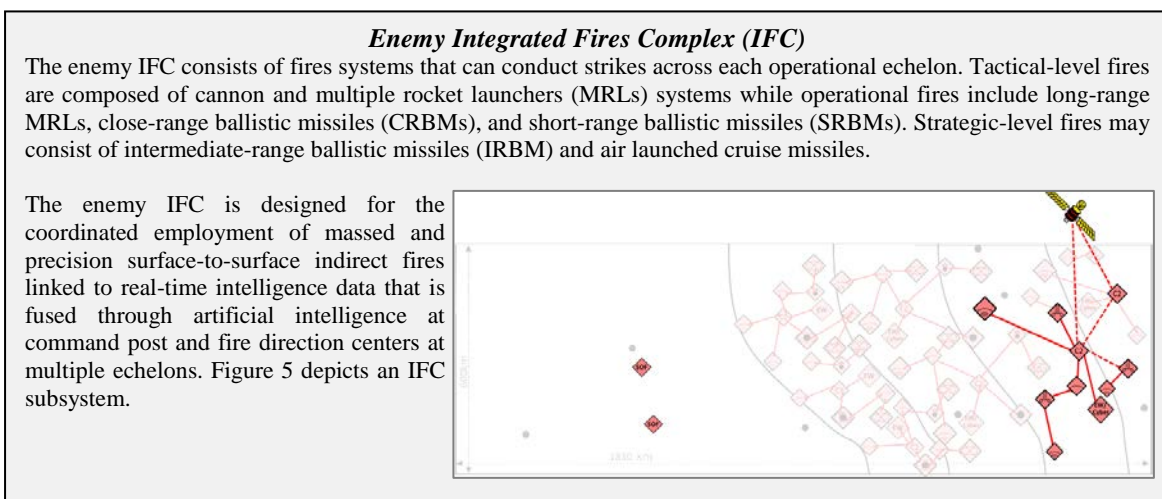

Figure 4-5. Subordinate IFC subsystem visualization

(1) *Penetrate*. The theater army operates as the ARFOR for Army forces in theater and serves as a force and capabilities provider to the LCC (field army). The field army, as the LCC, is the Army's principal echelon contributing to the joint fight against the expanded enemy IADS and IFC systems. It coordinates and synchronizes all ground-based attacks to subsystem key pathways

and nodes in order to bring about the defeat of the overall system. It maintains a common operational picture in order to assign targets and coordinate necessary resources for multiple U.S. and multinational corps. The corps utilizes a combination of lethal and nonlethal fires to create windows of superiority for division fires and maneuver. The corps uses its operational fires command to shape the operational deep fires and deep maneuver areas. Divisions engage in the deep maneuver and close areas to degrade and destroy tactical IADS and IFC to enable joint air and BCT maneuver.

(a) Theater army. The theater army coordinates space and cyberspace protection and counter-ISR support for ground forces not within the LCC's AO. Through continuous information environment operations activities, the theater army reinforces the GCC's information activities while denying the enemy cognitive positions of advantage. In the operational support area, the theater army protects key command and control nodes, joint RSOI locations, theater sustainment locations, and theater stocks through an integrated air and missile defense network, and local and area security operations to defeat enemy long-range missile defense network and fires, special forces, irregular threats, and air interdiction by enemy long-range attack aircraft. As the key link to strategic cyberspace support, the theater army protects operational level command and control nodes and networks within the theater to enable the effective connection of field army and below tactical networks to the DOD information network. Simultaneously, the theater army provides continuous support to other services in order to sustain joint tempo while protecting and repositioning key sustainment facilities and capabilities. Any fires forces retained at the theater army contribute to the destruction and suppression of enemy long-range systems.

(b) LCC (field army). The field army sets initial conditions for penetrating the threat air defense by prioritizing and sequencing key system elements based on detailed IPB conducted during competition and refined from intelligence obtained during transition. With this visualization, the field army is able to take advantage of the interconnectedness of the threat system and orchestrate compounding effects that may span corps boundaries. The field army coordinates an overall deception plan, including psychological operations, to support corps and division efforts to conceal friendly force posture and stimulate threat air defense systems. It employs cyberspace effects to specific C2 nodes that delay responses or force the enemy to utilize alternate C2 nodes that have already been infiltrated. As threat systems are revealed through ISR or overt action, the field army conducts long-range precision strikes to destroy delivery platforms and munitions. The field army coordinates converging long-range ground fires with joint multi-domain capabilities to destroy enemy long-range systems that prevent both air and ground freedom of maneuver.

(c) Corps. The corps coordinates for space effects to disrupt satellite communications to compound organic EW effects against key C2 nodes to degrade threat PNT. Corps employ and deploy multiple deception platforms, air and ground, and generate false indications and warnings in the non-physical domains and environments to stimulate threat air defense systems and generate plausible targetable indicators for threat detection. Corps utilize a vast array of interconnected sensors—artillery delivered, UAS, and infiltrated—that place close threat systems at risk. Through persistent active surveillance, threat systems are either actively exposed, forced to reposition, or stimulated to engage. The corps operational fires destroys targets revealed in the corps AO.

U.S. Army Concept for Multi-Domain Combined Arms Operations at Echelons Above Brigade

(d) Division. In conjunction with joint air, divisions deploy multiple deception platforms, air and ground, to stimulate threat air defense systems and generate plausible targetable indicators for threat detection. Simultaneously, forward division EW systems use targeting to shape the threat detection window to further enhance the believability of deception signals. Division fires assets are distributed in the forward covering force security zone and converge fires on threat tactical air defense locations that are revealed. Divisions employ counter UAS to degrade threat ISR.

(2) *Disintegrating the IADS and IFC.* To protect the land force from the IFC and enemy air and ballistic missile forces, the future theater army provides theater ballistic missile defense (missile, EW, and directed energy) protection in the operational support area. When coupled with tactical dispersion and protected by highly mobile directed-energy or EW-enabled short-range air defense, dispersed maneuver and strike forces can both survive and maintain freedom of action. Survivability can be enhanced by multi-domain reconnaissance and security formations, along with the deception, camouflage, and concealment capabilities resident in future corps and division formations. From distributed and protected locations, subsystems of the IADS are targeted and destroyed by the future corps' organic surface-to-surface lethal fires, nonlethal fires, and electronic attack and cyberspace capabilities, supported by the convergence of other joint systems. Initial strikes focus on forcing the dislocation of the IADS to enable fifth and sixth generation fighters and future advanced Army aviation manned and unmanned systems greater freedom of action. These attacks force other out-of-contact components of the IADS and IFC systems to reposition making them easier to strike. While these remaining enemy IADS and IFC forces reposition, reinforce, or echelon in response to friendly attacks, divisional maneuver elements rapidly move on multiple axes deeper into the friendly offensive security zone to posture for penetration of the enemy disruption zone.

(a) Theater army. Through reach back to national-level and non-geographically aligned Army capabilities, the theater army facilitates multi-domain shaping in the operational deep fires area. This shaping illuminates and uncovers elements of the fires complex for further disruption and degradation by the field army and joint forces.

(b) Field Army. As the LCC, the field army weights efforts between multiple U.S. and multinational corps to orchestrate fires, cyberspace, and EW capabilities across corps boundaries and engage components of the IFC as they become vulnerable. The field army continues to protect tactical command and control nodes and networks within the AO while resourcing subordinate corps. Similar to action taken against the IADS, the field army coordinates the deception and stimulation of enemy IFC to locate and engage key components while positioning its own long-range fires and intelligence, surveillance security, and reconnaissance forces to create windows of superiority that can be exploited by other joint and Army assets.

(c) Corps. As the strategic and operational air defense threat decreases, the corps converges fires and attack aviation against enemy tactical air defense and IFC components allowing joint fires and aviation to concentrate against operational-level targets in the deep maneuver and operational fires areas. The corps maintains a distributed posture and utilizes all domain resources available (air, missile, cyberspace, space, electronic warfare, UAS swarms, deception, etc.) to maintain continuous pressure on both the IADS and IDF networks so they are disrupted and collapse as forward enemy forces attempt to reposition rearward. The corps' operational fires,

distributed behind or forward positioned within a division's AO, engages known enemy positions in the deep area. Setting conditions for maneuver, the corps employs subordinate divisions to maneuver to gain positional advantage and seize or clear key terrain in a manner that accelerates the collapse of the enemy's IADS and IFC.

(d) Division. Divisions and their BCTs maintain a distributed posture to avoid presenting themselves as high-payoff targets. Though their organic fires systems (artillery, rocket, mortars) are dispersed, they are integrated through a protected, anti-jammed mesh network to converge fires from multiple locations against enemy tactical forces. As joint air begins to strike deep operational targets, divisions and BCTs simultaneously begin targeting known positions in the close area and utilize forward-looking radar to quickly identify points of origin and suppress systems revealed in response to corps fires. Divisions employ their aviation in conjunction with obscuration, false-signal generation, and physical decoys to deceive the enemy by, for example, making it appear that friendly forces are massing for a ground penetration. As enemy forces respond by fire or attempt to reposition, divisions and BCTs seize the initiative and converge fires against revealed enemy forces. As divisions gain greater freedom to maneuver, the corps may employ them to conduct ground maneuver to penetrate, envelop, or turn enemy maneuver forces to defeat key system nodes or disrupt critical pathways of the enemy's IADS and IFC.

(3) *Defeat*. Through systematic, iterative attacks against key components of the IADS, EAB forces are able to open windows of opportunity for the joint force to begin the reduction the IFC threat. This, in turn, enables maneuver forces to reposition critical assets and disrupt the threat calculus by placing enemy systems and forces at risk. As enemy forces reposition in an attempt to restore their defensive posture, friendly forces seize the initiative to further degrade the IADS and IFC systems and build momentum that ultimately leads to the failure of the overall system. Together, the field army and corps overcome long- and mid-range systems creating opportunity for joint air and maneuver forces. As the LCC, the field army coordinates the collapse of the IADS and IFC to maximize division and BCT momentum in order for them to rapidly and unexpectedly mass at decisive points or spaces against enemy ground forces.

(a) The future field army, as the LCC, commands and controls multiple corps to enable convergence of their maneuver and effects across the breadth and depth of the land area of operations. Given the interlocking complexity, layering, and span of the enemy IADS and IFC, the field army must have the capacity to ensure a unified, cumulative, and coordinated cross-domain effort among multiple corps and present multiple dilemmas to the enemy across the depth and breadth of the future battlespace.

(b) The future corps, within its area of operations, converges organic, joint, and multinational enablers to strike these two systems. This corps task requires the optimal organic capabilities to see and understand, decide, shape, and strike critical enemy nodes within both the IFC and IADS to ensure friendly forces achieve their desired objectives.

f. *Defeating enemy maneuver forces*. Once multiple corps, as subordinates to the field army, significantly dis-integrate the IADS and IFC at the decisive space, divisions and BCTs conduct a rapid campaign of cross-domain offensive maneuver across all areas of the expanded battlespace in multiple domains and locations simultaneously. The future Army division allocates resources

between subordinate BCTs and enablers to weight the effort and close with and defeat enemy ground forces. Division reconnaissance and security forces gain and maintain enemy contact to locate points of penetration while providing reaction time and maneuver space to the flanks of attacking BCTs. Subordinate BCTs maneuver in the close area to destroy enemy maneuver forces and seize objectives while division fires and aviation shape the deep maneuver area to enable further BCT exploitation or pursuit to complete the defeat of the enemy's maneuver forces and remnants of the IADS and IFC. In peripheral portions of the GCC's area of operation (outside the theater of armed conflict), the theater army continues to shape the security environment through information environment operations, ASOS, and resetting the theater activities to enable engaged forces to maintain tempo, while reassuring allies and populations on the periphery of the conflict zone.

(1) Theater army. During armed conflict, the theater army continues to plan, prepare, execute, and assess many of the missions, tasks, and activities conducted during competition below armed conflict. It remains focused on the entire AOR while continuing to sustain and support the focused efforts of the field army (if established) or corps, and its own contingency command component if employed for another contingency elsewhere in the AOR. The theater army continues to ensure that the field army and its corps and below forces have all the resources and warfighting capabilities that they need to rapidly win in armed conflict. However, the theater army continues to work with joint, interorganizational, and multinational partners to contain the conflict and not allow it to unnecessarily escalate.

(2) Field Army. Normally, the field army exercises operational or tactical control (OPCON or TACON) over multiple U.S. and multinational corps equivalent formations. It orchestrates the weighting of capabilities and the task organization of units within these subordinate corps, and maneuvers them to defeat enemy forces. It utilizes intelligence, fires, cyberspace, EW, and aviation assets to conduct deep maneuver to reinforce corps and division operations. The field army supports the division and brigades through the corps in the close area with long-range fires, and coordinates for reinforcing multi-domain joint capabilities. The field army maintains exquisite situational awareness through high-altitude and low-earth-orbit surveillance and an in-depth sensor network—enabled by AI and robotics and established during the competition period—to identify high payoff targets such as IADS, SRBMs, long-range MRLs, maneuver concentrations, sustainment, and C2.

(3) Corps. In armed conflict, the corps conducts combined arms operations employing cross-domain, conventional and unconventional capabilities to defeat enemy forces. Normally, the corps exercises OPCON over two or more Army divisions and a variety of supporting brigades, exercises TACON over various Marine Corps and multinational units, and is supported by various theater-enabling organizations. In major operations involving LSGCO, the corps conducts all four primary offensive tasks—movement to contact, attack, exploitation, and pursuit. The corps commander's primary means of attack are the corps-level fires and aviation brigades, the corps reconnaissance and security formation, and the divisions under corps command.

(4) Division. The division is optimized to defeat enemy maneuver forces in the close and deep maneuver areas. The future Army division allocates resources between subordinate BCTs and enablers to weight the main effort in order to rapidly close with and defeat enemy forces.

Subordinate BCTs maneuver in the close area while division fires and aviation shape the deep maneuver area.

(a) Division formations maneuver from their protected positions of advantage varying their tempo and dispersion. They concentrate fires from disaggregated locations to rapidly strike the enemy. When conditions are set, subordinate BCTs mass from dispersed locations on multiple axes to defeat opposing enemy forces in swift close maneuver and then quickly disperse and maneuver to subsequent objectives. They engage throughout all domains to gain overmatch and isolate, dislocate, dis-integrate, or destroy enemy maneuver forces. Divisions may at times be required to conduct defensive operations during LSGCO. Defensive tasks are conducted to defeat enemy attacks, gain time, economize forces, and develop conditions favorable to resume offensive operations. Defensive tasks are most likely executed during the transition periods—to and from armed conflict. Divisions also conduct limited stability tasks during armed conflict in accordance with the laws of land warfare. Stability tasks become more prevalent in consolidation areas and during consolidation of gains after bypassed enemy forces are defeated.

(b) Divisions employ multi-domain-capable BCTs simultaneously to overwhelm enemy maneuver forces continually gaining progressive positions of advantage. BCTs are configured to execute foundational multi-domain convergence of maneuver, fires, and aviation—even when temporarily isolated from higher headquarters. Despite degraded communications, brigades integrate EW, air operations, cyberspace, and offensive space control into their maneuver to gain and maintain domain windows of superiority.

g. Consolidating gains. EAB formations continuously consolidate gains to maintain tempo and enable the transition from armed conflict to renewed competition. Activities to consolidate gains are conducted to eliminate the enemy's capability and will to resist and are essential to exploiting tactical success and maintaining the initiative. Like shaping actions, consolidation of gains is a continuous activity with varying levels of intensity and a variety of tasks, including: stability, security, and offensive operations against bypassed enemy formations. EAB formations continuously plan for and conduct consolidation of gains to reset the conditions for long-term deterrence and as the prelude to creating a new and improved security environment. In theaters with a near-peer threat, the future field army typically transitions consolidation of gains activities to the corps when conflict intensity subsides and the number of committed forces reduces from multiple corps to a single corps. From the outset of a campaign, the field army plans, sets, and continually adjusts the conditions for a more favorable return to competition and a new normal.

(1) Theater army. The theater army anticipates and requests additional combat forces and functional capabilities and plans the mechanisms required to move those capabilities into and out of theater and regenerate forces. Critical to the consolidation of gains are consolidating activities which result in the establishment of transitional military authority and transitioning to civil authority. The theater army is the echelon responsible for establishing both. During the final phases of consolidating gains, the theater army retrogrades equipment, closes the joint area of operations, plans and coordinates the redeployment of Army forces, and revises its long-term security cooperation plan for the new post-conflict security environment.

(2) Field army. The field army is primarily responsible for orchestrating the consolidation of gains while there is still a significant threat of violence. From the outset of a campaign, the field army plans, coordinates, and continually adjusts the conditions for a return to competition below armed conflict on more favorable terms. The goal of the field army is to immediately reinforce and secure positions of advantage across all domains and quickly reorient to a competitive posture against any residual threat. A corps assumes responsibility for consolidation of gains across the battlespace as the level of violence subsides and the number of committed friendly forces in the battlespace lessens to a corps or less.

(a) The field army's role in consolidating gains lies mainly in planning, requesting, coordinating, and allocating the required resources, and prioritizing efforts across the entire AO. Consolidation activities require additional combat power and should not normally be drawn from forces in the close and deep fight. The field army is the link for obtaining the additional Army, joint, interorganizational, and multinational capabilities needed by multiple corps to accomplish the specific activities and conclude operations within their subordinate areas. As Army forces depart the theater, the field army continues longer-term activities to consolidate gains as an enduring part of subsequent activities in the return to competition below armed conflict.

(b) During consolidation of gains, properly vetted host-nation military and civilian security forces are reconstituted to provide for their own internal security. This transition is challenging, time consuming, and triggers changes to rules of engagement and other security policies, the development and execution of a comprehensive security force assistance plan, and potential task-specific changes in responsibility from the DOD to the DOS. With host-nation personnel assuming more responsibility for security, the field army may transition from a JFLCC to an Army-only unit and return to the control of theater army. As this occurs, U.S. and multinational forces are force tailored and task organized for the new operational environment, and the AO is adjusted and reorganized accordingly.

(3) Corps. The focus of operations shifts to the corps as violence subsides during the consolidation of gains. The corps initially conducts the deliberate planning and preparation to consolidate gains following the tactical success of its subordinate divisions. While eventually divisions and, at the completion of LSGCO, all Army units conduct activities to consolidate gains, the corps is responsible for overall planning, preparation, execution, and assessment to allow divisions and their BCTs to remain focused on retaining the initiative and maneuvering without loss of momentum. Consolidation of gains are those activities that, combined, make temporary tactical successes enduring; therefore, winning the close fight—tactical success—is of first importance. However, the tactical success will have been in vain without full and continuous consideration to the consolidation of operational and strategic gains. The corps continually reorganizes its AO as appropriate to best facilitate rapid consolidation of gains. Activities to consolidate gains require a balance between security and stability tasks as well as influencing key audiences to support coalition and host-nation political and security forces operating in the AO.

(a) Establish security. When consolidating gains, the corps prioritizes the establishment of security before stability tasks; stability tasks are difficult to accomplish without adequate security. Corps orchestrate combat operations against bypassed enemy or remnant conventional forces or irregular forces fighting among the local population and in dense urban and other complex terrain,

as well as against criminal elements taking advantage of the lack of civil control in a given area. Corps conduct other security tasks to protect friendly forces, civilians, routes, and critical infrastructure.

(b) Conduct stability tasks. The corps plans and conducts stability tasks to establish conditions that support the transition to legitimate authorities. It seeks to establish civil security, civil control, and the rule of law; restore essential services to create a sense of normalcy and prevent further destabilization; support governance and economic and infrastructure development; and conduct security force assistance to build capability and capacity of foreign security forces. The corps carefully integrates its stability operations with those of host-nation forces and intergovernmental agencies across multiple lines of effort. As U.S. and multinational forces deploy and redeploy, the corps may transition to a JTF and assume responsibility for stability operations. The various stability lines of effort require detailed plans and unique timelines based on threat reduction, force drawdown, host-nation capabilities and capacities, and the expertise required from other U.S. and multinational partners.

(c) Influence key audiences. The corps develops and communicates credible narratives in the corps area of operations to specific audiences to prevent interference and generate support for operations. Importantly, the corps establishes and maintains communications with the populations in their AO to assist them in understanding the overall goal of military actions and how those actions benefit them. The corps develops and implements more restrictive rules of engagement to avoid the perception that Army forces are doing more harm than good.

(4) Division. As part of its singular focus on winning the close fight, the division concentrates first on *consolidation* versus *consolidating gains* following tactical success. Consolidation is the tactical first step to consolidating gains which is the organizing and strengthening a newly captured position so that it can be used against the enemy. The division seeks to establish immediate security to eliminate pockets of resistance and protect lines of communications. It positions its subordinate BCTs in a hasty defense, blocking potential enemy counterattacks. It presses forward with reconnaissance and prepares to continue offensive operations or, if necessary transition to another mission. With more time, the division commits combat forces to defeat remnants of bypassed enemy forces before they can reorganize for a counterattack. During the conduct of close combat, divisions conduct the minimum-essential stability tasks of providing civil security, food, water, shelter, and medical treatment. When directed and provided more forces and other appropriate resources, the division can organize a consolidation area and plan and conduct longer-term stability tasks as a second priority. The corps may task a follow-and-support division to command and control the corps' consolidation area as it grows in size during the campaign.

h. ***Renewed competition below armed conflict.*** Under the new paradigm established at cessation of combat operations on U.S. and coalition terms, competition activities continue in a more favorable environment allowing for more enduring stability. During renewed competition, the future theater army and field army renew the theater campaign of competition to shape and prevent, while maintaining positions of strategic advantage that result in reduced overall competition intensity.

U.S. Army Concept for Multi-Domain Combined Arms Operations at Echelons Above Brigade

(1) Theater army. *The theater army is optimized for returning the theater to competition after armed conflict.* Already optimized for operations below armed conflict, the theater army resets the theater after cessation of hostilities and establishes the return to competition on enduringly favorable terms. The theater army manages security cooperation, simultaneously protecting the delicate security situation by deterring escalation. Throughout the return to renewed competition, the theater army seeks to transition control to appropriate host-nation civil or military authority.

(a) Security cooperation. Based on the new security environment, the theater army revises its security cooperation plans and conducts security cooperation activities to build or restore partner (old and new) warfighting capabilities able to counter the adversary's renewed subversion campaign (reconnaissance, unconventional warfare, and irregular warfare). These security cooperation activities influence the opinions and attitudes of the local population deterring a return to armed conflict.

(b) Deter escalation. The theater army manages the fragile security environment by ensuring combat power remains at appropriate levels within the theater to deter adversary aggression. The speed with which the theater army physically and virtually assists supported partner nations to restore stability and re-establish functioning security, safety, economic, and communications systems and infrastructure provides a cognitive window in which to conduct friendly information environment operations. Restoration of critical infrastructure returns an area to normalcy and helps to isolate adversaries from regaining popular support. The theater army also plans and conducts exercises and tests to demonstrate their capability and commitment to rapidly respond should escalation occur.

(2) Field army. In the return to competition, the field army may be required to act as a transitional military authority and control large-scale security force assistance activities to include restructuring of host-nation forces. The field army maintains the necessary formations and other capabilities to provide credible deterrence and ensures the ability to quickly respond to escalation within the AO.

(3) Corps. The corps, with augmentation, may transition to a JTF designed to command and control joint, intergovernmental, and multinational partners in order to conduct extensive reconstruction and restore essential services. The corps may be required to remain in the theater for a significant period of time to ensure stability while retaining the capability to rapidly renew offensive operations should hostilities resume.

(4) Division. Deployed divisions remain forward postured initially to deter armed conflict and challenge any renewed adversary anti-access and aerial denial activities. Divisions conduct assigned stability tasks while remaining postured for potential armed conflict should hostilities renew. Divisions continue to support security cooperation efforts by partnering with local forces to ensure the security situation remains in the new lower level of competition, simultaneously expanding both the theater and the partner capacities. As the risk of armed conflict subsides to acceptable levels, the division repositions rearward to protected locations or, if appropriate, redeploys to CONUS.

4-4. Building capability at echelon

a. Future EAB formations are complementary organizations possessing the appropriate capacities and capabilities necessary to create cross-domain positions of advantage and deter or defeat near-peer adversaries across the competition continuum. Future theater armies are uniquely tailored to the specific theater to conduct their critical theater management responsibilities, see and understand the threats in their AOR, and conduct operational preparation of their environment to allow the Army to succeed in any of its four strategic roles. In AORs with the highest risk of LSGCO with a near-peer threat requiring multiple corps formations to prevail in LSGCO, a standing field army is organic to the theater. Its focus is on deterring a specific near-peer threat and, if necessary, rapidly transitioning to an LCC to defeat them in armed conflict. The future corps is the Army's most agile and versatile echelon capable of commanding multiple divisions as an intermediate tactical command as well as accepting augmentation and conducting operations as a land component or joint force command in limited contingency operations. Future battlefields are complex, chaotic, highly lethal, and unforgiving; the cost of avoidable tactical mistakes is unacceptably high. Accordingly, future Army divisions are specifically organized, equipped, and trained to dominate the close fight against a near-peer adversary in LSGCO.

b. *Uniquely tailored theater armies to maintain an enduring operational initiative.*⁵⁷ The theater army is unique, as it is the only persistent Army echelon for a geographic AOR. As an ASCC, all theater armies share the same basic set of theater management tasks distilled to five primary categories: setting and maintaining the conditions in the theater for the employment of landpower with and among joint, interorganizational, and multinational partners (setting the theater); Army support to theater security cooperation; ASOS; administrative control over all Army forces in the AOR; and operational control and sustainment support of any assigned or attached Army forces until the combatant commander attaches those forces to a subordinate joint command.⁵⁸ However, future theater armies, in near-peer adversary theaters, require greater operational warfighting capabilities (ISR, EW, air defense artillery, ballistic missile defense, cyberspace, space, information environment operations, and hardened C2 capabilities) to defeat adversary aggression in competition below armed conflict, and to create protected operational positions of advantage during the transitions from competition to armed conflict and back to competition.⁵⁹ These required warfighting capabilities have the greatest variance from theater to theater. In the future OE, theater armies play *the* pivotal role in winning the competition below armed conflict and, should armed conflict be required, ensuring that Army and coalition forces can operate from protected operational positions of advantage.⁶⁰

(1) Theater armies are not and cannot be identical as each theater is different, comprising a variety of threat conditions spanning the competition continuum. Therefore, each theater army's capabilities are tailored to the specific AOR and threats. A theater army must have the necessary training resources and infrastructure to foster and create joint, multinational, and interorganizational interoperability and readiness; the operational capabilities to shape its theater to deter armed conflict and, should deterrence fail, set the conditions for operational and tactical success; and the ability to serve as a land component command (LCC)—including enablers to support multiple corps—in theaters with a near-peer threat. It must possess the warfighting capabilities and domain expertise to turn denied spaces into contested spaces in competition below armed conflict and create the conditions for subordinates to win in cases of LSGCO. Theater

armies are tailored to provide persistent warfighting capability in an AOR responsive to the GCC, and conduct necessary reconnaissance, surveillance, security, protection, and intelligence operations and operational preparation of the environment across the entire theater.

(2) Within the MDO Concept's framework, units assigned to theater army reside predominately in the operational support area though they provide reachback to the strategic support area to obtain the necessary capabilities required in theater. The theater army sets conditions across the theater but, during armed conflict, directly affects and influences the threat in the operational deep fires area in support of the field army.

(3) Each theater army headquarters comprises a main command component that can manage operations and plan for contingencies, and an contingency command component that can respond to crises for a limited period.⁶¹ These command components should not be considered synonymous with command nodes. Mission analysis determines the composition and location of command nodes. The main command component can be organized as main and rear or support area command nodes, for example, with the contingency command component acting as an early-entry or forward command node with a mobile command group. Regardless of how command nodes are positioned on the future battlefield, the main and contingency command components function together as one integrated headquarters.

c. Threat-focused field armies to provide credible deterrence, execute multi-domain competition against near-peer threats, and enable rapid transition to, and execution of, LSGCO. While all theaters require an operational capability, some theaters have adversaries that present enough risk of LSGCO that those theaters require an additional standing echelon that can manage specific operations within the AOR and then transition rapidly to a LCC. Historically, this has been a field army commanding two or more corps, but other factors drive the need for a field army and its actual composition.

(1) The field army is the primary headquarters for executing a persistent campaign of competition against an identified near-peer adversary in a theater. The field army provides mission command for forces within that AO. The field army has the ability to expand capabilities as necessary to counter or overmatch threats, or respond to unforeseen crises. If necessary, the field army operates as a LCC for the GCC. The field army enables rapid transition from competition to conflict, shapes the operational deep fires area, executes multi-domain competition against a near-peer, exploits the initiative, and commands multiple U.S. and multinational corps and enablers in theaters with near-peer threats.

(a) A field army is employed to relieve operational burden on the theater army, where attention to a specific operation in a subordinate geographic area would detract from the theater army's ability to support strategic objectives in the theater as a whole. The field army is forward stationed to account for higher probability of LSGCO or other vital geopolitical considerations requiring partner assurance.⁶² It is required in areas of persistent, intense competition with a near-peer threat with a likelihood of large-scale land combat. The field army can serve as the foundation for a joint task force (JTF), joint forces land component command (JFLCC), or merge into a standing—but under-resourced—alliance headquarters.

(b) While a field army is force tailored to its specific AO and threat, it is capable of changing over time as the situation changes. Corresponding documentation is developed as a tailored template for each region, with manning occurring based on potential or actual hostilities. The field army must be capable of gaining and maintaining contact across all domains, converging multi-domain capabilities, and transitioning across the competition continuum to maintain the initiative. The field army—in theaters with a near-peer adversary—is an enduring formation, remaining active as long as that adversary presents an unacceptable level of competition and threat within the theater. In theaters where the land domain has primacy—that is, where the other domains predominantly converge, the field army can serve as the GCC’s lead agent for multi-domain integration in competition below armed conflict. An established field army is well positioned to provide operational command in case of conflict to ensure successful transition to and execution of LSGCO, and the continuous consolidation of gains to facilitate transition back to competition.

(2) Within the MDO Concept’s framework, units assigned to the field army operate within the operational support area forward of the theater army. While the theater army addresses the entire AOR, the field army maintains continuous focus and pressure on the threat, and sets conditions across its smaller AO. The field army retains subordinate units to quickly respond to threat escalation and rapidly close with enemy forces to shape an emerging close area fight. The field army is key to rapidly converging forces and capabilities within the AO as the conduit to bring capabilities outside of the AO to bear and create overwhelming combat power against an enemy during the transition to armed conflict.

d. *The corps as the linchpin of EAB versatility and agility.* The corps must be the most versatile echelon in the Army because no other echelon can. Since theater armies are tailored to their respective theaters, and operational support of Army missions defines their functions to a great degree, the versatility at the theater level is limited. Similarly, but as a smaller subset, a field army is sharply focused on succeeding in competition below armed conflict against a specific near-peer threat within the theater and, if necessary, setting conditions to rapidly transition to armed conflict. Conversely, divisions must maintain an uncompromising emphasis on readiness for the task of integrating multiple BCTs and enabling formations as a highly lethal and cohesive tactical formation to win in armed conflict. This limits an aspect of versatility at the division. The corps, functioning as the link between the operational and tactical levels of war, emerges as the echelon that affords the greatest potential for adapting to account for uncertainty of threats, the environment, and potentially flawed predictions based on incomplete information.⁶³

(1) The corps is composed of organic and assigned warfighting components and a headquarters designed, organized, equipped, and trained to receive, integrate, and assimilate joint, multinational, and interorganizational augmentation. The corps retains its ability to perform its traditional role of commanding divisions and enablers in LSGCO.⁶⁴ Yet as the Army’s most adaptable headquarters, the corps is fully capable of transitioning to a JTF or JFLCC to execute a range of missions from humanitarian assistance, to limited contingency operations, and to large-scale combat against lesser threats (less than a near-peer) where a corps or less of combat power is adequate.⁶⁵ While the breadth of missions that a corps is able to conduct can create the appearance of risk to its ability to conduct LSGCO, it is mitigated by the tactical experience gained by its leaders and staff in prior assignments.⁶⁶

U.S. Army Concept for Multi-Domain Combined Arms Operations at Echelons Above Brigade

(2) Though highly versatile, future Army corps are the foremost tactical warfighting formations with assigned capabilities and capacities to see and understand, decide, shape, strike rapidly, and endure. Corps have assigned military intelligence, multi-domain reconnaissance and security, fires (artillery and air defense), maneuver support, space, cyberspace, information environment operations, EW, sustainment, and aviation formations as principal capabilities with which to train and prepare to deploy on short notice to austere locations and conduct operations immediately upon arrival. Future capabilities enable the corps to conduct deep operations physically, temporally, virtually, and cognitively, and enable subordinate tactical formations to dominate the close fight. While these capabilities are assigned to the corps, they can be further task organized to directly support the main effort.

(3) The corps main command component provides the corps' capability to execute its traditional role. When the expeditionary command component is deployed for an extended period, the main command component is the source for rotational personnel. The corps main command component in its traditional role not only commands multiple divisions, separate brigades, and functional and multifunctional brigades and battalions, it performs tasks critical to conducting deep cross-domain maneuver; enabling and shaping its subordinate divisions' fights, consolidating gains, and creating tactical and operational endurance to maintain cross-domain positions of advantage. The corps expeditionary command component is the cornerstone of versatility for the corps echelon. It is a cross-section of the functional staff, identical in capability to the main command component although limited in size and capacity. It is globally deployable on short notice. It is formally trained on both joint and Army doctrine, better enabling transition to a JTF or JFLCC, if required.

(4) Within the MDO Concept's framework, the corps is subordinate to either the theater army or, if present, the field army, and arrays forces within a band that encompasses the forward operational support area and the rear of the tactical support area. The corps shapes the deep maneuver and close areas, executes operational deep fires, and coordinates deep cross-domain maneuver. While capable of deploying anywhere, all corps are regionally aligned to provide further assurance to allies that the U.S. stands ready to support its agreements.

e. Tactically focused divisions to shape, dominate, and win the close fight. The division's role of commanding and sustaining multiple BCTs and enabling formations in tactical operations remains its primary focus, and is the crux of the Army's ability to gain and maintain contact and defeat an enemy maneuver force in violent combat.⁶⁷ Given the future OE, division commanders and staffs must hone their tactical warfighting skills while incorporating the ability to integrate capabilities from new domains into the close fight. The singular, uncompromising focus of future Army divisions is lethal, tactical warfighting; it is the principal tactical echelon above brigade.⁶⁸ Future Army divisions have assigned reconnaissance and security, aviation, fires, maneuver enhancement, and sustainment formations, as well as subordinate brigade combat teams. Divisions that are properly force-tailored, postured, and positioned—are a powerful, credible, and devastatingly lethal deterrent to any would-be threat.⁶⁹

(1) The future Army division is expeditionary and assimilates additional functional and multifunctional units easily, enhancing its ability to conduct deep operations and improving its sustainability. The future division can adjust its task organization easily, increasing its agility and

unpredictability throughout the conduct of the close fight. Its staff has the capability and capacity to identify and expertly employ all assigned or aligned enabling functions. The division headquarters possesses enough functional expertise to coordinate for support from units that may normally be assigned to higher echelons, specifically space, cyberspace, and information environment operations. Keeping execution of some capabilities at higher echelons prevents unnecessarily encumbering the division with tasks not directly related to isolating, dislocating, disintegrating, and destroying enemy forces.⁷⁰ However, the division is the EAB formation that serves as the conduit to bring all domain warfighting capabilities to bear on winning the close fight.

(2) Future Army divisions have assigned military intelligence, reconnaissance and security, fires, sustainment, maneuver support, and aviation units that form the core of a cohesive, warfighting formation capable of conducting tactical operations and winning the close fight in LSGCO. Divisions converge cross-domain capabilities, shape the deep maneuver and close area, and plan, prepare, execute, and assess deep maneuver.

(3) During LSGCO, divisions array forces within the tactical support and close areas of the MDO Concept's operational framework. The division shapes deep maneuver and close areas while executing deep maneuver with ground and aviation forces. The division weights the effort appropriately and employs BCTs and enabling units to defeat enemy forces in the close area, simultaneously consolidating gains achieved.

Chapter 5

Conclusion

a. The Army faces an uncertain, highly competitive, and dynamic future OE and prepares to conduct the full range of military operations across the competition continuum. To succeed in competition while maintaining preparedness for combat, Army forces gain and maintain initiative continuously. Across diverse AORs, the Army does this through enabled EAB formations dynamically postured with the necessary capabilities, capacities, and authorities to create windows of superiority and converge multi-domain effects against enemy vulnerabilities.

b. The expanded problem set of EAB formations in the competition continuum require formations enabled with capabilities necessary to counter threat action below the threshold of conflict while maintaining the capability to transition and quickly counter overt conventional fights. Uniquely tailored theater armies, threat-focused field armies, agile corps, and lean, tactically focused divisions are crucial to gaining and maintaining the initiative required to win the fight before it begins or, if necessary, quickly end it on more favorable terms.

Appendix A

References

Section I:

Required references

Army regulations (ARs), Department of the Army pamphlets (DA Pams), Army field manuals (FMs), Army doctrine publications (ADPs), Army doctrinal reference publications (ADRP) and DA forms are available at Army Publishing Directorate Home Page <http://www.usapa.army.mil>. U.S. Army Training and Doctrine Command (TRADOC) publications and forms are available at TRADOC Publications at <http://www.tradoc.army.mil>. Joint publications (JPs) are available at the Joint Electronic Library at <http://www.dtic.mil/doctrine>.

TP 525-2-1

The U.S. Army Functional Concept for Intelligence

TP 525-3-0

The U.S. Army Capstone Concept

TP 525-3-1

The U.S. Army Operating Concept: Win in a Complex World

TP 525-3-3

The U.S. Army Functional Concept for Mission Command

TP 525-3-4

The U.S. Army Functional Concept for Fires

TP 525-3-5

The U.S. Army Functional Concept for Maneuver Support

TP 525-3-6

The U.S. Army Functional Concept for Movement and Maneuver

TP 525-4-1

The U.S. Army Functional Concept for Sustainment

TRADOC. (2017, December). *Multi-Domain Battle: Evolution of Combined Arms for the 21st Century*. Fort Eustis, VA. Available from the proponent upon request.

Section II:

Related references

Alexander, K. (2013, August). The Army's way ahead in cyberspace. *Army Magazine*, 63 (8), 22-25.

U.S. Army Concept for Multi-Domain Combined Arms Operations at Echelons Above Brigade

Angeles, R. (2017, November-December). Assessing the value of serving in an Army service component command as a broadening assignment. *Military Review*, 97(6), 54-59.

ADP 1
The Army

ADRP 3-07
Stability

ADRP 3-28
Defense Support of Civil Authorities

ADRP 3-90
Offense and Defense

ADRP 5-0
The Operations Process

AR 10-87
Army Commands, Army Service Component Commands, and Direct Reporting Units

AR 11-30 (28 July 1995)
Army WARTRACE Program (Obsolete)

AR 34-1
Multinational Force Interoperability

Aretz, D. (2018, March 28). Information operations in a multi-domain operations battlespace. *Over the Horizon*. Retrieved from <https://othjournal.com/2018/03/28/information-operations-in-a-multi-domain-operations-battlespace/>

Association of the U.S. Army News Staff. (2017, December 14). Policy, process limiting cyber effectiveness. *AUSA News*. Retrieved from <https://www.ausa.org/news/policy-process-limiting-cyber-effectiveness>

ATP 3-91
Division Operations

ATP 3-92
Corps Operations

ATP 3-93
Theater Army Operations

ATP 3-94.2
Deep Operations

U.S. Army Concept for Multi-Domain Combined Arms Operations at Echelons Above Brigade

Bērziņš, J. (2014, April). *Russia's New Generation Warfare in Ukraine: Implications for Latvian Defense Policy*. Center for Security and Strategic Research, National Defence Academy of Latvia. Retrieved from <http://www.naa.mil.lv/~media/NAA/AZPC/Publikacijas/PP%2002-2014.ashx>

Big Data Analytics. Retrieved from <https://www.ibm.com/analytics/us/en/big-data/>.

Bohannon, D. (2017, October 18). Warriors corner: Installations of the Future. *Army News Service*.

Brewer, V. (2017, February 6). Joint and Army Experimentation Division, U.S. Army Capabilities Integration Center. *Roles and Responsibilities Above Brigade in the Future Force: A White Paper*. Fort Eustis, VA. Available upon request through the proponent.

Brimley, S., FitzGerald, B., & Saylor, K. (2013, September). *Game Changers: Disruptive Technology and U.S. Defense Strategy*. Center for a New American Security. Washington, DC.

Brown, R. & Perkins, D. (2017, August 18). Multi-domain battle: Tonight, tomorrow, and the future fight. *War on the Rocks*. Retrieved from <https://warontherocks.com/2017/08/multi-domain-battle-tonight-tomorrow-and-the-future-fight/>

Capstone Concept for Joint Operations (CCJO): Joint Force 2020

DA. (2014). Army Strategic Planning Guidance 2014. Retrieved from <http://www.army.mil/info/references/>

DA, Chief of Staff of the Army Strategic Studies Group-I. (2013, July). *Testing Assumptions about the Role of Land Power in 2030 Final Report*. Washington, DC. Available upon request through the proponent.

DA, Office of the Army Deputy Chief of Staff, G-4, Logistics Initiative Group. (2018, January-February). Looking back for the way ahead: An interview with retired Gen. Lloyd Austin. *Army Sustainment*, pp. 36-40. Retrieved from <http://www.alu.army.mil/alog/2018/JANFEB18/PDF/198441.pdf>

DeGennaro, P. (2017, September 19). The power of cognitive maneuver: Don't underestimate its value. *Small Wars Journal*. Retrieved from <http://smallwarsjournal.com/jrnl/art/the-power-of-cognitive-maneuver-don%E2%80%99t-underestimate-its-value>

DOD. (2010, December 12). DODD Directive 5100.01: Functions of the Department of Defense and its Major Components. Retrieved from <http://www.dtic.mil/whs/directives/corres/dir.html>

DOD. (2013, August 5). DOD Instruction 8320.02: Sharing Data, Information, and Information Technology (IT) Services in the Department of Defense. Retrieved from <http://www.dtic.mil/whs/directives/corres/pdf/832002p.pdf>

U.S. Army Concept for Multi-Domain Combined Arms Operations at Echelons Above Brigade

Duggan, P. (2017, August 3). How the enemy could hit the U.S. Army at home. *War on the Rocks*. Retrieved from <https://warontherocks.com/2017/08/how-the-enemy-could-hit-the-u-s-army-at-home/>

Esper, M. (2017, December 7). Statement by the Honorable Mark T. Esper, Secretary of the Army before the Committee on Armed Services United States Senate. Washington, DC.

FM 3-0
Operations

FM 3-13
Information Operations

FM 3-90
Offense and Defense

FM 6-0
Commander and Staff Organization and Operations

Freedberg, S. (2017, September 15). Army helicopters: Piecemeal modernization for future wars. *Breaking Defense*. Retrieved from <http://breakingdefense.com/2017/09/army-helicopters-piecemeal-modernizing-for-future-war/>

Fuller, JF.C. (1927, May). Tactics and mechanization. *Infantry Journal*. Retrieved from http://www.arcic.army.mil/App_Documents/LPD/Fuller_Tactics_and_Mechanization.pdf

Gandy, C. (2017, July 20). Time is always a constraint: Transforming headquarters organization and employment for the multi-domain battle environment. *Small Wars Journal*. Retrieved from <http://smallwarsjournal.com/print/72549>

Ham, C. (2017, October 4). The great war echoes today: Army faces similar challenges a century later. *Army Magazine*. Retrieved from <https://www.ansa.org/articles/great-war-echoes-today-army-faces-similar-challenges-century-later>

Heftye, E. (2017, May 26). Multi-domain confusion: All domains are not created equal. *Strategy Bridge*. Retrieved from <https://thestrategybridge.org/the-bridge/2017/5/26/multi-domain-confusion-all-domains-are-not-created-equal>

How to keep cool without cost to the Earth. (2017, February 11). *The Economist*. Retrieved from <https://www.economist.com/news/science-and-technology/21716599-film-worth-watching-how-keep-cool-without-costing-earth>

Johnson, D. (2018, January). The importance of land warfare: This kind of war redux. *The Land Warfare Papers*, (117). Arlington, VA: The Institute of Land Warfare, Association of the United States Army. Retrieved from <https://www.ansa.org/publications/importance-land-warfare-kind-war-redux>

U.S. Army Concept for Multi-Domain Combined Arms Operations at Echelons Above Brigade

Joint Concept for Cyberspace

Joint Concept for Integrated Campaigning

Joint Concept for Operations in the Information Environment

Joint Operational Access Concept

JP 3-0

Joint Operations

JP 3-14

Space Operations

JP 3-15.1

Counter-Improvised Explosive Device Operations

JP 3-20

Security Cooperation

JP 3-31

Command and Control for Joint Land Operations

JP 3-33

Joint Task Force Headquarters

JP 5-0

Joint Planning

Khoso, M. (2016, May 13). How much data is produced every day? *Northeastern University New Ventures*. Retrieved from <http://www.northeastern.edu/levelblog/2016/05/13/how-much-data-produced-every-day/>

Linder, J., Merdith, S., & Johnson, J. (2017, August 6). The battlefield of tomorrow fought today: Winning in the human domain. *Small Wars Journal*. Retrieved from <http://smallwarsjournal.com/print/73450>

Lorenzen, T. (2017, May 9). The edge of chaos: Emergent factors in the information environment. *The Strategy Bridge*. Retrieved from <https://thestrategybridge.org/the-bridge/2017/5/9/the-edge-of-chaos-emergent-factors-in-the-information-environment>

Macgregor, D. (2017, July 16). Why America's Army is falling apart. *The National Interest*. Retrieved from <http://nationalinterest.org/feature/why-americas-army-falling-apart-21546>

U.S. Army Concept for Multi-Domain Combined Arms Operations at Echelons Above Brigade

Mattis, J. (2017, October 5). [Memorandum for All Department of Defense Personnel]. *Guidance from Secretary Jim Mattis*. Retrieved from <https://www.defense.gov/Portals/1/Documents/pubs/GUIDANCE-FROM-SECRETARY-JIM-MATTIS.pdf>

McCarthy, R. & Milley, M. (2017, October 3). [Memorandum]. *Modernization priorities for the United States Army*. Washington, DC.

McMaster, H. (2003, April 7). *Crack in the Foundation: Defense Transformation and Underlying Assumption of Dominant Knowledge in Future War*. U.S. Army War College Strategy Research Project. Carlisle Barracks, PA.

Milley, M. (2015, October). Winning matters: Especially in a complex world. *Army Magazine*, 65(10), 21-26.

Murphy, P. & Milley, M. (2016, April 7). [Record Version]. Statement by the Honorable Patrick J. Murphy, Acting Secretary of the Army and General Mark A. Milley, Chief of Staff United States Army before the Committee on Armed Services United States Senate. Washington, DC.

Murray, J., Anderson, J., Ostrowski, P., & Dyess, R. (2018, February 7). [Record Version]. Statement by Lieutenant General John M. Murray, Deputy Chief of Staff of the Army, G-8; Lieutenant General Joseph Anderson, Deputy Chief of Staff of the Army, G-3/5/7; Lieutenant General Paul A. Ostrowski, Military Deputy to the Assistant Secretary of the Army for Acquisition, Logistics, and Technology; and Major General Robert M. Dyess, Jr. before the Subcommittee on Airland Committee on Armed Services United States Senate. Washington, DC.

Paiste, D. (2015, November 6). Quantum materials: A new paradigm for computing? *MIT News*. Retrieved from <http://news.mit.edu/2015/quantum-materials-new-paradigm-computing-1106>

Perkins, D. & Holmes, J. (2018, 1st Quarter). Multidomain battle: Converging concepts toward a joint solution. *Joint Force Quarterly*, 88, pp. 54-57.

Pomerleau, M. (2017, May 9). 6 priorities on Cyber Command's extensive to-do list. *Fifth Domain*. Retrieved from <http://fifthdomain.com/2017/05/09/6-priorities-on-cyber-command039s-extensive-to-do-list/>

Pomerleau, M. (2017, September 14). Cyber is being normalized with traditional military operations. *Fifth Domain*. Retrieved from <http://www.fifthdomain.com/dod/2017/09/14/cyber-is-being-normalized-with-traditional-operations/>

Pomerleau, M. (2018, April 17). Army to test new data sharing equipment at upcoming exercise. *C4ISRNET*. Retrieved from <https://www.c4isrnet.com/it-networks/2018/04/17/army-to-test-new-data-sharing-equipment-at-upcoming-exercise/>

Probert, T. (2018, April 16). US military dominance requires better command-and-control tool. *Defense One*. Retrieved from <https://www.defenseone.com/ideas/2018/04/us-military-dominance-requires-better-command-and-control-tools/147491/?oref=d-river>

Scales, R. (2018, April 9). Forecasting the future of warfare. *War on the Rocks*. Retrieved from <https://warontherocks.com/2018/04/forecasting-the-future-of-warfare/>

Shimerdla, J. & Kort, R. (2018, May-June). Setting the theater: A definition, framework, and rationale for effective resourcing at the theater army level. *Military Review*, 98 (3), 55-62.

Simontis, N. (2017, September-October). In defense of the theater army. *Military Review*, 97 (5), 30-36.

South, T. (2017, October 9). 4-star: Multi-domain battle will fundamentally change how the Army, other services fight. *Air Force Times*. Retrieved from <https://www.airforcetimes.com/news/your-army/2017/10/08/4-star-multi-domain-battle-will-fundamentally-change-how-the-army-other-services-fight/>

Terry, J. (2016, January 12). Curtain's always rising for theater army. *Army Magazine*. Retrieved from <https://www.ausa.org/articles/curtain%E2%80%99s-always-rising-theater-army>

Thorpe, J., Girling, K., & Auger, A. (2017, July 13). Maintaining military dominance in the future operating environment: A case for emerging human enhancement technologies that contribute to soldier resilience. *Small Wars Journal*. Retrieved from <http://smallwarsjournal.com/jrnl/art/maintaining-military-dominance-in-the-future-operating-environment-a-case-for-emerging-huma>

von Clausewitz, C. (1975). *On war*. (Ed. and trans. Michael Howard and Peter Paret). NJ: Princeton University Press.

White House (The). (2017, December). *National Security Strategy of the United States of America*. Washington, DC: The White House. Retrieved from <https://www.whitehouse.gov/wp-content/uploads/2017/12/NSS-Final-12-18-2017-0905.pdf>

Woods, K. & Greenwood, T. (2018, 1st Quarter). Multidomain battle: Time for a campaign of joint experimentation. *Joint Force Quarterly*, 88, pp. 14-21.

Appendix B

Required Capabilities

B-1. Introduction

- a. This appendix reflects level one required capabilities (RCs).

(1) Level one RCs are generated from the key ideas in the concept and are the primary inputs into formal assessments and analysis and are the key capabilities to be integrated by the U.S. Army Capabilities Integration Center to ensure support of the endstates described in higher concepts.

U.S. Army Concept for Multi-Domain Combined Arms Operations at Echelons Above Brigade

(2) Level two RCs are dependencies to or from another concept that inform the development of the tasks, conditions and standards for level one RCs and serve as the guideposts for further capability development. Level two RCs are generated from other concepts to reflect the capabilities that a formal analysis must address for the ideas in those other concepts to succeed. As the EABC addresses future combined arms warfighting formations, *all RCs from the Army's formal family of concepts are essential to achieving the solutions within this concept.*

b. Development of future force EAB capabilities adhere to the capability development principles outlined in the AOC and restated below.⁷¹

(1) Ensure capacity and readiness to accomplish missions that support achieving National objectives.

(2) Build new capacity or adjust existing capabilities to cope with emerging threats or achieve overmatch.

(3) Maintain U.S. Army asymmetrical advantages.

(4) Maintain essential theater foundational and enabling capabilities.

(5) Prioritize organizations and competencies that are most difficult to train and regenerate.

(6) Cut unnecessary overhead to retain fighting capacity and decentralize capabilities whenever possible.

(7) Maintain and expand synergies between the operating force and institutional Army.

(8) Optimize performance of the Army through a force mix that accentuates relative strengths and mitigates weaknesses of each component.

c. On 6 October 2017, the Chief of Staff of the Army (CSA) directed the establishment of a task force to explore all options to establish unity of command and unity of effort that consolidates the Army's modernization process under one roof. As part of these efforts, the Army established designated cross-functional team (CFT) pilots to embrace horizontal and vertical integration and improve the quality and speed of materiel development activities. These designated CFTs support the authority of the CSA to assist the Secretary of the Army in the development and approval of requirements. The CFTs consist of warfighters and developers from across the capability development and acquisition enterprise working together to narrow existing capability gaps. The CFT approach is meant to develop capabilities faster and in a less-costly manner than existing methods.

d. While the CFTs were established to close existing gaps, the EABC potentially identifies new gaps that may subsume existing gaps or identify separate gaps that may be addressed by expedited CFT solutions developing for existing gaps. Consequently, CFT modernization efforts must be considered when analyzing the ideas presented within this concept. The eight CFT pilots, aligned with the CSA's six modernization priorities, are:

- (1) Long-Range Precision Fires—Long-Range Precision Fires CFT pilot (LRPF).
- (2) Next Generation Combat Vehicle—Next Generation Combat Vehicle CFT pilot (NGCV).
- (3) Future Vertical Lift: Future Vertical Lift CFT pilot (FVL).
- (4) Network Command, Control, Communication, and Intelligence—
 - Network Command, Control, Communication, and Intelligence CFT pilot (NC3I).
 - Assured Positioning, Navigation, and Timing CFT pilot (PNT).
- (5) Air and Missile Defense—Air and Missile Defense CFT pilot (AMD).
- (6) Soldier Lethality—
 - Soldier Lethality CFT pilot.
 -
 - (b) Synthetic Training Environment CFT pilot (STE).

e. The following capability statements are not stand-alone; they must be understood based upon this concept and not the reader's own interpretation. Each required capability is followed by reference paragraphs from this concept, the appropriate functional concept, and, if applicable, higher-level concepts. These references are termed integrity of intent and are included to help readers understand the context and intent of the required capability, thereby reducing the likelihood of misinterpretation during subsequent capability analysis and development.

B-2. Level one required capability statements

a. Future combined arms formations above BCT require the ability to persistently compete throughout the competition continuum beneath the threshold of armed conflict to maintain an enduring initiative. (EABC: 3-3.a., 3-4.c., & 4-2.c. (2)(c) and MDO: B-2d & B-2.f.)

b. Future combined arms formations above BCT require the ability to see and understand across the depth and breadth of the multi-domain battlespace to reveal threat intentions, strategies, capabilities, and tactics. (EABC: 3-3.a., 3-4.b., 3-4.b.(4)(a), & 4-3.a., and MDO: B-2.c.)

c. Future combined arms formations above BCT require the ability to rapidly respond to regional emergencies and emergent threats with sufficient capability, capacity, and endurance to return to pre-crisis or better conditions. (EABC: 2-2.d., 2-2.f.(2), 3-1., 3-4.c.(4), 3-4.d.(1), & 4-2.b.(1) and MDO: B-2.i.)

d. Future combined arms formations above BCT require the ability to ensure sufficient interoperability, capability, and capacity among joint, interorganizational, and multinational partners to enable coordination, cooperation, and unity of command to effectively accomplish mutual objectives. (EABC: 3-4.c., 3-5.d., 4-2.c., & 4-3.b. and MDO: B-2b & B-2.k.)

U.S. Army Concept for Multi-Domain Combined Arms Operations at Echelons Above Brigade

e. Future combined arms formations above BCT require the ability to gain and maintain access to the operational area and create the diplomatic, military, and infrastructure conditions for joint entry, freedom of action, and endurance to last throughout campaign. (EABC: 3-3.d., 3-4.b., 3-4.d., & 4-2.c.(1)(a) and MDO: B-2.b.)

f. Future combined arms formations above BCT require the ability to converge multi-domain capabilities and all elements of national power to maneuver disaggregated throughout the depth and breadth of the battlespace and rapidly mass physically, virtually, and cognitively throughout all domains and against highly capable near-peer threats. (EABC: 3-3.d., 3-4.b.(1), 3-4.d.(3), 3-4.e., 3-4.f., 3-5.h., 4-2.c., & 4-2.f.; MDO: B-2e and B-2g; and LRPF, NGCV, NC3I, & FVL CFTs)

g. Future combined arms formations above BCT require the ability to rapidly deploy, force tailor, and task organize across Army components and combatant commands to enable quick transitions and adaptation to changing missions or environments and prevail in large-scale ground combat operations. (EABC: 3-5.a.(3) & 4-2.g.(2)(b) and MDO: B-2.a. and B-2.h.)

h. Future combined arms formations above BCT require the ability to rapidly analyze large volumes of data to thoroughly understand the environment; identify critical threat vulnerabilities, detect all hazards, and warn the force; and create viable options to support commanders' decision making (EABC: 3-4.e., 4-1.e.(1), & 4-2.e.(3) and NC3I CFT)

i. Future combined arms formations above BCT require the ability to continuously consolidate gains to ensure lasting outcomes and a more favorable security environment within the AOR. (EABC: 3-3.b., 3-4.g., & 4-2.g. and MDO: B-2.j.)

j. Future combined arms formations above BCT require the ability to create temporarily protected corridors and positions of advantage and defeat or destroy long-range threat systems operating from the operational and strategic fires areas. (EABC: 4-2.e.(2)(b) & 4-2.e.(3)(c) and LRPF & FVL CFTs)

k. Future combined arms formations above BCT require the ability to establish friendly integrated air defense zones, rapidly move and reconfigure air defense assets, and easily extend coverage to support combined arms maneuver. (EABC: 4-2.c.(2) and AMD CFT)

Appendix C **Science and Technology (S&T) to Support Future EAB Formations**

C-1. Introduction

a. This appendix recommends key S&T capabilities to enable EAB formations to exercise mission command and fulfill their future roles in 2025-2045. Acquiring these technologies requires targeted investment, extensive experimentation, and constant reassessment—the era of sustained technological advantage is past. With these capabilities, EAB headquarters can support subordinate units by shaping the environment, managing data and information, and creating physical, virtual, and cognitive windows of superiority. To achieve this, the Army must judiciously

follow and integrate knowledge management principles and work with academic experts, joint partners, industry leaders, and key stakeholders to develop the requisite future force capabilities.⁷²

b. Due to the nature of mission command, future Army forces must appreciate and carefully consider the dynamic relationship between it and other warfighting functions. That is to say, S&T developments in mission command affect all other functions much like advances in other branches can affect how leaders apply mission command. The interoperability between these capabilities is paramount to achieving synergy between functions, echelons, or branches. These relationships require continual assessment and consideration between capability and material developers to ensure fielded capabilities remain interoperable within the Army and joint environments. The technologies identified here are not prescriptive, but act as guides in developmental efforts.

c. The window of influence for program development is important. The acquisition system, program budgets, and schedules provide the developmental path for current mission command programs through the next seven to ten years of technical development. Consequently, this appendix focuses on S&T capabilities and developing technological trends that are likely to continue through the 2028-2045 timeframe. This includes technologies currently available, but also others requiring additional development to be adapted to the OE.

C-2. The future OE will be data driven

a. EAB formations assigned to combatant and functional commands must be able to continuously aggregate data, understand nuances, and appreciate the complexity of their AO, including country, groups, organizations, cultures, religions, and other operational and mission factors. However, the facets of complexity are numerous and the challenges to achieve understanding increase every day. Not only must EAB formations collect and process this information, they must make it useful for subordinate forces that do not possess regional experience or understand the complexities of a given theater of operations. Future EAB formations must have access to relevant and appropriate data sources and through effective use of knowledge management capabilities to rapidly gain and maintain an understanding of the OE. Subordinate units will be consumers of these pre-processed data sets.

b. The challenge to collect and manage this data will be tremendous and the sheer scale of future data sets will seem daunting. The International Business Machines Corporation (IBM) currently estimates the world creates 2.5 million terabytes daily while Northeastern University estimates by 2020 the world will have produced 44 *trillion* gigabytes of information. Extrapolating these figures even further into 2025 and beyond will place such esoteric terms such as petabyte, exabyte, and zetabyte into common vernacular. But with such scales of information on the horizon, the ability to understand even small portions of those data sets would be nearly impossible without focused S&T investment. The age of “big data” has arrived, and it will only get bigger.⁷³

c. Unstructured data has always existed, but computers in the 20th century generally required structured data sets to provide coherent results or execute defined programs. Despite efforts to create data standards to make digital information readable and searchable, unstructured data will continue to comprise the vast majority of information that will be generated. Current industry leaders such as Google, Microsoft, Facebook, and Amazon have created tools to manage and

understand known data types such as text, pictures, and videos. However, the emergent fields of virtual and augmented reality offer a window into data types the Army has yet to fully encounter or appreciate. Data may only make sense if it is placed in certain contexts such as virtual environments or in holograms that correspond to unique physical locations, challenging future collection and analysis. The democratization of technology has facilitated data entropy where more and more users and devices will create their own types of data and choose how they interact with the data.

d. Understanding the data problem is large and complex, the Army must leverage commercial tools to ingest data sets while others assist in prioritizing which sources require human analysis. These data processing tools must be able to analyze information to reveal patterns, trends, and associations, especially relating to human behavior and interactions. Technologies that allow EAB headquarters staffs to exploit big data can be one of the most relevant technologies that enables a deep understanding of the future OE.

e. The list below are examples of big data sets to which the Army needs access to understand potential OEs throughout the world. While the Army has authorities and certain responsibilities to collect information, much of the responsibility for collecting this data lies with agencies other than the Army. However, all data sets should be made available to the Army (and DOD) to inform tools capable of supporting operational design and contingency planning processes and products. Likely data sets of interest include:

- International, national, corporate, and individual financial transaction information.
- Social media trends, behaviors, and preferences.
- International, national, state, and local criminal activity patterns and police records.
- National, state, and local retail purchase information.
- National, state, and local web search patterns.
- National, state, and local website usage trends.
- National, state, and local commercial travel and passport information.
- National, state, and local cell phone use and location information.
- Location and movement of specific people of interest.

f. As technology becomes cheaper, the number of sensors and data inputs to these processes and activities will continue to grow. Moreover, as data from these various sensors and inputs grows and accumulates, EAB headquarters staffs lack effective tools to analyze the thousands, if not millions, of collected data points. Intelligent software agents and machine learning techniques can enable staffs to process data into information thereby enabling commanders to develop and maintain situational understanding and enhance their decision making. The availability of these large data sets requires new tools; AI that can process, recognize, and sort information effectively will be required. This software must be able to assist commanders and staff make linkages from data to fuel military operations. Future software must be flexible and easy to use to augment staff elements' ability to conduct analysis. It must guide people through staff processes and highlight unseen connections or correlations across sections or echelons. This software must be able to separate relevant portions of data so that it can be assigned and reassigned easily to units based on changing mission sets.

g. AI will assist EAB headquarters to fully use accessible data. For information superiority, AI will dramatically enhance information collection and analysis. AI may make some tasks simpler, faster, and more efficient, potentially requiring fewer Soldiers for those tasks. Unstructured datasets such as imagery and free text are generally labor intensive, but are now subject to automated analysis based on machine learning. Machine-learning-based analysis will also be useful for automated target recognition and pattern analysis—the larger the data sets the better the learning and predictive analysis. Future AI will continue to introduce new capabilities from EAB all the way down to the squad level.

C-3. Networking and applications

a. In addition to logistical and administrative support, future EAB formations may be required to augment subordinate unit networking and communications capabilities. When threat forces attempt to deny, disrupt, or cut communications through a variety of means, future EAB commanders must have the capability to extend, thicken, and increase bandwidth at the times and places of their choosing—weighting the main effort or enabling the decisive action. These capabilities will be an integral component of the maneuver plan. In the previous section discussing data, that information must be sent through some means—which may not be possible using traditional organic assets. The converse may be true as well, where important information must flow downward to warn of imminent threat or to issue new orders. Therefore, these capabilities must be bi-directional, spectrum agnostic, and enable burst communications in time-sensitive situations.

b. Network technologies. The Army requires robust and reliable network capabilities to exploit actionable information generated by large data sets. The Army's future communications network for EAB formations must enable expeditionary, uninterrupted mission command. This network must be comprised of intuitive, secured, standards-based capabilities adaptable to the commander's requirements and integrated into the common operating environment. Future network capabilities are assured, interoperable, tailorable, collaborative, identity-based, and accessible at the point of need and in operations that include unified action partners. Future solutions must allow users to easily understand network status, and configure, manage, and secure the network. Future capabilities must enable quick emplacement, or replacement, with components to support the operational tempo. The future Army communications network is both mobile and protected, and able to maneuver with the forces it supports. The future network provides a platform for capabilities to support multi-domain combined arms operations, is software-defined, and can be dynamically managed to adapt to changing operational conditions. Examples of these capabilities include investments in—

(1) Robotic and autonomous systems to help establish the Army communications network during early entry operations and support mission command on-the-move during subsequent movement and maneuver. Robotic and autonomous systems are also required to reduce cognitive burden, aid in decision making, improve situational awareness, and provide persistent monitoring of the battlespace.

U.S. Army Concept for Multi-Domain Combined Arms Operations at Echelons Above Brigade

(2) Multi-layered aerial support for digital and wireless networks deployable in any part of the world quickly. These capabilities may be short duration, or temporally aligned to support a defined time or mission.

(3) Ad-hoc mesh networking capabilities able to function when nodes or relays are disrupted or destroyed.

(4) Spectrum analysis and management tools to assist commanders understand the electromagnetic environment and visualize and control how—and how well—networks support the mission.

(5) Cyberspace tools to defend friendly networks and exploit weaknesses in enemy communications networks and information systems.

(6) Automated tools to counter enemies' use of social media.

c. High performance and quantum computing. Although multi-core processing has come of age and is in consumer products, future computing technologies are orders of magnitude more powerful. These technologies are able to run the neural networks that enable deep learning to process large data sets. Additional effects of successfully implementing these technologies reduce power consumption and open novel areas for on-board processing. Meanwhile, successful use cases of quantum computing can provide computing and information processing, enabling hard computational and logic problem solving. At larger scales, this type of computational power can enable implementing large-scale model and simulation applications where commanders and staffs can model actions and decisions affecting entire regions.

d. Application technologies. EAB applications must be interoperable, simple to use, and intuitive. These applications will aid leaders to better understand, visualize, describe, direct, lead, and assess complex problems in the future OE. They will be used by Soldiers and leaders at all echelons and must be consistent with the joint information environment⁷⁴ and Army common operating environment standards and technologies. Simple to train and understand, they must allow users to define how information is displayed, processed, and distributed. They must leverage powerful analytic tools and enable leaders and staffs to quickly assess the situation to enhance effective decision making. These solutions must be intuitive, adaptable, reduce complexity, and provide leaders with a clear, understandable, and multi-domain common operational picture—a shared consciousness—at all echelons. Applications must enable leaders to exercise uninterrupted mission command, capable of functioning in a denied, intermittent, and low-bandwidth environment. They should support distributed computing, mobility, and use augmented and virtual means to accelerate knowledge generation and develop understanding.

C-4. Materials and energy

a. Successfully applying advances in new technologies in materials and energy into EAB formations will be critical in future operations. Command posts can be transformed by utilizing multi-functional materials providing not only cover and concealment, but protection, light, displays, or even cooling.⁷⁵ Multifunctional materials would reduce not only the physical and

logistical footprint, but also energy demands for information processing, communications, and climate control. It is possible EAB formations could begin to provide energy wirelessly to remote devices or subordinate units. Technologies such as these could help untether forces from current constraints and allow greater freedom of maneuver.

b. Materials. Materials science continues to evolve and produce ever more capable components with which to build Army materiel. Command posts and sensors in particular could be affected by successful implementation of new materials. Such new properties include embedded electronics, diodes, sensors, and distributed computing. It is possible essential components such as displays and camouflage will be part of the actual material of the physical CP. Therefore, it is important to take notice of the ability to combine capability developments into a single solution. That is to say, the same CP material could provide protection, camouflage, and lighting merely by adding or layering materials with various properties. The effect would be to simplify CP set-up and teardown to more easily support deployability, emplacement, and agility for high operational tempo mission sets. These may be manufactured at the point of need by EAB formations, cutting wait times and reducing transport needs. Examples of such materials capabilities can include the following.

(1) Nanotechnology. This field is generally defined as materials smaller than 100 nanometers with novel properties. Such materials could be many times stronger than current building materials and be electronically controlled to perform such actions such as conducting electricity, computing, and communications.

(2) Quantum materials. These materials also known as topological materials are made with quantum properties and are typically constructed at the atomic level. They can be combined with traditional materials such as films and add properties such as lighting, cooling, and data storage. Diamond spintronics in particular holds promise for nanomagnetic imaging, gyroscopes, and quantum information processing.⁷⁶

(3) Biomaterials. Substances that have been engineered to take a form which, alone or as part of a complex system, is used to direct, by control of interactions with components of living systems, the course of any therapeutic or diagnostic procedure. Aside from medical applications in regenerative medicine and implantable devices, these new materials may be applied to produce self-cleaning surfaces or self-repairing materials.

(4) Metallurgy. Known as the science of metallic elements and compounds, advances in these materials can be applied to new armor and protection solutions. Novel alloys will reduce cost, weight, corrosion, increase strength and load bearing capability, and if combined with other materials identified in this section, new properties. Bulk metallic glass, as an example, can be applied to robotics to operate in extreme cold environments. Through metallurgy, batteries could also be improved with advances such as the recently discovered lithium-sulfur- battery.

c. Energy. Advances in energy harvest, storage, and transmission could have transformative effects on Army forces. Commercial companies such as Tesla are working on developing energy based consumer products. As competitors continue to enter the commercial market, it is ever more likely advances in energy will come to pass. As electronics continue to pervade military operations, nearly every mission type will be affected by breakthroughs in this area.

(1) Energy harvest. Advances in energy harvesting can greatly reduce power generation needs and battery resupply. Sources can vary from solar or wind to RF, ambient energy, or even collecting energy off individuals. Investment in these technologies can power ultra-low power neural network chipsets to increase utility while, simultaneously, future electronics may reduce power consumption rates to increase implementation across a variety of applications.

(2) Energy storage. Energy storage will move beyond current battery technologies to increase the power density needed to support extended range missions or expeditionary maneuver⁷⁷. Lithium-sulphur batteries, phase change materials, covalent organic frameworks, and capacitors all show promise in increasing energy storage.

(3) Transmission and distribution. As with data transmission, energy transfer will become wireless. Current induction technologies will improve as will power-over-Wi-Fi capabilities. It is possible future devices will use main power systems wirelessly with relatively small battery back-up. The effect is to reduce on board weight and increase maneuverability for future electronics and systems. Additionally, as units have relied on higher echelons providing communications, it is also conceivable EAB formations will possess robots or power relay capabilities in lieu of bulk fuel for power generation.

(4) Energy weapons. For air defense applications, these new generation weapons will have the capacity to invert the interceptor-to-projectile ratio. Combined with other advanced energy capabilities in this section, directed energy weapons will allow EAB formations to provide greater support and enable greater periods of overmatch. Further miniaturization will give individual Soldiers weapons with electronically disruptive and destructive capabilities.

C-5. Overcoming cognitive and social demands

a. Regardless of S&T advances, humans will be the users of these future technologies. Technology must assist preparing future leaders, Soldiers, and Army Civilians for unfamiliar missions through immersive simulation environments. Technology provides realistic training for lethal engagements requiring correct individual actions and leader decision making. This technology provides challenging nonlethal, human, social, and cultural engagements requiring critical thinking and well-developed emotional intelligence. The Army must have an array of tools that assist in understanding itself, the enemy, and the environment.

b. As part of joint, interorganizational, and multinational teams, the Army must prepare to deploy and execute operations ranging from military engagement, security cooperation, deterrence, crisis response, to major operations and campaigns.⁷⁸ The nature of future operations includes missions and tasks with which units have little experience or training prior to deployment. As such, commanders and Soldiers must learn, integrate knowledge, adapt tactics, prepare plans, and tailor supporting mission command systems rapidly to the unique situations. Consequently, optimizing human performance and abilities (physical, cognitive, and social) is central to effective mission command. Optimizing human performance requires focused investment in the human dimension and advanced systems engineering to achieve integrated development of these

capabilities. S&T initiatives that support future mission command across the broad range of potential missions include the following.

(1) Trust, cohesion, and candor measures and metrics to enhance team building within and between units and mission partners. This includes training interventions to improve these attributes when shortcomings are identified.

(2) Social and cultural models and simulations that create realistic training environments for human behavior and interaction.

(3) Analysis products that focus messages directed at engendering trust and favorable perceptions and opinions within American, global, and host-nation populations.

c. S&T also makes contributions beyond the training domain. In 2025-2045, the ability to modify human performance significantly is a real possibility.⁷⁹ Examples of these technologies include the following.

(1) Pharmaceuticals. Nootropic drugs and nutraceuticals may improve mental functions such as cognition, memory, intelligence, concentration, and attention allowing Soldiers to function with little sleep, make better decisions under stressful conditions, and improve learning speed dramatically.

(2) Neural prosthetics. Wearable and implanted neuro-stimulation devices may improve brain function and allow Soldiers to interface directly with information, computers, and other machines.

(3) Computer displays embedded in contact lenses. These contact lenses may allow immersive access to data and enhanced perception, such as night vision and augmented reality.

C-6. Conclusion

a. Predicting technological developments that might impact future Army operations is difficult. The uncertainty, competitiveness, and dynamic nature of future OEs, the array of threats, the range of potential future missions and their emergent nature provide the basis for this appendix. However, the direction technology is taking us is clear: more data, democratized distribution, and greater cognitive load requiring AI, machine learning, and the skilled use of knowledge management practices to convert raw data into actionable knowledge resulting in better and faster decision making.

b. The Army's focus is on advanced technological capabilities that provide EAB commanders and staffs with the tools necessary to understand the environment in 2025-2045. The capabilities and technologies discussed are purposely broad, serve as a general guide, and allow for unforeseen technological advances or breakthroughs. Therefore, the capabilities and technologies identified are not prescriptive in nature. They fuel the dialogue between user representatives, research and development organizations, and systems developers.

c. The Army's ability to address EAB commanders' future needs is predicated on capability and system developers working together across organizational boundaries. Success will happen through the efforts of dedicated professionals more concerned with providing leaders, Soldiers, and Army Civilians with warfighting capabilities and less concerned with organizational goals.

Appendix D

Risks of Adopting this Concept

D-1. Risks from concept hierarchy

The implementation risks stated in the higher concept hierarchy—Capstone Concept for Joint Operations, ACC, and AOC—are equally applicable to this concept.⁸⁰

D-2. Risks within the EABC

The EABC has identified the following additional risks.

a. *The future Army communications network may not fully support the EABC.* The Army's future communications network may not be as robust and assured as anticipated in the timeframe of this concept to allow future EAB formations to be distributed and globally connected from home station, enroute, and disaggregated throughout their AO. Future science and technology may not support the sustained data connectivity necessary between command components and information systems particularly those of joint, interorganizational, and multinational partners. Rigorous training and experimentation with current and future information technology—against top-tier, free-thinking, and capable opposing forces—will accurately identify risks and allow for technology modifications and the development of other appropriate mitigation strategies, tactics, techniques, and procedures.

b. *Overreliance on technological capabilities.* Unless Army forces take deliberate steps to the contrary, they may become overly reliant on technological capabilities limiting their ability to operate in a dispersed, decentralized, and degraded environment. Units that become most effective at maximizing the capabilities of technological enablers can also become the most at-risk by their loss.⁸¹ In the past, operating degraded has included continuing to operate in the extreme—the complete absence of certain enablers. The increased use of and reliance on the Army's communications network and other technological enablers may create situations where organizations *perceive* that operations, in the absence of these enablers, are no longer possible. Organizations that allow the atrophy of non-network enabled skills will demand a certain minimum service or capability to remain effective. This minimum now defines what it means for those units to operate degraded. Training and routine practice on analog and manual systems and processes, shortened radio and burst data transmissions, and operating under radio-listening silence can help mitigate this risk. Units will need to routinely incorporate purposeful events to practice these techniques and develop others to ensure that, in the absence or degradation of space enablers, the Army's communications network, and other technology, they can remain combat effective and still accomplish assigned missions—albeit not as rapidly or effectively as they might if technological enablers were fully operational.⁸²

c. *Semi-fixed formations provide a false illusion of permanency.* Creating EAB formations with organic or assigned, or some combination of, functional and multifunctional enabling formations

may instill in future Army leaders and planners the illusion that the formation is permanent and cannot be broken into enablers task organized and reallocated to subordinates to weight the main effort and accomplish specific missions and tasks. This perception can create inflexible and unadaptable units, squander combat power on less decisive tasks, cede the initiative to the enemy, and, worst case, contribute to mission failure. To combat this misperception, future operational concepts and organizational designs, subsequent doctrine and training, and enabling technology must emphasize and contribute to ease of force tailoring and task organization. Capability developers must also guard against this false illusion during experimentation and simulation to avoid reaching faulty conclusions and the development of inflexible organizations.

d. *Imprudent application of the mission command philosophy.* Mission command must be accurately understood to be properly employed. Mission command cannot be reduced to simple formulas. Its fundamental principles require varying amounts of judgment in their application. For example, the amount of control, the echelon to which decision-making authority and warfighting capabilities are decentralized, and the level of prudent risk are highly dependent on the OE and situation and, as importantly, how well leaders have previously developed their subordinates and applied the other principles of mission command. Army leaders cannot directly apply this philosophy to other joint, interorganizational, and multinational partners that have not trained and prepared for its use. Many future partners may operate only under centralized control and by following detailed orders and instructions; informed initiative may not be part of their organizational culture. Army leaders must be prepared to adjust their leadership and procedures to accommodate partner capabilities and needs.⁸³ However, creating shared understanding; providing a clear intent, purpose, and priorities; promoting boldness, agility, and innovation; building a networked, cohesive team; and cultivating candor and trust are always applicable to the conduct of any operation with any group of mission partners.

Appendix E

EAB Formations

E-1. Introduction

Form follows function. That is, the organizational design of future EAB formations (their forms) should be based on how these EAB formations are expected to operate in the future (their functions) to include their headquarters roles, functions, and tasks, as well as key span of control considerations. Chapter 4 described how future EAB formations would operate or fight in an envisioned future against a potential capable near-peer threat. This appendix provides more detail for capability developers to use during subsequent analysis and assessments.

E-2. EAB roles, functions, and span of control

a. Future EAB headquarters command roles. The five roles of future EAB headquarters are: ASCC to a geographic or functional combatant command, JTF, JFLCC, intermediate tactical command, and ARFOR (see figure E-1). These roles are further described below.

(1) ASCC to a combatant command. In this role, an echelon above brigade serves as the primary interface between the combatant commander and the Department of the Army.

(a) While subordinate Army forces may be assigned or attached to the combatant command to accomplish specific missions, the ASCC to the combatant command is a persistent, dedicated Army echelon. Though not well understood, the ASCC is essential to the Army’s overall command structure and global warfighting capabilities.⁸⁴ In a geographic combatant command (GCC), the theater army is the geographic combatant commander’s senior Army headquarters enabling the employment of landpower anywhere in the AOR and across the range of military operations. This level of command has continuous administrative, theater management, and operational warfighting responsibilities. It maintains administrative control over all Army forces in the AOR and exercises OPCON of any assigned or attached Army forces until the combatant commander attaches those forces to a subordinate joint command.

(b) In the competition below armed conflict, it is the principal Army formation responsible for defeating adversary aggression in the AOR.⁸⁵ As the activities and influence of threats become transregional and aggressively threaten the U.S. homeland, the theater army coordinates and synchronizes operations with other Service component commands, functional ASCCs, and theater armies in the other GCCs to achieve its own theater objectives, contribute to other theaters’ objectives, and, together, accomplish national strategic objectives.⁸⁶

(2) JTF. With augmentation and training on joint tasks, an echelon above brigade headquarters can serve as the foundation or core of a joint task force (JTF) or multinational task force command, or both.

(3) JFLCC. With augmentation and training on joint tasks, an echelon above brigade may serve as a JFLCC with tactical control over any combination of Army, Marine Corps, and multinational land forces for the AOR as a whole or any portion therein. Depending on the situation, an Army EAB headquarters in this land-focused role may be able to simultaneously fulfill the role of an ARFOR. In some cases, forming a field army to act as JFLCC or to coordinate the operations of multiple corps will be necessary and advantageous in large-scale combat operations.

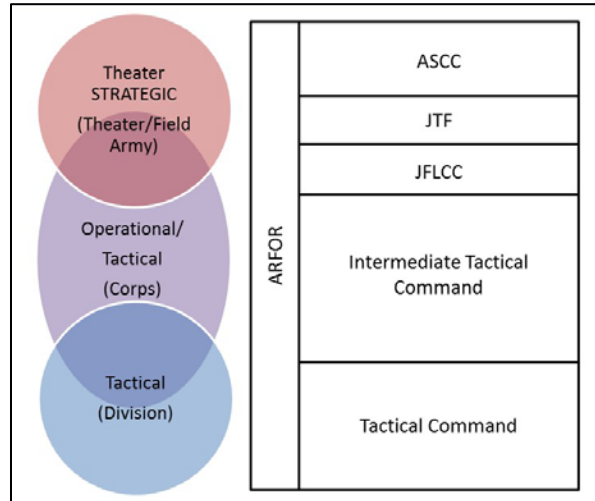

Figure E-1. Future EAB headquarters command roles

(4) Intermediate tactical command. Depending upon the size of the land force, scale and scope of operations, and the established joint command and control structure, any echelon above brigade headquarters may exercise intermediate tactical command under direction of a JTF or JFLCC commander. As the battlespace expands in large-scale combat operations, more than one command echelon may be needed to fulfill the role of increasingly higher-echelon tactical headquarters above brigade.

(5) ARFOR. Any echelon above brigade headquarters may serve as the Army component and senior Army echelon of all Army forces assigned or attached to a combatant command, subordinate joint force command, joint functional command, or multinational command. An ARFOR provides the necessary administrative and logistics support to all Army forces and retains OPCON over Army units not subordinate to another component of the joint force. An EAB headquarters required to transform to joint force command must shift its focus to joint, interorganizational, and multinational orchestration and should, normally, transfer this Army-specific role to a lower Army echelon.

b. Functions common to all EAB headquarters. The primary function of a military headquarters is to enable command. Command is the lawful exercise of authority derived from rank or assignment to direct subordinate organizations and utilize resources to accomplish tasks. Command includes the responsibility for planning the employment of, organizing, directing, coordinating, controlling, and leading people and organizations for the accomplishment of assigned missions.⁸⁷ The engine that powers every headquarters is the overall operations process: plan, prepare, execute, and assess.⁸⁸ Commanders drive the operations process through their command activities of understanding, visualizing, describing, directing, leading, and assessing. To this end, all EAB formations perform a set of general functions and supporting tasks common to multi-domain combined arms operations and any OE.⁸⁹

(1) Developing and maintaining situational understanding.

- Generating, distributing, or sharing information including reports required by higher headquarters.
- Collecting and receiving information including reports from subordinate units.
- Analyzing information and producing intelligence.
- Establishing a common operational picture across all domains, the EMS, the information environment, and warfighting functions.⁹⁰
- Operating and defending the Army's communications network.
- Information Collection

(2) Planning operations (long- and short-range).⁹¹

- Planning branches and sequels.
- Integrating intelligence into current operations and future plans.
- Planning, prioritizing, and sequencing targets and determining appropriate method(s) of engagement.
- Planning and synchronizing sustainment.
- Managing risk.

(3) Integrating and synchronizing resources and capabilities across multiple domains.

U.S. Army Concept for Multi-Domain Combined Arms Operations at Echelons Above Brigade

- Resourcing subordinates with the warfighting and information-related capabilities needed to accomplish assigned missions.
- Prioritizing support and weighting the decisive action or main effort.
- Providing appropriate decision-making authorities to allow informed initiative.
- Integrating and synchronizing information collection.
- Synchronizing the Army airspace control plan or order with the Joint Force Air Component Command.

(4) Orchestrating and controlling operations.

- Establishing command and support relationships and authorities among subordinate commanders.
- Providing timely battlefield adjustments in response to changes in environment and opportunities.
- Providing responsive airspace control and management.
- Providing clear rules of engagement.
- Orchestrating the convergence of multi-domain, EMS, and information environment capabilities to achieve physical, virtual, and cognitive windows of superiority at decisive points.⁹²

(5) Monitoring and assessing operations and effects in all domains, the EMS, the information environment, and each warfighting function, and their impact on future operations.

- Conducting running estimates.
- Conducting battle damage assessments.⁹³
- Making anticipatory and proactive recommendations to the commander.

(6) Coordinating, collaborating, and creating shared understanding with higher, lower, adjacent, supporting, and supported units, and other mission partners, and communicating with the public.

- Ensuring a thorough understanding of the commander's intent and concept of operations.
- Gaining unity of effort among mission partners not under military command.
- Informing the organization on critical issues so they may adjust plans as required.
- Avoiding conflict and duplication of effort among units and mission partners.
- Informing the public and responding to specific requests for information.

c. Span of control. When determining the number of command echelons required for a particular campaign, operation, or task, span of control is a primary consideration.

(1) For the military, span of control is the number of subordinate units that a commander can control effectively and reflects the complex human nature of war and the high risk associated with poor decisions and slow decision making. Past operations, research, and documented experiences have demonstrated there is a finite limit to military span of control. The tremendous advances in information technology, digital networks, and globally networked communications have not altered the limitations of the human brain to rapidly process information and make informed, well-reasoned decisions in a timely manner, particularly under the stress of combat and the media

spotlight. In fact, the deluge of information descending upon commanders operating on a chaotic battlefield can severely impede decision making. See figure E-2 for factors influencing an increase or decrease in span of control.

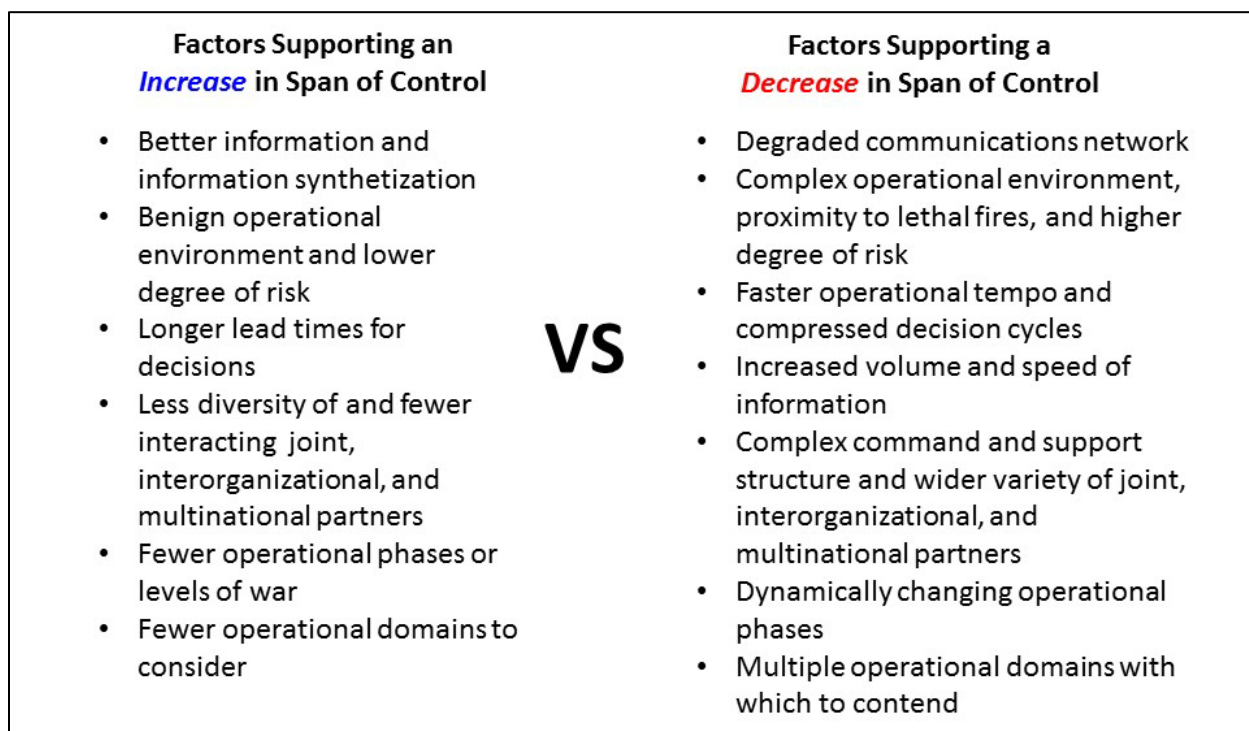

Figure E-2. Factors affecting military span of control

(2) In a complex future OE, EAB headquarters must maintain the capability to command during high-intensity, large-scale combat operations. In these operations against a highly capable near-peer threat, future EAB headquarters exercise a span of control of two to six subordinate maneuver units.⁹⁴ Too big a span of control can result in disjointed operations, slowed decision making, missed opportunities, and poor decisions with unacceptable high-risk consequences (including the moral hazards associated with pushing wartime decision making down to levels lacking the experience and judgment to make informed decisions).

E-3. The EAB warfighting formations

a. Theater army.

(1) Each theater army headquarters comprises a main command component that can manage operations and plan for contingencies, and an contingency command component that can respond to crises for a limited period.⁹⁵ Some theaters require an additional command component that provides a distinct operational capability with which to compete against near-peer adversaries in competition below armed conflict effectively and, if necessary, conduct LSGCO as a combined or JFLCC. In theaters with a near-peer adversary, this should include a standing field army or the core of a field army capable of transitioning quickly to a full field army. Like the theater army, the field army is uniquely tailored for its mission, AO, and threat, and may change over time as the situation warrants. These command components should not be considered synonymous with

command nodes. Mission analysis determines the composition and location of command nodes. The main command component can be organized as main and rear or support area command nodes, for example, with the contingency command component acting as an early-entry or forward command node with a mobile command group. Regardless of how command nodes are positioned on the future battlefield, the main and contingency command components function together as one integrated headquarters.

(2) *The theater army main command component.* In competition below armed conflict, the main command component is a traditional staff organization focused on the Title 10 theater management tasks of setting the theater for all warfighting functions, ASOS, DOD EA responsibilities, and Army support to theater security cooperation. Security cooperation, often to support interorganizational elements, is the implementation of national power to support strategic objectives using military capability and capacity for non-military tasks.⁹⁶ Security cooperation is essential to successful operations in the competition period, aids in deterrence, and sets conditions for the conduct of multinational operations at all echelons.⁹⁷ To this end, future theater armies need the requisite mission command capabilities and capacities to converge domain capabilities in the information environment, as well as integrate disparate security cooperation efforts by SOF, security force assistance formations, and conventional forces for greatest effect within their specific AOR. The theater army establishes theater-level physical, virtual, and cognitive landpower objectives during competition below armed conflict by persistently competing below armed conflict, while preparing the theater for transition to armed conflict if competition escalates.

(a) Although every theater army's main command component shares a common structure, each is tailored and scaled to their OE and threat. The main command component must be able to synchronize multi-domain assets germane to its theater. Not every theater faces a threat requiring air defense, for example. A theater with high probability or risk of this threat would need a corresponding planning and coordination capability in its staff and subordinate commands, but a theater with less of this type threat may only require the most basic level—if not omitted entirely.

(b) With the appropriate staff headquarters design, the main command component can conduct nonlethal offensive and defensive operations in specific domains during competition below armed conflict. Directed by the JFC, this operational focus in competitive domains enables the U.S. to further its interests against near-peer enemies or adversaries and non-state actors below the threshold of armed conflict and throughout its assigned AOR. Successful information environment operations, for example, can insulate a population that might otherwise sympathize or collaborate with a competitor, preventing support to the adversary's operations. An offensive cyberspace operation might degrade potential insurgents' ability to coordinate actions or mount their own information environment operations campaign.

(c) In geographic regions where the likelihood of armed conflict with threat is higher, theater armies require the ability to converge cross-domain capabilities to open sequential or simultaneous physical, virtual, and cognitive windows of superiority to generate overmatch, present multiple dilemmas to the enemy, and enable Joint Force freedom of movement and action. To set conditions should escalation occur, the theater army must also have the ability to conduct the deliberate and contingency planning required of a JFLCC across all warfighting functions until another

subordinate unit is designated or available. Early Army contribution to these plans have lasting effects for the duration of a campaign.

(3) *The theater army contingency command component.* Each theater army requires the capability to respond to crises or contingencies.⁹⁸ This is accomplished through its contingency command component. This command component is designed for rapid crisis response, primarily to fill the small deployment gap (up to 90 days) between event and deployment of a corps' contingency command component. Like the main command component, each theater army's contingency command component should be tailored and scaled to its environment based on its set of contingency plans and unique OE within its geographic AOR. A theater with higher probability or risk of combat operations might have its contingency command component tailored toward warfighting functions and able to operate as a forward command node for a limited time, whereas a theater with a higher probability for humanitarian assistance and disaster relief would have a limited operations, but large logistics planning and coordination capacity. The contingency command component may constitute the foundation for a small JTF during small-scale or short-duration contingencies.

b. Field army. Primarily, a field army is employed to relieve operational burden from the theater army, where attention to a specific scenario in a subordinate geographic area would detract from the theater army's ability to support strategic objectives in the theater as a whole. The field army is forward stationed to account for higher probability or risk of LSGCO, or other vital geopolitical considerations requiring partner assurance.⁹⁹ It is required in areas of persistent, intense competition with a near-peer threat with a high likelihood of combat. The field army can serve as the foundation for a JTF or JFLCC, or merge into standing—but under-resourced—alliance headquarters. Accordingly, it must be organized and resourced with or have access to the functional expertise necessary to plan, coordinate, and synchronize service capabilities within each domain. If the field army must be established as an enduring formation within the theater, it also requires the ability to conduct deliberate and contingency planning. While the field army may not have the authorities to execute specific joint or interagency tasks, it must have the ability to integrate and synchronize these operations.¹⁰⁰ The field army remains threat focused and contributes to security cooperation and operation plan development within its assigned AO. The theater army, on the other hand, retains its never-ending theater management tasks and security cooperation responsibilities throughout the remainder of the AOR.

c. Corps.

(1) The current corps headquarters is optimized to exercise mission command during limited contingency operations. This design-focus limits its flexibility and slows its transition to other missions across the range of military operations. Current doctrine specifies that it also serve as the foundation for a JTF or JFLCC during limited contingency operations. In practice, however, this is a significant shift not easily accomplished.¹⁰¹ To mitigate this problem, the future corps headquarters is of universal design that is capable of exercising mission command at all echelons for a variety of scenarios but weighted toward LSGCO. The future corps headquarters becomes the Army's most adaptable operational headquarters that, while retaining its ability to perform its traditional role of commanding multiple divisions in LSGCO, is also more capable of executing

the diverse missions that span the competition continuum as either a JTF or JFLCC during operations in the mid- to lower-tier level of conflict.¹⁰²

(2) *The corps main command component.* The corps main command component provides the corps' capability to execute its traditional role. When the expeditionary command component is deployed for an extended period, the main command component is the source for rotational personnel. The corps main command component in its traditional role not only commands multiple divisions, separate brigades, and functional and multifunctional enablers, it performs tasks critical to conducting deep cross-domain maneuver; enabling and shaping its subordinate divisions' fights, and creating tactical and operational endurance to maintain cross-domain positions of advantage.. Key tasks of the corps main command component are:

- Shaping the tactical fight, synchronizing the operational and tactical echelons.
- Converging cross-domain lethal and nonlethal capabilities to produce desired effects within the corps battlespace to open windows of superiority for tactical exploitation.
- Planning and synchronizing the deep fight physically, temporally, virtually, and cognitively.
- Providing and synchronizing support to the divisions from functional or domain enablers.
- Consolidating gains for lasting success.
- Coordinating security, freedom of movement, and protection in the operational support area and corps consolidation area.

(3) *The corps expeditionary command component.* The corps expeditionary command component is the cornerstone of versatility for the corps echelon. It is a cross-section of the functional staff, identical in capability to the main command component although limited in size and capacity. It is globally deployable on short notice. It is formally trained on both joint and Army doctrine, better enabling transition to a JTF or JFLCC, if required. Some of the mission-dependent ways it can be employed are:

- A stand-alone interim headquarters for limited contingencies, providing relief to a theater army's contingency command component or eliminating the need for its deployment.
- An augmentation to the theater army's main or contingency command component, increasing the capability and capacity of either element for employment of capabilities normally associated with the corps echelon.
- An augmentation of a division headquarters, enabling direct employment of capabilities normally associated with corps or above echelons, or enabling a transition to a JTF, or both.
- The early-entry capability of the corps proper.
- A forward or alternate command node for the corps in LSGCO.

d. Division.

(1) The division conducts simultaneous offensive, defensive, and stability tasks throughout any campaign. The weight of effort allotted to each task varies throughout the competition continuum. The division's primary means of conducting decisive action are its BCTs operating in assigned AO, supported by various brigades. Subordinate brigades perform all three tasks,

although one task normally requires the preponderance of their combat power. When deployed as part of a major operation or campaign, the division may command Marine Corps and multinational ground forces. When required, the division supports domestic authorities (using DSCA) in response to domestic disasters and during special events requiring large-scale military support.

(2) The division conducts offensive tasks to defeat, destroy, or neutralize an enemy. The preferred method of conducting offensive tasks is to find and disrupt the enemy from positions of advantage to set the conditions necessary for the division's decisive maneuver. The division commander must leverage every available technological advantage to gain intelligence and to employ lethal fires, offensive cyberspace operations, and electronic attack as a precursor to a decisive operation. It can then maneuver its BCTs and apply its fires for the final, decisive blow. Division commanders seek to achieve decisive results by massing overwhelming combat power at the point of attack while avoiding the enemy's main strength. They employ their subordinate BCTs to disrupt the cohesiveness of enemy defenses and force the enemy off plan. Division commanders use the four primary offensive tasks.

E-3. Conclusion

Future EAB formations are organized and designed as complementary formations designed to conduct multi-domain combined arms operations across the competition continuum. Together, EAB formations enable Army forces to quickly respond to crisis, compete below the threshold of conflict, defeat aggression, and prevail in LSGCO against capable near-peer threats. This concept begins the institutional dialogue necessary to recast EAB headquarters into robust combined arms fighting formations with resident capabilities and capacities optimized for large-scale combat operations while retaining the flexibility needed to conduct counterterrorism, counterinsurgency, humanitarian assistance, disaster response, and other long- and short-duration stability operations.

Glossary

The glossary contains acronyms and terms with Army or joint definitions. Those acronyms and definitions marked by an asterisk (*) and located in section II indicate a new acronym or term, or one modified from what is contained in current doctrine, regulations, or hierarchical concepts.

Section I: Abbreviations

A2/AD	anti-access and area denial
ABCT	armored brigade combat team
ACC	Army Capstone Concept
AI	artificial intelligence
AO	area of operations
AOC	Army Operating Concept
AOR	area of responsibility
ARCIC	Army Capabilities Integration Center
ASCC	Army Service component command
ASOS	Army support to other Services
ATP	Army techniques publication
ATTP	Army Tactics, Techniques, and Procedures
BCT	brigade combat team
C2	command and control
C3D2	camouflage, concealment, cover, deception, and decoys
CAC	United States Army Combined Arms Center
CBRN	chemical, biological, radiological, and nuclear
CCJO	Capstone Concept for Joint Operations
CFT	cross-functional team
CONUS	continental United States
CP	command post
CRBM	close-range ballistic missile
CSA	Chief of Staff of the Army
DA	Department of the Army
DOD	Department of Defense
DODD	Department of Defense Directive
DODI	Department of Defense Instruction
DOS	Department of State
DOTMLPF-P	doctrine, organization, training, materiel, leadership and education, personnel, facilities, and policy
EAB	echelons above brigade
EABC	Echelons Above Brigade Concept
EMS	electromagnetic spectrum
EW	electronic warfare
F/RW	fixed/rotary wing
FM	field manual
G-2	assistant chief of staff, intelligence
GCC	*geographic combatant command

U.S. Army Concept for Multi-Domain Combined Arms Operations at Echelons Above Brigade

HIMAD	high to medium altitude air defense
IADS	integrated air defense system
IBCT	infantry brigade combat team
IFC	integrated fires complex
JFLCC	*joint force land component command
JP	joint publication
JTF	joint task force
LSGCO	large-scale ground combat operation
MDO	Multi-Domain Operations
MEAD	medium altitude air defense
MP	military police
MRL	multiple rocket launchers
NATO	North Atlantic Treaty Organization
OE	operational environment
OPCON	operational control
OPLAN	operation plan
PNT	positioning, navigation, and timing
RC	required capability
SBCT	Stryker brigade combat team
SOF	special operations forces
SRBM	short-range ballistic missile
S&T	science and technology
TACON	tactical control
TRADOC	United States Army Training and Doctrine Command
U.S.	United States

Section II: Terms

abductive reasoning

Usually starts with an incomplete set of observations and proceeds to the likeliest possible explanation for the group of observations.

administrative control

Direction or exercise of authority over subordinate or other organizations in respect to administration and support. (JP 1)

agility

Flexibility of mind and an ability to anticipate and adapt to uncertain or changing situations. (TRADOC Pam 525-3-3)

anti-access

Actions and capabilities, usually long-range, designed to prevent an opposing force from entering an operational area. (Joint Operational Access Concept)

area denial

Actions and capabilities, usually of shorter range, designed to limit an opposing force's freedom of action within an operational area. (Joint Operational Access Concept)

area of operations

Operational area defined by the joint force commander for land and maritime forces that should be large enough to accomplish their missions and protect their forces. (JP 3-0)

area of responsibility

Geographical area associated with a combatant command within which a geographic combatant commander has authority to plan and conduct operations. (JP 1)

Army communications network

Army's portion of the DOD information network; encompasses all Army information management systems and information systems that collect, process, store, display, disseminate, and protect information worldwide. (Modified from TRADOC Pam 525-3-3)

Army Service component command

Command responsible for recommendations to the joint force commander on the allocation and employment of Army forces within a combatant command. (JP 3-31)

assign

Place units or personnel in an organization where such placement is relatively permanent, and/or where such organization controls and administers the units or personnel for the primary function, or greater portion of the function, of the unit or personnel. (JP 3-0)

attach

Placement of units or personnel in an organization where such placement is relatively temporary. (JP 3-0)

authority

Delegated power to judge, act, or command. (ADP 6-0)

campaign

Series of related major operations aimed at accomplishing strategic or operational objectives within a given time and space. (JP 5-0)

capability

Ability to achieve a desired effect under specified standards and conditions through a combination of means and ways across DOTMLPF to perform a set of tasks to execute a specified course of action. (DODD 7045.20)

capacity

Capability with sufficient scale to accomplish the mission; actual or potential ability to perform. (TRADOC Pam 525-3-1)

center of gravity

The source of power that provides moral or physical strength, freedom of action, or the will to act. (JP 5-0)

close area

Area where friendly and enemy formations, forces, and systems are in imminent physical contact and contest for control of physical space in support of campaign objectives. (Multi-Domain Operations Concept)

close combat

Warfare carried out on land in a direct-fire fight, supported by direct and indirect fires and other assets. (ADRP 3-0)

cognitive dimension

Dimension of the information environment within the minds of those who are affected by and act upon information. These minds range from friendly commanders and leaders to foreign audiences affecting or being affected by operations, and to enemy or adversarial decision makers. This dimension focuses on the societal, cultural, religious, and historical contexts that influence the perceptions of those producing the information and of the targets and audiences receiving the information. In this dimension, decision makers and target audiences are most prone to influence and perception management. (Adapted from description in FM 3-0)

combatant command

Unified or specified command with a broad continuing mission under a single commander established and so designated by the President, through the Secretary of Defense and with the advice and assistance of the Chairman of the Joint Chiefs of Staff. (JP 1)

combat power

Total means of destructive, constructive, and information capabilities that a military unit or formation can apply at a given time. (ADRP 3-0)

combined arms

Synchronized and simultaneous application of all elements of combat power that together achieve an effect greater than if each element was used separately or sequentially. (ADRP 3-0)

command

To lawfully exercise authority derived from rank or assignment, direct subordinate efforts, and utilize resources to accomplish tasks. Command includes the responsibility for planning the employment of, organizing, directing, coordinating, controlling, and leading people for the accomplishment of assigned missions. It includes responsibility for their health, welfare, morale, and discipline. (TRADOC Pam 525-3-3)

common operating environment

Approved set of computing technologies and standards that enable secure and interoperable applications to be developed rapidly and executed across a variety of computing environments. (U.S. Army CIO/G-6 Annex B to LandWarNet 2020 and Beyond Enterprise Architecture Version 2.0: Definitions and Guidance for the Common Operating Environment)

common operational picture

Single display of relevant information within a commander's area of interest tailored to the user's requirements and based on common data and information shared by more than one command. (ADRP 6-0)

competition

Exists when two or more actors in the international system have incompatible interests but neither seeks to escalate to open conflict. While violence is not the adversary's primary instrument in competition, challenges may include a range of violent instruments including conventional forces with uncertain attribution to the state sponsor. (Joint Concept for Integrated Campaigning)

consolidate gains

Activities to make enduring any temporary operational success and set the conditions for a stable environment allowing for a transition of control to legitimate authorities. (ADRP 3-0)

consolidation

Organizing and strengthening in a newly captured position so that it can be used against the enemy. (FM 3-90.1)

consolidation area

Portion of the commander's area of operations that is designated to facilitate the security and stability tasks necessary for freedom of action in the close area and to support the continuous consolidation of gains. (ADRP 3-0)

convergence

rapid and continuous integration of capabilities in all domains that optimizes effects to overmatch the enemy through cross-domain synergy and multiple forms of attack all enabled by mission command and disciplined initiative. (Multi-Domain Operations Concept)

cross-domain

Having an effect from one domain into another. (Multi-Domain Operations Concept)

cross-domain maneuver

The employment of mutually supporting lethal and nonlethal capabilities of multiple domains to create conditions designed to generate overmatch, present multiple dilemmas to the enemy, and enable joint force freedom of movement and action. (TRADOC Pam 525-3-6)

decentralized

Delegation of authority, information, warfighting capabilities, and other resources to subordinates at the lowest practical level which enables aggressive, independent, and informed initiative to develop the situation; seize, retain, and exploit the initiative; and cope with uncertainty to accomplish the mission within the Army Ethic and the commander's intent. (TRADOC Pam 525-3-3)

decisive point

A geographic place, specific key event, critical factor, or function that, when acted upon, allows commanders to gain a marked advantage over an adversary or contribute materially to achieving the operation's purpose. (JP 5-0)

decisive space

Conceptual geographic and temporal location where the full optimization of the employment of cross-domain capabilities generates a marked advantage over an enemy and greatly influences the outcome of an operation. (Multi-Domain Operations Concept)

deductive reasoning

The process of reasoning from one or more statements (premises) to reach a logically certain conclusion.

deep fires areas

Areas beyond the feasible range of movement for conventional forces, but where joint fires, SOF, information, and virtual capabilities can be employed. (Multi-Domain Operations Concept)

deep maneuver area

Area where maneuver forces can go (beyond the close area) but is so contested that maneuver still requires significant allocation and convergence of multi-domain capabilities. (Multi-Domain Operations Concept)

depth

The extension of operations in time, space, or purpose, to achieve definitive results. (ADRP 3-0)

denied spaces

Areas where the adversary can severely constrain U.S. and allied forces' freedom of action through A2/AD and other measures. (Multi-Domain Operations Concept)

destroy

Tactical mission task that physically renders an enemy force combat-ineffective until it is reconstituted. Alternatively, to destroy a combat system is to damage it so badly that it cannot perform any function or be restored to a usable condition without being entirely rebuilt. (FM 3-90-1)

dis-integrate

Break the coherence of the enemy's system by destroying or disrupting its subcomponents (such as command and control means, intelligence collection, critical nodes, etc.) degrading its ability to conduct operations while leading to a rapid collapse of the enemy's capabilities or will to fight. (Multi-Domain Operations Concept)

dislocate

Employ forces to obtain significant positional advantage, rendering the enemy's dispositions less valuable, perhaps even irrelevant (ADRP 3-0)

direct support

Support relationship requiring a force to support another specific force and authorizing it to answer directly to the supported force's request for assistance. (FM 3-0)

dispersion

Deliberate or accidental reaction to enemy or adversary capabilities to spread out or break up forces, reduce the targetable mass of friendly forces, more effectively cover terrain in an area of operations, and gain operational and tactical flexibility. (TRADOC Pam 525-3-1)

domain

Area of activity within the operational environment (land, air, maritime, space, and cyberspace) in which operations are organized and conducted. (TRADOC Pam 525-3-1)

enemy

Party identified as hostile, against which the use of force is authorized. (ADRP 3-0)

executive agent

DOD component which has been designated by the President, DOD, or Congress as the sole agency to perform a function or service for others. (DA Memo 10-1)

expeditionary

Ability to deploy task-organized forces on short notice to austere locations, capable of conducting operations immediately upon arrival. (TRADOC Pam 525-3-1)

exploitation

Taking full advantage of success in military operations, following up initial gains, and making permanent the temporary effects already created. (JP 2-01.3)

force tailoring

Process of determining the right mix of forces and the sequence of their deployment in support of a joint force commander. (ADRP 3-0)

function

(Army) A practical grouping of tasks and systems (people, organizations, information, and processes) united by a common purpose. (ADP 1-01)

hybrid threat

Diverse and dynamic combination of regular forces, irregular forces, terrorist forces, or criminal elements unified to achieve mutually benefitting threat effects. (ADRP 3-0)

inductive reasoning

Is the process in which the premises are viewed as supplying some evidence for the truth of the conclusion.

information environment

Aggregate of individuals, organizations, and systems that collect, process, disseminate, or act on information. (JP 3-13)

information environment operations

Integrated employment of information-related capabilities in concert with other lines of operation to influence, deceive, disrupt, corrupt, or usurp the decision making of enemies and adversaries while protecting our own; to influence enemy formations and populations to reduce their will to fight; and influence friendly and neutral populations to enable friendly operations. (Multi-Domain Operations Concept)

information-related capabilities

Capabilities, techniques, or activities that create or employ information to shape the information environment toward a desired outcome. (TRADOC Pam 525-3-3)

integration

Arrangement of military forces and their actions to create a force that operates by engaging as a whole. (JP 1)

interoperability

Ability of two or more organizations to operate together effectively and efficiently as an integrated team to accomplish a common goal. Interoperability includes human, procedural, and technical considerations. (TRADOC Pam 525-3-3)

interorganizational

Elements of U.S. government agencies; state, territorial, local, and tribal agencies; foreign government agencies; intergovernmental, nongovernmental, and commercial organizations. (Does not include forces.) (TRADOC Pam 525-3-1)

isolate

Tactical mission task that requires a unit to seal off—both physically and psychologically—an enemy from sources of support, deny the enemy freedom of movement, and prevent the isolated enemy force from having contact with other enemy forces. (FM 3-90-1)

land domain

Earth's physical surface located above the high water mark and inclusive of the physical, cultural, social, political, and psychological aspects of human populations that reside upon it. (TRADOC Pam 525-3-1)

landpower

Ability—by threat, force, or occupation—to gain, sustain, and exploit control over land, resources, and people. (ADRP 3-0)

main effort

Designated subordinate unit whose mission at a given point in time is most critical to overall mission success. (ADRP 3-0)

maneuver

Employment of forces in the operational area through movement in combination with fires to achieve a position of advantage in respect to the enemy. (JP 3-0)

mission command

Overarching leadership philosophy and an integrative command warfighting function. (TRADOC Pam 525-3-3)

mission command philosophy

Leaders convey a clear intent and empower subordinates to take informed initiative. (TRADOC Pam 525-3-3)

multi-domain

Dealing with more than one domain at the same time. (Multi-Domain Operations Concept)

multi-domain operations

Operations conducted across multiple domains and contested spaces to overcome an adversary's (or enemy's) strengths by presenting them with several operational and/or tactical dilemmas through the combined application of calibrated force posture; employment of multi-domain formations; and convergence of capabilities across domains, environments, and functions in time and spaces to achieve operational and tactical objectives. (Multi-Domain Operations Concept)

mutual support

That support which units render each other against an enemy, because of their assigned tasks, their position relative to each other and to the enemy, and their inherent capabilities. (JP 3-31)

near-peer adversaries

Nation states with the intent, capabilities, and capacity to contest U.S. interests globally in most or all domains and environments. (Multi-Domain Operations Concept)

operational control

Authority to perform those functions of command over subordinate forces involving organizing and employing commands and forces, assigning tasks, designating objectives, and giving authoritative direction necessary to accomplish the mission. (JP 1)

operational environment

Composite of conditions, circumstances, and influences that affect the employment of capabilities and bear on the decision of the commander. (JP 3-0)

operational preparation of the environment

Conduct of activities in likely or potential areas of operations to prepare and shape the operational environment. (JP 3-05)

operational support area

Area of responsibility from which most of the air and maritime capabilities derive their source of power, control, and sustainment, as well as where ground forces enter theater, organize, and prepare for rapid onward movement and integration. (Multi-Domain Operations Concept)

organic

Assigned to and forming an essential part of a military organization as listed in its table of organization for the Army, Air Force, and Marine Corps, and are assigned to the operating forces for the Navy. (JP 1)

overmatch

Application of capabilities or unique tactics either directly or indirectly, with the intent to prevent or mitigate opposing forces from using their current or projected equipment or tactics. (TRADOC Pam 525-3-1)

position of relative advantage

Location or the establishment of a favorable condition within the area of operations that provides the commander with temporary freedom of action to enhance combat power over an enemy or influence the enemy to accept risk and move to a position of disadvantage. (ADRP 3-0)

recursive reasoning

Is used to define the elements in a set in terms of other elements in the set.

regionally aligned forces

Army units assigned to combatant commands, allocated to a combatant command, and those capabilities service retained, combatant command aligned, and prepared by the Army for combatant command missions. (TRADOC Pam 525-3-1)

security cooperation

All DOD interactions with foreign security establishments to build security relationships that promote specific United States security interests, develop allied and partner nation military and security capabilities for self-defense and multinational operations, and provide United States forces with peacetime and contingency access to allied and partner nations. (JP 3-20)

security force assistance

DOD activities that contribute to unified action by the United States Government to support the development of the capacity and capability of foreign security forces and their supporting institutions. (JP 3-22)

semi-independent maneuver

Operating dispersed for extended periods without continuous [or contiguous] support from higher echelons with the ability to concentrate combat power rapidly at decisive points, and in spaces (domains) to achieve operational objectives within the intent of the theater campaign. (Multi-Domain Operations Concept)

shape the security environment

Combinations of activities that reassure partners, curtail aggression, and influence local perceptions, while establishing conditions that support the employment of Army forces. (TRADOC Pam 525-3-1)

strategic support area

Area of cross-combatant command coordination, strategic sea and air lines of communications, and the homeland. (Multi-Domain Operations Concept)

survivability

Quality or capability of military forces which permits them to avoid or withstand hostile actions or environmental conditions while retaining the ability to fulfill primary mission. (ATP 3-37.34)

synchronization

Arrangement of military actions in time, space, and purpose to produce maximum relative combat power at a decisive place and time. (JP 2-0)

system

System is a group of interacting, interrelated, and interdependent components or subsystems that form a complex and unified whole. Systems have a purpose with their parts arranged in a way (structure) to carry out their purpose. (TRADOC Pam 525-3-3)

tactical control

Authority over forces that is limited to detailed direction and control of movements or maneuvers within the operational area necessary to accomplish missions or tasks assigned. (JP 1)

tactical support area

Area that directly enables decisive tactical operations in the close area and extension of capabilities into the deep maneuver and deep fires areas. (Multi-Domain Operations Concept)

task organization

Temporary grouping of joint, interorganizational, and multinational partners designed to accomplish a particular mission or pursue a mutual line of effort. (TRADOC Pam 525-3-3)

task organizing

Act of designing a force, support staff, or sustainment package of specific size and composition to meet a unique task or mission. (ADRP 3-0)

threat

Any combination of actors, entities, or forces that have the capability and intent to harm United States forces, United States national interests, or the homeland. (ADRP 3-0)

unified action

Synchronization, coordination, and/or integration of the activities of governmental and nongovernmental entities with military operations to achieve unity of effort (JP 1)

unified command plan

The document, approved by the President, that sets forth basic guidance to all unified combatant commanders; establishes their missions, responsibilities, and force structure; delineates the general geographical area of responsibility for geographic combatant commanders; and specifies functional responsibilities for functional combatant commanders. (JP 1)

warfighting function

A system (people, processes, and tools), other enabling capabilities, and group of tasks united by a common purpose that leaders use to accomplish missions and train objectives. (TRADOC Pam 525-3-3)

windows of superiority

Converging capabilities in time and space in selected domains and environments to enable commanders to gain localized control or physical, virtual, and/or cognitive influence over a specified area to prevent its use by an enemy or to create conditions necessary for successful friendly operations. (Multi-Domain Operations Concept)

Section III

Special terms

***ARFOR**

Army component and senior Army command of all Army forces assigned or attached to a combatant command, subordinate joint force command, joint functional command, or multinational command. (Modified from FM 3-94 definition)

***deter**

Discouraging an action or event through instilling doubt or fear of the consequences.

***force posture**

Encompasses forward positioned forces; rapidly deployable formations and transport means; and integration of joint, interorganizational and multinational partner capabilities, as well as, the cross-section of relationships, activities, facilities, legal arrangements, and sustainment necessary for proper employment.

***grade plate**

The rank structure for an organization's command, leadership, and staff positions designed to ensure that a specific unit or organization, and the Army as a whole, has the leadership education

and experience and the right combination of strategic, operational, tactical, and technical skills necessary to accomplish the missions and tasks for which the unit or organization is designed.

***information warfare**

Threat employment of information-related capabilities in a deliberate disinformation campaign supported by actions of the intelligence organizations designed to confuse friendly states and forces and achieve strategic objectives at minimal cost.

***mesh**

To connect devices directly, dynamically, and non-hierarchically to as many other devices as possible allowing them to relay critical data without interruption and cooperate, self-organize, and self-configure to accomplish tasks collectively despite individual device degradation or destruction.

***orchestrate**

Arrangement and integration of multi-domain capabilities and activities in concert with one another, varying in scope and scale across time and space, to achieve the optimal effect across all domains that result in the creation and exploitation of windows of superiority during multi-domain operations.

***range of military operations**

Activities, tasks, missions, and operations along the competition continuum from peace to war that vary in purpose, scale, risk, and combat intensity and which can be grouped into military engagement, security cooperation, and deterrence; crisis response and limited contingency operations; and large-scale combat operations. (Adapted from FM 3-0 description)

***scale**

To increase or decrease the capacity of specific capabilities

***span of control**

Number of subordinate units that a commander can control effectively.

***tailored**

To be provided the warfighting capabilities required for the situation and mission.

***versatile**

Ability to be tailored and scaled as required across the range of military operations and the competition continuum

U.S. Army Concept for Multi-Domain Combined Arms Operations at Echelons Above Brigade

¹ This analysis is not conducted to limit thinking. It is necessary to conduct a grounded projection into the future. The Army must learn from its successes and failures, reexamine past assumptions for their current validity, and reevaluate previous decisions to determine if they are still appropriate for the future. “To be sure, there is danger in steering a car using only the rear-view mirror, but there is a greater risk in pressing ahead without a look at where we are driving from.” Scales, R. (2018, April 9). Forecasting the future of warfare. *War on the Rocks*.

² Future conditions also include new technology.

³ “Another lesson gathered is that of fast power. This entails placing the enemy on the horns of multiple dilemmas near simultaneously and being able to sustain this multiprong pressure over time and expansive distances. Momentum was key and will be essential in MDB.” DA, Office of the Army Deputy Chief of Staff, G-4, Logistics Initiative Group. (2018, January-February). Looking back for the way ahead: An interview with retired Gen. Lloyd Austin. *Army Sustainment*, p. 38.

⁴ “The intellectual foundation for building tomorrow’s military force rests on the unfounded assumption that technologies emerging from the ‘information revolution’ will lift the fog of war and permit U.S. forces to achieve a very high degree of certainty in future military operations....The first step is to abandon explicitly the assumptions that future war will lie mainly in the realm of certainty and that American forces will be able to achieve and maintain information dominance during combat operations.” McMaster, H. (2003, April 7). *Crack in the Foundation: Defense Transformation and Underlying Assumption of Dominant Knowledge in Future War*. U.S. Army War College Strategy Research Project. Carlisle Barracks, PA, pp 1-2. “Fog of war” is a term used to describe ambiguity experienced by participants in military operations. It is ascribed to the Prussian military theorist Carl von Clausewitz, who wrote: “The great uncertainty of all data in war is a peculiar difficulty, because all action must, to a certain extent, be planned in a mere twilight, which in addition not infrequently—like the effect of fog or moonshine—gives to things exaggerated dimensions and unnatural appearance.” von Clausewitz, C. (1975). *On War*. (Ed. and trans. Michael Howard and Peter Paret). NJ: Princeton University Press. Book 2, Chapter 2, para 24.

⁵ “The Army has explicitly pursued the issue of future roles and responsibilities for Echelons above Brigade (EAB) since 2000. Earlier Unified Quest wargames (mid-2000’s) demonstrated that it was possible to conduct operations with only two EAB echelons (ASCC & Division) but subsequent wargames of increased complexity reiterated that at times at least three echelons may be required.” Brewer, V. (2017, February 6). Joint and Army Experimentation Division, U.S. Army Capabilities Integration Center. *Roles and Responsibilities Above Brigade in the Future Force: A White Paper*. Fort Eustis, VA, p. 1.

⁶ See ACC, p. 5; AOC, p. 8; and MDO, pp. A-1. For emphasis and because of their specific applicability to this concept, some assumptions may be repeated in this concept.

⁷ “The proliferation of precision-guided weapons, integrated air defenses, cyberspace weapons, counter-space weapons, and other technologies allows an increasing number of potential adversaries to contest and hold at risk, U.S. forces in all domains at the tactical, operational, and strategic levels.” MDO p. A-1 “But as our relative strengths, especially in technology, are challenged by near-peer adversaries, domains become contested and communications are no longer assured.” Brown, R. & Perkins, D. (2017, August 18). Multi-domain battle: Tonight, tomorrow, and the future fight. *War on the Rocks*.

⁸ “If we are wise, let us prepare for the worst.” General George Washington as quoted in Macgregor, D. (2017, July 16). Why America’s Army is falling apart. *The National Interest*.

⁹ This assumption is modified from one contained in the AOC, p. 8. It is changed to account for the likelihood described the initial Multi-Domain White Paper that Army forces will likely reposition forces forward as a deterrence and, should deterrence fail, to be better postured for potential conflict.

¹⁰ The AOC defines expeditionary as “the ability to deploy task-organized forces on short notice to austere locations, capable of conducting operations immediately upon arrival.” AOC, p. 46. “Transport is a critical issue today. The global presence of the U.S. military greatly expanded through the end of the Cold War and now has declined with fewer forward-deployed forces worldwide. A lack of sufficient airlift and sealift in the current force could lengthen future conflicts and potentially increase U.S. casualties.” Ham, C. (2017, October 4). The great war echoes today: Army faces similar challenges a century later. *Army Magazine*.

¹¹ “The history of failure in war can almost be summed up in two words; too late. Too late in comprehending the deadly purpose of an enemy. Too late in realizing the mortal danger. Too late in preparedness. Too late in uniting all possible forces for resistance. And too late in standing with one’s friends.” General of the Army Douglas MacArthur

¹² The key to elevated performance is unit cohesion and teamwork. Combined arms teams must stay together for long periods of time to achieve the teamwork, confidence, trust, and reliability necessary for elevated performance. The BCT remains the most appropriate echelon to develop this cohesion and teamwork while simultaneously allowing the Army to maintain strategically deployable formations for rapid employment.

¹³ “However, the technologies we develop and field at great cost will likely have a brief moment of supremacy before our adversaries develop counter-measures, and we begin to realize the need for Fourth, Fifth, and Sixth Offset Strategies. Much as generals a century ago came to realize the new reality of warfighting in the air domain, generals today are now embracing the inevitability of competition in two more domains, space and cyberspace, as well as higher stake gambits in the air, on sea and land, due to revolutionary weapons advancements. Realistically, it is only a matter of time before ingenious counter-measures makes even our most advanced technologies an anachronism.” Lorenzen, T. (2017, May 9). The edge of chaos: Emergent factors in the information environment. *The Strategy Bridge*.

¹⁴ Army forces should not underestimate the threat. However, threats are not superhuman. The U.S. Army can develop DOTMLPF-P capabilities to defeat threats and win. The greatest of these Army capabilities remains bold, agile, and innovative leaders of character.

¹⁵ This concept is part of the Army Family of Concepts. However, joint concepts such as the *Joint Concept for Integrated Campaigning* and the *Joint Operational Access Concept* also inform this concept.

¹⁶ TRADOC Pamphlet 525-3-1, *The U.S. Army Operating Concept: Win in a Complex World*, hereafter referred to as the AOC, defines interorganizational as “elements of U.S. government agencies; state, territorial, local, and tribal agencies; foreign government agencies; intergovernmental, nongovernmental, and commercial organizations. (Does not include forces.)” AOC, p. 46.

¹⁷ “Cooperation includes mutually beneficial relationships between strategic actors with similar or compatible interests. Although interests will only rarely be in complete alignment, relations that are fundamentally cooperative are strategically important for the United States because they underpin the international order, enhance collective security, help to ensure access, enable burden-sharing, and deter conflict.” *Joint Concept for Integrated Campaigning*, p. 8.

¹⁸ Super-empowered individuals and small groups are “wild cards” that may be leveraged by a near-peer adversary, act independently on behalf of a near-peer adversary, or work to their own separate goals.

¹⁹ “The compression of events in time requires forces capable of responding rapidly in sufficient scale to seize the initiative, control the narrative, and consolidate order.” AOC, p. 11.

²⁰ “Across these battlefields, rival powers made investments and developed doctrine, providing ample evidence that future wars promise extreme lethality not seen since World War II.” Brown, R. & Perkins, D. (2017, August 18). Multi-domain battle: Tonight, tomorrow, and the future fight. *War on the Rocks*.

²¹ “We ignore the ethical implications of [human enhancement (HE)] technology use for soldier resilience at our own peril. Without proper *a priori* ethical considerations, the adoption of HE technologies could stall at the regulatory policy development stage, hindering the deployment of HE solutions for more resilient soldiers. Perhaps even more grave, if ethics is not considered prior to the adoption of HE technologies, unanticipated and potentially catastrophic unethical situations on the battlefield could ensue. Neither of these outcomes is desirable for military dominance in the [future operational environment].” Thorpe, J., Girling, K., & Auger, A. (2017, July 13). Maintaining military dominance in the future operating environment: A case for emerging human enhancement technologies that contribute to soldier resilience. *Small Wars Journal*.

²² “Adversaries will challenge U.S. interests by means and with ways below the threshold of armed conflict and short of what the U.S. considers war.” MDO, p. A-1.

²³ “Army forces must be prepared to defeat future threats including those that continuously adapt to avoid U.S. strengths and attack what they perceive as weaknesses.” ACC, pp. 9-10. See the AOC’s discussion of “harbingers of future conflict” for its description of enemies and adversaries. AOC, pp. 12-14. Importantly, enemies and adversaries will use urban areas for camouflage, concealment, and protection from advanced U.S. technology. They will routinely position command posts and other military targets in dense urban environments and deliberately endanger civilians to create international sympathy and support.

²⁴ This EABC defines information warfare as the employment of information-related capabilities against a threat or threat presence in the information environment to undermine the threat nation political will and public support for their actions, strengthen friendly and neutral populations psychological resolve against threat influence, and force a hostile state to choose actions favorable to friendly interests.

²⁵ As an example, the growing use of tunnels and underground facilities by military and irregular forces to gain a tactical advantage is becoming more sophisticated and increasingly effective, making the likelihood of U.S. forces encountering military-purposed subterranean structures on future battlefields very high.

²⁶ Bērziņš, J. (2014, April). *Russia’s New Generation Warfare in Ukraine: Implications for Latvian Defense Policy*. Center for Security and Strategic Research, National Defence Academy of Latvia, p. 5.

²⁷ Future capabilities must account for threats in a multi-polar world, but should be benchmarked against the most capable.

²⁸ “What good is having the best fighting forces in the world if the U.S. Army loses the ability to employ them? What happens when the 82nd Airborne Division isn’t physically able to deploy because its paratroopers and families are psychologically targeted where they live, train, and go to school? What happens when installation infrastructure is sabotaged by multiple attacks timed to natural disasters? What happens when bases at home become the first skirmish lines of future war? It is time for the U.S. Army to change the way it thinks about its installations.” Duggan, P. (2017, August 3). How the enemy could hit the U.S. Army at home. *War on the Rocks*.

²⁹ “However, the characterization of space and cyberspace as similar to earthly domains generates conceptual inconsistencies. Just as our sense of control diminishes as we travel beyond land, so do the desired effects we seek in order to influence a target. Our presence and ability to control becomes less *physical* and increasingly more *virtual* as we extend our influence over the seas, into the air, and overhead in space.” Heftye, E. (2017, May 26). Multi-domain confusion: All domains are not created equal. *Strategy Bridge*. “When establishing their operational framework, commanders and staffs consider the physical, temporal, virtual, and cognitive aspects of their own AO, their higher echelon’s AO, and subordinate AOs. The physical, temporal, virtual, and cognitive aspects of an operational framework vary in terms of focus and priority depending upon the echelon, force capabilities, and the OE.” FM 3-0, *Operations*, p. 1-26

³⁰ See MDO, pp. 22-40.

³¹ “A *fait accompli* campaign is intended to achieve military and political objectives rapidly, presenting a *fait accompli*—a thing accomplished and presumably irreversible—before an allied response can prevent it.”

³² See MDO, p. 11-12. Note that the use of “Joint Force” requires joint solutions to these problems—not an Army-only approach.

³³ Compare this problem statement with that from the MDO: “How does the Army enable the Joint Force to compete with China and Russia below armed conflict, penetrate and dis-integrate their anti-access and area denial systems and ultimately defeat them in armed conflict and consolidate gains, and then return to competition?” MDO, p. 11.

³⁴ “Against insurgents and terrorists, the United States operated freely in the air, maritime, space and cyber domains. These domains were all shaped and harnessed to enable contested operations on land. That said, we have purchased systems optimized for fighting low-end enemies while neglecting capabilities needed for more capable future adversaries. Furthermore, while U.S. land forces have significant combat experience against irregular opponents, they are not prepared for more competent, well-armed adversaries.” Johnson, D. (2018, January). The importance of land warfare: This kind of war redux. *The Land Warfare Papers*, (117). Arlington, VA: The Institute of Land Warfare, Association of the United States Army, p. v.

³⁵ “A theater of operations is never truly set. Setting a theater is supposed to be a continuous, long-term process that creates situational understanding and helps to shape conditions for the success of Army, joint, and combined operations.” Shimerdla, J. & Kort, R. (2018, May-June). Setting the theater: A definition, framework, and rationale for effective resourcing at the theater army level. *Military Review*, 98 (3), p. 56.

³⁶ The EABC defines mesh as to connect devices directly, dynamically, and non-hierarchically to as many other devices as possible allowing them to relay critical data without interruption and cooperate, self-organize, and self-configure to accomplish tasks collectively despite individual device degradation or destruction.

³⁷ MDO, pp. 26-37.

³⁸ MDO, pp. 15-20.

³⁹ See Aretz, D. (2018, March 28). Information operations in a multi-domain operations battlespace. *Over the Horizon*.

⁴⁰ “First, we have got to find our enemy and simultaneously prevent him from finding us. Once we have found him we must hold him, that is we must attempt to restrict his mobility. Thirdly, we want to hit him. And, simultaneously, fourthly, we want to protect ourselves from his blows. Once we have exhausted him, fifthly, we want to smash him to pieces.” Fuller, J.F.C. (1927, May). Tactics and mechanization. *Infantry Journal*.

⁴¹ In subsequent capability development efforts, developers must remain cognizant that the use of older titles can make it more difficult for some to envision a new organization that operates differently than its historic version. While the EABC will use these historic terms, capability developers may later determine that a new title is required because this potential cognitive bias may impede the development of necessary capabilities for the future Army.

⁴² “Many have indicated that the authorities in cyberspace from a military perspective are too slow and not deliberate enough. [Admiral Michael] Rogers [Commander USCYBERCOM] explained that the authorities issue is one he has highlighted with Secretary of Defense James Mattis, adding this is an important area that needs to be reassessed.” Pomerleau, M. (2017, May 9). 6 priorities on Cyber Command’s extensive to-do list. *Fifth Domain*.

U.S. Army Concept for Multi-Domain Combined Arms Operations at Echelons Above Brigade

⁴³ “U.S. and partner governments will provide authorities for friendly forces to conduct operational preparation of the environment, as well as offensive electromagnetic spectrum, cyberspace, space, [unconventional warfare], and [information warfare] operations to deter and defeat adversaries.” MDO, p. A-1. “Operational preparation of the environment is the conduct of activities in likely or potential areas of operations to prepare and shape the operational environment.” (JP 3-05)

⁴⁴ “Certainly if you’re coming to me to look for the expertise of how we actually do this and how we actually apply the tools, I think we have to rely on our people to do that, and that’s where the expertise lies,” [General Joseph] Votel [commander of U.S. Central Command] said. “The role of the leaders in this is making sure that we ensure that it is integrated with the other domains, which we are operating, be it air, maritime or on the ground, and that we are pursuing the right authorities to allow our experts to bring these capabilities to bear.” On the authorities front, Votel expressed some certainty regarding how cyber effects are governed. Through Presidential Policy Directive 20, cyber effects are governed through the White House to be delegated by the secretary of defense. These effects are integrated through Cyber Command. At the strategic level, he said, this arrangement makes sense and is actually helpful as global cyberspace operation are synchronized to better support geographic combatant commanders. “At the operational level, however, the level at which cyberspace operations are integrated with conventional and special operations forces, this can make approval so cumbersome that these capabilities are narrowly irrelevant,” Votel added.” Pomerleau, M. (2017, September 14). Cyber is being normalized with traditional military operations. *Fifth Domain*.

⁴⁵ “In the wake of the 9/11 attacks, our own leaders’ assessments summed up our lack of jointness as a collective failure of imagination. Our failures to embrace the imperatives of integrated intergovernmental and interagency operations led to gaps in our understanding of the operational environment. The environments of both today and tomorrow demand nothing less than joint, intergovernmental, interagency, and multinational approaches. MDB cannot afford to leap ahead of our alliances and coalition partner capabilities.” DA, Office of the Army Deputy Chief of Staff, G-4, Logistics Initiative Group. (2018, January-February). Looking back for the way ahead: An interview with retired Gen. Lloyd Austin. *Army Sustainment*, p. 39.

⁴⁶ “Although a whole-of-government approach may seem a daunting task, one of the most effective ways to encourage coordination and collaboration is to bring representatives from interagency entities together for realistic training with their military counterparts *before* they are forced to work together in a crisis. Recognizing the importance of “training as you fight,” the Army’s Joint Multinational Readiness Center (JMRC) in Hohenfels, Germany, integrates interagency personnel into its exercises. They include mission rehearsal exercises, noncombatant evacuation operations, and brigade readiness exercises with NATO allies and multinational partners. This experience provides soldiers and other interagency participants the opportunity to work with, and learn from, the other entities they may encounter during a deployment. Integrated training also helps build the relationships and develop the trust required to effectively implement national security policy.” Derleth, J. (2018, February 28). Fostering a whole-of-government approach to national security from the bottom up. *Military Review*, p. 1.

⁴⁷ “The burden thus falls on the Joint Force to create the information environment that will facilitate partner integration. Any such environment should provide the ability to collaborate across multiple security levels without the need for segregated hardware systems.” CCJO, p. 13.

⁴⁸ “A number of US adversarial countries, groups and proxies are already exploiting US cognitive vulnerabilities—refer to the example of the little green men. Despite this, US decision makers lack the desire to invest in the cognitive because it is seen by many to have less value. In fact, the cognitive is often the most significant part of an adversary’s military campaign. The US is often easy to exploit not because it does not have the skills to influence, but because it does not see the importance of influence operations. America’s military might is not in question. However a durable change is not won solely by applications of kinetic power, it is often won by aligning deeds and words with the application of military power.” DeGennaro, P. (2017, September 19). The power of cognitive maneuver: Don’t underestimate it value. *Small Wars Journal*.

⁴⁹ EAB formations seek to mass the effects of overwhelming combat power at the decisive place and time. For operations in the information environment, mass includes not only consideration for the volume of messages but the decisive forms of media that resonate greatest among targeted audiences, as well as the times and locations in which those audiences devote to consuming each particular medium.

⁵⁰ “Effectively confronting Gray Zone threats in the human domain requires an emphasis on warfighters as much as the technology that supports them, for this is at the core of the character of war. As Maj. Gen. (ret.) Robert Scales argued in his assessment of current and future conflicts (*Scales on War*), the human element of conflict requires a broad spectrum of resources. Prevalent among them are abilities to adapt to diverse cultures, while preserving core objectives. This ‘alien environment’ presents challenges for established doctrine and operational practice. However, by recognizing the imperative to invest in Soldiers who can successfully engage with foreign populations, the United States can meet and overmatch the diverse threats facing the nation today and into the foreseeable future.” Linder, J., Merdith, S., & Johnson, J. (2017, August 6). The battlefield of tomorrow fought today: Winning in the human domain. *Small Wars Journal*.

⁵¹ “Mr. [J. Randall] Robinson [acting assistant secretary of the Army for Installations] talked about how we, as an Army, need to change how we think about installations for the future, as the battle space is being redefined. He said Installations are no longer a safe haven. They are part of Multi-Domain Battle’s Strategic Support Area and constantly under attack. He noted that threats have changed and continue to evolve—cyber, information warfare, hybrid warfare, and more capable conventional and unconventional adversary forces present new challenges. . . . Installations, part of the strategic support area within multi-domain battle, are the initial maneuver platforms of the Army. They are at increased risk from the accelerating rate of technological advancement within the aforementioned trends. Technology will advance with or without the Army’s approval. Emerging and non-traditional threats will use technologies to delay mobilization, disrupt deployments, interfere with command operations, undermine unit morale and create friction between our installations and surrounding communities.” Bohannon, D. (2017, October 18). Warriors corner: Installations of the Future. *Army News Service*.

⁵² “But in an era when potential adversaries are catching up with and finding ways to nullify U.S. military capability, our current methods of combining air, land, and sea power — to say nothing of the electronic domain — are no longer good enough. In order to fully connect and integrate the future force, the U.S. military must accelerate the adoption of autonomy, machine learning and artificial intelligence to increase the speed at which data is processed, information distributed and warfighting decisions made.” Probert, T. (2018, April 16). US military dominance requires better command-and-control tool. *Defense One*.

⁵³ CP positioning will be influenced by enemy capability ranges. Stand-off can nullify effects of direct EMS jamming, greatly complicate enemy targeting, and, even if found, force the enemy to expend a highly-capable strike system rather than more plentiful short- or medium-range systems.

⁵⁴ “A more fundamental challenge is made by those arguing that the categorization of future war by domain—especially but not limited to the cyber domain—is neither logical nor practical. As one observer notes, ‘the word [domain] contains some built-in assumptions regarding how we view warfare that can limit our thinking . . . [and] could actually pose an intractable conceptual threat to an integrated joint force.’” Woods, K. & Greenwood, T. (2018, 1st Quarter). Multidomain battle: Time for a campaign of joint experimentation. *Joint Force Quarterly*, 88, p. 15.

⁵⁵ “Balancing the requirements with risk when it comes to personnel must be done correctly. Sending the right individuals to broadening assignments and providing them with a range of experiences will enhance their professional growth, but filling the ranks of a unit with less than adequate personnel dooms the organization to mediocrity. It also causes frustration when individuals with the wrong background and experience

U.S. Army Concept for Multi-Domain Combined Arms Operations at Echelons Above Brigade

struggle to perform a job. The two-levels-up-and-one-down methodology may not work well in an ASCC. The experience-level requirement cannot be filled by randomly assigning mere bodies.” Angeles, R. (2017, November-December). Assessing the value of serving in an Army service component command as a broadening assignment. *Military Review*, 97(6), p. 58.

⁵⁶ “Because military operations are a series of temporary conditions, commanders think ahead in time and space to retain and exploit the initiative. . . . To achieve depth, commanders think ahead in time and determine how to connect tactical and operational objectives to strategic goals.” AOC, p. 21.

⁵⁷ “According to doctrine, theater army responsibilities are straightforward. However, possibly due to the fact that most officers have little experience with theater armies, there is a great deal of misunderstanding regarding their roles. Because of this, theater armies are a target of convenience in the quest for force reduction, but recent recommendations go too far, eliminating vital theater army roles and functions. In reality, the responsibilities of theater armies are far more expansive, requiring specialized sets of capabilities. Contrary to misunderstandings regarding their doctrinal role in today’s environment, theater armies are becoming more strategically necessary than ever.” Simontis, N. (2017, September-October). In defense of the theater army. *Military Review*, 97 (5), p. 30.

⁵⁸ Setting the theater serves as a deterrence to adversaries as it demonstrates the Army’s preparedness to initiate and win large-scale ground combat operations.

⁵⁹ Senior Army leaders need to eliminate the notion that ASCCs are simply administrative headquarters that serve as the “building superintendents” for their AORs. It is true that the activities to set the theater are crucial to the Army’s ability to fight wars. It is also true that to establish the necessary theater conditions to win in future conflict, ASCCs must work daily to achieve them; necessary conditions cannot be achieved from a “cold start.” However in the future OE, geographic ASCCs—theater armies—must be considered warfighters and resourced appropriately to accomplish the Army’s four strategic roles based on the conditions within their AOR.

⁶⁰ While Army forces must be prepared to dominate and win in armed conflict (deterrence in and of itself), winning the competition below armed conflict can be viewed as a greater victory as strategic objectives are accomplished without loss of Soldiers lives. This should serve to prioritize capability development for theater (and field) armies ahead of other EAB formations.

⁶¹ “U.S. Army Central has served as the land component command providing Mission Command for land operations in the U.S. Central Command area of responsibility three times since 2001. Based on this historical precedent as well as lessons learned in recent contingency operations in Iraq, the combatant commander needs an immediately available joint and coalition capability and the theater-enabling capability inherent in the Army service component command to mitigate delays in responding to crises and contingencies. The Army service component command or theater Army, embedded in the theater and with persistent presence and enduring partnerships, provides that capability.” Terry, J. (2016, January 12). Curtain’s always rising for theater army. *Army Magazine*.

⁶² 8th Army in Korea is an example of the latter, while 7th Army is a candidate for the former.

⁶³ “Complex is defined as an environment that is not only unknown, but unknowable and constantly changing. The Army cannot predict who it will fight, where it will fight, and with what coalition it will fight.” AOC, p. iii. Consider, for example, strategic force posturing decisions made after the end of the Cold War.

⁶⁴ “[Operational adaptability] also requires flexible organizations and adaptable institutions that are tailored and scaled to support a wide variety of missions and adjust focus rapidly to prevent conflict, shape the operational environment, and win the Nation’s wars.” ACC, p. 24. “‘The Army 10 years from now will not be organized like the Army is today,’ [General David] Perkins [Commander, U.S. Army Training and Doctrine Command] said. ‘Very much of that is going to be a joint effort, a joint activity.’” South, T. (2017, October 9). 4-star: Multi-domain battle will fundamentally change how the Army, other services fight. *Air Force Times*.

⁶⁵ In cases of strategic surprise, a corps (with augmentation) could serve as a JTF for large-scale ground combat operations. This would generally be relatively temporary in nature until a long-term command solution like a field army or a coalition land component command was established and prepared.

⁶⁶ This statement implies potential changes might be necessary in the Army’s leader development and talent management policies and procedures as part of a holistic approach to future capability development.

⁶⁷ BCTs are assigned to a division, but the division headquarters may be employed independently of them when necessary.

⁶⁸ They must be masters of the doctrine in FM 3-90, *Offense and Defense*, ATP 3-91, *Division Operations*, and FM 3-0, *Operations*.

⁶⁹ “This modernization strategy has one simple focus: make Soldiers and units more lethal. . . .The American people expect us to win on the offense by mastering the fundamentals of shoot, move, communicate and sustain better than any other Army. We mass fires with precision, we seize and retain the initiative, we retain mobility to maneuver while protecting our forces, and we gain critical information to think and act decisively, all this backed up by world-class logistics, and led by world class leaders.” McCarthy, R. & Milley, M. (2017, October 3). [Memorandum]. *Modernization priorities for the United States Army*. Washington, DC.

⁷⁰ “Capabilities that could not be used effectively or that would encumber lower echelons are retained at higher levels in order to allow lower echelons to focus on the extremely demanding lethal and physical aspects of close and deep operations. Higher echelon headquarters create the conditions for subordinate echelons to succeed.” Perkins, D. & Holmes, J. (2018, 1st Quarter). Multidomain battle: Converging concepts toward a joint solution. *Joint Force Quarterly*, 88, pp. 55-56.

⁷¹ AOC, p. 35.

⁷² ADRP 6-0, p. Glossary 2

⁷³ “Big Data is being generated at all times. Every digital process and social media exchange produces it. Systems, sensors and mobile devices transmit it. Much of this data is coming to us in an unstructured form, making it difficult to put into structured tables with rows and columns. To extract insights from this complex data, Big Data projects often rely on cutting edge analytics involving data science and machine learning. Computers running sophisticated algorithms can help enhance the veracity of information by sifting through the noise created by Big Data’s massive volume, variety, and velocity.” *Big Data Analytics*. “Every day hundreds of millions of people take photos, make videos and send texts. Across the globe businesses collect data on consumer preferences, purchases and trends. Governments regularly collect all sorts of data from census data to incident reports in police departments. This deluge of data is growing fast. The total amount of data in the world was 4.4 zettabytes in 2013. That is set to rise steeply to 44 zettabytes by 2020. To put that in perspective, one zettabyte is equivalent to 44 trillion gigabytes.” Khoso, M. (2016, May 13). How much data is produced every day? *Northeastern University New Ventures*.

⁷⁴ DODI 8320.02, p. 14

⁷⁵ “[Rongui Yang and Xiaobo Yin] have invented a film that can cool buildings without use of refrigerants and, remarkably, without drawing any power to do so.” How to keep cool without cost to the Earth. (2017, February 11). *The Economist*.

⁷⁶ “A new family of quantum materials, including graphene, hexagonal boron nitride and molybdenum disulfide, and nitrogen vacancy centers in diamond, are at the forefront of recent scientific research. They are being explored for their unusual electronic, optical and magnetic properties

U.S. Army Concept for Multi-Domain Combined Arms Operations at Echelons Above Brigade

with special interest in their potential uses for sensing, information processing and memory.” Paiste, D. (2015, November 6). Quantum materials: A new paradigm for computing? *MIT News*.

⁷⁷ AOC, p. 46.

⁷⁸ JP 3-0, p. GL-12.

⁷⁹ “Culturally, DOD is comfortable undertaking [human performance modification] activity to return individuals to their baseline performance following injuries or the general degrading effects of conducting operations. DOD is less comfortable increasing individuals’ performance beyond their baseline by, for example, improving IQ or night vision.” Brimley, S., FitzGerald, B., & Saylor, K. (2013, September). *Game Changers: Disruptive Technology and U.S. Defense Strategy*. Center for a New American Security. Washington, DC, pp. 17-18.

⁸⁰ CCJO, pp. 14-15; ACC, pp. 34-36; and AOC, pp. 41-43.

⁸¹ While technology can improve Army capabilities, greater technology can also increase the number of vulnerable attack surfaces for an enemy to exploit.

⁸² “Similar to other domains, Army leaders and organizations must be capable of employing capabilities in cyberspace, but not to the point of dependency should those capabilities be negated.” DA. (2014, Undated). *Army Strategic Planning Guidance 2014*, p. 17.

⁸³ “Even if the Army is able to implement [mission command] perfectly, it will still need to be able to communicate in a [joint, interagency, intergovernmental, and multinational] environment to successfully complete operations and support national objectives.” DA, Chief of Staff of the Army Strategic Studies Group-I. (2013, July). *Testing Assumptions about the Role of Land Power in 2030 Final Report*, p. 31.

⁸⁴ “What an ASCC is most widely known for is that it works to provide access to the region or operational environment, to acquire basing privileges, and to obtain overflight authorizations to allow U.S. forces to execute their missions in theater. However, it does significantly more than that. Prior to my assignment to an ASCC, previous assignments and participation in exercises gave me limited insight on what an ASCC did but not enough to fully understand the whole gamut of its responsibilities.” Angeles, R. (2017, November-December). Assessing the value of serving in an Army service component command as a broadening assignment. *Military Review*, 97(6), p. 56.

⁸⁵ “The Joint Force succeeds in competition by defeating the adversary’s efforts to achieve their strategic goals and deterring military escalation; it does this by expanding the competitive space for policymakers through multiple options for employing the elements of national power. Army forces play an integral role in this effort, actively engaging across domains (including space and cyberspace), in the EMS, and in the information space. The demonstrated capability to prevail in competition and in conflict counters adversaries’ narratives that portray the U.S. as a weak or irresolute partner. The combination of the ability to both effectively compete below armed conflict and to respond to an escalation toward armed conflict creates a position of strength and sets favorable conditions if conflict ensues. This position of strength provides a favorable environment for Joint Force, interagency, and partner efforts to counter adversaries’ coercion through unconventional and information warfare. The adversary’s proxies receive little or no support from its conventional forces, which allows U.S. partners to counter attempts to destabilize their countries more easily. The combined and persistent effects of deterring armed conflict and defeating unconventional and information warfare in a campaign of competition create unpredictability for the adversary and generate additional friendly options, thereby expanding the competitive space for policymakers.” MDO, pp. 20.

⁸⁶ “As we move across domains from the physical to the virtual (e.g., cyber, information, and even cognitive), the failure to focus on the danger within our shores is less and less understandable. The idea that the U.S. homeland can be continuously attacked across all “phases” of an operation from an adversary’s homeland should not be surprising. Neither should the fact that an enemy’s strategic attack against our homeland could have tactical, operational, and strategic implications for our operations, most especially during mobilization and deployment.... Preparations for battle must begin in the homeland. The homefront will probably be part of the next major battlefield, and the price of poor preparation will be paid by soldiers and civilians alike. To ensure U.S. forces are organized, trained, equipped, and postured, we must develop battle concepts that consider the domestic battlefield. We cannot win ‘over there’ if we lose ‘over here.’” Tussing, B. (2017, November 10). The multi-domain battle: What’s in it for the homeland. *War Room*.

⁸⁷ Command also includes the responsibility for the health, welfare, morale, and discipline of subordinates.

⁸⁸ While the military decision-making process may need to change considerably, the operations process (of which planning is part) is sufficiently broad to account for future changes in the character of war.

⁸⁹ “Every echelon requires three kinds of specialized capabilities. The first of these is support to the functioning of the commander and staff—to facilitate decision making and other aspects of battle command, and to provide “housekeeping,” protection and mobility. The second of these is to support the functioning of the line organizations, providing capabilities that are periodically required and distributed by mission need and to weight the main effort. The third of these specialized capabilities is required to set conditions for the success of the weighted line organizations.” Wass de Czege, H. (2002, April). Using information technologies to reduce the Army’s echelons. *Army Magazine*, p. 9.

⁹⁰ “To support interoperability and a real-time common operational picture, mission command information systems employ an accurate, high-resolution, standard, sharable geospatial foundation that enables all elements of the Army force (and other ground, supporting forces, and national agencies) to reference the same location no matter the map, device, or application used.” AFC-MC, p. 73.

⁹¹ All headquarters are responsible for planning and arranging the actions of subordinate elements in such a way that the combined effects achieve a higher objective. Ultimately, tactical military operations must, collectively, achieve the operational level military objectives. Achievement of military operational objectives should contribute to fulfilling the strategic political objectives. The headquarters at each succeeding echelon of command is responsible for ensuring that the actions of its subordinate formations contribute to the success of the overall operation. As such, long- and short-range plans are relative terms based on the operational framework and the specific echelon’s time horizons.

⁹² “Convergence optimizes the employment of capabilities across all domains to provide cross-domain synergy and multiple forms of attack and defense to overmatch the enemy. The Joint Force currently converges capabilities through episodic synchronization of domain-federated solutions. Future operations against a near-peer threat, however, will require the Joint Force to conduct continuous and rapid integration of multi-domain capabilities to gain cross-domain overmatch at decisive spaces. Decisive spaces are locations in time and space (physical, virtual, and cognitive) where the full optimization of the employment of cross-domain capabilities generates a marked advantage over an enemy and greatly influences the outcome of an operation. Convergence has two advantages over single-domain alternatives: the creation of cross-domain synergy and the layering of options to enhance friendly operations and impose complexity on the enemy. Through convergence, multi-domain capabilities are brought together in stimulate-see-strike or see-strike combinations that disrupt, degrade, destroy or dis-integrate enemy systems or create windows of superiority to enable friendly exploitation of the initiative.” MDO, pgs. 15-16.

⁹³ Battle damage assessment is “an estimate of damage composed of physical and functional damage assessment, as well as target assessment, resulting from the application of lethal or nonlethal military force.” (JP 3-0)

⁹⁴ “Commanders carefully avoid exceeding the span of control capabilities of subordinates. Span of control refers to the number of subordinate units under a single commander. This number depends on the situation and may vary. As a rule, commanders can effectively command two to six subordinate units. Allocating subordinate commanders more units gives them greater flexibility and increases options and combinations. However,

increasing the number of subordinate units increases the number of decisions commanders have to make. This slows down the reaction time among decisionmakers.” FM 6-0, p. D-2.

⁹⁵ “U.S. Army Central has served as the land component command providing Mission Command for land operations in the U.S. Central Command area of responsibility three times since 2001. Based on this historical precedent as well as lessons learned in recent contingency operations in Iraq, the combatant commander needs an immediately available joint and coalition capability and the theater-enabling capability inherent in the Army service component command to mitigate delays in responding to crises and contingencies. The Army service component command or theater Army, embedded in the theater and with persistent presence and enduring partnerships, provides that capability.” Terry, J. (2016, January 12). Curtain’s always rising for theater army. *Army Magazine*.

⁹⁶ Security cooperation involves “All Department of Defense interactions with foreign security establishments to build security relationships that promote specific United States security interests, develop allied and partner nation military and security capabilities for self-defense and multinational operations, and provide United States forces with peacetime and contingency access to allied and partner nations.” JP 3-20, Security Cooperation p. GL-11.

⁹⁷ “*Second, strengthen alliances and attract new partners.* Alliances and multinational partnerships provide avenues for peace, fostering conditions for economic growth with countries sharing the same vision. Strong alliances also temper the plans of those who would attack other nations or try to impose their will over the less powerful. History is compelling on this point: nations with strong allies thrive, while those without stagnate and wither. We will continue to work our allies, partners, and coalitions—the North Atlantic Treaty Organization.” Mattis, J. (2017, October 5). [Memorandum for All Department of Defense Personnel]. *Guidance from Secretary Jim Mattis*.

⁹⁸ “As the increasing speed and complexity of the future MDB environment impinges on this complicated balancing act, commanders and staffs must better organize in order to have flexible and responsive options to prevent mission failures. The establishment of dedicated contingency headquarters elements within service component commands should serve as the first step toward mitigating this emergent challenge.” Gandy, C. (2017, July 20). Time is always a constraint: Transforming headquarters organization and employment for the multi-domain battle environment. *Small Wars Journal*.

⁹⁹ 8th Army in Korea is an example of the latter, while 7th Army is a candidate for the former.

¹⁰⁰ “While the need is clear, efforts to implement a “whole-of-government” approach to national security have been episodic and ultimately unsuccessful. Although there has been much discussion, frustration, and angst about the lack of cooperation and coordination between and among U.S. government agencies and departments, there has been very little progress in establishing mechanisms to coordinate disparate and diverse organizations, each with their own leadership, culture, and authorities. The result is a disjointed and often ineffective foreign policy. While it will take national leadership to change this at the strategic level, there are measures that can be taken to mitigate challenges at the operational and tactical levels.” Derleth, J. (2018, February 28). Fostering a whole-of-government approach to national security from the bottom up. *Military Review*, p. 1.

¹⁰¹ Former V Corps commander LTG William Wallace noted that: “You can’t take a tactical HQs [V Corps] and change it into an operational [level] headquarters [CJTF-7] at the snap of your fingers. It just doesn’t happen. Your focus changes completely, and either you are going to take your eye off the tactical fight in order to deal with operational issues, or you are going to ignore the operational issues and stay involved in the tactical fight.”

¹⁰² “[Operational adaptability] also requires flexible organizations and adaptable institutions that are tailored and scaled to support a wide variety of missions and adjust focus rapidly to prevent conflict, shape the operational environment, and win the Nation’s wars.” ACC, p. 24.