



Commercial  
Vehicles

# The Amarok



Since launch in 2011 the Amarok has taken on the toughest of Australian out-back trails and the roughest of worksites. The Amarok adds a fresh face and premium feel cabin to the legendary workhorse package.

**Powerful Bi-turbo diesel engine.**

Responsive 132kW of power and up to 420Nm of torque .

**Unique drive combination.**

The enhanced grip with the option of Permanent 4x4 (4MOTION) with 8-speed automatic gearbox.

**High level of grip on every terrain.**

Outstanding off-road ABS and Hill Descent Assist.

**Multi-Collision Braking System.**

This new system triggers braking post collision to help prevent secondary collisions.

**New exterior design.**

An aggressive new front look, plus new 17" alloy wheel design.

**New interior design.**

Redesigned dash panel, including air-vents and upper dash storage space.

**Modern infotainment systems.**

New multimedia system with App-Connect\* and voice recognition.

**Largest tray in its class.**

Still the only ute in its class to fit a pallet between the wheel arches.

# Rugg



\*App-Connect is compatible for selected apps with the latest smart phone versions of iOS and Android.

# ed Good Looks



# When Power Meets Effi

**The 2.0L TDI engine with up to 132kw of power and 420Nm of torque.**

The legendary Volkswagen Commercial Vehicle 2.0L TDI engine has proven itself as worksite and bush trail ready. With not one but two Turbo-chargers, this Bi-turbo unit delivers power and torque from super low revs ensuring a smoother and more enjoyable driving experience.

## **2.0L TDI400 (132kW, 400 Nm).**

Average fuel consumption from 8.0L / 100km~

## **2.0L TDI420 (132kW, 420 Nm).**

4x2: Average fuel consumption from 8.4L / 100km~

4x4: Average fuel consumption from 8.5L / 100km~



Engine image is for reference only and may vary from final installed unit.



**01 8-speed automatic gearbox.**

The Amarok is the only vehicle in its class that offers the flexibility and performance of the 8-speed automatic transmission. The 1st gear is designed for off-road driving, whereas the 8th gear is optimised for economy driving at highway speeds.

**6-speed manual gearbox and Selectable 4x4 (4MOTION) - not illustrated.**

The robust 6-speed manual gearbox offers responsive and smooth gear changes for all driving conditions. The manual transmission is combined with the dual range Selectable 4x4 system.

## Permanent 4MOTION



## Selectable 4MOTION



**02 Permanent 4x4.** This always-on 4x4 system with Torsen differential excels on all surfaces. Torque is mechanically distributed from front to rear (40:60) with the ability to drive distribution to each wheel optimised by traction control intervention.

**03 Selectable 4x4.** The 4x4 drive system with a transfer case enables the front wheels to be electrically engaged and disengaged while driving. On steep inclines or longer stretches of challenging terrain an additional reduction gear set can also be engaged.



**01 New "Composition Media" system**

The crystal clear 6.33" colour touch screen is packed with the latest multimedia functions, including App-Connect\* and Bluetooth®. For added convenience the telephone functions can be voice activated.

| DC | CE | CP |

**02 App-Connect\***

With this function, selected apps are mirrored from your smart phone to the touch screen of the radio or navigation system display via the USB port and controlled using the touchscreen. | DC | CE | CP |

**12V sockets** (not illustrated). With up to three 12V sockets inside the vehicle: one in the dash panel, one in the central console and one in the second row of seats. | CP |

**03 New "Discover Media" navigation system.**

In addition to the functions of the "Composition Media" radio system with six loud speakers, there is a second integrated SD-card slot which is compatible with the SD-card with the map data. | CP |

**04 Voice Control.**

You are free to operate the telephone and audio functions without taking your hands off the steering wheel. Furthermore, you can call up virtually all menus and notifications on the radio using voice control. | DC | CE | CP |

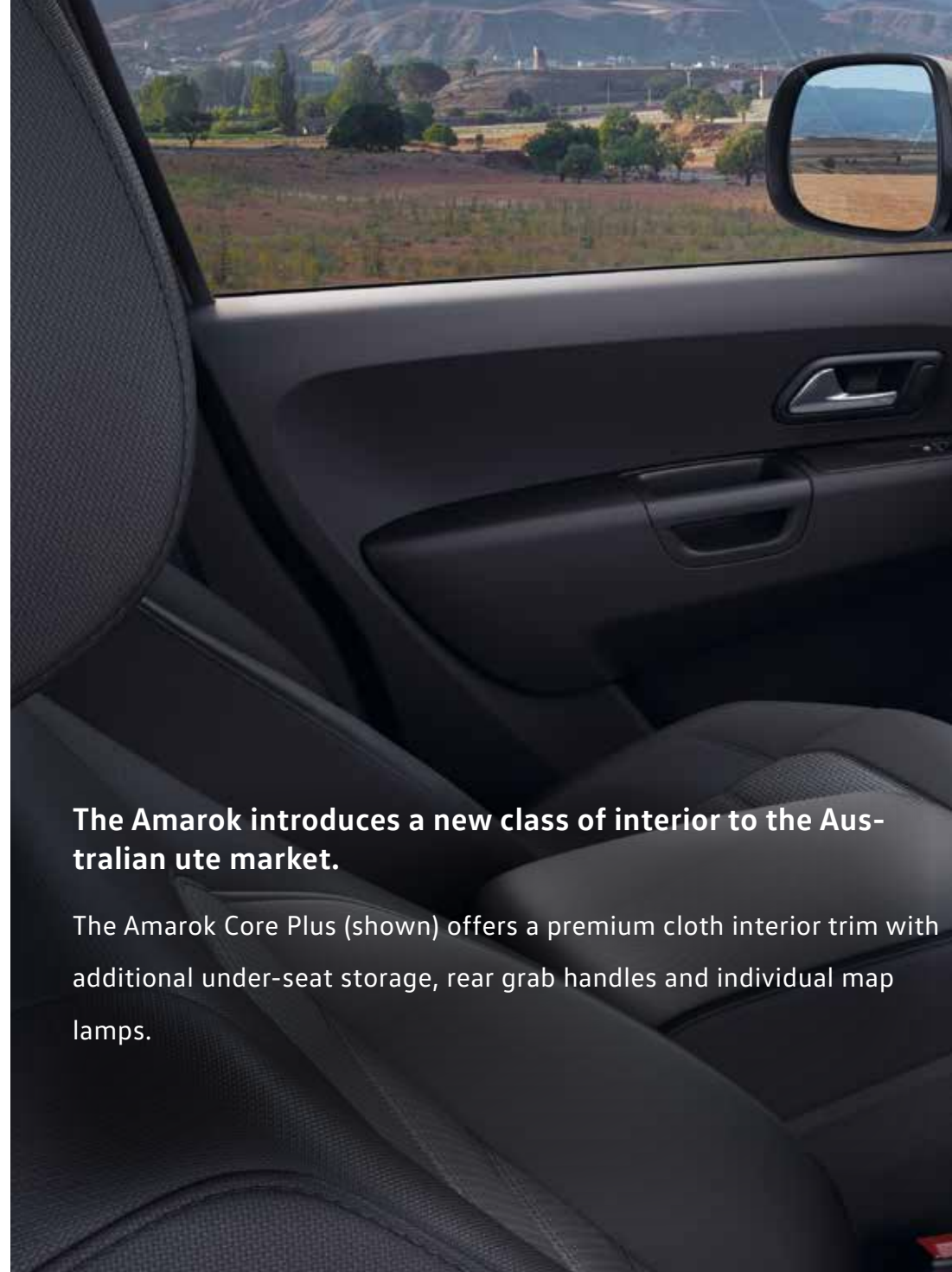

**The Amarok introduces a new class of interior to the Australian ute market.**

The Amarok Core Plus (shown) offers a premium cloth interior trim with additional under-seat storage, rear grab handles and individual map lamps.

\*App-Connect is compatible for selected apps with the latest smartphone versions of iOS and Android.



App-Connect featuring Apple CarPlay®

Core Plus interior shown



## Standard equipment for the Amarok Dual Cab.

### Dual Cab 4x2:

- 16-inch steel wheels
- Height adjustable front seats
- Power mirrors with heating function
- Power windows with one-touch up and down
- Climatic air-conditioning
- Rear bench seat with 3 child seat anchor points
- Heavy duty rubber flooring
- Centre console storage compartment with lid
- 3 point seat belts and headrests for all seating positions
- High level stop light incorporating lighting for tray area
- Leather-covered multi-function steering wheel
- Instrument cluster with multi-function "Plus" display
- Cruise control
- "Composition Media" system
- App-Connect\* USB interface
- Multi-Collision braking system

### Core 4x4:

- Dual Cab 4x2, Plus:
- Selectable or Permanent 4x4 (4MOTION) systems
- Engine under body protection (plate type)
- 16-inch 'Korama' alloy wheels
- Pirelli ATR tyres (245/70 R16)
- Rear bumper, with integrated step
- Rear parking sensors
- 'Rear-view' reversing camera<sup>^</sup>
- 'Core 4x4' decal on tub sides



## Standard equipment for The Amarok Core Plus.

### Core 4x4, plus:

- 17-inch 'Posadus' alloy wheels
- Radiator grille with single chrome elements
- Extended wheel arches
- Matte black styling bar
- Comfort closing rear tailgate
- Front fog lights
- Colour-coated exterior mirrors and door handles
- Four 12V sockets, (three in cabin and one in tray)
- Parking sensors front and rear
- 'Kemisu' cloth upholstery
- Carpet floor covering
- Rear (B-pillar) grab handles



\*App-Connect is compatible for selected apps with the latest smartphone versions of iOS and Android.  
<sup>^</sup>Safety technologies are not a substitute for the driver's responsibility of the vehicle.





Core Plus model shown



**01 Load light.** The exterior load light helps illuminate the tray, ideal for early starts or late finishes. | DC | CE | CP |

**The smoothest moving tailgate.** The comfort feature makes opening and closing the tailgate a breeze, while still rated to carry up to 200kg. | CP |

**12V socket** (not illustrated). A 12V socket is fitted on the inside of the left side panel. | CP |

# Packs A Pallet

**The widest tray in its class.** No other pickup provides so much space between the wheel arches: the loading width of 1,222 mm even enables Euro pallets to be loaded crosswise. The spacious cargo box with a 2.52 m<sup>2</sup> load surface features convincing dimensions – such as the 508 mm high side panels and the low loading sill height of 780 mm.



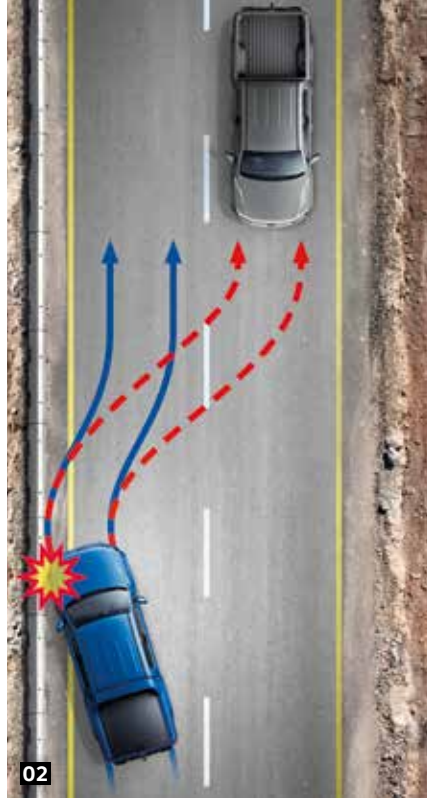



02





03

## Safety systems.

 **02 New automatic Multi-Collision Braking System.** Triggers braking after a collision, with the aim of preventing secondary collisions. After a short delay, the vehicle begins phased braking action down to 10 km/h. | DC | CE | CP |

 **Electronic Stability Programme** (not illustrated). Prevents under or over-steering via targeted braking of individual wheels. | DC | CE | CP |

 **Front and head/thorax airbags** (not illustrated) for the driver and front passenger. | DC | CE | CP |

 **Height-adjustable head restraints** (not illustrated) and 3-point seatbelts are featured throughout, with pretensioners on the front seats. | DC | CE | CP |

**03 Trailer Stabilisation.** Configured for the Genuine Volkswagen tow bar wiring to compliment the Electronic Stability Programme, helping to reduce trailer sway. | DC | CE | CP |





04

## Driver assistance systems.

 **04 "Rear View" camera<sup>^</sup>.** Simplifies reversing by showing a limited view of the area behind the vehicle on the display. Static guidelines facilitate the parking process. | DC | CE | CP |

 **Hill Descent Assist** (not illustrated). Allows you to drive down slopes in a safe, controlled way by governing the engine speed and applying the brakes, if necessary. | DC | CE | CP |

 **Park Pilot** (not illustrated). Emits audible warnings when obstacles are detected in front of or behind the vehicle when parking, and provides a visual display. | DC | CE | CP |

 **Cruise control** (not illustrated). As of a speed of 30 km/h, it maintains the set speed depending on uphill and downhill inclines. | DC | CE | CP |

 **Mechanical rear differential lock** (not illustrated). When activated ensures both rear wheels receive the same amount of power and rotations. This offers optimal traction on sandy or slippery surfaces. | DC | CE | CP |

**Hill Start Assist** (not illustrated). Prevents the vehicle from rolling back on inclines and makes it easier to start off on uphill slopes. | DC | CE | CP |

<sup>^</sup> Safety technologies are not a substitute for the driver's responsibility of the vehicle.

# Technical Specifications

Engine	TDI420 4x2	TDI400 4x4	TDI420 4x4
Type	4 cylinder Bi-turbo diesel, DOHC, 16 valve		
Cubic capacity, litres/cc	2.0 / 1,968		
Max power, kW @ rpm	132 @ 4,000	132 @ 4,000	132 @ 4,000
Max torque, Nm @ rpm	420 @ 1,750	400 @ 1,500 - 2,250	420 @ 1,750
Compression ratio	16.5:1		
Fuel system	Common Rail Direct Injection		
Exhaust emission control	Water-cooled exhaust gas recirculation (EGR), catalytic converter and diesel particulate filter (DPF)		
Fuel type (Recommended)	Diesel EN 590		
<b>Transmission</b>	<b>8 Speed Automatic</b>	<b>6 Speed Manual</b>	<b>8 Speed Automatic</b>
Driven wheels	4x2 Rear Wheel Drive	4x4 (4MOTION) Selectable	4x4 (4MOTION) Permanent
Gear Ratios	Final Drive: 3.70 1st Gear: 4.714 2nd Gear: 3.143 3rd Gear: 2.106 4th Gear: 1.667 5th Gear: 1.285 6th Gear: 1.00 7th Gear: 0.839 8th Gear: 0.667 Reverse Gear: 3.300	Final Drive: 4.10 1st Gear: 3.583 2nd Gear: 1.889 3rd Gear: 1.114 4th Gear: 1.00 5th Gear: 0.564 6th Gear: 0.473 Reverse Gear: 3.250	Final Drive: 3.70 1st Gear: 4.714 2nd Gear: 3.143 3rd Gear: 2.106 4th Gear: 1.667 5th Gear: 1.285 6th Gear: 1.00 7th Gear: 0.839 8th Gear: 0.667 Reverse Gear: 3.300
<b>Fuel consumption~</b>			
Combined, L/100km	8.4	8.0	8.5
Urban, L/100km	10.0	9.2	10.1
Extra Urban, L/100km	7.6	7.3	7.6
CO <sub>2</sub> emissions, g/km	224	211	224
Fuel tank capacity, litres	80		
<b>Towbar Capacity**</b>			
Braked † kg	3,000		
Unbraked, kg	750		
Towball load limit, kg	300		

~Fuel consumption figures according to Australian Design Rules (ADR) 81/02 derived from laboratory testing. Factors including but not limited to driving style, road and traffic conditions, environmental influences, vehicle condition and accessories fitted, will in practice in the real world lead to figures which generally differ from those advertised. Advertised figures are meant for comparison amongst vehicles only.

\*\* With trailer brakes up to a gradient of 12%.

† Please note that Volkswagen Group Australia does not endorse or will not be held liable for any claim, loss or damage arising from the use or fitment of electronic trailer brakes.

# Technical Specifications

## Running Gear

Suspension	2.0 litre, 4 cylinder TDI
Front axle	Transverse link with A-frame arm double wishbone and anti-roll bar
Rear axle	Multi-layer rigid axle with leaf spring and stabiliser bar
Steering	Power assisted rack & pinion steering
Brake systems	Anti-lock Braking System (ABS) with Electronic Brake-pressure Distribution (EBD), Brake Assist and Electronic Stabilisation Program (ESP)
Brakes	
Front / Rear, mm	303, Ventilated Discs / 292, Drum
Brake systems	ESP, off-road ABS, ASR, EDL, Hill Holder, Brake Assist, Traction Control and Off-Road ABS including Hill Descent
Turning circle, m	12.95

## Weights~

	TDI420 4x2	TDI400 4x4	TDI420 4x4
Unladen Mass Kg`s - DC 4x2	1,901	-	-
Unladen Mass Kg`s - Core	-	2,022	2,022
Unladen Mass Kg`s - Core Plus	-	2,052	2,052
Payload <sup>†</sup> kg - DC 4x2	1,139	-	-
Payload <sup>†</sup> kg - Core	-	1,018	1,018
Payload <sup>†</sup> kg - Core Plus	-	988	988
Gross Vehicle Mass (GVM) kg	3,040	3,040	3,040
Gross Combined Mass (GCM) kg	5,550	5,550	5,550
Roof load, kg	100	100	100

# Dimensions

Exterior Dimensions~	TDI420 4x2 MT	TDI400 Core 4x4 AT	TDI420 Core Plus 4x4 AT
Overall length mm	5,181	5,254	5,254
Width mm	1,944	1,944	1,954
Width incl. mirrors mm	2,228	2,228	2,228
Height mm	1,834	1,834	1,878 <sup>^</sup>
Wheelbase mm	3,095	3,095	3,095
Ground clearance mm	230	226	226
Entry angle °	28.0	28.0	28.0
Departure angle °	28.0	23.6	23.6
Ramp angle °	23.0	23.0	23.0
Wading depth, mm	500	500	500
<b>Tray Dimensions</b>			
Length, mm	1,555		
Width, mm (Max.)	1,620		
Width, mm (between wheel arches)	1,222		
Tailgate opening, mm (Max.)	1,364		
Height (tailgate,) mm	508		
Height from ground, mm	780		

## Amarok Dual Cab (with wheel arch flares and rear step bumper)

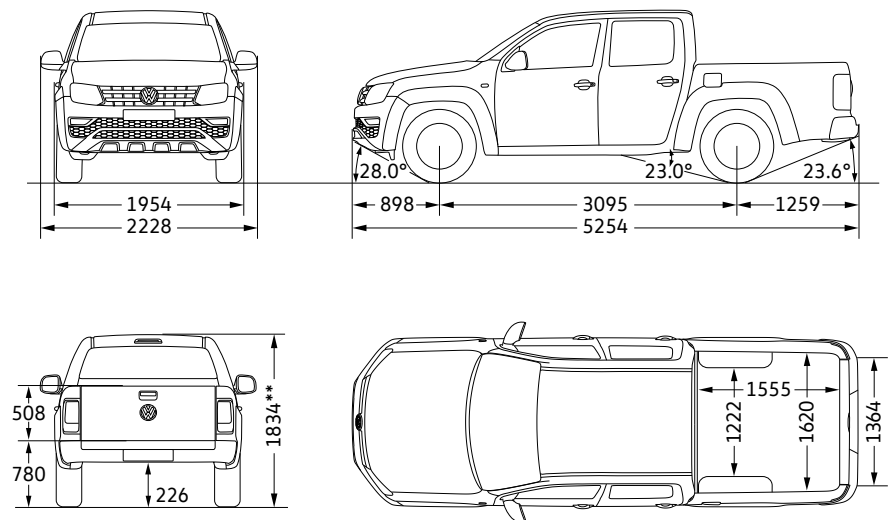

<sup>^</sup> including sports bar

<sup>†</sup> Payload is defined as the Gross Vehicle Mass (GVM) minus the Kerb Mass.

Payload is the maximum combined weight of occupants, cargo, added structures and tow ball down weight (when towing). GVM must not be exceeded.

\*\*Height shown without sports bar.

## Seat upholstery.

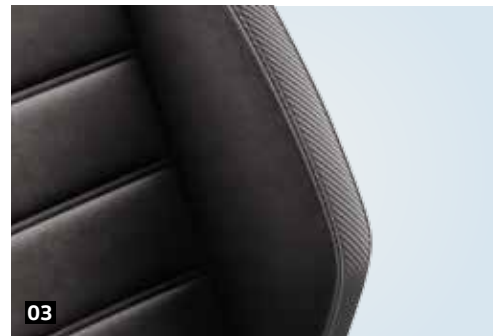
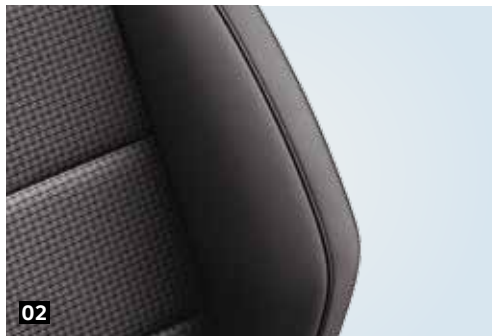

- 01** "Austin" cloth seat upholstery in Titanium Black and Moon Rock Grey | DC | CE |
- 02** "Kemisu" cloth seat upholstery in Palladium Black | CP |
- 03** "Alcantara®" seat upholstery\* in Titanium Black | CP |

## Wheels.



- 04** Steel wheels, 6.5J x 16. With 205 R 16 tyres. | DC |
- 05** "Korama" alloy wheel, 6.5 J x 16. With 245/70 R 16 tyres. | CE |
- 06** "Posadas" alloy wheel, 8.0 J x 17. With 245/65 R 17 tyres. | CP |
- 07** "Cantera" alloy wheel. 8.0 J x 19. With 255/55 R 19 tyres. | CP |



Please note that the print process does not allow for exact reproduction of the upholstery colours. Please contact your Volkswagen dealer for further information on upholstery combinations.

## Paint finishes.

<b>01</b> Candy White Solid	B4B4	DC   CE   CP
<b>02</b> Mojave Beige Metallic	1B1B	DC   CE   CP
<b>03</b> Reflex Silver Metallic	8E8E	DC   CE   CP
<b>04</b> Indium Grey Metallic	X3X3	DC   CE   CP
<b>05</b> Starlight Blue Metallic	3S3S	DC   CE   CP
<b>06</b> Deep Black Pearl Effect	2T2T	DC   CE   CP



Highline model shown. Please note that Metallic and Pearl Effect paint are optional at extra cost. The print process does not allow for exact reproduction of the exterior colours. Please contact your Volkswagen dealer for further information on colour combinations.

# Volkswagen Accessories



## 01 Load surface liner

5 piece load liner that "Packs a Pallet". The high impact material provides a non-skid surface whilst protecting the tub.



## 02 "Aragonit Black Edition" alloy wheel

19-inch ARAGONIT alloy wheel in black.



## 03 Tow bar

As robust as the Amarok itself: The towbar is designed specifically for this vehicle. The tow bar wiring harness ensures that trailer stability control is activated, helping to mitigate trailer sway.



## 04 Styling Bars

The Volkswagen genuine sports styling bars adds quite the impression to the Amarok. Designed to fit with the Volkswagen genuine hard lid, soft tonneau cover, rolling cover and tubliner. Available in polished stainless steel and black.



## 05 Side steps

Available in polished stainless steel and black, the side steps give the vehicle a sportier, more dynamic feel that can hold up to 200kg.



## 06 Rolling Cover

Rolling cover with its unique retractable design providing multiple opening positions and the benefits of a built-in tailgate lock.



# Volkswagen Choice: Protecting your investment.

Volkswagen Choice

Guaranteed Future Value

We're out to prove that there still are some guarantees in life. We've developed Volkswagen Choice<sup>^</sup> - a flexible finance solution that provides you with the assurance of knowing exactly what the minimum value of your vehicle will be down the track. With Volkswagen Choice<sup>^</sup>, you can enjoy your car without worrying about what the future will bring, providing peace of mind.

At the end of your term,  
you can simply choose to:



## Trade-in

Your existing vehicle and purchase a new Volkswagen under the Volkswagen Choice Program

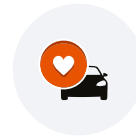

## Retain

Make an offer to purchase/refinance the vehicle

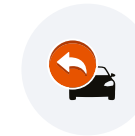

## Return

Hand the vehicle back and receive the Guaranteed Future Value<sup>#</sup>

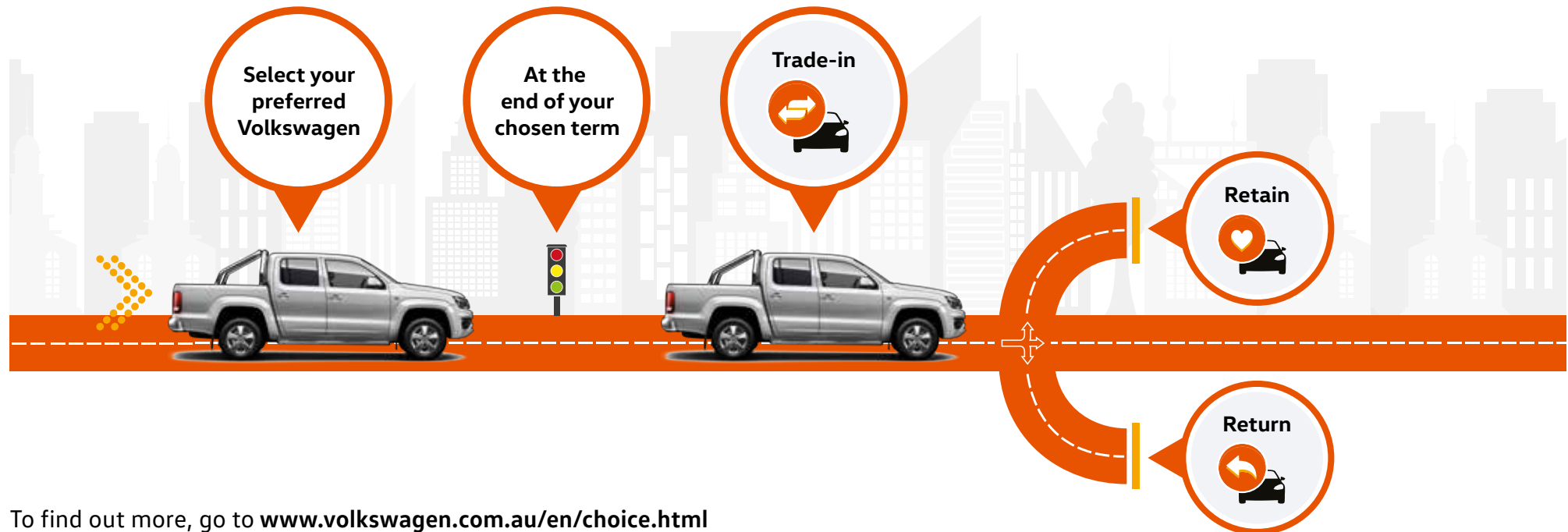

To find out more, go to [www.volkswagen.com.au/en/choice.html](http://www.volkswagen.com.au/en/choice.html)

<sup>^</sup>The Volkswagen Choice Program consists of an option to require Volkswagen Financial Services to purchase your vehicle at the end of your Volkswagen Financial Services Chattel Mortgage or Consumer Loan for a value (known as the Guaranteed Future Value) determined by Volkswagen Financial Services and set out in your contract. <sup>#</sup>The Guaranteed Future Value is not a representation by Volkswagen Financial Services as to the likely market value of your vehicle as at the end of your contract. The option is available on new and demonstrator Volkswagen vehicles for selected models only. Please verify with your dealership vehicles that are eligible for the program. If vehicles are not returned in an acceptable condition, as defined in the terms and conditions or exceed kilometre restrictions the Guaranteed Future Value will be reduced. See the Volkswagen Choice Fair Wear and Tear Guide for more information on the required conditions and circumstances. The cost of the Volkswagen Choice Program is incorporated into the applicable interest rate. Please read the full terms and conditions. Please consider whether these products and services are appropriate for your circumstances. Before acting on any of the information on this page, please seek independent financial and tax advice. Full terms and conditions are available upon application. Available only to approved applicants of Volkswagen Financial Services. Subject to credit assessment. Fees and charges apply. Fleet, government, rental buyers, hire car and chauffeur companies are excluded. Available at participating Volkswagen dealers. Volkswagen Financial Services is a trading name of Volkswagen Financial Services Australia Pty Limited ABN 20 097 071 460. Australian Credit Licence 389344

# General information

## Owning a Volkswagen

### **Volkswagen New Vehicle Warranty**

Every new Volkswagen vehicle is covered by a three-year unlimited kilometre manufacturer's warranty, which includes Volkswagen Assist (24-hour roadside assistance). Every new Volkswagen vehicle is also covered by a 3 year paintwork and 12-year anticorrosion perforation warranty. For further information regarding this New Vehicle Warranty, including pricing and terms and conditions, please consult your local Volkswagen dealer or visit [www.volkswagen.com.au](http://www.volkswagen.com.au)

### **Volkswagen Assist – 24-Hour Roadside Assistance**

As a valued customer, you can be assured that wherever you travel within Australia, you will have access to roadside assistance, 24 hours a day, 365 days a year. This is complimentary for the duration of the vehicle's original Volkswagen warranty period. You will receive help in the event of a breakdown or accident and, if required, your vehicle will be mobilised or transported to an Authorised Volkswagen Workshop. As a Volkswagen owner you will also have access to the additional benefits of accommodation and car rental if your vehicle cannot be mobilised within 24 hours, when you are over 100km away from home.

### **Volkswagen Genuine Parts®**

Volkswagen Genuine Parts® are designed for your vehicle and approved by Volkswagen, with particular regard to safety. The workmanship, dimensional accuracy and materials used in these parts comply with factory specifications. To ensure safety and reliability, Volkswagen recommends the use of Volkswagen Genuine Parts®. Volkswagen Authorised Dealers offer a two-year unlimited kilometre warranty on Genuine Parts from the date of purchase.

### **Volkswagen Financial Services**

Buying, borrowing or leasing, Volkswagen Financial Services will certainly make you think differently about financing and insuring your new Volkswagen. Committed to meeting the needs of Volkswagen drivers across Australia, we offer a range of leasing, financing and insurance products, each with distinct advantages depending on your specific circumstances. We can tailor a solution to suit your individual requirements, so you can rest assured that there will be no surprises along the way. Speak to your local participating authorised Volkswagen Dealer today to put together a solution that best suits your lifestyle.

### **Volkswagen Choice Guaranteed Future Value^**

Volkswagen Choice is a finance program available to approved applicants of Volkswagen Financial Services only, which provides Volkswagen owners protection around your Volkswagen's future value#, whilst offering a simple monthly instalment financing option. Enjoy the peace of mind of knowing the minimum value you can receive for your vehicle at the end of your contracted term. You can choose to either trade-in, return or retain your Volkswagen – it's your choice. Learn more about how to protect your investment by visiting [www.volkswagen.com.au/en/choice.html](http://www.volkswagen.com.au/en/choice.html) today.

### **Volkswagen Assured Service**

What you can expect as standard when servicing through our authorised Volkswagen dealer network is an expert team, trained by Volkswagen utilising specialist Volkswagen diagnostic equipment ensuring they're able to cater for all of your Volkswagen's servicing and repair needs. They also have access to the full Volkswagen Genuine Parts catalogue making sure any part replaced during a service or repair is replaced with a Volkswagen Genuine Part. What's more, your Volkswagen will be returned in immaculate condition, cleaned and vacuumed. Add these together and you can rest assured there's no better place to keep your Volkswagen running like a Volkswagen.



# The Amarok

Volkswagen Group Australia Pty Ltd  
24 Muir Road Chullora NSW 2190  
ABN 14 093 117 876

Printed in Australia  
July 2017  
[www.volkswagen.com.au](http://www.volkswagen.com.au)

Publication: VWCAMARMY17

#### **Important information**

Apple CarPlay® is a registered trademarks of Apple Inc. Android Auto™ is a registered trademark of Google Inc. Bluetooth® is a registered trademark of Bluetooth SIG Inc. Alcantara® is a registered trademark of Alcantara S.p.A.

Volkswagen is distributed by Volkswagen Group Australia Pty Ltd, 24 Muir Road, Chullora, NSW 2190, ABN 14 093 117 876. Specifications are as planned at July 2017, for Model Year 17 and are subject to change without notice or obligation. All information in this brochure is correct at the time of publication, however variations may occur from time to time and Volkswagen, in so far as it is permitted by law to do so, shall not be liable in any way as a result of any reliance by any person on anything contained in this brochure. Authorised Volkswagen dealers will provide up-to-date information on model application, design feature, prices and availability on request. All colours are a general guide only, as the printing process cannot reproduce the actual exterior colour appearance. See your dealer to confirm colour/model availability.

Your Volkswagen dealer.



Commercial  
Vehicles

# The Amarok

## Specifications



# Features and Specifications

Safety and Security	Amarok Dual Cab 4x2	Amarok Dual Cab Core 4x4	Amarok Dual Cab Core Plus 4x4
<b>Airbags</b>			
Driver and front passenger airbags	●	●	●
Driver and front passenger side (head & thorax) airbags	●	●	●
<b>Seat Belts</b>			
3 point seat belts for all passengers	●	●	●
Front height adjustable seat belts with pre-tensioners and belt force limiters	●	●	●
Outer rear seat belt pre-tensioners	●	●	●
Visual and acoustic warning for driver and front passenger seat belt not fastened	●	●	●
<b>Child Restraints</b>			
Child seat top tether anchorage points (3)	●	●	●
ISOFIX child seat anchorage points, outer rear seats	●	●	●
<b>Brakes and Traction Control</b>			
Automatic flashing brake lights activated in emergency braking situation	●	●	●
Electronic Stability Programme (ESP)	●	●	●
Electronic Brake-pressure Distribution (EBD)	●	●	●
Anti-lock Braking System (ABS)	●	●	●
Brake Assist	●	●	●
Anti-Slip Regulation (ASR)	●	●	●
Electronic Differential Lock (EDL)	●	●	●
Auto Hold function	●	●	●
Trailer Sway Stability Control (only with genuine tow bar wiring kit)	●	●	●
Mechanical Differential Lock	○	●	●
Multi-collision brake	●	●	●
Active Roll-over Prevention	●	●	●
<b>Driver Assistance Technology*</b>			
Off-road mode with optimised ABS, ESP, transmission and hill descent control	●	●	●
Parking distance sensors, rear with acoustic warning	○	●	●
Parking distance sensors, front and rear with acoustic warning	—	—	●
Optical Parking System (OPS) in audio display	○	●	●
Rear View Camera (RVC) with static guidance lines	○	●	●
Dusk sensing headlight function	○	○	●
Rain sensing wipers	○	○	●

\*Safety technologies are not a substitute for the driver's responsibility of the vehicle.

● Standard   ○ Optional Extra   — Not available   A Volkswagen Genuine Accessory (Dealer fitted)

## Safety and Security

	Amarok Dual Cab 4x2	Amarok Dual Cab Core 4x4	Amarok Dual Cab Core Plus 4x4
<b>Lighting</b>			
Halogen headlamps	●	●	●
Bi-Xenon headlamps with integrated LED daytime driving lights	—	—	○
Front fog lights	○	○	●
Coming / leaving home function	●	●	●
Internal headlight range adjustment	●	●	●
LED rear licence plate light	●	●	●
Rear high mount stop light, LED	●	●	●
Rear fog lamp	●	●	●
<b>Locking</b>			
Lockable rear tailgate with "comfort" closing	—	—	●
Electronic engine immobiliser	●	●	●
Remote central locking with folding key (3)	●	●	●
Lockable glovebox			
<b>Head Restraints</b>			
Rear head restraints height adjustable (3)	●	●	●

## Exterior Equipment / Styling

<b>Roof</b>			
Roof gutter inserts (Black)	●	●	●
Roof bar mounting points	●	●	●
Roof bars	A	A	A
Bicycle, kayak, ski, surfboard and snowboard holders	A	A	A
<b>Towbar</b>			
Towbar with removable tongue	A	A	A
Wiring Kit - 7-pin flat trailer connector	A	A	A
<b>Windows</b>			
Power front / rear, with roll-back function and one touch up-down	●	●	●
Remote operated convenience close and open feature	●	●	●
Heat insulating tinted glass	●	●	●
Privacy tint - rear windows	—	—	○

Exterior Equipment / Styling	Amarok Dual Cab 4x2	Amarok Dual Cab Core 4x4	Amarok Dual Cab Core Plus 4x4
<b>Body Enhancements</b>			
Body coloured front bumper bar	●	●	●
Body coloured door handles and exterior mirrors	—	—	●
Chrome radiator grille highlights with single chrome strip	—	—	●
Matte black rear step bumper	○	●	●
Extended wheel arch flares	—	—	●
Styling Bar (Matte Black) - Standard type	A	A	●
Side Steps (Matte Black)	A	A	A
Side Steps (Stainless Steel)	A	A	A
Styling Bar (Stainless Steel) - Standard type	A	A	A
Rolling cover (lockable)	A	A	A
Hard tonneau cover (lockable)	A	A	A
Soft tonneau cover	A	A	A
Canopy with side windows and rear door	A	A	A
<b>Protection</b>			
Underbody protection (Engine) - Plate type	●	●	●
Underbody protection (Engine) - Bar type	A	A	A
Mudflaps - front and rear	●	●	●
Slimline weather shields (set of 4)	A	A	A
Slimline bonnet protector - clear or tinted	A	A	A
Tubliner - Under rail plastic	A	A	A
Underbody protection (Fuel tank)	A	A	A
<b>Wheels and Tyres</b>			
Steel wheels 16" with 205 R16	●	—	—
Alloy wheels (Korama) 16 x 6.5" with 245/70 R16	○	●	—
Alloy wheels (Posadas) 17 x 6.5" with 245/65 R17	—	—	●
Alloy wheels (Cantera) 19 x 8" with 255/55 R19	—	—	○
Full size steel spare wheel	●	●	●

● Standard   ○ Optional Extra   — Not available   A Volkswagen Genuine Accessory (Dealer fitted)



<b>Comfort &amp; Convenience</b>	<b>Amarok Dual Cab 4x2</b>	<b>Amarok Dual Cab Core 4x4</b>	<b>Amarok Dual Cab Core Plus 4x4</b>
<b>Air Conditioning</b>			
Single zone air-conditioning	●	●	●
<b>Cruise Control</b>			
Cruise Control with stork mounted controls	●	●	●
<b>In-Car Entertainment and Technology</b>			
<b>Composition Media audio system 6.33"</b> 6.33" colour touch screen display, AM/FM radio with phase diversity tuner, CD player (MP3/WMA compatible), AUX and SD card slot and external USB input. Car menu with convenience and service settings. Includes display for park distance control (if fitted).	●	●	●
<b>Discover Media audio and satellite navigation system 6.33"</b> 6.33" colour touch screen display, AM/FM radio with phase diversity tuner, CD player (MP3/WMA compatible), AUX and SD card slot, external USB input, and four (4) speakers. Car menu with convenience and service settings. Includes display for park distance control (if fitted).	—	—	○
App-Connect <sup>^</sup> USB interface for Apple CarPlay <sup>®</sup> , Android Auto <sup>™</sup> and MirrorLink <sup>®</sup> in centre console	●	●	●
Audio, Telephone and Multi-Function Display controls mounted on steering wheel	●	●	●
Auxiliary input audio socket in centre console	●	●	●
Bluetooth <sup>®</sup> phone connectivity with contacts display, operation via touch screen audio unit or Multi-Function Display and Bluetooth <sup>®</sup> audio streaming	●	●	●
Speakers - front and rear (6)	●	●	●
Voice operation, telephone system functions can be operated using voice commands	●	●	●
<b>Instrumentation</b>			
Speedometer & tachometer, electronic odometer and tripmeter, digital clock, fuel and coolant gauges, ambient temperature display, transmission gear indicator	●	●	●
Multi-Function Display (MFD Plus) monochrome display – driving time, trip length, average and current speed, average and current fuel consumption, distance till empty, speed warning function, vehicle status, audio, telephone, navigation and convenience menus	●	●	●
<b>12 V Socket ( 4 )</b>			
Centre console	●	●	●
Centre console dashboard	—	—	●
Second row centre console	—	—	●
Cargo area	—	—	●
<b>Interior Lighting</b>			
Interior lights - door operated	●	●	●
Reading lights - front	—	—	●
Reading lights - rear	●	●	●

<sup>^</sup>App-Connect is compatible for selected apps with the latest smartphone versions of iOS and Android

<b>Comfort &amp; Convenience</b>	<b>Amarok Dual Cab 4x2</b>	<b>Amarok Dual Cab Core 4x4</b>	<b>Amarok Dual Cab Core Plus 4x4</b>
<b>Interior Trims</b>			
Shadow chrome-look decorative dashboard insert	●	●	●
Chrome-look interior door leaver	—	—	●
Leather covered steering wheel and gearshift knob	●	●	●
Rubber floor covering in cab	●	●	—
Carpet floor covering in cab	—	—	●
Carpet mats - front and rear with decorative stitching	A	A	A
Rubber mats - front and rear	A	A	A
<b>Mirrors</b>			
Electric adjusted door mirrors with heating function	●	●	●
Colour-coded exterior mirrors	—	—	●
<b>Steering Wheel</b>			
3 spoke leather covered steering wheel	●	●	●
Audio, Telephone and Multi-Function Display controls	●	●	●
Height and reach adjustable steering wheel	●	●	●
<b>Seating</b>			
Cloth seat upholstery - Austin trim	●	●	—
Cloth seat upholstery - Kemisu trim	—	—	●
Alcantara seat upholstery	—	—	○
Individually heated front seats	—	—	○
Manual height adjustment - front	●	●	●
Lumbar support - front	○	○	●
Rear seat backrest forward folding	●	●	●
Rear seat base split folding (60/40)	●	●	●
<b>Grab Handles</b>			
Roof line folding grab handles (4)	●	●	●
A-pillar fixed grab handle (1)	●	●	●
B-pillar fixed grab handles and coat hanger (2)	—	—	●

● Standard    ○ Optional Extra    — Not available    A Volkswagen Genuine Accessory (Dealer fitted)

## Comfort & Convenience

	Amarok Dual Cab 4x2	Amarok Dual Cab Core 4x4	Amarok Dual Cab Core Plus 4x4
<b>Storage</b>			
Centre console armrest with storage compartment	●	●	●
Storage under front seats	—	—	●
Door pockets - front and rear	●	●	●
Driver's and passenger's side vanity mirrors	●	●	●
Compartment with lid in roof console	●	●	●
Lockable glove compartment	—	—	●
Rear centre floor cup holders (2)	—	—	●
Bottle holders in front and rear door pockets	●	●	●
<b>Tray Body</b>			
Lashing rings for load restraining (4)	●	●	●
Cargo area light	●	●	●
12 volt socket	—	—	●
<b>Mechanical</b>			
Mechanical Differential Lock	○	●	●
6-speed Manual Transmission	—	●	●
8-speed Automatic Transmission	●	○	○
Rear Wheel Drive	●	—	—
Selectable 4MOTION Transmission (Standard with Manual)	—	●	●
Permanent 4MOTION Transmission (Standard with Auto)	—	○	○

## Optional Equipments

<b>Options</b>			
Rear differential lock	○	●	●
Front fog lamps	○	○	●
Discover Media audio and satellite navigation system	—	—	○
Bi-Xenon headlamps with integrated LED daytime driving lights	—	—	○
Privacy Tint - rear windows	—	—	○
Alcantara Pack Incl. Winter Pack (heated seats)	—	—	○
Alloy wheels (Korama) 16 x 6.5" with 245/70 R16	○	●	—
Alloy wheels (Cantera) 19 x 8" with 255/55 R19	—	—	○
<b>Paint</b>			
Metallic or Pearl Effect paint finish	○	○	○
<b>Option Packs</b>			
Vision pack - rear step bumper, rear park distance control and rear-view camera	—	●	●
Drivers pack - Front lumbar support, automatic headlights, rain sensing wipers and additional 12v socket	○	○	●

# Technical Specifications

Engine	TDI420 4x2	TDI400 4x4	TDI420 4x4
Type	4 cylinder Bi-turbo diesel, DOHC, 16 valve		
Cubic capacity, litres/cc	2.0 / 1,968		
Max power, kW @ rpm	132 @ 4,000	132 @ 4,000	132 @ 4,000
Max torque, Nm @ rpm	420 @ 1,750	400 @ 1,500 - 2,250	420 @ 1,750
Compression ratio	16.5:1		
Fuel system	Common Rail Direct Injection		
Exhaust emission control	Water-cooled exhaust gas recirculation (EGR), catalytic converter and diesel particulate filter (DPF)		
Fuel type (Recommended)	Diesel EN 590		
<b>Transmission</b>	<b>8 Speed Automatic</b>	<b>6 Speed Manual</b>	<b>8 Speed Automatic</b>
Driven wheels	4x2 Rear Wheel Drive	4x4 (4MOTION) Selectable	4x4 (4MOTION) Permanent
Gear Ratios	Final Drive: 3.70 1st Gear: 4.714 2nd Gear: 3.143 3rd Gear: 2.106 4th Gear: 1.667 5th Gear: 1.285 6th Gear: 1.00 7th Gear: 0.839 8th Gear: 0.667 Reverse Gear: 3.300	Final Drive: 4.10 1st Gear: 3.583 2nd Gear: 1.889 3rd Gear: 1.114 4th Gear: 1.00 5th Gear: 0.564 6th Gear: 0.473 Reverse Gear: 3.250	Final Drive: 3.70 1st Gear: 4.714 2nd Gear: 3.143 3rd Gear: 2.106 4th Gear: 1.667 5th Gear: 1.285 6th Gear: 1.00 7th Gear: 0.839 8th Gear: 0.667 Reverse Gear: 3.300
<b>Fuel Consumption~</b>			
Combined, L/100km	8.4	8.0	8.5
Urban, L/100km	10.0	9.2	10.1
Extra Urban, L/100km	7.6	7.3	7.6
CO <sub>2</sub> emissions, g/km	224	211	224
Fuel tank capacity, litres	80		
<b>Towbar Capacity**</b>			
Braked † kg	3,000		
Unbraked, kg	750		
Towball load limit, kg	300		

~Fuel consumption figures according to Australian Design Rules (ADR) 81/02 derived from laboratory testing. Factors including but not limited to driving style, road and traffic conditions, environmental influences, vehicle condition and accessories fitted, will in practice in the real world lead to figures which generally differ from those advertised. Advertised figures are meant for comparison amongst vehicles only.

\*\* With trailer brakes up to a gradient of 12%.

† Please note that Volkswagen Group Australia does not endorse or will not be held liable for any claim, loss or damage arising from the use or fitment of electronic trailer brakes.

# Technical Specification

## Chassis

Full-length ladder frame chassis in high strength steel

Fully galvanised body with 6 year anti-corrosion perforation warranty

## Running Gear

2.0 litre, 4 cylinder TDI

## Suspension

Front axle

Transverse link with A-frame arm double wishbone and anti-roll bar

Rear axle

Multi-layer rigid axle with leaf spring and stabiliser bar

## Steering

Power assisted rack & pinion steering

## Brake systems

Front, mm

303, Ventilated Discs

Rear, mm

292, Drum

## Brake systems

ESP, off-road ABS, ASR, EDL, Hill Holder, Brake Assist, Traction Control and Off-Road ABS including Hill Descent

## Turning circle, metres

12.95

# Measurements and Dimensions

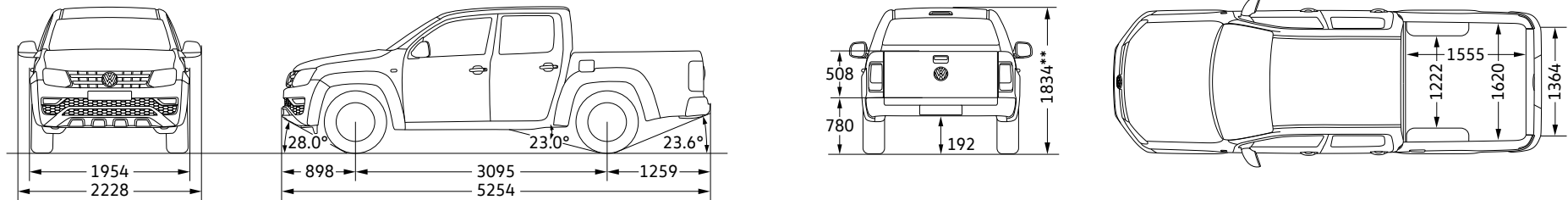

\*\*Maximum height excludes styling bar fitment

# Measurements and Dimensions

Weights <sup>#</sup>	TDI420 4x2	TDI400 4x4	TDI420 4x4
Unladen Mass Kg`s - DC 4x2	1,901	-	-
Unladen Mass Kg`s - Core	-	2,022	2,022
Unladen Mass Kg`s - Core Plus	-	2,052	2,052
Payload <sup>1</sup> kg - DC 4x2	1,139	-	-
Payload <sup>1</sup> kg - Core	-	1,018	1,018
Payload <sup>1</sup> kg - Core Plus	-	988	988
Gross Vehicle Mass (GVM) kg	3,040	3,040	3,040
Gross Combined Mass (GCM) kg	5,550	5,550	5,550
Roof load, kg	100	100	100
<b>Exterior Dimensions<sup>#</sup></b>			
Overall length mm	5,181	5,254	5,254
Width mm	1,944	1,954*	1,954*
Width incl. mirrors mm	2,228	2,228	2,228
Height, mm	1,820	1,834 <sup>^</sup>	1,834 <sup>^</sup>
Wheelbase mm	3,095	3,095	3,095
Ground clearance, mm	230	226	226
Entry angle	28.0°	28°	28°
Departure angle	28.0°	23.6°	23.6°
Ramp angle	23.0°	23.0°	23.0°
Wading depth, mm	500	500	500
<b>Tray Dimensions<sup>#</sup></b>			
Length, mm		1,555	
Width mm (Max.)		1,620	
Width mm (between wheel arches)		1,222	
Tail gate opening mm (Max.)		1,364	
Height (tail gate) mm		508	
load area m		2.52	
Height from ground mm		780	

\*Width includes wheel arch flares on Core Plus model only

<sup>^</sup> Core Plus models including styling bar

<sup>#</sup> Please note figures are sourced from overseas data where equipment levels by model variant may vary.

1. Payload is defined as the Gross Vehicle Mass (GVM) minus the Kerb Mass. Payload is the maximum combined weight of occupants, cargo, added structures and tow ball down weight (when towing). GVM must not be exceeded.

# Colours

## Solid paint finishes

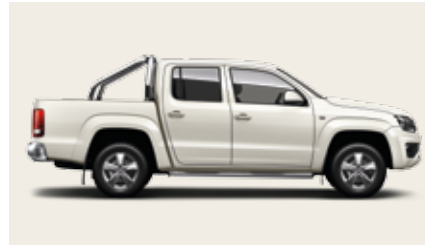

**Candy White** | Solid paint finish | B4B4



**Mojave Beige** | Metallic paint finish | 1B1B



**Indium Grey** | Metallic paint finish | X3X3

## Metallic and Pearlescent paint finishes



**Reflex Silver** | Metallic paint finish | 8E8E



**Starlight Blue** | Metallic paint finish | 3S3S



**Deep Black** | Pearl paint finish | 2T2T

## Seat upholstery



**Austin**  
Cloth seat upholstery | Titanium Black and Moon Rock Grey

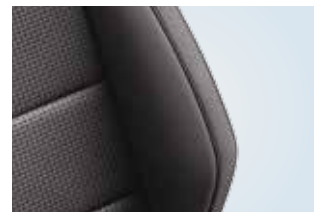

**Kemisu**  
Cloth seat upholstery | Palladium

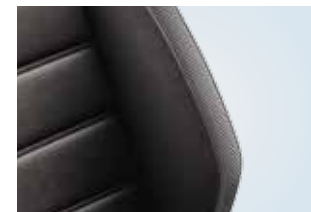

**Alcantara®**  
seat upholstery | Titanium Black

# General information

## Owning a Volkswagen

### **Volkswagen New Vehicle Warranty**

Every new Volkswagen vehicle is covered by a three-year unlimited kilometre manufacturer's warranty, which includes Volkswagen Assist (24-hour roadside assistance). Every new Volkswagen vehicle is also covered by a 3 year paintwork and 12-year anticorrosion perforation warranty. For further information regarding this New Vehicle Warranty, including pricing and terms and conditions, please consult your local Volkswagen dealer or visit [www.volkswagen.com.au](http://www.volkswagen.com.au)

### **Volkswagen Assist – 24-Hour Roadside Assistance**

As a valued customer, you can be assured that wherever you travel within Australia, you will have access to roadside assistance, 24 hours a day, 365 days a year. This is complimentary for the duration of the vehicle's original Volkswagen warranty period. You will receive help in the event of a breakdown or accident and, if required, your vehicle will be mobilised or transported to an Authorised Volkswagen Workshop. As a Volkswagen owner you will also have access to the additional benefits of accommodation and car rental if your vehicle cannot be mobilised within 24 hours, when you are over 100km away from home.

### **Volkswagen Genuine Parts®**

Volkswagen Genuine Parts® are designed for your vehicle and approved by Volkswagen, with particular regard to safety. The workmanship, dimensional accuracy and materials used in these parts comply with factory specifications. To ensure safety and reliability, Volkswagen recommends the use of Volkswagen Genuine Parts®. Volkswagen Authorised Dealers offer a two-year unlimited kilometre warranty on Genuine Parts from the date of purchase.

### **Volkswagen Financial Services**

Buying, borrowing or leasing, Volkswagen Financial Services will certainly make you think differently about financing and insuring your new Volkswagen. Committed to meeting the needs of Volkswagen drivers across Australia, we offer a range of leasing, financing and insurance products, each with distinct advantages depending on your specific circumstances. We can tailor a solution to suit your individual requirements, so you can rest assured that there will be no surprises along the way. Speak to your local participating authorised Volkswagen Dealer today to put together a solution that best suits your lifestyle.

### **Volkswagen Choice Guaranteed Future Value^**

Volkswagen Choice is a finance program available to approved applicants of Volkswagen Financial Services only, which provides Volkswagen owners protection around your Volkswagen's future value#, whilst offering a simple monthly instalment financing option. Enjoy the peace of mind of knowing the minimum value you can receive for your vehicle at the end of your contracted term. You can choose to either trade-in, return or retain your Volkswagen – it's your choice. Learn more about how to protect your investment by visiting [www.volkswagen.com.au/en/choice.html](http://www.volkswagen.com.au/en/choice.html) today.

### **Volkswagen Assured Service**

What you can expect as standard when servicing through our authorised Volkswagen dealer network is an expert team, trained by Volkswagen utilising specialist Volkswagen diagnostic equipment ensuring they're able to cater for all of your Volkswagen's servicing and repair needs. They also have access to the full Volkswagen Genuine Parts catalogue making sure any part replaced during a service or repair is replaced with a Volkswagen Genuine Part. What's more, your Volkswagen will be returned in immaculate condition, cleaned and vacuumed. Add these together and you can rest assured there's no better place to keep your Volkswagen running like a Volkswagen.

To find out more, go to [www.volkswagen.com.au/en/choice.html](http://www.volkswagen.com.au/en/choice.html)

---

^The Volkswagen Choice Program consists of an option to require Volkswagen Financial Services to purchase your vehicle at the end of your Volkswagen Financial Services Chattel Mortgage, Consumer Loan or Hire Purchase for a value (known as the Guaranteed Future Value) determined by Volkswagen Financial Services and set out in your contract. The Guaranteed Future Value is not a representation by Volkswagen Financial Services as to the likely market value of your vehicle as at the end of your contract. The option is available on new and demonstrator Volkswagen vehicles for selected models only. Please verify with your dealership vehicles that are eligible for the program. #If vehicles are not returned in an acceptable condition, as defined in the terms and conditions or exceed kilometre restrictions the Guaranteed Future Value will be reduced. See the Volkswagen Choice Fair Wear and Tear Guide for more information on the required conditions and circumstances. The cost of the Volkswagen Choice Program is incorporated into the applicable interest rate. Please read the full terms and conditions. Please consider whether these products and services are appropriate for your circumstances. Before acting on any of the information on this page, please seek independent financial and tax advice. Full terms and conditions are available upon application. Available only to approved applicants of Volkswagen Financial Services. Subject to credit assessment. Fees and charges apply. Fleet, government, rental buyers, hire car and chauffeur companies are excluded. Available at participating Volkswagen dealers. Volkswagen Financial Services is a trading name of Volkswagen Financial Services Australia Pty Limited ABN 20 097 071 460. Australian Credit Licence 389344.



# The Amarok

Volkswagen Group Australia Pty Ltd  
24 Muir Road Chullora NSW 2190  
ABN 14 093 117 876

Printed in Australia  
July 2017  
[www.volkswagen.com.au](http://www.volkswagen.com.au)

Publication: VWCAMARSPECMY17

Your Volkswagen dealer.

#### **Important information**

Apple CarPlay® is a registered trademarks of Apple Inc. Android Auto™ is a registered trademark of Google Inc. MirrorLink® is a registered trademark of Car Connectivity Consortium LLC. Bluetooth® is a registered trademark of Bluetooth SIG Inc. Alcantara® is a registered trademark of Alcantara S.p.A.

Volkswagen is distributed by Volkswagen Group Australia Pty Ltd, 24 Muir Road, Chullora, NSW 2190, ABN 14 093 117 876. Specifications are as planned at July 2017, for Model Year 17 and are subject to change without notice or obligation. All information in this brochure is correct at the time of publication, however variations may occur from time to time and Volkswagen, in so far as it is permitted by law to do so, shall not be liable in any way as a result of any reliance by any person on anything contained in this brochure. Authorised Volkswagen dealers will provide up-to-date information on model application, design feature, prices and availability on request. All colours are a general guide only, as the printing process cannot reproduce the actual exterior colour appearance. See your dealer to confirm colour/model availability.