

THE AESTHETIC PRINCIPLES OF SOUNDSCAPE IN
ARCHITECTURAL DESIGN AND BUILT ENVIRONMENT

A Thesis

by

KEDA WANG

Submitted to the Office of Graduate Studies of
Texas A&M University
in partial fulfillment of the requirements for the degree of

MASTER OF SCIENCE

May 2003

Major Subject: Architecture

THE AESTHETIC PRINCIPLES OF SOUNDSCAPE IN
ARCHITECTURAL DESIGN AND BUILT ENVIRONMENT

A Thesis

by

KEDA WANG

Submitted to Texas A&M University
in partial fulfillment of the requirements
for the degree of

MASTER OF SCIENCE

Approved as to style and content by:

Rodney Hill
(Co-Chair of Committee)

Chang-Shan Huang
(Co-Chair of Committee)

Mardelle Shepley
(Member)

Phillip Tabb
(Head of Department)

May 2003

Major Subject: Architecture

ABSTRACT

The Aesthetic Principles of Soundscape in Architectural Design and Built Environment.

(May 2003)

Keda Wang, B.Arch., Tsinghua University, Beijing, China

Co-Chairs of Advisory Committee: Prof. Rodney Hill
Dr. Chang-Shan Huang

This thesis is an attempt to establish a practical way for architectural designers to take advantage of the relationship between soundscape and architectural aesthetics. The whole study aides in providing a structural framework by which architectural designers could incorporate acoustic elements into their design, with aesthetic concerns rather than for practical purpose.

The discussions of soundscape and architecture forms are organized in the order of point, line, plane and space to present my personal observations on the issue. Three graphic systems are developed based on the previous researches of soundscape to visualize the coexistence of sonic identities and visual identities in built environment and how both of them interact to create a multi-sensory experience for visitors. Among the three systems, the Soundscape Map system is particularly introduced to demonstrate

some case studies where soundscape elements are successfully employed to strengthen the construction of architectural spaces and forms.

The goal of this research is to open a door for architectural researchers to discover the interconnection between soundscape and architecture, with the hope that the graphic systems introduced could be useful for effective designs with soundscape concerns in built environment.

DEDICATION

To my parents, for your endless love.

To my friends, Lei Han, Tieying Yu, Lening Zhang, Wenjian Sun and Hui Liu, for your support at my lowest point in the United States.

To Dr. Howard Fredrics and Mr. Kevin Patton, leading me to the realm of electronic music.

ACKNOWLEDGEMENTS

I greatly appreciate the guidance of my advisor and committee co-chair Dr. Chang-Shan Huang. He pointed out the direction for my thesis and always gave me his encouragement and trust. I've enjoyed my opportunity to benefit from his wide knowledge and deep thinking.

I am also grateful to my committee chair professor Rodney Hill, for his patience and tolerance. He kindly offered me the freedom to pursue my interest in such a new area of study.

I am grateful as well to Dr. Mardelle Shepley, the other member of my committee, and Professor Robert Warden, the coordinator of M.S. in Architecture program, for their flexibility and kind advice on my study.

TABLE OF CONTENTS

	Page
ABSTRACT.....	iii
DEDICATION.....	v
ACKNOWLEDGEMENTS.....	vi
TABLE OF CONTENTS.....	vii
LIST OF FIGURES	ix
LIST OF TABLES.....	xi
1. INTRODUCTION	1
1.1 Background.....	1
1.2 Problem Statement.....	3
1.2.1 Previous Research.....	3
1.2.2 My Project Scope.....	6
1.2.3 Objective of This Study	6
1.3 Methodology.....	8
1.3.1 Literature Review	8
1.3.2 Case Study	9
1.4 Significance	10
2. FUNDAMENTAL KNOWLEDGE OF SOUNDSCAPE	12
2.1 Basic Properties of Sound.....	12
2.1.1 Physical Properties of Sound	13
2.1.2 Other Properties of Sound.....	16
2.2 Three-dimensional Acoustic Environment	18
2.2.1 Directivity and Distance of Sound.....	21
2.2.2 Background and Foreground Sounds.....	22
2.3 Three Paradigm Systems for This Study	23

	Page
3. SOUNDSCAPE AND FORMAL AESTHETICS OF ARCHITECTURE	31
3.1 Basic Forms	31
3.1.1 Point.....	32
3.1.2 Line.....	37
3.1.3 Plane	48
3.1.4 Space.....	51
3.2 Soundscape and Organization of Spaces	55
3.2.1 Busy and Quiet Spaces	56
3.2.2 Silence	60
3.2.3 Soundscape and Spatial Relationships	62
3.3 A Case Study on Falling Water	67
4. CONCLUSION AND DICUSSION.....	71
4.1 Directions for Future Research	71
4.2 Limitations and Discussions	71
REFERENCES	74
APPENDIX	77
VITA	80

LIST OF FIGURES

FIGURE	Page
1. Classification of Architecture and Acoustics.....	4
2. A Single Cycle of a Sound Wave	12
3. A Generalized Source-Path-Receiver Model.....	13
4. An Example of Soundscape Map.....	24
5. Sound Perspectives	26
6. An Example of Soundscape Score.....	29
7. Point Elements in a Soundscape Map.....	33
8. Water Mirror	34
9. Center Fountain and Reflecting Pool.....	35
10. Elizabeth & Searcy Bracewell Clock Tower	36
11. A Pair Of Parabolic Listening Dishes.....	37
12. Linear Elements in Soundscape Map.....	38
13. Pebble Path and the Soundscape Score of it.....	39
14. Shallops.....	40
15. Indoor Space of Qiniandian, the Temple of Heaven.....	41
16. A Small Brook	42
17. Flying Sounds of Birds	43
18. Falling Water, Frank Lloyd Wright.....	44
19. Champ de mars	45

FIGURE	Page
20. Raindrops and Corridor	45
21. Tunnel	46
22. A Series of Three Wind Reeds	47
23. Sun Catchers	48
24. Aquarium	49
25. Soundscape Perspective of Noise Wall.....	50
26. Real Wall Reduces the Acoustic Space	51
27. Parabolic Bench	52
28. A Sound Play Musical Playscape	52
29. Another View of the Sound Play Musical Playscape	53
30. Echo Wall	54
31. Cylindre Sonore	55
32. Quiet and Busy Acoustic Spaces	56
33. Definition of a Quiet Space.....	57
34. John F. Kennedy Memorial.....	58
35. Acoustic Insulation	59
36. Rothko Chapel, Designed by Philip Johnson.....	61
37. Soundscape Map of Yi Yuan, Suzhou, China.....	63
38. A Sequence of Spaces with Different Soundscape Features	65
39. Soundscape Map of Falling Water.....	67
40. Sequence of Spaces in Falling Water.....	68

LIST OF TABLES

TABLE	Page
1. Study Issues on Architecture and Acoustics.....	5
2. Physical/Psycho-Acoustic Properties of Sound.....	15
3. A Rough Structure of Schafer's Catalogue of Classification of Sounds According to Referential Aspects	17
4. Some Sound Samples with Different Classifications of Basic Properties.....	19
5. Keynote, Signals and Soundmarks	23
6. Legend of Soundscape Perspective.....	28
7. Sonic and Visual Identities In Fig. 38.....	68

1. INTRODUCTION

1.1 Background

The sense of hearing cannot be closed off at will. There are no earlids. When we go to sleep, our perception of sound is the last door to close, and it is also the first to open when we awaken."[1]

In Architecture, visual experience is always regarded as a dominant perception for visitors and remains as a main concern to designers. The tool of visualization probably came out first and becomes the primary mode of design thinking in practice [2]. However, all individuals give form and definition to the world through multiple senses. We have ears, nose, as well as eyes to feel the world, touch the world and learn the world. In the book of *Experiencing Architecture*, the author Rasmussen suggested that people usually catch an overall impression of the buildings through their eyes but seldom realize all the perceptions that have contributed to that impression [3]. As many contemporary architectural researchers begin to launch their study on people's multi-sensory experience of architectural and other built environment, Soundscape, a new research subject that particularly concerns the auditory experience comes into being.

This thesis follows the style and format of *Leonardo*.

Soundscape, the environment of sounds, music, and noise that surrounds us, is a neologism coined by analogy with "landscape" by Canadian composer/author R. Murray Schafer in the late 1960s. He noted that:

Soundscape is the sonic environment. Technically, any portion of the sonic environment regarded as field for study. The term may refer to actual environments, or to abstract constructions such as musical compositions and tape montages, particularly when considered as an environment. [4]

Schafer's starting point was to pay attention on the dominance of the visual modality in society, which he called "eye culture" and to discover that the listening ability of children was facing the danger of deterioration. Later, Schafer compiled the result of his research and observations on the past history and present state of the neglected acoustic environment into a book, *Tuning of the World* in 1977. According to Schafer's research, the ear gave the priority to the eye back in the time of the Renaissance development of the printing press and perspective painting. As the world developed, sound becomes less significant and we suffer the loss of opportunity in experiencing natural sounds with each generation, partly because of the devastation of natural habitats. Under such circumstances, "sound becomes something that the individual tries to block, rather than to hear" [5].

Many researches on soundscape suggested a positive attitude for people to treat natural soundscape as a whole appreciation of acoustic experience rather than

eliminating those we do not desire to hear. Inspired by this point of view, I am trying to discover a new way to effectively use acoustic design, soundscape planning and composition of electronic music to strengthen the aesthetic expression of architectural or any other forms of environmental design.

Besides providing a new method for architects in their design practice, a systemically organized study on how the soundscape principles could contribute to the formal aesthetics of architectural designs is also part of the research issue.

1.2 Problem Statement

1.2.1 Previous Research

A soundscape is all the sounds within a given environment either made by human, by nature, or by both, when it occurs through dimensions of time and space. The sound source could be all sorts of individual things such as birds, crickets, tractors, wind, fireworks and waterfalls.

When the concern of soundscape goes to the field of architecture, many topics such as architectural acoustics, acoustic design, noise control and vibration control are within the study range that relates acoustic issues to building technology and architectural design.

As wrightson describes, soundscape could be classified into two groups [6]. Real Sounds, which are the sounds from the natural world, such as bird song and sea voices; Virtual Sounds, which are those intentionally made by human being to produce an exclusive virtual sonic environment, such as music, sonic sculpture, and film soundtracks. If we divide the architectural topics that are involved with acoustics and soundscape into two categories, according to their practical or aesthetic purpose, the previous researches on the issue of architecture and acoustic could be framed into such a structure (Fig. 1). I named all the relationships shown in the figure that are between Acoustics and Architecture from their initials, which are RA, RP, VA and VP. And the previous studies on each of the relationships are developed into a group of study issues that are presented in Table 1.

Fig. 1. Classification of architecture and acoustics

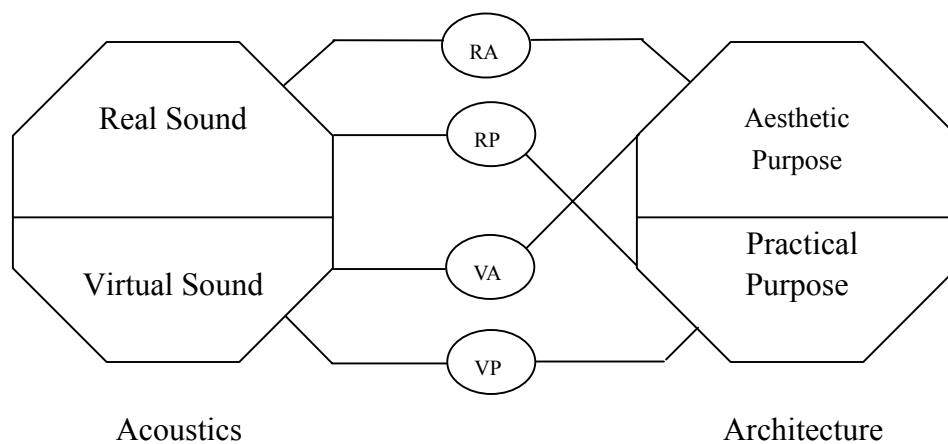

Table 1. Study issues on architecture and acoustics

Classification		Research subjects	Previous Researches
R A	The studies on the real sounds that happen in the built environment to reinforce or weaken the aesthetic experience of users.	Soundscape; Sonic sculpture	<i>“Schafer, R. Murray. Tuning of the world”</i> R. Murray Schafer (1977) [1] <i>Sonic Architecture</i> Bill & Mary Buchen (2002) [7]
R P	The studies on the real sounds that need to be dealt with for practical considerations in the built environment	Noise reduction; Noise control; Acoustic insulation; Vibration control	<i>“Acoustics: architecture, engineering, the environment”</i> Charles M. Salter Associates Inc. (1998) [8] <i>“Design for good acoustics and noise control”</i> John Moore (1979) [9]
V A	Virtual sound/ music that is used to inspire architectural design or support architectural presentation	Multimedia presentation for architectural design; Inspiration on design process; Making background music in the built environment	<i>“Architecture as a translation of music”</i> Elizabeth Martin (1995) [10] <i>“Sound: space”</i> Bernhard Leitner (1999) [11]
V P	Virtual sound/ music that has to be dealt with in practical considerations in architectural design	Architectural acoustics; Concert hall designs; Audio/visual issues	<i>“Acoustics and the built environment”</i> Anita Lawrence (1990) [12]

1.2.2 My Project Scope

Although there are different study topics being shown in the table above, the previous researches are mainly focused on the acoustic issues that relate to the functional perspective of architecture. In Copeland's article, *For an Awareness of Associations*, he noted that:

Sounds from the environment remain tucked away in the undervalued realm of functional utility. Once people can scrutinize their aural connection to other levels of experience, like for instance their emotional worlds, can sounds in turn be attributed with the potential to carry associative properties. [13]

For this reason, my study is getting into the more or less overlooked aspects of the research on architecture and acoustics, which is to discover the interrelationship between sound and the aesthetic perspective of architecture, as "RA" and "VA" listed in Table 1. Based on this classification, this study contains two parts of content, respectively concerning the relationship between each of the two types of soundscape and the aesthetic perspective of architectural studies.

1.2.3 Objective of This Study

Among the two categories, the former one (RA) is the main concentration of my research. The problem on how the natural soundscape/real sound could be used to affect people's aesthetic experience through built environment will be the central topic of my

study. Reading through the previous researches on RA issues such as Soundscape carried by Schafer, I seldom found detail discussions on the relationship between architectural aesthetics and acoustics. However, there are a lot of examples where acoustic environment contributes to the formal construction of the aesthetic quality of architectural environment in practice. Through the sounds of our steps, slamming doors and the wind blowing through the trees along the street, our appreciation of the beauty of architectural environment is strengthened. By finding these examples and categorize the way they are put into practice, I hope more attention will be drawn to this issue.

For the second issue (VA), the previous researches are also limited within a narrow range. Martin's book, *Architecture as a translation of music* [10] did arouse some interesting topics, but most of them are merely focused on the inspiration that music brings to architects, without digging into the more specific issues how music can be used in design process. Instead of drawing relationships between music and architecture in the design stage, I will focus my study on the application of virtual acoustic environment in multimedia architectural presentation stage. I believe, a multimedia project with the construction of virtual acoustic environment can bring exciting experience to the audience to present the design works convincingly and effectively.

1.3 Methodology

The whole research process is based on my literature review and summarization of the previous studies in soundscape, architectural aesthetic theory and multimedia production. With the incorporation of my personal observations, I will organize the discussion on acoustic issues and architectural forms in order of point, line, plane and space to demonstrate the formal aesthetics of soundscape and architecture.

1.3.1 Literature Review

The two main sources of my literature review are Schafer's *The Tuning of the World* (1977) [1] and Ching's *Architecture: Form, Space and Order* (1996) [14]. The former one is widely considered as the best known and the most comprehensive text on the subject of Soundscape and Acoustic Ecology. It has been recognized in many disciplines as a work which is going to have far-reaching effects on the future. A lot of the basic conceptions and terminologies of Soundscape and Acoustics, on which my research is built, are borrowed from this book. Considering the fact that the readers of this thesis are mostly in architecture background, I include the conceptions and terminologies in the Appendix as reference for readers.

Ching's book, *Architecture: Form, Space and Order* (1996), is also a classic reference for its concentrated area, architectural forms. As a comprehensive introduction

on the ways forms and spaces are interrelated and organized in the shaping of architectural environment, this book is valuable for my study for its well-organized structure on which the formal aesthetics of architecture is discussed.

I also collected some information and examples from the records of some design practices that successfully applied soundscape principles into their design concerns. These examples will be presented and discussed for the analysis of soundscape vocabulary and principles in Chapter Three.

1.3.2 Case Study

To support my study on the relationship between architecture and sound, I am working on the multimedia presentation for a design project directed by my thesis committee chair, Dr. Chang-Shan Huang. The final product is a multimedia project with a soundscape production which could be regarded as a piece of Electro-acoustic music. In the process of production, I carefully observe the path on which the virtual tourists are accessing the designed environment and montage some recording samples from the natural world such as leaves in the wind, fountain and stepping on the pebble paths, together to create a virtual acoustic environment to the audience. To meet the aesthetic need of hearing as well as create a virtual sound environment, I also produced some virtual soundscape, which is my own composition of electronic music with electronic

instrumental sounds. They are mixed with the natural soundscape together to help audience envision a virtual environment both acoustically and visually.

1.4 Significance

As people are resisting noise pollution by noise abatement, Schafer regarded it as a negative approach. He suggested us to seek a way to positively treat environmental acoustics as a study program. From judging the sounds around us whether we desire to hear them or like to eliminate them, our ears gradually lose the ability to hear, to positively perceive the soundscape as a total appreciation. The worse thing is that the majority of us might seldom notice that. In Schafer's book, *The Tuning of the World*, he suggested three aspects of importance his study may bring to people:

The home territory of soundscape studies will be the middle ground between science, society and the arts. From acoustics and psychoacoustics we will learn about the physical properties of sound and the way sound is interpreted by the human brain. From society we will learn how man behaves with sounds and how sounds affect and change his behavior. From the arts, particularly music, we will learn how man creates ideal soundscapes for that other life, the life of the imagination and psychic reflection. [15]

By implementing this study, I will try to lead my readers to the realization of the importance of soundscape contributing to the whole aesthetic experience of architecture. Hence preserve the hearing ability as an indispensable part when we perceive the world.

For architectural designers, by digging into the relationship between architecture and music, this study might present a new point of view to them to discover the inner rule of some aesthetic principles of architecture, especially in the subjects of form, space and order. Also, this study aims to provide architects with acoustic aid to present their design more effectively and strengthen the ideas of design with more inventive and diversified ways.

For people enjoying the architectural or other built environment, this study is trying to reveal the fact to them that the best way for people to eliminate noise pollution without the degeneration of listening ability is to appreciate the acoustic environment as the resources for improving the orchestration of the world soundscape. [16] Hopefully, this study will draw more attention from the public to the issues.

2. FUNDAMENTAL KNOWLEDGE OF SOUNDSCAPE

2.1 Basic Properties of Sound

As we all know, sound is created by vibrating bodies in the form of waves. When the sound wave propagates in the air, the vibration of air molecules is activated to create compression, which refers to an area of greater than the normal atmospheric density and rarefaction, which refers to an area of less than the normal atmospheric density. The tension between compression and rarefaction areas pushes the sound wave move through from high pressure areas to low pressure areas (Fig. 2). [17]

Fig. 2. A single cycle of a sound wave

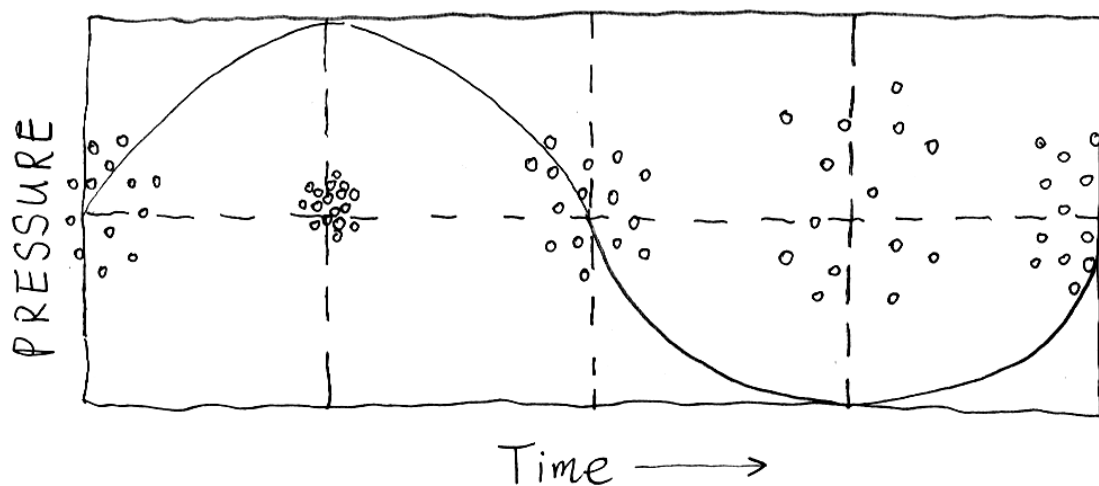

Besides air, the medium of transmission of sound can also be water, solid, or a combination of all, involving a conversion to vibration and back to the sound. A chain of sound events originated from sound source to listener through a path which is made up of the environment encompassing all the three elements (Fig. 3). [18]

Fig. 3. A generalized source-path-receiver model

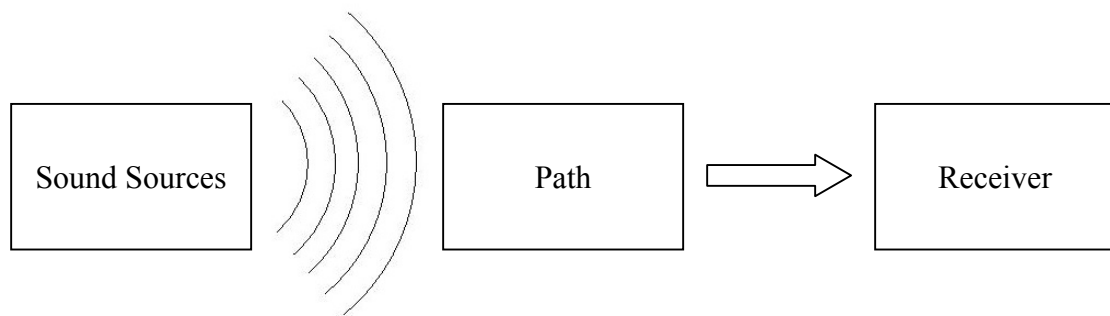

For reader's convenience, the glossary of terminologies of sound could be found at Appendix as reference.

2.1.1 Physical Properties of Sound

The basic properties could be categorized in to physical properties, semantic component and aesthetic attributes. *In The Tuning of the World*, the author suggested that there are four basic properties of any sound events: 1) Duration; 2) Frequency/Mass; 3) Fluctuations/Grain; 4) Dynamics. Except the other three properties that are easy to

understand, **Fluctuation/Grain** is defined as “a special type of internal fluctuation, one with a regular modulatory effect. It consists of Tremolo (Amplitude modulation), Vibrato (frequency modulation). [19]

If we look at the third (Fluctuations/Grain) and fourth (Dynamics) properties Schafer presented here, we will find that they share an identical feature, which is, they are more or less related to *envelop* of sound. As envelope is actually a mixture measurement of time and amplitude, the only difference between Fluctuations/Grains and Dynamics lies in the different time scales at which they refer to a sound event: Fluctuations/Grain is used to describe the detail texture of *envelop* while Dynamics concern the whole shape of *envelop*.

According to *The Art of Mixing*, the basic physical components of sound include: volume (or amplitude), frequency, and time [20]. This idea also works for Schafer’s four property theory: the first property of Schafer’s, Duration is about *time*; the second, Frequency appears in both theories; the third and fourth is based on *time* and *volume* as mentioned above.

Based on these three basic components, almost all the measurements and physical attributes of sound and music could be found. The only exception is, in my opinion, *directivity* of sound. The physical properties and their basic components are listed in

Table 2. From the table, we can also find the psycho-acoustic measurements which relate to human auditory perceptions.

Table 2. Physical/Psycho-acoustic properties of Sound

Basic Physical Properties	Components	Psycho-acoustic measurements
Frequency	Frequency	Pitch
Spectrum	Frequency/Volume	Tone/Timbre
Duration	Time	Duration
Envelope	Frequency/Volume/ Time	Envelope
Reverbs/Delays	Frequency/Volume/ Time	Reverberation/Echo
Sound Pressure Level	Volume	Volume/Loudness/Intensity
Dynamic	Volume/Time	Dynamic/Expression
Directivity	Directivity	Directivity/Stereo/Spatial feelings
Fluctuations/Grain	Time/Volume	Texture
Distance	Frequency/Volume	Presence
Reverberation Time, Spectrum	Frequency/Volume	Clarity

2.1.2 Other Properties of Sound

Besides physical properties introduced in the last section, sounds may also be classified in several other ways. Now let us think about these questions. Why do people feel more restless when they hear the sound of telephone compared with the sound of flute music with same volume and frequency spectrum? Why do people feel relaxed when they hear the sound of bird song compared with the sound of siren with similar physical properties? Why do people appreciate sea sound more than industrial noises even if they have similar segments of sound samples?

These questions bring out the issues of semantic properties of sounds, which refer to the function and meaning of sounds. In the World Soundscape Project led by Schafer in 1977, he presented a framework in which he gathered information about past soundscape through earwitness accounts by some volunteers. He then made an extended card catalogue which describes soundscape in terms of literary, anthropological and historical aspects [21]. Table 3 shows a rough frame of the card catalogue.

Table 3. A rough structure of Schafer's catalogue of classification of sounds according to referential aspects [21].

Natural Sounds	Sounds of Water	Oceans, Seas and Lakes
		Rain
		Rivers and Brooks
		Steam
		Ice and Snow ...
	Sounds of Air	Wind ...
	Sounds of Earth	Trees...
	Sounds of Birds	Sparrow ...
	Sounds of Insects	Flies...
Sounds of Seasons ...	Spring...	
Human Sounds	Sounds of Voice, Body ...	Speaking...
Sounds & Society	Town, Urban, Factories, Domestic Sounds, Parks...	...
Mechanical Sounds	Machines, Aircraft, Constructions
Silence and Quiet	-	-
Sound as Indicators	Bells, Horns, Telephones

And finally, we can sort sounds according to the aesthetic qualities they have. Due to the different feelings and opinions held by different individuals towards same sounds, it is really hard to give a definite suggestion on the aesthetic classification of soundscapes. People's evaluation of sounds can be easily affected by their regional background, working environments and personal experiences. Although the study of this problem is widely considered to be too subjective to yield meaningful results, we can still analyze some soundscape with classification of physical properties, semantic properties and aesthetic qualities [22].

2.2 Three-dimensional Acoustic Environment

The imagination of three-dimensional acoustic environment is mostly discussed in the topic of recording technology. These discussions are also useful for the study of real

Table 4. Some sound samples with different classifications of basic properties [22].

		Telephone Bell	Car Horn	Bird-Song	Kettle Boiling
A c c o u n t i c s	Intensity (SPL)	75 dB	90 dB	60 dB	60 dB
	Distance	3 meters	100 meters	10 meters	1 meters
	Distinguishability	Heard distinctly	Heard distinctly	Heard distinctly	Indistinctly
	Ambiance	Hi-Fi, human	Hi-Fi, technological	Hi-Fi, natural	Lo-Fi, human
	Repetition	Repeated	Isolated	Part of extended song	Steady-state
	Reverberation	No	No	No	No
	Frequency	≈ 2k Hz	≈500 Hz	≈ 5k Hz	Narrow band 8k+ Hz
Semantics	Telephone signal	“Get out of my way!” “I’ve just married!”	Clear day, morning	Tea is on.	
Aesthetics	Not very pleasant	Annoying, unpleasant, Festive, exciting	Pleasant, beautiful, festive	Pleasing	

acoustic environment. Without looking at the physical sound sources, people still tend to imagine the apparent placement of sounds. The study on the aural perception of blind persons by Copeland discovers that the acoustic environment presents the world as it exists outside the blind person's body, therefore he or she can determine his or her surroundings by paying attention on the typical sound patterns, such as traffic sounds.

Copeland noted that:

To give a different example of how sounds photograph the space around one, there is a large clock tower at the University of Birmingham. The tolling of that clock sounds different wherever one happens to be on campus. This is due to the physical distance between listener and bell, as well as the varying ratios of direct and reflected sound. It is also due to the types of echoes and reverberations heard in different outdoor spaces, as well as the effects of masking in particular areas. Every time the clock strikes a different person gets a unique acoustic impression of structures normally considered to be immobile and silent. Flash, the bell strikes, and one has an exemplification of how sound expresses both time and space in the same snapshot of existence. Interestingly, the buildings play as much of a role in the composition of this snapshot as the tolling bell. [13]

This example brings out an important conception of three-dimensional acoustic environment, *directivity/distance* of sound.

2.2.1 Directivity and Distance of Sound

As introduced in the section 2.1, *directivity* describes the angle of coverage of aural perception both in the vertical and horizontal planes [23]. The level difference between the sound events received respectively by our two ears forms an impression of directivity from the sound source. Usually, people can locate the sound sources for the measurement of left and right better than front and back.

Besides, we can distinguish the distance of a sound source both by the sound level and the spatial feeling it brings to us. Why both? Let us assume that we are in a spacious outdoor square. The sounds we hear are seldom reflected by surfaces and mostly absorbed by receivers or sent to the sky and distant sites. Without much reverberation involved, we can tell out the distance of a sound source by its volume compared with the background acoustic environment. But if we are indoors, for instance, in an entry hall of an office building, we receive both sound events directly from the sound source and those reflected by walls, windows and other indoor surface. Under this circumstance, the level differences between all the sound sources in the hall are relatively subtler than the outdoor acoustic environment. We perceive a sound event to be closer to us if it has less reverberation than the sound events with more reverbs.

Another factor that contributes to the spatial perception of sound is frequency spectrum. Generally speaking, the sounds within narrower bandwidth that has more

middle range of frequency response are more present to our ears. Schafer's definition on Hi-fi and Lo-fi soundscape is actually about the frequency spectrum that affects the impression they bring to people's ear.

Schafer used the term hi-fi (high fidelity) to identify the pre-industrial acoustic environment and lo-fi (low fidelity) to characterize the post-industrial one. The former is defined as an environment where sounds overlap less frequently and has more feeling of perspective which clarifies the soundscape of foreground and background [24].

2.2.2 Background and Foreground Sounds

In Schafer's book, *The Tuning of the World*, he defined background sound as *keynote*, which he borrowed the conception of keynote from music to indicate the fundamental tonality of the soundscape background; foreground sounds were termed *sound signals* to identify the sounds that intended to draw attentions from visitors. With a higher hierarchy than *keynote* and *sound signals*, *soundmarks* was introduced to describe the particularly regarded sounds by a community [24]. (Table 5)

Table 5. Keynote, signals and soundmarks [24].

	Definition	Psychological	Examples
Keynote Sound (Background)	They are not listened to consciously; They are overheard but cannot be overlooked.	Ground	Water, Wind, Forest, Plains, Birds...
Signals (Foreground)	They can be listened to consciously.	Figure	Train Whistles, Ship Whistles, Bell, Horns...
Soundmarks (Most noticeable)	They are sounds that is specially regarded or noticed by the people in a certain community.	Landmark	Virtuoso drumming of the Austrian bureaucrats with their long handled rubber stamps.

2.3 Three Paradigm Systems for This Study

In Chapter Three, I will discuss how the soundscape principles could be put into use in architecture practice. To better demonstrate the specific problems in these case studies and illustrate the technical details that are involved in the recording technology to reproduce the acoustic environment for audience, three paragraph systems are going to be employed developed from previous researches.

Fig. 4. An example of Soundscape map

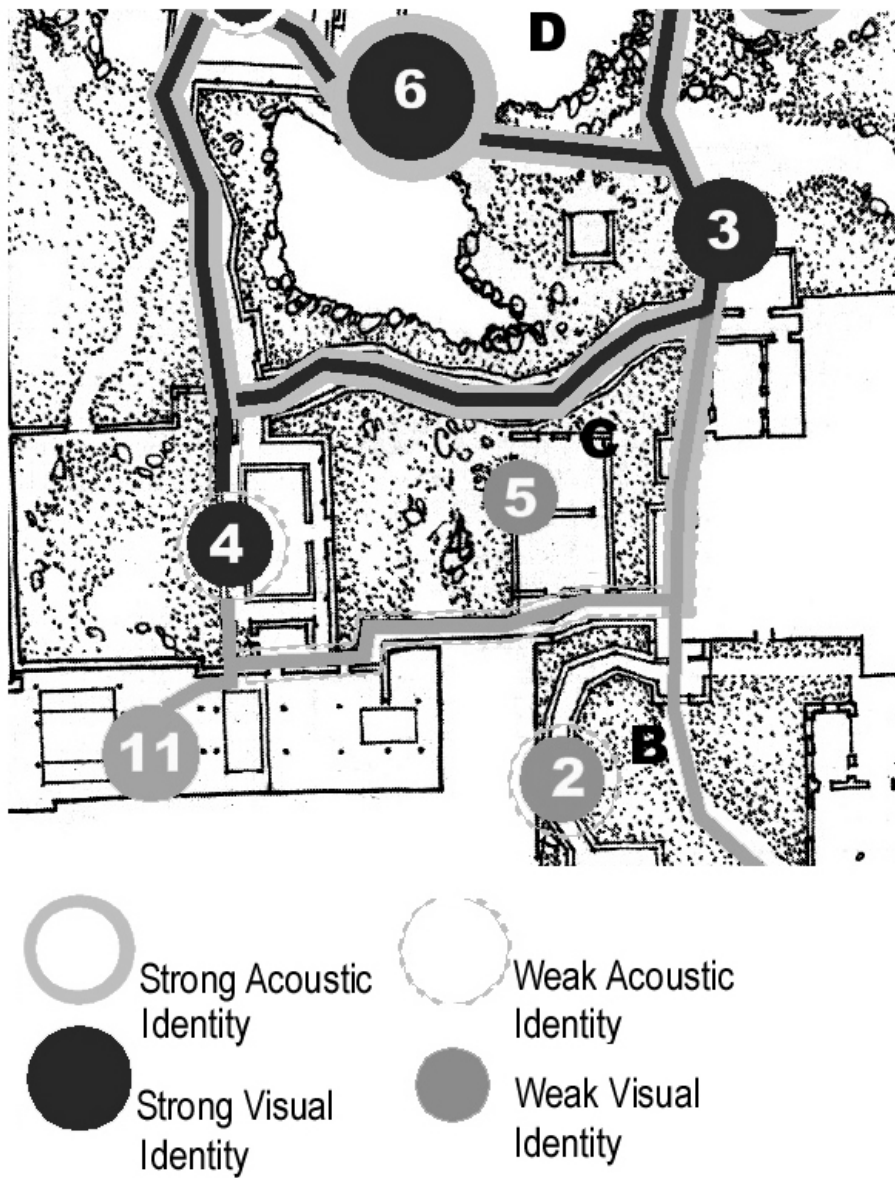

The first one, which I call it “Soundscape Map”, is developed from Michael Southworth’s drawing of sound event map, which appears in Schafer’s book, *the tuning of the world* [25]. It could effectively demonstrate the sonic identities that mixed with visual identities to form a whole aesthetic experience for visitors. (Fig. 4)

The second one, which I call it “Soundscape Perspectives”, is a system to visualize the acoustic space around an audience. It is developed from Gibson’s study in *The Art of Mixing: A Visual Guide to Recording, Engineering, and Production* [26]. It is particularly useful when we use recording technology to reproduce the sonic environment for soundscape design. As I explained above, soundscape itself can create a virtual acoustic space for people without aid of vision. With a pair of speakers in front of us, the acoustic environment is reproduced to display almost all the sound objects around us with their direction, distance, height and weight. The Soundscape Perspective system can indicate a lot of physical attributes of sound objects (spheres in the diagram) such as directivity, volume and frequency (Fig. 5) (Table 6).

Fig. 5. Soundscape Perspective

a) Soundscape Perspective can show the volume (by the size of spheres), frequency (by the height of spheres on the y-axis), distance (by the location of spheres on the z-axis), directivity (by the location of spheres on the x-axis) and clarity (by the brightness of spheres)

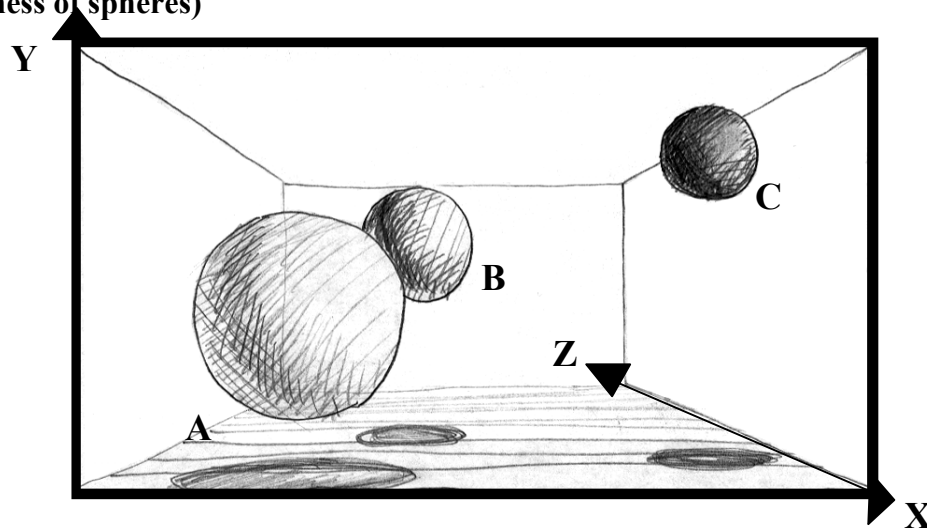

b) The plane in the back of the space stands for background sound, or we can call it *keynote* sound, compared with the foreground sound or *sound signals* (object A and B in the diagram). It is usually a noise wall taking a wide range of frequencies.

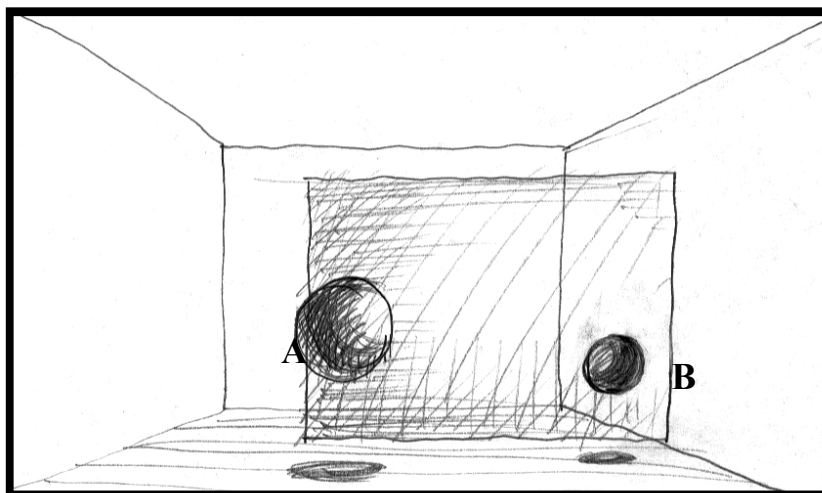
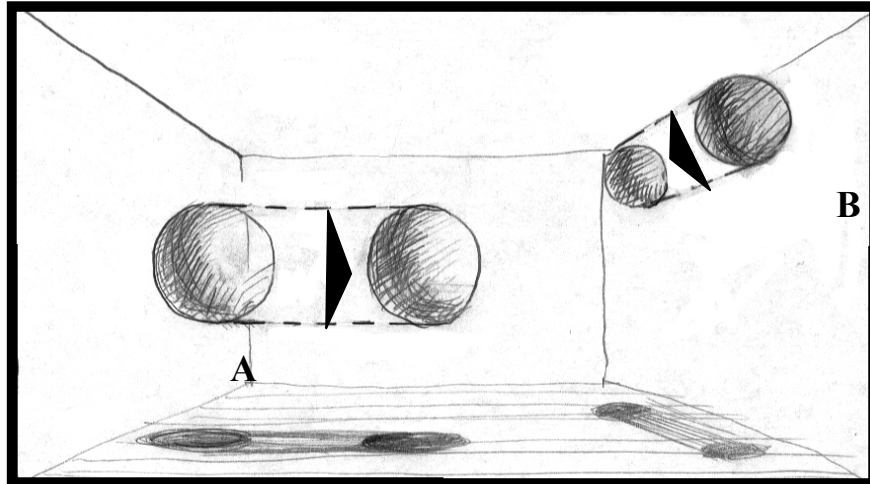

Fig. 5. Continued

c) The movement of sound objects could be indicated here by the pairs of spheres with arrows to show the direction of the movement.



d) The flattened spheres shown in the diagram (object A and B) here symbolize the sound objects that are more or less transformed due to sound reflection or diffusion. They do not come from direct sound sources. In recording technology, these objects also represent the sound events that are processed by effects such as Chorus, Reverb or Flanger.

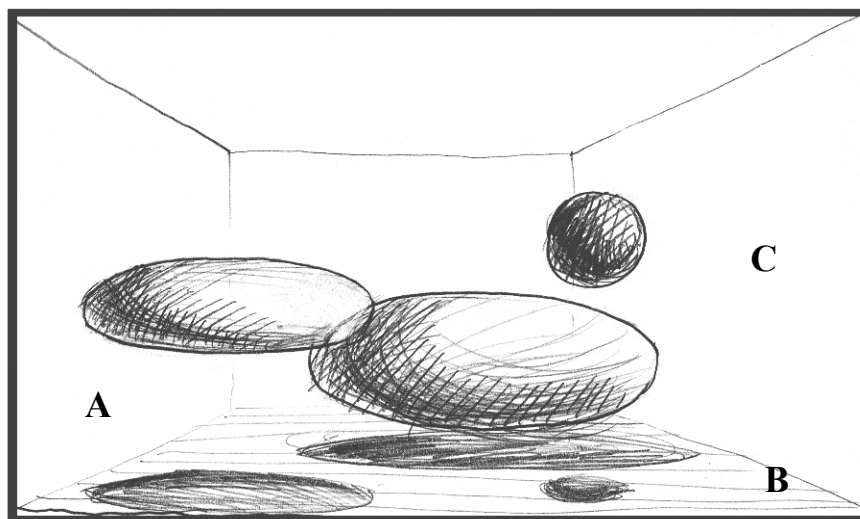

Table 6. Legend of soundscape perspective

Physical Properties	Representation	Examples in Diagrams
Frequency	Height on <i>y</i> -axis	A vs. C in Fig. 5 a)
Distance/Presence	Location on <i>z</i> -axis	A vs. B in Fig. 5 a)
Clarity	Brightness of spheres	A vs. C in Fig. 5 a)
Movement	Pairs of spheres with arrows to indicate the direction	A and B in Fig. 5 c)
Reverbs/Delays	Flattened spheres	A and B in Fig. 5 d)
Amplitude/SPL	Size of spheres	A vs. C in Fig. 5 a)
Background noise	Standing planes	The plane in Fig. 5 b)
Directivity	Location on <i>x</i> -axis	A vs. C in Fig. 5 a)

The third one is “Soundscape Scores”, established by my own due to the reason that the former two systems cannot indicate the time factor, which plays a very important role in soundscape designs. (Fig. 6) As shown in the Figure 6, the density of object lines

shows the rhythm and texture of those sound objects if they are not continuous. If the sound event appears temporarily, such as the object A in the figure, the left end of the object line won't touch the left edge of the frame. Besides, as same as the system of Soundscape Perspectives, the distance between the vertical gray strip on the right and those arrows along the z-axis identifies the presence of sound objects; the order they are arranged along the y-axis is decided according to their fundamental frequency.

Fig. 6. An example of Soundscape Score

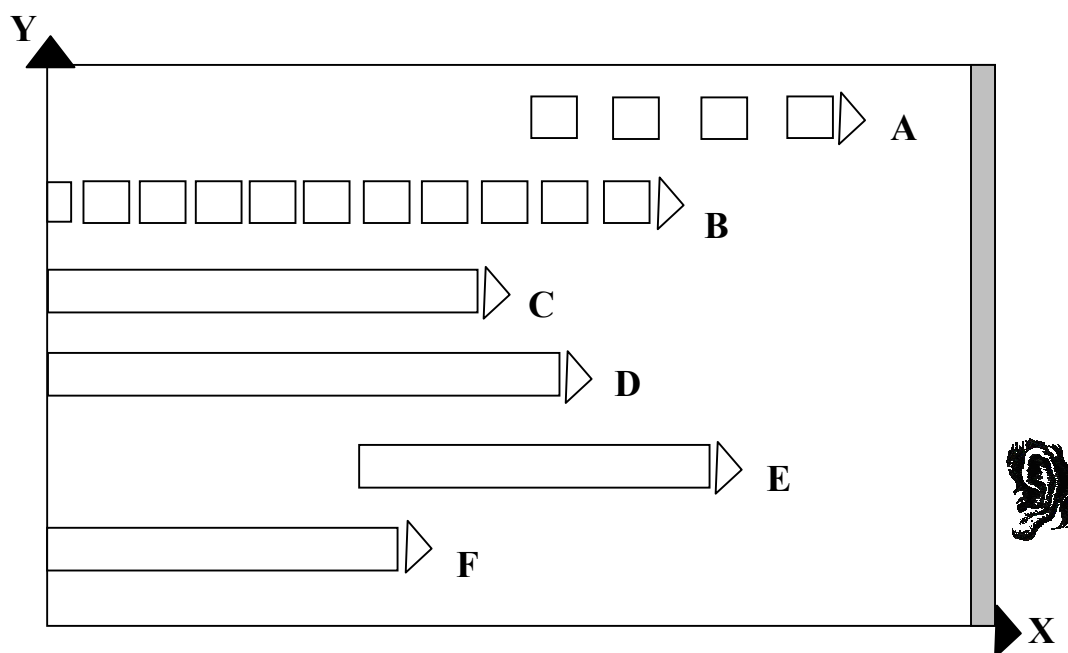

- A:** high frequency, present, low density and temporary sound;
- B:** Higher density, enduring sound;
- C, D:** Continuous sound;
- E:** Temporary, continuous sound, present;
- F:** Low frequency, continuous background sound

These three diagram systems will be used for different purposes in the following chapter to demonstrate the discussions of some case studies. Soundscape Maps will mostly be used in the design stage for the whole planning of soundscape designs. Soundscape Perspectives and Soundscape Scores are more into detail problems and mostly used in the presentation stage for the reproduction of acoustic environment.

3. SOUNDSCAPE AND FORMAL AESTHETICS OF ARCHITECTURE

In this chapter, I will elucidate the soundscape principles that are applied to design practice both in architecture and landscape architecture. Besides giving examples of some case studies that I made to demonstrate how soundscape design works to strengthen the visual aspect of aesthetic experience in architecture, this chapter will also talk about some technical details in the reproduction of soundscape in design process and multimedia presentation stage. Some discussions may be beyond the range of architectural design, but are useful for obtaining a whole understanding of the relationship between soundscape and the environment around us; no matter it is natural or man-made.

3.1 Basic Forms

Architecture is regarded as a three-dimension visual art, because it has primary elements of form “in the order of their growth from the point to a one-dimensional line, from the line to a two-dimensional plane, and from the plane to a three-dimensional volume” [27]. One feature that differentiates architecture from another three-dimension art, sculpture is that the primary elements of architecture exists both in forms of solids and cavities, or we call entities and spaces.

When made visible to the eye on paper or in three-dimensional space, these elements become form with characteristics of substance, shape, size, color and texture. As we experience these forms in our environment, we should be able to perceive in their structure the existence of the primary elements of point, line, plane, and volume [27].

Now let us discuss the application of soundscape in strengthening people's perception of these primary elements in the alphabetical order of point, line, plane and volume.

3.1.1 Point

A sound source itself defines a point. If it comes along with an object which exists in the environment as an active element, the cross-perceptual experience will add up to its visual dominance of the space.

Water Mirror

In the graphic system of Soundscape Maps, I used round dots to define the sonic identities that accompany with visual identities, which are represented by dashed circles. (Fig. 7)

Fig. 7. Point elements in a Soundscape Map

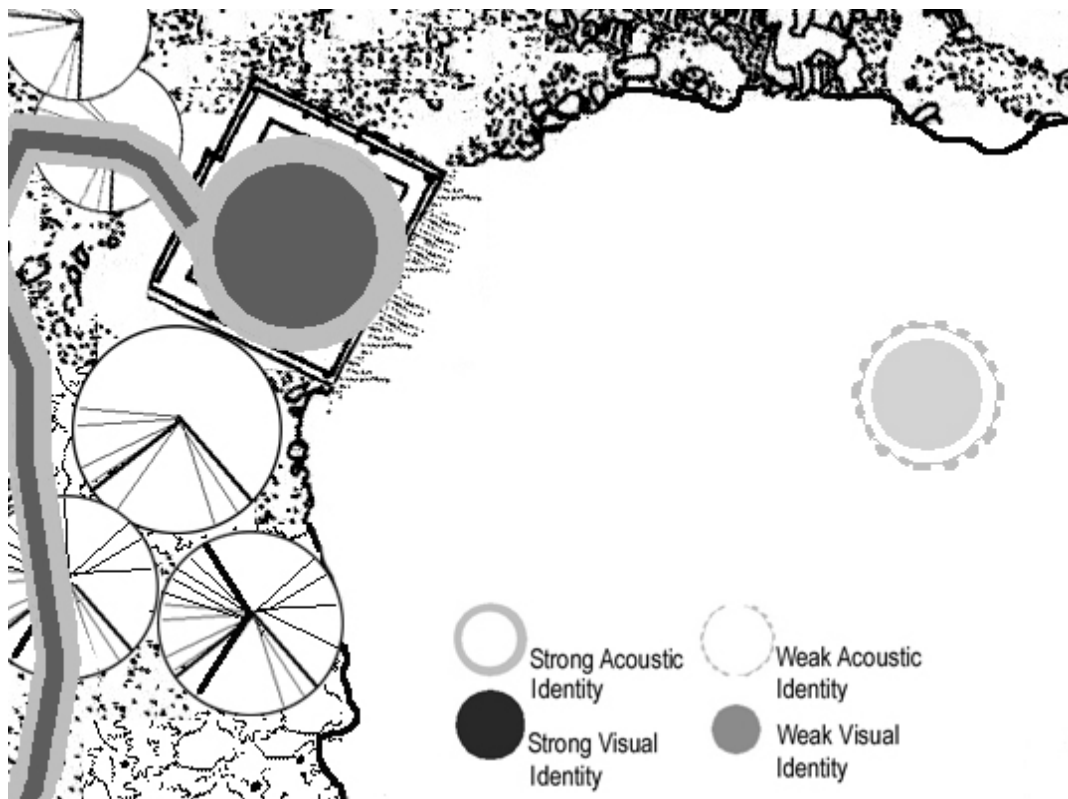

This Soundscape map is actually describing an acoustic design by Bernhard Leitner, called Water mirror. Designed for Danube temple located at Donaueschingen, the designer suspended a flat metal vault between the four columns to focus and amplify the sound of water falling into the Brigach. Thus acoustic meaning is added to the visual attraction of Danube temple on the side of Brigach [28]. (Fig. 8)

Fig. 8. Water mirror. (Donaueschingen, Germany, acoustic design by Bernhard Leitner) [28].



Fountain

When the main *sound signal* is from a visual identity, its function as a focus in a certain space is obviously strengthened (Fig. 9).

Fig. 9. Center fountain and reflecting pool. (University at Albany, New York)



Clock Tower

Clock towers don't make sound all the time, but the ringing sounds of bells are always part of an integrated figure of clock tower to people. Clock tower, together with the ringing sounds of bells is usually a dominant point both visually and acoustically in a square, playground or other public areas. In a sense, the sounds of clock tower are *Soundmarks* more than *Sound Signals* for they bring certain meaning and cultural containing to the soundscape enclosing it (Fig. 10).

Fig. 10. Elizabeth & Searcy Bracewell clock tower (Texas A&M University, Galveston, TX. 2003)



Sonic Sculpture

It is definitely a good idea to let sculptures sing along with their visual beauty to attract attention from visitors as well as decorating the outer space (Fig. 11).

Fig. 11. A pair of parabolic listening dishes. They are for the entry plaza of the Children's Museum of Richmond, VA. Designed by Son Arc / Bill + Mary Buchen [7]



3.1.2 Line

Lines in architecture are the active elements to describe path and express draw direction, movement and growth. They link different points as well as describe edges between spaces [29]. For soundscape, the linear elements sometimes are those continuous and enduring sound events that go along with us. In the paradigm system of Soundscape Maps, the linear sonic elements are usually coming along with visual elements (Fig. 12).

Fig. 12. Linear elements in a Soundscape map

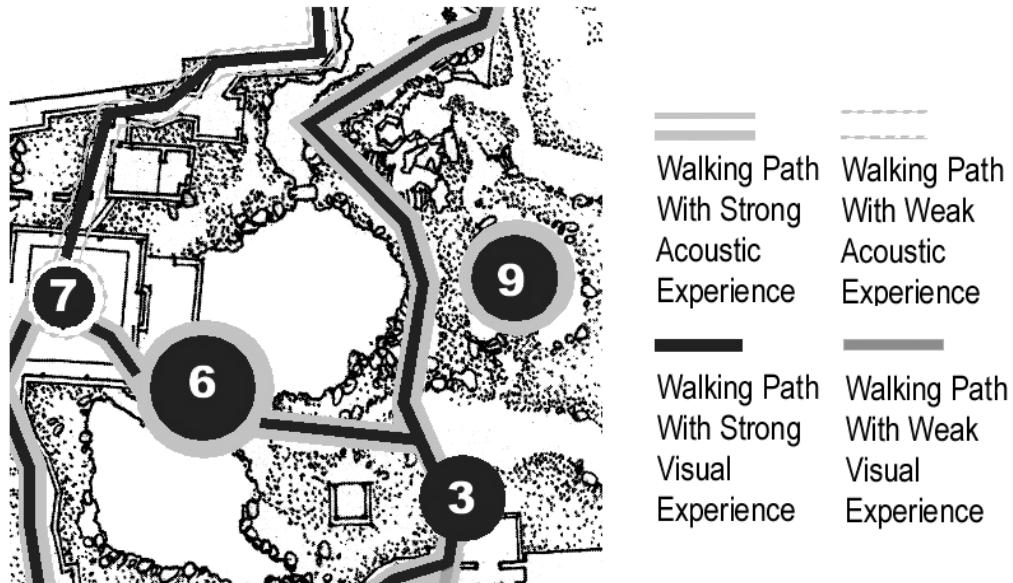

Pebble Path

Walking on a pebble path, the sounds coming underneath our feet constitute a linear element for they record our movement and express the direction to the next position. The rhythm of the sounds created by our feet adds texture to this line (Fig. 13). Similar examples are: shallops (Fig. 14).

Fig. 13. Pebble path and the Soundscape score of it

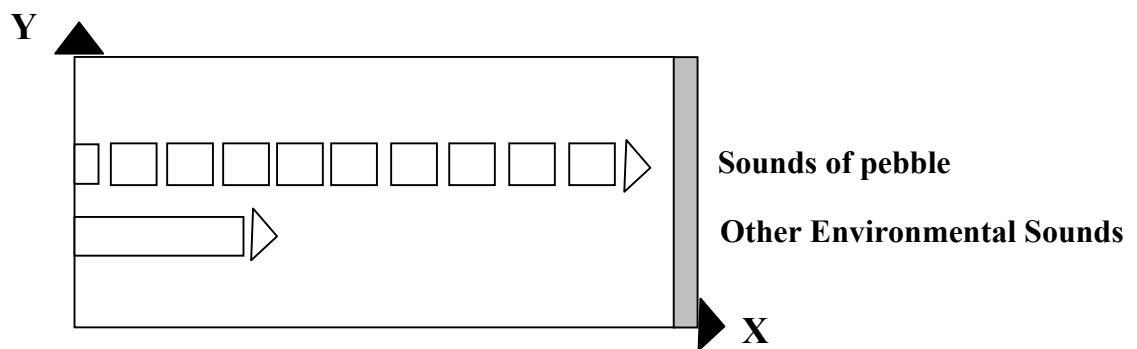

Fig. 14. Shallops



Vertical Line

The soundscape in uplifting space such as the indoor Qiniandian at the Temple of Heaven, Beijing (Fig. 15), is mixed with various reverberations due to the reflection and diffraction of sounds. It creates a feeling of sublimity and awe-inspiration which suits the purpose of this imperial palace very well.

Fig. 15. Indoor space of Qiniandian, the Temple of Heaven (Beijing, China)



Edge

Lines define the edge between two spaces. Sometimes soundscape becomes a strong support (Fig. 16).

Fig. 16. A small brook



Moving Sound Objects

When sound objects move, they make the acoustic environment around us more dynamic and lively. Our attention on visual attractions is sometimes distracted by these moving sound objects. The vivacious soundscape of animal sounds is a good example, which reminds us of the natural environment that encloses us (Fig. 17).

Fig. 17. Flying sounds of birds



Extension of Space

The distant sound object can sometimes act as an extension of the space where we are walking through and it implies the direction where we are going to (Fig. 18). In Falling Water, the architect Frank Lloyd Wright's famous work, people hear the sounds of falling water even before they get the whole image of the building. It is water that leads them to the goal.

Fig. 18. Falling Water, Frank Lloyd Wright



Alameda

The soundscape of the parallel trees along an alameda is like a piece of military march, especially where there is wind blowing through the trees (Fig. 19, 20). A similar example is the sound of raindrops down from the eaves of a corridor.

Fig. 19. Champ de mars

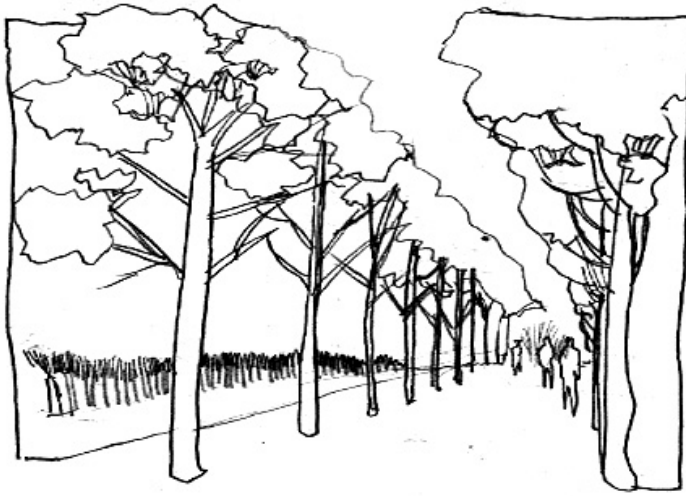
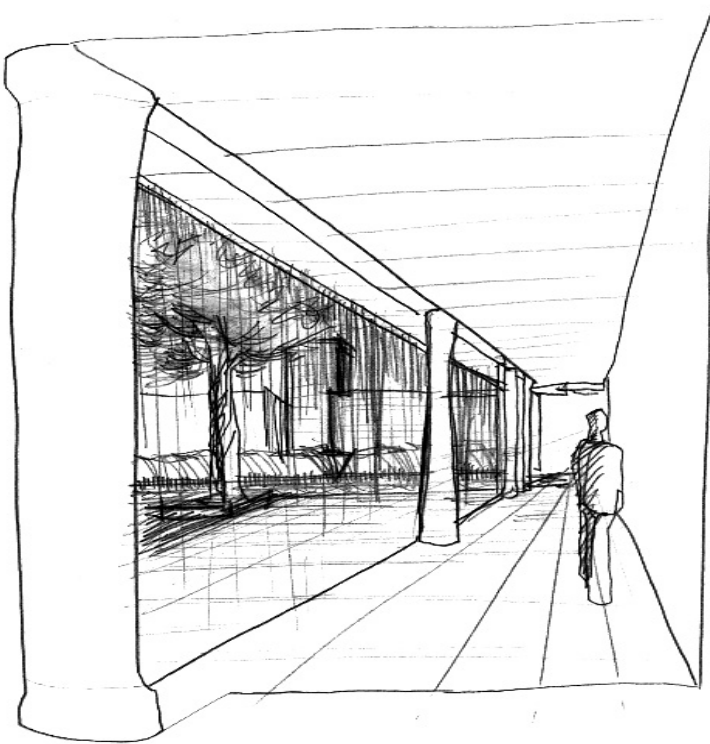

Fig. 20. Raindrops and corridor



Tunnels and caves

The soundscape in tunnels and caves may not be desirable, but it is full of mystery and unexpectedness. Every sound you make now is being echoed and amplified, even your heart beat. The most striking *sound signal* is generated from our footsteps. The soundscape of tunnels and caves can be found in Hollywood adventure and Sci-Fi movies (Fig. 21).

Fig. 21. Tunnel



Sonic Sculpture Sequence

In this example, a sequence of wind reeds produces linear sound events to lead visitors into the museum (Fig. 22). The desirable, high pitch sounds hanging in the sky help create a pleasing and festival atmosphere for the outer space in front of the museum [8].

Fig. 22. A series of three wind reeds. They are at the entry plaza of the Children's Museum of Richmond, VA. Designed by Son Arc / Bill + Mary Buchen [7]



Sun Catchers

Fig. 23 shows another similar project that is also designed by Buchens. Five wind-driven musical sculptures were installed to create a sequence of *sound signals*. The sounds are connected to produce certain rhythm driven by the power of the wind and the propellers spin out a mirrored landscape and sky. These Suncatchers are tuned to a pentatonic scale, universal to African, Asian, and American Blues musical traditions. The speed and direction of wind determines note timings and sequence, generating a chance-operated composition. There is a chaos factor built into the mallet mechanism,

causing "skip" on some rotations, producing periods of silence into the musical composition [7].

Fig. 23. Sun catchers. (Arizona Science Center, Phoenix.1997) [7]

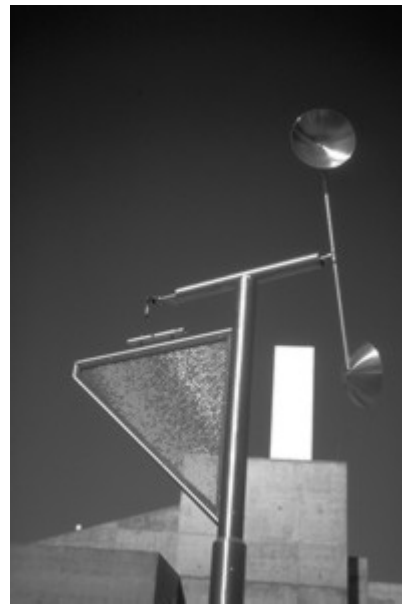

3.1.3 Plane

In soundscape, planar elements include both planar sound sources such as waterfall and sound walls that mask other sound objects.

Waterfall

Waterfall is such an attractive natural figure as well as soundmarks that many architect want to take advantage of it. But nobody got more success than Frank Lloyd Wright's Falling Water (Fig. 18).

Aquarium

As a planar visual attraction, the crystal blue of aquarium is accompanied with a very special soundscape. It is recognized for the muffled sea sounds and fish voices (Fig. 24).

Fig. 24. Aquarium



Noise Wall

Noise wall is used to term the undesirable soundscape that has wide bandwidth of frequencies and produces masking effect which weakens the enclosing Soundscape (Fig. 25). Some of the examples are construction noises and human noises in crowded streets.

Wrightson defined noise wall this way:

In the lo-fi soundscape, meaningful sounds (and any associated acoustic coloration), can be masked to such an extent that an individual's "aural space" is reduced. Where the effect is so pronounced that an individual can no longer hear the reflected sounds of his/her own movement or speech, aural space has effectively shrunk to enclose the individual, isolating the listener from the

environment. If the masking of reflected and direct sounds is so severe that an individual cannot hear his/her own footsteps - which is common on the streets of many cities - one's aural space is reduced to less than that of human proportions. Under such extreme conditions, sound is either smothered (in the sense that particular sounds are not heard) or, sounds merge and sonic information mutates into anti-information: "noise" [5].

Fig. 25. Soundscape perspective of noise wall

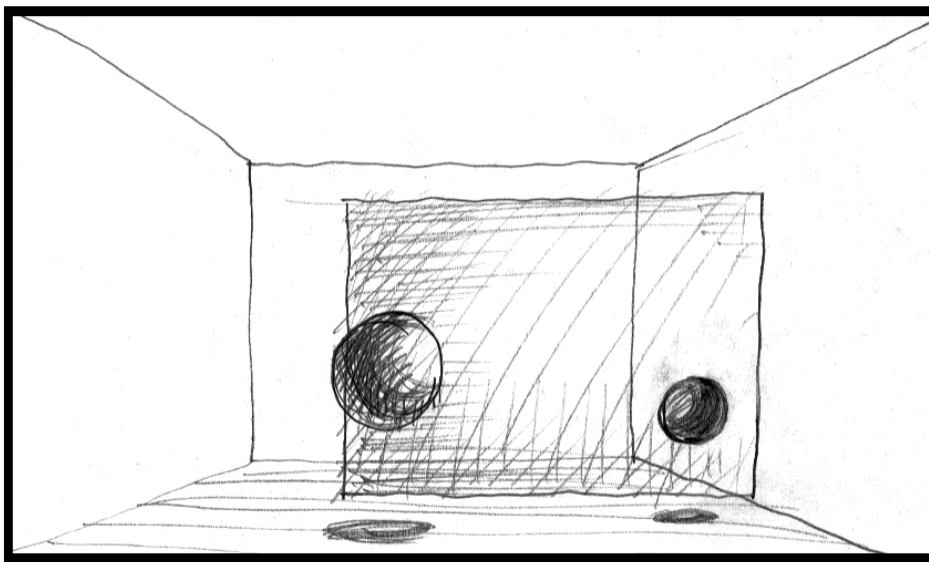

Real Wall

No doubt, the real walls block a big part of soundscape and create a “blind” area in the acoustic environment around visitors walking by. (Fig. 26) The acoustic space is squeezed but the visual attention can be sometimes concentrated on the opposite side against the wall.

Fig. 26. Real wall reduces the acoustic space

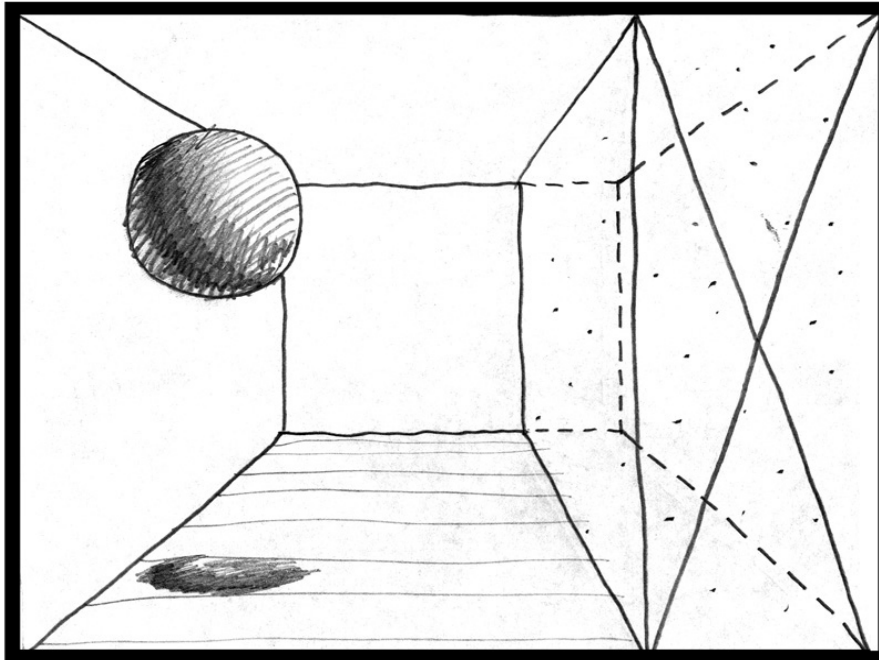

3.1.4 Space

There are some examples that use deliberately designed acoustic space to attract visitors.

Sonic Playground

This is a sonic playground built on the walkway to Liberty Science Center in Jersey City, NJ (Fig. 27). This ramped walkway with two eight-inch diameter vertical stainless steel dishes is creating an acoustic space for reflecting and focusing sound. Visitors can use their hand to generate sound waves by clapping and stop them [7].

Fig. 27. Parabolic bench. (Liberty Science Center 2000 Jersey City, NJ)



Another example is called by the designers as “outdoor musical instruments”, which is located in Wesley Coan Park, Atlanta, Georgia (Fig. 28, 29). It is designed by musician/artist/craftsman Bond Anderson and his Sound Play. They developed the musical playscape to become a permanent installation of tuned musical instruments providing a public setting where people may share in the creative process [30].

Fig. 28. A Sound Play musical playscape. (Wesley Coan Park, Atlanta, Georgia) [30]



Fig. 29. Another view of the Sound Play musical playscape [30]



Echo Wall

This Echo Wall is an attraction in the Temples of Heaven, Beijing. It is famous because of its unique acoustic design. If one speaks against the wall at one end, another can hear his voice at the other end of it. This might seem to be a small trick. But back in 15th century, it was a really amazing design. The main technology involved is sound reflection and diffraction (Fig. 30).

Fig. 30. Echo wall, Temple of Heaven, Beijing, China



Le Cylindre Sonore

This is a small circular space designed to create a sound space for visitors walking through to obtain aural refreshment as well as visual entertainment. The sound spaces are constructed, developed and varied in the Cylindre Sonore between the sound columns behind the eight perforated concrete elements (Fig. 31). 24 loudspeakers are positioned around the inner side of cylinder, along with water forming narrow rivulets into the basin which encloses the ground of the cylinder space to create sound lines tracing the shape of the architectural instrument [31].

Fig. 31 Cylindre Sonore (Parc De La Villette, Paris, designed by Bernhard Leitner) [31].



3.2 Soundscape and Organization of Spaces

In architecture, there seldom are buildings that consist of only solitary space. It is the combination and organization of spaces that generate the path of movement. However, buildings themselves don't move. They are just standing there. When we walk through a series of spaces, we connect a sequence of pictures of static objects to feel the change of spaces. But for blind people, the sound is always mobile. If it stops moving then it is

silent. Moving is the only way of existence [13]. These moving sound objects define the space, connect the space, and sometimes hide the space.

3.2.1 Busy and Quiet Spaces

In architecture, different spaces have different soundscapes. Architects might need to define spaces according to visitors' behavior and preference such as whether they like to find a quiet place to have rests or to enjoy the festival atmosphere with other people. This is similar with the difference between public and private spaces. For practical purpose, designers should know that loudness and density are not the only factors to differentiate a quiet aural space from busy ones. The amount and frequency spectrum of *sound signals* are also important. And we usually hear hi-fi natural sounds as quieter soundscape than lo-fi man-made acoustic environment (Fig. 32).

Fig. 32. Quiet and busy acoustic spaces



In any situation, clearly defined spaces should come with clearly defined soundscape, whether they are quiet or busy, so that visitors can select the spaces they want to stay (Fig. 33).

Fig. 33. Definition of a quiet space



How to separate noisy and quiet spaces is a big topic of acoustic insulation. But in soundscape, the boundary between louder spaces and quieter ones could be blurred, which results in gradual changes of dynamics with the movement of visitors. This continuous soundscape change could be well organized to bring aesthetic aural experience to visitors. JFK Memorial at Dallas is an example to create a quiet space in the noisy downtown soundscape both visually and acoustically (Fig. 34).

Fig. 34. John F. Kennedy Memorial (Dallas, TX, by Philip Johnson)



There are usually two ways to create a quiet acoustic environment from a loud and busy soundscape. The first way is to block the lo-fi sound events by sound-absorbing materials or natural plants such as trees or tall green fences (Fig. 35). The second way is to use natural sound objects as hi-fi *sound signals* up front to the ears of visitors. These *sound signals* better have different frequency range and acceptable volume range (usually less than 50 dBA).

Fig. 35. Acoustic insulation [32]

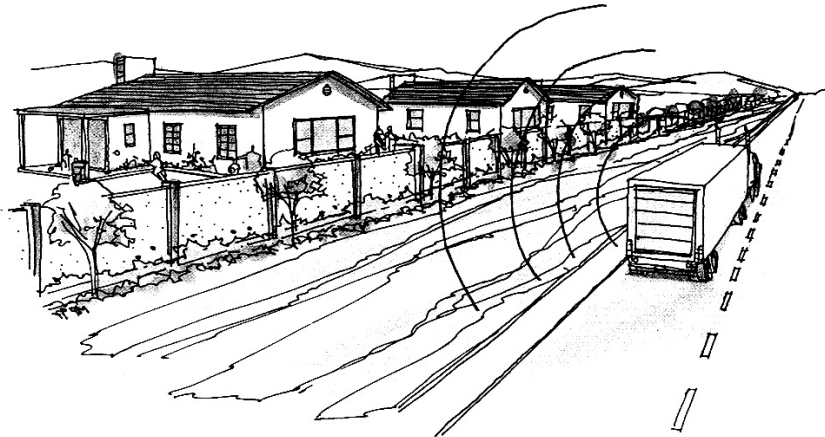
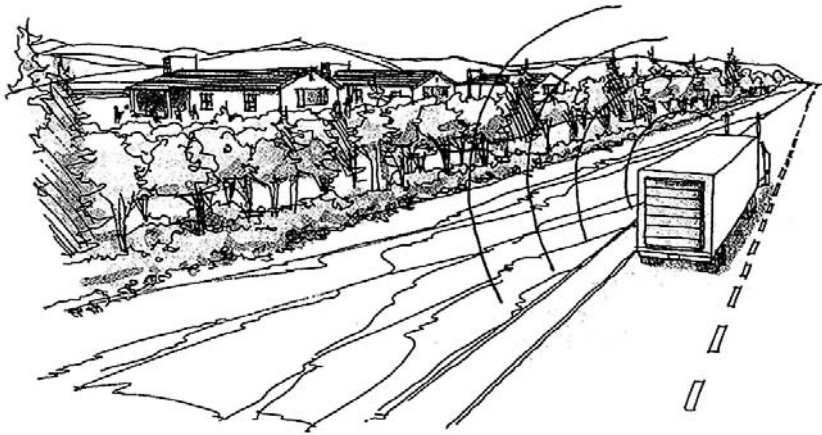

3.2.2 Silence

The extremity of quiet soundscape is silence. As Schafer suggested, there are two different attitudes to treat silence in acoustic design. One is negative silence,

Man likes to make sounds to remind him that he is not alone. From this point of view total silence is the reflection of the human personality. Man fears the absence of sound as he fears the absence of life. As the ultimate silence is death, it achieves its highest dignity in the memorial service [33].

And the other is positive silence, when designers use silence to avoid the increasing sonic incursions.

The essence of sound is felt in both motion and silence; it passes from existent to nonexistent. When there is no sound, it is said that there is no hearing, but that does not mean that hearing has lost its preparedness. Indeed, when there is no sound, hearing is most alert, and when there is sound the hearing nature is least developed [34].

There is no absolute silence. Even when there is no sound in the space enclosing a person, he can still hear his own heart beat and breath. And our sensitivity to silence, according to Miler, is essential to listening well. He suggested that understanding silence clearly is strongly helpful in cultural sensitivity, ecological awareness, and personal physical and communicative health [35].

Silence can also bring sense of awe-inspiring to an architectural space. The acoustic design for Philip Johnson's Rothko Chapel successfully treated silence as a main theme to create a place of worship and contemplation. The inside acoustic atmosphere brings

the visitors warmth and the immense tranquility of this space dedicated to peace and freedom (Fig. 36).

Fig. 36. Rothko Chapel, designed by Philip Johnson

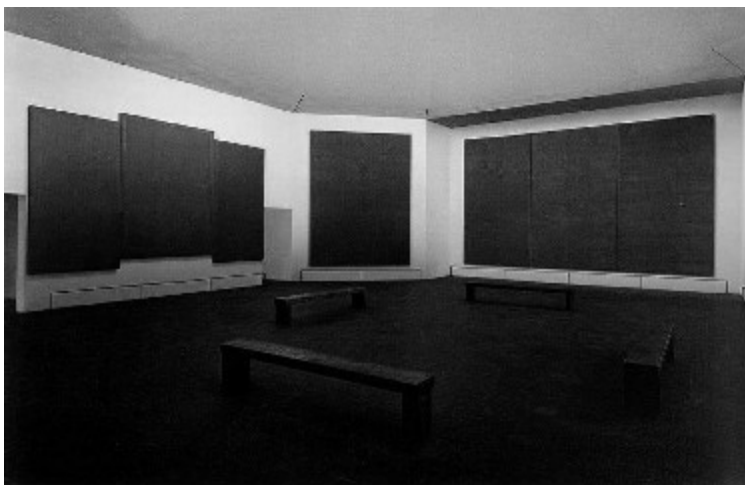
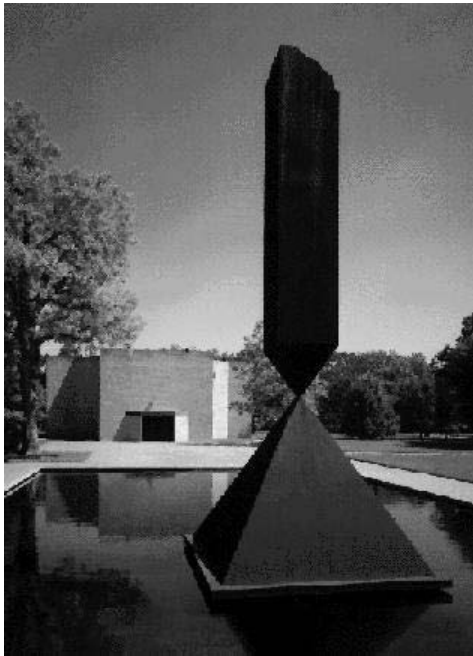

In traditional Asian art, leaving blank is a widely used technique in painting. It is the relation between blank and non-blank that defines the beauty and inner philosophy of life. Silence is blank in soundscape. As the ancient oriental philosopher, Lao-tzu noted, “Give up haste and activity. Close your mouth. Only then will you comprehend the spirit of Tao.” [36]

3.2.3 Soundscape and Spatial Relationships

At For an Awareness of Associations, Copeland noted that,

For sighted people: another person approaches, you see the person a long way away, or coming around the corner. And they get bigger as they approach you, don't they? And finally, they are within shouting distance. Et cetera, et cetera. Alas, you shake hands. None of that intermediate space exists for a blind person. All of a sudden you are grabbed, you are greeted. Somebody calls your name from a few feet away. Now I think that changes the sense of distance and nearness for a blind person [13].

Sometimes we hear something even before we see it. This is due to the effect of Sound Diffraction. Now the question is, how we can utilize this time difference between the two perceptions by which we sense the objects around us?

In ancient Chinese architecture, designers tend to avoid leading visitors to approach the most attractive space or scene directly. Just like the Chinese proverb says, “hold it down before you release it.” Let us look at the site plan of Yi Yuan (Garden of Contentment), Suzhou, China (Fig. 37).

Fig. 37. Soundscape map of Yi Yuan (Garden of Contentment), Suzhou, China.

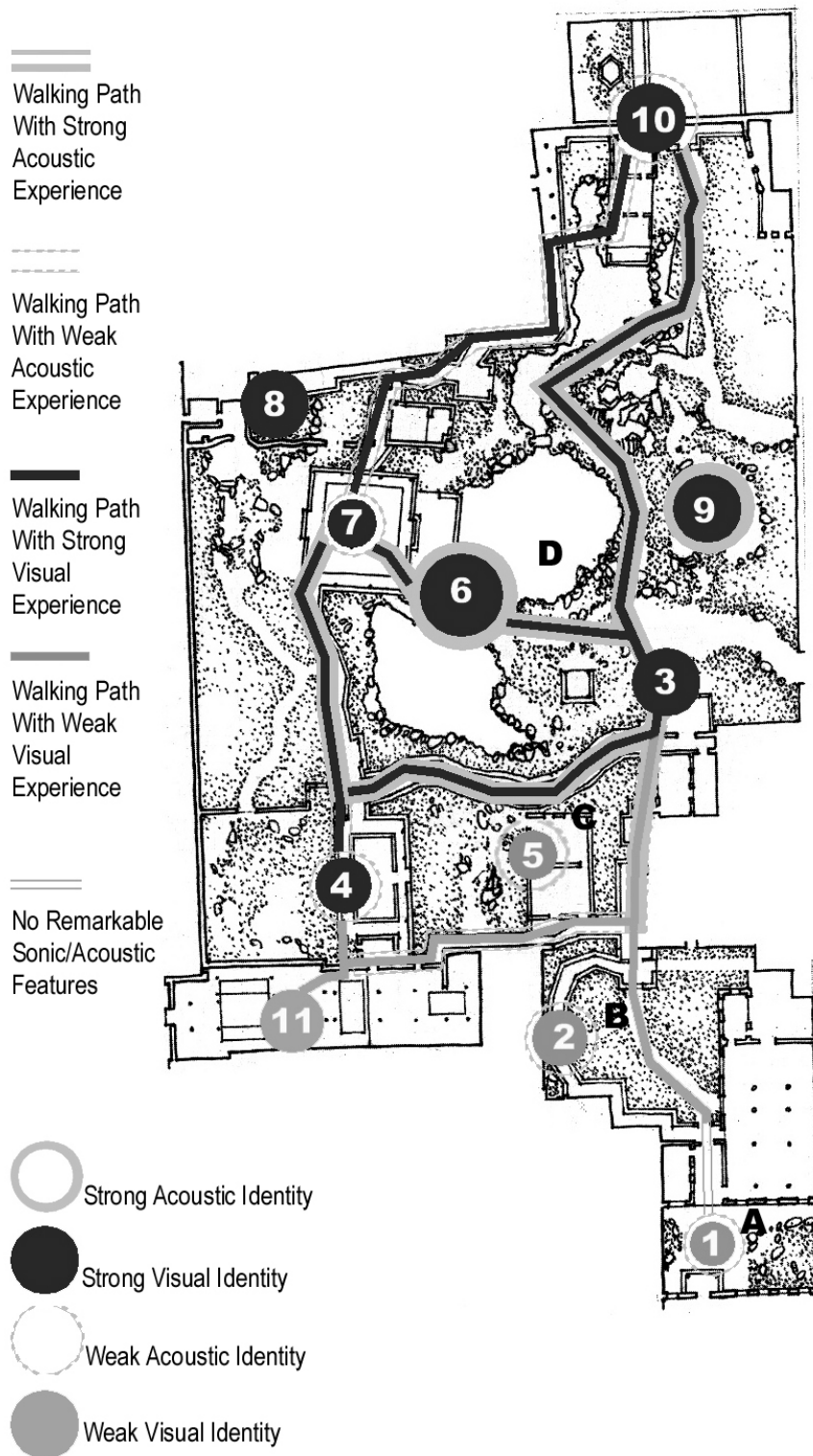

At the time of Qing Dynasty in China, there was usually a musician playing Zheng, a traditional Chinese musical instrument at the lakeside to create a soundscape for the courtyard of the garden. Some of the featured acoustic identities in this example are:

- 1, the soundscape changes from the noisy street to a quiet small entrance yard;
- 2, the soundscape changes from a quiet room into an outdoor space;
- 5, visitors can hear the music from behind the wall;
- 6, here the sound of musical instrument becomes remarkable;
- 9, the music sound comes from beneath the small hill.

When visitors came, even before they crossed the entry hall, they could hear the music coming out from behind the small rooms leading to the courtyard. The visitors then formed expectation and imagination for the coming vision. Their desire to reach the climax of a series of spaces became so strong that when they finally saw the central lake and the big space of the courtyard, they got a feeling being released and satisfied. The process is shown in Fig. 38:

Fig. 38. A sequence of spaces with different soundscape features

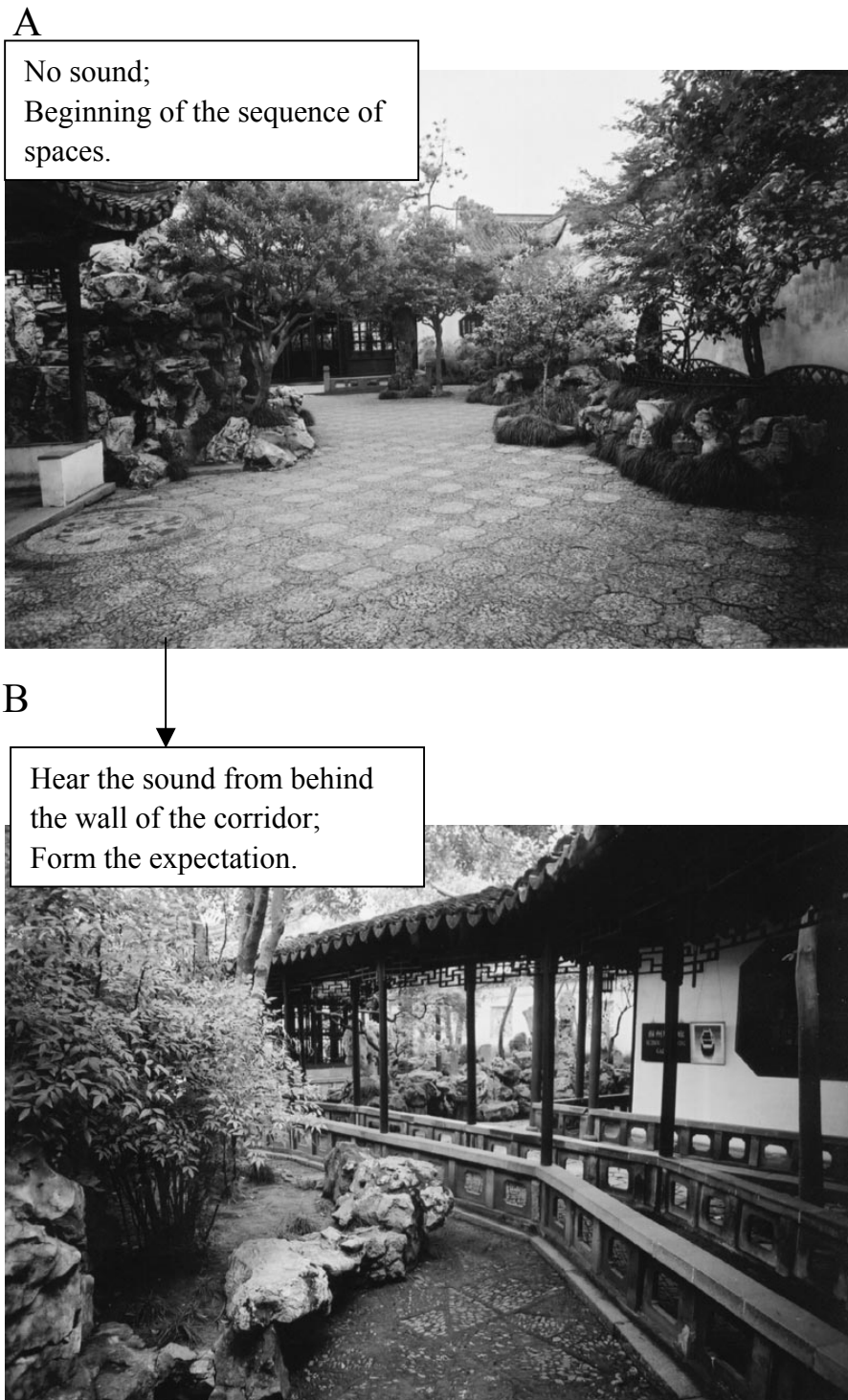
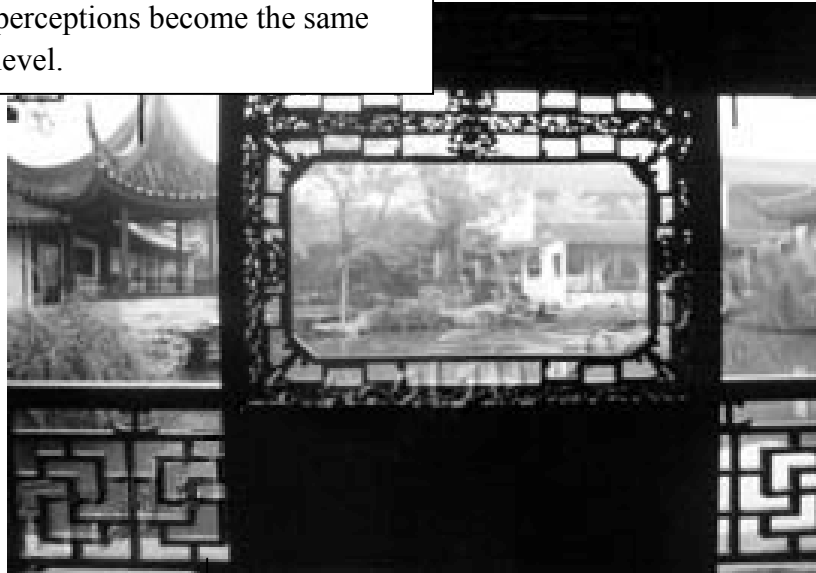

Fig. 38. Continued

C

See the central lake through the corridor. The visual and sonic perceptions become the same level.



D

Get into the court yard and reach the climax of the series of spaces. Get the feeling being released and satisfied. The visual perception becomes



3.3 A Case Study on Falling Water

Wright's Falling Water is regarded as one of the most successful masterpiece in architecture in the last century. It is also a famous example of soundscape design (Fig. 39).

Fig. 39. Soundscape map of Falling Water

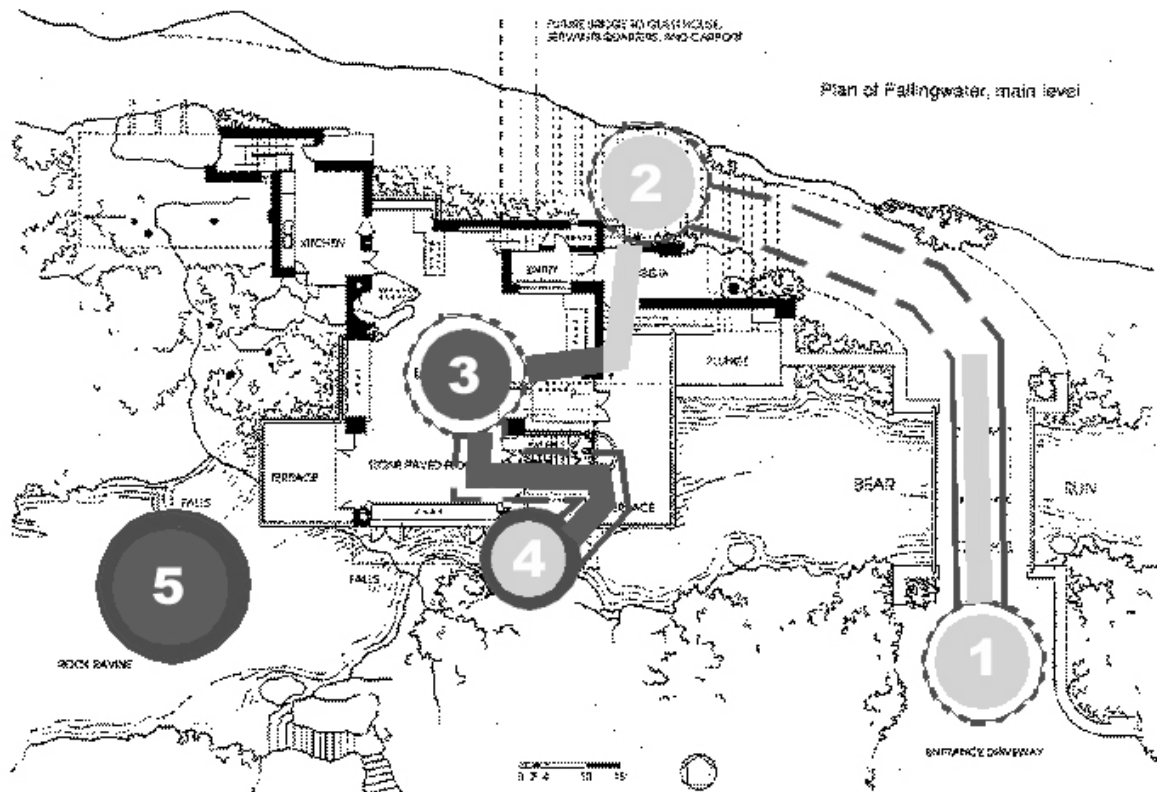

This Soundscape Map describes the path of visitors approaching Falling Water. The five main identities of visual and sonic experience are (Tab. 7 and Fig. 40):

Table 7. Sonic and visual identities in Fig. 39

	Sonic Identity	Visual Identity
1	Visitors can hear the water sound but can not see it.	See the living room of the house through windows.
2	Quiet soundscape.	Small entrance space with low lighting.
3	We can hear the water sound but not clearly	Big living room with views to the outdoor natural scenes.
4	The water sound is under feet with reverbs created by the bottom of the rocks.	Water is the first vision. Get into the outdoor environment with water fall under feet.
5	Soundscape of water fall.	The well known figure of Falling Water.

Fig. 40. Sequence of spaces in Falling Water [37]



1, Gateway

Fig. 40. Continued



2, Entrance



3, Living Room

Fig. 40. Continued



4, Water floor



5, The famous figure of Falling Water

4. CONCLUSION AND DISCUSSION

4.1 Directions for Future Research

As a master's thesis, this paper leaves big spaces to be furthered and developed. The future researches could be implemented in these four aspects:

1, the future study will emphasis on more specific issues of typical natural sound sources such as: water, wind, footprints, bird voices, human voices and traffic sounds with further classification of each source to indicate their use and feature in soundscape design;

2, some scientific research methods such as survey and case studies will be introduced to testify and analysis the problems that discussed in the thesis. The study population could be a group architectural designers or students in the department of architecture;

3, some scientific means such as experiments and mathematical modeling will be employed to obtain data and analysis for the study of psychoacoustics and human behavior. By doing this, a standard to evaluate the quality of individual soundscape and mixed soundscapes could be set to meet the need of acoustic design and soundscape design in architecture and landscape architecture.

4, a database will be established with all the sampled individual hi-fi and lo-fi soundscapes in different forms and environments. They are ready to be used in reproduction of virtual acoustic environment in multimedia architecture presentations.

4.2 Limitations and Discussions

This study is mostly based on literature review and personal observations. The scope is wide but time is limited. As a thesis in master's level, some of the viewpoints are not

fully developed and leave space to be developed and examined by experiments or surveys. The whole thesis is organized with summary of previous researches and some case studies to serve as a step stone for architects who have interests in soundscape leading to deeper research attempts. As the relevant researches on architecture and soundscape are so limited, I hope my research can at least open another window in this “huge dark room” so that more people will devote themselves into this new research subject.

Another limitation comes from the subject of soundscape itself. Up to now, the soundscape studies are basically divided into three categories: acoustic physics, psychoacoustics and aesthetics. My study should be included into the third, which concerns the aesthetic issues of soundscape research. Even Schafer claimed that the aesthetic qualities of soundscape might be the hardest of all types of classification of soundscape. Sounds affect individuals in different manner and every single sound object might often stimulate wide assortment of reactions, which confused or dispirited researchers easily [22]. Just as people have different preferences toward music and other art forms, study of this problem is widely regarded as too subjective to achieve meaningful results. However, having known some basic principals of soundscape and leaving some space for problems seeking in acoustic issues, designers would learn to launch their ideas more acoustically to help people realize the importance of aural perception in their daily life.

At last, to arouse the public interest in acoustic issues, we still have a long way to go. Today, the visual sense is predominating of all the perceptions. However, as Schafer

noted, before the days of writing, in prophets and epics days, the perception of hearing was more vital and active than the perception of sight [16]. The history of the tribe and all other important information was heard, rather than seen. The certificates could be found even today at some rural Africans living largely in a world of sound. I believe, with more and more effort taken into the study of soundscape, the world will be appreciated in a wider and more diversified manner with all the perceptions at relatively closer level.

REFERENCES

1. R. Murray Schafer, *The Tuning of the World* (New York: Alfred A. Knopf, 1977) p. 11.
2. Neil McLachlan, "The Aural Dimensions," *Architecture Australia*, **89** Issue 1 (Jan/Feb 2000) p. 92.
3. Steen E. Rasmussen, *Experiencing Architecture* (New York: Technology Press of MIT, 1959) p. 232.
4. Schafer [1] p. 274.
5. Kendall Wrightson, "An Introduction to Acoustic Ecology," *Journal of Acoustic Ecology*, **1**, Number 1 (Spring 2000) pp. 10-14.
6. Wrightson [5].
7. Bill + Mary Buchen, Website of Sonic Architecture, at http://www.sonicarchitecture.com/frm_htm.htm (2002).
8. Charles M. Salter Associates Inc. *Acoustics: Architecture, Engineering, the Environment*, 1st edition (San Francisco: William Stout Publishers, May 1998).
9. John E. Moore, *Design for Good Acoustics and Noise Control* (London: MacMillan Pub Co., December 1979).
10. Elizabeth Martin, *Architecture as a Translation of Music, Pamphlet Architecture 16* (New York: Princeton Architectural Press, 1995).
11. Bernhard Leitner, *Sound: Space* (Ostfildern: Hatje Cantz Publishers, June 1999)
12. Anita Lawrence, *Acoustics and the Built Environment* (New York: Elsevier Applied Science, May 1990).
13. Darren Copeland, "For an Awareness of Associations", written for The International

Congress on Acoustic Ecology in Paris, France (Summer 1997).

14. Francis DK Ching, *Architecture: Form, Space and Order*, 2nd edition (New York: Van Nostrand Reinhold, 1996).

15. Schafer [1] p. 4.

16. Schafer [1] pp. 4-11.

17. David M. Huber and Robert E. Runstein, *Modern Recording Techniques* (Boston: Focal Press, 1997) p. 24.

18. Salter [8] p. 18.

19. Schafer [1] pp. 134-135.

20. David Gibson, *The Art of Mixing: A Visual Guide to Recording, Engineering, and Production (Mix Pro Audio Series)* (Emeryville, CA: Mix Books, July 1997) p. 28.

21. Schafer [1] pp. 137-145.

22. Schafer [1] pp. 146-150.

23. Sandy Lerner, *Dilettantes dictionary online, audio terminology in theses digital days* at <<http://www.dilettantesdictionary.com/intro.html>> (2003).

24. Schafer [1] pp. 9-10.

25. Schafer [1] p. 263.

26. Gibson [20] pp. 8-19.

27. Ching [14] p.2.

28. Leitner [11] pp. 264-267.

29. Ching [14] p.8.

30. Bond Anderson, Website of “Sound Play: outdoor musical instruments” at <<http://www.soundplay.com>> (2002).
31. Leitner [11] pp. 146-163.
32. Salter [8] pp. 64-65.
33. Schafer [1] pp. 253-259.
34. Kirpal Singh, *Naam or Word*, (Delhi, India: Ruhani Satsang, 1970) p. 59.
35. Wreford Miller, M.A. Thesis, *Silence in the Contemporary Soundscape*, Simon Fraser University, Burnaby, Canada (August 1993)
36. Lao-tzu, *Tao Teh King, The Texts of Taoism*, Part II, Chapter 56.
37. Bruce B. Pfeiffer and Yukio Futagawa, *Frank Lloyd Wright Selected Houses 4*, (Tokyo, Japan: A.D.A. Edita, 1990)

APPENDIX: GLOSSARIES OF SOUND

Amplitude: It refers to the volume of sound. It is a measure of the distance above or below the centerline of a waveform. [5]

Bandwidth: A specific range of frequencies. [1]

dBa: A-weighting is standard frequency weighting that de-emphasizes low-frequency sound similar to average human hearing response and approximates loudness and annoyance of noise. A-weighted sound levels are reported as dBA. [4]

Decay: Decrease in volume of a sound event with time.

Diffraction of Sound: Sound has the inherent ability to diffract around or through an acoustic barrier: sound can bend around an object and reconstruct itself.

Directivity: Describes the angle of coverage of aural perception both in the vertical and horizontal planes. The receiver can form an impression of directivity from the sound source. It includes information of panning, which refers to the left-right placement of a sound; distance, and height. [3]

Echo: Reflection of a sound wave back to its source in sufficient strength and with a sufficient time lag to be separately distinguished. [1]

Envelope: Characteristic variations in level (usually amplitude) that change in time of a sound event. It has four parts of content, which is *Attack*, *Decay*, *Sustain*, and *Release*. [5]

Equalizer: An adjustable audio filter inserted in a circuit to divide and adjust its frequency response, altering or distorting the relative amplitude of certain frequency ranges of an audio signal. [3]

Frequency: Number of wave cycles that arriving at or passing a point per second. The unit used to describe frequency is hertz (HZ). It is related to the musical measurement, Pitch.

Frequency Response: The amplitude response of a system or device to reflect the input spectrum of sounds.

Harmonic Content: The factor that allows us to differentiate between instruments is the presence of various frequencies, called *partials*. Frequencies that exist in addition to the pitch that is being played, called the *fundamental*. Partials that are higher than the fundamental frequency are called upper partials or *overtones*. [5]

Masking: The process by which sensitivity to a sound is decreased by the presence of another sound. [4]

Noise: (1) Undesired sound. (2) Random waveform. [4]

Phase: It can be described as the relative degree angle of a wave with another wave over 360° , or its starting point measured in degrees. [5]

Reflection of Sound: Like light, sound reflects off a surface boundary that is equal to and in the opposite direction of direction of its initial angle of incidence. [5]

Resonance: An increase in a certain range of frequencies of a sound event. It also refers to the change of one or more harmonics of sounds as a result of large amplitude vibration in a mechanical system caused by small stimulus. [4]

Reverberation: It is the collection of multi-delayed sounds caused by sound reflections. The effect of reverberation can create certain sense of space and distance.

Sound Absorption: The absorption of energy from objects and surfaces on which sounds reflect.

Sound Event: Something that occurs in a certain place during a particular interval of time. [2]

Sound Isolation: The method to attenuate sound by certain kinds of material or assembly.

Sound Object: It is defined by the human ear as the smallest self-contained particle of a soundscape, and is analyzable by the characteristics of its envelope. [2]

Sound Pressure Level (SPL): It is to term a sound pressure expressed using the logarithmic unit, dB. SPL is the most frequently used metric in acoustics. [4]

Spectrum: The combination of different frequencies within a sound object is called spectrum.

Timbre: The quality of a given sound event that results from the spectrum and frequency content. There are other terms that have similar meaning with timbre, such as “tone” or “color”.

Wavelength: In a periodic wave cycle, the distance between two points, which are in the same phase in consecutive cycles along the direction of propagation.

White Noise: Noise that has a spectrum with absolute even level for each frequency.

Note:

1. Columbia Encyclopedia 2003, Sixth Edition, Copyright (c) 2003.
<<http://www.encyclopedia.com>>
2. R. Murray Schafer, *The Tuning of the World* (New York: Alfred A. Knopf, 1977).
3. Sandy Lerner, *Dilettantes dictionary online, audio terminology in theses digital days* at <<http://www.dilettantesdictionary.com/intro.html>> (2003).
4. Charles M. Salter Associates Inc., *Acoustics: Architecture, Engineering, the Environment* 1st Edition (San Francisco: William Stout Publishers, May 1998).
5. David M. Huber and Robert E. Runstein, *Modern Recording Techniques* (Boston: Focal Press, 1997)

VITA

Author	Keda Wang
Address	28-A-608, Beiwalu Street, Haidian District Beijing, China 100089
Education	Bachelor of Architecture, Conferred July 1999 Tsinghua University, Beijing, China
Areas of Interest	Soundscape, Multimedia Architectural Presentation, Electronic Music Composition