

SYLLABUS - 2016

FINAL : PAPER -

15

STRATEGIC COST MANAGEMENT - DECISION MAKING

FINAL

STUDY NOTES



The Institute of Cost Accountants of India

CMA Bhawan, 12, Sudder Street, Kolkata - 700 016

First Edition : August 2016

Reprint : January 2018

Revised Edition : December 2018

Edition : August 2019

Published by :

Directorate of Studies

The Institute of Cost Accountants of India (ICAI)

CMA Bhawan, 12, Sudder Street, Kolkata - 700 016

www.icmai.in

Printed at :

M/s. Aravali Printers & Publishers (P) Ltd.

W-30, Okhla Industrial Area, Phase - II

New Delhi - 110 020.

Copyright of these Study Notes is reserved by the Institute of Cost Accountants of India and prior permission from the Institute is necessary for reproduction of the whole or any part thereof.

Syllabus- 2016

PAPER 15 : STRATEGIC COST MANAGEMENT - DECISION MAKING (SCMD)

Syllabus Structure

A	Cost Management	20%
B	Strategic Cost Management Tools and Techniques	50%
C	Strategic Cost Management - Application of Statistical Techniques in Business Decisions	30%

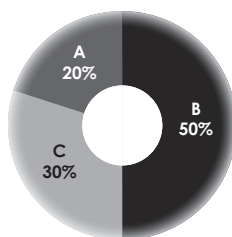

ASSESSMENT STRATEGY

There will be written examination paper of three hours

OBJECTIVES

On completion of this subject students should have developed skills of analysis, evaluation and synthesis in cost and management accounting and, in the process, created an awareness of current developments and issue in the area. The subject covers the complex modern industrial organizations within which the various facets of decision-making and controlling operations take place; the subject includes discussion of costing systems and activity based costing, activity management, and implementation issues in modern costing systems.

Learning Aims

The syllabus aims to test the student's ability to:

- Identify the conventions and doctrines of managerial and cost accounting and other generally accepted principles which may be applied in the contemporary cost management models
- Identify major contemporary issues that have emerged in strategic cost management
- Discuss a number of issues relating to the design and implementation of cost management models in modern firms
- Application of Operation Research in Strategic Decision Making

Skill set required

Level C : Requiring skill levels of knowledge, comprehension, application, analysis, synthesis and evaluation

Section A : Cost Management	20%
1. Cost Management	
Section B : Strategic Cost Management Tools and Techniques	50%
2. Decisions Making Techniques	
3. Standard Costing in Profit Planning	
4. Activity Based Cost Management – JIT and ERP	
5. Cost of Quality and Total Quality Management	
Section C : Strategic Cost Management – Application of Statistical Techniques in Business Decisions	30%
6. Application of Operation Research and Statistical Tools in Strategic Decision Making	

SECTION A: COST MANAGEMENT [20 MARKS]

1. Cost Management

- (a) Developments in Cost Management:
 - (i) Life Cycle costing
 - (ii) Target costing
 - (iii) Kaizen Costing
 - (iv) Value Analysis and Value Engineering
 - (v) Throughput Costing
 - (vi) Business Process Re-engineering
 - (vii) Back-flush Accounting
 - (viii) Lean Accounting
 - (ix) Socio Economic Costing
- (b) Cost Control and Cost Reduction – Basics, Process, Methods and Techniques of Cost Reduction programme.

SECTION B: STRATEGIC COST MANAGEMENT TOOLS AND TECHNIQUES [50 MARKS]

2. Decision Making Techniques

- (a) Marginal Costing- Differential costing-CVP Analysis – Profit Volume Graphs – Contribution Approach
- (b) Decisions involving alternative choices – Optimum utilization of resources – Make or Buy – Evaluation of Orders – Multiple scarce resource problems- Product sales pricing..... etc
- (c) Pricing Decisions and Strategies – New Product Pricing, Use of Costs in Pricing, Sensitivity Analysis in Pricing Decisions; Monopoly Pricing vs. Competitive Pricing; Bottom Line Pricing
- (d) Costing of Service Sector – methods, pricing, performance measurement
- (e) Transfer Pricing - Objectives, Methods (Cost Based, Market Price Based, Negotiated Pricing), Advantages and Disadvantages, Criteria for setting Transfer Prices, Transfer Price in different situations, Situations causing Conflicts and resolving the Conflicts;
- (f) Relevant Cost Analysis : Relevant Cost, Irrelevant Costs - Sunk or Historical Cost, Committed Cost, Absorbed Cost, Situations where Fixed Costs become relevant for decision – making and its related implications
- (g) Profitability Analysis – Product wise / Segment Wise / Customer wise

3. Standard Costing in Profit Planning

- (a) Variance Analysis - Investigation of Variances, Planning and Operating Variances, Controllable / Non-controllable Variances, Relevant Cost Approach to Variance Analysis; Variance analysis under marginal costing and absorption costing; Activity Ratios; Application of budgetary control and Standard Costing in Profit planning, Standard Costing Vs Budgetary Control, Reconciliation of Actual Profit with Standard Profit and /or Budgeted Profit.
- (b) Uniform Costing and Inter-firm comparison.

4. Activity Based Cost Management – JIT and ERP

- (a) Activity Based Cost Management - Concept , purpose, benefits, stages, relevance in decision-making and its application in Budgeting, Responsibility accounting, Traditional Vs. ABC System – comparative analysis

- (b) JIT – introduction, Benefits, Use of JIT in measuring the Performance
- (c) ERP and its applications in strategic cost management
- (d) Bench Marking

5. Cost of Quality and Total Quality Management

- (a) TQM - Basics, Stages, Principles, Control, Corrective actions
- (b) PRAISE-Steps, Problems, implementation
- (c) PARETO Analysis
- (d) Quality Costs

SECTION C: STRATEGIC COST MANAGEMENT – APPLICATION OF STATISTICAL TECHNIQUES IN BUSINESS DECISIONS [30 MARKS]

6. Application of Operation Research and Statistical Tools in Strategic Decision Making

- (a) Learning Curve,
- (b) Linear Programming (Formulation only)
- (c) Assignment,
- (d) Transportation
- (e) Simulation
- (f) Network Analysis – CPM / PERT

Contents

SECTION A – COST MANAGEMENT

Study Note 1 : Cost Management

1.1	Life Cycle Costing	1
1.2	Target Costing	8
1.3	Kaizen Costing	14
1.4	Value Analysis and Value Engineering	15
1.5	Throughput Costing	21
1.6	Business Process Re-engineering	33
1.7	Back-flush Accounting	34
1.8	Lean Accounting	40
1.9	Socio Economic Costing	43
1.10	Cost Control and Cost Reduction – Basics, Process, Methods and Techniques of Cost Reduction Programme	47

SECTION B – STRATEGIC COST MANAGEMENT TOOLS AND TECHNIQUES

Study Note 2 : Decision Making Techniques

2.1	Marginal Costing	51
2.2	Transfer Pricing	143

Study Note 3 : Standard Costing in Profit Planning

3.1	Variance Analysis	165
3.2	Uniform Costing in Profit Planning	226
3.3	Inter Firm Comparison	228

Study Note 4 : Activity Based Cost Management - JIT and ERP

4.1	Activity Based Cost Management	231
4.2	Just-In-Time (JIT)	245
4.3	Enterprise Resource Planning (ERP)	251
4.4	Bench Marking	254

Study Note 5 : Cost of Quality and Total Quality Management

5.1	Total Quality Management (TQM)	259
5.2	Praise Analysis	261
5.3	Six Sigma	263
5.4	Pareto Analysis	264
5.5	Quality Costs	267

SECTION C – STRATEGIC COST MANAGEMENT – APPLICATION OF STATISTICAL TECHNIQUES IN BUSINESS DECISIONS

Study Note 6 : Application of Operation Research and Statistical Tools in Strategic Decisions Making

6.1	Learning Curve	281
6.2	Linear Programming	289
6.3	Assignment	296
6.4	Transportation	307
6.5	Simulation	327
6.6	Network Analysis – CPM/PERT	342



Section A
Cost Management
(Syllabus - 2016)



Study Note - 1

COST MANAGEMENT



This Study Note includes

- 1.1 Life Cycle Costing
- 1.2 Target Costing
- 1.3 Kaizen Costing
- 1.4 Value Analysis and Value Engineering
- 1.5 Throughput Costing
- 1.6 Business Process Re-engineering
- 1.7 Back-flush Accounting
- 1.8 Lean Accounting
- 1.9 Socio Economic Costing
- 1.10 Cost Control and Cost Reduction – Basics, Process, Methods and Techniques of Cost Reduction Programme

1.1 LIFE CYCLE COSTING

Meaning of Life Cycle Costing

- (a) **Life Cycle Costing**; aims at cost ascertainment of a product, project etc. over its projected life.
- (b) It is a system that tracks and accumulates the actual costs and revenues attributable to cost object (i.e.; product) from its inception to its abandonment.
- (c) Sometimes the terms; cradle-to-grave costing and womb-to-tomb costing convey the meaning of fully capturing all costs associated with the product from its initial to final stages.

Meaning of Product Life Cycle

- (a) Product Life Cycle is a pattern of expenditure, sale level, revenue and profit over the period from new idea generation to the deletion of product from product range.
- (b) Product Life Cycle spans the time from initial R&D on a product to when customer servicing and support is no longer offered for the product. For products like motor vehicles, this time-span may range from 5 to 7 years. For some basic pharmaceuticals, the time-span be 7 to 10 years.

Characteristic of PLCC

- (a) Involves tracing of costs and revenues of each product over several calendar periods throughout their entire life cycle.
- (b) Traces research, design and development costs and total magnitude of these costs for each individual product and compared with product revenue.
- (c) Assists report generation for costs and revenues.

Phases in Product Life Cycle:

The 4 identifiable phases in the product Life Cycle are — (a) Introduction (b) Growth (c) Maturity and (d) Decline. A comparative analysis of these phases is given below —

Particulars	Introduction	Growth	Maturity	Decline
Phase	I	II	III	IV
Sales Volumes	Initial stages, hence low.	Rise in sales levels at increasing rates.	Rise in sales levels at decreasing rates	Sales level off and then start decreasing
Prices of products	High levels to cover initial costs and promotional exps.	Retention of high level prices except in certain cases.	Prices fall closer to cost, due to effect of competition.	Gap between price and cost is further reduced.
Ratio of promotion expenses to sales	Highest, due to effort needed to inform potential customers, launch products, distribute to customers etc.	Total expenses remain the same, while ratio of S&D OH to sales is reduced due to increase in sales.	Ratio reaches a normal level of sales. Such normal level becomes the industry standard.	Reduced sales promotional efforts as the product is no longer in demand.
Competition	Negligible and insignificant	Entry of a large number of competitors.	Fierce Competition	Starts disappearing due to withdrawal of products.
Profits	Nil, due to heavy initial costs	Increase at a rapid pace	Normal rate of profits since costs and prices are normalized.	Decline profits due to price competition new products etc.

- in the growth stage, maintain the prices at high levels, in order to realize maximum profits.
- Price reduction will not be undertaken unless (a) the low prices will lead to market penetration, (b) the Firm has sufficient production capacity to absorb the increased sales volume, and (c) Competitors enters the market.

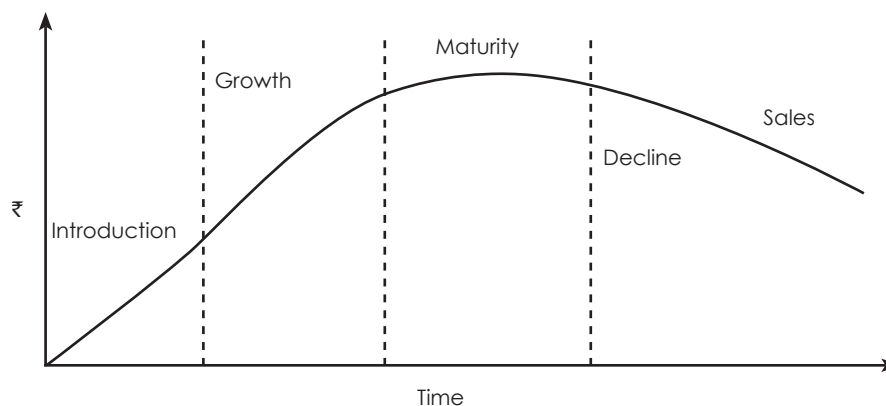

Benefits of PLCC

- Results in earlier actions to generate revenue or to lower costs than otherwise might be considered.
- Ensures better decision from a more accurate and realistic assessment of revenues and costs atleast within a particular life cycle stage.
- Promotes long-term rewarding.
- Provides an overall framework for considering total incremental costs over the life span of the product.



Importance of Product Life Cycle Costing:

Product Life Cycle Costing is considered important due to the following reasons —

- (a) **Time based analysis:** Life cycle costing involves tracing of costs and revenues of each product over several calendar periods throughout their life cycle. Costs and revenues can be analysed by time periods. The total magnitude of costs for each individual product can be reported and compared with product revenues generated in various time periods.
- (b) **Overall Cost Analysis:** Production Costs are accounted and recognized by the routine accounting system. However non-production costs like R&D; design; marketing; distribution; customer service etc. are less visible on a product — by — product basis. Product Life Cycle Costing focuses on recognizing both production and non-production costs.
- (c) **Pre-production costs analysis:** The development period of R&D and design is long and costly. A high percentage of total product costs may be incurred before commercial production begins. Hence; the Company needs accurate information on such costs for deciding whether to continue with the R&D or not.
- (d) **Effective Pricing Decisions:** Pricing Decisions; in order to be effective; should include market considerations on one hand and cost considerations on the other. Product Life Cycle Costing and Target Costing help analyze both these considerations and arrive at optimal price decisions.
- (e) **Better Decision Making:** Based on a more accurate and realistic assessment of revenues and costs, at least within a particular life cycle stage, better decisions can be taken.
- (f) **Long Run Holistic view:** Product Life Cycle Costing can promote long-term rewarding in contrast to short-term profitability rewarding. It provides an overall framework for considering total incremental costs over the entire life span of a product, which in turn facilitates analysis of parts of the whole where cost effectiveness might be improved.
- (g) **Life Cycle Budgeting:** Life Cycle Budgeting, i.e., Life Cycle Costing with Target Costing principles, facilitates scope for cost reduction at the design stage itself. Since costs are avoided before they are committed or locked in the Company is benefited.
- (h) **Review:** Life Cycle Costing provides scope for analysis of long term picture of product line profitability, feedback on the effectiveness of life cycle planning and cost data to clarify the economic impact of alternatives chosen in the design, engineering phase etc.

Illustration 1.

Wipro is examining the profitability and pricing policies of its Software Division. The Software Division develops Software Packages for Engineers. It has collected data on three of its more recent packages - (a) ECE Package for Electronics and Communication Engineers, (b) CE Package for Computer Engineers, and (c) IE Package for Industrial Engineers.

Summary details on each package over their two year cradle to grave product lives are -

Package	Selling Price	Number of units sold	
		Year 1	Year 2
ECE	₹250	2,000	8,000
CE	₹300	2,000	3,000
IE	₹200	5,000	3,000

Assume that no inventory remains on hand at the end of year 2. Wipro is deciding which product lines to emphasize in its software division. In the past two years, the profitability of this division has been mediocre.

Wipro is particularly concerned with the increase in R & D costs in several of its divisions. An analyst at the Software Division pointed out that for one of its most recent packages (IE) major efforts had been made to reduce R&D costs.



Last week, Amit, the Software Division Manager, decides to use Life Cycle Costing in his own division. He collects the following Life Cycle Revenue and Cost information for the packages - Amount (₹)

Particulars	Package ECE		Package CE		Package IE	
	Year 1	Year 2	Year 1	Year 2	Year 1	Year 2
Revenues	5,00,000	20,00,000	6,00,000	9,00,000	10,00,000	6,00,000
Costs						
R&D	7,00,000	-	4,50,000	-	2,40,000	-
Design of Product	1,15,000	85,000	1,05,000	15,000	76,000	20,000
Manufacturing	25,000	2,75,000	1,10,000	1,00,000	1,65,000	43,000
Marketing	1,60,000	3,40,000	1,50,000	1,20,000	2,08,000	2,40,000
Distribution	15,000	60,000	24,000	36,000	60,000	36,000
Customer Service	50,000	3,25,000	45,000	1,05,000	2,20,000	3,88,000

Present a Product Life Cycle Income Statement for each Software Package. Which package is most profitable and which is the least profitable? How do the three packages differ in their cost structure (the percentage of total costs in each category)?

Answer:

Life cycle Income Statement (in ₹000s)

Particulars	Package ECE				Package CE				Package IE			
	Y1	Y2	Total	%	Y1	Y2	Total	%	Y1	Y2	Total	%
Revenues	500	2,000	2,500	100%	600	900	1,500	100%	1,000	600	1,600	100%
Costs												
R&D	700	-	700	28%	450	-	450	30%	240	-	240	15%
Design	115	85	200	8%	105	15	120	8%	76	20	96	6%
Manufacturing	25	275	300	12%	110	100	210	14%	165	43	208	13%
Marketing	160	340	500	20%	150	120	270	18%	208	240	448	28%
Distribution	15	60	75	3%	24	36	60	4%	60	36	96	6%
Cust. Service	50	325	375	15%	45	105	150	10%	220	388	608	38%
Total Costs	1065	1,085	2150	86%	884	376	1260	84%	969	727	1696	106%
Profit			350	14%			240	16%			(96)	-6%

Observation: Package ECE is most profitable, while package IE is least profitable.

Illustration 2.

A2Z p.l.c supports the concept of zero technology or life cycle costing for new investment decisions covering its engineering activities. The financial side of this philosophy is now well established and its principles extended to all other areas of decision making. The company is to replace a number of its machines and the Production Manager is torn between the Exe Machine, a more expensive machine with a life of 12 years, and the Wye machine with an estimated life of 6 years. If the Wye machine is chosen it is likely that it would be replaced at the end of 6 years by another Wye machine. The pattern of maintenance and running costs differs between the two types of machine and relevant data are shown below:



	Exe	Wye
	₹	₹
Purchase price	19,000	13,000
Trade-in value/brakeup/scrap	3,000	3,000
Annual repair costs	2,000	2,600
Overhaul costs	(at year 8) 4,000	(at year 4) 2,000
Estimated financing costs averaged over machine life		
	10%p.a -Exe;	10% p.a. -Wye

You are required to: recommend with supporting figures, which machine to purchase, stating any assumptions made.

Solution:

Computation of present value of outflows and equivalent annual

	₹	Exe machine	₹	WYE machine
		₹		₹
Initial cost		19,000.00		13,000.00
Less : Scrap at the end of the life	(3000x0.32)	960.00	(3000X.56)	1,680.00
		18,040.00		11,320.00
Present value of total annual cost	(2000x6.81)	13,620.00	(2600x4.36)	11,336.00
Overhaul cost	(4000X.47)	1,880.00	(2000X.68)	1,360.00
		33,540.00		24,016.00
Capital recovery factor	(1/6.81)	0.15	(1/4.36)	0.23
Equivalent annual cost		4,925.00		5,508.00

As the equivalent annual cost is less for exe machine, it is better to purchase the same.

Illustration 3.

Company X is forced to choose between two machines A and B. The two machines are designed differently, but have identical capacity and do exactly the same job. Machine A costs ₹ 1,50,000 and will last for 3 years. It costs ₹40,000 per year to run. Machine B is an 'economy' model costing only ₹ 1,00,000, but will last only for 2 years, and costs ₹ 60,000 per year to run. These are real cash flows. The costs are forecasted in rupees of constant purchasing power. Ignore tax. Opportunity cost of capital is 10%. Which machine Company X should buy?

Answer:

Compound present value of 3 years @ 10%	= 2.486	
P.V. of running cost of Machine A for 3 years	= ₹ 40,000 x 2.486	= ₹ 99,440
Compound present value of 2 years @ 10%	= 1.735	
P.V. of running cost of Machine B for 2 years	= ₹ 60,000 x 1.735	= ₹ 1,04,100

Statement Showing Evaluation of Machines A and B

(₹)

Particulars	Machine A	Machine B
Cost of purchase	1,50,000	1,00,000
Add: P.V. of running cost for 3 years	99,440	1,04,100
P.V. of Cash outflow	2,49,440	2,04,100
	2,49,440	2,04,100
Equivalent present value of annual cash outflow	2.486	1.735
	= 1,00,338	= 1,17,637

Analysis: Since the annual cash outflow of Machine B is higher, Machine A can be purchased.

Illustration 4.
Computation of Equivalent Annual Cost and Identification of Year to Replace the Machine

A & Co. is contemplating whether to replace an existing machine or to spend money on overhauling it. A & Co. currently pays no taxes. The replacement machine costs ₹90,000 now and requires maintenance of ₹10,000 at the end of every year for eight years. At the end of eight years it would have a salvage value of ₹20,000 and would be sold. The existing machine requires increasing amounts of maintenance each year and its salvage value falls each year as follows:

Amount (₹)		
Year	Maintenance	Salvage
Present	0	40,000
1	10,000	25,000
2	20,000	15,000
3	30,000	10,000
4	40,000	0

The opportunity cost of capital for A & Co. is 15%.

When should the company replace the machine?

(Notes: Present value of an annuity of ₹1 per period for 8 years at interest rate of 15% : 4.4873; present value of ₹1 to be received after 8 years at interest rate of 15% : 0.3269)

Answer:

Calculation of Equivalent Annual Cost of New Machine		Amount (₹)
Cost of New Machine		90,000
Add: Present value of annual maintenance cost for 8 years	(₹ 10,000 × 4.4873)	44,873
		1,34,873
Less: Present value of salvage value at the end of 8th year	(₹20,000 × 0.3269)	6,538
Total present value of life cycle costs of new machine		1,28,335

Equivalent Annual cost = ₹ 1,28,335/4.4873 = ₹ 28,600

Calculation of Equivalent Annual cost in continuing with Existing Machine

1 st Year		Amount (₹)
P.V. of salvage value at the beginning of 1st year		40,000
Add: P. V. of Maintenance cost	(10,00/1.15)	8,696
		48,696
Less: P.V. of salvage value at the end of the year	(25,000/1.15)	21,739
		26,957
Equivalent Annual cost at the end of 1st year	(26,957 × 1.15)	31,000

2 nd Year		Amount (₹)
P.V. of salvage value at the beginning of 2nd year		25,000
Add: P. V. of Maintenance cost	(20,00/1.15)	17,391
		42,391
Less: P.V. of salvage value at the end of the 2 nd year	(15,000/1.15)	13,043
		29,348
Equivalent Annual cost at the end of 2 nd year	(29,348 × 1.15)	33,750



3 rd Year		Amount (₹)
P.V. of salvage value at the beginning of 3 rd year		15,000
Add: P. V. of Maintenance cost	(30,00/1.15)	26,087
		41,087
Less: P.V. of salvage value at the end of the 3 rd year	(10,000/1.15)	8,696
		32,391
Equivalent Annual cost at the end of 3 rd year	(32,391 × 1.15)	37,250

4 th Year		Amount (₹)
P.V. of salvage value at the beginning of 4 th year		10,000
Add: P. V. of Maintenance cost	(40,00/1.15)	34,783
		44,783
Less: P.V. of salvage value at the end of the 4 th year		Nil
		44,783
Equivalent Annual cost at the end of 4 th year	(44,783 × 1.15)	51,500

Analysis: Since the equivalent annual cost of new machine is lesser than that of existing machine, it is suggested to replace the existing machine with new machine. The equivalent annual cost of existing machine is higher in all the four years as compared to new machine.

Illustration 5.

A company is considering the purchase of a machine for ₹ 3,50,000. It feels quite confident that it can sell the goods produced by the machine as to yield an annual cash surplus of ₹ 1,00,000. There is however uncertainty as to the machine working life. A recently published Trade Association Survey shows that members of the Association have between them owned 250 of these machines and have found the lives of the machines vary as under:

No. of year of machine life	3	4	5	6	7	Total
No. of machines having given life	20	50	100	70	10	250

Assuming discount rate of 10% the net present value for each different machine life is follows:

Machine life	3	4	5	6	7
NPV (₹)	(1,01,000)	(33,000)	29,000	86,000	1,37,000

You required to advice whether the company should purchase a machine or not.

Answer:

Computation of NPV of an asset considering the probability of life of machine.

Year	Probability (a) ₹	NPV (b) ₹	Expected value (a × b)
3	20/250	(1,01,000)	(8,080)
4	50/250	(33,000)	(6,600)
5	100/250	29,000	11,600
6	70/250	86,000	24,080
7	10/250	1,37,000	5,480
			26,480

So, Assets should be purchased.

1.2 TARGET COSTING

Target Costing.

Target Costing: This technique has been developed in Japan. It aims at profit planning. It is a device to continuously control costs and manage profit over a product's life cycle. In short, it is a part of a comprehensive strategic profit management system. For a decision to enter a market prices of the competitors' products are given due consideration. Target Costing initiates cost management at the earliest stages of product development and applies it throughout the product life cycle by actively involving the entire value chain. In the product concept stage selling price and required profit are set after consideration of the medium term profit plans, which links the operational strategy to the long term strategic plans.

$$\text{Target Cost} = \text{Planned Selling Price} - \text{Required Profit.}$$

From this, the necessary target cost can be arrived at. Target cost, then, becomes the residual or allowable sum. If it is thought that the product cannot generate the required profit, it will not be produced as such and aspects of the product would be redesigned until the target is met. Value engineering and value analysis may be used to identify innovative and cost effective product features in the planning and concept stages. Throughout the product's life target costing continues to be used to control costs. After the initial start up stage target costs will be set through short-period budget. Thus all costs including both variable and fixed overheads are expected to reduce on a regular (monthly) basis. Target profit is a commitment agreed by all the people in a firm, who have any part to play in achieving it.

Features of Target Costing

Target Costing is defined as "a structured approach in determining the cost at which a proposed product with specified functionality and quality must be produced, to generate a desired level of profitability at its anticipated selling price." The main features or practices followed in Target Costing are

Step 1	Identify the market requirements as regards design, utility and need for a new product or improvements of existing product.
Step 2	Set Target Selling Price based on customer expectations and sales forecasts.
Step 3	Set Target Production Volumes based on relationships between price and volume.
Step 4	Establish Target Profit Margin for each product, based on the company's long term profit objectives, projected volumes, and course of action, etc.
Step 5	Set Target Cost (or Allowable cost) per unit, for each product. Target cost = Target selling price less Target profit margin
Step 6	Determine Current Cost of producing the new product, based on available resources and conditions.
Step 7	Set cost reduction Target in order to reduce the Current Cost to the Target Cost.
Step 8	Analyze the Cost Reduction Target into various components and identify cost reduction opportunities using Value Engineering (VE) and Value Analysis (VA) and Activity Based Costing (ABC)
Step 9	Achieve cost reduction and Target profit by Effective Implementation of Cost Reduction decisions
Step 10	Focus on further possibilities of cost reduction ie Continuous Improvement program.

Steps in Target Costing

Target Costing is viewed as integral part of the design and introduction of new products. It is part of an overall Profit Management Process, rather than simply a tool for cost Reduction and Cost Management.

Step 1: Customer product Design Specification:

- The customer requirements as to the functionality and quality of the product is of prime importance
- The design specification of the new product is based on customer's tastes, expectations and requirements.



- (c) Competitor's products and the need to have extra features over competitor's products are also considered. However the need to provide improved products, without significant increase in prices, should be recognized as charging a higher price may not be possible in competitive conditions.

Step 2 & Step 3: Market - Target Selling Price and Production Volume:

- (a) The Target Selling Price is determined using various sales forecasting techniques.
- (b) **The** price is also influenced by the offers of competitors, product utility, prices, volumes and margins.
- (c) In **view** of competition and elasticity of demand, the Firm has to forecast the price volume relationship **with** reasonable certainty. Hence the Target Selling Price is market driven and should encompass a realistic reflection of the competitive environment.
- (d) **Establishment** of Target Production Volumes is closely related to Target Selling price, given the **relationship** between price and volume.
- (e) **Target** Volumes are also significant in computation of unit costs particularly Capacity Related Costs **and Fixed Costs**. Product Costs are dependent upon the production levels over the life cycle of the product.

Step 4: Profitability - Target Profit Margin:

- (a) Since profitability is Critical for survival, a Target Profit Margin is established for all new products.
- (b) The Target Profit Margin is derived from the company's long term business plan, objectives **and** strategies.
- (c) Each product or product line is required to earn atleast the Target Profit Margin.

Step 5: Setting Target Costs:

- (a) The difference between the Target Selling Price and Target Profit Margin indicates the "Allowable Cost" for the product.
- (b) Ideally, the Allowable Cost becomes the "Target Cost for the product". However, the Target Cost may exceed the Allowable Cost, in light of the realities associated with existing capacities and capabilities.

Step 6: Computing Current Costs:

- (a) The "Current Costs" for producing the new product should be estimated.
- (b) The estimation of Current Cost is based on existing technologies and components, taking into account the functionalities and quality requirements of the new product.
- (c) Direct Costs are determined by reference to design specifications, materials prices, labour processing time and wage rates. Indirect Costs may be estimated using Activity Based Costing Principles.

Step 7: Setting Cost Reduction Targets:

- (a) The difference between Current Cost and Target Cost indicates the required cost reduction.
- (b) This amount may be divided into two constituents namely - a) Target Cost - Reduction Objective and b) Strategic Cost - Reduction Challenge.
- (c) The former is viewed as being achievable (yet still a very challenging target) while the latter acknowledges current inherent limitations.
- (d) After analyzing the Cost Reduction Objective, a Product-Level Target Cost is set which is the difference between the current cost and the target cost -reduction objective.

Step 8: Identifying Cost Reduction Opportunities:

- (a) After the Product-Level Target Cost is set, a series of analytical activities, commence to translate the cost challenge into reality.
- (b) These activities continue from the design stage until the point when the new product goes into production.
- (c) The total target is broken down into its various components, each component is studied and opportunities for cost reductions are identified.
- (d) These activities are referred to as a) Value Engineering (VE) and b) Value Analysis (VA).

Advantages of Target Costing

- Innovation:** It reinforces top-to-bottom commitment to process and product innovation, and is aimed at identifying issues to be resolved.
- Competitive Advantage:** It enables a Firm to achieve competitive advantage over other Firms in the industry. The firm which achieves cost reduction targets realistically stands to gain in the long run.
- Market Driven Management:** It helps to create a Company's competitive future with market-driven management for designing and manufacturing products that meet the price required for market success.
- Real Cost Reduction:** It uses management control systems to support and reinforce manufacturing strategies, and to identify market opportunities that can be converted into real savings to achieve the best value rather than simply the lowest cost.

Illustration 6.

B manufacturing company sells its product at ₹1,000 per unit. Due to competition, its competitors are likely to reduce price by 15%. B wants to respond aggressively by cutting price by 20% and expects that the present volume of 1,50,000 units p.a. will increase to 2,00,000. B wants to earn a 10% target profit on sales. Based on

Particulars	Existing (₹)	Target (₹)
Direct material cost per unit	400	385
Direct manufacturing labour per unit	55	50
Direct machinery costs per unit	70	60
Direct manufacturing costs per unit	525	495
Manufacturing overheads :		
No. of orders (₹80 per order)	22,500	21,250
Testing hours (₹2 per hour)	4,50,000	30,00,000
Units reworked (₹100 per unit)	12,000	13,000

Manufacturing overheads are allocated using relevant cost drivers. Other operating costs per unit for the expected volume are estimated as follows:

	Amount (₹)
Research and Design	50
Marketing and customer service	130
	180

Required:

- Calculate target costs per unit and target costs for the proposed volume showing break up of different elements.
- Prepare target product profitability statement.

Solution:

(i)

	Amount (₹)
Target selling price : ₹1,000 less 20%	800
Less: Target profit margin (10%)	80
Target costs per unit	720



The break-up of ₹ 720 per unit is as follows:

Target Costs per unit

Particulars	Per unit (₹)	
Direct materials		385
Direct manufacturing labour		50
Direct machining costs		60
Direct manufacturing costs		495
Add: Manufacturing overheads:		
Ordering and receiving	8.50	
(21,250 x ₹80) ÷ 2,00,000		
Testing and inspection	30.00	
(30,00,000 x ₹2) ÷ 2,00,000		
Rework	6.50	
(13,000 x ₹100) ÷ 2,00,000		45
Total manufacturing costs		540
Other operating costs:		
Research and Design	50	
Marketing and Customer service	130	180
Full Product Costs		720

(ii) Target Product Profitability

Particulars	Per unit	2,00,000 units
	(₹)	(₹)
1. Sales	800	16,00,00,000
2. Costs of goods sold:		
Direct materials	385	7,70,00,000
Direct labour	50	1,00,00,000
Direct machining costs	60	1,20,00,000
	495	9,90,00,000
Manufacturing overheads	45	90,00,000
	540	10,80,00,000
3. Gross margin (1-2)	260	5,20,00,000
4. Operating costs:		
Research and Design	50	1,00,00,000
Marketing and customer service	130	2,60,00,000
	180	3,60,00,000
5. Operating profit (3-4)	80	1,60,00,000

Illustration 7.

Desktop Co. manufactures and sells 7,500 units of a product. The full Cost per unit is ₹100. The Company has fixed Its price so as to earn a 20% return on an Investment of ₹ 9,00,000.

Required:

- (i) Calculate the Selling Price per unit from the above. Also, calculate the mark-up % on the Full Cost per unit.
- (ii) If the Selling Price as calculated above represents a mark-up % of 40% on Variable Cost per unit, calculate the Variable Cost per unit.



- (iii) Calculate the Company's Income if it had changed the Selling Price to ₹115. At this price, the Company would have sold 6,750 units.
- (iv) In response to competitive pressures, the Company must reduce the price to ₹105 next year, in order to achieve sales of 7,500 units. The company also plans to reduce its investment to ₹8,25,000. If a 20% return on Investment should be maintained, what is the Target Cost per unit for the next year?

Answer:

(i) Computation of Selling Price and mark - up % on the Full Cost per unit

Target Sale Price per unit = Full Cost + Target Profit = ₹100 + 24	₹124
So, Mark - up price is	24%

(ii) Computation of Variable Cost per unit:

Above sale Price ₹124 = VC + 40% thereon, i.e. 140% on VC. So, Var. Cost = $\frac{₹124}{140\%} = ₹89$

(iii) Calculate the company's Income if selling price are increased

Present Contribution at 7,500 units = (₹124 - ₹89) × 7,500 units = ₹2,62,500

Revised Contribution at 6,750 units = (₹115 - ₹89) × 6,750 units = ₹1,75,500
₹87,000

Hence, Increase in Sale Price is not beneficial. due to reduction in Contribution by ₹87,000

(iv) Calculate the company's Target Profit if selling price are reduced and Target cost if investment is ₹ 8,25,000

Target Profit for next year = $\frac{₹8,25,000 \times 20\%}{7500 \text{ units}} = ₹24$

Target cost = 105 - 24 = ₹ 83/unit

Illustration 8.

ABC Enterprises has prepared a draft budget for the next year follows:

Quantity	10,000 units
	(₹)
Sales price per unit	30
Variable costs per unit:	
Direct Materials	8
Direct Labour	6
Variable overhead (2 hrs × 0.50)	1
Contribution per unit	15
Budgeted Contribution	1,50,000
Budgeted Fixed costs	1,40,000
Budgeted Profit	10,000

The Board of Directors is dissatisfied with this budget, and asks working party to com up with alternate budget with higher target profit figures.

The working party reports back with he following suggestions that will lead to budgeted profit of ₹ 25,000. The company should spend ₹ 28,500 on advertising, & set the target sales price up to ₹ 32 per unit. It is expected that the sales volume will also rise, inspite of the price rise, to 12,000 units.

In order to achieve the extra production capacity, however, the workforce must be able to reduce the time taken to make each unit of the product. It is proposed to offer a pay and productivity deal in which the wage rate per hour in increased to ₹ 4. The hourly rate for variable overhead will be unaffected.

Ascertain the target labour time required to achieve the target profit.



Answer:

	₹	₹
Target profit	25,000	
Add: Fixed cost	1,40,000	
Add: Additional Advertisement	28,500	
Total contribution	1,93,500	
Sales volume	12,000	
Contribution per unit (₹ 1,93,500/12,000)	16.125	
Target Selling price per unit		32.000
Less: Contribution per unit		16.125
Target variable cost p.u.		15.875
Less: Material cost p.u.		8.000
Labour + Variable overhead p.u.		7.875

(1) Let revised labour time be x

Labour cost per hour = hour x ₹ 4 per hour = ₹ 4x
 Variable overhead per hour = hour ₹ 0.5 per hour = ₹ 0.5x

Total labour & variable overhead per hour = 4.5x
 Labour + variable cost / unit = ₹ 7.875
 Time required per unit = 7.875 = 4.5x or, x = 1.75 hrs.

(2) Time required to achieve the target profit

1.75 hours per unit
 So, for 12,000 units = 12,000 × 1.75 hour
 = 21,000 hours

Illustration 9.

You the manager of a paper mill (M Ltd) and have recently come across a particular type of paper, which is being sold at substantially lower rate (by another company -ABC Ltd) than the price charged by your ow mill. The value chain for one of tonne of such paper for ABC Ltd is follows,

ABC Ltd. → Merchant → Printer → Customer

ABC Ltd sells this particular paper to the merchant at the rate of ₹ 1,466 per tonne ABC Ltd pays for the freight which amounts to ₹ 30 per tonne

Average returns and allowances amount to 4% of sales and approximately equal ₹ 60 per tonne.

The value chain of your company, through which the paper reaches the ultimate customer is similar to the of ABC Ltd. However, your mill does not sell directly to the merchant, the latter receiving the paper from a huge distribution center maintained by your company at Haryana. Shipment costs from the mill to the Distribution Center amount to ₹ 11 per tonne while the operating costs in the Distribution Center have been estimated to be ₹ 25 per tonne. The return on investments required by the Distribution Center for the investments made amount to an estimated ₹ 58 per tonne.

You are required to compute the “Mill manufacturing Target Cost” for this particular paper for your company. You may assum that the return on the investment expected by your company equals Rs. 120 per tonne of such paper.

Answer:
Computation of Target Cost

Per tonne (in ₹)

ABC Ltd selling price to the merchant		1,466
Less: freight paid by ABC Ltd	30	
Less normal sales returns and allowances	60	
XYZ Ltds Capital charge	120	210
Target cost for XYZ Ltd		1256
Less: Shipment cost Distribution Centre	11	
Operating cost in the Distribution Centre	25	36
Distribution centre capital charge		1220
Less: Target manufacturing cost of the Mill		58
		1162

1.3 KAIZEN COSTING
Meaning of Kaizen Costing

Introduction: The initial VE review may not be complete and perfect in all cost aspects. There may be further chances of waste reduction, cost and time reduction and product improvement. Such continuous cost reduction technique is called as Kaizen Costing.

The review of product costs under the target costing methodology is not reserved just for the period up to the completion of design work on a new product. There are always opportunities to control costs after the design phase is completed, though these opportunities are fewer than during the design phase.

Meaning: Kaizen Costing refers to the ongoing continuous improvement program that focuses on the reduction of waste in the production process, thereby further lowering costs below the initial targets specified during the design phase. It is a Japanese term for a number of cost reduction steps that can be used subsequent to issuing a new product design to the factory floor.

Process of Kaizen Costing: Activities in Kaizen Costing include elimination of waste in production, assembly, and distribution processes, as well as the elimination of unnecessary work steps in any of these areas. Thus Kaizen Costing is intended to repeat many of the value engineering steps, continuously and constantly refining the process, thereby eliminating out extra costs at each stage.

Kaizen Costing Vs Value Engineering: Cost reductions resulting from Kaizen Costing are much smaller than those achieved with value engineering. But these are still significant since competitive pressures are likely to force down the price of a product over time, and any possible cost savings allow a Company to still attain its targeted profit margins.

Multiple Versions of Products - Continuous Kaizen Costing: Multiple improved versions of products can be introduced to meet the challenge of gradually reducing costs and prices. The market price of products continues to drop over time, which forces a Company to use both target and kaizen costing to reduce costs and retain its profit margin.

However, prices eventually drop to the point where margins are reduced, which forces the Company to develop a new product with lower initial costs and for which kaizen costing can again be used to further reduce costs. This pattern may be repeated many times as a Company forces its costs down through successive generations of products.

The exact timing of a switch to a new product is easy to determine well in advance since the returns from kaizen costing follow a trend line of gradually shrinking savings. Since prices also follow a predictable downward track, plotting these two trend lines into the future reveals when a new product version must be ready for production.



Experience of Kaizen Costing in Toyota.

Toyota's Experience of Kaizen Costing: Toyota aggressively pursued Kaizen Costing to reduce costs in the manufacturing phase. In July and January, Plant Managers submit six months plan for attaining their kaizen goal. Methods for achieving these goals include cutting material costs per unit and improvement in standard operating procedures. These are pursued based on employee's suggestions. For improvements involving industrial engineering and value engineering, employees often receive support from technical staff. To draw up a Kaizen plan after Kaizen goals have been set by top management, employees look for ways to contribute to Kaizen in their daily work. About two million suggestion were received from Toyota employees in t\one recent year alone roughly thirty-five per employee. Ninety-seven percent of them were adopted. This is really a prime example of concept of employee empowerment in which workers are encouraged to take their own initiatives to improve operations, reduce costs, and improve product quality and customer service.

Kaizen Costing and Standard Costing

Standard Costing is used in conjunction with management by exception (management's attention is directed towards situations where actual results differ from expected results). The expected results are based on standards, which have been derived from the capability of current organizational processes. Standard costing, therefore, reflects current level of performance and fails to provide any motivation to improve. A table given below set out principal differences between Kaizen Costing and Standard Costing:

Basis of Difference	Standard Costing	Kaizen Costing
Concepts	It is used for cost control	It is used for cost reduction.
	It is assumed that current manufacturing conditions remain unchanged.	It assumes continuous improvement.
	The cost focus is on standard costs based on static conditions	The cost focus is on actual costs assuming dynamic conditions
	The aim is to meet cost performance standards	The aim is to achieve cost reduction targets.
Techniques	Standards are set every six or twelve months	Cost reduction targets are set and applied monthly
	Costs are controlled using variance analysis based on standard and actual costs.	Costs are reduced by implementing continuous improvement (kaizen) to attain the target profit or to reduce the gap between target and estimated profit.
	Management should investigate and respond when standards are not met.	Management should investigate and respond when target kaizen amount are not attained.
Employees	They are often viewed as the cause of problems	They are viewed as the source of, and are empowered to find, the solutions.

1.4 VALUE ANALYSIS AND VALUE ENGINEERING

Value Analysis

The Value Analysis (VA) technique was developed after the Second World War in America at General Electric during the late 1940s. Since this time the basic VA approach has evolved and been supplemented with new techniques that have become available and have been integrated with the formal VA process. Today, VA is enjoying a renewed popularity as competitive pressures are forcing companies to re-examine their product ranges in an attempt to offer higher levels of customization without incurring high cost penalties. In parallel, many major corporations are using the VA process with their suppliers to extend the benefits of the approach throughout the supply chain. Businesses, big and small, will therefore benefit from understanding and applying the VA process.



It is likely that those companies that do not take the time to develop this capability will face an uncertain future as the lessons and problems of the past are redesigned into the products of the future.

Definition of Value Analysis

Value Analysis (VA) or Value Engineering (VE) is a function-oriented, structured, multi-disciplinary team approach to solving problems or identifying improvements. The goal of any VA Study is to:

-Improve value by sustaining or improving performance attributes

(of the project, product, and/or service being studied)

-while at the same time reducing overall cost

(including lifecycle operations and maintenance expenses).

Value Analysis can be defined as a process of systematic review that is applied to existing product designs in order to compare the function of the product required by a customer to meet their requirements at the lowest cost consistent with the specified performance and reliability needed.

This is a rather complicated definition and it is worth reducing the definition to key points and elements:

- (i) Value Analysis (and Value Engineering) is a **systematic, formal and organized process of analysis and evaluation**. It is not haphazard or informal and it is a management activity that requires planning, control and co-ordination.
- (ii) The analysis concerns the **function of a product** to meet the demands or application needed by a customer. To meet this functional requirement the review process must include an understanding of the purpose to which the product is used.
- (iii) Understanding the **use of a product** implies that specifications can be established to assess the level of fit between the product and the value derived by the customer or consumer.
- (iv) To succeed, the **formal management process must meet these functional specification** and performance criteria consistently in order to give value to the customer.
- (v) In order to yield a benefit to the company, the formal review process must result in a **process of design improvements** that serve to lower the production costs of that product whilst maintaining this level of value through function.

Defining Cost and Value

Any attempt to improve the value of a product must consider two elements, the first concerns the use of the product (known as **Use value**) and the second source of value comes from ownership (**Esteem value**). This can be shown as the difference between a luxury car and a basic small car that each has the same engine. From a use point of view both cars conduct the same function – they both offer safe economical travel (**Use value**) – but the luxury car has a greater **esteem value**. The difference between a gold-plated ball pen and a disposable pen is another example. However, use value and the price paid for a product are rarely the same, the difference is actually the esteem value, so even though the disposable pen is priced at X the use value may be far less.

It is important for all managers to understand the nature of costs in the factory and for any given product. Whilst there is no direct relationship between 'Cost' (for the factory) and customer 'Value' in use and esteem, this education process is important. A shocking figure, that is often used as a general measure, is that typically 80% of the manufacturing costs of a product will be determined once the design drawing has been released for manufacturing.

The costs of production are therefore 'frozen' and determined at this point. These costs include the materials used, the technology employed, the time required to manufacture the product and such like. Therefore, the design process creates many constraints for the business and fixes a high degree of the total product cost. It is therefore a process that demands periodic review in order to recover any 'avoidable' costs that can be removed throughout



the life of the product (by correcting weaknesses or exploiting new processes, materials or methods) and lowering the costs of production whilst maintaining its Use value to the customer.

Basically, there are three key costs of a product:

- **Cost of the parts purchased:** These are costs associated with the supply of parts and materials.
- **Cost of direct labour** used to convert products.
- **Cost of factory overheads** that recover the expenses of production.

Although there are three elements of total cost accumulation it is traditionally the case that cost reduction activities have focused on the labour element of a product. Activities such as work-study, incentive payments and automation have compressed labour costs and as a result there is little to be gained, for most companies, in attempting to reduce this further. Instead, comparatively greater gains and opportunities lie in the redesign and review of the products themselves to remove unnecessary materials and overhead costs. This approach to the 'total costs' of a product involves taking a much broader look at the way costs in the factory accumulate and the relationship between costs and value generation. These new sources of costs and evaluations would therefore include such sources as:

- **Cost of manufacture**
- **Cost of assembly**
- **Cost of poor quality**
- **Cost of warranty**

A detailed understanding of how costs are rapidly accumulated throughout the process of design to the despatch of the product is key to exploiting the process of VA. All VA activities are aimed at the reduction of avoidable and unnecessary costs, without compromising customer value, and therefore the VA process should target the largest sources of potential cost reduction rather being an indiscriminate or unsystematic process (such as focusing on labour alone). It is therefore preferable to take the holistic approach to understanding costs and losses in the 'entire system' of design and conversion of value in order to determine how to achieve customer service 'functionality' at a minimal cost per unit.

The Focus of Value Analysis

The key focus of the VA approach is therefore the management of 'functionality' to yield value for the customer. Let us emphasize this point a little. Not that long ago, consumers of electric kettles were offered a variety of different types of metal-based boiling device. The value of a kettle is derived through heating water and therefore its functionality can be determined (temperature, capacity, reliability, safety etc.). Now faced with the same functionality (to boil water), designers would probably look towards a kettle made of plastic.

Plastic has the same functionality as metal in terms of containing and boiling water. The action to boil water is conducted by the same part - known as the element. However the switch from metal to plastic does not impair this value and functionality with the customer – they still want to boil water - but it does result in a cost saving for the manufacturing company. If a company that traditionally made metal kettles did not review its design process then it would be severely disadvantaged when attempting to compete against the lower cost plastic alternative. This is a simple example used only to provide an illustration of the VA concept but it does demonstrate the point of maintaining value whilst reducing costs.

If a company seeks to reduce the costs of producing a product then it must seek out costs that are unnecessary or items of the product that provide no functional value to the customer. If you adopt this approach then the VA process is concerned with removing a specific type of cost. This cost is one that can be removed without negatively affecting the function, quality, reliability, maintainability or benefit required by the customer. As such, the target for all VA activities is to find these costs as opposed to simply re-engineering a product design with no real purpose to the re-engineering exercise. The VA approach is therefore formal and systematic because it is directed towards highlighting and dealing with these 'recoverable costs' of production. The objective is to create



value for money as opposed to creating new products that do not provide customer satisfaction but are relatively inexpensive.

The rules governing the application of the VA approach are therefore simple:

- **No cost can be removed if it compromises the quality of the product or its reliability**, as this would lower customer value, create complaints and inevitably lead to the withdrawal of the product or lost sales.
- **Saleability is another issue that cannot be compromised**, as this is an aspect of the product that makes it attractive to the market and gives it appeal value.
- **Any activity that reduces the maintainability of the product increases the cost of ownership** to the customer and can lower the value attached to the product.

Types of Value Analysis Exercises

VA for Existing Products

One of the best approaches to VA is simply to select an existing product that is sold in relatively large volumes. This product, or product family, will tend to have a great deal of the basic information, and documented history, which can be used quickly as opposed to a newly introduced product where such a history is not available. An existing product unites all the different managers in a business, each with an opinion and list of complaints concerning the ability to convert the design into a 'saleable' product. Therefore any team that is created for the purpose of VA will understand their own problems but not necessarily the cause of these problems across the entire business. These opinions regarding poor performance (and documented evidence of failures) are vital to the discussions and understanding of how the product attracts costs as it is converted from a drawing to a finished product. These discussions therefore allow learning to take place and allow all managers to understand the limitations to the scope of product redesign and re-engineering activities. These issues include:

- The inability to change existing product designs due to the need to redesign tooling and the expense of such an initiative.
- The project team may have a finite duration before the project is concluded and therefore time will dictate what can be achieved.
- The high levels of purchased costs may imply a need to engage with suppliers in the VA process. This initiative will be constrained by a number of issues such as the timing of the project, the availability of resources from the supplier, the location of the suppliers, and other constraints.

VA for New Products – Value Engineering

For new products, the team will need to modify the VA approach and will operate in an environment that is less certain and has poor levels of available information upon which to make decisions. In this case, the analysis and systematic process of review for new products is known as Value Engineering (VE). The VE approach is similar to that of Value Analysis but requires a much greater level of investment by the organization in terms of the skilled, experienced and proficient human resources seconded to the group.

VA for Product Families- Horizontal Deployment

The final form of VA is results when there is scope for the 'horizontal deployment' of the results of a VA exercise with a single product or family of products. Under conditions where the value analysis project team finds commonalties with many products manufactured by the company, then it is possible to extend the benefits to all these other products concurrently. In this manner, all affected products can be changed quickly to bring major commercial benefits and to introduce the improvement on a 'factory-wide basis'. This is particularly the case when supplying companies offer improvements that affect all the products to which their materials or parts are used. The horizontal deployment activity has many advantages both in terms of financial savings and also the relatively short amount of time required to introduce the required changes to the product design.



Competitive VA

VA techniques are not simply the prerogative of the business that designed the product. Instead VA is often used as a competitive weapon and applied to the analysis of competitor products in order to calculate the costs of other company's products. This is often termed 'strip down' but is effectively the reverse value analysis. Here the VA team are applied to understanding the design and conversion costs of a competitor product. The results of the analysis is to understand how competitor products are made, what weaknesses exist, and at what costs of production together with an understanding of what innovations have been incorporated by the competitor company.

It is recommended that the best initial approach, for companies with no real experience of VA, is to select a single product that is currently in production and has a long life ahead. This approach offers the ability to gain experience, to learn as a team, and to test the tools and techniques with a product that has known characteristics and failings. In the short term it is most important to develop the skills of VA, including understanding the right questions to ask, and finally to develop a skeleton but formal process for all VA groups to follow and refine.

How to use Value Analysis

Keys to Success

There are many keys to the success of a VA programme and it is wise to consider these issues before commencing the project, as errors in the project plan are difficult to correct, without causing frustration, once the VA project has started. One of the most important initial steps in developing the VA process is to create a formal team of individuals to conduct the exercise. These individuals must be drawn from different parts of the business that affect the costs associated with design, manufacturing, supply and other relevant functions. In addition, the team must be focused on a product or product family in order to begin the exercise. Further key success factors include:

- **Gain approval of senior management** to conduct a Value Analysis exercise. Senior management support, endorsement and mandate for the VA project provides legitimacy and importance to the project within the business. This approval process also removes many of the obstacles that can prevent progress from being made by the team.
- **Enlist a senior manager as a champion** of the project to report back directly to the board of directors and also to act as the programme leader.
- Once a programme team has been developed it is important to **select an operational leader** to co-ordinate the efforts, monitor progress and to support the project champion.

This leader will remain with the VA team throughout the life of the project and will be the central linking pin between the team and the senior management champion.

- **Establish the reporting procedure** for the team and the timing of the project. This project plan needs to be formal and displayed as a means of controlling and evaluating achievements against time.
- **Present the VA concept and objectives of the team to all the middle and senior managers** in the business. Widespread communication of the VA project is important so that other employees, particularly managers (who may not be involved directly with the process) understand the need to support the project either directly by assigning staff or indirectly through the provision of data.
- Maintain a list of those business functions that should receive a **regular communication of progress** even though they may not be directly involved with the project. This process allows other individuals in the business to be informed about the progress and findings of the group. This form of promotion is important as it maintains a momentum and communicates the findings of the team as widely as possible.
- **Provide an office space and co-locate the team members** where practical and possible to do so. The ability to locate a VA improvement group in one area of the business is important and assists the communication within the group. A convenient area can also be used to dismantle the product and also the walls of the area can be used to record, on paper charts, the issues that have been discovered by the team (and the associated actions that must be undertaken).



- **Select the product** for the first study. Ideally the existing product, or family of products, will be one that is established, sells in volume and has a relatively long life expectancy.
As such any improvement in the cost performance of the product will provide a large financial saving to the business.
- Write down the **objectives of the project** and the key project review points. Estimate the targets to be achieved by the project. These objectives provide a reference point and framework for the exercise. The objectives also focus attention on the outputs and achievements required by the company.
- **Select and inform any personnel** who will act in a part time or temporary role during the project. This process is used to schedule the availability of key specialist human resources to support the team throughout the duration of the project.
- **Train the team** in both the process of VA and also in basic team building activities. It is important that all members understand the nature of the project and its importance. The initial team building exercises are also a good way of understanding the attitude of all members to the project – especially those with reservations or a negative attitude to what can be achieved. As with most team exercises there is a requirement to allow the team to build and bond as a unit. It is often difficult for individuals, drawn from throughout the factory, to understand the language that is used throughout the business and also to understand the 'design to market' process when their own role impacts on a small section of this large and complex process.

Value Engineering

Value Engineering is an organized/systematic approach directed at analyzing the function of systems, equipment, facilities, services, and supplies for the purpose of achieving their essential functions at the lowest life-cycle cost consistent with required performance, reliability, quality, and safety. Society of Japanese Value Engineering defines VE as:

"A systematic approach to analyzing functional requirements of products or services for the purposes of achieving the essential functions at the lowest total cost".

Value Engineering is an effective problem solving technique. Value engineering is essentially a process which uses function analysis, team-work and creativity to improve value. Value Engineering is not just "good engineering." It is not a suggestion program and it is not routine project or plan review. It is not typical cost reduction in that it doesn't "cheapen" the product or service, nor does it "cut corners."

Value Engineering simply answers the question "what else will accomplish the purpose of the product, service, or process we are studying?". VE technique is applicable to all type of sectors. Initially, VE technique was introduced in manufacturing industries. This technique is then expanded to all type of business or economic sector, which includes construction, service, government, agriculture, education and healthcare.

Aadarsh Instruments, located in Ambala, is a medical instrument manufacturing company considered to apply Value Engineering in to the Focus Adjustment Knob in one of their model SL 250 for Slit Lamp in microscope. This microscope has found application in the field of eye inspection. The value engineering analysis may help company in running its export business of medical microscope. This firm is producing different types of microscopes which they export to various countries around the globe. All of the products manufactured here are conforming to the international standards. It is an ISO certified company.

The total savings after the implementation of value engineering are as given below:

- Cost before analysis — ₹ 29.99
- Total Cost of Nylon Knob — ₹ 18.40
- Saving per product — ₹ 11.59
- Percentage saving per product — 38.64%
- Annual Demand of the product — 8,000



- Total Annual Saving — ₹ 92,720
- Value Improvement — ₹ 62.98%

What are the steps to be followed for doing Value Engineering? How can you conclude the decision on the basis of the above Value Engineering?

Answer:

The following are the steps to be used for carrying out the Value Engineering exercise by Aadarsh Instruments in their model SL 250 for Slit Lamp in Microscope for the Focus Adjustment Knob:

- (i) Selection of the Product Plan.
- (ii) Gathering Product Information
- (iii) Functional Analysis
- (iv) Creativity Phase and preparing the work-sheet
- (v) Evaluation Sheet
- (vi) Cost Analysis
- (vii) Result and Conclusion
- (viii) Implementation.

Conclusion: Value Engineering methodology is a powerful tool for resolving system failures and designing improvements in performance of any process, product, service or organization. In the Case Study discussed under the question, we have used the concept of Value Engineering to analyze the Focus Adjustment Knob of SL 250 Slit Lamp Microscope. With a critical evaluation of this study, we have been able to increase the value of the product by substituting another material in place of the one currently in use. The % value improvement is to the tune of 62.98% and the total annual saving has been ₹ 92,720.

The various advantages have been observed in terms of:

- Cost Reduction
- Increase in overall production
- Reduction in man-power
- Reduction in scrap.

Thus the cost has been brought down by a substantial margin and thereby the value of the product has been increased.

1.5 THROUGHPUT COSTING

Throughput Accounting is a management accounting technique used as a performance measure in the theory of constraints. It is the business intelligence used for maximizing profits. It focuses importance on generating more throughput. It seeks to increase the velocity or speed of production of products and services keeping in view of constraints. It is based on the concept that a company must determine its overriding goal and then it should create a system that clearly defines the main capacity constraint that allows it to maximize that goal. The changes that this concept causes are startling.

Throughput accounting is a system of performance measurement and costing which traces costs to throughput time. It is claimed that it complements JIT principles and forces attention to the true determinants of profitability. Throughput accounting is defined as follows:

"A management accounting system which focuses on ways by which the maximum return per unit of bottleneck activity can be achieved" – CIMA Terminology.



Throughput Concepts:

A few new terms are used in throughput accounting. They are explained as below:

Throughput:

Throughput is the excess of sales value over the totally variable cost. That is nothing but contribution margin left after a product's price is reduced by the amount of its totally variable cost.

Totally Variable Cost:

This cost is incurred only if a product is produced. In many cases only direct materials are considered as totally variable cost. Direct labour is not totally variable, unless piece rate wages are paid.

Capacity Constraints:

It is a resource within a company, that limits its total output. For example, it can be a machine that can produce only a specified amount of a key component in a given time period, thereby keeping overall sales from expanding beyond the maximum capacity of that machine. There may be more than one capacity constraint in a company, but rarely more than one for a specified product or product line.

Throughput (or Cycle) Time:

Throughput (or cycle) time is the average time required to convert raw materials into finished goods ready to be shipped to customer. It includes the time required for activities such as material handling, production processing, inspecting and packaging.

Throughput Efficiency:

Throughput efficiency is the relation of throughput achieved to resources used.

$$\text{Throughput efficiency} = \frac{(\text{Throughput cost})}{(\text{Actual factory cost})}$$

Throughput Time Ratio:

It is the ratio of time spent adding customer value to products and services divided by total cycle time. It is also known as the 'ratio of work content to lead time'.

Operating Expenses:

This is sum total of all company expenses including totally variable expenses. It should be noted that throughput accounting does not care, if a cost is semi-variable, fixed or allocated – all costs that are not totally variable is lumped together for throughput accounting purpose. This group of expenses is considered the price that a company pays to ensure that it maintains its current level of capacity.

Investment:

This term is used here also, as it is used in common parlance, i.e. any application of funds, which is intended to provide a return by way of interest, dividend or capital appreciation. However, there is a particular emphasis on company's investment in working capital. This is discussed subsequently in discussion about throughput model.

Total Factory Cost:

With the exception of material costs, in the short run, most factory costs (including direct labour) are fixed. These fixed costs can be grouped together and called total factory costs (TFC).

Manufacturing Response Time:

With JIT, products should not be made, unless there is a customer waiting for them, because the ideal inventory level is zero. The effect of this will be that there will be idle capacity in some operations except the operation, which is bottleneck of the moment. Working on output just to increase WIP or Finished Goods stocks creates no profit and so would not be encouraged. This means that profit is inversely proportional to the level of inventory in the system. It can be expressed as follows:



$$\text{Profit} = f = \left[\frac{1}{\text{MRT}} \right]$$

where, MRT = Manufacturing Response Time

Profitability:

This concept emphasizes that profitability is determined by how quickly goods can be produced to satisfy customer's order. Production for stock does not create profits. Improving the throughput of bottleneck operations will increase the rate at which customer demand can be met and this will improve profitability. Contribution in its traditional form (sales – variable costs) is not a good guide or profitability because it ignores capacity factors and rate of production.

$$\text{Return per factory hour} = \left[\frac{\text{Sales Prices} - \text{material Cost}}{\text{Time on key resource i.e., the bottleneck}} \right]$$

Product costs are measured thus:

$$\text{Cost per factory hour} = \left[\frac{\text{Total factory costs (TFC)}}{\text{Total time available on the key resource}} \right]$$

The return and cost per factory hour are combined into the throughput accounting ratio as follows:

$$\text{TA} = \left[\frac{\text{Return per factory hour (or minute)}}{\text{Cost per factory hour (or minute)}} \right]$$

The TA ratio should be greater than 1. If it is less than 1 the product will lose money for the company and the company should consider withdrawing it from the market.

Using TA, value is not created until products are sold. Thus items made for stock produce no return and depress the TA ratio. This should prompt managers to use their limited bottleneck resource to produce products for which customer demand exists. The TA ratio can be considered in total terms and compares the total return from the throughput to TFC, i.e.,

$$\text{Primary TA Ratio} = \left[\frac{\text{Return from total throughput (i.e., Sales-Material Costs)}}{\text{(TFC (i.e., all costs other than materials))}} \right]$$

Throughput Accounting and Contribution Approach:

Throughput accounting has certain similarities with the traditional approach of maximizing contribution per unit of scarce resource. However, there are certain differences. In throughput accounting, return is defined as sales less material costs in contrast to contribution, which is sales less all variable costs, i.e., material, labour, overheads. The assumption (i.e., emphasis) in throughput accounting is that all costs except material are fixed in relation to throughput in short run. Eminent management accountants like Kaplan and Shank have criticized TA for its short-term emphasis. Besides, TA does not appear to be useful in JIT environment. Throughput helps to direct attention to bottlenecks and forces management to concentrate on the key elements in making profits and approach adopted to gain this objective is reduction in inventory and reducing response time to customer demand.

Basic logic of throughput costing and comparison with absorption costing:

Throughput costing assigns only unit level spending for direct costs as the cost of products or services. Advocates of throughput costing argue that adding any other indirect cost, past or committed cost, to product cost creates improper incentives to drive down the average cost per unit by making more products than can be used or sold. Since these are committed costs, making more units with the same level of spending arithmetically reduces the average cost per unit and makes the production process appear to be more efficient. Throughput accounting (costing) avoids this incentive because the cost per unit depends only on the unit level spending (i.e., cost of materials) not how many units are made. Using throughput accounting (costing) means that cost management analyst must distinguish between



- (a) Spending for resources caused by the decision to produce different levels of products and services, and
- (b) The use of resources that organisation has committed to supply regardless of level of products and services provided.

Steps to be followed to increase the throughput:

The theory of constraints is applied within an organisation by following what are called 'the five focusing steps.' These are a tool that Goldratt developed to help organisations deal with constraints, otherwise known as bottlenecks, within the system as a whole (rather than any discrete unit within the organisation.) The steps are as follows:

- (a) Identify the bottle neck in the system i.e., identification of the limiting factor of the production (or) process such as installing capacity or hours etc.
- (b) Decide how to exploit the systems bottleneck that means bottleneck resource should be actively and effectively used as much as possible to produce as many goods as possible.
- (c) Subordinate everything else to the decision made in step (b). The production capacity of the bottleneck resource should determined production schedule.
- (d) Augment the capacity of the bottleneck resource with the minimum capital input.
- (e) Identify the new bottlenecks in the process and repeat the same above steps to address the bottlenecks.

Problems with throughput accounting:

- 1. When throughput accounting is the driving force behind all production scheduling, a customer that has already placed an order for a product, which will result in a sub-optimal profit level for the manufacturing, may find that its order is never filled.
- 2. The company's ability to create the highest level of profitability is now dependent on the production scheduling staff, who decides, what products are to be manufactured and in what order.
- 3. Another issue is that all costs are totally variable in the long-run since the management then, has the time to adjust them to long-range production volumes.

Reporting under throughput accounting:

When the throughput model is used for financial reporting purposes, the format appears slightly different. The income statement includes only direct materials in the cost of goods sold, which results in a 'throughput contribution instead of gross margin. All other costs are jumped into an 'Operating Expenses' category below the throughput contribution margin, yielding a net income figure at the bottom. All other financial reports stay the same. Though this single change appears relatively minor, it has significant impact. *The primary change is that throughput accounting does not charge any operating expenses to inventory so that they can be expressed in future period. Instead, all operating expenses are realized during the current period.* As a result, any incentive for managers to over produce is completely eliminated because they cannot use the excess amount to shift expenses out of current period, thereby making their financial results look better than they would otherwise. Though this is a desirable result, such a report can be used only for internal reporting because of the requirement of generally accepted accounting principles that some overheads should be charged to excess production.

Systematic changes required for acceptance of the throughput accounting:

Throughput accounting does not have a logical linkage with the more traditional form of cost accounting. This makes it difficult for it to gain acceptance. The main problem is that this method does not use cost as the basis for the most optimal production decisions. This is entirely contrary to the teachings of any other type of accounting, which holds that the highest margin products should always be produced first. Now question is whether the enterprise should either use throughput or traditional costing exclusively or is there any way to merge the two. Following discussion relates to this issue:

(a) Inventory Valuation:

Generally accepted accounting principles clearly state that cost of overhead must be apportioned to inventory. Throughput accounting states that none of the overhead cost should be so assigned. In this case, since the rules are so clear, it is apparent that throughput accounting loses. The existing system must continue to assign costs irrespective of how throughput principles are used for other decision making (short-range) activities.

**(b) Inventory Investment Analysis:**

There are fundamental differences between the two methodologies. Both hold that the objective is always to keep one's investment at a minimum. In the case of traditional cost accounting, this is because the return on investment is higher when the total amount of investment is forced to the lowest possible level. Throughput accounting, however, wants to shrink the amount of investment because it includes work-in-progress inventory in this category. It tries to keep WIP levels down so that waste is reduced in the production system. In short, first system advocates a small investment for financial reasons, while later system favours it because it makes more operational sense. Despite the differences in reasoning, the same conclusion is reached by both methodologies. However, throughput approach is still better, for it forces one to analyse all inventory reduction projects in light of how they together will impact the capacity constraint rather than individually.

(c) Capital Investment Analysis:

Traditional cost accounting only analyses each investment proposal on its own rather than considering its impact on the production processes as a whole. It tends to recommend investments that will result in an incremental investment but no overall change in the level of corporate capacity, which is driven by capacity constraint. Throughput accounting, however, has a tight focus on investment only in areas that impact capacity constraint – to other investment proposals are rejected. In this instance, it is best to reject the traditional system and conduct analysis based on throughput principles.

(d) Product Costing:

Under throughput accounting, a product has only a totally variable cost, which may be far lower than the fully absorbed cost, that would be assigned to it under more traditional costing system. This totally variable cost is almost always direct materials, which is an easily calculated figure. Full absorption costing, however, requires a large amount of calculation effort, before a detailed cost can be compiled for a product. For companies selling to Government under cost-plus contracts, there are lengthy detailed requirement as to what variable and overhead costs should be assigned to each product manufactured. These rules virtually require the use of absorption costing – throughput costing is not a viable solution. For companies, that do not require detailed costing justifications while selling their products, it may be possible to use the much simpler throughput accounting approach.

(e) Production Scheduling:

Traditional systems do not include any kind of throughput accounting, that tells production planners which orders should be produced first. These days with throughput accounting, it is possible to customize existing systems or to upgrade packaged software so that this option is available to planner. This would allow them to produce the items that result in the highest throughput per minute of the capacity constraint. Here it is difficult to fully support the throughput approach. Any company that has already received a customer has an obligation to fill it, even if the resulting sale will reduce its overall level of profit from the theoretical maximum that can be calculated with throughput accounting. Maximising short-term profit by ignoring orders is tantamount to long-term suicide since customers will leave in droves. Consequently, production planners should be left alone to schedule production in the traditional manner rather than basing their decisions on short-term profit maximisation.

(f) Long-term planning:

This is the main application area of throughput accounting. The enterprise should estimate the approximate sales levels for each product for a long-time frame enter into a throughput model and determine what mix of prospective sales will result in the highest level of profitability. This method is much superior to use of throughput costing for short-term production decisions, since long-term planning sidesteps problems by avoiding existing customer orders that will result in low profits. Long-term planning does not involve existing customer orders so that decisions to produce various types of products at different price points can be made before the sales force goes out to obtain orders.

(g) Price Setting:

Throughput accounting is favoured by the sales and marketing staff favours throughput accounting because the margin on products is simple to obtain-just subtract totally variable costs from the price. This beats the incomprehensible image of allocations accompanying activity based costing. Price setting in throughput environment focuses more on what products can be inserted into the existing production mix at a price that



will incrementally increase overall profitability, rather than the painful accumulation and allocation of costs to specific products. Throughput accounting is the clear choice here based on case of understandability and the speed with which information can be accumulated.

Illustration 10.

Modern Co produces 3 products, A, B and C, details of which are shown below:

Particulars	A	B	C
Selling price per unit (₹)	120	110	130
Direct material cost per unit (₹)	60	70	85
Variable overhead (₹)	30	20	15
Maximum demand (units)	30,000	25,000	40,000
Time required on the bottleneck resource (hours per unit)	5	4	3

There are 3,20,000 bottleneck hours available each month.

Required:

Calculate the optimum product mix based on the throughput concept.

Solution:

Particulars	A	B	C
Selling price per unit (₹)	120	110	130
Direct material cost per unit (₹)	60	70	85
Throughput per unit (₹)	60	40	45
Time required on the bottleneck resource (hours per unit)	5	4	3
Return per factory hour (₹)	12	10	15
Ranking	2	3	1
Total Available hours		= 3,20,000	

(-) Hours used for C (40,000 x 3) = 1,20,000

(-) Hours used for A (30,000 x 5) = 1,50,000 = 2,70,000

Balance hours available for B = 50,000

No. of units that can be made in balance hours = 50,000/4 = 12,500 units.

Statement showing optimum mix:

	A	B	C
No. of units	30,000	12,500	40,000

Illustration 11.

Cat Co makes a product using three machines – X, Y and Z. The product has to pass through all the three machines. The capacity of each machine is as follows:

	X	Y	Z
Machine capacity per week (in units)	800	600	500

The demand for the product is 1,000 units per week. For every additional unit sold per week, profit increases by ₹ 50,000. Cat Co is considering the following possible purchases (they are *not* mutually exclusive):

Purchase 1 Replace machine X with a newer model. This will increase capacity to 1,100 units per week and costs ₹ 60 Lakhs.



Purchase 2 Invest in a second machine Y, increasing capacity by 550 units per week. The cost of this machine would be ₹ 68 Lakhs.

Purchase 3 Upgrade machine Z at a cost of ₹ 75 Lakhs, thereby increasing capacity to 1,050 units.

Required:

Which is Cat Co's best course of action under throughput accounting?

Solution:

Since the product has to pass through all the machines, machine capacity is the bottleneck.

Bottleneck resource in order of preference is firstly machine 'Z', secondly machine 'Y' and lastly machine 'X' because the no. of units are in that order in the existing capacity.

Particulars	X	Y	Z	Demand
Current capacity per week	800	600	500*	1,000
Buy Z	800	600*	1,050	1,000
Buy Z & Y	800*	1,150	1,050	1,000
Buy Z, Y & X	1,100	1,150	1,050	1,000*

* = bottleneck resource

All the three machines to be purchased in the above order to meet the existing demand.

Illustration 12.

A factory has a key resource (bottleneck) of Facility A which is available for 31,300 minutes per week. Budgeted factory costs and data on two products, X and Y, are shown below:

Product	Selling Price/Unit	Material Cost/Unit	Time in Facility A
X	₹ 35	₹ 20.00	5 minute
Y	₹ 35	₹ 17.50	10 minutes

Budgeted factory costs per week:

	₹
Direct labour	25,000
Indirect labour	12,500
Power	1,750
Depreciation	22,500
Space costs	8,000
Engineering	3,500
Administration	5,000

Actual production during the last week is 4,750 units of product X and 650 units of product Y. Actual factory cost was ₹ 78,250.

Calculate:

- (i) Total factory costs (TFC)
- (ii) Cost per Factory Minute
- (iii) Return per Factory Minute for both products
- (iv) TA ratios for both products.
- (v) Throughput cost per the week.
- (vi) Efficiency ratio

**Solution:**

- (i) Total Factory Costs = Total of all costs except materials.
 = ₹ 25,000 + ₹ 12,500 + ₹ 1,750 + ₹ 22,500 + ₹ 8,000 + ₹ 3,500 + ₹ 5,000.
 = ₹ 78,250
- (ii) Cost per Factory Minute = Total Factory Cost ÷ Minutes available
 = ₹ 78,250 ÷ 31,300 = ₹ 2.50
- (iii)
- (a) Return per bottleneck minute for Product X = $\frac{\text{Selling Price} - \text{Material Cost}}{\text{Minutes in bottleneck}}$
 = (35 – 20) / 5 = ₹ 3
- (b) Return per bottleneck minute for Product Y = $\frac{\text{Selling Price} - \text{Material Cost}}{\text{Minutes in bottleneck}}$
 = (35 – 17.5) / 10 = ₹ 1.75
- (iv) Throughput Accounting (TA) Ratio for Product X = $\frac{\text{Return per Minute}}{\text{Cost per Minute}}$
 = (3 / 2.5) = ₹ 1.2
- Throughput Accounting (TA) Ratio for Product Y = $\frac{\text{Return per Minute}}{\text{Cost per Minute}}$
 = (1.75 / 2.5) = ₹ 0.7

Based on the review of the TA ratios relating to two products, it is apparent that if we only made Product Y, the enterprise would suffer a loss, as its TA ratio is less than 1. Advantage will be achieved, when product X is made.

- (v) Standard minutes of throughput for the week:
 = [4,750 x 5] + [650 x 10] = 23,750 + 6,500 = 30,250 minutes
- Throughput cost per week:
 = 30,250 x ₹ 2.5 per minutes
 = ₹ 75,625
- (vi) Efficiency % = (Throughput cost / Actual TFC) %
 = (₹ 75,625 / ₹ 78,250) x 100
 = 96.6%

The bottleneck resource of Facility A is available for 31,300 minutes per week but produced only 30,250 standard minutes. This could be due to:

- (a) the process of a 'wandering' bottleneck causing facility A to be underutilized.
 (b) inefficiency in facility A.

Illustration 13.

Given below is the basic data relating to New India Company for three years:

	Year1	Year 2	Year 3
Production and Inventory data			
Planned production (in units)	2,500	2,500	2,500
Finished goods inventory (in units), Jan 1	0	0	750
Actual production (in units)	2,500	2,500	2,500
Sales (in units)	2,500	1,750	3,250
Finished goods inventory (in units), Dec 31	0	750	0

Revenue and cost data, all three-years			₹
Sales price per unit			<u>48</u>
Manufacturing costs per unit			
Direct material			12
Direct labour			8
Variable manufacturing overhead			<u>4</u>
Total variable cost per unit			24
Used only under absorption costing:			
Fixed manufacturing overhead = Annual fixed OH / Annual Production			<u>12</u>
= ₹ 30,000 / ₹ 2,500			<u>36</u>
Total absorption cost per unit			
Variable selling and administrative cost per unit			<u>4</u>
Fixed selling and administrative cost per year			5,000

You are required to Prepare:

- Absorption Costing Income Statement
- Variable Costing Income Statement.
- Reconciliation of Income under Absorption and Variable Costing.
- Throughput Costing Income Statement and Comment how it is relatively more useful.

Draw your conclusion.

Solution:

Actual production is 2500 units in each year.

- Absorption Costing Income Statement

New India Company

Income Statement as per Absorption Costing

Particulars	Year 1	Year 2	Year 3
	₹	₹	₹
Sales revenue (at ₹ 48 per unit)	1,20,000	84,000	1,56,000
Less: Cost of goods sold (at absorption cost of ₹ 36 per unit)	90,000	63,000	1,17,000
Gross margin	30,000	21,000	39,000
Less: Selling and administrative expenses:			
Variable (at ₹ 4 per unit)	10,000	7,000	13,000
Fixed	5,000	5,000	5,000
Operating Income	15,000	9,000	21,000

**(b) Variable Costing Income Statement**

New India Company
Income Statement as per Variable Costing

Particulars	Year1	Year 2	Year 3
	₹	₹	₹
Sales revenue (at ₹ 48 per unit)	1,20,000	84,000	1,56,000
Less: Variable expenses:			
Variable manufacturing costs (at variable cost of ₹ 24 per unit)	60,000	42,000	78,000
Variable selling & admn. Costs (at ₹ 4 per unit)	10,000	7,000	13,000
Contribution margin	50,000	35,000	65,000
Less: Fixed expenses :			
Fixed manufacturing overhead	30,000	30,000	30,000
Fixed selling & admn. Expenses	5,000	5,000	5,000
Operating Income	15,000	0	30,000

(c) Reconciliation of Income under Absorption and Variable Costing

New India Company
Reconciliation of Income under Absorption and Variable Costing

Particulars	Year1	Year 2	Year 3
	₹	₹	₹
Cost of goods sold under absorption costing	90,000	63,000	1,17,000
Variable manufacturing costs under variable costing	60,000	42,000	78,000
Difference	30,000	21,000	39,000
Fixed manufacturing overhead as a period expense under variable costing.	30,000	30,000	30,000
Balance	0	(9,000)	9,000
Operating Income under variable costing	15,000	0	30,000
Operating income under absorption costing	15,000	9,000	21,000
Difference in operating income	0	(9,000)	9,000

The following table shows, this difference in the amount of fixed overhead expenses explains the difference in reported income under absorption and variable costing:

Year	Change in Inventory (in units)	Fixed Overhead Rate	Difference in Fixed Overhead Expenses	Absorption Costing Income Minus Variable Costing Income
Year 1	0	x ₹ 12 =	= 0	= 0
Year 2	750 increase	x ₹ 12 =	= ₹ 9,000	= ₹9,000
Year 3	750 decrease	x ₹ 12 =	= (9,000)	= (9,000)

(d) Throughput Costing Income Statement

New India Company
Income Statement as per Throughput Costing

Particulars	Year1	Year 2	Year 3
	₹	₹	₹
Sales revenue (at ₹ 48 per unit)	1,20,000	84,000	1,56,000
Less: Cost of goods sold (at throughput cost: Direct – material cost) ¹	30,000	21,000	39,000
Throughput	90,000	63,000	1,17,000
Less: Operating costs:			
Direct labour	20,000	20,000	20,000
Variable manufacturing overhead	10,000	10,000	10,000
Fixed manufacturing overhead	30,000	30,000	30,000
Variable Selling & Admn. Costs	10,000	7,000	13,000
Fixed selling & Admn. Costs	5,000	5,000	5,000
Total Operating costs	75,000	72,000	78,000
Operating Income	15,000	(9,000)	39,000

Notes:

- Standard direct-material cost per unit of ₹ 12 multiplied by sales volume in units.
- Assume that management has committed to direct labour sufficient to produce the planned annual production volume of 2500 units; direct labour cost is used at a rate of ₹ 8 per unit produced.
- Assumes management has committed to support resources sufficient to produce the planned annual production volume of ₹ 2500 units; variable overhead cost is used at a rate of ₹ 4 per unit produced. Fixed overhead is ₹ 30,000 per year.
- Variable selling and administrative costs used amount to ₹ 1 per unit sold. Fixed selling and administrative costs are ₹ 5,000 per year.

Illustration 14.

T Ltd, produces a product which passes through two processes - cutting and finishing.

The following information is provided:

	Cutting	Finishing
Hours available per annum	50,000	60,000
Hours needed per unit of product	5	12
Fixed operating costs per annum excluding direct material	10,00,000	10,00,000

The selling price of the product is ₹ 1,000 per unit and the only variable cost per unit is direct material, which costs ₹ 400 per unit. There is demand for all units produced.

Evaluate each of the following proposals independent of each other:

- An outside agency is willing to do the finishing operation of any number of units between 5,000 and 7,000 at ₹ 400 per unit.
- An outside agency is willing to do the cutting operation of 2,000 units at ₹ 200 per unit.



- (iii) Additional equipment for cutting can be bought for ₹ 10,00,000 to increase the cutting facility by 50,000 hour, with annual fixed costs increased by ₹ 2 lakhs.

Answer:

Cutting process capacity	= 50,000 hours/5	= 10,000 units
Finishing process capacity	= 60,000 hours/12	= 5,000 units
Throughput contribution per unit	= Selling price - Material cost	
	= ₹ 1,000 - ₹ 400	= ₹ 600p.u.

Alternative-I If an outside agency is willing to do the finishing operation

Increase in throughput contribution

$$= (\text{Throughput contribution} - \text{Subcontracting charges}) \times \text{No. of finished units}$$

$$= (\text{₹ } 600 - \text{₹ } 400) \times 5,000 \text{ units} = \text{₹ } 10,00,000$$

Alternative-II If an outside agency is willing to do the cutting operation

Already the cutting process has got surplus capacity. It is not a bottleneck. It is not suggested to outsource cutting operation, since there is no benefit to TP Ltd. from outsourcing, and outsourcing of cutting process will reduce the throughput contribution of outsourced activity.

Alternative-III Installation of additional equipment for cutting process.

The cutting process has surplus capacity. It is not suggested to increase non-bottleneck capacity.

Illustration 15.

H Ltd. manufactures three products. The material cost, selling price and bottleneck resource details per unit are as follows:

Particulars		Product X	Product Y	Product Z
Selling price	(₹)	66	75	90
Material and other variable cost	(₹)	24	30	40
Bottleneck resource time	(minutes)	15	15	20

Budgeted factory costs for the period are ₹ 2,21,600. The bottleneck resources time available is 75,120 minutes per period.

Required:

- (i) Company adopted throughput accounting and products are ranked according to 'product return per minute'.
Select the highest rank product.
- (ii) Calculate throughput accounting ratio and comment on it.

Answer:

- (i) Calculation of Rank according to product return per minute (₹)

Particulars		X	Y	Z
Selling price		66	75	90
Less: Variable cost		24	30	40
Throughput contribution	(a)	42	45	50
Minutes per unit	(b)	15	15	20
Contribution per minute	(a) ÷ (b)	2.8	3	2.5
Ranking		II	I	III

(ii) Calculation of Throughput Accounting ratio

Particulars	X	Y	Z
Factory cost per minute (₹ 2,21,600/75,120 minutes) (₹)	2.95	2.95	2.95
TA ratio (Contribution per minute/Cost per minute)	0.95	1.02	0.85
Ranking based on TA ratio	II	I	III

Analysis - Product Y yields more contribution compared to average factory contribution per minute, whereas X and Z yield less. J

1.6 BUSINESS PROCESS RE-ENGINEERING

Meaning of Business Process Re-engineering

Business Process Re-engineering (BPR) refers to the fundamental rethinking and redesign of business processes to achieve improvement in critical measures of performance such as cost, quality, service, speed and customer satisfaction. In contrast the concept of Kaizen, which involves small, incremental steps towards gradual improvement, re-engineering involves a giant leap. It is the complete redesign of a process with an emphasis on finding creative new way to accomplish an objective. It has been described as taking a blank piece of paper and starting from scratch to redesign a business process. Rather than searching continually for minute improvement, re-engineering involves a radical shift in thinking about how an objective should be met. Re-engineering prescribes radical, quick and significant change. Admittedly, it can entail high risks, but it can also bring big rewards. These benefits are most dramatic when new models are discovered for conducting business.

Characteristics and Principles of Re-engineering Process

Characteristics of Re-engineering Process

- (i) Several jobs are combined into one
- (ii) Often workers make decisions
- (iii) The steps in the process are performed in a logical order
- (iv) Work is performed, where it makes most sense
- (v) Quality is built in.
- (vi) Manager provides a single point of contact
- (vii) Centralized and decentralized operations are combined.

Seven Principles of BPR:

- (a) Processes should be designed to achieve a desired outcome rather than focusing on existing tasks.
- (b) Personnel who use the output from a process should perform the process
- (c) Information processing should be included in the work, which produces the information
- (d) Geographically dispersed resources should be treated, as if they are centralized
- (e) Parallel activities should be linked rather than integrated
- (f) Doers should be allowed to be self-managing
- (g) Information should be captured once at source.

Example of business process reengineering:

(i) Credit Card Approval

An applicant submits an application. The application is reviewed first to make sure that the form has been completed properly. If not, it is returned for completion. The complete form goes through a verification of information. This is done by ordering a report from a credit company and calling references. Once the information is verified, an



evaluation is done. Then, a decision (yes or no) is made. If the decision is negative, an appropriate rejection letter is composed. If the decision is positive, an account is opened, and a card is issued and mailed to the customer. The process, which may take a few weeks due to workload and waiting time for the verifications, is usually done by several individuals. Business processes are characterized by three elements:

- **The inputs**, (data such customer inquiries or materials),
- **The processing** of the data or materials (which usually go through several stages and may necessary stops that turns out to be time and money consuming), and
- **The outcome** (the delivery of the expected result).

The problematic part of the process is processing. Business process reengineering mainly intervenes in the processing part, which is reengineered in order to become less time and money consuming.

(ii) Ford Motors

One of the best-known examples of organisations that used BPR in an effort to become more efficient is Ford Motors, a car manufacturer. Ford Motor Company is the world's second largest manufacturer of cars and trucks with products sold in more than 200 markets.

With inherent large-scale growth issues, more demanding customers, and mounting cost pressures, Ford needed to transform from a linear, top-down bureaucratic business model to an Internet ready, nimble organization that engages and integrates customers, suppliers, and employees. Working with Cisco, Ford integrated and leveraged their supplier base by designing Covisint, an end-to-end infrastructure that enables an online, centralized marketplace connecting the automotive industry supply chain. Ford also enhanced the customer buying experience through redesigned and more user friendly Web sites.

As a result, Ford is enjoying an increase in customer satisfaction, sees huge revenue opportunities for developing and retaining loyal product advocates, and has taken both complexity and cost out of the supply chain.

The term "Business Process Reengineering" has, over the past couple of year, gained increasing circulation. As a result, many find themselves faced with the prospect of having to learn, plan, implement and successfully conduct a real Business Process Reengineering endeavor, whatever that might entail within their own business organization. Hammer and Champy (1993) define business process reengineering (BPR) as:

" the fundamental rethinking and **radical** redesign of **the business processes** to achieve **dramatic** improvements in critical, contemporary measures of performance, such as cost, quality, service and speed".

1.7 BACK-FLUSH ACCOUNTING

Backflush accounting is when you wait until the manufacture of a product has been completed, and then record all of the related issuances of inventory from stock that were required to create the product. This approach has the advantage of avoiding all manual assignments of costs to products during the various production stages, thereby eliminating a large number of transactions and the associated labor.

This system records the transaction only at the termination of the production and sales cycle. The emphasis is to measure cost at the beginning and at the end with greater emphasis on the end or outputs. Since back flushing is usually employed in parallel with JIT, there is no work-in-progress to considered nor, does work –in-progress materially fluctuate. What is essential, however, is an accurate bill materials goods measures of yield generally effective production control and accurate engineering change notice when yields do change.

The principle of a just-in-time system is that production is pulled by customer demand and this in turn pulls the purchasing procedures. Thus, theoretically there are zero stocks of raw materials. Work-in-progress and finished goods. For such a situation to exist there needs to be an excellent system of production planning ad communication with materials suppliers.

Backflush accounting is entirely automated, with a computer handling all transactions. The backflushing formula is:

Number of units produced x unit count listed in the bill of materials for each component

Backflushing is a theoretically elegant solution to the complexities of assigning costs to products and relieving inventory, but it is difficult to implement. Backflush accounting is subject to the following problems:



- **Requires an accurate production count.** The number of finished goods produced is the multiplier in the backflush equation, so an incorrect count will relieve an incorrect amount of components and raw materials from stock.
- **Requires an accurate bill of materials.** The bill of materials contains a complete itemization of the components and raw materials used to construct a product. If the items in the bill are inaccurate, the backflush equation will relieve an incorrect amount of components and raw materials from stock.
- **Requires excellent scrap reporting.** There will inevitably be unusual amounts of scrap or rework in a production process that are not anticipated in a bill of materials. If you do not separately delete these items from inventory, they will remain in the inventory records, since the backflush equation does not account for them.
- **Requires a fast production cycle time.** Backflushing does not remove items from inventory until after a product has been completed, so the inventory records will remain incomplete until such time as the backflushing occurs. Thus, a very rapid production cycle time is the best way to keep this interval as short as possible. Under a backflushing system, there is no recorded amount of work-in-process inventory.

Backflushing is not suitable for long production processes, since it takes too long for the inventory records to be reduced after the eventual completion of products. It is also not suitable for the production of customized products, since this would require the creation of a unique bill of materials for each item produced.

The cautions raised here do not mean that it is impossible to use backflush accounting. Usually, a manufacturing planning system allows you to use backflush accounting for just certain products, so you can run it on a compartmentalized basis. This is useful not just to pilot test the concept, but also to use it only under those circumstances where it is most likely to succeed. Thus, backflush accounting can be incorporated into a hybrid system in which multiple methods of production accounting may be used.

The Variants of Backflush Accounting

There are a number of variants of the Backflush system, each differing as to the 'trigger points' at which costs are recognized within the cost accounts and thus associated with products. All variants, however, have the following common features :

- the focus is on output – costs are first associated with output (measured as either sales or completed production) and then allocated between stocks and costs of goods sold by working back.
- Conversion costs (labour and overheads) are never attached to products until they are complete (or even sold) – thus the traditional WIP account doesn't exist. Materials are recognized at different points according to the variant used, but only to the extent of being either stock of raw materials or part of the cost of stock of finished goods. Again, materials are not attached to WIP.

Two variants of the Backflush system are summarized below. Note that in each as conversion costs (labour and overheads) are incurred they will be recorded in a conversion cost (CC) account.

Variant 1

This has two trigger points (TP) :

- TP 1** - purchase of raw materials / components. A 'raw and in process (RIP)' account will be debited with the actual cost of materials purchased, and creditors credited.
- TP 2** - completion of good units. The finished goods (FG) account will be debited with the standard cost of unit produced and the RIP and CC account will be credited with the standard cost.

Under this variant, then, there will be two stock accounts :

- raw materials (which may, in fact, be incorporated into WIP)
- finished goods

Variant 2

This has only one trigger point – the completion of good units. The FG account is debited with the standard cost of units produced, with corresponding credits to the CC account and the creditors account.

Thus the cost records exclude :

- raw materials purchased but not yet used for complete production
- the creditors for these materials (and any price variance)

and there is only stock account, carrying the standard cost of finished goods stock.

Other variants include those using the sale of complete goods units as a trigger point for the attachment of conversion cost to unit -- thus there is no finished goods account, just a raw materials stock account, carrying the materials cost of raw materials, WIP and finished goods.



It should be seen that as stock of raw materials, WIP and finished goods are decreased to minimal levels, as in a 'pure' JIT system, these variants will give the same basic results.

Backflush Accounting — example

The following example will be used to illustrate the first two variant outlined above.

The manufacturing cost information for March for a division of XYZ plc is as follows :

Cost incurred in March	₹'000
Purchase of raw materials	4,250
Labour	2,800
Overheads	1,640
Activity in March	Units ('000)
Finished goods manufactured during the period	180
Sales 145	
Standard cost per unit	₹
Materials	20
Labour	15
Overhead	9
	44

There were no opening stocks of raw materials, WIP or finished goods. It should be assumed that there are no direct materials variance for the period.

Variant 1

The double entry would be as follows

	Dr.	Cr.
	₹'000	₹'000
1. RIP account	4,250	
Creditor		4,250
2. CC account	4,440	
Cash		2,800
Cash/ creditor		1,640
3. FG account (180 X 44)	7,920	
RIP account (180 X 20)		3,600
CC account (180 X 24)		4,320
4. COGS (145 X 44)	6,380	
FG account		6,380



The ledger would appear as follows

Raw and in process materials

	₹'000		₹'000
Creditor	4,250	FG	3,600
		Bal c/d	650
	<u>4,250</u>		<u>4,250</u>
Bal b/d	650		

Conversion costs

	₹'000		₹'000
Cash/creditor	4,440	FG	4,320
		Bal c/d	120
	<u>4,440</u>		<u>4,440</u>
Bal b/d	120		

Finished goods

	₹'000		₹'000
RIP	3,600	COGS	6,380
CC	4,320	Bal c/d	1,540
	<u>7,920</u>		<u>7,920</u>
Bal b/d	1,540		

Cost of goods sold

	₹'000		₹'000
FG	6,380		

The stock balances at the end of March would be

	₹'000
Raw and in process materials	650
Finished goods	1,540
	<u>2,190</u>

The balance on the Conversion Cost (CC) Account would be carried forward and written off at the end of the year.

**Variant 2**

The accounting entries where there is only one trigger point (on completion of units) would be simpler.

	DR.	CR.
	₹'000	₹'000
1. CC account	4,440	
Cash		2,800
Cash/creditors		1,640
2. FG account (180 X 44)	7,920	
RIP Account (180 X 20)		3,600
CC account (180 X 24)		4,320
3. COGS	6,380	
FG account		6,380

This variant is thus only suitable for JIT system with minimal raw materials stocks.

Illustration 16.

Dandia Ltd. follows JIT system. It had following transactions in May, 2014:

- (i) Raw materials were purchased for ₹2,00,000.
- (ii) Direct labour cost incurred ₹36,000
- (iii) Actual overhead costs ₹3,00,000
- (iv) Conversion costs applied ₹3,16,000

All materials, that were purchased, were placed into production and the production was also completed and sold during the month. The difference between actual and applied costs is computed.

You are required to pass both Traditional journal entries and Backflush journal entries.

Solution:

**In the books of Dandia Ltd.
Journal Entries (Traditional)**

Particulars	Debit (₹)	Credit (₹)
Material A/c.....Dr.	2,00,000	
To, Accounts Payable		2,00,000
(being purchase of raw materials)		
WIP A/c.....Dr.	2,00,000	
To, Materials A/c		2,00,000
(being materials issued to production)		
WIP A/c.....Dr.	36,000	
To, Direct wages A/c		36,000
(being direct labour cost incurred)		
Overhead Control A/c.....Dr.	3,00,000	
To, Accounts Payable		3,00,000



(being overhead cost incurred)		
WIP A/c.....Dr.	2,80,000	
To, Overhead Control A/c		2,80,000
(Being application of overhead)		
Finished Goods A/c.....Dr.	5,16,000	
To, WIP A/c		5,16,000
(Being completion of goods)		
Cost of Goods Sold A/c.....Dr.	5,16,000	
To, Finished Goods		5,16,000
(being cost of finished goods sold transferred)		
Cost of Goods Sold A/c.....Dr.	20,000	
To, Overhead Control A/c		20,000
(being variance is recognized)		

**In the books of Dandia Ltd.
Journal Entries (Backflush)**

Particulars	Debit (₹)	Credit (₹)
Raw Material in Process A/c.....Dr.	2,00,000	
To, Accounts Payable		2,00,000
(being purchase of raw materials)		
Conversion Cost Control A/c.....Dr.	3,36,000	
To, Direct wages A/c		36,000
To, Accounts Payable		3,00,000
(being overhead cost incurred)		
Finished Goods A/c.....Dr.	5,16,000	
To, Raw Material in Process A/c		2,00,000
To, WIP A/c		3,16,000
(Being completion of goods)		
Cost of Goods Sold A/c.....Dr.	5,16,000	
To, Finished Goods		5,16,000
(being cost of finished goods sold transferred)		
Cost of Goods Sold A/c.....Dr.	20,000	
To, Overhead Control A/c		20,000
(being variance is recognized)		



1.8 LEAN ACCOUNTING

What we now call lean manufacturing was developed by Toyota and other Japanese companies. Toyota executives claim that the famed Toyota Production System was inspired by what they learned during visits to the Ford Motor Company in the 1920s and developed by Toyota leaders such as Taiichi Ohno and consultant Shigeo Shingo after World War II. As pioneer American and European companies embraced lean manufacturing methods in the late 1980s, they discovered that lean thinking must be applied to every aspect of the company including the financial and management accounting processes.

Lean Accounting is the general term used for the changes required to a company's accounting, control, measurement, and management processes to support lean manufacturing and lean thinking. Most companies embarking on lean manufacturing soon find that their accounting processes and management methods are at odds with the lean changes they are making. The reason for this is that traditional accounting and management methods were designed to support traditional manufacturing; they are based upon mass production thinking. Lean manufacturing breaks the rules of mass production, and so the traditional accounting and management methods are (at best) unsuitable and usually actively hostile to the lean changes the company is making.

Classic examples of these kinds of problems are:

- Lean improvements showing cost increases as a result of the way standard costing applies labor and overhead costs. There is many an excellent lean strategy that has been cancelled or held back because the standard costing system shows a negative impact.
- Traditional performance measurements motivating the people to take anti-lean actions like building inventory, running large batches, "cherry picking" production jobs to maximize earned hours, combining jobs into more "efficient" runs, buying large (so called) economic order quantities of raw materials & components, and so forth. These problems are caused by measurements like labor efficiency, machine utilization, purchase price variance, and perhaps worst of all-overhead absorption variance (and other variances).

The lean team working hard to eliminate waste from the value stream only to find that profitability goes down owing to the adjustments made by significant inventory reduction. Looking at the other side of this same problem, the finance people are told about all the savings being made in operations but they see (at best) no financial improvement; and often a negative impact.

What is Lean Accounting? Is an off-asked question. Everybody working seriously to implement lean thinking in their company eventually bumps up against their accounting systems. It soon becomes clear that traditional accounting systems are actively anti-lean.

- They are large, complex, wasteful processes requiring a great deal of non-value work.
- They provide measurements and reports like labor efficiency and overhead absorption that motivate large batch production and high inventory levels.
- They have no good way to identify the financial impact of the lean improvements taking place throughout the company. On the contrary, the financial reports will often show that bad things are happening when very good lean change is being made.
- Very few people in the company understand the reports that emanate from the accounting systems, and yet they are used to make important and far-reaching decisions.
- They use standard product (or service) costs which can be misleading when making decisions related to quoting, profitability, make/buy, sourcing, product rationalization, and so forth. Almost all companies implementing lean accounting are making poor decisions, turning down highly profitable work, out-sourcing products or components that should be made in house, manufacturing overseas products that can be competitively manufactured here at home etc.



A short example will illustrate why traditional accounting approaches can lead us to the wrong decisions. Let's assume a company runs a traditional standard costing system with a Standard Cost of ₹27 per piece made up of materials ₹12, labour ₹5 and overhead (absorbed on a labour hours basis) of ₹15. A request for quote comes in from a major potential customer for 10,000 pieces. The customer's target price is ₹29 per piece. Should we take the order? In its standard costing system the company adds 15% to its standard cost when making quotes, thus it would quote this customer ₹31.05 per piece and not take the order.

Is this the right decision? The answer is we don't know. The Standard Cost approach doesn't tell us whether we have the spare capacity to produce the order, it doesn't tell us whether we have the potential to improve our Value Stream to produce the order and so on. In fact the Standard Cost tells us nothing.

What we actually need to do is take an incremental (marginal) costing approach to the decision. The materials to produce the extra product will cost ₹50,000 (at ₹5 each). If we have enough spare capacity in the Value Stream then there will be no extra labour cost, but let's assume we need to work ₹100,000 of overtime to complete the order. There won't be any extra overheads, but let's say there would be ₹25,000 of extra energy costs and consumables. Thus the incremental income from the order would be ₹290,000; and the incremental costs would be ₹175,000 (₹50,000 + ₹100,000 + ₹25,000) = an extra ₹115,000 contribution to profit.

Thus, based on Standard costing we would refuse a profitable order. Of course there are other factors to take into account - what impact would this price of ₹29 have on our other customers? Is this a one-off order or a potential long term relationship? etc etc. I am not saying that this approach gives us the whole picture, but it gives us more of the picture than a standard costing approach.

The purpose of lean accounting is to tell us about the flow through the Value Stream; to tell us about the capacity for extra work in the Value Stream; and to tell us about the incremental costs of alternative decisions and actions. Traditional accounting tells us nothing about these things.

Principles, Practices and Tools of Lean Accounting

Principles	Practices	Tools of lean accounting
A. Lean & simple business accounting	1. Continuously eliminate waste from the transactions processes, reports, and other accounting methods	(a) Value stream mapping; current & future state (b) Kaizen (lean continuous improvement) (c) PDCA problem solving
B. Accounting processes that support lean transformation	1. Management control & continuous improvement	(a) Performance Measurement Linkage Chart; linking metrics for cell/process, value streams, plant & corporate reporting to the business strategy, target costs, and lean improvement (b) Value stream performance boards containing break-through and continuous improvement projects (c) Box scores showing value stream performance
	2. Cost management	(a) Value stream costing (b) Value stream income statements
	3. Customer & supplier value and cost management	(a) Target costing



C. Clear & timely communication of information	1. Financial reporting	(a) "Plain English" financial statements (b) Simple, largely cash-based accounting
	2. Visual reporting of financial & non-financial performance measurements	(a) Primary reporting using visual performance boards; division, plant, value stream, cell/process in production, product design, sales/ marketing, administration, etc.
	3. Decision-making	(a) Incremental cost & profitability analysis using value stream costing and box scores
D. Planning from a lean perspective	1. Planning & budgeting	(a) Hoshin policy deployment (b) Sales, operations, & financial planning (SOFP)
	2. Impact of lean improvement	(a) Value stream cost and capacity analysis (b) Current state & future state value stream maps (c) Box scores showing operational, financial, and capacity changes from lean improvement. Plan for financial benefit from the lean changes
	3. Capital planning	(a) Incremental impact of capital expenditure on value stream box-score. Often used with 3P approaches
	4. Invest in people	(a) Performance measurements tracking continuous improvement participation, employee satisfaction, & cross-training (b) Profit sharing
E. Strengthen internal accounting control	1. Internal control based on lean operational controls	(a) Transaction elimination matrix (b) Process maps showing controls and SOX risks
	2. Inventory valuation	(a) Simple methods to value inventory without the requirement for perpetual inventory records and product costs can be used when the inventory is low and under visual control.

While Lean Accounting is still a work-in-process, there is now an agreed body of knowledge that is becoming the standard approach to accounting, control, and measurement. These principles, practices, and tools of Lean Accounting have been implemented in a wide range of companies at various stages on the journey to lean transformation. These methods can be readily adjusted to meet your company's specific needs and they rigorously maintain adherence to GAAP and external reporting requirements and regulations. Lean Accounting is itself lean, low-waste, and visual, and frees up finance and accounting people's time so they can become actively involved in lean change instead of being merely "bean counters."

Companies using Lean Accounting have better information for decision-making, have simple and timely reports that are clearly understood by everyone in the company, they understand the true financial impact of lean changes, they focus the business around the value created for the customers, and Lean Accounting actively drives the lean transformation. This helps the company to grow, to add more value for the customers, and to increase cash flow and value for the stock-holders and owners.



CONTRASTING LEAN ACCOUNTING AND TRADITIONAL STANDARD COSTING		
LEAN ACCOUNTING	STANDARD COSTING	WHY IS THIS IMPORTANT FOR LEAN?
Quick, simple, and timely	Complex and wasteful processes	FLOW: Frequent and simple value stream income statements create much better control.
Clear and easy to understand	Difficult for people to understand	EMPOWERMENT: Information people can understand empowers those people for Lean improvement and growth.
Provides information for effective decisions.	Leads to bad decisions	VALUE: Readily understandable costs lead to better decisions and improved cash-flow and profits.
Supports value stream measurements and box scores	Supports measurements that undermine Lean endeavors	PURSUE PERFECTION: Measurements motivate people, Value Stream costs motivate lean improvement. Standard variance reports are anti-Learn.
Supports a value stream (total process) approach	Supports a departmental view of production	VALUE STREAMS: Focus on value streams lead to improved value, flow, and costs. Department focus opposes Lean.
Enables value stream financial control and improvement.	Narrows the focus of financial control and improvement.	PURSUE PERFECTION: Value Stream cost information creates better financial control and drives improvement.
Enables inventory valuation,	Enables inventory valuation,	FLOW: Standard costs were designed to value inventory. Lean accounting values inventory easier and better.
Enables value based pricing	Enables Cost+ Pricing	VALUE: Value streams focus on customer value leading to value pricing. Traditional companies use cost.

1.9 SOCIO ECONOMIC COSTING

Socioeconomics (also known as **social economics**) is the social science that studies how economic activity affects and is shaped by social processes. In general it analyzes how societies progress, stagnate, or regress because of their local or regional economy, or the global economy.

Socioeconomics is sometimes used as an umbrella term with different usages. The term 'social economics' may refer broadly to the "use of economics in the study of society.

In many cases, socioeconomists focus on the social impact of some sort of economic change. Such changes might include a closing factory, market manipulation, the signing of international trade treaties, new natural gas regulation, etc. Such social effects can be wide-ranging in size, anywhere from local effects on a small community to changes to an entire society. Examples of causes of socioeconomic impacts include new technologies such as cars or mobile phones, changes in laws, changes in the physical environment (such as increasing crowding within cities), and ecological changes (such as prolonged drought or declining fish stocks). These may affect patterns of consumption, the distribution of incomes and wealth, the way in which people behave (both in terms of purchase decisions and the way in which they choose to spend their time), and the overall quality of life.

Companies are increasingly interested in measuring socio-economic impact as part of maintaining their license to operate, improving the business enabling environment, strengthening their value chains, and fuelling product and service innovation.

But while more and more tools are being developed to help companies measure socio-economic impact, it can be difficult to compare and choose among them. The tools available today are incredibly diverse. They are based



on different assumptions, they offer different functionality, they focus on different types of impact, and they suit different purposes.

Business is a major driver of socio-economic impact – and socioeconomic impact is a major predictor of business success, especially in the long term. By creating jobs, training workers, building physical infrastructure, procuring raw materials, transferring technology, paying taxes, and expanding access to products and services ranging from food and healthcare to energy and information technology, companies affect

people's assets, capabilities, opportunities, and standards of living – sometimes positively, sometimes negatively. And because these people are companies' employees, customers, suppliers, distributors, retailers, and neighbours, their growth and well-being matters to the bottom line. It influences whether or not companies have happy customers, healthy value chains, contented local communities, and supportive governments and other stakeholders now and into the future.

As a result, companies are increasingly interested in measuring their socio-economic impact for a variety of reasons, ranging from reducing cost and risk to creating and capturing new opportunities. These reasons include:

1. **Obtaining or maintaining license to operate:** Measuring socio-economic impact can help companies show communities, government authorities, and other stakeholders, like donors and civil society groups, that their activities create net benefits for the economies and societies in which they operate – and mitigate the risk of negative publicity, protest, and declining government support for current and future operations. It can help companies answer questions like;

Are we fulfilling our commitments and the expectations our stakeholders have of us?

Is there a gap between our impacts and our stakeholders' perceptions?

To what extent do our activities create social risk or conflict?

Where should we invest our corporate social responsibility budget?

Where do we need help from external stakeholders – like governments, donors, and civil society groups?

2. **Improving the business enabling environment:** Measuring socio-economic impact can help companies show policymakers what and how they contribute to public policy goals through profitable business activity – helping those policymakers develop the right mix of rules, incentives, and public services needed to maximize the business contribution. It can help companies answer-

To what extent are our business activities contributing to local, national, or international public policy goals? What negative impacts should we be aware of?

How are our business activities contributing? What are the critical levers of impact (such as procurement, training, or consumption of our products and services)?

Are there external constraints on those levers that policymakers could help change?

3. **Strengthening value chains:** Measuring socio-economic impact can help companies predict the loyalty, performance, stability, and capacity for growth of suppliers, distributors, and retail partners – identifying vulnerabilities and opportunities to address them. It can help companies answer questions like:

Are we at risk of side-selling by smallholder farmers?

Do our suppliers have what it takes to attract other big customers, expand production capacity, and achieve economies of scale?

Can our retail partners afford to invest in added shelf space and inventory?

4. **Fueling product and service innovation:** Measuring socio-economic impact can help companies understand the needs, aspirations, resources, and incentives of their customers – enabling them to develop winning new products and services and improve existing offerings. It can help companies answer questions like:

Why haven't our sales grown as expected?



What is the best way to segment new “base of the pyramid” markets?

How can we create demand for a product or service we know would add value?

Where do we need help from external stakeholders – like governments, donors, and civil society groups?

Tools available with the company for measuring the Socio economic impact:

The various tools available to the company for measuring the socio economy impact are enumerated below;

1. **Strategic fit:** Many socio-economic impact measurement tools are flexible, and can be used in support of company efforts to obtain or maintain license to operate, engage policymakers to improve the business enabling environment, strengthen their value chains, or fuel product and service development to capture new markets and grow revenues – depending on specific design and implementation choices made by the user. Examples include the Base of the Pyramid (BOP) Impact Assessment Framework, the Initiative for Global Development's (IGD) Impact Measurement Framework, the Global Environmental Management Initiative (GEMI) Metrics Navigator, and the WBCSD Measuring Impact Framework. Other tools are more targeted. For example, Anglo American's Socio-Economic Assessment Toolbox (SEAT) has been designed with social license to operate and the business enabling environment in mind, and it can help strengthen value chains to the extent local procurement is part of the business strategy. An important factor in strategic fit is the extent to which a tool generates relevant, credible information for those who need it – whether they be company managers, local community members, governments, or NGOs. This is a function of scope, the specific metrics chosen, the credibility of the measurement process and how quickly it can be carried out, and whether or not negative impacts are included as well as positive ones.

Strategic objectives include:

- Secure license to operate
- Improve business enabling environment
- Strengthen value chains
- Fuel product and service innovation

2. **Applicable level(s) of analysis:** Most frameworks are designed to be flexible and can be applied at many different levels. For example, the GEMI Metrics Navigator and WBCSD Measuring Impact Framework can be applied at the site, value chain, business line, or company level, depending on the company's needs. However, several frameworks are designed to be applied at specific levels and yield better or more meaningful results at those levels. For example, Anglo American's SEAT is designed for use at the site level and the MDG Scan works best at the company level.

Levels of analysis include:

- Site
- Value chain
- Business line
- Company operations at the national level
- Company

3. **Guidance included:** Frameworks vary in the nature of the guidance they offer. Some are very comprehensive, helping the user to set the scope for a socioeconomic impact measurement exercise, select indicators/metrics, gather and/or generate data, and interpret the results. Others are very specific. For example, the Impact Reporting and Investment Standards (IRIS) only help select indicators/metrics and the Progress out of Poverty Index (PPI) generates a single, albeit important, metric.

Guidance is available for:

- Setting scope
- Selecting indicators/metrics



Gathering and/or generating data

Interpreting results

- Metrics:** Some frameworks are agnostic as to the specific metrics companies should choose, focusing instead on the process of choosing relevant ones (e.g. GEMI Metrics Navigator and WBCSD Measuring Impact Framework). Others propose specific metrics – some at the “input,” “activity,” and “output” end of the spectrum (like IGD and IRIS) and others pushing toward “outcomes” and “impacts” (like the BOP Impact Assessment Framework and the Poverty Footprint). Still other frameworks focus on generating a small number of specific metrics (like the MDG Scan, which estimates the numbers of people reached in the eight Millennium Development Goal areas, and the Progress out of Poverty Index, which calculates the percentage of people below the poverty line).

Types of metrics covered include:

Input, activity and output metrics

Outcome and impact metrics

Flexible – can be tailored to business needs

- Data requirements:** Data requirements vary depending on the metrics in question. As a result, it is impossible to generalize about the data requirements of frameworks that are agnostic about metrics. Frameworks that focus on “input,” “activity,” and “output” metrics tend to rely more heavily on data a company already has or can easily collect. Those that push toward “outcomes” and “impacts” require more external data collection, including from stakeholders on the ground.

Data requirements include:

Internal company data

External data collection

Flexible – can be tailored to business needs

- Key audiences:** Which audiences find socio-economic impact measurement relevant depends on the type of information it generates and nature of the process (including whether or not it is credible in their eyes). Companies should make sure that the audiences for their socioeconomic impact measurement work align with the strategic fit they are hoping to achieve. For example, a company measuring to support efforts to improve the business enabling environment must make sure the data is relevant and credible to government policymakers.

Target audiences include:

Company managers

Civil society groups

Donors

Impact investors

Governments

- Level of effort:** Frameworks vary in the level of effort required to implement. They involve different sets of tasks and have different cost and time implications. While available cost and time data are patchy, factors include the scope of the exercise and specific metrics selected; the extent to which external data must be collected from stakeholders on the ground; the level of stakeholder engagement conducted; whether or not a public report must be prepared; the cost of third party services; and company staff time required. There is a need to build the knowledge base on the level of effort involved in implementing these as user experience grows. It should be stressed that it is not appropriate to compare these frameworks on the basis of level of effort alone, since they offer different value in return.



The level of effort can vary by:

Tasks required

Cost

Time required

8. **Developer services:** While socio-economic impact measurement frameworks offer guidance in and of themselves, many developers offer services that expand or deepen the guidance available. They may also offer to implement their frameworks on behalf of or in collaboration with companies, and to write public reports on the results.

1.10 COST CONTROL AND COST REDUCTION – BASICS, PROCESS, METHODS AND TECHNIQUES OF COST REDUCTION PROGRAMME

Cost Control and the various steps involved in it.

Cost Control is defined as the regulation by executive action of the costs of operating an undertaking, particularly where such action is guided by cost accounting.

Cost control involves the following steps and covers the various facets of the management:

- (a) **Planning:** First step in cost control is established plans/targets. The plan/target may be in the form of budgets, standards, estimates and even past actual may be expressed in physical as well as monetary terms. These serves as yardsticks by which the planned objective can be assessed.
- (b) **Communication:** The plan and the policy laid down by the management are made known to all those responsible for carrying them out. Communication is established in two directions; directives are issued by higher level of management to the lower level for compliance and the lower level executives report performances to the higher level.
- (c) **Motivation:** The plan is given effect to and performances starts. The performance is evaluated, costs are ascertained and information about results achieved are collected and reported. The fact that costs are being complied for measuring performances acts as a motivating force and makes individuals endeavour to better their performances.
- (d) **Appraisal and Reporting:** The actual performance is compared with the predetermined plan and variances, i.e deviations from the plan are analyzed as to their causes. The variances are reported to the proper level of management.
- (e) **Decision Making:** The variances are reviewed and decisions taken. Corrective actions and remedial measures or revision of the target, as required, are taken.

Advantages of cost control system.

The advantages of cost control are mainly as follows:

- (a) Achieving the expected return on capital employed by maximising or optimizing profit
- (b) Increase in productivity of the available resources
- (c) Reasonable price of the customers
- (b) Continued employment and job opportunity for the workers
- (c) Economic use of limited resources of production
- (f) Increased credit worthiness
- (g) Prosperity and economic stability of the industry



Cost Reduction:

Profit is the result of two varying factors, viz., sales and cost. The wider the gap between these two factors, the larger is the profit. Thus, profit can be maximised either by increasing sales or by reducing cost. In a competition loss market or in case of monopoly products, it may perhaps be possible to increase price to earn more profits and the need for reducing costs may not be felt. Such conditions cannot, however, exist paramount and when competition comes into play, it may not be possible to increase the sale price without having its adverse effect on the sale volume, which, in turn, reduces profit. Besides, increase in price of products has the ultimate effect of pushing up the raw material prices, wages of employees and other expenses all of which tend to increase costs. In the long run, substitute products may come up in the market, resulting in loss of business. Avenues have, therefore, to be explored and method devised to cut down expenditure and thereby reduce the cost of products. In short, cost reduction would mean maximization of profits by reducing cost through economics and savings in costs of manufacture, administration, selling and distribution.

Cost reduction may be defined as the real and permanent reduction in the unit costs of goods manufactured or services rendered without impairing their suitability for the use intended. As will be seen from the definition, the reduction in costs should be real and permanent. Reductions due to windfalls, fortuitous receipts, changes in government policy like reduction in taxes or duties, or due to temporary measures taken for tiding over the financial difficulties do not strictly come under the purview of cost reduction. At the same time a programme of cost reduction should in no way affect the quality of the products nor should it lower the standards of performance of the business.

Broadly speaking reduction in cost per unit of production may be affected in two ways viz.,

1. By reducing expenditure, the volume of output remaining constant, and
2. By increasing productivity, i.e., by increasing volume of output and the level of expenditure remains unchanged.

These aspects of cost reduction are closely linked and they act together - there may be a reduction in the expenditure and the same time, an increase in productivity.

Differences between Cost Control and Cost Reduction.

Cost Control VS Cost Reduction: Both cost reduction and cost control are efficient tools of management but their concepts and procedure are widely different. The differences are summarised below:

Cost Control	Cost Reduction
(a) Cost Control represents efforts made towards achieving target or goal.	(a) Cost reduction represents the achievement in reduction of cost
(b) The process of cost control is to set up a target, ascertain the actual performance and compare it with the target, investigate the variances, and take remedial measures.	(b) Cost reduction is not concerned with maintenance of performance according to standard
(c) Cost control assumes the existence of standards or norms which are not challenged	(c) Cost reduction assumes the existence of concealed potential savings in standards or norms which are therefore subjected to a constant challenge with a view to improvement by bringing out savings
(d) Cost Control is a preventive function. Costs are optimized before they are incurred	(d) Cost reduction is a corrective function. It operates even when an efficient cost control system exists. There is room for reduction in the achieved costs under controlled conditions
(e) Cost control lacks dynamic approach	(e) Cost reduction is a continuous process of analysis by various methods of all the factors affecting costs, efforts and functions in an organization. The main stress is upon the why of a thing and the aim is to have continual economy in costs

**Illustration 17.**

Ever Forward Ltd is manufacturing and selling two products: Splash and Flash, at selling prices of ₹3 and ₹4 respectively. The following sales strategy has been outlined for the year 2015.

- (i) Sales planned for year will be ₹7.20 lakhs in the case of Splash and ₹ 3.50 lakhs in the case of Flash.
- (ii) Break-even is planned at 60% of-the total sales of each product.
- (iii) Profit for the year to be achieved is planned at ₹69,120 in the case of Splash and ₹17,500 in the case of Flash. This would be possible by launching a cost reduction programme and reducing the present annual fixed expenses of ₹1,35,000 allocated as ₹1,08,000 to Splash and ₹27,000 to Flash.

The selling price of Splash and Flash will be reduced by 20% and 12.5% respectively to meet the competition.

You are required to present the proposal in financial terms giving clearly the following information.

- (a) Number of units to be sold of Splash and Flash to break-even as well as the total number of units of Splash and Flash to be sold during the year.
- (b) Reduction in fixed expenses product-wise that is envisaged by the cost Reduction Program.

S. S. Computation of Breakeven, total no of units to be sold & reduction in costs

		Splash	Flash	Total
I	Sales (₹)	7,20,000	3,50,000	10,70,000
II	SP (₹)	2.4	3.5	
III	No. of units to be sold $\left(\frac{7,20,000}{2.4}\right)$	3,00,000	1,00,000	4,00,000
IV	Break even units 60%	1,80,000	60,000	
V	Break even sales (₹)	4,32,000	2,10,000	6,42,000
VI	M/s (₹)	2,88,000	1,40,000	4,28,000
VII	Project Planned	69,120	17,500	86,620
VIII	P/V Ratio	24%	12.5%	
IX	FC (Break even sales × P/V Ratio) (₹)	1,03,680	26,250	1,29,930
X	Previous FC (₹)	1,08,000	27,000	1,35,000
XI	Reduction in FC (X – IX) (₹)	4320	750	5070



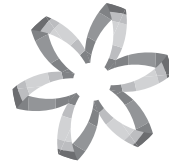

Section B
**Strategic Cost Management Tools
and Techniques**
(Syllabus - 2016)



Study Note - 2

DECISION MAKING TECHNIQUES



This Study Note includes

2.1 Marginal Costing

- Decisions involving alternative choice
- Pricing Decisions and Strategies
- Costing of Service Sector
- Relevant Cost Analysis
- Profitability Analysis

2.2 Transfer Pricing

2.1 MARGINAL COSTING

The cost of a product or process can be ascertained using different elements of cost using any of the following two techniques viz.,

1. Absorption Costing
2. Marginal Costing

Absorption Costing:

Under this method, the cost of the product is determined after considering the total cost i.e., both fixed and variable costs. Thus this technique is also called traditional or total costing. The variable costs are directly charged to the products where as the fixed costs are apportioned over different products on a suitable basis, manufactured during a period. Thus under absorption costing, all costs are identified with the manufactured products. However, this technique suffers from the following limitations:

Limitations of Absorption Costing:

1. Being dependent on levels of output which vary from period to period, costs are vitiated due to the existence of fixed overhead. This renders them useless for purposes of comparison and control. (If, however, overhead recovery rate is based on normal capacity, this situation will not arise).
2. Carryover of a portion of fixed costs, i.e., period costs to subsequent accounting periods as part of the cost of inventory is a unsound practice because costs pertaining to a period should not be allowed to be vitiated by the inclusion of costs pertaining to the previous period.
3. Profits and losses in the accounts are related not only to sales but also to production, including the production which is unsold. This is contrary to the principle that profits are made not at the stage when products are manufactured but only when they are sold.
4. There is no uniformity in the methods of application of overhead in absorption costing. These problems have, no doubt, to be faced in the case of marginal costing also but to a less extent because of the exclusion of fixed costs, as different assumptions made in the matter of application of fixed overhead will not arise in the case of marginal costing.
5. Absorption costing is not always suitable for decision making solutions to various types of problems of management decision making, where the absorption cost method would be practically ineffective, such as selection of production volume and optimum capacity utilisation, selection of production mix, whether to buy or manufacture, choice of alternatives and evaluation of performance can be had with the help of marginal cost analysis. Sometimes, the conclusion drawn from absorption cost data in this regard may be misleading and lead to losses.



Marginal Costing:

Marginal costing is "the ascertainment of marginal costs and of the effect on profit of changes in volume or type of output by differentiating between fixed costs and variable costs." Several other terms in use like direct costing, contributory costing, variable costing, comparative costing, differential costing and incremental costing are used more or less synonymously with marginal costing.

It is a process whereby costs are classified into fixed and variable and with such a division so many managerial decisions are taken. The essential feature of marginal costing is division of total costs into fixed and variable, without which this could not have existed. Variable costs vary with volume of production or output, whereas fixed costs remains unchanged irrespective of changes in the volume of output. It is to be understood that unit variable cost remains same at different levels of output and total variable cost changes in direct proportion with the number of units. On the other hand, total fixed cost remains same disregard of changes in units, while there is inverse relationship between the fixed cost per unit and the number of units.

Features of Marginal Costing:

The main features of Marginal Costing may be summed up as follows:

1. Appropriate and accurate division of total cost into fixed and variable by picking out variable portion of semi variable costs also.
2. Valuation of stocks such as finished goods, work-in-progress is valued at variable cost only.
3. The fixed costs are written off soon after they are incurred and do not find place in product cost or inventories.
4. Prices are based on Marginal Cost and Marginal Contribution.
5. It combines the techniques of cost recording and cost reporting.

Advantages or Merits or Applications of Marginal Costing:

1. Marginal costing system is simple to operate than absorption costing because they do not involve the problems of overhead apportionment and recovery.
2. Marginal costing avoids, the difficulties of having to explain the purpose and basis of overhead absorption to management that accompany absorption costing. Fluctuations in profit are easier to explain because they result from cost volume interactions and not from changes in inventory valuation.
3. It is easier to make decisions on the basis of marginal cost presentations, e.g., marginal costing shows which products are making a contribution and which are failing to cover their avoidable (i.e., variable) costs. Under absorption costing the relevant information is difficult to gather, and there is the added danger that management may be misled by reliance on unit costs that contain an element of fixed cost.
4. Marginal costing is essentially useful to management as a technique in cost analysis and cost presentation. It enables the presentation of data in a manner useful to different levels of management for the purpose of controlling costs. Therefore, it is an important technique in cost control.
5. Future profit planning of the business enterprises can well be carried out by marginal costing. The contribution ratio and marginal cost ratios are very useful to ascertain the changes in selling price, variable cost etc. Thus, marginal costing is greatly helpful in profit planning.
6. When a business concern consists of several units and produces several products and evaluation of performance of such components can well be made with the help of marginal costing.
7. It is helpful in forecasting.
8. When there are different products, the determination of number of units of each product, called Optimum Product Mix, is made with the help of marginal costing.
9. Similarly, optimum sales mix i.e., sales of each and every product to get maximum profit can also be determined with the help of marginal costing.
10. Apart from the above, numerous managerial decisions can be taken with the help of marginal costing, some of which, may be as follows:-
 - (a) Make or buy decisions,
 - (b) Exploring foreign markets,
 - (c) Accept an order or not,



- (d) Determination of selling price in different conditions,
- (e) Replace one product with some other product,
- (f) Optimum utilisation of labour or machine hours,
- (g) Evaluation of alternative choices,
- (h) Subcontract some of the production processes or not,
- (i) Expand the business or not,
- (j) Diversification,
- (k) Shutdown or continue,

Limitations of Marginal Costing:

- (a) The separation of costs into fixed and variable present's technical difficulties and no variable cost is completely variable nor is a fixed cost completely fixed.
- (b) Under the marginal cost system, stock of finished goods and work-in-progress are understated. After all, fixed costs are incurred in order to manufacture products and as such, these should form a part of the cost of the products. It is, therefore, not correct to eliminate fixed costs from finished stock and work-in-progress.
- (c) The exclusion of fixed overhead from the inventories affects the Profit and Loss Account and produces an unrealistic and conservative Balance Sheet, unless adjustments are made in the financial accounts at the end of the period.
- (d) In marginal costing system, marginal contribution and profits increase or decrease with changes in sales volume. Where sales are seasonal, profits fluctuate from period to period. Monthly operating statements under the marginal costing system will not, therefore, be as realistic or useful as in absorption costing.
- (e) During the earlier stages of a period of recession, the low profits or increase in losses, as revealed in a magnified way in the marginal costs statements, may unduly create panic and compel the management to take action that may lead to further depression of the market.
- (f) Marginal costing does not give full information. For example, increased production and sales may be due to extensive use of existing equipments (by working overtime or in shifts), or by an expansion of the resources, or by the replacement of labour force by machines. The marginal contribution fails to reveal these.
- (g) Though for short-term assessment of profitability marginal costs may be useful, long term profit is correctly determined on full costs basis only.
- (h) Although marginal costing eliminates the difficulties involved in the apportionment and under and over-absorption of fixed overhead, the problem still remains so far as the variable overhead is concerned.
- (i) With increased automation and technological developments, the impact on fixed costs on products is much more than that of variable costs. A system which ignores fixed costs is therefore, less effective because a major portion of the cost, such as not taken care of.
- (j) Marginal costing does not provide any standard for the evaluation of performance. A system of budgetary control and standard costing provides more effective control than that obtained by marginal costing.

Differences between Absorption Costing and Marginal Costing:

	Absorption Costing	Marginal Costing
1.	Both fixed and variable costs are considered for product costing and inventory valuation.	Only variable costs are considered for product costing and inventory valuation.
2.	Fixed costs are charged to the cost of production. Each product bears a reasonable share of fixed cost and thus the profitability of a product is influenced by the apportionment of fixed costs.	Fixed costs are regarded as period costs. The profitability of different products is judged by their P/V ratio.



3.	Cost data are presented in conventional pattern. Net profit of each product is determined after subtracting fixed cost along with their variable cost.	Cost data are presented to highlight the total contribution of each product.
4.	The difference in the magnitude of opening stock and closing stock affects the unit cost of production due to the impact of related fixed cost.	The difference in the magnitude of opening stock and closing stock does not affect the unit cost of production.
5.	In case of absorption costing the cost per unit reduces, as the production increases as it is fixed cost which reduces, whereas, the variable cost remains the same per unit.	In case of marginal costing the cost per unit remains the same, irrespective of the production as it is valued at variable cost.

Difference in profit under Marginal and Absorption Costing:

- (i) No opening and closing stock: In this case, profit/loss under absorption and marginal costing will be equal.
- (ii) When opening stock is equal to closing stock: In this case, profit/loss under two approaches will be equal provided the fixed cost element in both the stocks is same amount.
- (iii) When closing stock is more than opening stock: In other words, when production during a period is more than sales, then profit as per absorption approach will be more than that by marginal approach. The reason behind this difference is that a part of fixed overhead included in closing stock value is carried forward to next accounting period.
- (iv) When opening stock is more than the closing stock: In other words when production is less than the sales, profit shown by marginal costing will be more than that shown by absorption costing. This is because a part of fixed cost from the preceding period is added to the current year's cost of goods sold in the form of opening stock.

MARGINAL COST:

Marginal Cost is defined as "the amount at any given volume of output by which aggregate costs are changed if the volume of output is increased or decreased by one unit." Marginal Cost also means Prime Cost plus Variable Overheads. Marginal Cost is a constant ratio which may be expressed in terms of an amount per unit of output. On the other hand, fixed cost which is not normally traceable to particular unit denotes a fixed amount of expenditure incurred during an accounting period. Fixed cost is, therefore, also called time cost, period cost, standby cost, capacity cost, or constant cost. Variable cost or marginal cost is also termed as direct cost, activity cost, volume cost or out-of-pocket cost.

From the above definition and analysis of marginal cost, we can understand that is the cost which varies according to the variations in the volumes of output. However, by definition marginal cost is the change in the total cost for addition of one unit. *It is to be noted that for an economist marginal cost and variable cost would be different. But for an accountant both marginal cost and variable cost are same and are interchangeably used.* Therefore, for our study, we use marginal cost and variable cost synonymously.

Differential Cost Analysis

Differential Cost is the change in the costs which results from the adoption of an alternative course of action. The alternative actions may arise due to change in sales volume, price, product mix (by increasing, reducing or stopping the production of certain items), or methods of production, sales, or sales promotion, or they may be due to 'make or buy' or 'take or refuse' decisions. When the change in costs occurs due to change in the activity from one level to another, differential cost is referred to as incremental cost or decremental cost, if a decrease in output is being considered, i.e. total increase in cost divided by the total increase in output. However, accountants generally do not distinguish between differential cost and incremental cost and the two terms are used to mean one and the same thing.

The computation of differential cost provides an useful method of analysis for the management for anticipating the results of any contemplated changes in the level or nature of activity. When policy decisions have to be taken, differential costs worked out on the basis of alternative proposals are of great assistance.



The determination of differential cost is simple. Differential cost represents the algebraic difference between the relevant costs for the alternatives being considered. Thus, when two levels of activities are being considered, the differential cost is obtained by subtracting the cost at one level from the cost of another level.

The essential features of differential costs are as follows:-

1. The basis data used for differential cost analysis are costs, revenue and the investment factors which are relevant in the problem for which the analysis is undertaken.
2. Total differential costs rather than the costs per unit are considered.
3. Differential cost analysis is made outside the accounting records.
4. As the differences in the costs at two levels are considered, absolute costs at each level are not as relevant as the difference between the two. Thus, items of costs which do not change but are identical for the alternatives under consideration, are ignored.
5. The differentials are measured from a common base point or position.
6. The stage at which the difference between the revenue and the cost is the highest, measured from the common base point, determines the choice from amongst a number of alternative actions.
7. In computing differential costs, historical or standard costs may be used but they should be adjusted to the requirements of future conditions.
8. The elements and items of cost to be considered in differential cost analysis will depend upon the nature of the problem and the alternatives being considered.

Differential Costs Analysis and Marginal Costing:

Although the techniques of differential costs analysis are similar to those of marginal costing, the two should not be confused. The points of similarity and difference between differential costs analysis and marginal costing are summarized below:

Similarity:

- (a) Both the techniques of cost analysis and cost presentation.
- (b) Both are made use of by the management in decision making and in formulating policies.
- (c) The concepts of differential costs and marginal costs mainly arise out of the difference in the behaviour of fixed and variable costs.
- (d) Differential costs compare favourably with the economist's definition of marginal cost, viz. that marginal cost is the amount which at any given volume of output is changed if output is increased or decreased by one unit.

Difference:

- (a) Differential cost analysis can be made in the case of both absorption costing as well as marginal costing.
- (b) While marginal costing excludes the entire fixed costs, some of the fixed costs may be taken into account as being relevant for the purpose of differential cost analysis.
- (c) Marginal costs may be embodied in the accounting system whereas differential costs are worked out separately as analysis statements.
- (d) In marginal costing, margin of contribution and contribution ratio are the main yardsticks for performance evaluation and for decision making. In differential cost analysis, differential costs are compared with the incremental or decremental revenues, as the case may be.

Practical Application of Differential Costs:

They are useful in managerial decisions, which are enumerated below:

- (i) Determination of most profitable levels of production and price.
- (ii) Acceptance of offer at a lower price or offering a quotation at lower selling price in order to increase capacity.



- (iii) It is used to decide whether it will be more profitable to sell a product as it is or to process it further into a different product to be sold at an increased price.
- (iv) Determining the suitable price at which raw material may be purchased.
- (v) Decision of adding a new product or business segment.
- (vi) Discontinuing a product or business segment in order to avoid or reduce the present loss or increase profit.
- (vii) Changing the product mix.
- (viii) Make or buy decisions.
- (ix) Decision regarding alternative capital investment and plant replacement.
- (x) Decision regarding change in method of production.

Tools and Techniques of Marginal Costing:

1. Contribution:

In common parlance, contribution is the reward for the efforts of the entrepreneur or owner of a business concern. From this, one can get in his mind that contribution means profit. But it is not so. Technically or in Costing terminology, contribution means not only profit but also fixed cost. That is why; it is defined as the amount recovered towards fixed cost and profit.

Contribution can be computed by subtracting variable cost from sales or by adding fixed costs and profit.

Symbolically, $C = S - V \rightarrow (1)$

Where $C =$ Contribution

$S =$ Selling Price

$V =$ Variable Cost

Also $C = F + P \rightarrow (2)$

Where $F =$ Fixed Cost

$P =$ Profit

From (1) and (2) above, we may deduce the following equation called Fundamental Equation of Marginal Costing i.e.

$S - V = F + P \rightarrow (3)$

Contribution is helpful in determination of profitability of the products and/or priorities for profitabilities of the products. When there are two or more products, the product having more contribution is more profitable.

For example: The following are the three products with selling price and cost details:

Particulars	Amount (₹)		
	A	B	C
Selling price	100	150	200
Variable cost	50	70	100
Contribution	50	80	100

In the above example, one can say that the product 'C' is more profitable because, it has more contribution. This proposition of product having more contribution is more profitable is valid, as long as, there are no limitations on any factor of production. In this context, factors of production means, the factors that are responsible for producing the products such as material, labour, machine hours, demand for sales etc..



Limiting Factor (or) Key Factor:

In the above example, we find that product having more contribution is more profitable. However, when there is a limitation on any input factor, the profitability of the product cannot simply be determined by finding out the contribution of the unit, but it can be found out by ascertaining the contribution per unit of that factor of production which is limited in the given situation. Such factor of production which is limited in the question is called key factor or limiting factor.

Continuing the above example, it may be explained as follows:

The three products take same raw material. A takes 1 kg, B requires 2 kgs, C requires 5 kgs and the raw material is not abundant.

Then profitability of the above products is determined as follows:

$$\text{Profitability} = \left(\frac{\text{Contribution}}{\text{Key Factor}} \right)$$

A	B	C
50 / 1 = ₹ 50	80 / 2 = ₹ 40	100 / 5 = ₹ 20

Now, product A is more profitable because it has more contribution per kg of material.

The key factor can also be called as scarce factor or Governing factor or Limiting factor or Constraining factor etc., whatever may be the name, it indicates the limitation on the particular factor of production.

From the above, it is essentially understandable that contribution is helpful in determination of profitability of the products, priorities for profitability of the products and in particular, profitabilities when there are limitation on any factor.

2. Profit Volume Ratio (P/V Ratio) or Contribution Ratio:

First of all, a ratio is a statistical or mathematical tool with the help of which a relationship can be established between the variables of the same kind. Further, it may be expressed in different forms such as fractional form, quotient, percentage, decimal form, and proportional form.

For example:

Gross profit ratio: It may be expressed as follows:

- Gross profit is ¼th of sales
- Sales is 4 times that of gross profit
- Gross profit ratio is 25%
- Gross profit is 0.25 of sales and lastly
- Gross profit and sales are in the ratio of 1:4

So, P/V ratio or contribution ratio is association of two variables. From this, one may assume that it is the ratio of profit and sales. But it is not so. It is the ratio of Contribution to Sales.

$$\text{Symbolically, P/V ratio} = \frac{\text{Contribution}}{\text{Sales}} \times 100 \rightarrow (1)$$

$$\Rightarrow \text{P/V ratio} = \frac{C}{S} \times 100$$

$$\Rightarrow \text{Contribution} = \text{Sales} \times \text{P/V ratio} \rightarrow (2)$$

$$\Rightarrow \text{Sales} = \frac{\text{Contribution}}{\text{P/V Ratio}} \rightarrow (3)$$

When cost accounting data is given for two periods, then:

$$\text{P/V ratio} = \frac{\text{Change in Contribution}}{\text{Change in Sales}} \times 100 \quad \text{or}$$

$$\text{P/V ratio} = \frac{\text{Change in Profit}}{\text{Change in Sales}} \times 100$$

It is to be noted that the above two formulas are valid as long as there are no changes in prices, means input prices and selling prices.

Usually, Sales = Cost + Profit

i.e. it can also be written as Sales = Variable Cost + Fixed Cost + Profit and this is called general sales equation.

Since Sales consists of variable costs and contribution, given the variable cost ratio, P/V ratio can be found out. Similarly, given the P/V ratio, variable cost ratio can be found out.

For example, P/V ratio is 40%, then variable cost ratio is 60%, given variable cost ratio is 70%, then P/V ratio is 30%. Such a relationship is called complementary relationship. Thus P/V ratio and variable cost ratios are said to be complements of each other.

P/V ratio is also useful like contribution for determination of profitabilities of the products as well as the priorities for profitabilities of the products. In particular, it is useful in determination of profitabilities of the products in the following two situations:

- (i) When sales potential in value is limited.
- (ii) When there is a greater demand for the products.

3. Break Even Point:

When someone asks a layman about his business he may reply that it is alright. But a technical man may reply that it is break even. So, Break Even means the volume of production or sales where there is no profit or loss. In other words, Break Even Point is the volume of production or sales where total costs are equal to revenue. It helps in finding out the relationship of costs and revenues to output. In understanding the breakeven point, cost, volume and profit are always used. The break even analysis is used to answer many questions of the management in day to day business.

The formal break even chart is as follows:

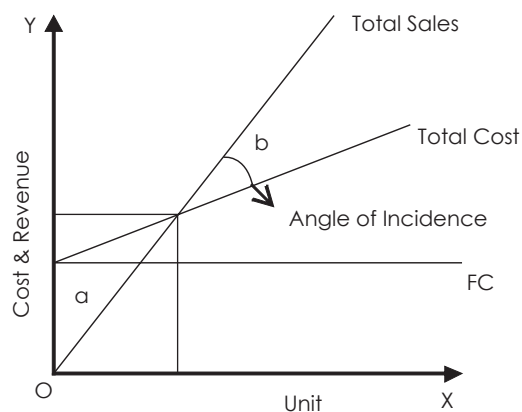

a = Losses

b = Profits

When no. of units are expressed on X-axis and costs and revenues are expressed on Y-axis, three lines are drawn i.e., fixed cost line, total cost line and total sales line. In the above graph we find there is an intersection point of the total sales line and total cost line and from that intersection point if a perpendicular is drawn to X-axis, we find break even units. Similarly, from the same intersection point a parallel line is drawn to X-axis so that it cuts Y-axis, where we find Break Even point in terms of value. This is how, the formal pictorial representation of the Break Even chart.

At the intersection point of the total cost line and total sales line, an angle is formed called Angle of Incidence, which is explained as follows:

Angle of Incidence:

Angle of Incidence is an angle formed at the intersection point of total sales line and total cost line in a formal break even chart. If the angle is larger, the rate of growth of profit is higher and if the angle is lower, the rate of growth of profit is lower. So, growth of profit or profitability rate is depicted by Angle of Incidence.

Break Even Analysis (or) Cost-Volume-Profit Analysis (CVP analysis):

From the breakeven charts breakeven point and profits at a glance can be found out. Besides, management makes profit planning with the help of breakeven charts. It can clearly be understood by way of charts to know the changes in profit due to changes in costs and output. Such profit planning is made with the variables mainly cost, profit and volume, such an analysis is called breakeven analysis. Throughout the charts relationship is established among the cost, volume and profit, it is also called *Cost-Volume-Profit Analysis (CVP analysis)*. That is why it is popularly said by S.C.Kuchal in his book "Financial Management - An Analytical and Conceptual Approach", that **Cost-volume-profit analysis, break even analysis and profit graphs are interchangeable words**. The analysis is further explained as follows:

The change in profit can be studied through Break even charts in different situations in the following manner:

(i) Increase in No. of Units

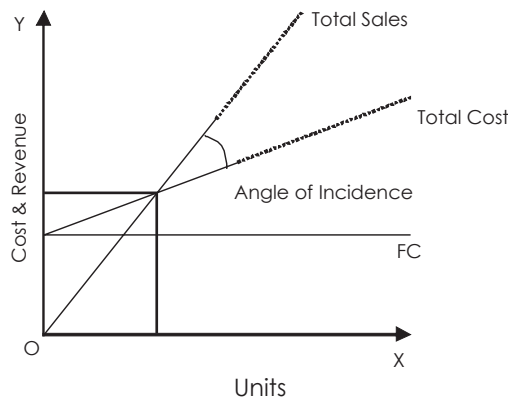

'.....' line indicates increase in total cost and total sales.

In the above chart, if we clearly observe we find that there is no change in BEP even if there is increase or decrease in No. of units.

(ii) Increase in Sales due to increase in selling price.

NTS = New Total Sales line

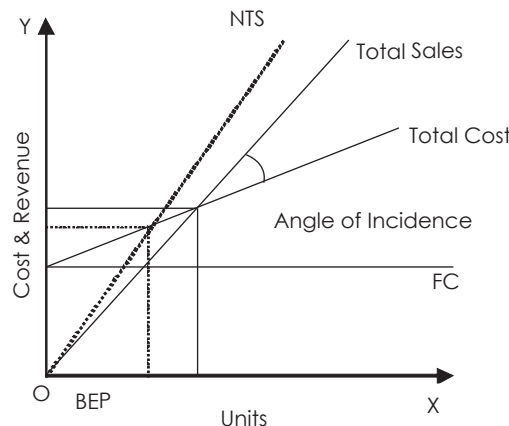

'.....' line indicates changes in break even point and changes in sales.

From the above chart, we observe that profit is increased by increasing the selling price and also, if there is change in selling price, BEP also changes. If selling price is increased then BEP decreases. If selling price is decreased then BEP increases. Thus, we say that there is an inverse relationship between selling price and BEP.

(iii) Decrease in variable cost:

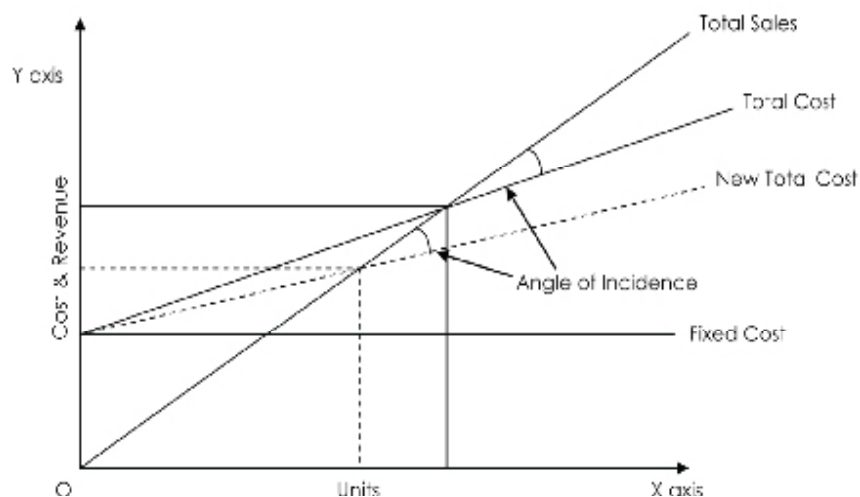

'.....' line indicates decrease in total cost and decrease in B.E.P

From the above chart, we observe that when variable costs are decreased, no doubt, profit is increased. If there is change in variable cost then BEP also changes. If variable cost is decreased then BEP also decreases. If variable cost is increased then BEP also increases. Thus there is direct relationship between variable cost and BEP.

(iv) Change in fixed cost:

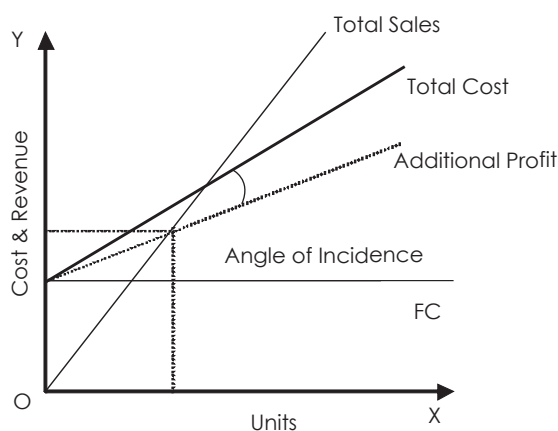

'.....' line indicates decrease in fixed cost and total cost and also decrease in BEP.

NTC = New Total Cost Line

NFC = New Fixed Cost Line

From the above chart also we find that there is increase in profit due to decrease in fixed cost. If fixed cost is increased then BEP also increases. If fixed cost is decreased then BEP also decreases. Thus there is a direct relationship between fixed cost and BEP.

Non linear Break Even Chart:

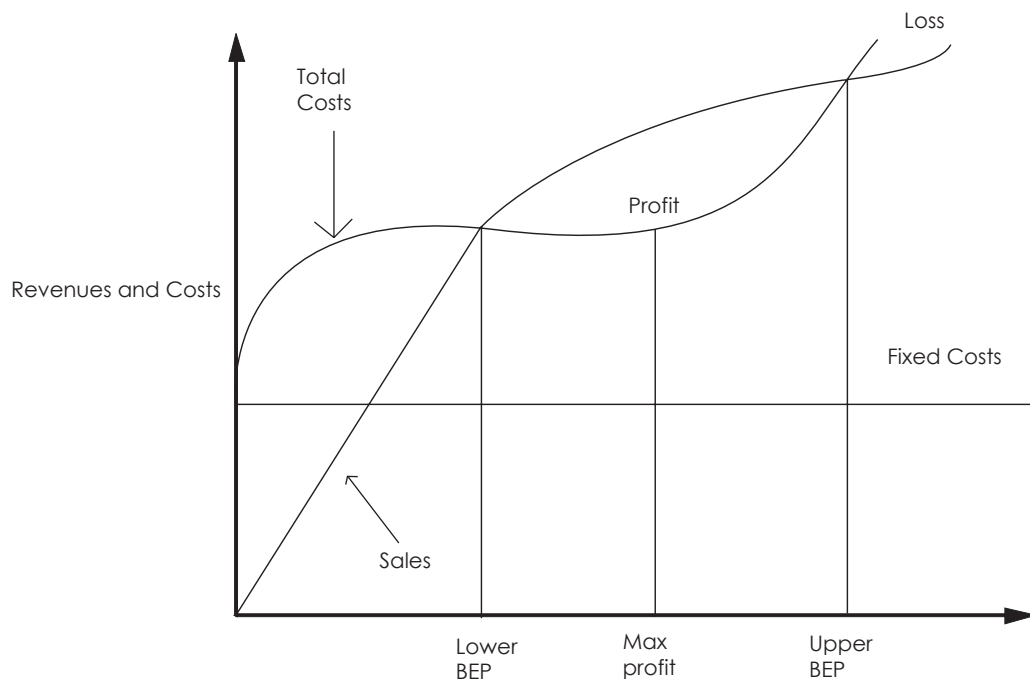

In some cases on account of non-linear behaviour of cost and sales there may be two or more break even points. In such a case the optimum profit is earned where the difference between the sales and the total costs is the largest. It is obvious that the business should produce only upto this level. This is being illustrated in the above chart.

Cash Break-Even Point:

When break-even point is calculated only with those fixed costs which are payable in cash, such a break-even point is known as cash break-even point. This means that depreciation and other non-cash fixed costs are excluded from the fixed costs in computing cash break-even point. Its formula is-

Cash break even point = Cash fixed costs / Contribution per unit.

Profit Volume Chart:

Profit-volume chart prominently exhibits the relationship between profit and sales volume. The normal break-even charts suffer from one limitation. Profit cannot be read directly from the chart. It is essential to deduct total cost from sale to know the profit figure. The profit graph overcomes the difficulty by plotting profit directly against an activity. These charts are easy to understand and their preparation involves drawing sales curve and profit curve. The point at which profit line cuts the sales line is called break-even point. Taking the methods and objects under consideration, the profit-volume chart can be further divided into following categories i.e.,

a. Simple Profit-Volume Chart:

Its preparation involves the following steps:

- (i) Finding out profit at any two levels of activity.
- (ii) Drawing sales line.
- (iii) Drawing profit line.



Simple Profit-Volume chart is shown below:

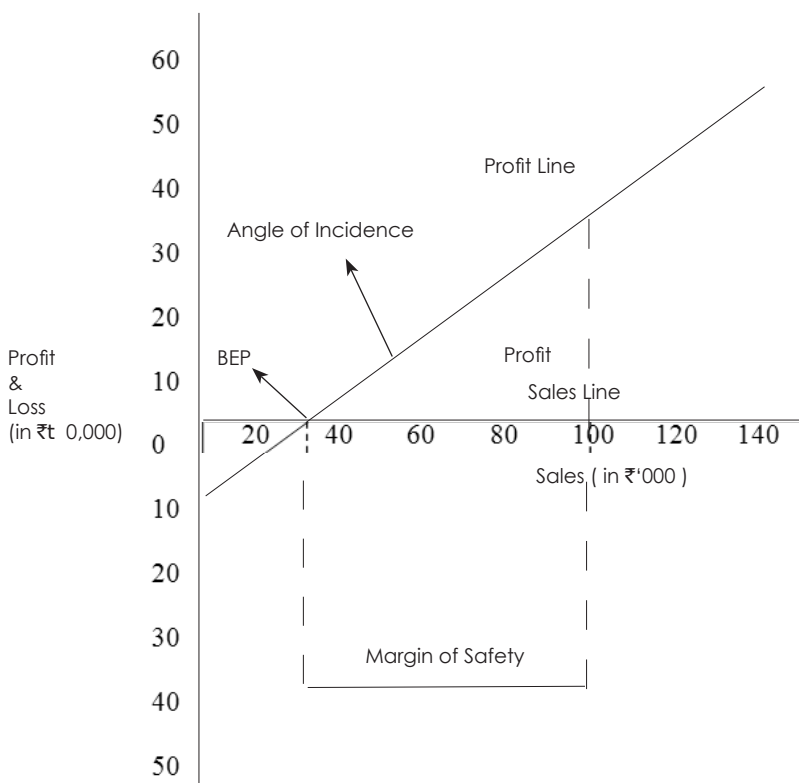

b. Profit volume chart showing different breakeven point at different price levels is shown below:

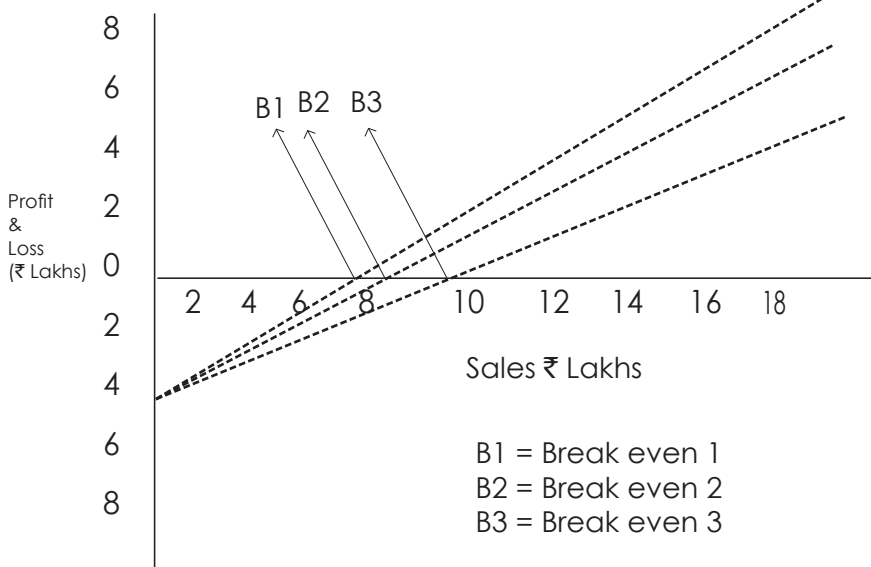

Sequential Profit Graph:

Sometimes, a company manufactures more than one product of varying profitability. A change in the profitability of one product will lead to a change in the profitability as a whole. Profit-volume chart can be prepared for a group also. This chart shows relative profitability of different products. It is also called profit-volume graph for a group of products, sequential profit graph or profit path chart. Its main advantage is that it exhibits the relative profitability of different products at a glance. This graph is also useful to show average slope and marginal slope.



Methods of drawing 'Profit Path':

In sequential profit graph or profit graph for a group of products, a line "profit plan" is drawn in order to draw total profit line. For drawing profit path, a statement is prepared showing cumulative sale and cumulative profit. The line 'Profit path' is drawn with the aid of columns for cumulative same and cumulative profit.

Steps in drawing Profit volume graph (or) sequential profit graph:

- First prepare a marginal cost statement to know the P/V ratios.
- Prepare a statement to find out cumulative sale and cumulative profit.
- Draw a profit path with the help of columns, cumulative sale and cumulative profit.
- Draw total profit line for group of products.

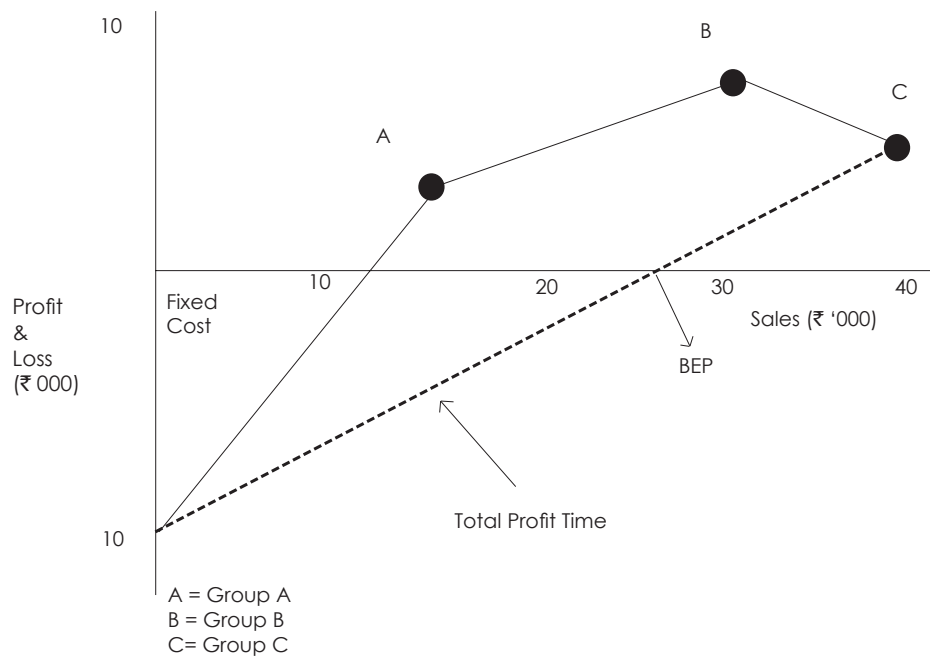

COMPUTATION OF BREAK EVEN POINT:

$$\text{Break Even Point in value} = \frac{F \times S}{S - V} \quad \dots (1)$$

$$= \frac{F \times S}{C} \quad \dots (2)$$

$$= \frac{F \times S}{F + P} \quad \dots (3)$$

$$= \frac{F}{\text{P.V. Ratio}} \quad \dots (4)$$

$$\text{or} = \frac{F}{\frac{C}{S}}$$

$$\text{or} = \frac{F}{\frac{S - V}{S}}$$

$$= \frac{F \times S}{S - V} \quad \dots (5)$$

Break Even Point (in units) = Fixed Cost / Contribution per unit



Proof for basic breakeven:

Let, V be the variable cost per unit

U be the volume of output i.e., No. of units

P be the Profit

F be the Fixed Cost

S be the Selling Price

Where,

F = Fixed Cost

V = Variable Cost

S = Sales

P = Profit

C = Contribution

By substituting the notations in general sales equation:

Sales = Fixed cost + Variable cost + Profit

$$SU = F + VU + P$$

At Break Even, $SU = F + VU$ (Since $P = 0$)

$$\rightarrow SU - VU = F$$

$$\rightarrow U(S - V) = F$$

$$\rightarrow U = \frac{F}{S - V}$$

OR

$$\text{No. of Units} = \frac{\text{Fixed Cost}}{\text{Contribution per Unit}}$$

Break even sales

$$SU (\text{Sales}) = \frac{F \times S}{S - V}$$

Uses and applications of Break even Analysis (Or) Profit Charts (Or) Cost Volume Profit Analysis:

The important uses to which cost-volume profit analysis or break-even analysis or profit charts may be put to use are:

- (a) Forecasting costs and profits as a result of change in Volume determination of costs, revenue and variable cost per unit at various levels of output.
- (b) Fixation of sales Volume level to earn or cover given revenue, return on capital employed, or rate of dividend.
- (c) Determination of effect of change in Volume due to plant expansion or acceptance of order, with or without increase in costs or in other words, determination of the quantum of profit to be obtained with increased or decreased volume of sales.
- (d) Determination of comparative profitability of each product line, project or profit plan.
- (e) Suggestion for shift in sales mix.
- (f) Determination of optimum sales volume.
- (g) Evaluating the effect of reduction or increase in price, or price differentiation in different markets.
- (h) Highlighting the impact of increase or decrease in fixed and variable costs on profit.
- (i) Studying the effect of costs having a high proportion of fixed costs and low variable costs and vice-versa.
- (j) Inter-firm comparison of profitability.
- (k) Determination of sale price which would give a desired profit for break-even.
- (l) Determination of the cash requirements as a desired volume of output, with the help of cash break-even charts.
- (m) Break-even analysis emphasizes the importance of capacity utilization for achieving economy.



- (n) During severe recession, the comparative effects of a shutdown or continued operation at a loss are indicated.
- (o) The effect on total cost of a change in the fixed overhead is more clearly demonstrated through break-even charts.

Limitations of Break-even Analysis:

- (a) That Costs are either fixed or variable and all costs are clearly segregated into their fixed and variable elements. This cannot possibly be done accurately and the difficulties and complications involved in such segregation make the break-even point inaccurate.
- (b) That the behavior of both costs and revenue is not entirely related to changes in volume.
- (c) That costs and revenue patterns are linear over levels of output being considered. In practice, this is not always so and the linear relationship is true only within a short run relevant range.
- (d) That fixed costs remain constant and variable costs vary in proportion to the volume. Fixed costs are constant only within a limited range and are liable to change at varying levels of activity and also over a long period, particularly when additional plants and equipments are introduced.
- (e) That sales mix is constant or only one product is manufactured. A combined analysis taking all the products of the mix does not reflect the correct position regarding individual products.
- (f) That production and sales figures are identical or the change in opening and closing stocks of the finished product is not significant.
- (g) That the units of production on the various product range are identical. Otherwise, it is difficult to find a homogeneous factor to represent volume.
- (h) That the activities and productivity of the concern remain unchanged during the period of study.
- (i) As output is continuously varied within a limited range, the contribution margin remains relatively constant. This is possible mainly where the output is more or less homogeneous as in the case of process industries.

4. Margin of Safety:

It is the sales point beyond the breakeven point. Margin of safety can be obtained by subtracting break even sales from Total sales. It is useful to determine financial soundness of business enterprise. If margin of safety is high, then the financial position of the enterprise is sound.

$$\text{Margin of Safety} = \text{Total Sales} - \text{Break Even Sales} \rightarrow (1)$$

$$\text{Total Sales} = \text{Break Even Sales} + \text{Margin of Safety Sales} \rightarrow (2)$$

→ Margin of safety can also be computed as follows:

$$\text{Margin of Safety} = \text{Profit} / \text{P/V ratio} \rightarrow (3)$$

A relative measure to the margin of safety is its ratio to total sales.

→ Margin of safety ratio is the ratio of Margin of safety sales to Total sales.

$$\text{Margin of safety ratio} = [\text{Margin of safety} / \text{Total sales}] \times 100 \rightarrow (4)$$

→ Margin of safety ratio and Break even sales ratios are complements of each other.

→ If the sales amount, P/V ratio and M/S ratio are given, then profit can be computed as follows:

$$\text{Profit} = \text{Total sales} \times \text{P/V ratio} \times \text{M/S ratio} \rightarrow (5)$$

Apart from the above formulae, various formulae that are used in the chapter to find out different results are as follows:

$$\text{Profit} = (\text{Sales} \times \text{P/V ratio}) - \text{Fixed Cost}$$



$$\text{Sales value to earn desired profit} = \left(\frac{\text{Fixed Cost} + \text{desired profit}}{\text{P/V ratio}} \right) \text{ and}$$

$$\text{Required units to earn desired profit} = \left(\frac{\text{Fixed Cost} + \text{desired profit}}{\text{Contribution per unit}} \right)$$

$$\text{Fixed cost} = (\text{Sales} \times \text{P/V ratio}) - \text{Profit}$$

$$\text{Total sales} = \text{Break even sales} + \text{Margin of safety sales}$$

$$\text{Break even sales} = \text{Total sales} - \text{Margin of safety sales}$$

$$\text{Margin of safety sales} = \text{Total sales} - \text{Break even sales}$$

$$\text{Fixed cost} = \text{Break even sales} \times \text{P/V ratio}$$

$$\text{Shut down sales} = \left(\frac{\text{Fixed Cost} - \text{Shut down costs}}{\text{P/V ratio}} \right)$$

$$\text{Shut down Units} = \left(\frac{\text{Fixed Cost} - \text{Shut down costs}}{\text{Contribution per unit}} \right)$$

The level at which profits are same or the level at which costs are same for two methods or two alternatives

$$\text{i.e., Indifference Point} = \left(\frac{\text{Difference in fixed costs}}{\text{Difference in variable costs per unit}} \right)$$

Operating or Service Costing

Cost Accounting has been traditionally associated with manufacturing companies. However in the modern competitive market, cost accounting has been increasingly applied in service industries like banks, insurance companies, transportation organizations, electricity generating companies, hospitals, passenger transport and railways, hotels, road maintenance, educational institutions, road lighting, canteens, port trusts and several other service organizations. The costing method applied in these industries is known as 'Operating Costing'.

According to CIMA [London] operating costing is, '*that form of operating costing which applies where standardized services are provided either by an undertaking or by a service cost center within an undertaking*'.

Nature of Operating Costing:

The main objective of operating costing is to compute the cost of the services offered by the organization. For doing this, it is necessary to decide the unit of cost in such cases. The cost units vary from industry to industry. For example, in goods transport industry, cost per ton kilometer is to be ascertained while in case of passenger transport, cost per passenger kilometer is to be computed. Cost units used in different service units are explained in detail later in chapter. The next step is to collect and identify various costs under different headings.

The headings used are,

- (a) Fixed or standing charges
- (b) Semi-fixed or maintenance charges
- (c) Variable or running charges.

One of the important features of operating costing is that mostly such costs are fixed in nature. For example, in case of passenger transport organization, most of the costs are fixed while few costs like diesel and oil are variable and dependent on the kilometers run.

Because of the diverse nature of activities carried out in service undertakings, the cost system used is obviously different from that of manufacturing concern. Let us discuss the method of computing costs in various service organisations .



Transport Organisation: Costing in a transport industry consists of determining the operating cost of each vehicle and applying this cost to find out the cost per unit of service rendered by a vehicle. The cost unit is selected with proper care keeping in view the needs of each concern, the weight, bulk, volume and type of goods carried and distance covered in each trip. Transport undertakings include goods transport organizations as well as passenger transport organizations. The cost unit is either ton kilometer or passenger kilometer. The meaning is cost of carrying one ton over a distance of one kilometer or cost of carrying one passenger for a distance of one kilometer.

Collection of Costs: A log book is maintained for each vehicle to record details of trips made by the vehicle during a specified period of time. Log book is maintained usually on a daily basis. The details shown in the log book enables the management to make suitable allocation of vehicles, to avoid the duplicate trips, or to avoid idle running capacity. The log book also provides the information relating to the fuel consumed, distance travelled, no of hours travelled, chargeable kilo meters. The log book provide the data for proper allocation of cost and in this respect these may be compared with the production details available in a manufacturing concern

Classification of Costs:

The costs of a transport organisation can be classified and accumulated under the following heads:-

- (a) *Fixed or stand-by costs:* These costs which include garage charges, insurance, taxes, license, depreciation, wages of drivers, cleaner's salary, establishment cost of workshop and office. Out of the above some of the costs are directly identifiable for each vehicle such as license fee and some are apportioned such as office expenses
- (b) *Maintenance Charges:* These costs are in the nature of semi-variable nature includes expenditure on maintenance, repairs, tyres, tubes and other charges.
- (c) *Operating and Running costs:* These costs are variable in nature, includes fuel, lubricating oil, wages of drivers/cleaners (if paid on per trip / kilometer). These costs can be easily identifiable with each of the vehicle.

Significance of Operating or Running Costs:

- (i) Control of operating and running cost and avoidance of waste of fuel and other consumable material.
- (ii) Cost of running own vehicles may compared with the hired or other forms of transport.
- (iii) Facilitates quotation of hiring rates to outside parties who ask for the transport service.
- (iv) If transport service is treated as a separate department or service cost center, the costs to be charged to the requesting department may be easily determined.
- (v) Suitable information is obtained for efficient routing of vehicles.
- (vi) Cost of idle vehicles and lost running time is easily obtained.

Relevant Cost Analysis

For decision making purpose, it is necessary to classify costs and revenues based on whether they are relevant or irrelevant to the decisions. Relevant costs and revenues are those, that are influenced by the decisions. Irrelevant costs and revenues are those, that are not affected or influenced by the decisions.

Relevant costs are those expected future costs that are essential but differ for alternative courses of action. It is a future cost that would arise as a direct consequence of the decision under review.

Relevant costing is a management accounting toolkit that helps managers reach decisions when they are posed with the following questions:

1. Whether to buy a component from an external vendor or manufacture it in house?
2. Whether to accept a special order?
3. What price to charge on a special order?
4. Whether to discontinue a product line?
5. How to utilize the scarce resource optimally?, etc.



Relevant costing is an incremental analysis which means that it considers only relevant costs i.e. costs that differ between alternatives and ignores sunk costs i.e. costs which have been incurred, which cannot be changed and hence are irrelevant to the scenario.

The costs which should be used for decision making are often referred to as "relevant costs". CIMA defines relevant costs as 'costs appropriate to aiding the making of specific management decisions'.

To affect a decision a cost must be:

- (a) **Future:** Past costs are irrelevant, as we cannot affect them by current decisions and they are common to all alternatives that we may choose.
- (b) **Incremental:** Expenditure which will be incurred or avoided as a result of making a decision. Any costs which would be incurred whether or not the decision is made are not said to be incremental to the decision.
- (c) **Cash flow:** Expenses such as depreciation are not cash flows and are therefore not relevant. Similarly, the book value of existing equipment is irrelevant, but the disposal value is relevant.

Example

Company A manufactures bicycles. It can produce 1,000 units in a month for a fixed cost of ₹ 3,00,000 and variable cost of ₹ 500 per unit. Its current demand is 600 units which it sells at ₹ 1,000 per unit. It is approached by Company B for an order of 200 units at ₹ 700 per unit. Should the company accept the order?

Solution:

A layman would reject the order because he would think that the order is leading to loss of ₹ 100 per unit assuming that the total cost per unit is ₹ 800 (fixed cost of ₹ 3,00,000/1,000 and variable cost of ₹ 500 as compared to revenue of ₹ 700).

On the other hand, a management accountant will go ahead with the order because in his opinion the special order will yield ₹ 200 per unit. He knows that the fixed cost of ₹ 300,000 is irrelevant because it is going to be incurred regardless of whether the order is accepted or not. Effectively, the additional cost which Company A would have to incur is the variable cost of ₹ 500 per unit. Hence, the order will yield ₹ 200 per unit (₹ 700 minus ₹ 500 of variable cost).

Normally, the following are relevant Costs:

Differential Cost

- (i) A differential cost is the difference in cost items under two or more decision alternatives specifically two different projects or situations. Where same item with the same amount appears in all alternatives, it is irrelevant. For example, a plot of land can be used for a shopping mall or entertainment park. The plot is irrelevant since it would be used in both the cases.
- (ii) An example of differential cost would be of a company which is selling its products through distributors. It is paying them a commission of ₹ 16 million. Any alternate which costs lesser would be considered. Let us suppose that the company is planning to appoint salespersons to sell its products and cancels the contracts with distributors. In this case, the selling expense is expected to be ₹ 12 million. There is cost differential ₹ 4 million ₹ (16 m - 12m). This is a good sign but the risk would have to be considered for changing the channel of distribution. If there is low risk, it would be prudent to go for own arrangements for sales.

Differential costs must be compared to differential revenues. In case, switching over to direct sales bring additional revenues of ₹ 2 million, it would increase the net benefit to ₹ 6 million. This would provide more comfort to the decision maker while considering a change in the distribution channel.

Incremental or Marginal Cost

- (i) Whereas differential cost is a difference between the cost of two independent alternatives, incremental or marginal cost is a cost associated with producing an additional unit. In case of a university, it could be cost of admitting another student. Even operating a second shift is an example of incremental cost. It would be noted that the two decisions are not independent as second shift depends upon first shift.
- (ii) Incremental cost must be compared with incremental revenues to arrive at a decision.



Opportunity Cost

- (i) It is cost of opportunity foregone. Mr. Ahmed Shah left a bank job which was paying him ₹ 15,000 per month and got admission in a University. Monthly fee-charge in the university is ₹ 10,000 per month. For Ahmed Shah, this would be ₹ 25,000 per month (₹ 10,000 + ₹ 15,000).
- (ii) Farhana is a fresh graduate from a business university. She got two offers, one of ₹ 25,000 from an investment bank and another of ₹ 15,000 for a teaching-assistant in a university. Another of her class-fellow, Shabana got the same offer from the same university. While Shabana would be happy to join the university, Faraha would not be as she would lose an opportunity to serve at the bank for ₹ 25,000.
- (iii) Whenever an organization is deciding to go for a particular project, it should not ignore opportunities for other projects. It should consider (i) what alternative opportunities are there? (2) Which is the best of these alternative opportunities?

Avoidable costs

These are costs that can be eliminated in whole or in part by choosing one alternative over another. Avoidable costs are relevant costs.

Replacement Cost: It is the cost at which there could be purchase of an asset or material identical to that which is being replaced or revalued. It is the cost of replacement at current market price and is relevant for decision-making.

Imputed Costs

These are Notional Costs appearing in the Cost Accounts only e.g. notional rent charges, interest on capital for which no interest has actually been paid. These are relevant costs for decision-making. Where alternative capital investment projects are being evaluated, it is necessary to consider the imputed interest on capital before a decision is arrived at as to which is the most profitable project.

Out-of-Pocket Cost

These are costs that entail current or near future cash outlays for the decision at hand. Such costs are relevant for decision - making, as these will occur in near future. This cost concept is a short-run concept and is used in decisions on fixing Selling Price in recession, Make or Buy, etc. Out-of-Pocket costs can be avoided or saved if a particular proposal under consideration is not accepted.

Special Decisions

There are special decisions where relevant costs and benefits are to identified before proceeding further. Such decisions are:

- (i) Accept or reject an order when there is excess capacity
- (ii) Accept or reject an order when there is no excess capacity
- (iii) Outsource a product or service
- (iv) Add, drop a product, service or department
- (v) Sell or process further
- (vi) Optimization of limited resources or working under constraint.

Irrelevant Costs

Sunk Costs

Sunk costs are costs that were incurred in the past. **Committed costs** are costs that will occur in the future, but that cannot be changed. As a practical matter, sunk costs and committed costs are equivalent with respect to their decision-relevance; neither is relevant with respect to any decision, because neither can be changed. Sometimes, accountants use the term "sunk costs" to encompass committed costs as well.

Experiments have been conducted that identify situations in which individuals, including professional managers, incorporate sunk costs in their decisions. One common example from business is that a manager will often continue to



support a project that the manager initiated, long after any objective examination of the project seems to indicate that the best course of action is to abandon it. A possible explanation for why managers exhibit this behavior is that there may be negative repercussions to poor decisions, and the manager might prefer to attempt to make the project look successful, than to admit to a mistake.

Here is an example. Consider a student who is between her junior and senior year in college, deciding whether to complete her degree. From a financial point of view (ignoring nonfinancial factors) her situation is as follows. She has paid for three years of tuition. She can pay for one more year of tuition and earn her degree, or she can drop out of school. If her market value is greater with the degree than without the degree, then her decision should depend on the cost of tuition for next year and the opportunity cost of lost earnings related to one more year of school, on the one hand; and the increased earnings throughout her career that are made possible by having a college degree, on the other hand. In making this comparison, the tuition paid for her first three years is a sunk cost, and it is entirely irrelevant to her decision. In fact, consider three individuals who all face this same decision, but one paid ₹ 24,000 for three years of in-state tuition, one paid ₹ 48,000 for out-of-state tuition, and one paid nothing because she had a scholarship for three years. Now assume that the student who paid out-of-state tuition qualifies for in-state tuition for her last year, and the student who had the three-year scholarship now must pay in-state tuition for her last year. Although these three students have paid significantly different amounts for three years of college (₹ 0, ₹ 24,000 and ₹ 48,000), all of those expenditures are sunk and irrelevant, and they all face exactly the same decision with respect to whether to attend one more year to complete their degrees. It would be wrong to reason that the student who paid ₹ 48,000 should be more likely to stay and finish, than the student who had the scholarship.

Committed Cost

A committed cost is an investment that a business entity has already made and cannot recover by any means, as well as obligations already made that the business cannot get out of.

For example, if a company buys a machine for ₹40,000 and also issues a purchase order to pay for a maintenance contract for ₹2,000 in each of the next three years, all ₹46,000 is a committed cost, because the company has already bought the machine, and has a legal obligation to pay for the maintenance. A multi-year property lease agreement is also a committed cost for the full term of the lease, since it is extremely difficult to terminate a lease agreement.

Absorbed Cost

The indirect costs that are associated with manufacturing. Absorbed costs include such expenses as insurance, or property taxes for the building in which the manufacturing process occurs. When the total manufacturing costs are determined, the implicit absorbed costs are not considered, but will be included in a separate account.

Absorbed Fixed Cost: Fixed Costs which do not change due to increase or decrease in activity is irrelevant to decision-making. Although Fixed Costs are absorbed in cost of production on a normal rate, they are irrelevant for managerial decision-making. However if Fixed Costs are specific, they become relevant for decision-making.

Fixed Costs are unrelated to output and are generally irrelevant for decision-making purpose. However, in the following circumstances, Fixed Costs become relevant for decision-making -

1. When Fixed Costs are specifically incurred for any contract,
2. When Fixed Costs are incremental in nature.
3. When the fixed portion of Semi-Variable Cost increases due to change in level of activity consequent to acceptance of a contract.
4. When Fixed Costs are avoidable or discretionary,
5. When Fixed Costs are such that one cost is incurred in lieu of another (the difference in costs will be relevant for decision-making.)



Relevant Cost for Material

Case-1	Opportunity Cost of Material already purchased and having no other use in current production process and having No Realisable Value.	Nil
Case-2	Opportunity Cost of Material already purchased and having no other use in current production process but having Realisable Value.	Opportunity Cost of the Material i.e., Best Alternative Use
Case-3	Opportunity Cost of Material required under proposed production. Only some portion thereof is held in stock out of purchase and having no other use in current production process but having Realisable Value.	Realisable Value
Case-4	Opportunity Cost of Material already Purchased and held in Godown and having Regular Use in current production process.	Replacement Cost i.e., Current Purchase Price
Case-5	Opportunity Cost of Material already Purchased and held in Godown and having Regular Use in current production process as a substitute Material.	Replacement Cost i.e., Current Purchase Price
Case-6	Opportunity Cost of Material already purchased and having no other use in current production process and having No Realisable Value but can be disposed by incurring some additional cost.	Saving in Additional Disposal Cost i.e., Benefit or (-) Cost.
Case-7	Opportunity Cost of Material (Say A) already purchased that can be used after suitable alteration in place of other material (Say B) or can be disposed off.	(a) Resale Value of Material A or (b) Current Purchase Price of Material B – Alteration cost of Material A. Whichever is higher

Instead of all the above 7 cases remember:

Already purchased Material not used in Regular Production Process	<ul style="list-style-type: none"> The maximum Benefit you can drive from the Material is the Opportunity Cost. (for other than using in an offer) If used in Offer the Old Purchase Price.
Material used in Regular Production Process or Material required to be purchased for the offer.	Current Purchase Price

Labour

Labour is of two types: -

(1) Casual Labour

- It means Temporary Labour.
- Payment according to work only.
- It may be Idle or Busy (if Busy it means Short Supply)

(2) Permanent Labour

- Those Labour whom the management could not reduce, retrench, terminate, due to an agreement with labour.
- Agreed Labour payment irrespective of work.
- It may be Idle or Busy.



Relevant Cost of Labour

	Idle	Busy
Casual	Cost to be incurred	Cost to be incurred + Contribution Lost
Permanent	Nil	Benefit Lost (ignoring Sunk Cost)

Relevant Cost of Machines

Machine	Relevant Cost
Useless	Difference of Resale Value
Regular Use	Difference of Replacement Cost

Example-1

Machine (Original Cost)	₹ 1,00,000
Life of Machine	5 Years
WDV	Nil
Resale Value	₹ 10,000
No other use of the machine.	

Offer: To use the machine for construction of a Guest House for 1 year. Resale Value after 1 year is ₹1,000. Find out the Opportunity Cost of Machine.

Solution:

- Relevant Cost of utilising machine in order to complete the offer is ₹ 9,000 (10,000 – 1,000), that is benefit lost due to acceptance of offer.
- If the machine has no other use then Relevant Cost is difference of Resale Value.

Example-2 – (Relevant cost of machines which are in Regular Use)

The Company has M1 type of Machines which are of regular use. The company receives an offer for construction of guest house. The Company requires M1 type of machine.

- Current Purchase Price of Machine at beginning of the Year ₹1,00,000.
- Such machine shall be transferred to regular work at ₹90,000 at the end of work of offer.

Solution:

	Amount (₹)
Cost to be incurred	10,000
(-) Transferred Cost	90,000
Difference of Replacement Cost	10,000

Relevant Cost for Overheads

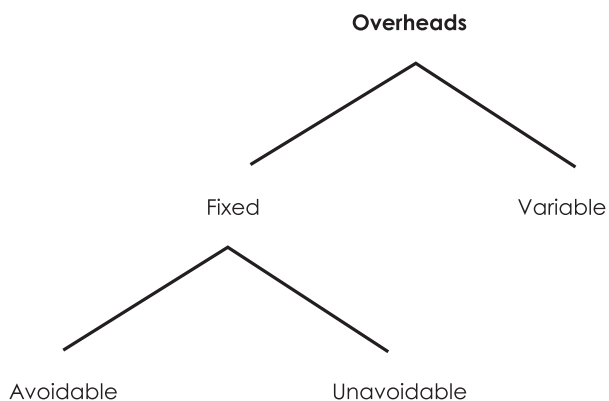



Fixed Overheads

- (1) **Avoidable Fixed Costs: are always relevant for the decision (cost to be incurred) like extra machine rent, extra supervisor salary.**
- (2) **Unavoidable Fixed Costs: Always to be ignored due to Sunk Cost (future obligation already decided).**
 - Change in apportionment does not change in cash outflow.
 - For **Decision Making** Fixed Costs are always to be expressed in totality instead of unit wise.

Variable Overheads

- (i) Variable Overheads to be incurred due to acceptance of offer, hence relevant for decision making.
- (ii) If Variable Overheads include **Indirect Material, Indirect Labour** then such Variable Overheads to be linked with **Production**.
- (iii) If Variable Overheads include **Indirect Expenses** (Power, Electricity, Energy) then Variable Overheads always linked with **Working Hours**.
- (iv) If the break-up of Variable Overheads are not given in question then always presume Variable Overheads include Indirect Expenses like power, electricity, **based on hours**.

If the Question is silent about nature of Resources: -		
(i)	Material	Slow Moving
(ii)	Labour	Casual
(iii)	Casual + Busy	Short Supply
(iv)	Overheads	Fixed – Unavoidable (allocated, absorbed, recovered, apportioned, added to products, General Overheads)

Classification based on Costs for Management Decision Making

Ascertainment of cost is essential for making managerial decisions. On this basis costing may be classified into the following types

Marginal Costing: Marginal Cost is the aggregate of variable costs, i.e. prime cost plus variable overhead. Marginal cost per unit is the change in the amount at any given volume of output by which the aggregate cost changes if the volume of output is increased or decreased by one unit. Marginal Costing system is based on the system of classification of costs into fixed and variable. The fixed costs are excluded and only the marginal costs, i.e. the variable costs are taken into consideration for determining the cost of products and the inventory of work-in-progress and completed products.

Differential Cost: Differential cost is the change in the cost due to change in activity from one level to another.

Opportunity Cost: Opportunity cost is the value of alternatives foregone by adopting a particular strategy or employing resources in specific manner. It is the return expected from an investment other than the present one. These refer to costs which result from the use or application of material, labour or other facilities in a particular manner which has been foregone due to not using the facilities in the manner originally planned. Resources (or input) like men, materials, plant and machinery, finance etc., when utilized in one particular way, yield a particular return (or output). If the same input is utilized in another way, yielding the same or a different return, the original return on the forsaken alternative that is no longer obtainable is the opportunity cost. For example, if fixed deposits in the bank are proposed to be withdrawn for financing project, the opportunity cost would be the loss of interest on the deposits. Similarly when a building leased out on rent to a party is got vacated for own purpose or a vacant space is not leased out but used internally, say, for expansion of the production programme, the rent so foregone is the opportunity cost.

Replacement Cost: Replacement cost is the cost of an asset in the current market for the purpose of replacement. Replacement cost is used for determining the optimum time of replacement of an equipment or machine in



consideration of maintenance cost of the existing one and its productive capacity. This is the cost in the current market of replacing an asset. For example, when replacement cost of material or an asset is being considered, it means that the cost that would be incurred if the material or the asset was to be purchased at the current market price and not the cost at which it was actually purchased earlier, should be taken into account.

Relevant Costs: Relevant costs are costs which are relevant for a specific purpose or situation. In the context of decision making, only those costs are relevant which are pertinent to the decision at hand. Since we are concerned with future costs only while making a decision, historical costs, unless they remain unchanged in the future period are irrelevant to the decision making process.

Imputed Costs: Imputed costs are hypothetical or notional costs, not involving cash outlay computed only for the purpose of decision making. In this respect, imputed costs are similar to opportunity costs. Interest on funds generated internally, payment for which is not actually made is an example of imputed cost. When alternative capital investment projects are being considered out of which one or more are to be financed from internal funds, it is necessary to take into account the imputed interest on own funds before a decision is arrived at.

Sunk Costs: Sunk costs are historical costs which are incurred i.e. sunk in the past and are not relevant to the particular decision making problem being considered. Sunk costs are those that have been incurred for a project and which will not be recovered if the project is terminated. While considering the replacement of a plant, the depreciated book value of the old asset is irrelevant as the amount is sunk cost which is to be written-off at the time of replacement.

Normal Cost & Abnormal Cost: Normal Cost is a cost that is normally incurred at a given level of output in the conditions in which that level of output is achieved. Abnormal Cost is an unusual and typical cost whose occurrence is usually irregular and unexpected and due to some abnormal situation of the production.

Avoidable Costs & Unavoidable Costs: Avoidable Costs are those which under given conditions of performance efficiency should not have been incurred. Unavoidable Costs which are inescapable costs, which are essentially to be incurred, within the limits or norms provided for. It is the cost that must be incurred under a programme of business restriction. It is fixed in nature and inescapable.

Uniform Costing: This is not a distinct system of costing. The term applies to the costing principles and procedures which are adopted in common by a number of undertakings which desire to have the benefits of a uniform system. The methods of Uniform Costing may be extended so as to be useful in inter-firm comparison.

Engineered Cost: Engineered Cost relates to an item where the input has an explicit physical relationship with the output. For instance in the manufacture of a product, there is a definite relationship between the units of raw material and labour time consumed and the amount of variable manufacturing overhead on the one hand and units of the products produced on the other. The input-output relationship can be established in the form of standards by engineering analysis or by an analysis of the historical data. It should be noted that the variable costs are not engineered cost but some administration and selling expenses may be categorized as engineered cost.

Out-of-Pocket Cost: This is the portion of the cost associated with an activity that involves cash payment to other parties, as opposed to costs which do not require any cash outlay, such as depreciation and certain allocated costs. Out-of-Pocket Costs are very much relevant in the consideration of price fixation during trade recession or when a make-or-buy decision is to be made.

Managed Cost: Managed (Programmed or Discretionary) Costs all opposed to engineering costs, relate to such items where no accurate relationship between the amount spent on input and the output can be established and sometimes it is difficult to measure the output. Examples are advertisement cost, research and development costs, etc.,

Common Costs: These are costs which are incurred collectively for a number of cost centres and are required to be suitably apportioned for determining the cost of individual cost centres. Examples are: Combined purchase cost of several materials in one consignment, and overhead expenses incurred for the factory as a whole.

Controllable and Non-Controllable Costs: Controllable Cost is that cost which is subject to direct control at some level of managerial supervision. Non-controllable Cost is the cost which is not subject to control at any level of managerial supervision.

**Illustration 1. (Break Even Analysis)**

Accelerate Co. Ltd., manufactures and sells four types of products under the brand names of A, B, C and D. The sales mix in value comprises 33 1/3%, 41 2/3%, 16 2/3% and 8 1/3% of products A,B,C and D respectively. The total budgeted sales (100%) are ₹ 60,000 p.m. Operating Costs are:

Variable Costs:

Product A 60% of selling Price Product B 68% of selling Price Product C 80% of selling Price

Product D 40% of selling Price

Fixed Costs: ₹14,700 p.m.

(a) Calculate the break-even-point for the products on overall basis and

(b) Also calculate break-even-point, if the sales mix is changed as follows the total sales per month remaining the same.

(Mix: - A - 25% : B - 40% : C - 30%: D - 5%)

Solution:

(a) Statement showing computation of break even point on overall basis:

Amount (₹)

	A	B	C	D	TOTAL
a) Sales	20000	25000	10000	5000	60000
b) Variable cost	12000	17000	8000	2000	39000
c) Contribution	8000	8000	2000	3000	21000
d) Fixed cost					14700
e) Profit					6300
f) P/V ratio	40%	32%	20%	60%	35%
g) Break even sales	14700/35% =				42000

(b) Statement showing computation of break even point if the sales mix is changed:

Amount (₹)

	A	B	C	D	TOTAL
Sales	15000	24000	18000	3000	60000
Variable cost	9000	16320	14400	1200	40920
Contribution	6000	7680	3600	1800	19080
Fixed cost					14700
P/V ratio	40%	32%	20%	60%	(19080/60000) x 100 = 31.8%
Break even sales					14700/31.8% = 46266

Illustration 2. (Evaluation of Order)

A Co. currently operating at 80% capacity has the following; profitability particulars:

	Amount (₹)	Amount (₹)
Sales		12,80,000
Costs:		
Direct Materials	4,00,000	
Direct labour	1,60,000	
Variable Overheads	80,000	
Fixed Overheads	5,20,000	11,60,000
Profit		1,20,000



An export order has been received that would utilise half the capacity of the factory. The order has either to be taken in full and executed at 10% below the normal domestic prices, or rejected totally. The alternatives available to the management are given below:

- a) Reject order and Continue with the domestic sales only, as at present;
- b) Accept; order, split capacity equally between overseas and domestic sales and turn away excess domestic demand;
- c) Increase capacity so as to accept the export order and maintain the present domestic sales by:
 - (i) buying an equipment that will increase capacity by 10% and fixed cost by ₹40,000 and
 - (ii) Work overtime at one and a half the normal rate to meet balance of required capacity. Prepare comparative statements of profitability and suggest the best.

Solution:

Statement showing computation of comparative profit of different alternatives:

Amount (₹)

	80% capacity	100% capacity	130% capacity
Sales	1280000	800000 + 720000	1280000 + 720000
Variable cost:			
Material	400000	500000	650000
Direct labour	160000	200000	260000
Variable OHs	80000	100000	130000
Overtime premium			20000
	640000	800000	1060000
Contribution	640000	720000	940000
Fixed cost	(520000)	(520000)	(560000)
Profit	120000	200000	380000

From the above computations we find that the profit is more at alternative III i.e., accepting the foreign order fully & maintaining the present domestic sales.

Illustration 3. (Indifference Point)

A practicing Cost and Management Accountant now spends ₹0.90 per K.m on taxi fares for his client's work. He is considering two other alternatives the purchase of a new small car or an old bigger car.

Item	New Small Car Amount (₹)	Old Bigger Car Amount (₹)
Purchase price	35,000	20,000
Sale price after 5 years	19,000	12,000
Repairs and servicing per annum	1,000	1,200
Taxes and insurance p.a.	1,700	700
Petrol consumption per liter(k.m.)	10	7
Petrol price per liter	3.5	3.5

He estimates that he does 10,000 Km annually. Which of the three alternatives will be cheaper? If his practice expands he has to do 19,000 Km p.a. where will the cost of the two cars break even and why? Ignore interest and Income-tax.

**Solution:****Statement showing computation of break-even point for three alternatives:**

	Taxi Amount (₹)	New smaller car Amount (₹)	Old bigger car Amount (₹)
Fixed Cost: Depreciation		16000/5 = 3200	8000/5 = 1600
Repairs		1000	1200
Taxes		1700	700
		5900	3500
Variable cost per KM	0.9	0.35	0.5
TOTAL COST PER 10000 KMS	9000	3500 + 5900 = 9400	5000 + 3500 = 8500
Cost per 19000 KMS	17100	12550	13000

(a) At 10000 KMS old bigger car is cheaper than the other two alternatives.

(b) At 19000 KMS it is better and cheaper to purchase the new smaller car.

Indifference point = (difference in fixed cost / difference in variable cost per unit) = (2400/0.15) = 16000kms

Illustration 4. (Indifference Point)

Study Horse Ltd., a cycle manufacturing company, has drawn up a programme for the manufacture of a new product for the purpose of fuller utilisation of its capacity. The scheme envisages the manufacture of baby tricycle fitted with a bell. The company estimates the sales of tricycles at 10,000 during the first year and expects that from the second year onwards the sales estimates will stabilise at 20,000 tricycles. Since the company has no provision for the manufacture of the small bells. It is initially proposed to be met by way of purchase from the market, at ₹ 8 each.

However, if the company desires to manufacture the bell in its factory by installation of new equipment, it has two alternative proposals as under:

	Installation of Super-X Machine	Installation of Janta Machine
Initial cost of machine	₹ 3,00,000	₹ 2,00,000
Life	10 years	10 years
Fixed overheads other than depreciation on machines (per annum)	₹ 54,000	₹ 28,000
Variable expenses per bell	₹ 4.00	₹ 5.00

Depreciation on machine should be charged on straight line basis.

Required:

- For each of the two levels of output namely, 10,000 and 20,000 bells state with suitable workings whether the company should purchase the bells from market or install new equipment for manufacture of bells. If your decision is in favour of the installation of new equipment, which of the two new machines should be installed?
- What would be your decision in case the forecast of requirement from the second year onwards is estimated at 40,000 bells instead of 20,000 bells.
- At what volume of bells will the installation of the two machines break even.

**Solution:**

(i) and (ii)

Statement showing comparative costs at the 3 levels of output at the 3 alternatives **Amount (₹)**

Particulars	Market	10,000 SPX	Janta	Market	20,000 SPX	Janta	Market	40,000 SPX	Janta
Fixed Cost:									
Depreciation		30,000	20,000		30,000	20,000		30,000	20,000
FOH other than dep.		54,000	28,000		54,000	28,000		54,000	28,000
Variable Cost		84,000	48,000		84,000	48,000		84,000	48,000
	80,000	40,000	50,000	1,60,000	80,000	1,00,000	3,20,000	1,60,000	2,00,000
Total Cost	80,000	1,24,000	98,000	1,60,000	1,64,000	1,48,000	3,20,000	2,44,000	2,48,000

From the above computations it is evident that,

At level of out put 10,000 - buying from market

20,000 - Installation of Janta

40,000 - Installation of Super - X are beneficial.

(iii) Volume of bells at which the two machines will break even = $\frac{\text{Difference in FC}}{\text{Difference in VC per unit}}$

$$\frac{84,000 - 48,000}{5 - 4} = 36,000$$

Illustration 5. (Optimum Mix)

Something More Ltd. is considering adding to its product line. After a lot of deliberations between the sales and production personnel, it is decided that products P, Q and R would be the most desirable additions to be company's product range on account of the technical competency, marketing potential and production flexibility as regards these products. In fact P, Q and R can all be made on the same kind of plant as that already in use and therefore as regards production, all products can be readily interchanged. However, it is considered necessary to build further plant facilities to cater for additional production. In this connection the following data are relevant:

Amount (₹)

Products (Per Unit)	P	Q	R
Direct Materials	100	120	90
Direct Labour	50	70	90
Variable Overheads	50	130	100
Selling Price	350	420	370
Demand in units per cost period (on the basis of the above selling price)	200	125	750
Machine Hours required per units of production	15	5	3

It is felt that initially extra plant facilities can be built to operate at the following five different levels of activity, viz., 1,800; 2,300; 2,800; 3,300 and 3,800 machine hours per cost period. The fixed overhead costs for a cost period relevant to these five different levels of activity are estimated at ₹ 15,000; ₹20,000; ₹ 26,000; ₹33,000 and 39,000 respectively.

You are required to advise, with supporting figures, the product or products to be manufactured and in what quantities at each of the five contemplated levels of activity in order to maximize the profits at each level and also indicate the level of activity that would seem most desirable to be pursued for such maximization of profits.

Solution:

Statement showing contribution per machine hour and determination of priority for profitability Amount (₹)

	P		Q		R	
Selling Price	-	350		420		370
Variable Cost:						
Direct Material	100		120		90	
Direct Labour	50		70		90	
Variable Overheads	50	200	130	320	100	280
Contribution Per unit		150		100		90
Contribution per machine hour		10		20		30
		III		II		I

Statement Showing optimum mix and profit of the 5 levels and determination of capacity to be pursued for maximization of profit:

Level of Activity	P			Q			R			Total Contrib. ₹	Fixed Cost ₹	Profit ₹
	Hours	Units	Contrib. ₹	H	U	C	H	U	C			
1800	-	-	-	-	-	-	1800	600	54000	54000	15000	39000
2300	-	-	-	50	10	1000	2250	750	67500	68500	20000	48500
2800	-	-	-	550	110	11000	2250	750	67500	78500	26000	52500
3300	425	28.33	4250	625	125	12500	2250	750	67500	84250	33000	51250
3800	925	61.67	9250	625	125	12500	2250	750	67500	89250	39000	50250

From the above computation it is evident that 2800 hour capacity level of activity is to be pursued to maximize profit.

Illustration 6. (Pricing Strategy)

Bathing care Ltd. manufactures and sells soaps under the brand name - Elite, Lovely, Fresh and Janata. The Janata soap is very popular as it is of good quality and at the same time reasonably priced. The company produces and sells per annum on an average 50,000 cakes of Elite, 1,00,000 cakes of Lovely, 75,000 cakes of fresh and 2,00,000 cakes of Janata at a unit selling price of ₹3.50, ₹3.00, ₹2.50 and ₹1.5 respectively.

At this level of production and sales the unit cost of a cake of each brand of soap is as follows:

(Expressed in Paise)

	Elite	Lovely	Fresh	Janata
Direct Material	50	40	35	45
Direct Labour	20	20	15	10
Production Expenses:				
Variable	10	10	5	5
Fixed	20	25	20	20
Administrative Expenses:				
Fixed	30	40	25	30
Variable	15	5	10	5
Selling & Distribution Expenses:				
Fixed	80	60	45	10
Variable	45	20	25	5
Total Cost	270	220	180	130



The co. has lot of unutilised capacity and there is ample scope for improving production and sales volumes.

Bathing Care Ltd. has built a name for its products in the market and with proper sales effort it should be possible to sell whatever is produced by the co., the production manager sees no problems. The sales manager puts up a bold scheme for almost quadrupling the present profits of the company.

1. An exclusive advertising campaign has to be undertaken to produce and sell Janata Soaps and it is estimated at ₹4,85,000.
2. At the same time the selling price of Janata Soap should be reduced to ₹ 1. By adopting this sales strategy the sales manager is confident that he is able to double the present sales volume of Janata Soap and with each 1 lack increase of Janata Soap he would be able to push 30,000 cakes of Elite, 70,000 of lovely, 50,000 of fresh in the market. You are required to find out the profit at present and profit if the sales managers scheme is implemented.

Solution:

Statement showing computation of profit at the current Mix:

	Elite (₹)	Levels (₹)	Fresh (₹)	Janata (₹)	Total (₹)
I) SP					
II) VC:	3.50	3.00	2.50	1.50	
DM	0.50	0.40	0.35	0.45	
DL	0.20	0.20	0.15	0.10	
Prod. Exp.	0.10	0.10	0.50	0.50	
AOH	0.15	0.05	0.10	0.05	
SOH	0.45	0.20	0.25	0.05	
	1.40	0.95	0.90	0.70	
III) Contrib.	2.10	2.05	1.60	0.80	5,90,000
IV) Total Cont.	1,05,000	2,05,000	1,20,000	1,60,000	
V) F.C:					
Prod. Exp.	0.20	0.25	0.20	0.20	
Adv. Exp.	0.30	0.40	0.25	0.30	
S & D Exp.	0.80	0.60	0.45	0.10	
	1.30	1.25	0.90	0.60	
VI) Total F.C	65,000	1,25,000	67,500	1,20,000	3,77,500
VII) Profit	40,000	80,000	52,000	40,000	2,12,500

Statement showing computation of profit by adopting Sales Manager's scheme:

	Elite	Levels	Fresh	Janata	Total
No. of Units	1,10,000	2,40,000	1,75,000	4,00,000	
Contribution per unit (₹)	2.10	2.05	1.60	(0.8 - 0.5) 0.30	
Total Contribution (₹)	2,31,000	4,92,000	2,80,000	1,20,000	11,23,000
F C (₹)					8,62,500
Profit (₹)					2,60,500

Illustration 7. (Break Even)

Evenkeel Ltd. manufactures and sells a single product X whose price is ₹40 per unit and the variable cost is ₹16 per unit.

- (a) If the fixed costs for this year are ₹4,80,000 and the annual sales are at 60% margin of safety, calculate the rate of net return on sales, assuming an income tax level of 40%.
- (b) For the next year, it is proposed to add another product line Y whose selling price would be ₹50 per unit and



the variable cost ₹10 per unit. The total fixed costs are estimated at ₹6,66,600. The sales mix of X:Y would be 7:3. At what level of sales next year, would Evenkeel Ltd. break even ? Give separately for both X and Y the break even sales in rupees and quantities.

Solution:

(a) Statement showing computation of profit on X:

	Amount (₹)
SP	= 40
VC	= <u>16</u>
C	= <u>24</u>

$$P/V \text{ Ratio} = \frac{C}{S} \times 100 = \frac{24}{40} \times 100 = 60\%$$

$$BES = \frac{FC}{PV \text{ Ratio}} = \frac{4,80,000}{60\%} = ₹8,00,000$$

Given that margin of safety = 60%,

Let x be the total sales

$$0.6x = x - 8,00,000$$

$$\Rightarrow x = 20,00,000$$

$$\Rightarrow \text{No. of units} = \frac{x}{40} = \frac{20,00,000}{40} = 50,000 \text{ units}$$

	Amount (₹)
(I) Sales (50,000 x 40)	= 20,00,000
(II) Variable Cost	= 8,00,000
(III) Contribution	= 12,00,000
(IV) Fixed Cost	= 4,80,000
(V) Profit	= 7,20,000
(VI) Tax (7,20,000 x 40%)	= 2,88,000
(VII) Net Profit	= 4,32,000
(VIII) ROR on sales	= $\frac{4,32,000}{20,00,000} \times 100 = 21.60\%$

(b) Let the break - even units of products X & Y be 7a & 3a respectively.

In order to break even the contribution must be equal to FC

$$\rightarrow (7a \times 24) + (3a \times 40) = ₹ 6,66,600$$

$$\rightarrow a = 2314.58$$

BES of X = 7a = 16,202 units and sales = ₹ 6,48,080

Y = 3a = 6944 units and sales = ₹ 3,47,200.

**Illustration 8. (Evaluation of Strategy)**

- (a) The profit for the year of Push On Ltd. work out to 12.5% of the capital employed and the relevant figures are as under:

	Amount (₹)
Sales	5,00,000
Direct Material	2,50,000
Direct labour	1,00,000
Variable overheads	40,000
Capital employed	4,00,000

The new sales manager who has joined the company recently estimates for the next year a profit of about 23% on the capital employed provided the volume of sales is increased by 10% and simultaneously there is an increase in Selling Price of 4% and an overall cost reduction in all the elements of cost by 2%.

Find out by computing in detail the cost and profit for next year, whether the proposal of sales manager can be adopted.

- (b) Details about the single product marketed by a company are as under

Per Unit	Amount (₹)
Selling Price	100
Direct Material	60
Direct Labour	10
Variable Overheads	10

No. of units sold in the year 5,035. Pursuant to an agreement reached with the Employee's union, there would be next year a 10% increase in wages across the board for all those directly engaged in production.

Work out:

- (i) How many more units have to be sold next year to maintain the same quantum of profit?
(ii) Or else, by what percentage the Selling Price has to be raised to maintain the same P/V ratio.

Solution:

- (a) Computation of Fixed Cost:

	Amount (₹)
Sales	5,00,000
(-) Profit	4,00,000 x 12.5% <u>50,000</u>
Total Cost	4,50,000
(-) VC: DM	2,50,000
DL	1,00,000
VOH	<u>40,000</u> <u>3,90,000</u>
Fixed Cost	<u>60,000</u>



Statement showing computation of profit obtained on adopting the sales manager's proposal:

		Amount (₹)
(I) Sales	$5,00,000 \times \frac{110}{100} \times \frac{104}{100}$	5,72,000
(II) Variable Cost	$3,90,000 \times \frac{110}{100} \times \frac{98}{100}$	4,20,420
(III) Contribution		1,51,580
(IV) Fixed Cost	$60,000 \times 98\%$	58,800
(V) Profit		92,780

$$\% \text{ of profit on capital employed} = \frac{92,780}{4,00,000} \times 100 = 23.195 > 23\%$$

∴ Proposal is adoptable.

(b) Current year details:

		Amount (₹)
Sales	5035×100	5,03,500
Variable Cost	80×5035	4,02,800
Contribution		1,00,700
P/V Ratio	$\frac{C}{S} \times 100 = \frac{20}{100} \times 100 =$	20%

Details of next year:

		Amount (₹)
SP		100
VC: DM	60	
DL – 10 x 110%	11	
VOH	10	81
C		19

(i) No. of units to maintain same profit = $\frac{\text{Desired Contribution}}{\text{c per unit}} = \frac{1,00,700}{19} = 5,300$

(ii) Let S be the new SP

$$\text{P/V Ratio} = \frac{S - V}{S} \times 100$$

$$\text{or, } 0.2 = \frac{S - 81}{S}$$

$$\text{or, } S = ₹ 101.25$$

∴ SP has to be increased by 1.25%.

Illustration 9. (Optimum Product Mix)

S. U Ltd. produces three products namely A, B and C. The budgeted production, costs and selling prices for the next year are as under:

Product	A	B	C
Direct materials (₹/unit)	24	16	12
Direct wages:			
Dept. Rate/Hour:			



1. ₹ 4 Hrs/ unit	3	5	2.5
2. ₹ 2 Hrs/unit	3	8	6
Budgeted Production (units)	10,000	12,000	20,000
Max. possible sales (units)	12,000	16,000	24,000
Selling price (₹/unit)	75	105	60

Variable overheads:

Dept.1 Recovered at 100% of direct wages.

Dept.2 Recovered at 50% of direct wages.

Fixed overheads ₹5,00,000 per annum.

A direct labour hour in Dept1 is in short supply and the budgeted volume of output envisages full utilisation of the available direct labour hours. In Dept 2, the co. has committed to engage the workers to the extent of the direct labour hours required for the budgeted volume of production. Should a change in the product mix be desired, the co. can engage additional direct labour hours required in dept 2 at normal rates; but any portion of the direct labour hours of dept 2 rendered surplus by reasons of a change in the present product mix have to be paid by the co. as idle wages in view of the commitment already made.

Required:

- Present a statement showing the budgeted profitability.
- Set optimal product mix and work out the optimum profit after taking into consideration the idle time wages, if any, payable in dept 2.

If the co. desires to subcontract the surplus direct labour hours, if any, in dept 2, what minimum charges should be quoted per direct labour hour.

Solution:

(i) Statement showing computation of budgeted profit and contribution per labour hour in dept. 1:

	A	B	C	Total
	₹	₹	₹	₹
SP	75	105	60	
VC:				
DM	24	16	12	
DW: Dept 1	12	20	10	
Dept 2	6	16	12	
VOH	15	28	16	
	57	80	50	
Contribution	18	25	10	
Contr. Per lab hour	6	5	4	
In Dept. I				
	I	II	III	
Budgeted units	10,000	12,000	20,000	
Total contrib.	1,80,000	3,00,000	2,00,000	6,80,000
Fixed Cost				5,00,000
Profit				1,80,000

**(ii) Statement showing optimum mix and profit at that mix:**

Amount (₹)

No. of Units	A	B	C	Total
No. of Units	12,000	16,000	9,600	
C P.U	18	25	10	
Total Contribution	2,16,000	4,00,000	96,000	7,12,000
FC				5,00,000
Profit				2,12,000
(-) Cost of idle wages in dept 2			24,400 x 2	48,800
Profit after idle wages				1,63,200

Working Notes:

No. of hours in dept 1 = (10,000 x 3) + (12,000 x 5) + (20,000 x 2.5) = 1,40,000

No. of hours in dept 2 = (10,000 x 3) + (12,000 x 8) + (20,000 x 6) = 2,46,000

	Dept I hrs	Dept II hrs
Available Hours	1,40,000	2,46,000
(-) utilized for A	36,000	36,000
	1,04,000	2,10,000
(-) for B	80,000	1,28,000
	24,000	82,000
No. of Units of C = $\frac{24,000}{2.5} = 9600$	24,000	9600 x 6 = 57,600
Idle Hours	-	24,400

(iii) Hire charges = Labour Cost + Var. O.H = 2 + 2 x 50% = ₹ 3 per hour

Illustration 10. (Optimum Product Mix)

V Ltd. produces two products P and Q. The draft budget for the next month is as under:

Budgeted production and sale (units)	40,000	80,000
Selling price ₹/unit	25	50
Total costs ₹/unit	20	40
Machine hours/unit	2	1
Max. sale potential (units)	60,000	1,00,000

The fixed expenses are estimated at ₹9,60,000 per month. The co. absorbs fixed Ohs on the basis of machine hours which are fully utilised by the budgeted production and cannot be further increased.

When the budget was discussed, the managing director states that the product mix should be altered to yield optimum profit. The marketing director suggests that he could introduce a new product C each unit of which take 1.5 machine hours. However a processing vat involving a capital outlay of ₹2,00,000 is to be installed for processing product C. The additional fixed overheads relating to the processing vat was estimated at ₹60,000 per month. The variable costs of product C was estimated at ₹21 per unit.

Required:

- Calculate the profit as per draft budget for the next month.
- Revise the product mix based on data given P and Q to yield optimum profit.
- The company decides to discontinue either product P or Q whichever is giving lower profit and proposes to substitute product C instead. Fix the selling price of C in such a way to yield 15% return on additional capital employed besides maintaining the same overall profit as envisaged in (ii) above.

**Solution:****Computation of profit as per draft budget:** Amount (₹)

	P	Q	Total
SP	25	50	
Total Cost	20	40	
Profit	5	10	
Budgeted Units	40,000	80,000	
Profit	2,00,000	8,00,000	10,00,000
Total Cost	8,00,000	32,00,000	40,00,000
(-) FC			9,60,000
VC			30,40,000
FC P u	12	6	
VC P u	8	34	
C P u	17	16	
C Per machine hour	8.5	16	
	II	I	

Statement showing optimum mix and relevant profit: Amount (₹)

	P	Q	Total
No. of units	30,000	1,00,000	
C P. u.	17	16	
Total C	5,10,000	16,00,000	21,10,000
FC			9,60,000
Profit			11,50,000

Working Notes:

Available hours = (40,000 × 2) + (80,000 × 1) = ₹ 1,60,000

(-) Utilised for Q = ₹ 1,00,000

₹ **60,000**

No. of units of P = $\frac{60,000}{2} = 30,000$ units

Computation of SP of product C:

Out of products P & Q, P is less profitable and hence can be replaced by c.

Variable Cost ₹ 21

FC ₹ 60,000

Machine hours released = 60,000 hrs.

No. of units of C = $\frac{60,000}{1.5} = 40,000$ units



In order to get the profit as above, the contribution to be recovered is as follows:

	Amount (₹)
Total Contribution	21,10,000
(+) Fixed Cost (addnl.)	60,000
(+) Return on capital employed	30,000
	22,00,000
(-) Recovered from Q	16,00,000
	6,00,000

$$C \text{ per unit} = \frac{60,000}{40,000} = ₹15$$

$$(+) \text{ VC} \quad \quad \quad \underline{21} \text{ ₹}$$

$$\text{Selling Price} \quad \quad \quad \underline{36} \text{ ₹}$$

Illustration 11. (Make/Buy)

Household Equipments Ltd. is producing kitchen equipment from five components three of which are made using general purpose machines and two by manual labour. The data for the manufacture of the equipment is as follows:

Components	A	B	C	D	E	Total
Machines hours reqd. per unit	10	14	12			36 hrs
Labour hours reqd. per unit				2	1	3hrs
Variable cost per unit (in ₹)	32	54	58	12	4	160
Fixed cost per unit (apportioned) ₹	48	102	116	24	36	316
Total component cost ₹	80	156	174	36	30	476
Assembly cost/unit (all variable)						₹40
Selling price/unit						₹600

The marketing department of the company anticipates 50% increase in demand during the next period. General purpose machinery used to manufacture. A, B and C is already working to the maximum capacity of 4752 hours and there is no possibility of increasing this capacity during the next period. But labour is available for making components D and E and also for assembly according to demand. The management is considering the purchase of one of the components A, B or C from the market to meet the increase in demand. These components are available in the market at the following prices:

Components A: ₹ 80

Components B: ₹ 160

Components C: ₹ 125

Required:

- Profit made by the company from current operations.
- If the company buys any one of the components A,B or C, what is the extent of additional capacity that can be created?
- Assuming 50% increase in demand during the next period, which component should the company buy from the market?
- The increase in profit, if any, if the component suggested in (c) is purchased from the market.

**Solution:**

(a) Statement showing profit at current operations:

		Amount (₹)
SP		600
Variable Cost	(160 + 40)	200
Contribution		400
No. of units	4752/36	Units 132
Total Contribution		52,800
Fixed Cost		41,712
Profit		11,088

Amount (₹)

	A	B	C
Buying cost	80	160	125
Variable Cost	32	54	58
Extra buying Cost	48	106	67
Excess buying cost per hour	4.8	7.571	5.583

It is better to buy component A from the market because excess buying cost per machine hour is less. Computation of additional capacity created if components are bought from outside:

If A is bought:

No. of units that can be manufactured	(4752/26)	182.76 units
Increase in capacity	(182.76 – 132/132 × 100)	38.46 %
If B is bought:		
No. of units	(4752/22)	216
Increase in capacity	(182.76 – 132/132 × 100)	63.64%
If C is bought:		
No. of units	(4752/24)	198
Increase in capacity	(198 – 132/132 × 100)	50%

(c) A is cheaper to buy. But the increase in capacity will not be sufficient to meet the expected demand for next year. Therefore, we shall try to buy the next cheaper component. i.e., C and by buying it the increase in capacity will be exactly equal to the demand for our product during the next year. Hence, component 'C' should be bought from the market.

(d) **Statement showing computation of profit by buying C from outside:**

I) No. of Units	(4752/24)	Units 198
II) Selling Price		₹ 600
III) Variable Cost	(200 – 58 + 125)	₹ 267
IV) Contribution		₹ 333
V) Total Contribution		₹ 65,934
VI) Fixed Cost		₹ 41,712
VII) Profit		₹ 24,222
Less: Existing Profit		₹ 11,088
Increase in profit		₹ 13,134

**Illustration 12. (Optimum Product Mix)**

As a part of its rural upliftment programme, the Government has put under cultivation a farm of 96 hectares to grow tomatoes of four varieties: Royal Red, Golden Yellow, Juicy Crimson and Sunny Scarlet. Of the total, 68 hectares are suitable for all four varieties, but the remaining 28 hectares are suitable for growing only Golden Yellow and Juicy Crimson. Labour is available for all kinds of farm work and there is no constraint. The market requirement is that all four varieties of tomato must be produced with a minimum of 1,000 boxes of any one variety.

The farmers engaged have decided that the area devoted to any crop should be in terms of complete hectares and not in fractions of a hectare. The other limitation is that not more than 22,750 boxes of any one variety should be produced. The following data are relevant.

	Royal Red	Golden Yellow	Juicy Crimson	Sunny Scarlet
Annual Yield				
Boxes per hectare	350	100	70	180
Costs	₹	₹	₹	₹
Direct:				
Material per hectare	476	216	196	312
Labour:				
Growing per hectare	896	608	371	528
Harvesting and				
packing per box	3.60	3.28	4.40	5.20
Transport per box	5.20	5.20	4.00	9.60
Market price per box	15.38	15.87	18.38	22.27
Fixed overheads per annum				
Growing	₹ 11,200			
Harvesting	₹ 7,400			
Transport	₹ 7,200			
General Administration	₹ 10,200			

Find out: (i) within the given constraints, the area to be cultivated with each variety of tomatoes, if the largest total profit has to be achieved.

(ii) The amount of such profit in rupees.

A nationalized bank has come forward to help in the improvement programme of the 28 hectares in which only Golden Yellow and Juicy Crimson will grow, with a loan of ₹ 5,000 at a very nominal interest of 6% per annum. When this improvement is carried out, there will be a saving of ₹ 1.25 per box in the harvesting cost of Golden Yellow and the 28 hectares will become suitable for growing Royal Red in addition to the existing Golden Yellow and Juicy Crimson varieties. Assuming that other constraints continue, find the maximum total profit that would be achieved when the improvement programme is carried out.



Solution:

Statement showing contribution per hectare and determination of priority for profitability

Amount (₹)

	Royal Red	Golden Yellow	Juicy Crimson	Sunny Scarlet
i) Sales realised per hectare	5383	1587	1288.6	4008.6
ii) Variable cost:				
a. direct material	476	216	196	312
b. growing cost per hectare	896	608	371	528
c. harvesting and packing	1260	328	308	936
d. transport	1820	520	280	1728
	4452	1672	1155	3504
iii) Contribution per hectare	931	-85	133.60	504.6
iv) Priority	1	4	3	2

Statement showing optimum product mix under the given conditions and computation of profit at that mix

	Royal Red	Golden Yellow	Juicy Crimson	Sunny Scarlet	Total
Minimum boxes to be produced (Units)	1,000.00	1,000.00	1,000.00	1,000.00	
Area required for this minimum (hectares)	3.00	10.00	14.00	6.00	33.00
Remaining land Apportioned on the basis of given data according to priority (hectares)	59.00		4.00		63.00
i) No. of hectares	62.00	10.00	18.00	6.00	96.00
ii) Contribution per hectare (₹)	931.00	(85.00)	133.60	504.60	
iii) Total contribution (₹)	57,722.00	(850.00)	2,404.80	3,027.60	62,304.40
iv) Fixed cost (₹)					36,000.00
v) Profit (₹)					26,304.40

Statement showing optimum mix after the improvement programme and computation of profit

	Royal Red	Golden Yellow	Juicy Crimson	Sunny Scarlet	Total
Area required for the minimum (hectares)	3.00	10.00	14.00	6.00	33.00
Remaining land Apportioned on the basis of given data according to priority (hectares)	62.00			1.00	63.00
i) No. of hectares	65.00	10.00	14.00	7.00	96.00
ii) Contribution per hectare (₹)	931.00	40.00	133.60	504.60	
iii) Total contribution (₹)	60,515.00	400.00	2,404.80	3,532.20	66,852.00
iv) Fixed cost (₹)					36,300.00
v) Profit (₹)					30,552.00

Illustration 13. (Evaluation on Strategy)

Nice and Warm, Ltd. manufactures and markets hot plates. During the first five years of operations, the company has experienced a gradual increase in sales volume, and the current annual growth in sales of 5% is expected to continue in the foreseeable future. The plant is now producing at its full capacity of one lakh hot plates.



At the monthly Management Advisory committee meeting, amongst other things, the plan of action for next year was discussed.

Managing Director proposed two alternatives. First, operations could be continued at full capacity and with the existing facilities, an output of one lakh hot plates at a selling price of ₹ 100 per plate per unit could be maintained. Secondly, production and sales could be increased by 5% to take advantage of the rate of expansion in demand for the product. But this could increase cost, as to achieve the output, the company will have to resort to weekend and overtime workings. However, a policy of steady growth was preferable to maintaining status quo.

In view of the company's competitors having a substantial share of the market, the Works Director was of the view that it was not enough for the company to maintain merely the present share of the total market. A large share of the total market should be obtained. For that, the company should increase production by 10% through a modest expansion of the plant capacity. In order to sell the output of 1,10,000 units the selling price could be reduced to ₹ 95 per unit.

Thinking on the same lines, the Marketing Director put forth a more radical proposal. The strategy should be to seize the competitive leadership in the market with regard to both price and volume. With this end in view, he suggested that the company should straightaway embark on an expensive modernisation programme, which will initially increase volume by 20%. The entire output of 1,20,000 hot plates could be easily sold at a price of ₹ 90 per unit.

At this juncture, the Managing Director expressed concern about the probable behavior of the company's competitors. They might also expand in order to produce more and sell at lower prices. Suppose this happened, he wanted also the financial effects of the proposals of the Works Director and Marketing Director, if in these proposals, the expected increase in sales were to be only half of that predicted.

As a Cost Accountant of the company, you are required to critically evaluate the six alternatives along with your recommendations and circulate the same to the Directors. In this connection, you have gathered the following details:

- (i) If next year's production was maintained at the current year's level, variable cost would remain at ₹ 50 per unit. Fixed cost would remain unchanged at ₹ 30 lakhs.
- (ii) The week-end and overtime working would increase with the variable and fixed costs. Variable cost would rise to ₹ 55 per unit while fixed cost would increase to ₹ 30,25,000
- (iii) In the proposal of the Works Director, the ratio of variable costs to sales would continue to be 50%. Fixed costs would rise to ₹ 32,25,000.
- (iv) In the proposal of Marketing Director, as a result of increased production, efficiency and some savings from purchase of materials, it is estimated that the ratio of variable cost of sales would decrease to 48% and the fixed costs would increase by ₹ 5,16,000.

Your answer should contain:

- (a) A tabular statement of comparative figures pertaining to total turnover, total contribution, Percentage of Profit to Sales and Breakeven units as regard to each of the six proposals.
- (b) Comments on the relative risk involved.
- (c) Consideration of the short-term and long-term implications of the Managing Director's proposals.
- (d) Comment on the price elasticity of demand for the company's products and your suggestions on the pricing policy and cost structure
- (e) Comment on financial implications of the expansion scheme.

Solution:

(a) Statement showing contribution, profit at six alternatives

	Managing director		Works director		Marketing director	
	I	II	I	II	I	II
i) No. of units	100,000.00	105,000.00	110,000.00	105,000.00	120,000.00	110,000.00
ii) Selling price per unit (₹)	100.00	100.00	95.00	95.00	90.00	90.00
iii) Sales turnover (₹ Lakhs)	100.00	105.00	104.50	99.75	108.00	99.00
iv) Variable cost per unit (₹)	50.00	55.00	47.50	47.50	43.20	43.20
v) Contribution per unit (ii-iv) (₹)	50.00	45.00	47.50	47.50	46.80	46.80
vi) Total contribution (₹ Lakhs)	50.00	47.25	52.25	49.88	56.16	51.48
vii) Fixed cost (₹ Lakhs)	30.00	30.25	32.25	32.25	35.16	35.16
viii) Profit (₹ Lakhs) (vi-vii)	20.00	17.00	20.00	17.63	21.00	16.32
ix) % of profit on sales (%)	20.00	16.19	19.14	17.67	19.44	16.48
x) Break even units (vii/v)(units)	60,000.00	67,222.00	67,895.00	67,895.00	75,128.00	75,128.00
xi) Margin of safety units	40,000.00	37,778.00	42,105.00	37,105.00	44,872.00	34,872.00
xii) P.V ratio	0.50	0.45	0.50	0.50	0.52	0.52

(b) Managing Director's first proposal seems to be more favorable from the risk point of view because it has low break even and high margin of safety coupled with higher percentage of profit to sales.

(c) From the short run point of view, Managing director's second proposal, i.e steady growth of 5% a year would be better, even by resorting to weekend over time working. However, from the long term view point, the above proposal is not advisable because when they have steady growth, they can go for expansion of business rather than resorting to overtime working. If it is not possible to go for expansion, a steady status quo is the best solution.

(d) It was given that , annual growth of sales of 5% is expected to continue in foreseeable future. It is not clear, why the second proposal of the works director and marketing director should suggest, reduction in price for 5% and 10% respectively.

It seems no serious study has been made on the price elasticity of demand of the product. If there is demand for the product and increased production, they may reduce the price by adapting discriminate price policy

(e) If the company desires to expand the production, it is necessary to find out the sources of financing of expansion scheme by relative profitability of different funds.

Illustration 14. (Optimum Mix)

Domestic political trouble in the country of an overseas supplier is causing concern in your company because it is not known when further supplies of raw material 'x' will be received. The current stock held of this particular raw material is 17,000 kilograms, which costs ₹ 1,36,000. Based on raw material 'x', your company makes five different products and the expected demand for each of these, for the next three months, is given below together with other relevant information:

Product code	Kilogram of raw material 'x' per unit of finished product	Direct labour hours per unit of finished product	Selling price per unit	Expected demand over three months
	Kg.	Hours	₹	units
701	0.7	1.0	26	8,000
702	0.5	0.8	28	7,200
821	1.4	1.5	34	9,000
822	1.3	1.1	38	12,000
937	1.5	1.4	40	10,000



The direct wages rate per hour is ₹5 and production overhead is based on direct wages cost - The variable overhead absorption rate being 40% and the fixed overhead absorption rate being 60% Variable selling costs, including sales commission, are 15% of selling price.

Budgeted fixed selling and administration costs are ₹ 300,000 per annum. Assume that the fixed production overhead incurred will equal the absorbed figure.

You are required to:

- Show what quantity of the raw material on hand ought to be allocated to which products in order to maximize profits for the forthcoming three months.
- Present a brief statement showing contribution and profit for the forthcoming three months, if your suggestion in (a) is adopted;
- Comment briefly on the analysis you used to aid the decision making process in (a) and give three other examples of business problems where this type of analysis can be useful.

Solution:

Statement showing computation of contribution per kilogram of material and determination of priority for profitability

Amount (₹)

	701	702	821	822	937
i) Selling price	26.00	28.00	34.00	38.00	40.00
ii) Variable cost					
a. Direct material	5.60	4.00	11.20	10.40	12.00
b. labour	5.00	4.00	7.50	5.50	7.00
c. Production overheads	2.00	1.60	3.00	2.20	2.80
d. selling expenses	3.90	4.20	5.10	5.70	6.00
	16.50	13.80	26.80	23.80	27.80
iii) Contribution	9.50	14.20	7.20	14.20	12.20
iv) Contribution per kilogram of material	13.57	28.40	5.14	10.90	8.13
v) Priority	2	1	5	3	4

Statement showing optimum mix under given conditions and computation of profit at that mix

	701	702	821	822	937	Total
No. of units	8,000.00	7,200.00		6,000.00		
Contribution per Unit (₹)	9.50	14.20		14.20		
Total contribution (₹)	76,000.00	1,02,240.00		85,200.00		2,63,440.00
Fixed cost (₹)						1,36,080.00
Profit (₹)						1,27,360.00

Working Notes:

Computation of material apportion on the basis of priority

	Kgs (₹)
Available material	17,000.00
Less : used for 702 (7200 x 0.5)	3,600.00
	13,400.00
701 (8000 x 0.7)	5,600.00
	7,800.00

Therefore no. of units of 822 to be produced from remaining material (7800/1.3) = 6000 Units

**Fixed Cost**

	Amount (₹)
Selling and adm. Overheads [(300000/12) x 3]	75,000.00
Factory overheads [(8000 x 5 x 60%) + (7200 x 4 x 60%) + (6000 x 5.5 x 60%)]	61,080.00
	1,36,080.00

Illustration 15. (Optimum Mix)

Z Ltd., makes a range of five products to which the following standards apply:

	₹ / Unit				
	A	B	C	D	E
Sales price	50	60	70	80	90
Direct materials	9	10	17	12	21
Direct Wages	16	20	24	28	32
Variable production overheads	8	10	12	14	16
Variable selling and distribution overheads	5	6	7	8	9
Fixed overheads	4	5	6	7	8
	42	51	66	69	86

The direct labour wage rate is ₹4 per hour. Fixed overheads have been allocated on the basis of direct labour hours. The company has commitments to produce a minimum of 400 units of each product per month. Direct hours cannot exceed 13,000 per month due to restriction of space. The Board is now considering an offer of a new three-year contract to produce an additional 400 units of product B per month at a selling price of ₹58 per unit. The contract would involve an outlay of ₹1,00,000 on the lease of additional factory premises and purchase of new plant and equipment. There would be residual value at the end of the contract. Variable production costs would be in accordance with existing standards, variable selling and distribution costs would be one-half of the existing rate and cash outflows on fixed costs would be ₹20,000 per annum. There would be no change to existing production arrangements. An outside supplier has offered to supply 400 units of product B per month at a price of ₹48 per unit. If purchased externally cash flows on additional fixed costs will be ₹ 25,000 per annum.

Required:

- Give recommendations, supported by calculations, to show how direct labour hours in the existing factory should be utilised in order to maximize profits.
- Show the budgeted trading results on the basis of your recommendations in (a)
- Give calculations to show whether or not the proposed contract for product B should be accepted and, if so, whether it should be purchased externally or manufactured in the new premises. The company's cost of capital is 10% (the present value of an annuity of ₹1 for three years at 10% is ₹2.49). Ignore taxation and inflation.

Solution:**A. Statement showing contribution per labour hour and determination of priority for profitability**

	Amount (₹)				
	A	B	C	D	E
i) Selling price	50.00	60.00	70.00	80.00	90.00
ii) Variable cost					
a. Direct material	9.00	10.00	17.00	12.00	21.00
b. Labour	16.00	20.00	24.00	28.00	32.00
c. Variable overheads	8.00	10.00	12.00	14.00	16.00
d. Variable selling & dis. Overheads	5.00	6.00	7.00	8.00	9.00
	38.00	46.00	60.00	62.00	78.00
iii) Contribution	12.00	14.00	10.00	18.00	12.00



iv) Contribution per labour hour	3.00	2.80	1.66	2.57	1.50
v) Priority	I	II	IV	III	V

B. Statement showing optimum mix under given conditions and computation of profit at that mix.

	A	B	C	D	E	Total
Minimum no. of units	4,800.00	4,800.00	4,800.00	4,800.00	4,800.00	
Units in remain hours (w/n)	3,000.00					
No. of units	7,800.00	4,800.00	4,800.00	4,800.00	4,800.00	
Contribution per Unit (₹)	12.00	14.00	10.00	18.00	12.00	
Total contribution (₹)	93,600.00	67,200.00	48,000.00	86,400.00	57,600.00	352,800.00
Fixed cost (156000 hoursx1) (₹)						156,000.00
Profit (₹)						196,800.00

Working notes:

Available hours	156,000.00 hrs.
Hours utilised for minimum $\{(4+5+6+7+8) \times 4800\}$	144,000.00 hrs.
Remaining hours	12,000.00 hrs.
Therefore units of a to be produced $(12000/4)$	3000 units

C.

Option I	Amount (₹)
Selling price offered	58.00
Less: Variable cost $(46 - (6/2))$	43.00
Contribution	15.00
No. of units	4,800.00
Total contribution	72,000.00
Less: Fixed cost	20,000.00
Profit	52,000.00

Present value of profit for three years contract

	Amount (₹)
i.e Inflow (52000×2.49)	129,480.00
Less : outflow	100,000.00
Net present value	29,480.00

Option II	Amount (₹)
Contract value (4800×48)	230,400.00
Add : Fixed cost	25,000.00
	255,400.00
Present value for three years (255400×2.49)	(₹) 635,946.00
Present value of inflows $(4800 \times 58 \times 2.49)$	(₹) 693,216.00
Net present value	(₹) 57,270.00

It is better to accept the order for product-b and to supply them by sub-contracting the order.

**Illustration 16. Evaluation of Strategy — Fixation of Price**

The Management Accountant of X Ltd., has prepared the following estimates of working results for the year ending 31st December, 2016 for the purpose of preparing the budgets for the year ending 31st December, 2017.

Year ending 31/12/2016		
Direct material	₹/unit	16.00
Direct wages	"	40.00
Variable overheads	"	12.00
Selling price	"	125.00
Fixed expenses	₹	6,75,000 p.a.
Sales	₹	25,00,000p.a.

During the year 2017, it is expected that the material prices and variable overheads will go up by 10% and 5% respectively. As a result of re-organisation of production methods the overall direct labour efficiency will increase by 12% but the wage rate will go up by 5%. The fixed overheads are also expected to increase by ₹1,25,000. The technical director states that the same level of output as obtained in 2016 should be maintained in 2017 also and efforts should be made to maintain the same level of profit by suitably increasing the selling price. The marketing director states that the market will not absorb any increase in the selling price. On the other hand he proposes that publicity involving advertisement expenses in the proportions will increase the quantity of sales as under:

Advertisement expenses (₹)	80,000	1,94,000	3,20,000	4,60,000
Additional units of sales	2,000	4,000	6,000	8,000

Required:

- (i) Present an income statement for the year 2017.
- (ii) Find the revised price and the percentage of increase in the price for 2017 if the Technical Directors' views are accepted.
- (iii) Evaluate the four alternative proposals put forth by the Marketing Director, determine the best output level to be budgeted and prepare an overall income statement for 2017 at that level of output.

Solution:**I. Statement of profit at budget**

	Amount (₹)
(i) Selling price	125.00
(ii) Variable cost	
a. direct material	16.00
b. direct wages	40.00
c. variable overheads	12.00
	68.00
(iii) Contribution (i-ii)	57.00
(iv) No. of units (25,00,000/125)	20,000.00
(v) Total contribution	1,140,000.00
(vi) Less: Fixed cost	675,000.00
(vii) Profit (v-vi)	465,000.00



II. Computation of selling price, if the technical director views are implemented

Variable cost		Amount (₹)
Direct material	(16x110%)	17.60
Direct wages	[(40x105%)x(100/112)]	37.50
Variable overheads	(12x105%)	12.60
		67.70

In order to get the same profit contribution to be recovered is as follows:

	Amount (₹)
Existing fixed overheads	675,000.00
Add :Expected increase	125,000.00
	800,000.00
Add : desired profit	465,000.00
	1,265,000.00

Therefore contribution per unit (1265000/20000)	₹ 63.25
Required selling price = variable cost + contribution = 67.7+63.25	₹ 130.95
% increase in sale price = [(130.95-125)/125]x100]	4.76%

III. Computation of additional profit at four alternatives proposed by marketing director

Additional Units	2000	4000	6000	8000
	Amount (₹)			
a. contribution per unit (125-67.7)	57.30	57.30	57.30	57.30
b. Total contribution	114,600.00	229,200.00	343,800.00	458,400.00
c. additional fixed cost	80,000.00	194,000.00	320,000.00	460,000.00
d. Profit/(loss)	34,600.00	35,200.00	23,800.00	(1,600.00)

Statement showing overall income for the year 1987

a. No. of units	24,000.00
	Amount (₹)
b. Contribution per unit	57.30
c. Total contribution	1,375,200.00
d. Fixed cost (800000+194000)	994,000.00
e. Profit	381,200.00

Illustration 17. (Optimum Mix)

Allplay Ltd., are specialists in the manufacture of dolls for children. They manufacture and market four types of dolls patented the names, Dolly, Molly, Jolly, Polly and a doll dress sewing kit. They require your assistance as a Cost Accountant for determining the appropriate sales and product-mix of their products for the coming year. From the production standards established market forecasts and pricing policies, you get the following data:

Doll's name	Estimated demand for next year	Standard material cost per unit	Standard labour cost per unit.	Estimated net price per unit.
	Unit	₹	₹	₹
Dolly	50,000	1.40	0.80	5.20
Molly	42,000	0.70	0.50	2.40



Jolly	35,000	2.70	1.40	8.50
Polly	40,000	1.00	1.00	4.00
Sewing kit	3,25,000	0.60	0.40	3.00

- (i) To promote sales of the sewing kit, there is a 15% discount offered in the established price of a kit, purchased at the same time along with a doll and it is expected that all the customers will avail this benefit.
- (ii) The labour rate of ₹2.00 per hour is expected to continue without change in the next year. The plant has an effective capacity of 1,30,000 labour hours on a single shift basis. Present equipment can produce all of the products. Overtime worked is paid at double the normal rate.
- (iii) Next year's fixed cost is estimated at ₹30,000 in the factory, ₹20,000 in administration and ₹ 50,250 in selling and distribution.
- (iv) Variable costs will be equivalent to 50% of standard Direct Labour cost.
- (v) The company has a very small inventory of its products that can be ignored.
 - (a) You are required to draw a conservative estimate for the next year of the total contribution that would be made by each product line and the net income that would be earned by the company.
 - (b) The company is at present having some industrial relations problem and if this continues in the next year, it would not then be possible to arrange for overtime work. Anticipating that eventuality, you are required to suggest a product-mix that would absolutely minimize the drop in the income already envisaged. With that product-mix, work out product-wise contribution and the new net income that would be earned as a result.

Solution:

(a) Conservative Estimate

Amount (₹)

	Dolly	Molly	Jolly	Polly	Sewing kit		Total
					Discount	No Discount	
Selling price	5.20	2.40	8.50	4.00	2.55	3.00	
Variable cost							
a. direct material	1.40	0.70	2.70	1.00	0.60	0.60	
b. direct wages	0.80	0.50	1.40	1.00	0.40	0.40	
c. variable overheads	0.40	0.25	0.70	0.50	0.20	0.20	
	2.60	1.45	4.80	2.50	1.20	1.20	
Contribution	2.60	0.95	3.70	1.50	1.35	1.80	
Hours per unit	0.40	0.25	0.70	0.50	0.20	0.20	
Contribution per hour	6.50	3.80	5.29	3.00	6.75	9.00	
No. of units	50,000.00	42,000.00	35,000.00	40,000.00	167,000.00	158,000.00	
Total contribution	130,000.00	39,900.00	129,500.00	60,000.00	225,450.00	284,400.00	869,250.00
Fixed cost							100,250.00
Profit before considering o.t							769,000.00
Less : o.t premium (w/n)							20,000.00
Profit at conservative estimate							749,000.00



Statement showing computation of contribution per hour, determination of priority and profit at conservative estimate.

Computation of over time premium

		Hours
Available hours		130,000.00
Less : Utilised for		
Dolly	(50000x.4)	20,000.00
Molly	(42000x0.25)	10,500.00
Jolly	(35000x.7)	24,500.00
Polly	(40000x.5)	20,000.00
Sewing kit (discount)	(167000x.2)	33,400.00
Sewing kit (no discount)	(158000x0.2)	31,600.00
O. T. Hours		10,000.00

Therefore overtime premium (10000 x 2) = ₹20000

Computation of profit when no over time is available

	Dolly	Molly	Jolly	Polly	Sewing kit		Total
					Discount	No Discount	
a. No. of units	50,000.00	42,000.00	35,000.00	20,000.00	147,000.00	178,000.00	
	₹	₹	₹	₹	₹	₹	₹
b. Contribution per unit	2.60	0.95	3.70	1.50	1.35	1.80	
c. Total contribution	130,000.00	39,900.00	129,500.00	30,000.00	198,450.00	320,400.00	848,250
d. Fixed cost							100,250
e. Profit							748,000

Illustration 18. (Optimum Mix)

The operating results of B.N. Ltd., for the year 1981 were as under:

The Company sells 4 products - 'A', 'B', 'C' & 'D' in 4:1:3:2 & P.V. Ratio 20%, 6%, 12% & 10% respectively.

Total sales value of all the products was ₹80 lacs. Total fixed overheads amounted to ₹ 10 lacs. Raw material contents of each product represented 50% of the respective variable cost. The forecast for the year 1982 is as under:

- The raw material costs will go up by 10%
- The company has been able to obtain export quota of raw material of the value of ₹ 35 lacs.
- The maximum sale potential of any of the above four products is 40% of the 1981 sale value.
- The Company expects to secure an increase of 5% in the selling prices of all the products uniformly.

Required:

- Prepare a statement showing the profitability of 1981.
- Set a Product mix to maximise profit in 1982.
- Prepare a statement showing the profitability of 1982.



Solution:

Statement showing profit for 1981, computation of contribution per rupee of material and determination of priority for profitability Amount (₹)

	A	B	C	D	Total
Sales	3,200,000.00	800,000.00	2,400,000.00	1,600,000.00	8,000,000.00
Contribution	640,000.00	48,000.00	288,000.00	160,000.00	1,136,000.00
Fixed cost					1,000,000.00
Profit					136,000.00

Amount (₹)

Variable cost	2,560,000.00	752,000.00	2,112,000.00	1,440,000.00
Raw material cost	1,280,000.00	376,000.00	1,056,000.00	720,000.00
Contribution per rupee of Raw Material Cost	0.50	0.13	0.27	0.22
Priority	I	IV	II	III

Statement showing optimum mix under given conditions and computation of profit at that mix

Amount (₹)

	A	C	D	Total
i) Sales	3,360,000.00	3,360,000.00	1,152,242.00	7,872,242.00
	(80x40%x105%)	(80x40%x10)	(w/n)	
ii) Variable cost				
a. Raw material	1,408,000.00	1,548,800.00	543,200.00	
	[32x(12.8/32)x110%]			
b. Other variable cost	1,280,000.00	1,408,000.00	493,818.00	
	2,688,000.00	2,956,800.00	1,037,018.00	6,681,818.00
iii) Contribution	672,000.00	403,200.00	115,224.00	1,190,424.00
iv) Fixed cost				1,000,000.00
v) Profit				190,424.00

Working notes:

	Amount (₹)
Available material	3,500,000.00
Less : utilised for	
A $\{(33.6) \times (12.8 \times 1.1) / (32 \times 1.05)\}$	1,408,000.00
C $\{(33.6) \times (10.56 \times 1.1) / (24 \times 1.05)\}$	1,548,800.00
	543,200.00

Sales of D to be produced Let X be sales

$$[(X \times 7.2 \times 1.1) / 16 \times 1.05] = 543200 \quad X = ₹ 1,152,242$$

Illustration 19. (Optimum Mix)

A small-scale manufacturing unit has employed skilled persons for doing pressing and welding operations on various products. The welders produce two different products, W1 and W2. The press operators also produce two products, p1 and p2. Due to specific skill requirements, the press operators can't do welding job and vice-versa. The labour hours and cost data in respect of the above 4 products are as under.



	W ₁	W ₂	P ₁	P ₂
Hours per unit	4	4	5	2
Price per unit (₹)	50	50	80	65
Direct Material per unit (₹)	18	22	35	45
Direct Labour Rate per hour (₹)	4	4	4	4
Variable Overheads per unit (₹)	2	2	3	3

The unit incurs ₹50,000 per annum on fixed costs for producing the above products. The available labour hours for welding are 20,000 and for pressing 16,000.

The unit has also observed that the market can absorb minimum 2,000 units of W₁, 2,500 units of W₂, 1,800 units of P₁ and 2,200 units of P₂. The demand keeps on fluctuating. The manager of the shop has, therefore suggested that the workers should be trained to do either of welding or pressing job so that any excess demand can be fulfilled. It is estimated that this decision will increase the burden of fixed costs by ₹5,000 p.a.

Required:

- Present the figures of optimum product mix assuming that the minimum marketable quantity is produced before the workers are trained and after they are trained.
- Prepare profitability statement for optimum product mix under both the above conditions and recommend whether it is advisable to train employees.

Solution:

Statement showing computation per hour and determination of priority

	W ₁	W ₂	P ₁	P ₂
	₹	₹	₹	₹
i) Selling price	50.00	50.00	80.00	65.00
ii) Variable cost				
a. direct material	18.00	22.00	35.00	45.00
b. direct wages	16.00	16.00	20.00	8.00
c. variable overheads	2.00	2.00	3.00	3.00
	36.00	40.00	58.00	56.00
iii) Contribution	14.00	10.00	22.00	9.00
iv) Contribution per hour	3.50	2.50	4.40	4.50
v) Priority	III	IV	II	I

Statement showing calculation of profit before workers are trained

	W ₁	W ₂	P ₁	P ₂	Total
Minimum units	2,000.00	2,500.00	1,800.00	2,200.00	
Units in remaining time	500.00			1,300.00	
i) Total units	2,500.00	2,500.00	1,800.00	3,500.00	
ii) Contribution per unit (₹)	14.00	10.00	22.00	9.00	
iii) Total contribution (₹)	35,000.00	25,000.00	39,600.00	31,500.00	131,100.00
iv) Fixed cost (₹)					50,000.00
v) Profit (₹)					81,100.00

**Working Notes:**

	W ₁ hours	P ₂ hours
Available hours	20,000.00	16,000.00
Less : used for minimum	18,000.00	13,400.00
	2,000.00	2,600.00
units	500.00	1,300.00

Statement showing calculation of profit after training

	W ₁	W ₂	P ₁	P ₂	
Minimum units	2,000.00	2,500.00	1,800.00	2,200.00	
Units in remaining time				2,300.00	
i) Total units	2,000.00	2,500.00	1,800.00	4,500.00	
ii) Contribution per unit (₹)	14.00	10.00	22.00	9.00	
iii) Total contribution (₹)	28,000.00	25,000.00	39,600.00	40,500.00	133,100.00
iv) Fixed cost (₹)					55,000.00
v) Profit (₹)					78,100.00

From the above, it is not advisable to train the workers.**Illustration 20. (Pricing)**

PH Ltd., has a productive capacity of 2,00,000 units of product BXE per annum. The company estimated its normal capacity utilisation at 90% for 1986-87. The variable costs are ₹22 per unit and the fixed factory overheads were budgeted at ₹7,20,000 per annum. The variable selling overheads amounted to ₹6 per unit and the fixed selling expenses were budgeted at ₹5,04,000. The operating data for 1986-87 are as under:

Production	1,60,000 units
Sales @ ₹40 per unit	1,50,000 units
Opening stock of finished goods	10,000 units

The cost analysis revealed an excess spending of variable factory overheads to the extent of ₹80,000. There are no variances in respect of other items of cost.

Required:

- (i) Determine the budgeted break-even point for 1986-87
- (ii) What increase in price would have been necessary to achieve the budgeted profit?
- (iii) Present statements of profitability for 1986-87 using:
 - (a) Marginal costing basis.
 - (b) Absorption costing basis.

Solution:

Fixed cost = Fixed overheads + selling expenses = 720000 + 504000 = 1224000

	Amount (₹)
I Selling price	40.00
II Variable cost	28.00
III Contribution	12.00



Break even at budget = $(1224000/12) = 102000$ units

(i) Contribution at budget = $[(200000 \times 90\%) \times 12] = 2160000$

	Amount (₹)
Contribution per unit $(2160000/150000)$	14.40
Add : Variable cost	28.00
	42.40
Standard variable production cost	22.00
Add: Standard fixed cost $(720000/200000 \times 90\%)$	4.00
	26.00

Profit under Absorption Costing

		Units	Amount (₹)	Amount (₹)
Standard Variable cost	(160000×22)			3,520,000.00
Add : Variance				80,000.00
				3,600,000.00
Add : Fixed production cost absorbed	(160000×4)		680,000.00	
Add : Under recovery	$(720000 - 680000)$		40,000.00	720,000.00
		160,000.00		4,320,000.00
Add : Opening stock		10,000.00		260,000.00
				4,580,000.00
Less : Closing stock		20,000.00	$(43.2 \times 0.2 / 1.6)$	540,000.00
				4,040,000.00
Add : selling & dis. Cost				
Variable	(150000×6)		900,000.00	
Fixed			504,000.00	1,404,000.00
Total cost				5,444,000.00
profit (b/f)				556,000.00
Sales	(150000×40)			6,000,000.00
Profit under marginal costing				
i) Sales				6,000,000.00
ii) Variable cost				
Production			3,600,000.00	
Add : opening	(10000×22)		220,000.00	
			3,820,000.00	
Less : closing	$20000 \times 36 / 16$		450,000.00	3,370,000.00
Selling & distribution				900,000.00
				4,270,000.00
iii) Contribution				1,730,000.00
iv) Fixed cost				1,224,000.00
v) Profit				506,000.00

**Illustration 21. (Indifference Point)**

Y Company has just been incorporated and planned to produce a product that will sell for ₹ 10 per unit. Preliminary market surveys show that demand will be around 10,000 units per year. The company has the choice of buying one of the two machines 'A' would have fixed costs of ₹30,000 per year and would yield a profit of ₹30,000 per year on the sale of 10,000 units. Variable costs behave linearly for both machines. Machine B would have F.c of ₹ 18,000 p.a. and would yield a profit of ₹22,000 p.a. on the sale of 10,000 units.

Required to:

- Break-even sales for each machine
- Sales level where both machines are equally profitable
- Range of sales where one machine is more profitable than the other.

Solution:

- Statement Showing Computation of Break even of each machine, Calculation of indifference point & range of sales where each machine is profitable.

		Amount (₹)	
	Particulars	A	B
I.	Selling Price	10	10
II.	No. of units	10,000	10,000
III.	Sales	1,00,000	1,00,000
IV.	Fixed Cost	30,000	18,000
V.	Profit	30,000	22,000
VI.	Contribution	60,000	40,000
VII.	Contribution Per unit	6	4
VIII.	Variable Cost Per Unit	4	6
	Break Even Sales	50,000	45,000
	Break Even units	5000	4500

$$(b) \text{ Sales Level where both machines are equally profitable} = \frac{\text{Difference in Fixed Cost}}{\text{Difference in Variable Cost Per Unit}} = \frac{12000}{2} = 6000 \text{ units}$$

- For the units ≥ 6000 units machine A is more profitable because Variable Cost Per unit is less. For sales level below 6000 units Machine B is more Profitable because its Variable Cost Per Unit is more.

Illustration 22. (Optimum Mix)

A farmer owns an orchard which has an area of 300 acres on which he grows apples, apricots, Cherrie and plums. Of the total area, 200 acres of land are suitable for growing apricots and cherries and in the remaining acres of land any of the four fruits can be grown.

The marketing policy requires that in each season all the four types of fruits must be produced and the quantity of any one of the four fruits should not be less than 12,000 boxes.

It is essential that the area devoted to any one should be in terms of complete acres and not in fractions of an acre. There are no physical or marketing limitations and there is an adequate supply of all types of labour

The details regarding the selling price, production and cost are given below:



	Apples	Apricots	Cherries	Plums
Selling price per box ₹	10	10	20	30
Acreage at each present devoted to each line	120	70	80	30
Seasons yield in boxes per acre	500	150	100	200
Weight per box kg	30	30	40	20
Costs (₹):				
Direct: Material per acre	180	70	60	100
Labour:				
Growing per acre	200	150	100	130
Harvesting & Picking per box	1	1	2	3
Transport per box	2	2	1	3

Fixed overhead incurred each season:

	₹	Basis of apportionment to produce
Cultivation and growing	27,840	Direct labour cost incurred
Harvesting	20,900	Direct labour cost incurred
Administration	42,250	No. of boxes produced
Transport	5,110	Weight produced
Land revenue	9,000	No. of acres cultivated

Using above information, you are required to:

- Calculate profit and loss per box of each type of fruit that the farmer will obtain from operating the orchard on the present basis.
- Advise the farmer on the area to be allocated to each item in order to earn the maximum total profit.

Solution:

(a) Statement showing computation of profit per box of each crop if the Orchard is maintained on the present basis.

	Particulars	Apples	Apricots	Cherries	Plums	Total
I.	Selling Price (₹)	10	10	20	30	
II.	No. of boxes	60000	10500	8000	6000	84500
III.	Total Weight in kgs (No. of boxes x Wt per box)	1800000	315000	320000	120000	2555000
IV.	Sales (₹)	600000	105000	160000	180000	1045000
V.	Variable Cost (₹)					
	Direct Material	21600	4900	4800	3000	34300
	Growing	24000	10500	8000	3900	46400
	Harvesting	60000	10500	16000	18000	104500
	Transport	120000	21000	8000	18000	167000
	Total Variable Cost (₹)	225600	46900	36800	42900	352200
VI.	Contribution (Sales - Variable Cost) (₹)	374400	58100	123200	137100	692800
VII.	Fixed Cost (₹)					
	Cultivation & Growing	14400	6300	4800	2340	27840



	Harvesting	12000	2100	3200	3600	20900
	Administration	30000	5250	4000	3000	42250
	Transport	3600	630	640	240	5110
	Land Revenue	3600	2100	2400	900	9000
	Total Fixed Cost (₹)	63600	16380	15040	10080	105100
VIII.	Profit (₹)	310800	41720	108160	127020	587700
IX.	Profit Per box (₹)	5.18	3.97	13.52	21.17	6.95
X.	Contribution per acre (₹)	3120	830	1540	4570	
	Priority	II	IV	III	I	

(b) Statement showing optimum mix under the given conditions:

Particulars	Apples	Apricots	Cherries	Plums	Total
Minimum boxes to produce	12000	12000	12000	12000	
Area required for this minimum (acres)	24	80	120	60	284
Remaining Area (acres)	—	—	—	16	16
No. of acres	24	80	120	76	300

Illustration 23. (Shut down)

S.G Ltd produces four products in its factory. The volume of production and sales achieved is considerably lower than normal and so there has been substantial under recovery of overheads. The sales and cost particulars are as under:

(₹ In lakhs)					
	Products				Total
	A	B	C	D	
Sales	160	200	80	40	480
Costs:					
Direct Material	24	32	16	3	75
Direct Wages	40	48	32	8	128
Factory Overheads	48	64	40	8	160
Selling & Admn. (15% Sales)	24	30	12	6	72
Total	136	174	100	25	435
Profit / Loss	24	26	(20)	15	45
Under recovery of overheads					24
Profit before tax					21

40% of factory overheads are variable at normal volume and the selling and administration overheads are variable to the extent of 5% of sales. 20% of sales of product C are done in connection with Product A in as much as the discontinuance of Product C will bring down the sale of Product A by 10%. Alternatively, the sale of product C can be reduced to 20% of the present level to maintain the sales of product A.

In view of the loss reported for Product C the management has for consideration three proposals, viz;

- Discontinue product C. In that event the co. can save a sum of ₹8 lakhs p.a. in fixed expenses.
- Maintain the sales of product C to the extent of 20% of the present sales as sales service to product A. In that event the reduction of fixed expenses will be ₹ 3 lakhs p.a.

- c) Discontinue product C totally and increase the sales of product D for which demand is available to the extent of another ₹40 lakhs. This can be done without any change in fixed expenses.

Draft a report to the management bringing out the financial implications of the aforesaid three proposals as compared with the annual operating results generating a profit before tax of ₹21 lakhs. Suggest a source of action to be followed by the S.G Ltd.

Solution:

Computation of Variable Factory Overheads

₹ In lakhs

	A	B	C	D	Total
	₹	₹	₹	₹	₹
Factory Overheads recovered	48	64	40	8	160
(+) under recovery (6:8:5:1)	7.2	9.6	6	1.2	24
Overheads at normal value	55.2	73.6	46	9.2	184
40% Overheads Variable	22.08	29.44	18.4	3.68	73.6
Fixed Overhead	33.12	44.16	27.6	5.52	110.4

Presentation of data in 'Contribution' format

₹ In lakhs

	A	B	C	D	Total
	₹	₹	₹	₹	₹
I. Sales	160	200	80	40	480
II. Variable Cost					
Direct Material	24	32	16	3	75
Direct Wages	40	48	32	8	128
Variable Overheads	22.08	29.44	18.4	3.68	73.6
Variable Selling & Distribution Overheads.	8	10	4	2	24
	94.08	119.44	70.4	16.68	300.6
III. Contribution	65.92	80.56	9.6	23.32	179.4
IV Fixed Cost					
Fixed Factory Overheads	33.12	44.16	27.6	5.52	110.4
Fixed Selling & Distribution Overheads	16	20	8	4	48
	49.12	64.16	35.6	9.52	158.4
V. Profit/Loss	16.8	16.4	(26)	13.8	20.56

(a) Computation of Profit at course of Action a

₹ In lakhs

	A	B	D	Total
I. Contribution (65.92 – 10%)	59.328	80.56	23.32	163.208
II. Fixed Cost				150.400
III. Profit				12.808



(b)

₹ In lakhs

		A	B	C	D	Total
I.	Contribution	65.92	80.56	1.92	23.32	171.72
II.	Fixed Cost					155.40
III.	Profit					16.32

(c)

₹ In lakhs

		A	B	D	Total
I.	Contribution	59.328	80.56	46.64	186.528
II.	Fixed Cost				158.400
III.	Profit				28.128

From the above computation, it was found that profit is more in the course of action C i.e., discontinuing in Product C completely & increasing the sales of Product D at 100%, it is the best course of action to be suggested.

Illustration 24. (Make/Buy)

T.T.D Ltd., manufacturing a single product has normal working capacity of 8,000 units per annum. The sales manager has projected a sale of 10,000 units for the year 2015 - 16 at a price of ₹250 per unit.

The operating budget for 2015-16 as under:

	₹ in lakhs	₹ in lakhs
Sales: 8,000 units @ ₹250 each		20.00
Cost of production		
Raw material	12.00	
Direct wages	3.00	
Works overhead (50% Fixed)	1.40	
Admn. overhead (all fixed)	0.60	
Selling & Distribution OH (80% fixed)	1.00	18.00
Profit		2.00

In order to increase production to meet the sales demand, two proposals have been put forward as under:

- 1) Subcontracting the production of 2,000 units at ₹225 per unit.
- 2) Installing additional machine which will entail the following expenses :
 - (a) Cost of machine ₹2,00,000; Life 20 years
 - (b) Recruitment of 10 workers including direct workers to operate the machine at a wage rate of ₹500 each per month. Add 25% towards fringe benefits. (None of the existing workers will be utilised for this purpose).
 - (c) Interest on capital required for the purchase of machine 15% p.a.

The following additional fixed expenses will be required in respect of both alternatives.

Administration expenses - ₹10,000 per year.

Selling & Distribution expenses - ₹20,000 per year.

You are required to prepare

- (1) A statement showing respective profitability of the two methods of increasing the production.
- (2) Comment upon the choice of one of the two proposals.

Solution:

Statement Showing Computation of Profit at Proposed alternatives as well as present position:

		Present Position (8000)	Sub Contract (10000)	Own Expansion (10000)
		₹ In lakhs	₹ In lakhs	₹ In lakhs
I	Sales	20	25	25
II.	Variable Cost			
	Raw Materials	12	12	15
	Direct Wages	3	3	3
	Works Overhead	0.7	0.7	0.875
	Selling & Distribution Overhead	0.2	0.2	0.25
	Sub Contract Cost		4.5	
	Add Workers			0.75
		15.9	20.4	19.875
III.	Contribution	4.1	4.6	5.125
IV.	Fixed Cost	2.1	2.4	2.8
V.	Profit	2.0	2.2	2.325

The best proposal is to produce by their own to meet the additional demand by installing a new machine because it has highest profit.

Fixed Cost includes interest & depreciation.

Illustration 25. (Optimum Mix)

SV Ltd engaged in the manufacture of four products has prepared the following budget for 2015.

Product	A	B	C	D
Production Units	20,000	5,000	25,000	15,000
Selling price ₹/unit	21.75	36.75	44.25	64.00
Direct Materials ₹/unit	6.00	13.50	10.50	24.00
Direct Wages ₹/unit	4.75	9.00	18.00	24.00
Variable Overheads ₹/unit	5.00	6.00	6.00	6.50
Fixed Overheads ₹/annum	75,000	25,000	2,25,000	1,80,000

When the budget was discussed, it was proposed that the production of 'C' should be increased by 10,000 units for which capacity existed in 2015.

It was also decided that for the next year i.e. 2016, the production capacity should be further increased by 25,000 units over and above the increase of 10,000 units envisaged as above for 2015. The additional production capacity of 25,000 units should be used for the manufacture of product 'B' for which new production facilities were to be created at an annual fixed overhead cost of ₹35,000. The direct material costs of all the four products were expected to increase by 10% in 2016 while the other costs and selling prices would remain the same.

Required:

- (a) Find the profit of 2015 on the assumption that the existing capacity of 10,000 units is utilised to maximize the profit.



- (b) Prepare a statement of profit for 2016.
- (c) Assuming that the increase in the output of product 'B' may not fully materialise in the year 2016, find the number of units of product B to be sold in 2016 to earn the same overall profit as in 2015.

Solution:

(a) Statement showing computation of profit for the year 2015

			A	B	C	D	Total
I.	Selling Price	₹	21.75	36.75	44.25	64.0	
II.	Variable Cost	₹	15.75	28.50	34.50	54.5	
III.	Contribution	₹	6.0	8.25	9.75	9.5	
IV.	No. of units		20000	5000	35000	15000	
V.	Total Contribution	₹	120000	41250	341250	142500	645000
VI.	Fixed Cost	₹	75000	25000	225000	180000	505000
VII.	Profit	₹					140000

(b) Profit for the year 2016

		A	B	C	D	Total
I.	No. of Units	20000	30000	35000	15000	
		₹	₹	₹	₹	₹
II.	Contribution Per Unit	5.4	6.9	8.7	7.1	
III.	Total Contribution	108000	207000	304500	106500	726000
IV.	Fixed Cost					540000
V.	Profit					186000

(c) In order to get the profit of 2015, the 'Contribution' to be recovered as follows:

	Amount (₹)
Profit for the year 2015	140000
Existing Fixed Cost	505000
Additional Fixed Cost	35000
	680000
(-) 'Contribution' Recovered from A,C,D	519000
To be recovered from 'B'	161000

No. of units of B required = $161000 / 6.9 = 23,333$ units

Additional units minimum required = $23,333 - 5000 = 18,333$ units

Illustration 26. (Capacity Utilization — Optimum Mix)

- (a) A firm produces 5 different products from a single raw material. Raw material is available in abundance at ₹6 per kg. The labour rate is ₹8 per hour for all products. The plant capacity is 21,000 labour hours for the budget period. Production facilities can produce the products. The factory overhead rate is ₹8 per hour, comprising ₹5.60 per hour fixed overhead and ₹2.40 per hour as variable overhead. The selling commission is 10% of the product price. Given the following information, you are to suggest a suitable sales mix which will maximise the company's profits. Determine the profits that will be earned at the selected sales mix.



Product	Market Demands (Units)	Selling Price (₹)	Labour Hours Per (Unit)	Raw Material Required Per Unit (in gms)
A	4,000	32.00	1.00	700
B	3,600	30.00	0.80	500
C	4,500	48.00	1.50	1,500
D	6,000	36.00	1.10	1,300
E	5,000	44.00	1.40	1,500

Assume, in above situation, 3,500 hours of over time working is possible. It will result in additional fixed overheads of ₹20,000; a doubling of labour rates and a 50% increase in variable overheads. Do your recommend to overtime working?

Solution:

(a) Statement showing contribution per labour hour and ranking:

		A	B	C	D	E
		₹	₹	₹	₹	₹
I.	Selling Price	32	30	48	36	44
II.	Variable Cost					
	Raw Materials	4.2	3	9	7.8	9
	Labour	8	6.4	12	8.8	11.2
	Variable Overhead	2.4	1.92	3.6	2.64	3.36
	Selling Commission	3.2	3.00	4.8	3.6	4.4
	Total	17.8	14.32	29.4	22.84	27.96
III.	Contribution	14.2	15.68	18.6	13.16	16.04
IV.	Contribution per hour	14.2	19.6	12.4	11.96	11.45
		II	I	III	IV	V

Working Notes:

	hrs.
Available hours	21,000
(-) Utilized for B 3600 x 0.8	2,880
	18,120
(-) for A	4,000
	14,120
(-) for C	6,750
	7,370
(-) for D	6,600
	770

No. of units of E = $770 / 1.4 = 550$ units



Statement showing optimum mix under the given conditions and computation of profit at that mix.

		A	B	C	D	E	Total
I.	No. of Units	4000	3600	4500	6000	550	
		₹	₹	₹	₹	₹	₹
II.	Contribution Per Unit	14.2	15.68	18.6	13.16	16.04	
III.	Total Contribution	56,800	56,448	83,700	78,960	8,822	2,84,730
IV.	Fixed Cost	22,400	16,128	37,800	36,960	4,312	1,17,600
V.	Profit	34,400	40,320	45,900	42,000	4,510	1,67,130

(b) If overtime is used for Product E,

	Amount (₹)	
Contribution obtained = 11.45×3500		40,075
Less: Additional Fixed Cost	20,000	
Overtime Labour Cost 3500×8	28,000	
Addl. Variable Cost 3500×1.2	4,200	52,200
	Loss	12,125

Hence overtime working is not recommended.

Illustration 27. (Optimum Mix)

Akshara combines manufactures 3 components X, Y and Z which are made up from 3 parts A, B and C in the following proportions:

X	1A and 1B
Y	2A, 2B and 1C
Z	3A, 1B and 2C

These parts are made on the premises. Further information as follows:

	A (₹)	B (₹)	C (₹)
Selling price	6	14	24
Direct materials	2	2	5
Time cost	2	9	12

Time cost which covers the cost of direct labour and overheads is valued at ₹6 per hour. All parts can be sold individually at the above selling prices, but the market demand, which it is hoped, will be satisfied from the expansion for the components. The further expansion would provide an additional 58,000 hours and the additional market demand for the components would be 5,000 units each. Additional fixed expenses related to the expansion are expected to be ₹15,000.

Prepare a statement showing how the additional capacity available should be used to generate maximum additional profit.

**Solution:****Statement showing computation of 'Contribution' per hour & determination of priority for profitability:**

		X	Y	Z
		₹	₹	₹
I.	Selling Price	20 (6 + 14)	64 (12+28+24)	80 (18+14+48)
II.	Variable Cost			
	Direct Material	4	13	18
	Time Cost	11	34	39
		15	47	57
III.	Contribution	5	17	23
IV.	Contribution Per Hour	2.73 <u>5</u> 11/6	3.00 <u>17</u> 34/6	3.54 <u>23</u> 39/6
V.	Priority	III	II	I

Statement showing optimum mix under the given conditions & computation of profit at that mix:

		X	Y	Z	Total
I.	No. of Units		4500	5000	
			₹		
II.	Contribution Per Unit		17	23	
III.	Total Contribution	₹	76500	115000	191500
IV.	Fixed Cost	₹			15000
V.	Profit	₹			176500

Available hours = 58000

(-) hours used for Z (5000 x 39/6) = 32500

25500

No. of units produced by Y = $25,500 \div \frac{34}{6} = 4500$ units

Illustration 28. (Optimum Mix)

AB Ltd. manufactures three products. The standard selling prices and costs have been estimated for 1985 as follows:

	Per Unit		
	X (₹)	Y (₹)	Z (₹)
Selling Price	28	60	125
Direct materials	8	15	20
Direct wages	10	20	50
Variable overheads	5	10	25

Direct wages are paid at the rate of ₹2 per hour in each case. Fixed overheads are budgeted at ₹25,000 for the coming year.

In short run, the company cannot increase its direct labour strength and as a result, only 35,000 direct labour hours will be available in the coming year. The company has commitments to produce 500 units of each product.



It has been suggested that after meeting the minimum requirements for X, Y and Z, the balance of available direct labour hours should be used to produce the product Z.

You are required to:

- to prepare an income statement showing the expected results if the proposal is adopted
- comment on the statement you have produced in (a) and prepare an income statement for any alternative policy which you consider would be more profitable.
- Basing your calculations on your suggestion in (b), show the company's BEP in terms of units and sales value.
- Show the sales value which is required to produce an after tax return of 10% on capital employed of ₹1,00,000 assuming tax rate of 50%.

Solution:

(a) Statement showing computation of Contribution per hour & determination of priority for profitability:

		X	Y	Z
		₹	₹	₹
I.	Selling Price	28	60	125
II.	Variable Cost	23	45	95
III.	Contribution	5	15	30
IV.	Contribution Per hour	1	1.5	1.25
	Priority	III	I	II

Computation of Profit at the proposal

		X	Y	Z	Total (₹)
	Minimum Units to be produced	500	500	500	
	Units in Remaining time	--	--	600	
I.	No. of Units	500	500	1100	
II.	Contribution Per Unit	₹ 5	15	30	
III.	Total Contribution	₹ 2500	7500	33000	43000
IV.	Fixed Cost	₹			25000
V.	Profit	₹			18000

Working Notes:

$$\begin{aligned} \text{Available Hours} &= 35000 \\ (-) \text{ Hours for Minimum units} &= \underline{20000} \\ &15000 \\ \text{Units of Z} &= 15000 / 25 = 600 \text{ units.} \end{aligned}$$

(b) Computation of profit at Optimum Mix

		X	Y	Z	Total (₹)
	Minimum Units to be produced	500	500	500	
	Units in Remaining time	--	1500	--	
I.	No. of Units	500	2000	500	
II.	Contribution Per Unit	₹ 5	15	30	
III.	Total Contribution	₹ 2500	30000	15000	47500
IV.	Fixed Cost	₹			25000
V.	Profit	₹			22500



Units of Y = $15000 / 10 = 1500$ units

In order to break even 'C' must be equal to Fixed Cost

'Contribution' recovered from minimum units of each product.

X	=	500 x 5	=	2500
Y	=	500 x 15	=	7500
Z	=	500 x 30	=	<u>15000</u>
Fixed Cost	=		=	<u>25000</u>

(c) Break Even Units & Value

	Units	Value (₹)
X	500	14000
Y	500	30000
Z	500	62500
	1500	106500

(d)

Required Return before tax	=	$1,00,000 \times 10\% / 0.5$	=	₹20,000
Sales of Y required to get this profit	=	$20,000 / 15 \times 60$	=	₹80,000
Total sales required	=	$1,06,500 + 80,000$	=	₹1,86,500

Illustration 29. (Optimum Mix)

A company produces four products A,B,C, and D which are marketed in cartons. Of the total of 20 machines installed, 8 are suitable for manufacturing all the four products and the remaining 12 machines are not suitable for the manufacture of products A and D.

Each machine is in production for 300 days per year and each is used on a given product in terms of full days and not in fractions of days. The company however has no problem in obtaining adequate supplies of labour and raw materials.

The marketing policy is that all four products should be sold and the minimum annual production should be 3000 cartons for each product. Fixed costs budgeted amount to ₹50 lacs. Production cost and price data are as under:-

	A	B	C	D
Production/day/machine (cartons)	14	4	3	6
Selling price/carton	₹810	790	845	1290
Cost: Process I				
Direct Materials/day.				
Machine	₹140	52	45	84
Direct Labour/day/Machine	224	148	90	132
Process II				
Direct Material/Carton	₹ 30	30	30	30
Direct Labour/Carton	₹240	216	300	360
Variable Overheads/Carton	₹390	390	300	720



With a view to meeting the increasing demand for products A and D, the company is contemplating to convert such number of machines, as may be necessary, out of the 12 machines which at present are unsuitable to produce products A and D into all purpose machines. The cost of conversion of these machines is ₹2,10,000 per machines. The expenditure is to be amortized over a period of three years. The company expects 12.5% return on this expenditure.

Market research indicates that the company's sales products A and D can be increased to 37,500 cartons and 5,400 cartons respectively.

Required:

- Calculate the optimum profit of the company if the existing machines were worked on most profitable basis before conversion.
- Recommend the maximum number of machines to be converted into all purpose machines giving supporting calculations.
- Calculate for the first year the optimum profit of the company after conversion of the required number of machines into all-purpose machines.

Solution:

Statement showing computation of Contribution per machine days determination of priority for profitability.

		A	B	C	D
		₹	₹	₹	₹
I	Selling price per carton	810	790	845	1290
II	Variable Cost				
	Process 1				
	Direct Material	10	13	15	14
	Direct Labour	16	37	30	22
	Process 2				
	Direct Material	30	30	30	30
	Direct Labour	240	216	300	360
	Variable Overheads	390	390	300	720
		686	686	675	1146
III	Contribution per carton	124	104	170	144
IV	Contribution per machine day	1736	416	510	864
V	Priority	I	IV	III	II

Statement showing optimum mix under the given conditions & Computation of profit at that mix.

		A	B	C	D	Total
	Minimum no. of cartons to be produced	3000	3000	3000	3000	
	Cartons in the remaining machine days	23590 (1685x14)		5550 (1850 x 3)		
I	No. of Cartons	26590	3000	8550	3000	
II	Contribution per Carton (₹)	124	104	170	144	
III	Total Contribution (₹)	32,97,160	3,12,000	14,53,500	4,32,000	54,94,660
IV	Fixed Cost (₹)					50,00,000
V	Profit (₹)					4,94,660



Available Machine days	(300 x 8)		(300 x 12)
	2400		3600
A = 3000/14	215	B = 3000/4	750
D = 3000/6	<u>500</u>	C = 3000/3	<u>1000</u>
Machine Days	<u>1685</u>		<u>1850</u>

(b) Computation of No. of machines to be converted

	A	D	
Maximum Production	37500	5400	
No. of machine days required	2679	900	
	(37500/14)	(5400/6)	
Total machine days required to meet the demand = 2679 + 900		=	3579
(-) Machine days already available		=	<u>2400</u>
No. of machine days further required		=	<u>1179</u>

No. of machines required to be converted = 1179/300 = 3.93 (say) 4

(c) Computation of Optimum Mix after conversion & Profit.

		A	B	C	D	Total
I	No. of cartons	37500	3000	5014	5400	
		₹	₹	₹	₹	₹
II	Contribution per carton	124	104	170	144	
III	Total Contribution	4650000	312000	852380	777600	6591980
IV	Fixed Cost					5280000
V	Profit					1311980
	(-) Capital cost @ 12.5% on 840000					105000
						1206980

Total No. of Machine days (20 x 300)	=	6000.00
A - 37500/14	=	2678.57
B - 3000/4	=	750.00
D - 5400/6	=	900.00
		<u>4328.57</u>
Machine days available to 'C'	=	1671.43
No. of Cartons produced by 'C'	=	1671.43 x 3 = 5014

Note: Fixed Cost = ₹ [50,00,000 + (2,10,000 × 4)/3] = ₹ 52,80,000

Illustration 30. (Optimum mix with alternative Strategies)

A firm has two machines, namely, machine 'P' and machine 'Q'. Machine 'P' can be used for the production of either product 'A' or product 'B' or both. Machine 'Q' can be used for the production of either product 'X' or product 'Y' or both. In order to maintain customer relations a minimum quantity of 1500 units each of 'A' and 'B' and 1200 units each of 'X' and 'Y' should be produced by the firm.



The production and cost data for 1984 are as under:

Machine hours available P-4500 hours
Q-5100 hours

	PRODUCTS			
	A	B	X	Y
Machine used	P	P	Q	Q
Machine hours required per unit of out put	1.0	1.25	1.25	0.8
Selling price per unit	₹ 200	₹ 250	₹ 300	₹ 256
Direct material per unit	80	100	100	80
Direct labour per machine hour	90	80	100	125
Variable overhead per machine hour	12	12	20	20

Fixed overheads are ₹ 4lacs per annum. An additional expenditure involving a fixed overhead of ₹25,000 per annum will convert the machine P and Q into a versatile centre such that any four of the products can be manufactured on these two machines. The rate of output on these machines and direct wage rate will, however, remain the same. Required:

- Set an optimal product mix subject to minimum market commitments both before and after the conversion of the machines into a versatile centre.
- Evaluate the profitability under the two sets or product mixes.
- Advise the management whether the conversion of machine should be undertaken or not.

Solution:

Statement showing computation of Contribution per machine hour & determination of priority for profitability:

		A	B	X	Y
		₹	₹	₹	₹
I	Selling Price	200	250	300	256
II	Variable Cost				
	Direct Material	80	100	100	80
	Direct Labour	90	100	125	100
	Variable Overhead	12	15	25	16
		182	215	250	196
III	Contribution	18	35	50	60
IV	Contribution per hour	18	28	40	75
V	Priority	IV	III	II	I

Statement showing optimum product mix under the given condition & computation of profit before conversion of machines into Versatile:

		A	B	X	Y	Total
	Minimum units to be produced	1500	1500	1200	1200	
	Units in remaining hours	--	900	--	3300	
I	No. of units	1500	2400	1200	4500	
II	Contribution per unit (₹)	18	35	50	60	
III	Total contribution (₹)	27000	84000	60000	270000	441000
IV	Fixed Cost (₹)					400000
V	Profit (₹)					41000

**Working Notes**

	P		Q
Available Hours	4500		5100
A 1500 x 1		1200 x 1.25	
B 1500 x 1.25	<u>3375</u>	1200 x 0.8	<u>2460</u>
	<u>1125</u>		<u>2640</u>
No. of Units = 1125/1.25	900	2640/0.8	3300

Statement showing optimum mix under the given condition & computation of profit at that mix after conversion of machines into Versatile:

	A	B	X	Y	Total
Minimum units to be produced	1500	1500	1200	1200	
Units in remaining hours	--	--	--	4706.25	
I No. of units	1500	1500	1200	5906.25	
II Contribution per unit (₹)	18	35	50	60	
III Total contribution (₹)	27000	52500	60000	354375	493875
IV Fixed Cost (₹)					425000
V Profit (₹)					68875

Working Notes:

Total No. of hours	=	9600
Hours utilized (3375 + 2460)	=	<u>5835</u>
		<u>3765</u>
Units of Y = 3765 / 0.8	=	4706 Units

As the profit is increased by 27875/- it is advised to convert the machines into versatile centers.

Illustration 31. (Optimum Mix)

Novelties Ltd. seeks your advice on production mix in respect of the three products Super, Bright and Fine. You have the following information:

Data for Standard Costs per Unit:

	Super	Bright	Fine	
Direct Materials	₹320	₹ 240	₹160	
Variable overhead	16	40	24	
Direct Labour:				
Department:	Rate per Hour (₹)	Hours	Hours	Hours
A	8.00	6	10	5
B	16.00	6	15	11



From current budget, you have further details as below:

	Super	Bright	Fine
Annual production (No.s)	5,000	6,000	10,000
Selling price per unit (₹)	624	800	480
Fixed Overhead: ₹16,00,000			

Sales department's estimate of maximum possible sales in the coming year (No.s)	6,000	8,000	12,000
---	-------	-------	--------

You are also to note that there is a constraint on supply of labour in Department A and its manpower cannot be increased beyond its present level.

Suggest the best production and sales mix from the standpoint of maximum profitability. Prepare statements setting out the profits resulting from the budgeted production and the best alternative suggested by you.

Solution:

Statement showing computation of Contribution per hour in Dept-A & determination of priority for profitability.

		Super	Bright	Fine
		₹	₹	₹
I	Selling Price	624	800	480
II	Variable Cost			
	Direct Material	320	240	160
	Variable Overhead	16	40	24
	Direct Labour			
	Dept – A	48	80	40
	Dept – B	96	240	176
		480	600	400
III	Contribution	144	200	80
IV	Contribution per labour hour in Dept. A	24	20	16
V	Priority	I	II	III

Statement showing computation of profit at current budgeted production:

		Super	Bright	Fine	Total
I	No. of units	5000	6000	10000	
II	Contribution	144	200	80	
III	Total Contribution (₹)	720000	1200000	800000	2720000
IV	Fixed Cost (₹)				1600000
V	Profit (₹)				1120000

No. of hours in Department A at budget = $6 \times 5000 + 10 \times 6000 + 5 \times 10000 = 140000$.



Statement showing optimum mix under the given condition & computation of profit at that mix:

		Super	Bright	Fine	Total
I	No. of units	6000	8000	4800	
II	Contribution Per unit	144	200	80	
III	Total Contribution (₹)	864000	1600000	384000	2848000
IV	Fixed Cost (₹)				1600000
V	Profit (₹)				1248000

Available hours	1,40,000
(-) used for super (6000x6)	<u>36,000</u>
	1,04,000
(-) used for Bright (8000x10)	<u>80,000</u>
	<u>24,000</u>

No. of units of fine = $24,000/5 = 4800$ Units

Illustration 32. (Absorption vs Mgl)

ABC Ltd. manufactures only one product.

The following information relates to April and May 1986:

(i) Budgeted costs and selling prices:

	April	May
Variable manufacturing cost per unit	₹ 2.00	₹2.20
Total fixed manufacturing cost (based on budgeted sales of per month) (₹)	25,000 units 40,000	44,000
Total fixed marketing cost (based on budgeted sales of 25,000 units per month) (₹)	14,000	15,400
Selling price per unit (₹)	5.00	5.50

(ii) Actual production and sales achieved:

	units	units
Production	24,000	24,000
Sales	21,000	26,500

(iii) There was no stock of finished goods at the beginning of April 1986. There was no wastage or loss of finished goods during either April or May 1986.

(iv) Actual costs incurred corresponded to those budgeted for each month.

Required:

Calculate the relative effects on the monthly operating profits of applying the following methods:

- Absorption costing and
- Marginal costing.



Solution:

(i) Profit under Absorption Costing

	April	May
	₹	₹
Variable Manufacturing cost	48000	52800
Fixed Manufacturing cost	38400 (40000/25000 x 24000)	42240 (44000/25000 x 24000)
Total production cost	86400	95040
(+) Op. Stock	--	10800
	86400	105840
(-) Cl. Stock	10800 (86400 x 3/24)	1980 (95040 x 5/24)
Production cost of goods sold	75600	103860
(+) Under recovery (40000 – 38400)	1600 (40000-38400)	1760 (44000-42240)
	77200	105620
(+) Marketing costs	14000	15400
	91200	121020
Profit	13800	24730
Sales	105000	145750

(ii) Profit under Marginal Costing

		April	May
	Units	₹	₹
I	Sales	105000	145750
II	Variable Cost		
	Manufacturing	48000	52800
	(+) Op. Stock	--	6000
		48000	58800
	(-) Cl. Stock	6000	1100
		42000	57700
III	Contribution	63000	88050
IV	Fixed Cost	54000	59400
V	Profit	9000	28650

DECISION MAKING

Illustration 33. (Relevant Cost)

(a) A machine which originally cost ₹12,000 has an estimated life of 10 years and it depreciated at the rate of ₹1,200 per year. It has been unused for some time, however, as expected production orders did not materialise.

A special order has now been received which would require the use of the machine for two months.

The current net realisable value of the machine is ₹8,000. If it is used for the job, its value is expected to fall to ₹7,500. The net book value of the machine is ₹8,400. Routine maintenance of the machine currently costs ₹40 per month. With use, the cost of maintenance and repairs would increase to ₹60 per month.



What would be the relevant cost of using the machine for the order so that it can be charged as the minimum price for the order?

- (b) X Ltd. has been approached by a customer who would like a special job to be done for him and is willing to pay ₹22,000 for it. The job would require the following materials:

Materials	Total units required	Units already in stock	Book Value of units in stock	Realisable Value	Replacement Cost
			₹/unit	₹/unit	₹/unit
A	1,000	0	—	—	6
B	1,000	600	2	2.5	5
C	1,000	700	3	2.5	4
D	200	200	4	6	9

- (i) Material B is used regularly by X Ltd. and if stocks were required for this job, they would need to be replaced to meet other production demand.
- (ii) Materials C and D are in stock as the result of previous excess purchase and they have a restricted use. No other use could be found for material C but material D could be used in another job as substitute for 300 units of material which currently cost ₹5 per unit (of which the company has no units in stock at the moment.)

What are the relevant costs of material, in deciding whether or not to accept the contract? Assume all other expenses on this contract to be specially incurred besides the relevant cost of material is ₹550.

Solution:

(a) Computation of relevant cost of using the machine for the order

		Amount (₹)
Fall in sale value, if used	(8000-7500)	500.00
Incremental maintenance cost	[(60-40)×2]	40.00
		540.00

(b) Computation of relevant cost of the job

		Amount (₹)
A	(1000×6)	6,000.00
B	(1000×5)	5,000.00
C	[(700×2.5)+(300×4)]	2,950.00
D	(300×5)	1,500.00
		15,450.00
Add : other expenses		550.00
		₹ 1,6000.00

As the revenue from the order, which is more than the relevant cost of ₹16000 the order should be accepted

Illustration 34. (Relevant Cost)

The Officers' Recreation Club of a large public sector undertaking has a cinema theater for the exclusive use of themselves and their families. It is a bit difficult to get good motion pictures for show and so pictures are booked as and when available.



The theater has been showing the picture 'Blood Bath' for the past two weeks. This picture, which is strictly for adults only has been a great hit and the manager of the theater is convinced that the attendance will continue to be above normal for another two weeks, if the show of 'Blood Bath' is extended. However, another popular movie, eagerly looked forward to by both adults and children alike, 'Appu on the Airbus' is booked for next two weeks. Even if 'Blood Bath' is extended the theater has to pay the regular rental on 'Appu on the Airbus' as well.

Normal attendance at theater is 2,000 patrons per week, approximately one fourth of whom are children under the age of 12. Attendance of 'Blood Bath' has been 50% greater than the normal total. The manager believes that this would taper off during the second two weeks, 25% below that of the first two weeks, during the third week and 33 1/3 % below that of the first two weeks, during the fourth week. Attendance for 'Appu on the Airbus' would be expected to be normal throughout its run regardless of the duration.

All runs at the theater are shown at a regular price of ₹2 for adults and ₹1.20 for children lower than 12. The rental charge for 'Blood Bath' is ₹900 for one week or ₹1,500 for two weeks. For 'Appu on the Airbus' it is ₹ 750 for one week or ₹ 1,200 for two weeks. All other operating costs are fixed - ₹4,200 per week, except for the cost of potato wafers and cakes, which average 60% of their selling price. Sales of potato wafers and cakes regularly average ₹1.20 per patron, regardless of age.

The Manager can arrange to show 'Blood Bath' for one week and 'Appu on the Airbus' for the following week or he can extend the show of 'Blood Bath' for two weeks or else he can show 'Appu on the Airbus' for two weeks as originally booked.

Show by computation, the most profitable course of action he has to pursue.

Solution:

Statement showing evaluation of alternatives

		Blood bath	Blood bath & Appu on the airbus	Appu on the airbus
		₹	₹	₹
No. of spectators				
Adults:				
Third week	3,000 x 75%	2,250.00	2,250.00	1,500.00
fourth week	3,000 x 2/3	2,000.00	1,500.00	1,500.00
		4,250.00	3,750.00	3,000.00
Children:				
Third week				500.00
fourth week			500.00	500.00
			500.00	1,000.00
Total spectators:		4,250.00	4,250.00	4,000.00
Revenue:				
By sale of tickets		8,500.00	8,100.00	7,200.00
				(3,000 x 2 + 1000 x 1.2)
Add : contribution from snacks		2,040.00	2,040.00	1,920.00
		10,540.00	10,140.00	9,120.00
Less : Incremental cost		1,500.00	900.00	
		9,040.00	9,240.00	9,120.00

It is found that the net revenue is more at the option of running blood bath and Appu on the Air bus a week each. It must be chosen.

Illustration 35. (Evaluation of the Strategies)

A review, made by the top management of Sweat and Struggle Ltd. which makes only one product, of the result of the first quarter of the year revealed the following:



Sales in units	10,000
Loss	₹ 10,000
Fixed cost (for the year ₹1,20,000)	₹ 30,000
Variable cost per unit	₹ 8.00

The Finance Manager who feels perturbed suggests that the company should at least break-even in the second quarter with a drive for increased sales. Towards this, the company should introduce better packing which will increase the cost by ₹0.50 per unit.

The Sales Manager has an alternative proposal. For the second quarter additional sales promotion expenses can be increased to the extent of ₹5,000 and a profit of ₹ 5,000 can be aimed at during the period with increased sales.

The Production Manager feels otherwise. To improve the demand, the selling price per unit has to be reduced by 3%. As a result the sales volume can be increased to attain a profit level of ₹ 4,000 for the quarter.

The Manager Director asks you as a Cost Accountant to evaluate the three proposals and calculate the additional sales volume that would be required in each case, in order to help him to take a decision.

Solution:

Calculation of selling price

		₹
Variable cost	(8x10,000)	80,000.00
Add : Fixed cost		30,000.00
Total cost		1,10,000.00
Profit		(10,000.00)
Sales		1,00,000.00
Selling price	(100000/10000)	₹ 10

Statement showing evaluation of alternatives and the number of units required to attain the targets of respective managers.

	Finance Manager	Sales Manager	Production Manager
i) Selling price (₹)	10.00	10.00	9.70
ii) Variable cost (₹)	8.50	8.00	8.00
iii) Contribution per unit (₹)	1.50	2.00	1.70
iv) Fixed cost (₹)	30,000.00	35,000.00	30,000.00
v) Target (₹)	B.E.P	Profit or ₹ 5000	Profit of ₹ 4000
	(30000/1.5)	(40000/2)	(34000/1.7)
	20,000.00	20,000.00	20,000.00
Additional units required	10,000.00	10,000.00	10,000.00

**Illustration 36. (Evaluation of Strategies)**

A Company manufacturing agricultural tractors has a capacity to produce 6,000 tractors annually. The capital employed in the project as on date is ₹20 crores. With increasing cost of production and reducing margins, the company is fast narrowing its margin of safety. The return on capital employed fell from 10% in the previous year to 6% in the current year. i.e., the current year profit is 1.20 crores. The company wants to maintain the original cut-off rate of 12% and various possibilities have been examined for this purpose.

The company is at present manufacturing and marketing 6,000 tractors annually though there is imbalance in the plant. The company has the following major production departments with percentages of capacity utilisation for the present production:

Production Department	Capacity utilised
Machine shop	75%
Assembly shop	100%
Heat treatment shop	75%
Induction hardening	50%

The company operates a single shift of 8 hrs per day on an average for 300 days in a year. For technical reasons the plant will have to operate on single shift basis only.

The two alternatives which have emerged after a detailed study are:

- (a) To hire out the surplus capacity in the production shop for which constant demand exists. The following income and expenditure projections are drawn out:

	Hire charge per hour	Incremental cost per hour
Machine shop	₹ 10,000	₹ 2,000
Heat treatment shop	₹ 7,500	₹ 1,500
Induction hardening	₹ 5,000	₹ 1,000

- (b) To increase the installed capacity to 8,000 tractors by spending ₹2 crores on additional machinery for the assembly shop. The incremental revenue from the additional sales will be ₹ 5,000 per tractor. The cost of additional finance will be 12% being the cost of existing capital employed, In addition, tax benefits on an average will work out to 1% of additional investment.

You are required:

- (i) To work out the profitability, i.e., average rate of return of the two alternatives; and

Solution:

Computation of hire charges and return on capital employed

		₹
Machine shop	$[2400 \times 25\% \times (10000 - 2000)]$	4,800,000.00
Heat treatment	$[2400 \times 25\% \times (7500 - 1500)]$	3,600,000.00
Induction hardening	$[2400 \times 50\% \times (4000)]$	4,800,000.00
		13,200,000.00
Present profit		12,000,000.00
Total profit		25,200,000.00
Return on investment	$[(25200000 / 20000000) \times 100]$	12.6%



Computation of profit under alternative 2

		₹
Profit from sale of tractors	(5000x2000)	10,000,000.00
Hire charges		3,200,000.00
Tax benefit (1% on 2 crores)		200,000.00
		13,400,000.00
Add : existing profit		12,000,000.00
		254,00,000.00
Return on investment	$[(25400000/220000000) \times 100]$	11.55%

Working notes:

Computation of surplus capacity in the production shop

Machine shop	$\{[(300 \times 8) \times 75\%] \times 100/75\}$	2,400.00
		(no extra capacity)
Heat treatment	$\{[(300 \times 8) \times 75\%] \times 100/75\}$	2,400.00
		(no extra capacity)
Induction	$\{[(300 \times 8) \times 50\% \times (8000/6000)]\}$	1,600.00
Extra capacity in induction	(1600 x 50%)	800 hours
Therefore hire charges (₹)	(800 x 4000)	3,200,000.00

As the required cut off rate is 12%, it is better to hire out the balance capacity instead of increasing capacity.

Illustration 37. (Evaluation of the Order)

A Modern Packing Corporation specialises in the manufacture of one-liter plastic bottles. The firm's customers include dairy processors, fruit juice manufacturers and manufacturers of edible oils. The bottles are produced by a process called blow moulding. A machine heats plastic to the melting point. A bubble of molten plastic is formed inside a mould, and a jet of hot air is forced into the bubble. This blows the plastic into the shape of the mould. The machine releases the moulded bottle, an employee trims off any flashing (excess plastic around the edge), and the bottle is complete.

The Firm has four moulding machines, each capable of producing 100 bottles per hour. The firm estimates that the variable cost of producing a plastic bottle is 20 paise. The bottles are sold for 50 paise each.

Management has been approached by a local toy company that would like the firm to produce a moulded plastic toy for them. The toy company is willing to pay ₹ 3.00 per unit for the toy. The variable cost of manufacture of the toy will be ₹2.40. In addition, Modern Packing Corporation would have to incur a cost of ₹20,000 to construct the needed mould exclusively for this order. Because the toy uses more plastic and is of a more intricate shape than a bottle, a moulding machine can produce only 40 units per hour. The customer wants 1,00,000 units. Assume that Modern Packing Corporation has the total capacity of 10,000 machine hours available during the period in which the toy company wants the delivery of toys. The firm's fixed costs, excluding the costs to construct the toy mould, during the same period will be ₹2,00,000.

Required:

- If the management predicts that the demand for its bottles will require the use of 7,500 machine hours or less during the period, should the special order be accepted? Give the reasons.
- If the management predicted that the demand for its bottles would be higher than its ability to produce bottles, should the order be accepted? Why?



- (c) The management has located a firm that has just entered the moulded plastic business. The firm has considerable excess capacity and more efficient moulding machines and is willing to subcontract the toy job, or any portion of it for ₹ 2.80 per unit. It will construct its own toy mould. Determine Modern Packing Corporation's minimum expected excess machine hour capacity needed to justify producing any portion of the order itself rather than subcontracting it entirely.
- (d) The management predicated that it would have 1,600 hours of excess machine hour capacity available during the period. Consequently, it accepted the toy order and subcontracted 36,000 units to the other plastic company. In fact demand for bottles turned out to be 9,00,000 units for the period. The firm was able to produce only 8,40,000 units because it had to produce the toys. What was the cost of the prediction error failure to predict demand correctly?

Solution:

Contribution From M bottle per hour	[100(0.5-.2)]	₹30
Contribution from toy per hour	[40(3-2.4)]	₹24

- (a) When the demand for the bottles is 7500 or less hours, it is better to accept, toy order because it gives additional profit of ₹40000
- (b) When the capacity for bottles is more than 7500 hours, the toy order should not be accepted because the contribution of bottle ₹30, is more than the contribution per hour of toy ₹24
- (c) The level at which it is necessary to sub contract the toy order is $[20000 / (2.8-2.4)] = 50000$ units
- (d) Computation of cost of prediction error.

(I) Statement showing computation of profit if 36000 toys are given for sub contract

	Bottles	Toy Manufacture	Toy Sub contract	Total
i. No. of units	840,000.00	64,000.00	36,000.00	
ii. Contribution per unit (₹)	0.30	0.60	0.20	
iii. Total contribution (₹)	252,000.00	38,400.00	7,200.00	297,600.00
iv. Fixed cost (₹)	200,000.00	20,000.00		220,000.00
v. Profit (₹)	52,000.00	18,400.00	7,200.00	77,600.00

(II) Computation of profit at actual position

	Bottles	Toys	Total
i. No. of units	900,000.00	100,000.00	
ii. Contribution per unit (₹)	0.30	0.20	
iii. Total contribution (₹)	270,000.00	20,000.00	290,000.00
iv. Fixed cost (₹)	200,000.00		200,000.00
v. Profit (₹)	70,000.00	20,000.00	90,000.00
Therefore cost of prediction error	(90000-77600)		₹12400

Illustration 38. (Relevant Cost)

Tiptop Textiles manufactures a wide range of fashion fabrics. The company is considering whether to add a further product 'Superb' to the range. A market research survey recently undertaken at a cost of ₹50,000 suggests that demand of the 'Superb' will last for only one year, during which 50,000 units could be sold at ₹18 per unit. Production and sale of 'Superb' would take place evenly throughout the year. The following information is available regarding the cost of manufacturing 'Superb'.



Raw Materials: Each 'Superb' would require 3 types of raw materials Posh, Flash and Splash. Quantities required, current stock levels and cost of each raw material are shown below. Posh is used regularly by the company and stocks are replaced as they are used. The current stock of Flash is the result of over buying for an earlier contract. The material is not used regularly by Tiptop Textiles and any stock that was not used to manufacture 'Superb' would be sold. The Company does not carry a stock of splash and the units required would be specially purchased.

Raw	Quantity reqd. per unit of superb (Meters)	Current stock (meters)	Costs per metre of raw material		
			Original Cost	Current replacement cost	Current resale cost
			₹	₹	₹
Posh	1.00	1,00,000	2.10	2.50	1.80
Flash	2.00	60,000	3.30	2.80	1.10
Splash	0.50	0	5.50	5.00	5.00

Labour: Production of each 'Superb' would require a quarter of an hour of skilled labour and two hours of unskilled labour and ₹2 per hour for unskilled labour. In addition, one foreman would be required to devote all his working time for one year in supervision of the production of superb. He is currently paid an annual salary of ₹15,000. Tiptop Textiles is currently finding it very difficult to get skilled labour. The skilled workers needed to manufacture 'Superb' would be transferred from another job on which they are earning a contribution surplus of ₹1.50 per labour hour, comprising sales revenue of ₹10.00 less skilled labour wages of ₹3.00 and other variable costs of ₹5.50. It should not be possible to employ additional skilled labour during the coming year. If 'Superb' are not manufactured, the company expects to have available 2,00,000 surplus unskilled labour hours during the coming year. Because the company intends to expand in the future, it has decided not to terminate the services of any unskilled worker in the foreseeable future. The foreman is due to retire immediately on an annual pension payable by the company of ₹6,000. He has been prevailed upon to stay on for a further year and to defer his pension for one year in return for his annual salary.

Machinery: Two Machines would be required to manufacture 'Superb' MT 4 and MT 7. Details of each machine are as under:

		Start of the year ₹	End of the year ₹
MT 4	Replacement cost	80,000	65,000
	Resale Value	60,000	47,000
MT 7	Replacement cost	13,000	9,000
	Resale Value	11,000	8,000

Straight-line depreciation has been charged on each machine for each year of its life. Tiptop Textiles owns a number of MT 4 machines, which are used regularly for various products. Each MT 4 is replaced as soon it reaches the end of its useful life. MT 7 machines are no longer used and the one which would be used for 'Superb' is the only one the company now has. If it were not used to produce 'Superb' it would be sold immediately.

Overheads: A predetermined rate of recovery for overheads is in operation and the fixed overheads are recovered fully from the regular production at ₹3.50 per labour hour. Variable overhead costs for Superb are estimated at ₹1.20 per unit produced.

For decision-making, incremental costs based on relevant costs and opportunity costs are usually computed.

You are required to compute such a cost sheet for 'Superb' with all details of material, labour overhead etc., substantiating the figures with necessary explanations.



Solution:

For each of the element the relevant cost will be as follows for preparing cost sheet

(i) Market survey cost is a sunk cost and not relevant for decision making

(ii) Raw materials

- (a) Raw material 'posh', is used regularly and stocks are replenished and hence current replacement cost is relevant i.e. $(50,000 \times 1 \times 2.5) = ₹ 125,000.00$
- (b) Current stock of 'flash' is a result of over buying and will not be used for other than 'superb' and hence relevant cost is net releasable value

Material required $(50000 \times 2) = 100000$ units

(60000×1.1)	₹ 66,000.00	
(40000×2.8)	₹ 112000	₹ 178,000.00

- (c) Material 'splash' has no stock and has to be bought and relevant cost is hence not relevant in decision making
 $(50000 \times 0.5 \times 5) = ₹ 125,000.00$

(iii) Labour:

- (a) Due to unskilled labour, no work has been suffered and so no extra cost and hence not relevant in decision making
- (b) Skilled labour is scarce therefore not only the cost, but also the contribution forgone, being opportunity cost, should be considered for decision making
 $(50000 \times 0.25 \times 4.5) = ₹ 56,250.00$
- (c) Effective cost of pension $(15000 - 6000) = ₹ 9,000.00$

(iv) Machinery:

- (a) MT-4 are regularly used and therefore the difference between replacement cost at the start and at the end of the year is relevant $(80000 - 65000) = ₹ 15,000.00$
- (b) MT-7 is not used regularly and the difference between resale value at the start and at the end of the year should be taken $(11000 - 8000) = ₹ 3,000.00$

(v) Variable overheads are relevant $(50000 \times 1.2) = ₹ 60,000.00$

(vi) Fixed overheads are not relevant because it is recorded fully at regular production

Cost sheet of 50000 units of superb

	Amount (₹)	Amount (₹)
Raw material:		
Posh	125,000.00	
Flash	178,000.00	
Splash	125,000.00	428,000.00
Labour:		
Skilled	56,250.00	
Pension	9,000.00	65,250.00
Machinery:		
MT-4	15,000.00	
MT-7	3,000.00	18,000.00
Variable overheads		60,000.00
		571,250.00
Profit (b/f)		328,750.00
Sales (50000×18)		900,000.00

Illustration 39. (Pricing)

Forward and Foundry Ltd. is feeling the effects of a general recession in the industry. Its budget for the coming half year is based on an output of only 500 tones of casting a month which is less than half of its capacity. The prices of casting vary with the composition of the metal and the shape of the mould, but they average ₹ 175 a tone. The following details are from the Monthly Production Cost Budget at 500 tone levels:

	Core making	Melting and Pouring	Moulding	Cleaning and Grinding
	₹	₹	₹	₹
Labour	10,000	16,000	6,000	4,500
Variable overhead	3,000	1,000	1,000	1,000
Fixed overhead	5,000	9,000	2,000	1,000
	18,000	26,000	9,000	6,500
Labour and O.H. rate per direct labour hour	9.00	6.50	6.00	5.2

Operation at this level has brought the company to the brink of break-even. It is feared that if the lack of work continues, the company may have to lay off some of the most highly skilled workers whom it would be difficult to get back when the volume picks up later on. No wonder, the work's Manager at this Juncture, welcomes an order for 90,000 casting, each weighing about 40 lbs., to be delivered on a regular schedule during the next six months. As the immediate concern of the Works Manager is to keep his work force occupied, he does not want to lose the order and is ready to recommended a quotation on a no-profit and no-loss basis.

Materials required would cost ₹ 1 per casting after deducting scrap credits. The direct labour hour per casting required for each department would be:

Core Making	0.09
Melting and pouring	0.15
Moulding	0.06
Cleaning and grinding	0.06

Variable overheads would bear a normal relationship to labour cost in the melting and pouring department and in the moulding department. In core making, cleaning and grinding however, the extra labour requirements would not be accompanied by proportionate increases in variable overhead. Variable overhead would increase by ₹1.20 for every additional labour hour in core making and by 30 paise for every additional labour hour in cleaning and grinding. Standard wage rates are in operation in each department and no labour variances are anticipated.

To handle an order as large as this, certain increases in factory overheads would be necessary amounting to ₹ 1,000 a month for all departments put together. Production for this order would be spread evenly over the six months period.

You are required to:

- Prepare a revised monthly labour and overhead cost budget, reflecting the addition of this order.
- Determine the lowest price at which quotation can be given for 90,000 castings without incurring a loss.

Solution:**Computation of labour and overhead rate**

	Core making	Melting & pouring	Moulding	Cleaning & grinding
Labour & overheads (₹)	18,000.00	26,000.00	9,000.00	6,500.00
Labour & overheads per hour (₹)	9.00	6.50	6.00	5.20
No. of hours	2,000.00	4,000.00	1,500.00	1,250.00



Variable overhead per hour (₹)	1.50	0.25	0.67	0.80
Labour rate per hour (₹)	5.00	4.00	4.00	3.60
Hours required for new order	1,350.00	2,250.00	900.00	900.00
Labour cost required for order (₹)	6,750.00	9,000.00	3,600.00	3,240.00
Variable overhead cost for order (₹)	1,620.00	563.00	600.00	270.00

Revised monthly labour and overheads cost budget reflecting the additions of the order

	Core making	Melting & pouring	Moulding	Cleaning & grinding	Total
	₹	₹	₹	₹	₹
Labour	10,000.00	16,000.00	6,000.00	4,500.00	
Labour for the order	6,750.00	9,000.00	3,600.00	3,240.00	
	16,750.00	25,000.00	9,600.00	7,740.00	
Variable overheads	3,000.00	1,000.00	1,000.00	1,000.00	
Variable overheads for the order	1,620.00	563.00	600.00	270.00	
	4,620.00	1,563.00	1,600.00	1,270.00	
Fixed cost	5,000.00	9,000.00	2,000.00	1,000.00	
Total	26,370.00	35,563.00	13,200.00	10,010.00	85,143.00
Add : additional fixed cost					1,000.00
				Total:	86,143.00

Computation of total price for the order

		₹
Material	(15000x1)	15,000.00
Labour & overheads	(86143-59500)	26,643.00
		41,643.00
Total price for the order	(41643x6)	249858

Illustration 40. Profitability Analysis — Service Industry

A local Government authority owns and operates a leisure centre with numerous sporting facilities, residential accommodation, a cafeteria and a sports shop. The summer season lasts for 20 weeks including a peak period of 6 weeks corresponding to the school holidays. The following budgets have been prepared for the next summer season:

Accommodation:

60 single rooms let on a daily basis.

35 double rooms let on a daily basis at 160% of the single room rate.

Room rate:

Fixed costs ₹29,900.

Variable costs ₹ 4 per single room per day and ₹6.40 per double room per day

Sports centre:

Residential guests each pay ₹ 2 per day and casual visitors ₹ 3 per day for the use of facilities.

Fixed costs ₹15,500.



Sports Shop:

Estimated contribution ₹1 per person per day.

Fixed costs ₹ 8,250.

Cafeteria:

Estimated contribution ₹ 1.50 per person per day.

Fixed costs ₹12,750.

During the summer season the centre is open 7 days a week and the

Following activity levels are anticipated.

Double rooms fully booked for the whole season.

Single rooms fully booked for the peak period but at only 80% of

Capacity during the rest of the season.

30 casual visitors per day on average.

You are required to:

- Calculate the charges for single and double rooms assuming that the authority wishes to make a ₹ 10,000 profit on accommodation.
- Calculate the anticipated total profit for the leisure centre as a whole for the season.
- Advise the authority whether an offer of ₹2,50,000 from a private leisure company to operate the centre for five years is worth while, assuming that the authority uses a 10% cost of capital and operations continue as outlined above.

Solution:**Computation of usage of room days**

		₹
Single room		
(60x7x6)	2,520.00	
(60x7x14x80%)	4,704.00	
		7,224.00
Double room (35x7x20)		4,900.00
i) Total sale value of accommodation		
Variable cost		
Single room (7224x4)	28,896.00	
Double room (4900x6.4)	31,360.00	60,256.00
Fixed cost		29,900.00
Required profit		10,000.00
		100,156.00

Let 'S' be the room rent of single room and 1.6'S' is the rent of double room Therefore

$$7224S + 4900(1.6S) = 100516$$

$$7224S + 7840S = 100516 = S = 6.65$$

$$\text{Double room rent} = (6.65 \times 1.6) = 10.64$$

**(ii) Statement showing computation of total profit to leisure centre**

		₹
a. Accommodation		10,000.00
b. sports centre:		
Total	[(7224x2)+(4900x2x2)+(30x7x20x3)]	46,648.00
Less : fixed		15,500.00
		31,148.00
c. Sports Shop:		
Contribution	[(7224x1)+(4900x2x1)+(30x7x20x1)]	21,224.00
Less : fixed		8,250.00
		12,974.00
d. cafeteria		
Contribution	[(7224x1.5)+(4900x2x1.5)+(30x7x20x1.5)]	31,836.00
Less : fixed		12,750.00
		19,086.00
		73,208.00

(iii) Present values

Present value compound factor @ 10% for 5 years	3.79
P.V. of profit for 5 years (73208x3.7906)	₹ 277,500.00

As the present value of profit for 5 years is ₹ 277500, which is more than the lease rent of ₹ 250000, it is not worthwhile to give leisure centre for lease

Illustration 41. (Relevant Cost)

Chakra Ltd. manufactures Mixer Grinders. The manufacture involves an assembly of various parts which are proceeds in the machine shop and purchased components. The on/off switch is presently being purchased form a vendor at ₹ 4.50 each, annual requirement being 20,000 pieces.

The production manager has put up a proposal two months back to make the switch in the machine shop. He had suggested that the company would make profit and save taxes on bought out switch. The costing department was asked to make an estimate of making the item which showed that the cost of making was ₹ 4.73. The purchase department continues buying the item on the basis of the cost estimate given to them. Recently, the Vendor has sent a letter requesting the purchase department to grant increase in price of 10% minimum per switch as the input costs had gone up. The costing department was once again requested to estimate cost of making the switch.

The costing department re-estimated the costs using current prices and observed that the cost of making has gone up to ₹ 5.33. Purchase department again decided to continue buying as it was cheaper to buy than make. The cost estimate prepared by the costing department was as under:

	Annual costs	
	Previous (₹)	Current (₹)
Direct Materials	40,000	48,000
Direct Labour ₹2 per hour	20,000	22,000
Overheads at ₹3 per hour	30,000	31,500
Total cost at current price	90,000	1,01,500
Add: expected increase 5%	4,500	5,075
Expected manufacturing cost	94,500	1,06,575
Cost per price	4.73	5.33



Twenty-five per cent of the overheads are fixed.

Required: Do you agree with the decision of buying considering the relevant costs? If the cost of making or buying is more or less same, what factors other than cost will influence making decision?

Solution:

Statement showing computation of making on/off switch before and after price increase.

Particulars	Previous (₹)	Current (₹)
Materials	40000	48000
Labour	20000	22000
Overhead	22500	23625
	82500	93625
Cost per Switch	4.125 (82500/20000)	4.68 (93625/20000)
Cost of Buying	4.50	4.95 (4.50 x 110/100)

It is not agreeable that purchase department continues to buy the switch because variable cost of making are less than buying cost.

Note: Expected increased cost is not relevant cost.

Illustration 42. (Make/Buy)

A Company manufacturing a highly successful line of cosmetics intends to diversify the product line to achieve fuller utilization of its plant capacity. As a result of considerable research made the company has been able to develop a new product called 'EMO'.

EMO is packed in tubes of 50 grams capacity and is sold to the wholesalers in cartons of 24 tubes at ₹ 240 per carton. Since the company uses its spare capacity for the manufacture of EMO, no additional fixed expenses will be incurred. However, the cost accountant has allocated a share of ₹ 4,50,000 per month as fixed expenses to be absorbed by EMO as a fair share of the company's present fixed costs to the new production for costing purposes.

The company estimated the production and sale of EMO at 3,00,000 tubes per month and on this basis the following cost estimates have been developed.

	₹ per carton
Direct Materials	108
Direct Wages	72
All overheads	54
Total costs	234

After a detailed market survey the company is confident that the production and sales of EMO can be increased to 3,50,000 empty tubes and the cost of empty tubes, purchased from outside will result in a saving of 20% in material and 10% in direct wages and variable overhead costs of EMO. The price at which the outside firm is willing to supply the empty tubes is ₹ 1.35 per empty tube. If the company desires to manufacture empty tubes in excess of 3,00,000 tubes, new machine involving an additional fixed overheads ₹ 30,000 per month will have to be installed. Required.

(i) State by showing your working whether company should make or buy the empty tubes at each of the three



volumes of production of EMO namely 3,00,000; 3,50,000 and 4,50,000 tubes.

- (ii) At what volume of sales will it be economical for the company to install the additional equipment for the manufacture of empty tubes?
- (iii) Evaluate the profitability on the sale of EMO at each, of the aforesaid three levels of output based on your decision and showing the cost of empty tubes as a separate element of cost.

Solution:

Total Cost per tube including EMO:

Direct Material	108/24	= ₹ 4.50
Direct Wages	72/24	= ₹ 3.00
Variable Overheads	[54/24 – 450000/300000]	= ₹ 0.75

Particulars	Total Cost (₹)	Tube Cost (₹)	Product Cost (₹)
Material	4.5	0.9	3.60
Wages	3.0	0.3	2.70
Variable Overhead	0.75	0.075	0.675
	8.25	1.275	6.975

Statement showing computation of manufacturing cost of 300000 tubes

Cost of making (300000 x 1.275)	=	₹ 3,82,500
Cost of buying (300000 x 1.35)	=	₹ 4,05,000

It is better to make the tubes at 300000 level of output.

Computation of Cost for additional tubes:

Particulars	50000	150000
Cost of Making (₹)	93750 [(50000 x 1.275) + 30000]	221750 [(150000 x 1.275) + 30000]
Cost of Buying (₹)	67500 (50000 x 1.35)	202500 (150000 x 1.35)

From the above, it is better to buy at these levels.

- (ii) The level at which it is beneficial to make the tubes over and above 300000 units.

$$[\text{Indifference Point}] \frac{\text{Fixed Cost}}{\text{Diff. in Variable Cost per unit}} = \frac{30000}{1.35 - 1.275} = 4,00,000 \text{ units.}$$

The Company will be justified to install the additional Equipment for the manufacture of Empty tubes at a sales volume of 400000 units.

Statement showing computation of Profit at three levels of output:

	Particulars	300000	350000	450000
I.	Sales [240/24] (₹)	3000000	3500000	4500000
II.	Cost (₹)	2092500 (300000x6.975)	2441250 (350000x6.975)	3138750 (450000x6.975)
III.	Tube Cost (₹)	382500 (300000x1.275)	472500 (350000x1.35)	607500 (450000x1.35)
IV.	Fixed cost (₹)	450000	450000	450000
V.	Total Cost (₹)	2925000	3363750	4196250
VI.	Profit (I – V) (₹)	75000	136250	303750

Illustration 43. (Evaluation Statement)

Z Ltd. manufactures a range of products which it sells through manufacturer's agents to whom it pays commission of 20% of the selling price of the products. Its budgeted profits and loss statement for 1987 is as follows:

	₹	₹
Sales		22,50,000
Production costs:		
Prime costs and variable overhead	7,87,500	
Fixed Overhead	3,62,500	
		11,50,000
		11,00,000
Selling costs:		
Commission to manufacturer's agents	4,50,000	
Sales office expenses (fixed)	20,000	
		4,70,000
		6,30,000
Administration costs (fixed)		3,00,000
Profit		3,30,000

Subsequent to the preparation of the above budgeted profit and loss statement, the company is faced with a demand from its agents for an increase in their commission to 22% of selling price. As a result, the company is considering whether it might achieve more favorable results if it were to discontinue the use of manufacturer's agents and, instead employ its own sales force. The costs that this could involve are budgeted as follows:

	₹
Sales manager (salary and expenses)	75,000
Salesmen's expenses (including traveling costs)	20,000
Sales office costs (additional to present costs)	50,000
Interest and depreciation on sales department cars	35,000

In addition to the above, it will be necessary to hire four salesmen at a salary of ₹40,000 per annum each plus commission of 5% on sales plus car allowance of Re.1 per Kilometer to cover all costs except interest and depreciation.

On the assumption that the company decided to employ its own sales force on the above terms, you are required to ascertain:



- (a) What is the maximum average kilometer per annum that salesmen could travel if the company is to achieve the same budgeted profit as it would have obtained by retaining the manufacturer's agents and granting them the increased commission they had requested. Assume that sales in each case would be as budgeted.
- (b) At what level of sales would the original budgeted profit be achieved if each salesmen were to travel an average of 14,000 kilometers per annum. Assume that all other assumptions inherent in the budgets were maintained.
- (c) What is the maximum level of commission on sales that the company could afford to pay if it wished to achieve a 16% increase in its original budgeted profit and expected a 16% increase in sales (at budgeted selling prices) and average of 16,000 kilometers per annum to be traveled by each salesmen.

Solution:**(a) Computation of amount available for car allowance:**

	₹	₹
Commission		495000
(+) Costs	180000	
Commission (2250000 x 5%)	112500	
Salaries of salesmen	160000	452500
Amount available for payment to car allowance		42500

No. of KMS that each salesmen can travel = $42500/4 = 10625$.

(b) Computation of Required sales to earn desired profit:

		₹	₹
I.	Sales		2250000
II.	Variable Cost		
	Material	787500	
	Commission @ 5%	112500	900000
III	Contribution		1350000
IV	Fixed Cost:		
	Existing Fixed Overheads	362500	
	Existing sales office expenses	20000	
	Existing Admn. Overheads	300000	
	New Selling Expenses	180000	
	Sales men salaries	160000	
	Car allowance (14000 x 4)	56000	1078500
V	P/V Ratio = $C/S \times 100 = 1350000/2250000 \times 100 = 60\%$		
VI	Required sales to get desired Profit (budgeted Profit) = $1078500 + 330000 / 0.6 = ₹ 2347500$		

(c) Computation of maximum commission that the Co. would be able to pay at the increased quantum of sales:

		₹
I.	Sales (2250000 x 116/100)	2610000
II.	Variable Cost (787500 x 116/100)	913500
III	Contribution	1696500
	(-) Fixed Cost other than car allowance (1078500 – 56000)	1022500
		674000
	(-) Car allowance (16000 x 4)	64000
		610000
	(-) Profit Expected (330000 x 116/100)	382800
	Amount available for payment of commission	227200

% of commission on sales = $227200 / 2610000 \times 100 = 8.7\%$

Illustration 44. (Pricing)

Shri Kiran manufactures lighters. He sells his product at ₹20 each, and makes profit of ₹5 on each lighter.

He worked 50 per cent of his machinery capacity at 50,000 lighters. The cost of each lighter is as

	₹
Direct material	6
Wages	2
Workers overhead	5 (50 per cent fixed)
Sales expenses	2 (25 per cent variable)

His anticipation for the next year is that the cost will go up as under:

Fixed cost	10%
Direct wages	20%
Material	5%

There will not be any change in selling price. There is an additional order for 20,000 lighters in the next year.

What is the lowest rate he can quote so that he can earn the same profit as the current year?

Solution:

Present profit	= 50000 x 5	= ₹ 250000
Present Fixed cost	= 50000 (2.5+1.5)	= ₹ 200000

Computation of Profit after increase in prices:

	Particulars	Amount (₹)	Amount (₹)
I.	Selling Price		20-00
II.	Variable Cost		
	Material [6 x 105/100]	6.30	
	Wages [2 x 120 / 100]	2.40	
	Works Overhead	2.50	
	Sales Expenses	0.50	11-70
III	Contribution		8-30
IV	Total Contribution [50000 x 8.30]		415000
V	Fixed Cost [200000 x 110/100]		220000
VI	Profit		195000

**Computation of Selling Price of the order:**

Contribution of profit required for unit 55000/20000	=	₹ 2.75
(+) Variable cost per unit	=	₹ 11.70
Therefore, Required Selling Price	=	₹ 14.45

Illustration 45. (Evaluation of the Order)

A manufacturing company currently operating at 80% capacity has received an export order from Middle East, which will utilise 40% of the capacity of the factory. The order has to be either taken in full and executed at 10% below the current domestic prices or rejected totally.

The current sales and cost data are given below.

Sales	₹16.00 lakhs.
Direct Material	₹ 5.80 lakhs.
Direct Labour	₹ 2.40 lakhs.
Variable Overheads	₹ 0.60 lakhs.
Fixed Overheads	₹ 5.20 lakhs.

The following alternatives are available to the management:

- Continue with domestic sales and reject the export order.
- Accept the export order and allow the domestic market to starve to the extent of excess of demand.
- Increase capacity so as to accept the export order and maintain the domestic demand by
 - Purchasing additional plant and increasing 10% capacity and there by increasing fixed overheads by ₹65,000 and
 - Working overtime at one and half time the normal rate to meet balance of the required capacity.

You are required to evaluate each of the above alternatives and suggest the best one.

Solution:**Statement showing computation of profit at different alternatives:**

(In Lakhs)

	Particulars	I Present Sales 80%	II 40% - Foreign 60% - Domestic	III 40% - Foreign 80% - Domestic
I.	Sales (₹)	16	19.2 (7.2 + 12)	23.2 (7.2+16)
II.	Variable Cost (₹)			
	Direct Material (₹)	5.8	7.25	8.70
	Direct Labour (₹)	2.4	3.00	3.60
	Variable Overheads (₹)	0.6	0.75	0.90
	Overtime Premium (₹)	--	--	0.15
		8.80	11.00	13.35
III	Contribution (₹)	7.20	8.20	9.85
IV	Fixed Cost (₹)	5.20	5.20	5.85 (5.20 + 0.65)
V	Profit (₹)	2.00	3.00	4.00

From the above computation, it was found that the profit is more at the III alternative i.e. accepting the foreign order fully and maintaining the present domestic sales, it is the best alternative to be suggested.

**Illustration 46. (Make/Buy)**

AB Ltd manufactures a picnic table which has three components, X,Y,Z one of each being required for each table. The company is working to its full machine capacity of 28,000 hours per period and the machinery used is capable of making all the components.

The tables are made in batches of 20 and data relating to current production are:

Components	Machine Hours	Variable Costs ₹	Per batch of 20	
			Fixed Costs ₹	Total Costs ₹
X	6	15	6	21
Y	10	18	7	25
Z	<u>12</u>	18	13	31
	<u>28</u>			
Assembly		<u>32</u>	<u>13</u>	<u>45</u>
		<u>83</u>	<u>44</u>	<u>127</u>
		Profit		<u>23</u>
		Selling price		<u>150</u>

Over the next budget period the machine capacity cannot be increased although the assembly capacity can be increased as required. The budget for the next period is being prepared. Because of the expected increase in sales, purchase of one of the components is being considered and the following quotation has been received:

Batches of 20	
Component	Price (₹)
X	22
Y	28
Z	32

The company has decided that only one component will be bought outside in any one period. The sales director thinks that he could sell at least 50% more tables than at present and probably 75% more provided that the production capacity was available.

You are required to:

- Recommend which component should be bought outside if production is increased by 50% and how many components should be bought;
- Recommend which component should be bought outside if production is increased by 75% and how many components should be bought.

Solution:

No. of units being produced at present = $28000/28 = 1000$

Statement showing Contribution (or) buying cost per machine hour.

	Particulars	X	Y	Z
I	Price quoted (₹)	22	28	32
II	Variable cost (₹)	15	18	18
III	Contribution (₹)	7	10	14
IV	Contribution (or) Buying cost per Machine hour (₹)	1.17 (7/6)	1.00 (10/10)	1.17 (14/12)



Since, the buying cost per machine hour is less in case of Y it should be bought from outside. No. of units that may be bought from outside.

If 50% capacity is increased:

Hours utilized for	X	=	1500 x 6	=	9000 hours
(1000 x 150%)	Z	=	1500 x 12	=	<u>18000</u> hours
					<u>27000</u> hours

Remaining hours = 28000 – 27000 = 1000 hours

No. of units that can be manufactured by Y = 1000/10 = 100 units

No. of units to be bought from outside = 1500 – 100 = 1400 units

If 75% capacity is increased:

Hours utilized for	X	=	1750 x 6	=	10500 hours
	Z	=	1750 x 12	=	21000 hours

This is not possible because if Y is bought from outside, the available hours are not sufficient to manufacture X & Z and it is also given that only one component should be bought from outside. We have to buy from outside either X (or) Z and it will not matter if we buy any one of these because the buying cost per machine hour is same.

In that event, we shall try to purchase from outside which takes more machine hours, at present i.e. Z. On calculation no. of units of Z to be bought from outside is as follows:

Hours utilized for making X	=	1750 x 6	=	10500 hours	
	Y	=	1750 x 10	=	<u>17500</u> hours
					<u>28000</u> hours

No. of units of Z to be bought from outside = 1750 units.



2.2 TRANSFER PRICING

Introduction and Meaning:

In the modern days, production is on the mass scale due to technological advancement and upgradation. Organisations grow in course of time and for such growing organisations, decentralization becomes absolutely necessary. It becomes inevitable for such organisations to establish separate divisions and departments to ensure smooth working. Transfer pricing has become necessary in highly decentralized companies where number of divisions/departments are created as a part and parcel of the decentralized organisation. Transfer pricing is one of the tools in the hands of management for measuring the performance of divisions or departments.

A 'Transfer Price' is that notional value at which goods and services are transferred between divisions in a decentralized organisation. Transfer prices are normally set for intermediate products, which are goods, and services that are supplied by the selling division to the buying division. In large organisations, each division is treated as a 'profit center' as a part and parcel of decentralization. Their profitability is measured by fixation of 'transfer price' for inter divisional transfers.

The transfer price can have impact on the division's performance and hence lot of care is to be taken in fixation of the same. The following factors should be taken into consideration before fixing the transfer prices.

1. Transfer price should help in the accurate measurement of divisional performance.
2. It should motivate the divisional managers to maximize the profitability of their divisions.
3. Autonomy and authority of a division should be ensured.
4. Transfer Price should allow 'Goal Congruence' which means that the objectives of divisional managers match with those of the organisation.

Objectives of Inter Company Transfer Pricing:

The following are the main objectives of intercompany transfer pricing scheme:

1. **To evaluate the current performance and profitability of each individual unit** : This is necessary in order to determine whether a particular unit is competitive and can stand on its working. When the goods are transferred from one department to another, the revenue of one department becomes the cost of another and such inter transfer price affects the reported profits.
2. **To improve the profit position** : Intercompany transfer price will make the unit competitive so that it may maximize its profits and contribute to the overall profits of the organisation.
3. **To assist in decision making** : Correct intercompany transfer price will make the costs of both the units realistic in order to take decisions relating to such problems as make or buy, sell or process further, choice between alternative methods of production.
4. **For accurate estimation of earnings on proposed investment decisions** : When finance is scarce and it is required to determine the allocation of scarce resources between various divisions of the concern taking into consideration their competing claims, then this technique is useful.

Methods of Transfer Pricing:

It is the notional value of goods and services transferred from one division to other division. In other words, when internal exchange of goods and services take place between the different divisions of a firm, they have to be expressed in monetary terms. The monetary amount for those inter divisional exchanges is called as 'transfer price'. The determination of transfer prices is an extremely difficult and delicate task as lot of complicated issues are involved in the same. Inter division conflicts are also possible. There are several methods of fixation of 'Transfer Price'. They are discussed below.

1. Pricing based on cost.
 - (a) Actual cost
 - (b) Cost plus



- (c) Standard cost
 - (d) Marginal cost
2. Market price as transfer price.
 3. Negotiated pricing.
 4. Pricing based on Opportunity cost.
1. **Pricing based on cost:** In these methods, 'cost' is the base and the following methods fall under this category.
- (a) **Actual Cost:** Under this method the actual cost of production is taken as transfer price for inter divisional transfers. Such actual cost may consist of variable cost or sometimes total costs including fixed costs.
 - (b) **Cost Plus:** Under this method, transfer price is fixed by adding a reasonable return on capital employed to the total cost. Thereby the measurement of profit becomes easy.
 - (c) **Standard Cost:** Under this method, transfer price is fixed on the basis of standard cost. The difference between the standard cost and the actual cost being variance is absorbed by transferring division. This method is simple and easy to follow, but the constant revision of standards is necessary at regular intervals.
 - (d) **Marginal Cost:** Under this method, the transfer price is determined on the basis of marginal cost. The reason being fixed cost is in any case unavoidable and hence should not be charged to the buying division. That is why only marginal cost will be taken as transfer price
2. **Market price as transfer price:** Under this method, the transfer price will be determined according to the market price prevailing in the market. It acts as a good incentive for efficient production to the selling division and any inefficiency in production and abnormal costs will not be borne by the buying division. The logic used in this method is that if the buying division would have purchased the goods/services from the open market, they would have paid the market price and hence the same price should be paid to the selling division. One of the variation of this method is that from the market price, selling and distribution overheads should be deducted and price thus arrived should be charged as transfer price. The reason behind this is that no selling efforts are required to sale the goods/services to the buying division and therefore these costs should not be charged to the buying division. Market price based transfer price has the following advantages :
1. Actual costs are fluctuating and hence difficult to ascertain. On the other hand market prices can be easily ascertained.
 2. Profits resulting from market price based transfer prices are good parameters for performance evaluation of selling and buying divisions.
 3. It avoids extensive arbitration system in fixing the transfer prices between the divisions.

However, the market price based transfer pricing has the following limitations :

1. There may be resistance from the buying division. They may question buying from the selling division if in any way they have to pay the market prices.
2. Like cost based prices, market prices may also be fluctuating and hence there may be difficulties in fixation of these prices.
3. Market price is a rather vague term as such prices may be ex-factory price, wholesale price, retail price etc.
4. Market prices may not be available for intermediate products, as these products may not have any market.
5. This method may be difficult to operate if the intermediate product is for captive consumption.
6. Market price may change frequently.
7. Market prices may not be ascertained easily.



- 3. Negotiated Pricing:** Under this method, the transfer prices may be fixed through negotiations between the selling and the buying division. Sometimes it may happen that the concerned product may be available in the market at a cheaper price than charged by the selling division. In this situation the buying division may be tempted to purchase the product from outside sellers rather than the selling division. Alternatively the selling division may notice that in the outside market, the product is sold at a higher price but the buying division is not ready to pay the market price. Here, the selling division may be reluctant to sell the product to the buying division at a price, which is less than the market price. In all these conflicts, the overall profitability of the firm may be affected adversely. Therefore it becomes beneficial for both the divisions to negotiate the prices and arrive at a price, which is mutually beneficial to both the divisions. Such prices are called as 'Negotiated Prices'. In order to make these prices effective care should be taken that both, the buyers and sellers should have access to the available data including about the alternatives available if any. Similarly buyers and sellers should be free to deal outside the company, but care should be taken that the overall interest of the organisation is not affected.
- The main limitation of this method is that lot of time is spent by both the negotiating parties in fixation of the negotiated prices.
 - Negotiating skills are required for the managers for arriving at a mutually acceptable price, otherwise there is a possibility of conflicts between the divisions.
- 4. Pricing based on opportunity cost:** This pricing recognizes the minimum price that the selling division is ready to accept and the maximum price that the buying division is ready to pay. The final transfer price may be based on these minimum expectations of both the divisions. The most ideal situation will be when the minimum price expected by the selling division is less than the maximum price accepted by the buying division. However in practice, it may happen very rarely and there is possibility of conflicts over the opportunity cost.

It is very clear that fixation of transfer prices is a very delicate decision. There might be clash of interests between the selling and buying division and hence while fixing the transfer price, overall interests of the organisation should be taken into consideration and overall 'Goal Congruence' should be given utmost importance rather than interests of the selling or buying division.

Illustration 47.

Your company fixes the inter-divisional transfer prices for its products on the basis of cost, plus a return on investment in the division. The Budget for Division A for 1981-82 appears as under:

	₹
Fixed Assets	5,00,000
Current assets	3,00,000
Debtors	2,00,000
Annual Fixed Cost of the Division	8,00,000
Variable Cost per unit of Product	10
Budgeted Volume	4,00,000 units per year
Desired ROI	28%

Determine the transfer Price for Division A.

Solution:

		₹
Variable Cost		10.00
Fixed Cost per unit	$8,00,000 \div 4,00,000$	2.00
required Return	$\frac{10,00,000 \times 28\%}{4,00,000}$	0.70
Total cost or Transfer price		<u>12.70</u>

**Illustration 48.**

Transferor Ltd. has two processes Preparing and Finishing. The normal output per week is 7,500 units (Completed) at a capacity of 75%

Transferee Ltd. had production problems in preparing and requires 2,000 units per week of prepared material for their finishing processes.

The existing cost structure of one prepared unit of Transferor Ltd. at existing capacity

Material	₹ 2.00 (variable 100%)
Labour	₹ 2.00 (Variable 50%)
Overhead	₹ 4.00 (variable 25%)

The sale price of a completed unit of Transferor Ltd is ₹16 with a profit of ₹4 per unit.

Construct the effect on the profits Transferor Ltd., for six months (25 weeks) of supplying units to Transferee Ltd. with the following alternative transfer prices per unit:

- (i) Marginal Cost
- (ii) Marginal Cost + 25%
- (iii) Marginal Cost + 15% Return on capital (assume capital employed ₹20 lakhs)
- (iv) Existing Cost
- (v) Existing Cost + a portion of profit on the basis of (preparing cost / Total Cost) x Unit Profit
- (vi) At an agreed market price of ₹8.50 Assume no increase in fixed cost.

Solution:

Transferred units	25 x 2000 =	50000
Existing profit	7500 x 25 x 4 = ₹	750000

Effect on profit if transfer price is

- (i) Marginal cost

	₹
Material	2.00
Labour	1.00
OHS	1.00
	4.00

At this transfer price there is no effect on profit of transferor ltd.

- (ii) Profit = 50000
- (iii) Price per unit = $4 + \{(2000000 \times 15\% \times 0.5) / 50000\} = 7$

Under this method profit of transferor ltd is increases by 150000 i.e., 50000 x (7-4)

- (iv) Profit increases by 50000 x (8-4) = 200000
- (v) Transfer price: ₹
- {8 + (8/12)4} = 10.67
- Marginal Cost = 4.00
- Profit = 6.67



Profit increases by $50000 \times 6.67 = ₹ 333500/-$

(vi) Transfer price = 8.50

Profit increase by $4.5 \times 50000 = ₹ 2,25,000$

Illustration 49.

A Company with two manufacturing divisions is organised on profit centre basis. Division 'A' is the only source for the supply of a component that is used in Division B in the manufacture of a product KLIM. One such part is used in each unit of the product KLIM. As the demand for the product is not steady. Division B can obtain orders for increased quantities only by spending more on sales promotion and by reducing the selling prices. The Manager of Division B has accordingly prepared the following forecast of sales quantities and selling prices.

Sales units per day	Average Selling price per unit of KLIM
	₹
1,000	5.25
2,000	3.98
3,000	3.30
4,000	2.78
5,000	2.40
6,000	2.01

The manufacturing cost of KLIM in Division B is ₹3,750 for first 1,000 units and ₹750 per 1,000 units in excess of 1,000 units.

Division A incurs a total cost of ₹1,500 per day for an output to 1,000 components and the total costs will increase by ₹900 per day for every additional 1,000 components manufactured. The Manager of Division A states that the operating results of his Division will be optimised if the transfer price of the component is set at ₹1.20 per unit and he has accordingly set the aforesaid transfer price for his supplies of the component to Division A.

You are required:

- Prepare a schedule showing the profitability at each level of output for Division A and Division B.
- Find the profitability of the company as a whole at the output level which
 - Division A's net profit is maximum.
 - Division B's net profit is maximum.
- If the Company is not organised on profit centre basis, what level of output will be chosen to yield the maximum profit.

Solution:

(i) Statement showing profit of division A:

Sale per day(units)	Sale value	Cost	Profit/(loss)
	₹	₹	₹
1000	1200	1500	(300)
2000	2400	2400	-
3000	3600	3300	300
4000	4800	4200	600
5000	6000	5100	900



6000	7200	6000	1200
------	------	------	------

Profit of division B:

No of units	Sales	Transfer price	Other manufacturing cost	Total cost	Profit/(loss)
	₹	₹	₹	₹	₹
1000	5250	1200	3750	4950	300
2000	7960	2400	4500	6900	1060
3000	9900	3600	5250	8850	1050
4000	11120	4800	6000	10800	320
5000	12000	6000	6750	12750	(750)
6000	12060	7200	7500	14700	(2640)

(ii) Profitability of the company at the output level where division A's net profit is maximum :

	₹
Profit of division A at 6000units	1200
Profit of division B at 6000units	(2640)
Profit / (loss)	<u>(1440)</u>

Division B's net profit is maximum:

Profit of division A at 2000 units	-
Profit of division B at 2000units	1060
	<u>1060</u>

(c) When the company is not organized on profit centre basis

Profit at different levels of output

Units	Division A	Division B	Total
	₹	₹	₹
1000	(300)	300	—
2000	—	1060	1060
3000	300	1050	1350
4000	600	320	920
5000	900	(750)	150
6000	1200	(2640)	(1440)

Best output level is 3000 units

Illustration 50.

Division A is a profit centre which produces three products X, Y and Z. Each product has an external market.

	X	Y	Z
External market price per unit	₹ 48	₹ 46	₹ 40
Variable cost of production in division A	₹ 33	₹ 24	₹ 28
Labour hours required per unit in division A	3	4	2

Product Y can be transferred to Division B, but the maximum quantity that might be required for transfer is 300 units of Y.

X	Y	Z
---	---	---

The maximum external sales are : 800 units 500 units 300 units

Instead of receiving transfers of Product Y from Division A, Division B could buy similar product in the open market at a slightly cheaper price of ₹45 per unit.

What should the transfer price be for each unit for 300 units of Y, if the total labour hours available in Division A are?

(a) 3800 hours

(b) 5600 hours.

Solution:

Computation of contribution per labour hour from external sales:

	X	Y	Z
Market price (₹)	48	46	40
Variable cost (₹)	33	24	28
Contribution (₹)	15	22	12
Labour hours required	3	4	2
Contribution per labour hour (₹)	5	5.50	6
Priority	III	II	I

Computation of transfer price when

(a) The capacity is 3800 hours:

$$\begin{array}{rcl}
 \text{Hours required for Z} & = 300 \times 2 & = 600 \\
 \text{Y} & = 500 \times 4 & = \underline{2000} \\
 & & 2600 \\
 \text{X} & = 800 \times 3 & \underline{2400} \\
 & & \underline{5000}
 \end{array}$$

The existing capacity is not sufficient to produce the units to meet the external sales. In order to transfer 300 units of Y, 1200 hours are required in which division A will give up the production of X to this extent.

Variable cost of Y	₹ 24
(+) contribution lost by giving up production of X to the extent of 1200 hours	
= 1200 x 5 = 6000	
∴ Opportunity cost per unit = (6000/300)	<u>20</u>

Required transfer price 44

(b) If the capacity is 5600 hours:

Variable cost	24
Contribution cost of giving up X to the extent of 600hours = 600 x 5 = 3000	
Opportunity Cost Per unit = (3000/300)	<u>10</u>

Required transfer price 34

**Illustration 51. (Profitability)**

PH Ltd. manufactures and sells two products, namely BXE and DXE. The company's investment in fixed assets is ₹2 lakh. The working capital investment is equivalent to three months' cost of sales of both the products. The fixed capital has been financed by term loan lending institutions at an interest of 11% p.a. Half of the working capital is financed through bank borrowing carrying interest at the rate of 19.4%, the other half of the working capital being generated through internal resources.

The operating data anticipated for 2016-17 is as under:

	Product BXE	Product DXE
Production per annum (in units)	5,000	10,000
Direct Material/unit:		
Material A (Price ₹ 4 per kg)	1 Kg	0.75 Kg
Material B (Price ₹ 2 per kg)	1 Kg	1 Kg
Direct labour hours	5	3

Direct wage rate ₹ 2 per hour. Factory overheads are recovered at 50% of direct wages. Administrative overheads are recovered at 40% of factory cost. Selling and distribution expenses are ₹ 2 and ₹ 3 per unit respectively of BXE and DXE. The company expects to earn an after tax profit of 12% on capital employed. The income tax rate is 50%.

Required:

- Prepare a cost sheet showing the element wise cost, total cost profit and selling price per unit of both the products.
- Prepare a statement showing the net profit of the company after taxes for the 2016-17.

Solution:

(a) Cost sheet

	BXE		DXE		TOTAL
	UNIT	TOTALS	UNIT	TOTAL	
	₹	₹	₹	₹	₹
Direct material	6	30000	5	50000	80000
Direct wages	10	50000	6	60000	110000
Prime cost	16	80000	11	110000	190000
Factory OHs	5	25000	3	30000	55000
Factory cost	21	105000	14	140000	245000
Office OHs	8.40	42000	5.60	56000	98000
Cost of production	29.40	147000	19.60	196000	343000
Selling & dist. OHs	2.00	10000	3.00	30000	40000
Cost of sales	31.40	157000	22.60	226000	383000
Interest		14807		16481	31288
Profit		33420		37560	70980
Sales / S.P	41.05	205227	28.00	280041	485268

**Working notes:**

(A)			₹
Return after tax	$\{383000 \times 0.25\} + 200000$	12%	35,490
∴ Sales	$383000 + 31288 + [35490 \times (1/50\%)]$		4,85,268
(B)			₹
	BXE	DXE	Total
Interest Calculation	$\{(157000 \times 0.25 \times 0.50 \times 19.4\%) + (100000 \times 11\% \times 50\%)\}$	$\{(226000 \times 0.25 \times 0.50 \times 19.4\%) + (100000 \times 11\% \times 50\%)\}$	
	=14,807	=16,481	31,288
(C)			₹
	BXE	DXE	Total
Profit Calculation	$\{(157000 \times 0.25) + 100000\} \times 12\% \times (1/50\%)$	$\{(226000 \times 0.25) + 100000\} \times 12\% \times (1/50\%)$	
	= 33,420	=37,560	70,980

(b) Statement showing net profit:

	₹
Sales	4,85,268
(-) cost of sales	(3,83,000)
Gross profit	<u>1,02,268</u>
(-) interest $\{22000 + (95750/2) 19.4\%$	(31,288)
profit before tax	<u>70,980</u>
(-) tax @ 50%	(35,490)
Profit after tax	<u>35,490</u>

Illustration 52.

P.H. Ltd. has two manufacturing departments organised into separate profit centres known as the Basic unit and Processing unit. The Basic unit has a production capacity of 4,000 tonnes per month of Chemvax but at present its sales are limited ₹ 2,000 tonnes to outside market and 1,200 tonnes to the Processing unit.

The transfer price for the year 1986 was agreed at ₹ 400 per tonne. This price has been fixed in line with the external wholesale trade price on 1st January 1986. However due to heavy competition the Basic unit has been forced to reduce the wholesale trade price to ₹ 360 per tonne with effect from 1st June, 1986. This price however was not made applicable to the sales made to the Processing unit of the company. The Processing unit applied for revision of the price as applicable to the outside market buyers as from 1st June 1986 but the same was turned down by the basic unit.

The Processing unit refines Chemvax and packs the output Known as Colour-X in drums of 50kgs each. The selling price of colour-X is ₹ 40 per drum. The Processing unit has a potential of selling a further quantity of 16,000 drums of colour-X provided the overall price is reduced to ₹32 per drum. In that event it can buy the additional 800 tonnes of Chemvax from the basic unit whose capacity can be fully utilised. The outside market will not however absorb more than the present quantity of 2,000 tonnes.



The cost data relevant to the operations are:

	Basic Unit	Processing Unit
	₹	₹
Raw Materials/tonne	70	Transfer price
Variable Cost/tonne	140	170
Fixed Costs/month	₹ 3,00,000	1,20,000

You are Required :

- (i) Prepare statement showing the estimated profitability for June 1986 for each unit and the company as a whole on the following bases:
 - (a) At 80% and 100% capacity utilisation of the Basic unit at the market price and transfer price to the Processing unit of ₹400 per tonne.
 - (b) At 80% capacity utilisation of the basic unit at the market price of ₹360 per tonne and the transfer price to the Processing unit of ₹ 400 per tonne.
 - (c) At 100% capacity utilisation of the Basic unit at the market price and transfer price to the Processing unit of ₹ 360 per tonne.
- (ii) Comment on the effect of the company's transfer pricing policy on the profitability of the Processing Unit.

Solution:

(a) Statement showing computation of profit at 80% capacity when transfer price is ₹ 400/- ton:

		Basic unit	Processing unit	Total
i) No. of units		3200	(1200x1000)/50	24000
ii) Contribution per unit	₹	{400-(140 + 70)} = 190	{40 - (570/20)}	11.50
iii) Total contribution	₹	608000	276000	884000
iv) Fixed cost	₹	300000	120000	420000
v) Profit	₹	308000	156000	464000

At 100% capacity:

		Basic unit	Processing unit	Total
i) No. of units		4000	40000	
ii) Contribution per unit	₹	190	3.50	
iii) Total contribution	₹	760000	140000	900000
iv) Fixed cost	₹	300000	120000	420000
v) Profit	₹	460000	20000	480000

**(b) Computation of profit:**

		Basic unit		Processing unit	Total
		Out side sale	Internal transfer		
i) No of units		2000	1200	24000	
ii) Contribution per unit	₹	150	190	11.50	
iii) Total contribution	₹	300000	228000	276000	
	₹		528000	276000	804000
iv) Fixed cost	₹		300000	120000	420000
v) Profit	₹		228000	156000	384000

(c) Computation of profit:

		Basic unit	Processing unit	Total
No of units		4000	40000	
Contribution per unit	₹	150	5.50	
Total contribution	₹	600000	220000	820000
Fixed cost	₹	300000	120000	420000
Profit	₹	300000	100000	400000

Overall profit is more at 100% capacity of basic unit with a transfer price of ₹ 400/- per ton being the market price. If individual interests are not considered this may be adopted. However, from the view point of the processing unit, it will not be interested to buy more than 1200tonnes from the basic unit, because its profit gets reduced when it takes additional units. Therefore, the present policy of the management is not at all attractive to the processing unit.

Illustration 53.

SV Ltd. Manufactures a product which is obtained basically from a series of mixing operations. The finished product is packaged in the company made glass bottles and packed in attractive cartons.

The company is organized into two independent divisions viz. one for the manufacture of the end product and the other for the manufacture of glass bottles. The Product manufacturing division can buy all the bottle requirements from the bottle manufacturing division.

The General Manager of the bottle manufacturing division has obtained the following quotations from the outside manufacturers for the empty bottles.

Volume	Purchase Value
Empty bottles	Total (₹)
8,00,000	14,00,000
12,00,000	20,00,000



A cost analysis of the bottle manufacturing division for the manufacture of empty bottles reveals the following production costs:

Volume	Purchase value
Empty bottles	Total Cost (₹)
8,00,000	₹10,40,000
12,00,000	14,40,000

The production cost and sales value of the end product marketed by the product manufacturing division are as under.

Volume (Bottle of end product)	Total cost of end product*	Sales Value (Packed in bottles)
8,00,000	₹64,80,000	₹ 91,20,000
12,00,000	₹96,80,000	₹1,27,80,000

There has been considerable discussion at the corporate level as to the use of proper price for transfer of empty bottles from the bottle manufacturing division to product manufacturing division. This interest is heightened because a significant portion of the Divisional General Manager's salary is in incentive bonus based on profit centre results.

As the corporate management accountant responsible for defining the proper transfer prices for the supply of empty bottles by the bottle manufacturing division to the product manufacturing division, you are required to show for the two levels of volume of 8,00,000 and 12,00,000 bottles, the profitability by using (i) market price and (ii) shared profit relative to the cost involved basis for the determination of transfer prices. The profitability position should be furnished separately for the two divisions and the company as a whole under each method. Discuss also the effect of these methods on the profitability of the two divisions.

* (Excluding cost of empty bottles)

Solution:

Statement showing Computation of transfer price on the basis of profit shared on cost basis:

	Output (800000)	Output (1200000)
	Amount (₹)	Amount (₹)
Sales	9120000	12780000
Costs:		
Product manufacturing division	6480000	9680000
Bottle manufacturing division	1040000	1440000
	7520000	11120000
Profit	1600000	1660000
Share of bottle manufacturing division	221276	214964
Product manufacturing division	1378724	1445036
Transfer price	1261276	1654964
Transfer price per bottle	1.5777	1.379

**Profitability on the basis of market price:**

	Output (800000)	Output (1200000)
	Amount (₹)	Amount (₹)
Bottle manufacturing division		
Sale value	1400000	2000000
(-)cost	1040000	1440000
Profit	360000	560000
Product manufacturing division		
Sale value	9120000	12780000
(-)cost of product	6480000	9680000
Cost of bottle	1400000	2000000
	7880000	11680000
Profit	1240000	1100000
Total profit	1600000	1660000
Transfer price	1.75	1.67

Illustration 54. (Opportunity Cost)

A manufacture has three products A, B, C Current sales; cost and selling price details and processing time requirements are as follows:

	Product A	Product B	Product C
Annual sales (units)	6000	6000	750
Selling Price (₹)	20	31	39
Unit Cost (₹)	18	24	30
Processing time required per unit (hour)	1	1	2

The firm is working at full capacity (13,500 processing hours per year.) Fixed manufacturing overheads are absorbed into unit costs by a charge of 200% of variable costs. This procedure fully absorbs the fixed manufacturing overhead.

Assuming that:

- (i) Processing time can be switched from one product line to another.
- (ii) The demand at current selling price is:

Product A	Product B	Product C
11,000	8,000	2,000

- (iii) The selling prices are not be altered.

You are required to calculate the best production programme for the next operating period and to indicate the increase in net profit that this should yield. In addition identify the shadow price of processing hour.

**Solution:**

Computation of contribution per labour hour & priority:

		A	B	C
i) Selling price	₹	20	31	39
ii) Variable cost(1/3 rd of total cost)	₹	6	8	10
iii) Contribution per unit	₹	14	23	29
iv) Contribution per hour	₹	14	23	14.5
v) Priority		III	I	II

Computation of current profit:

		A	B	C	TOTAL
i) No of units		6000	6000	750	
ii) Contribution per unit	₹	14	23	29	
iii) Total contribution	₹	84000	138000	21750	243750
iv) Fixed cost	₹	72000	96000	15000	183000
v) Profit	₹				60750

Statement showing optimum mix & profit at that mix:

		A	B	C	Total
i) No of units		1500	8000	2000	
ii) Contribution per unit	₹	14	23	29	
iii) Total contribution	₹	21000	184000	58000	263000
iv) Fixed cost	₹				183000
v) Profit	₹				80000

Working notes:

Hours available	13500
(-) used for B = 8000 x 1	<u>8000</u>
	5500
(-) used for C = 2000 x 2	<u>4000</u>
Used for A	<u>1500</u>

Increase in profit = 80000 – 60750 = 19250

Shadow price of processing hour:

The shadow price is the opportunity cost of one unit of resource for the decision maker. In the present case every extra processing hour will increase contribution by ₹ 14

There fore the shadow price of processing hour is ₹ 14.

**Illustration 55. (Pricing)**

Look Ahead Ltd. wants to fix proper selling prices for their products 'A' and 'B' which they are newly introducing in the market. Both these products will be manufactured in Department D, which is considered as a Profit Centre.

The estimated data are as under: -

	A	B
Annual Production (unit)	1,00,000	2,00,000
	₹	₹
Direct Materials per unit	15.00	14.00
Direct Labour per unit	9.00	6.00

(Direct Labour Hour Rate = ₹ 3)

The proportion of overheads other than interest, chargeable to the two products are as under:

Factory overheads (50% fixed) 100% of Direct Wages. Administration overheads (100% fixed) 10% of factory costs. Selling and Distribution overheads (50% variable) ₹ 3 and ₹ 4 respectively per unit of products A and B.

The fixed capital investment in the Department is ₹50 lakhs. The working capital requirement is equivalent to 6 months stock of cost of sales of both the product. For this project a term loan amounting to ₹40 lakhs has been obtained from Financial Institutions on a interest rate of 14% per annum. 50% of the working capital needs are met by bank borrowing carrying interest at 18% per annum. The Department is expected to give a return of 20% on capital employed.

You are required to:

- Fix the selling price of products A and B such that the contribution per direct labour hour is the same for both the products.
- Prepare a statement showing in details the overall profit that would be made by the Department.

Solution:**Statement of Cost**

Material	A	B
	Amount (₹)	Amount (₹)
Direct Material	15	14
Direct Labour	9	6
Price Cost	24	20
Factory Overhead (100% Direct Labour)	9	6
Factory Cost	33	26
Administration Overhead (10% of Factory Cost)	3.30	2.6
Cost of production	36.30	28.6
Selling and Distribution	3	4
Cost of Sales (or) Unit Cost	39.30	32.60

Variable Cost:

	A	B
	Amount (₹)	Amount (₹)
Prime Cost	24	20
Factory Overhead (Variable) (9 x 50%) (6 x 50%)	4.5	3
Selling (Variable)	1.5	2
Total	30	25

**Computation of Total capital Employed:**

Fixed Capital		Amount (₹) 50,00,000
Working Capital:		
A = 1,00,000 x 39.3	39,30,000	
B = 2,00,000 x 32.6	65,20,000	
	1,04,50,000 x 6/12	52,25,000
Total Capital employed		1,02,25,000
Required Return @ 20% on Total Capital employed		20,45,000
Total Cost		1,04,50,000
Add: EBIT		20,45,000
Sales Value		1,24,95,000
Less: Variable Cost	1,00,000 x 30 + 2,00,000 x 25	80,00,000
Contribution		44,95,000
Contribution per hour	44,95,000/7,00,000	6.4214
Contribution for unit of 'A'	3 x 6.4214	19.2643
Contribution for unit of 'B'	2 x 6.4214	12.8429

Computation of Selling Price:

	A	B
	Amount (₹)	Amount (₹)
Variable cost	30	25
Add: Required Contribution	19.2643	12.8429
Selling Price	49.2643	37.8429

(b)

		Amount (₹)
I	Sales	1,24,95,000
II	Cost	1,04,50,000
III	EBIT (Profit)	20,45,000
IV	Interest on term loan (40,00,000 x 14%)	(5,60,000)
V	Interest on bank borrowing 52,25,000 x ½ x 18/100	(4,70,250)
VI	Profit	10,14,750

Illustration 56. (Pricing Strategies)

S.V.Ltd budgets to make 1,00,000 units of product P. The variable cost per unit is ₹ 10. Fixed costs are ₹6,00,000. The finance Director suggested that the cost-plus approach should be used with a profit mark-up of 25%. However, the Marketing Director disagreed and has supplied the following information:



Price per unit (₹)	Demand (Unit)
18	84,000
20	76,000
22	70,000
24	64,000
26	54,000

As Management Accountant of the Company analyse the above proposals and comment.

Solution:

Calculation of selling price as per Finance Director's approach

	Amount (₹)
Variable Cost	10
Fixed Cost (6,00,000/1,00,000)	6
Total Cost	16
Add: Profit mark up 25%	4
Selling Price	20

Evaluation of marketing Director's Proposal:

Selling Price ₹	Contribution per unit ₹	No. of units	Total contribution ₹	Fixed Cost ₹	Profit ₹
18	8	84,000	6,72,000	6,00,000	72,000
20	10	76,000	7,60,000	6,00,000	1,60,000
22	12	70,000	8,40,000	6,00,000	2,40,000
24	14	64,000	8,96,000	6,00,000	2,96,000
26	16	54,000	8,64,000	6,00,000	2,64,000

At the selling price of ₹ 24 per unit, the profit is maximum and hence that price must be fixed for the product.

Illustration 57: (Transfer Price)

XYZ Ltd which has a system of assessment of Divisional Performance on the basis of residual income has two Divisions, Alfa and Beta. Alfa has annual capacity to manufacture 15,00,000 numbers of a special component that it sells to outside customers, but has idle capacity. The budgeted residual income of Beta is ₹ 1,20,00,000 while that of Alfa is ₹ 1,00,00,000. Other relevant details extracted from the budget of Alfa for the current year were as follows.

Particulars

Sale (outside customers)	12,00,000 units @ ₹ 180 per unit
Variable cost per unit	₹ 160
Divisional fixed cost	₹ 80,00,000
Capital employed	₹ 7,50,00,000
Cost of Capital	12%



Beta has just received a special order for which it requires components similar to the ones made by Alfa. Fully aware of the idle capacity of Alfa, beta has asked Alfa to quote for manufacture and supply of 3,00,000 numbers of the components with a slight modification during final processing. Alfa and Beta agree that this will involve an extra variable cost of ₹ 5 per unit.

Calculate the transfer price which Alfa should quote to Beta to achieve its budgeted residual income.

Solution:

Contribution required at Budgeted Residual Income

	₹
Fixed cost	80,00,000
Return on 7,50,00,000 x 12 %	90,00,000
Residual Income	<u>1,00,00,000</u>
Total Contribution required.	<u>2,70,00,000</u>
Contribution derived from existing units = 12,00,000 x 20 = ₹ 2,40,00,000	
Contribution required on 3,00,000 units = 2,70,00,000 – 2,40,00,000 = ₹ 30,00,000	
Contribution per unit = 30,00,000 / 3,00,000 = ₹ 10	
Increase in Variable cost = ₹ 5	

$$\begin{aligned} \therefore \text{Transfer price} &= \text{V.C} + \text{Desired Residual Income} + \text{Increase in VC} \\ &= 160 + 10 + 5 \\ &= ₹ 175 \end{aligned}$$

Illustration 58. (Division wise Profitability & Transfer Price)

Vinak Ltd. has two manufacturing divisions, AD and CD. Each division operates as an independent profit centre. AD which produces two components BRITE and LITE has a capacity of 1,00,000 hours per annum. The annual fixed overheads of this department amounts to ₹20 lakhs. The product wise variable cost data are as under:

	BRITE ₹/unit	LITE ₹/unit
Direct Materials	10	5
Direct Labour and Variable overheads	140	35
Total	150	40

The direct labour and variable overhead is ₹ 35 per hour.

AD has a permanent customer for the purchase of 15,000 units of BRITE per annum at a selling price of ₹300 per unit. The balance capacity is devoted to the production of LITE for which there is an unlimited sales potential at ₹60 per unit.

CD assembles a product known as TITE using an imported component. The annual fixed overheads of this division amount to ₹4 lakhs and the variable cost data per unit are as under:



	TITE ₹/Unit
Imported component	300
Direct Materials	40
Direct Labour and variable overheads (10 hours @ ₹25)	250
Total	590

The selling price of TITE is ₹700 per unit.

With a view of minimising the dependence on imported components, the possibility of using the company's own component BRITE, which is similar to the imported component, was explored. The import substitution is possible with slight modification in the manufacture of TITE which in that case will take two extra labour hours per unit. This means an increase of ₹50 in variable costs per unit of TITE. CD envisages a production of 5,000 units per annum of TITE.

You are required to present the division wise profitability and the profitability of the company as a whole on the basis of the following conditions:

- CD Imports its requirements of 5,000 components for the manufacture of TITE.
- CD Stops import and substitutes BRITE by drawing 5,000 units of BRITE from AD at the market price of ₹300 per unit.
- Same situation as in (ii) above except that CD gets a relief of ₹50/- per unit (net transfer price to CD is ₹250 per unit) of BRITE to compensate the increased labour and variable overhead cost of CD.
- CD revises its production programme to manufacture 12,000 units of TITE by drawing 10,000 units of BRITE from AD at ₹250 per unit and imports the balance of 2,000 units of components at ₹300/- per unit. Due to installation of additional production capacity, the annual fixed overhead of CD would increase by ₹7,70,000. In order to induce CD to the expansion programme do you think a negotiated transfer price of ₹240 for BRITE would be agreed by AD? Give reasons and also comment on the best alternative (i to iv) for the company as a whole.

Solution:

	BRITE ₹	LITE ₹	TITE ₹
Selling Price	300	60	700
Variable Costs	150	40	590
Contribution	150	20	110

Time required to produce 1 unit of BRITE = $140/35 = 4$ hrs.

Time required to produce 1 unit of LITE = $35/35 = 1$ hr.

Profitability :

(i)

	Amount (₹)
Division AD	
15,000 units of BRITE x ₹150	22,50,000
40,000 units of LITE x ₹20	8,00,000
Total contribution	30,50,000
Fixed expenses	20,00,000
Profit (A)	10,50,000



Division CD	
5,000 units of TITE X ₹110 contribution	5,50,000
Fixed expenses	4,00,000
Profit (B)	1,50,000
Overall Profit (A + B)	12,00,000

(ii)

	Amount (₹)
Division AD	
15,000 units of BRITE outside customer @ ₹150	22,50,000
5,000 units of BRITE Division CD @ ₹150	7,50,000
20,000 units of LITE (Limited to capacity) @ ₹20	4,00,000
Total contribution	34,00,000
Fixed expenses	20,00,000
Profit (A)	14,00,000
Division CD	
Extra cost of labour ₹50. Hence VC = 640 Hence, contribution = 700 – 640 = ₹60	
5,000 units @ ₹60 contribution	3,00,000
Fixed expenses	4,00,000
Profit (B)	(1,00,000)
Overall Profit (A + B)	13,00,000

(iii)

	Amount (₹)	Amount (₹)
Division AD		
15,000 units of BRITE outside customer @ ₹150		22,50,000
5,000 units of BRITE Division CD @ ₹100		5,00,000
20,000 units of LITE (Limited to capacity) @ ₹20		4,00,000
Total contribution		31,50,000
Fixed expenses		20,00,000
Profit (A)		11,50,000
Division CD		
BRITE from AD	250	
Labour and overhead	340	
Variable costs	590	
Contribution (₹700 – ₹590)	110 per unit	
5,000 unit @ ₹110		5,50,000
Fixed expenses		4,00,000
Profit (B)		1,50,000
Overall profit (A + B)		13,00,000



(iv)

	Amount (₹)
Division AD	
15,000 units of BRITE outside party @ ₹150	22,50,000
10,000 units of BRITE to CD @ ₹250 i.e. contribution @ ₹100	10,00,000
Total contribution	32,50,000
Fixed expenses	20,00,000
Profit (A)	12,50,000
Division CD	
Contribution on input from AD [10,000 × ₹(700-250-340)]	11,00,000
Contribution on imported material [2,000 × ₹(700-340-250)]	2,20,000
Total contribution	13,20,000
Fixed expenses (4,00,000 + 7,70,000)	11,70,000
Profit (B)	1,50,000
Overall Profit (A + B)	14,00,000

Alternative (ii) and (iii) is the same from company's point of view, profit is merely transferred from one division to other. In general import substitution has helped the company as a whole finding from (i) and (iii). Net transfer price of ₹250 per unit is fair to AD and it also does not harm CD because its profitability has not reduced. In fact to encourage CD to be an active member of import substitution the transfer price could be lower than ₹250 per unit so long it is not detrimental to the interest of AD i.e. as long as total profit remains above ₹10,50,000 in (i).

If CD increases its production and wants to utilise the capacity of AD with good product mix, the company will benefit. More production of BRITE at the cost of LITE will benefit AD and that has happened in alternative (iv). The total company profit is the highest but the condition of CD has not improved because of increase in fixed cost.



Study Note - 3

STANDARD COSTING IN PROFIT PLANNING



This Study Note includes

- 3.1 Variance Analysis
- 3.2 Uniform Costing in Profit Planning
- 3.3 Inter Firm Comparison

3.1 VARIANCE ANALYSIS

Introduction:

During the first stages of development of cost accounting, historical costing was the only method available for ascertaining and presenting costs. Historical costs have, however, the following limitations:

- (a) Historical cost is valid only for one accounting period, during which the particular manufacturing operation took place.
- (b) Data is obtained too late for price quotations and production planning.
- (c) Historical cost relating to one batch or lot of production is not a true guide for fixing price.
- (d) Past actual are affected by the level of working efficiencies.
- (e) Historical costing is comparatively expensive as it involves the maintenance of a large volume of records and forms.

The limitations and disadvantages attached to historical costing system led to further thinking on the subject and resulted in the emergence of **standard costing** which makes use of scientifically pre-determined standard costs under each element.

Definition:

Standard Costing is defined as "*the preparation and use of standard cost, their comparison with actual costs and the measurement and analysis of variances to their causes and points of incidence.*"

General Principles of Standard Costing:

1. Predetermination of technical data related to production. i.e., details of materials and labour operations required for each product, the quantum of inevitable losses, efficiencies expected, level of activity, etc.
2. Predetermination of standard costs in full details under each element of cost, viz., labour, material and overhead.
3. Comparison of the actual performance and costs with the standards and working out the variances, i.e., the differences between the actuals and the standards.
4. Analysis of the variances in order to determine the reasons for deviations of actuals from the standards.
5. Presentation of information to the appropriate level of management to enable suitable action (remedial measures or revision of the standards) being taken.

Difference between Standard Costing and Budgetary Control:

Like Budgetary Control, Standard Costing assume that costs are controllable along definite lines of supervision and responsibility and it aims at managerial control by comparison of actual performances with suitable predetermined yardsticks. The basic principles of cost control, viz., setting up of targets or standards, measurement of performance,



comparison of actual with the targets and analysis and reporting of variances are common to both standard costing and budgetary control systems. Both techniques are of importance in their respective fields are complementary to each other. Thus, conceptually there is not much of a difference between standard costs and budgeted and the terms budgeted performance and standard performance mean, for many concerns one and the same thing.

Budgets are usually based on past costs adjusted for anticipated future changes but standard costs are of help in the preparation of production costs budgets. In fact, standards are often indispensable in the establishment of budgets. On the other hand, while setting standard overhead rates of standard costing purposes, the budgets framed for the overhead costs may be made use of with modifications, if necessary. Thus, standard costs and budgets are interrelated but not inter-dependent.

Despite the similarity in the basic principles of Standard Costing and Budgetary Control, the two systems vary in scope and in the matter of detailed techniques. The difference may be summarized as follows:

1. A system of Budgetary Control may be operated even if no Standard Costing system is in use in the concern.
2. While standard is an unit concept, budget is a total concept.
3. Budgets are the ceilings or limits of expenses above which the actual expenditure should not normally rise; if it does, the planned profits will be reduced. Standards are minimum targets to be attained by actual performance at specified efficiency.
4. Budgets are complete in as much as they are framed for all the activities and functions of a concern such as production, purchase, selling and distribution, research and development, capital utilisation, etc. Standard Costing relates mainly to the function of production and the related manufacturing costs.
5. A more searching analysis of the variances from standards is necessary than in the case of variations from the budget.
6. Budgets are indices, adherence to which keeps a business out of difficulties. Standards are pointers to further possible improvements.

Advantages of Standard Costing:

The advantages derived from a system of standard costing are tabulated below:

1. Standard Costing system establishes yard-sticks against which the efficiency of actual performances is measured.
2. The standards provide incentive and motivation to work with greater effort and vigilance for achieving the standard. This increase efficiency and productivity all round.
3. At the very stage of setting the standards, simplification and standardisation of products, methods, and operations are effected and waste of time and materials is eliminated. This assists in managerial planning for efficient operation and benefits all the divisions of the concern.
4. Costing procedure is simplified. There is a reduction in paper work in accounting and less number of forms and records are required.
5. Cost are available with promptitude for various purposes like fixation of selling prices, pricing of inter-departmental transfers, ascertaining the value of costing stocks of work-in-progress and finished stock and determining idle capacity.
6. Standard Costing is an exercise in planning - it can be very easily fitted into and used for budgetary planning.
7. Standard Costing system facilities delegation of authority and fixation of responsibility for each department or individual. This also tones up the general organisation of the concern.
8. Variance analysis and reporting is based on the principles of management by exception. The top management may not be interested in details of actual performance but only in the variances form the standards, so that corrective measures may be taken in time.



9. When constantly reviewed, the standards provide means for achieving cost reduction.
10. Standard costs assist in performance analysis by providing ready means for preparation of information.
11. Production and pricing policies may be formulated in advance before production starts. This helps in prompt decision-making.
12. Standard costing facilitates the integration of accounts so that reconciliation between cost accounts and financial accounts may be eliminated.
13. Standard Costing optimizes the use of plant capacities, current assets and working capital.

Limitations of standard costing:

1. Establishment of standard costs is difficult in practice.
2. In course of time, sometimes even in a short period the standards become rigid.
3. Inaccurate, unreliable and out of date standards do more harm than benefit.
4. Sometimes, standards create adverse psychological effects. If the standard is set at high level, its non achievement would result in frustration and build-up of resistance.
5. Due to the play of random factors, variances cannot sometimes be properly explained, and it is difficult to distinguish between controllable and non-controllable expenses.
6. Standard costing may not sometimes be suitable for some small concerns. Where production cannot be carefully scheduled, frequent changes in production conditions result in variances. Detailed analysis of all of which would be meaningless, superfluous and costly.
7. Standard costing may not, sometimes, be suitable and costly in the case of industries dealing with non-standardized products and for repair jobs which keep on changing in accordance with customer's specifications.
8. Lack of interest in standard costing on the part of the management makes the system practically ineffective. This limitation, of course, applies equally in the case of any other system which the management does not accept wholeheartedly.

Standard Cost:

Standard Cost is defined as "*the predetermined cost that is calculated at the management's standards of efficient operations and the relevant necessary expenditure*".

From this we understand that it is the cost calculated when all the people working in the organisation to their utmost, the expenditure incurred for producing the product can be taken as standard cost. The optimum efficiency can not at all time exists. Therefore, optimum efficiency is assumed and that is why standard cost is called assumed cost. Further, all the inputs of cost scientifically analysed using so many industrial engineering techniques such as work measurement, method study, time and motion study, merit rating, job evaluation and other scientific techniques, it can also be called as Scientific Cost.

Standard Costs and Estimated Costs:

The distinction between Standard Costs and Estimated Costs should be clearly understood. While both Standard Costs and Estimated Costs are predetermined costs, their objectives are different. The main differences between the two types of costs are:

1. Estimated Costs are intended to determine what the costs 'will' be. Standard Costs aim at what costs 'should' be.
2. Estimated Costs are based on average of past actual figures adjusted for anticipated changes in future. Anticipated wastes, spoilage and inefficiencies, all of which tend to increase costs are included in estimated costs. Standard Costs are planned costs determined on a scientific basis and they are based upon certain assumed conditions of efficiency and other factors.



3. In Estimated Costing Systems, stress is not so much on cost control, but costs are used for other purposes such as fixation of prices to be quoted in advance. Standard Costs serve as effective tools for cost control.

Setting of Standard Costs:

While setting production costs standards, the following preliminaries should be considered:

- (a) Study of the technical and operational aspects of the concern, such as methods of manufacture and the processes involved, management of organisation and line of assignment of responsibilities, division of the organisation into cost centres, units of measurement of input and output, anticipation of wastes, rejections and losses, expected efficiency, and capacity likely to be utilized.
- (b) Review of the existing costing system and the cost records and forms in use.
- (c) The type of standard to be used, i.e, whether current, basic, or normal standard costs are to be set. The choice of a particular type of standard will depend upon two factors, viz. which type would be most effective for cost control in the organization, and whether the standards will be merged in the accounting system or kept outside the accounts as statistical data.
- (d) Proper classification of the accounts so that variances may be determined in the manner desired.
- (e) Fixation of responsibility for setting standards. As definite responsibility for variances from standards is ultimately to be laid on individuals or departments, it is but natural that all those individuals or departments should be associated with the setting of standards.

Stock Valuation:

The function of a Balance Sheet is to give a true and fair view of the state of affairs of a company on a particular date. A true and fair view also implies the consistent application of generally accepted principles. Stocks valued at standard costs are required to be adjusted at actual costs in the following circumstances:

- (a) As per Accounting Standards – 2, closing stock to be valued either at cost price or at net realisable value (NRV) whichever is less.
- (b) The standard costing system introduced is still in an experimental stage and the variances merely represent deviations from poorly set standards.
- (c) Occurrence of certain variances which are beyond the control of the management. (Unless the stocks are adjusted for uncontrollable factors, the values are not correctly stated).

Maintenance of Raw Material Stock at Standard Cost:

In the single plan, the inventory in the stores ledger may be carried either at standard costs or at actual. Although both the methods are in use, the consensus is in favour of standard costs. The advantages of adopting standard costs for inventory valuation are as follows:

- (a) Stores ledger may be maintained in quantities only and the standard price noted at the top in the ledger sheets. This economises the use of forms as well as reduces clerical costs as no columns for rates need be maintained.
- (b) Pricing of materials requisitions is simplified as only one standard price for each item of material is required to be used.
- (c) Price variance is promptly revealed at the time of purchase of material.

The disadvantages are:

- (a) The stores ledger does not reveal the current prices.
- (b) If the material stock is shown in the Balance Sheet at standard costs, the variances have the effect of distorting the profit or loss. Standard cost of the closing inventory is required to be adjusted to actual cost based on price variance to comply with the statutory requirement of the Companies Act, 2013.

(c) A revision of the standard necessitates revision of the cost of the inventory.

Variance Analysis

Variance Analysis is nothing but the differences between Standard Cost and Actual Cost. Of course, in ordinary language we call it difference; in statistics we call it deviations and in costing terminology we call it as variances. When Standard Costing is adopted, the standards are set for all the costs, revenue and profit, and if the difference in case of cost is more than the standard we call it adverse variance, symbolized (A) and if the difference is less than the standard, we call it favourable variance, symbolized (F). However, in case of sales and profit, if the standard is more than the actual it is adverse variance and if the standard is less than the actual it is favourable variance. From this we understand that variances can be calculated in all the elements of costs, sales and profit too.

An overview of Variance Analysis is shown as follows:

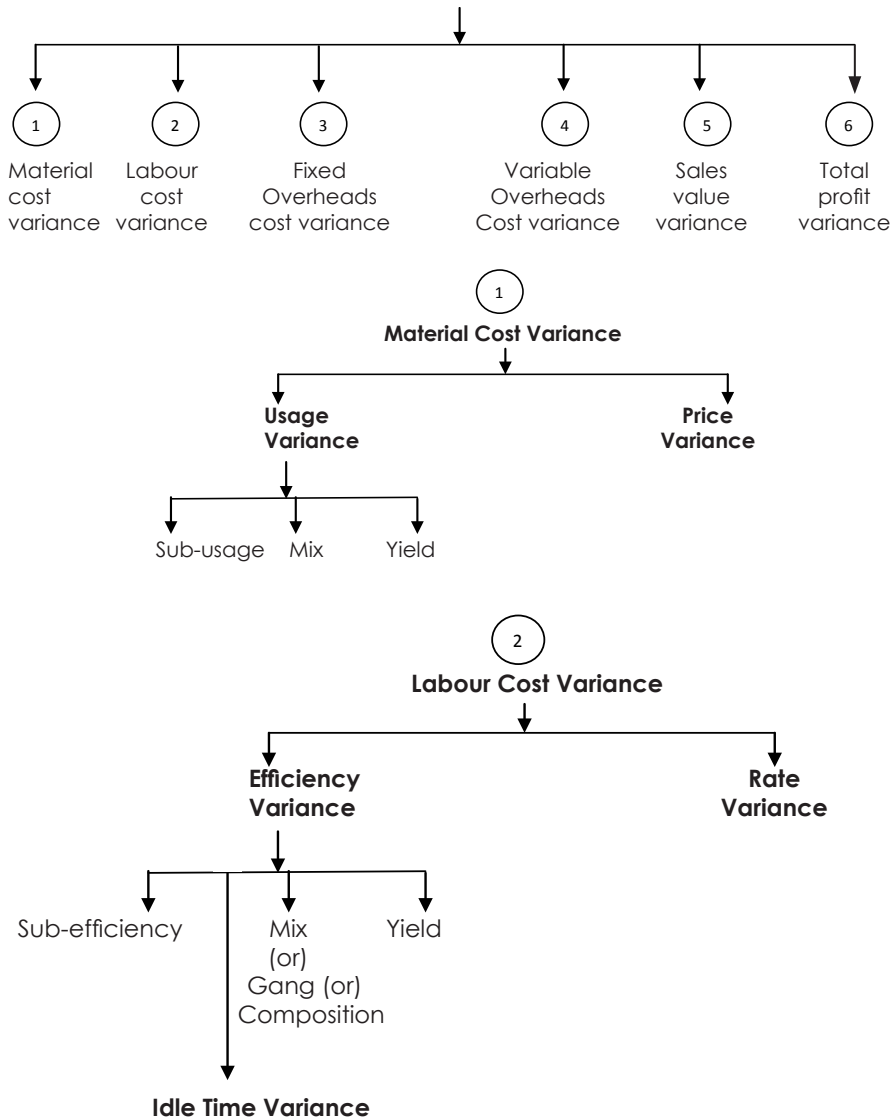

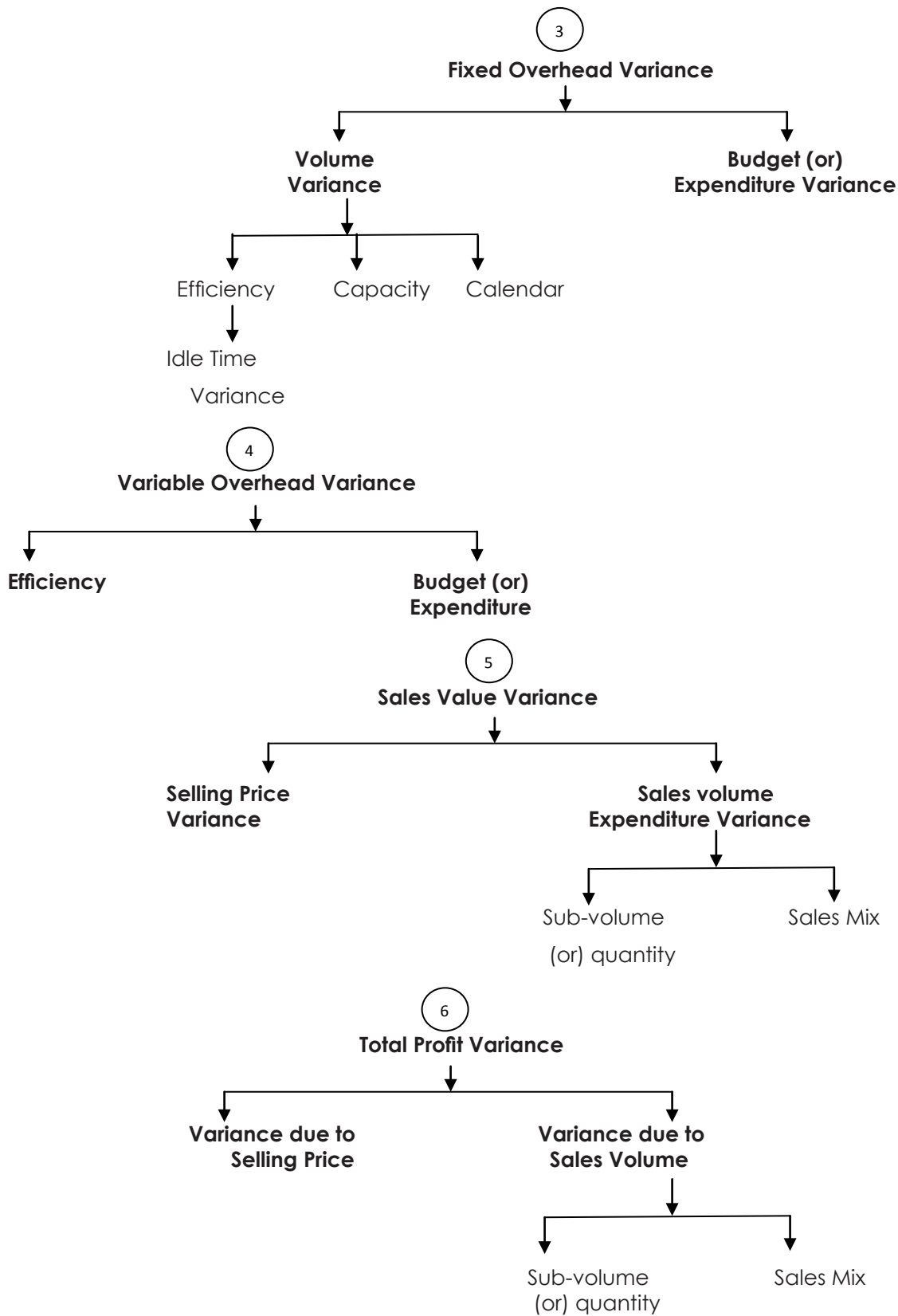



I. Material Variance:

1. **Direct Materials Cost Variance:** Direct materials cost variance is the difference between the actual direct material cost incurred and the standard direct material cost specified for the production achieved.

1. Direct Materials Price Variance: The difference between the actual and standard price per unit of the material applied to the actual quantity of material purchased or used.

Direct materials price variance = (Standard Price minus Actual Price) x Actual Quantity, or

$$= (SP-AP) AQ$$

$$= (\text{Standard Price} \times \text{Actual Quantity}) \text{ minus } (\text{Actual Price} \times \text{Actual Quantity})$$

$$= (AQSP-AQAP)$$

Causes of Material Price Variance:

- Change in basic purchase price of material.
- Change in quantity of purchase or uneconomical size of purchase order.
- Rush order to meet shortage of supply, or purchase in less or more favourable market.
- Failure to take advantage of off-season price, or failure to purchase when price is cheaper.
- Failure to obtain (or availability of) cash and trade discounts or change in the discount rates.
- Weak purchase organisation.
- Payment of excess or less freight.
- Transit losses and discrepancies, if purchase price is inflated to include the loss.
- Change in quality or specification of material purchased.
- Use of substitute material having a higher or lower unit price.
- Change in materials purchase, upkeep, and store-keeping cost. (This is applicable only when such changes are allocated to direct material costs on a predetermined or standard cost basis.)
- Change in the pattern or amounts of taxes and duties.

2. **Direct Materials Usage Variance:** The difference between the actual quantity used and the amount which should have been used, valued at standard price.

Direct materials usage variance = (Standard Quantity for actual output x Standard Price) minus (Standard Price x Actual Quantity)

$$= SQSP-AQSP \text{ or}$$

$$= \text{Standard Price} \times (\text{Standard Quantity for actual output} \text{ minus } \text{Actual Quantity})$$

$$= SP (SQ-AQ)$$

Causes of Materials Usage Variance:

- Variation in usage of materials due to inefficient or careless use, or economic use of materials.
- Change in specification or design of product.
- Inefficient and inadequate inspection of raw materials.
- Purchase of inferior materials or change in quality of materials
- Rigid technical specifications and strict inspection leading to more rejections which require more materials for rectification.
- Inefficiency in production resulting in wastages
- Use of substitute materials.



- h. Theft or pilferage of materials.
- i. Inefficient labour force leading to excessive utilisation of materials.
- j. Defective machines, tools, and equipments, and bad or improper maintenance leading to breakdowns and more usage of materials.
- k. Yield from materials in excess of or less than that provided as the standard yield.
- l. Faulty materials processing. Timber, for example, if not properly seasoned may be wasted while being used in subsequent processes.
- m. Accounting errors, e.g. when materials returned from shop or transferred from one job to another are not properly accounted for.
- n. Inaccurate standards
- o. Change in composition of a mixture of materials for a specified output.

(i) **Direct Materials Mix Variance:** One of the reasons for materials usage variance is the change in the composition of the materials mix. The difference between the actual quantity of material used and the standard proportion, priced at standard price.

$$\begin{aligned} \text{Mix variance} &= (\text{Revised Standard Quantity minus Actual Quantity}) \times \text{Standard Price.} \\ &= \text{RSQSP} - \text{AQSP} \end{aligned}$$

(ii) **Direct Materials Yield Variance:** Yield variance is the difference between the standard cost of production achieved and the actual total quantity of materials used, multiplied by the standard weighted average price per unit.

$$\text{Material yield variance} = (\text{Standard Yield for Actual Mix minus Actual Yield}) \times \text{Standard Yield Price}$$

(Standard yield price is obtained by dividing the total cost of the standard units by the total cost of the standard mixture by the total quantity (number of physical units).

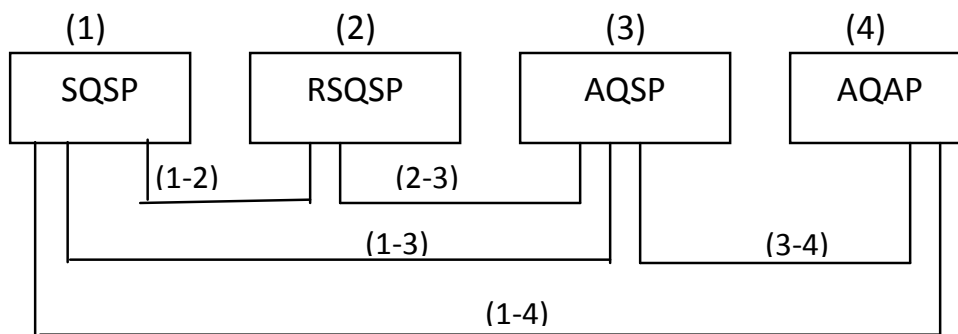

Where

SQ = Standard Quantity for Actual Production or Output

SP = Standard Price

AQ = Actual Quantity of Materials Consumed

AP = Actual Price

RSQ = Revised Standard Quantity

1. SQSP = Standard Cost of Standard Material

2. RSQSP = Revised Standard Cost of Standard Material



3. AQSP = Standard cost of Actual Material
4. AQAP = Actual Cost of Actual Material
 - (a) Material Sub-Usage or Yield Variance = 1-2
 - (b) Material Mix Variance = 2-3
 - (c) Material Usage Variance = 1-3
 - (d) Material Price Variance = 3-4
 - (e) Material Cost Variance = 1-4

II. Labour Variance:

Direct Labour Cost Variance: Direct Labour Cost Variance (also termed Direct Wage Variance) is the difference between the actual direct wages incurred and the standard direct wages specified for the activity achieved.

1. **Direct Labour Rate Variance (Wage Rate Variance):** The difference between the actual and standard wage rate per hour applied to the total hours worked.

Wages rate variance = (Standard Rate minus Actual Rate) x Actual Hours

$$= (SR-AR) \times AH$$

$$= SRAH-ARAH$$

Causes of Direct Labour Rate Variances:

- a. Change in basic wage structure or change in piece-work rate. These will give rise to a variance till such time the standards are not revised.
 - b. Employment of workers of grades and rates of pay different from those specified, due to shortage of labour of the proper category, or through mistake, or due to retention of surplus labour.
 - c. Payment of guaranteed wages to workers who are unable to earn their normal wages if such guaranteed wages form part of direct labour cost.
 - d. Use of a different method of payment, e.g. payment at day-rates while standards are based on piece-work method of remuneration.
 - e. Higher or lower rates paid to casual and temporary workers employed to meet seasonal demands, or urgent or special work.
 - f. New workers not being allowed full normal wage rates.
 - g. Overtime and night shift work in excess of or less than the standard, or where no provision has been made in the standard. This will be applicable only if overtime and shift differential payments form part of the direct labour cost.
 - h. The composition of a gang as regards the skill and rates of wages being different from that laid down in the standard.
2. **Direct Labour Efficiency Variance (also termed Labour Time Variance):** The difference between the standard hours which should have been worked and the hours actually worked, valued at the standard wage rate.

Direct Labour Efficiency Variance = (Standard Hours for Actual Production minus Actual Hours) x Standard Rate

$$= (SH-AH) \times SR$$

$$= SRSR-SRAH$$

Causes for Labour Efficiency Variance:

- a. Lack of proper supervision or strict supervision than specified.
- b. Poor working conditions.



- c. Delays due to waiting for materials, tools, instructions, etc. if not treated as idle time.
- d. Defective machines, tools and other equipments.
- e. Machine break-down, if not booked to idle time.
- f. Work on new machines requiring less time than provided for, till such time standard is not revised.
- g. Basic inefficiency of workers due to low morale, insufficient training, faulty instructions, incorrect scheduling of jobs, etc.
- h. Use of non-standard material requiring more or less operation time.
- i. Carrying out operations not provided for a booking them as direct wages.
- j. Incorrect standards
- k. Wrong selection of workers, i.e., not employing the right type of man for doing a job.
- l. Increase in labour turnover.
- m. Incorrect recording of performances, i.e., time or output.

i. Direct Labour Composition or Mix or Gang Variance: This is a sub-variance of labour efficiency variance. This variance arises due to change in the composition of a standard gang, or, combination of labour force

Mix or Gang or Composition Variance = (Actual Hours at Standard Rate of Standard Gang) minus (Actual Hours at Standard Rate of Actual Gang)

ii. Direct Labour Yield Variance: Just as material yield variance is calculated, similarly labour yield variance can also be known. It is the variation in labour cost on account of increase or decrease in yield or output as composed to the relative standard. The formula is –

$$\text{Direct Labour Yield Variance} = \text{Standard Cost Per Unit} \times \left[\frac{\text{Standard Output for Actual Mix} - \text{Actual Output}}{\text{Standard Output}} \right]$$

3. Idle time variance: This variance which forms a portion of wages efficiency variance, is represented by the standard cost of the actual hours for which the workers remain idle due to abnormal circumstances.

Idle time variance = (Standard rate x Actual hours paid for) minus (Standard rate x Actual hours worked) or
= Standard Rate x Idle Hours

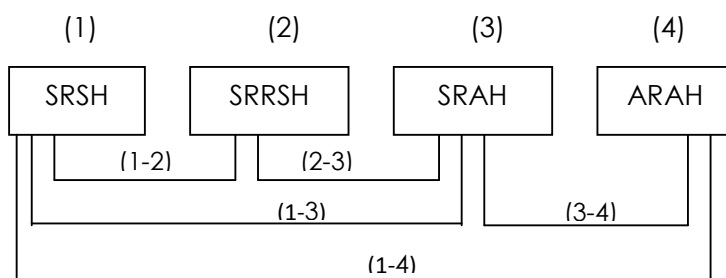

SR = Standard Rate of Labour Per Hour

SH = Standard Hours for Actual Production or Output

RSH = Revised Standard Hours

AH = Actual Hours

AR = Actual Rate of Labour per Hour



1. SRSH = Standard Cost of Standard Labour
2. SRRSH = Revised Standard Cost of Labour
3. SRAH = Standard Cost of Actual Labour
4. ARAH = Actual Cost of Labour
 - a. Labour Sub-Efficiency or Yield Variance = 1-2
 - b. Labour Mix or Gang or Composition Variance = 2-3
 - c. Labour Efficiency Variance = 1-3
 - d. Labour Rate Variance = 3-4
 - e. Labour Cost Variance = 1-4

Idle Time Variance = Idle Time Hours x Standard Rate per Hour.

It is to be noted that this is the part and parcel of efficiency ratio and always it is adverse.

III. Overhead Variance

Overhead Cost Variance: Overhead cost variance or Overall (or net) overhead variance is the difference between the actual overhead incurred and the overhead charged or applied into the job or process at the standard overhead rate.

1. Fixed Overhead Variance:

Fixed overhead cost variance is the difference between the standard cost of fixed overhead allowed for the actual output achieved and the actual fixed overhead cost incurred. The fixed overhead variance is analysed as below:

(i) Budget (or) Expenditure (or) Spending Variance:

Fixed overhead variance which arises due to the difference between the budgeted fixed overheads and the actual fixed overheads incurred during a particular period. It shows the efficiency in spending. Expenditure variance arises due to the following:

- Rise in general price level.
- Changes in production methods.
- Ineffective control.

Fixed Overhead Expenditure or Budget Variance = Budgeted Fixed Overhead – Actual Fixed Overhead

(ii) Volume Variance:

Fixed overhead volume variance is the difference between standard cost of fixed overhead allowed for actual output and the budgeted fixed overheads for the period. This variance shows the over (or) under absorption of fixed overheads during a particular period. If the actual output is more than the budgeted output then there will be over recovery of fixed overheads and volume variance will be favourable and vice-versa. This is so because fixed overheads are not expected to change with the change in output. Volume variance arises due to the following reasons:

- Poor efficiency of workers.
- Poor efficiency of machinery.
- Lack of orders.
- Shortage of power.
- Ineffective supervision.
- More or less working days.

Volume variance (Fixed Overhead) = Recovered Fixed Overhead – Budgeted Fixed Overhead

Volume variance can be further sub divided into three variances namely:

a. Capacity Variance:

It is that portion of the volume variance which is due to working at higher or lower capacity than the standard capacity. In other words, the variance is related to the under and over utilization of plant and equipment and arises due to idle time, strikes and lock-out, break down of the machinery, power failure, shortage of materials and labour, absenteeism, overtime, changes in number of shifts. In short, this variance arises due to more or less working hours than the budgeted working hours.

$$\begin{aligned} \text{Capacity Variance} &= \frac{\text{Standard Fixed Overhead Rate per hour}}{\text{Rate per hour}} \times \left[\text{Actual Hour Worked} - \text{Budgeted Hours} \right] \\ &\text{or} \\ &= \text{Standard Overhead} - \text{Budgeted Overheads} \end{aligned}$$

b. Calendar Variance:

It is that portion of the volume variance which is due to the difference between the number of working days in the budget period and the number of actual working days in the period to which the budget is applicable. If the actual working days are more than the budgeted working days the variance will be favourable and vice-versa if the actual working days are less than the budgeted days.

$$\text{Calendar Variance} = \frac{\text{Standard Rate Per Hour or Per Day}}{\text{Hour or Per Day}} \times \frac{\text{Excess or Deficit Hours or Days Worked}}{\text{Days Worked}}$$

c. Efficiency Variance:

It is that portion of the volume variance which is due to the difference between the budgeted efficiency of production and the actual efficiency achieved.

$$\begin{aligned} \text{Efficiency Variance} &= \frac{\text{Standard Fixed Overhead Rate per hour}}{\text{Rate per hour}} \times \left[\text{Standard Hour for Actual Production} - \text{Actual Hours} \right] \\ &\text{or} \\ &= \text{Recovered Fixed Overheads} - \text{Standard Fixed Overheads} \end{aligned}$$

Fixed Overhead Variances:

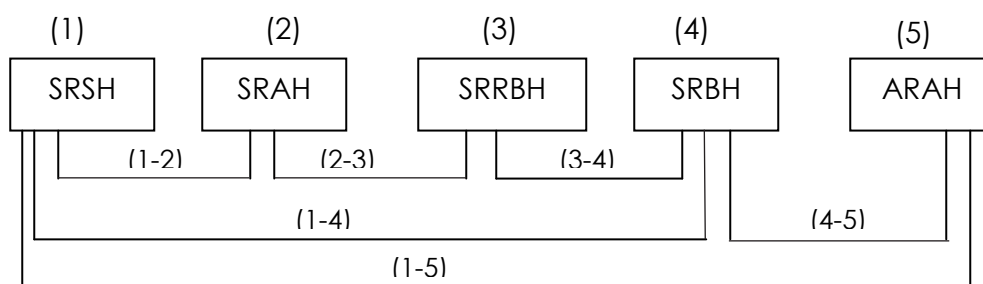

Where,

SR = Standard Rate of Fixed Overhead Per Hour

SH = Standard Hours for Actual Production or Output

AH = Actual Hours

RBH = Revised Budgeted Hours

BH = Budgeted Hours

AR = Actual Rate of Fixed Over Head per Hour

1. SRSH = Standard Cost of Standard Fixed Overhead



2. SRAH = Standard Cost of Actual Fixed Overhead or Fixed Overhead Absorbed or Recovered
3. SRRBH = Revised Budgeted Fixed Overhead
4. SRBH = Budgeted Fixed Overhead
5. ARAH = Actual Fixed Overhead
 - a. Fixed Overheads Efficiency Variance = 1-2
 - b. Fixed Overheads Capacity Variance = 2-3
 - c. Fixed Overhead Calendar Variance = 3-4
 - d. Fixed Overhead Volume Variance = 1-4
 - e. Fixed Overhead Budget or Expenditure Variance = 4-5
 - f. Fixed Overhead Cost Variance = 1-5

Note 1: - In the above values SR is found out in the following manner.

$$SR = \frac{BFO}{BH} \text{ (OR) } \frac{\text{Budgeted Fixed Overhead}}{\text{Budgeted Hours}}$$

Note 2: Fixed overhead variances can also be worked out using overhead rate per unit instead of rate per hour. In that event values and variances would be as follows:

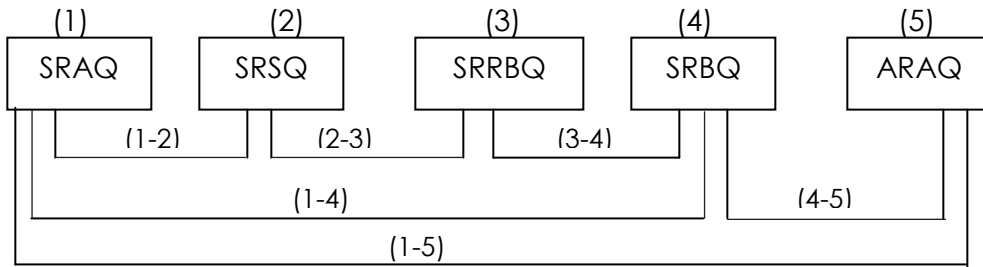

Where,

SR = Budgeted Fixed Overheads / Budgeted Quantity

1. SRSQ = Standard Cost of Standard Fixed Overhead
2. SRAQ = Standard Cost of Actual Fixed Overhead or Fixed Overhead Absorbed or Recovered
3. SRRBQ = Revised Budgeted Fixed Overhead
4. SRBQ = Budgeted Fixed Overhead
5. ARAQ = Actual Fixed Overhead
 - a. Fixed Overheads Efficiency Variance = 1-2
 - b. Fixed Overheads Capacity Variance = 2-3
 - c. Fixed Overhead Calendar Variance = 3-4
 - d. Fixed Overhead Volume Variance = 1-4
 - e. Fixed Overhead Budget or Expenditure Variance = 4-5
 - f. Fixed Overhead Cost Variance = 1-5

Note 3: Idle time variance in fixed overhead is part and parcel of efficiency variance and it is always adverse.



2. Variable overhead variance:

This is the difference between the standard variable overhead cost allowed for the actual output achieved and the actual variable overhead cost. The variance is represented by expenditure variance only because variable overhead cost will vary in proportion to output so that only a change in expenditure can cause such variance.

Sometimes, variable overhead efficiency variance can also be calculated just like labour efficiency variance. Variable overhead efficiency can be calculated if information relating to actual time taken and time allowed is given. In that event variable overhead variance can be divided into two parts.

- (i) Variable overhead efficiency variance.
- (ii) Variable overhead expenditure (or) budget (or) price variance.

Idle Time Variance = Idle Time Hours x Fixed Overhead Rate per Hour

- (i) **Efficiency Variance:** This variance is due to the difference between standard hours for actual output and the actual hours taken at the standard variable overhead rate. In other words, Variable Overhead Efficiency Variance is a measure of the extra overhead (or saving) incurred solely because direct labour usage exceeded (or was less than) the standard direct labour hours allowed.

Efficiency Variance = Standard Variable Overhead Rate per Hour × [Standard Hours for Actual production – Actual Hours]

= Recovered Variable overheads - Standards Variable Overheads

- (ii) **Expenditure or Budget or Price Variance:** This variance is due to the difference between standard variable overhead rate and actual variable overhead rate for the actual time taken. It is calculated on the pattern of Direct Labour rate Variance.

Expenditure Variance = Actual Time × [Standard Variable Overhead Rate per Hour – Actual Variable Overhead rate per hour]

= Standard Variable Overheads – Actual Variable overheads

IV. Sales Variance:

- (iii) **Sales Variance:** The analysis of variances will be complete only when the difference between the actual profit and standard profit is fully analysed. It is necessary to make an analysis of sales variances to have a complete analysis of profit variance, because profit is the difference between sales and cost. Thus, in addition to the analysis of cost variances i.e., material cost variance, labour cost variance and overhead variance, an analysis of sales variance should be made. Sales variances analysis may be categorized into two:

1. Sales Value (or) Revenue variance.
2. Sales Margin (or) Profit variance.

Sales Value Variance is the difference between the budgeted value of sales and the actual value of sales during a period. Sales Value Variance may arise due to the following reasons:

- Actual selling price may be higher or lower than the standard price.
- Actual quantity of goods sold may be more or less than the standard.
- Actual mix of the sales may be different than the standard mix.

Sales Margin Variance is the difference between the budgeted profit and actual profit and this is also the sum total of all variances. Sales Margin Variance may arise due to the following reasons:

- Raise in general price level.
- Unexpected competition.
- Ineffective sales promotion.

1. **Sales Value Variance:** The difference between budgeted sales and actual sales results in Sales Value Variance. If the actual sales are more than the budgeted sales, a favourable variance would be shown and vice versa.



The formula is:

Sales Value variance = Budgeted Sales – Actual Sales

- (i) **Price Variance:** This can be calculated just like Material Price Variance. It is an account of the difference in actual selling price and the standard selling price for actual quantity of sales. The formula for this is:

Price variance = Actual Quantity Sold × (Standard Price – Actual Price)

Or

= Standard Sales – Actual Sales

- (ii) **Volume Variance:** It can be computed as Material Usage Variance. Budgeted sales may be different from the standard sales. In other words, budgeted quantity of sales at standard prices may vary from the actual quantity of sales at standard prices. Thus, the variance is as a result of difference in budgeted and actual quantities of goods sold. The formula is:

Volume Variance = Standard Price × (Budgeted Quantity – Actual Quantity)

Or

= Budgeted Sales – Standard Sales

- (a) **Mix variance:** When more than one product is manufactured and sold, the budgeted sales of different products are in a given ratio. If the actual quantities sold are not in the same proportion as budgeted, it would cause a mix variance.

It can be calculated according to two methods:

- Based on Quantity: This method is followed on those cases where products are homogenous. In case the formula for calculating Sales Mix Variance is on the same pattern as is used in case of Material Mix Variance.

Mix Variance = Standard Price × (Revised Standard Quantity – Actual Quantity)

= Revised Standard Sales – Standard Sales

If actual quantity is more than the revised standard quantity, it will result in favourable variance or vice versa.

Revised Standard Quantity = $\frac{\text{Total Quantity of Actual Mix}}{\text{Total Quantity of Standard Mix}} \times \text{Standard Quantity}$

- Based on Value: This method is followed in those cases where products are not homogeneous. In such a case, the actual sales at standard prices, i.e. standard sales are to be expressed in budgeted ratios so as to calculate 'revised standard sales' and then is compared with the actual sales at standard prices. The formula is:

Mix Variance = Revised Standard Sales × Standard Sales

Revised Standard Sales = Budgeted Ratio of Sales × Standard Sales

Budgeted Ratio of Sales = $\frac{\text{Budgeted Sales Of a Product}}{\text{Total Budgeted Sales}}$

- (b) **Quantity Variance:** It is the difference between budgeted sales and the revised standard sales. The formula is:

Quantity variance = Budgeted Sales – Revised Standard Sales

Sales (or) Revenue Variances

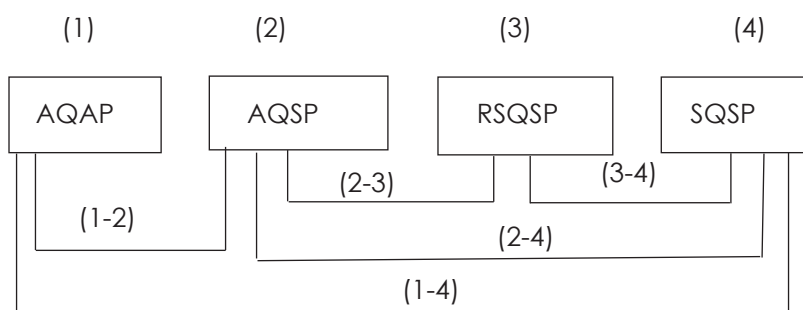

Where,

AQ = Actual Quantity Sold

AP = Actual Selling Price

SP (or) BP = Standard Selling Price (or) Budgeted Price

RSQ = Revised Standard Quantity

SQ (or) BQ = Standard (or) Budgeted Quantity

1. AQAP = Actual Sales
 2. AQSP = Actual Quantity of Sales at Standard Selling Prices.
 3. RSQSP = Revised Standard or Budgeted Sales.
 4. SQSP = Standard (or) Budgeted Sales.
- a. Sales Sub-Volume (or) Quantity Variance = 3-4
 - b. Sales Mix Variance = $\frac{2-3}{2}$
 - c. Sales Volume Variance = 2-4
 - d. Sales Price Variance = $\frac{1-2}{2}$
 - e. Total Sales Value Variance = 1-4

V. Profit Variance:

Profit Variance: This represents the difference between budgeted profit and actual profit. The formula is: Profit Variance = Budgeted Profit – Actual Profit

- (i) **Price Variance:** It shall be equal to the price variance calculated with reference to turnover. It represents the difference of standard and actual profit on actual volume of sales. The formula is:

$$\text{Price Variance} = \text{Standard Profit} - \text{Actual Profit}$$

Or

$$= \text{Actual Quantity Sold} \times (\text{Standard Profit per Unit} - \text{Actual Profit per Unit})$$

- (ii) **Volume Variance:** The profit at the standard rate on the difference between the standard and the actual volume of sales would be the amount of volume variance. The formula is:

$$\text{Volume Variance} = \text{Budgeted Profit} - \text{Standard profit}$$

Or

$$= \text{Standard Rate of Profit} \times (\text{Budgeted Quantity} - \text{Actual Quantity})$$



The Volume Variance can be divided into:

(a) Mix Variance: When more than one product is manufactured and sold, the difference in profit can result because of the variation of actual mix and budgeted mix of sales. The difference between revised standard profit and the standard profit, therefore is the mix variance. The formula is:

$$\text{Mix Variance} = \text{Revised Standard Profit} - \text{Standard Profit}$$

(b) Quantity Variance: It results from the variation in profit because of difference in actual quantities sold and the budgeted quantities both taken in the same ratio. The actual quantities are to be revised in the ratio of standard mixture. The formula is:

$$\text{Quantity Variance} = \text{Budgeted Profit} - \text{Revised Standard Profit}$$

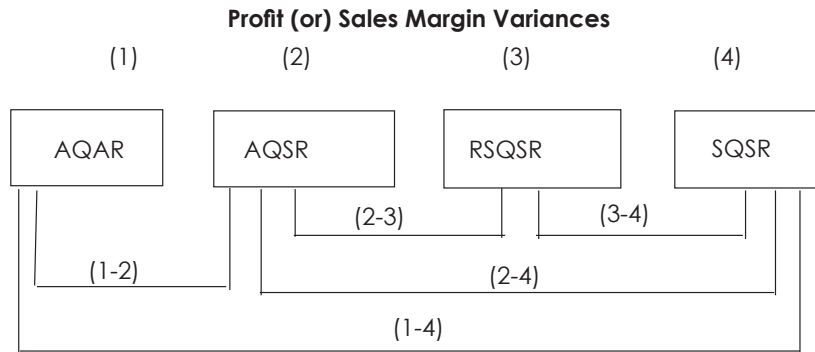

Where,

AQ = Actual Quantity Sold

AR = Actual Rate of Profit

SR (or) BR = Standard (or) Budgeted Rate of Profit

RSQ = Revised Standard Quantity

SQ (or) BQ = Standard (or) Budgeted Quantity

1. AQAR = Actual Profit
 2. AQSR = Actual Quantity of Sales at Standard Rate of Profit
 3. RSQSR = Revised Standard (or) Budgeted Profit
 4. SQSR = Standard (or) Budgeted Profit
- a. Profit Sub-Volume or Quantity Variance = 3-4
 - b. Profit Variance due to Sales Mix = 2-3
 - c. Profit Variance due to Sales Volume = 2-4
 - d. Profit Variance due to Selling Price = 1-2
 - e. Total Profit Variance = 1-4

Reporting of Variances:

In order that variance reporting should be effective, it is essential that the following *requisites* are fulfilled:

1. The variances arising out of each factor should be correctly segregated. If part of a variance due to one factor is wrongly attributed to or merged with that of another, the analysis report submitted to the management would be misleading and wrong conclusions may be drawn from it.



2. Variances, particularly the controllable variances should be reported with promptness as soon as they occur. Mere operation of Standard Costing and reporting of variances is of no avail. The success of a Standard Costing system depends on the extent of responsibility which the management assumes in correcting the conditions which cause variances from standard. In order to assist the management in assuming this responsibility, the variances should be reported frequently and on time. This would enable corrective action being taken for future production while work is in progress and before the project or job is completed.
3. For effective control, the line of organisation should be properly defined and the authority and responsibility of each individual should be laid down in clear terms. This will avoid 'passing on the buck' and shirking of responsibility and will enable the tracing of the causes of variances to the appropriate levels of management.
4. In certain cases, a particular variance may be the joint responsibility of more than one individual or department. It is obvious that if corrective action has to be effective in such cases, it should be taken jointly.
5. Analysis of uncontrollable variances should be made with the same care as for controllable variances. Though a particular variance may not be controllable at the lower level of management, a detailed analysis of the off-standard situation may reveal far reaching effects on the economy of the concern. This should compel the top management to take corrective action, say, by changing the policy which gave rise to the uncontrollable variance.

Forms of Variance Reports:

The forms of reports for the different types of variances should be designed keeping in view the needs of the management and the size of the concern, and no standard forms are, therefore, suggested. Variance Analysis Reports prepared for the top management would obviously be more formal and would contain broad details only, while those meant for presentation to the lower levels would contain details showing the causes of each variance and the specific responsibilities of the individuals concerned.

Variance Ratios and Cost Ratios:

We have so far considered the various cost variances in absolute monetary terms. Although these show the extent of the variances, the information is insufficient if the management wants to study the trend of variances from period to period. Absolute figures in themselves do not give the full picture and it is only by comparison of one item with another that their correct relationship is obtained. Variance Ratios serve this need and comparison of these ratios from one period to another can be gainfully made. Another advantage of Variance Ratio is in regard to its applicability in the dual plan of standard cost accounting. With the help of the Cost Variance Ratios, standard costs of production and the standard values of inventory can be easily converted into actual costs for the purpose of incorporation in the financial accounts.

A number of ratios are used for reporting to the management the effective use of capacity, material, labour and other resources of a concern. Some of these are considered below:

1. Efficiency Ratio.
2. Activity Ratio.
3. Calendar Ratio.
4. Capacity Usage Ratio
5. Capacity Utilization Ratio.
6. Idle Time Ratio.

1. **Efficiency Ratio:** It is the standard hours equivalent to the work produced, expressed as a percentage of the actual hours spent in producing that work.

$$\text{Efficiency Ratio} = \frac{(\text{Standard Hours})}{(\text{Actual Hours})} \times 100$$



2. **Activity Ratio:** It is the number of standard hours equivalent to the work produced, expressed as a percentage of the budgeted standard hours.

$$\text{Activity Ratio} = \frac{\text{Standard Hours for Actual Work}}{\text{Budgeted standard hours}} \times 100$$

3. **Calendar Ratio:** It is the relationship between the number of working days in a period and the number of working days in the relative budget period.

$$\text{Calendar Ratio} = \frac{\text{Available Working Days}}{\text{Budgeted Working Days}} \times 100$$

4. **Capacity Usage Ratio:** It is the relationship between the budgeted number of working hours and the maximum possible number of working hours in a budget period.

$$\text{Capacity Usage Ratio} = \frac{\text{Budgeted Hours}}{\text{Maximum Possible Hours in Budget Period}} \times 100$$

5. **Capacity Utilisation Ratio:** It is the relationship between actual hours in a budget period and the budgeted working hours in the period.

$$\text{Capacity Utilisation Ratio} = \frac{\text{Actual Hours}}{\text{Budgeted Hours}} \times 100$$

6. **Idle Time ratio:** It is the ratio of idle time hours to the total hours budgeted.

$$\text{Idle Time Ratio} = \frac{\text{Idle Time Hours}}{\text{Budgeted Hours}} \times 100$$

Treatment of Cost Variances in Accounts:

In Standard Cost Accounting Systems which contain both actual and standard costs in the accounting records and financial statements, the question of adjustment of the cost variances at the end of the accounting period arises. Three methods of disposal of variances and the advantages and disadvantages of each are discussed below:

1. Transfer to Profit and Loss Account.
2. Allocation of Variances to Finished Stock, Work-in-Progress and Cost of Sales Account.
3. Transfer of Variances to the Reserve Account.

1. Transfer to Profit and Loss Account:

In this method, the stocks of work-in-process and finished goods and cost of sales are maintained at standard costs and all variances are closed to the Profit and Loss Account at the end of the accounting period.

The opinions advanced in favour of transfer of variances to profit or loss are:

- a. Standard costs are considered to be the correct or real costs. Any variances from the standard costs should, therefore, be taken to mean deviations from the 'should be' costs due to the efficiencies or inefficiencies, abnormal activity, excessive or less spending etc. The variances cannot, therefore, be considered as the normal increases or decreases in costs and should be debited or credited to the Profit and Loss Account.
- b. The method ensures conservative inventory valuation as all extraneous factors like costs of inefficiencies, waste and losses are eliminated.
- c. Exclusion of variations makes gross profit for different periods comparable.
- d. Standard costs facilitate prompt inventory valuation.



- e. Variances separated out and reflected as profit or loss attracts the management's attention.
- f. Distribution of variances to product costs is difficult where a large number of diverse products is manufactured.

Some Accountants prefer to transfer only the debit variances, and credit variances are not credited to the Profit and Loss Account. Another practice is to adjust a proportionate part of the Material Price Variance to the closing stock of materials when price variance at the point of purchase is worked out.

2. Allocation of variances to Finished Stock, Work-in-Progress and Cost of Sales Account:

Under this method, the variances are distributed over stocks of finished and partly finished products and to the cost of sales. The distribution of each variance is made to the three accounts on a percentage basis according to the closing balance (value) of each account.

The opinions put forth in support of this method are, in brief, as follows:

- a. Standard costs are only tools of control and they do not represent true or correct costs. Only actual costs should, therefore, be reflected in the financial statements.
- b. Variances are not actual losses and as such, they should not be allowed to distort profits.
- c. Unless the standards are accurate and up-to-date, inventory valuation on the basis of standard costs will be inaccurate.
- d. Variances when credited to the Profit and Loss Account inflate the Work-in-Progress Account to the extent of the unrealized profit.

3. Transfer of variances to the Reserve Account:

In this method, the various costs variances are carried over to the subsequent financial year as deferred credits or charges. Thus, variance losses and gains may be set off against the gains and losses in the subsequent years. This method is not in common use but it might be useful in cases where seasonal fluctuations occur so that the favourable and adverse variances may cancel each other in a complete business cycle covering more than one financial year.

Investigation of Variances:

Since the analysis of variances costs money, not all variances are investigated, and management takes up only the significant variances for probing. As a common practice, minor deviations from budgets and standards and random or variances are not considered for investigation. A cost benefit analysis is necessary to decide whether or not an item should be taken up for detailed analysis and investigation. The costs of investigation consist of (i) cost of investigating a variance, and (ii) cost of action taken to correct the process and to bring it back in control. The benefit is represented by the cost of allowing the process to continue as it is, i. e. in an out-of-control state. Investigation is taken only if the cost of allowing the present state to continue exceeds the costs of investigation and correction.

Three different methods to decide whether a variance should be investigated are discussed in the following sections.

- (i) **Managerial intuition and judgment:** Most companies prescribe limits of variances expressed as, (i) absolute rupee amount, or (ii) percentage of budget amount, or both, as guidelines for investigation. Variances falling within the limits are considered to be in-control state and hence not investigated. Variances beyond the limits are out-of-control variances that need investigation. The practice in some companies is to prescribe such limits separately for each element of costs and for revenue.

The limits are not fixed arbitrarily but are based partly on historical experience and partly on intuition. The basic assumptions are that variances within the limits fixed will be in-control and that the costs of investigation of such variances and bringing back the process into control will be higher than the cost of allowing the present state to continue.

The intuition method is simple and inexpensive and though not statistically justified like the other two methods described below the limits, if fixed with proper care, may be reasonably accurate.



- (ii) **Expected Value method:** In this method, the probabilities of a variance being in out-of-control and in-control states are estimated and a payoff matrix is formed in the manner shown below:

Action	State	
	In-control	Out-of-control
Probability	P_1	P_2
Investigate, a_i	C_i	$C_i + C_c$
Do not investigate, a_0	0	C_b

P_1 = Probability associated with in-control state

P_2 = Probability associated with out-of-control state

C_i = Cost of investigation

C_c = Cost of bringing back the process in-control

C_b = Cost of allowing the out-of-control state to continue

a_i = Value of the action to investigate

a^0 = Value of action not to investigate

From the pay-off matrix, we find that,

Expected value, $a_i = P_1 C_i + P_2 (C_i + C_c)$, and

Expected value, $a^0 = P_1 \times 0 + P_2 C_b$,

If $a_i > a^0$, the decision will be not to investigate;

$a_i < a^0$, the decision will be to investigate ;

$a_i = a^0$, the management will be indifferent, i.e.

it is immaterial whether or not the variance is investigated.

When $a_i = a^0$, $P_1 C_i + P_2 (C_i + C_c) = P_2 C_b$.

But $P_1 + P_2 = 1$, or $P_1 = 1 - P_2$

Therefore, $(1 - P_2) C_i + P_2 (C_i + C_c) = P_2 C_b$

$$\text{or } P_2 = \frac{C_i}{C_b - C_c}$$

In the above situation, P_2 becomes the break-even probability which indicates that the decision will be to investigate only if the estimated probability of the out of - control state is greater than the break-even probability, viz.

$$\frac{C_i}{C_b - C_c}$$

This may be illustrated by assigning numerical values to the symbols. Let us assume that,

$C_i = ₹300$ $P_1 = 0.85$

$C_c = ₹2,000$ $P_2 = 0.15$

$C_b = ₹5,000$



The Break-even probability will be equal to

$$\frac{C_i}{C_b - C_c} = \frac{300}{5,000 - 2,000} = 0.10$$

Since P_2 (0.15) is higher than the break-even probability, the decision will be to investigate. This will be evident from the following, where $a_i < a_o$:

Expected value, $a_i = 0.85 \times 300 + 0.15 (300+2,000) = ₹600$

Expected value, $a_o = 0 + 0.15 \times 5,000 = ₹750$

The limitation of the expected value method arises mainly from the following: —

- (i) Estimation of the value of probability distribution for out-of-control state is difficult.
- (ii) It is difficult to calculate the value of C_b , the cost of allowing the out-of-control state to continue.
- (iii) **Statistical Control Chart method:** Statistical Quality Control is based on the concept that repetitive processes are subject to a certain amount of chance variability which has a stable pattern. A process is said to be in control if all measurements fall within this pattern of variability. Items outside the pattern are in out-of-control state needing investigation. Thus if we build up the parameters within which a standard or budgeted cost item should vary, we can find out whether a variance should or should not be investigated.

Illustration 1.

S.V.Ltd. Manufacturers by mixing three raw materials. For every batch of 100Kg. of BXE, 125 Kg. of raw Materials are used. In April, 1988, 60 batches were prepared to produce an output of 5,600 Kg. of BXE. The standard and actual particulars for April, 1988 are as under:

Raw material	Mix %	Price per kg	Mix %	Price per kg	Quantity of raw materials purchased kg
A	50	20	60	21	5,000
B	30	10	20	8	2,000
C	20	5	20	6	1,200

Calculate all variances.

Solution:

	Standard data			actual data		
	Q	P	V	Q	P	V
A	3750	20	75000	4500	21	94500
B	2250	10	22500	1500	8	12000
C	1500	5	7500	1500	6	9000
	60x125=7500		105000	7500		115500
(-)standard loss	60x25=1500			1900		
	6000		105000	5600		115500

	SQSP	RSQSP	AQSP	AQAP
A	3500x20		4500x20	
B	2100x10		1500x10	
C	1400x5		1500x5	



A	70000		90000	
B	21000		15000	
C	7000		75000	
Total	₹ 98000	₹ 105000	₹ 112500	₹ 115500

SQ FOR A = $5600/6000 \times 3750$, B = $5600/6000 \times 2250$, C = $5600/6000 \times 1500$

- Material price variance = ₹3000(A)
- Material mix variance = ₹ 7500(A)
- Material yield variance = ₹ 7000(A)
- material cost variance = ₹17500(A)

Illustration 2.

A brass foundry making castings which are transferred to the machine shop of the company at standards in regard to material stocks which are kept at standard price are as follows:-

Standard Mixture 70% Copper : 30% Zinc

Standard Price Copper ₹2,400 per ton

Zinc ₹ 650 per ton

Standard loss in melting 5% of input

Figures in respect of a costing period are as follows:

Commencing stocks	Copper	100 tons	
	Zinc	60 tons	
Finishing stocks	Copper	110 tons	
	Zinc	50 tons	
Purchases	Copper	300 tons	Cost ₹ 7,32,500
	Zinc	100 tons	Cost ₹ 62,500
Metal melted	400 tons		
Casting produced	375 tons		

Present figures showing: Material Price, Mixture and yield Variance.

Solution:

	Copper		Zinc	
	Q	V	Q	V
Opening stock	100	240000	60	39000
(+) purchases	300	732500	100	62500
	400	972500	160	101500
(-) closing stock	110	264000	50	32500
	290	708500	110	69000

	STANDARD			ACTUAL		
	Q	P	V	Q	P	V
Copper	280	2400	672000	290		708500
Zinc	120	650	78000	110		69000
	400		750000	400		777500
(-) standard loss @ 5%	20			25		
	380		750000	375		777500



	SQSP	RSQSP	AQSP	AQAP
copper	276.315x2400		290x2400	
zinc	118.42x650		110x650	
copper	663157		696000	
zinc	76975		71500	
total	740132	750000	767500	777500

Material yield variance = 9868(A)

- Material price variance=10000(A)
- Material mix variance=17500(A)

Illustration 3.

A company manufacturing a special type of fencing tile 12" × 8" × 1\2" used a system of standard costing. The standard mix of the compound used for making the tiles is:

1,200 kg. of material A @ ₹ 0.30 per kg.

500 kg. of Material B @ ₹ 0.60 per kg.

800 kg. of Material C @ ₹ 0.70 per kg.

The compound should produce 12,000 square feet of tiles of 1/2" thickness. During a period in which 1,00,000 tiles of the standard size were produced, the material usage was:-

Kg		₹
7,000	Material A @ ₹0.32 per kg.	2,240
3,000	Material B @ ₹0.65 per kg.	1,950
5,000	Material C @ ₹0.75 per kg.	3,750
15,000		7,940

Present the cost figures for the period showing Material price, Mixture, Sub-usage Variance.

Solution:

Area of tile = 12x8/12x12 = 2/3 sq ft

No of tiles that can be laid in 12000 sq ft is 12000/(2/3) = 18000

	Standard data			actual data		
	Q	P	V	Q	P	V
A	6666.67	0.3	2000	7000		2240
B	2777.77	0.6	16666.67	3000		1950
C	4444.44	0.7	3111.11	5000		3750
	13888.89		6778	15000		7940

Q for A = 18000/100000x1200 = 6666.67

Q for B = 18000/100000x500 = 2777.77

Q for C = 18000/100000x800 =4444.44



	SQSP	RSQSP	AQSP	AQAP
A		7200 x 0.3	7000 x 0.3	
B		3000 x 0.6	3000 x 0.6	
C		4800 x 0.7	5000 x 0.7	
A		2160	2100	
B		1800	1800	
C		3360	3500	
	₹ 6778	₹ 7320	₹ 7400	₹ 7940

RSQ for A = $(15000/13888.89) \times 666667$

- Material sub usage variance = ₹ 542(A)
- Material mix variance = ₹ 80(A)
- Material usage variance = ₹ 622(A)
- Material price variance = ₹ 540(A)
- Material cost variance = ₹ 1162(A)

Illustration 4.

The Standard labour complement and the actual labour complement engaged in a week for a job are as under:

	Skilled Workers	Semi-Skilled Workers	Unskilled Workers
(a) Standard No. of workers in the gang	32	12	6
(b) Standard wage rate per hour ₹	3	2	1
(c) Actual No. of workers employed in the gang during the week	28	18	4
(d) Actual wage rate per hour	₹4	₹ 3	₹ 2

During the 40 hour working week the gang produced 1,800 standard labour hours of work. CALCULATE:

- 1) Labour efficiency variance 2) Mix variance 3) Rate of wages variance 4) Labour cost variance

Solution:

	Standard data			Actual data		
	H	R	V	H	R	V
Skilled	1280	3	3840	1120	4	4480
semi skilled	480	2	960	720	3	2160
Unskilled	<u>240</u>	1	<u>240</u>	<u>160</u>	2	<u>320</u>
	2000		5040	2000		6960

	SRSH	SRRSH	SRAH	ARAH
Skilled	3 x 1152		3 x 1120	
Semi skilled	2 x 432		2 x 720	
Unskilled	<u>1 x 216</u>		<u>1 x 160</u>	
	₹ 4536	₹ 5040	₹ 4960	₹ 6960



SH for skilled workers = $(1800/2000) \times 1280 = 1152$

SH for semi-skilled workers = $(1800/2000) \times 480 = 452$

SH for unskilled workers = $(1800/2000) \times 240 = 216$

SRSB = Standard cost of standard labour = ₹ 4536

SRRSH = Revised standard cost of labour = ₹ 5040

SRAH = Standard cost of actual labour = ₹ 4960

ARAH = Actual cost labour = ₹ 6960

- Labour sub efficiency variance = ₹ 504(A)
- Labour mix variance = ₹ 80(F)
- Labour efficiency variance = ₹ 424(A)
- Labour rate variance = ₹ 2000(A)
- Labour cost variance = ₹ 2424(A)

Illustration 5.

Calculate variances from the following:

STANDARD				ACTUAL		
INPUT	MATERIAL	RS./KG	TOTAL	INPUT	RS.KG	TOTAL
400	A	@ 50	20,000	420	@ 45	18,900
200	B	@20	4,000	240	@ 25	6,000
100	C	@15	1,500	90	@15	1,350
700			25,500	750		26,250

LABOUR HOURS				LABOUR HOURS		
	100 @ ₹ 2 Per hour	200		120 Hrs. @ ₹2.50	300	
	200 Women @ ₹ 1.50	300	500	240 Women @ ₹ 1.60	384	684
25	Normal Loss			75	Actual Loss	
675			26,500	675		26,034

Solution:

Calculate of Material Variances:

	(1) SQSP	(2) RSQSP	(3) AQSP	(4) AQAP
A		428.57×50	420×50	
B		214.29×20	240×20	
C		107.14×15	90×15	
A		21429		
B		4289		
C		1607		
	₹ 25500	₹ 27325	₹ 27150	₹ 26250

RSQ for

A = $400/700 \times 750$

B = $200/700 \times 750$



$$C = 100/700 \times 750$$

- (1) SQSP = Standard Cost of Standard Material = ₹ 25,500
- (2) RSQSP= Revised Standard Cost of Material = ₹ 27,325
- (3) AQSP= Standard Cost of Actual Material = ₹ 27,150
- (4) AQAP= Actual Cost of Material = ₹ 26,250
- (a) Material yield variance (1-2) = ₹ 1825 (A)
- (b) Material mix variance (2-3) = ₹ 175 (F)
- (c) Material usage Variance (1-3) = ₹ 1650 (A)
- (d) Material price Variance (3-4) = ₹ 900 (F)
- (e) Material cost Variance (1-4) = ₹ 750 (A)

Calculation of Labour Variances:

	(1) SRSH	(2) SRRSH	(3) SRAH	(4) ARAH
Men		2 x 107.14	2 x 120	
Women		1.50 x 214.28	1.50 x 240	
Men		214.28	240	
Women		321.42	360	
	₹ 500	₹ 536	₹ 600	₹ 684

RSH for

$$\text{Men} = 100/700 \times 750$$

$$\text{Women} = 200/700 \times 750$$

- (1) SRSH = Standard Cost of Standard Labour = ₹ 500
- (2) SRRSH = Revised Standard Cost of Labour = ₹ 536
- (3) SRAH = Standard Cost of Actual Labour = ₹ 600
- (4) ARAH = Actual Cost of Labour = ₹ 684

- (a) Labour Yield Variance (1-2) = ₹ 36 (A)
- (b) Labour Mix variance (2-3) = ₹ 64 (A)
- (c) Labour efficiency Variance (1-3) = ₹ 100 (A)
- (d) Labour Rate Variance (3-4) = ₹ 84 (A)
- (e) Labour Cost Variance (1-4) = ₹ 184 (A)

Illustration 6.

Item	Budget	Actual
No.of working days	20	22
Output per man hour	1.0 Units	0.9 Units
Overhead cost	₹1,60,000	1,68,000
Man-hours per day	8,000	8,400

Calculate Overhead Variances.



Solution:

(1)	(2)	(3)	(4)	(5)
<u>SRSH</u>	<u>SRAH</u>	<u>SRRBH</u>	<u>SRBH</u>	<u>ARAH</u>
1 x 166320	1 x 184800	1 x 176000		
₹ 166320	₹ 184800	₹ 176000	₹ 160000	₹ 168000

- $SR = \text{budgeted FOH} / \text{budgeted hours} = 160000 / 160000 = 1$
 - $RBH = (22/20) \times 160000 = 176000$
 - $AH = 22 \times 8400 = 184800$
 - $AQ = 184800 \times 0.9 = 166320$
 - $SH = 166320 / 1 = 166320$
- (1) SRSH = Standard Cost of Standard Fixed Overheads = ₹ 1,66,320
- (2) SRAH = Standard Cost of Actual Fixed Overheads (or)
Fixed Overheads absorbed or recovered = ₹ 1,84,800
- (3) SRRBH = Revised budgeted Fixed overheads = ₹ 1,76,000
- (4) SRBH = Budgeted Fixed overheads = ₹ 1,60,000
- (5) ARAH = Actual Fixed Overheads = ₹ 1,68,000
- (a) FOH efficiency variance = 1-2 = ₹ 18480(A)
- (b) FOH capacity variance = 2-3 = ₹ 8800(F)
- (c) FOH calendar variance = 3-4 = ₹ 16000(F)
- (d) FOH volume variance = 1-4 = ₹ 6320(F)
- (e) FOH budget variance = 4-5 = ₹ 8000(A)
- (f) FOH cost variance = 1-5 = ₹ 1680(A)

Illustration 7.

One kilogram of product 'K' requires two chemicals A and B. The following were the details of product 'K' for the month of June, 2015:

- (a) Standard mix Chemical 'A' 50% and Chemical 'B' 50%
- (b) Standard price per kilogram of Chemical 'A' ₹12 and Chemical 'B' ₹15
- (c) Actual input of Chemical 'B' 70 kilograms.
- (d) Actual price per kilogram of Chemical 'A' ₹15
- (e) Standard normal loss 10% of total input.
- (f) Materials Cost variance total ₹650 adverse.
- (g) Materials Yield variance total ₹135 adverse.



You are required to calculate:

1. Materials mix variance total
2. Materials usage Variance total
3. Materials price variance total
4. Actual loss of actual input
5. Actual input of chemical 'A'
6. Actual price per kilogram of Chemical 'B'

Solution:

Let, actual input of chemical A be 'a' kgs

Actual price per Kg of chemical B be ₹ b

Standard input be 100Kgs

Actual output be 90Kgs

	Standard			Actual		
	Q	P	V	Q	P	V
A	50	12	600	a	15	15a
B	<u>50</u>	15	<u>750</u>	<u>70</u>	b	<u>70b</u>
	100		1350	70 + a		15a + 70b
(-) normal loss	<u>10</u>	--	--	<u>a - 20</u>	--	--
	90		1350	90		15a + 70b

	(1)	(2)	(3)	(4)
	SQSP	RSQSP	AQSP	AQAP
A		$12 \times (70+a/100) \times 50$	$12 \times a$	
B		$15 \times (70+a/100)/50$	15×70	
	1350	$945 + 13.5a$	$1050 + 12a$	$15a + 70b$

Given material cost variance = (1) – (4) = - 650

$$= 15a + 70b = ₹ 2000$$

Material yield variance = (1) – (2) = - 135

$$\Rightarrow a = 40$$

$$\Rightarrow b = 20$$

1) SQSP = ₹ 1350

2) RSQSP = $945 + (13.5 \times 40) = ₹ 1485$

3) AQSP = $1050 + (12 \times 40) = ₹ 1530$



- 4) $AQAP = (15 \times 40) + (70 \times 20) = ₹ 2000$
- (a) Material mix variance = ₹ 45(A)
 - (b) Material usage variance = ₹ 180(A)
 - (c) Material price variance = ₹ 470(A)
 - (d) Actual loss of actual input = 20 Kgs
 - (e) Actual input of chemical A = 40Kgs
 - (f) Actual price per Kgs of chemical B = ₹ 20

Illustration 8.

Compute the missing data indicated by the Question marks from the following.

	Product 'R'	Product 'S'
Sales quantity		
Std.(units)	?	400
Actual (Units)	500	?
Price (Unit)		
Standard	₹12	₹15
Actual	₹15	₹20
Sales price variance	?	?
Sales volume variance	₹ 1,200 F	?
Sales value variance	?	?

Sales mix variance for both the products together was ₹450 F, 'F' denotes Favourable.

Solution:

Let the standard units of product R be r

Actual units of product S be s

	Standard			Actual		
	Q	P	V	Q	P	V
R	R	12	12r	500	15	7500
S	400	15	6000	s	20	20s
	400 + r		6000 + 12r	500 + s		7500 + 20s

Given sales volume variance for R = ₹ 1200(F)

$$\Rightarrow AQSP - SQSP = ₹ 1200$$

$$r = ₹ 400$$

Sales mix variance = $AQSP - RSQSP = ₹ 450(F)$

	AQSP	RSQSP
R	12 x 500	12 x $\{(500+s)/(400+r)\} \times 400$
S	15 x s	12 x $\{(500+s)/(400+r)\} \times 400$
	6000 + 15s	6750 + 13.5s



Then $s = 800$

- Standard units of product R, $r = ₹ 400$
- Actual units of product S, $s = ₹ 800$
- Sales price variance for R = $AQ(AP - SP) = ₹ 1500(F)$
 $S = 4000(F)$
- Sales volume variance for S = $SP(AQ - SQ) = ₹ 6000(F)$
- Sales value variance for R = $AQAP - SQSP = ₹ 2700(F)$
 For S = ₹ 10000(F)

Illustration 9.

The assistant management accountant of your company has been preparing the profit and loss account for the week ended 31st October. Unfortunately, he has had a traffic accident and is now in a hospital, so as senior cost analyst you have been asked to complete this statement. The uncompleted statement and relevant data are shown below.

Week ended 31st October		
	₹	₹
Sales		50,000
Standard Cost:		
Direct materials		
Direct wages		
Overhead	—	—
Standard profit		
Variances	Fav./ (adv.)	Fav./ (adv.)
	₹	₹
Direct materials: Price	(400)	
Usage	(300)	
Total:		(700)
Direct Labour:		
Rate		
Efficiency		
Total		---
Overhead expenditure		
Volume		
Total	—	
Total variance		—
Actual Profit		—



Standard Data

The standard price of direct material used is ₹600 per ton. From each tone of material it is expected that 2,400 units will be produced. A forty hour week is operated. Standard labour rate per hour is ₹4. There are 60 employees working as direct labour.

The standard performance is that each employee should produce one unit of product in 3 minutes. There are 4 working weeks in October. The budgeted fixed overhead for October is ₹ 76,800.

Actual data

Materials used during the week were 20 tones at ₹620 per tone. During the week 4 employees were paid of ₹4.2 p.h and 6 were paid ₹3.8 p.h and Remaining were paid at Standard Rate Overheads incurred was ₹ 18000.

You are required to complete the P & L Statement for the week ended 31st Oct.

Solution:

Actual cost of material 620 x 20		₹ 12400/-
(-) direct material: price variance	400	
Usage variance	<u>300</u>	<u>(700)</u>
		<u>11700</u>

For ₹ 600/- production = 2400 units

For ₹ 11700/- production = (2400/600) x 11700 = 46800 units

Labour variances

(1)	(2)	(3)
SRSH	SRAH	ARAH
4 X 2340	4 x (40 x 60)	[(4 x 4.20) + (6 x 3.80) + (50 x 4)] 40
₹ 9360	₹ 9600	₹ 9584

Labour rate variance (2) – (3): 16(F)

Labour efficiency variance: (1) – (2): 240(A)

Overhead variances:

(1)	(2)	(3)	(4)
SRSH	SRAH	SRBH	ARAH
8 x 2340	8 x 2400		
₹ 18720	₹ 19200	₹ 19200	₹ 18000

OHs expenditure variance: (3) – (4): 1200(F)

OHs volume variance: (1) – (3): 480(A)

P&L statement for the week ended 31st October:

	₹	₹
Sales		50000
Standard cost		
direct material	11700	
direct wages	9360	
overheads	<u>18720</u>	<u>39780</u>



Standard profit			10220
Variances	F/(A)	F/(A)	
Direct material: price usage total	(400) (300)		
		(700)	
Direct labour:			
rate	16		
efficiency	(240)		
Total		(224)	
Overheads:			
Expenditure	1200		
Volume	(480)		
Total		720	
Total variance			<u>(204)</u>
Actual profit			10016

Illustration 10.

Standard Cost card of a product is as under:

Direct Materials:	₹
A. 2 Kg. @ ₹ 3 per kg.	6.00
B. 1 Kg. @ ₹ 4 Per Kg.	4.00
Direct wages 5 Hours @ ₹4 per hour	20.00
Variable overheads 5 hours @ ₹1 per hour	5.00
Fixed overheads 5 hours @ ₹2 per hour	<u>10.00</u>
Total:	45.00
Standard profit	<u>5.00</u>
Standard selling price	<u>50.00</u>

Budgeted out put are 8,000 units per month. In October 1989, the company produced 6,000 units.

The actual sales value was ₹ 3,05,000. Direct material consumed was Material A 14,850Kg valued at ₹ 43,065 and material B 7,260 kg valued at ₹29750. The total direct labour hours worked was 32,000 and the wages paid there fore amounted to ₹ 1,27,500. The direct labour hours actually booked on production was 31,800. Overheads recorded were: Fixed ₹ 80,600 and variable ₹ 30,000. Closing work in progress 600 units in respect of which materials A and B were fully issued and labour and overheads were 50%complete.

Analyse the variance and present an operating statement showing the reconciliation between budgeted and actual profit for the month in the following format:

Operating Statement	₹
Budgeted Profit	
Sales Margin Variances	
	Price
	Volume



	Total
Cost Variances	Direct Material
	Price
	Yield
	Mix
Direct Wages	Rate
	Efficiency
	Idle time
Variable overheads	Expenses
	Efficiency
Fixed Overheads	Expenses
	Efficiency
	Idle time
	Capacity

Total cost variance

Actual Profit.

Solution:

Sales margin or profit variances:

(1)	(2)	(3)
AQAR	AQSR	SQSR
6000 x (50.83 – 45)	6000 x 5	8000 x 5
₹ 35000	₹ 30000	₹ 40000

- a) Profit variance due to selling price = (1) – (2) = ₹ 5000(F)
- b) Profit variance due to sales volume = (2) – (3) = ₹ 10000(A)
- c) Profit value variance = (1) – (3) = ₹ 5000(A)

Material variances:

	Standard			Actual		
	Q	P	V	Q	P	V
A	13200	3	39600	14850		43065
B	6600	4	26400	7260		29750
	19800		66000	22110		72815

	SQSP	RSQSP	AQSP	AQAP
A		14740 x 3	14850 x 3	
B		7370 x 4	7260 x 4	
	66000	73700	73590	72815
(6000/6600) x	₹ 60000	₹ 67000	₹ 66900	₹ 66195

- a) Material yield variance: (1) – (2) = ₹ 7000(A)
 b) Material mix variance : (2) – (3) = ₹ 100(F)
 c) Material price variance : (3) – (4) = ₹ 705(F)

Labour variances:

	(1)	(2)	(3)
	SRSH	SRAH	ARAH
	4 x 31500	4 x 32000	
	126000	128000	127500
(6000/6300) x	₹ 120000	₹ 121905	₹ 121429

- a) Labour idle time variance : 200 x 4 = 800 (A)
 b) Labour rate variance: (2) – (3) = 476(F)
 c) Labour efficiency variance: 1905 – 800 = 1105 (A)

Variable overheads variances:

	(1)	(2)	(3)
	SRSH	SRAH	ARAH
	1 x 31500	1 x 31800	
	31500	31800	30000
(6000/6300) x	₹ 30000	₹ 30286	₹ 28571

- VOH efficiency variance: (1) – (2) = ₹ 286 (A)
 b) VOH budget variance : (2) – (3) = ₹ 1715(F)

Fixed overhead variance:

	(1)	(2)	(3)	(4)
	SRSH	SRAH	SRBH	ARAH
	2 x 31500	2 x 32000		
	63000	64000	80000	80600
(6000/6300) x	₹ 60000	₹ 60952	₹ 80000	₹ 76762

- a) FOH idle capacity variance: 200 x 2 = ₹ 400(A)
 b) FOH efficiency variance : 952 – 400 = ₹ 552 (A)



- c) FOH capacity variance = ₹ 19048 (A)
 d) FOH budget variance: ₹ 3238(F)

Operating statement showing reconstruction of budgeted and actual profit:

		₹
Budgeted profit		40000
Sales margin variance due to:		
Price	5000(F)	
Volume	<u>10000(A)</u>	<u>(5000)</u>
		<u>35000</u>
Cost variances		
Direct material variances:		
Price	705(F)	
Mix	100(F)	
Yield	7000(A)	(6195)
Direct wages variances:		
Rate	476(F)	
Efficiency	1105(A)	
Idle time	800(A)	(1429)
Variable OHs variances:		
Expenditure	1715(F)	
Efficiency	286(A)	1429
Fixed OHs variances:		
Efficiency	552(A)	
Expenditure	3238(F)	
Idle time	400(A)	
Capacity	19048(A)	(16762)
Actual profit		12043

Illustration 11.

The summarised results of a company for the two years ended 31st December 2014 and 2015 are given below: -

	2015	2014
	₹ lacs	₹ lacs
Sales	770	600
Direct Materials	324	300
Direct Wages	137	120
Variable Overheads	69	60
Fixed Overheads	150	80
Profit	90	40



As a result of re-organisation of production methods and extensive advertisement campaign use, the company was able to secure an increase in the selling prices by 10% during the year 2015 as compared to the previous year.

In the year 2014, the company consumed 1,20,000 Kgs. of raw materials and used 24,00,000 hours of direct labour. In the year 2015, the corresponding figures were 1,35,000kgs. of raw materials and 26,00,000 hours of direct labour.

You are required to:

Use information given for the year 2014 as the base year information to analyse the results of the year 2015 and to show in a form suitable to the management the amount each factor has contributed by way of price, usage and volume to the change in profit in 2015.

Solution:

A. Sales Variance

- 1) Sales price variance = $770 - \{770 \times (100/110)\} = ₹ 70(F)$
- 2) Sales volume variance = $\{770 \times (100/110)\} - 600 = ₹ 100(F)$
% increase in volume = $(100/600) \times 100 = ₹ 16.67\%$
- 3) Sales Value variance = $770 - 600 = ₹ 170(F)$

B. Material Variance

Material price = $(30000000)/120000 = ₹ 250/-$

Material expected to be used = $(120000/600) \times 700 = 140000$ Kgs

Standard Material Cost = $140000 \times ₹ 250 = ₹ 350$ Lacs

- 4) Material cost variance = $350 - 324 = ₹ 26 (F)$
- 5) Material volume variance = $300 \times (1/6) = ₹ 50(A)$
- 6) Material usage variance = $5000 \times 250 = ₹ 12.5 (F)$
- 7) Material price variance = $(250 - 240) \times 135000 = ₹ 13.5 (F)$

C. Labour Variance

Labour hours expected to be used = $(2400000/600) \times 700 = 2800000$

Labour rate = $(12000000)/(2400000) = ₹ 5/-$

Standard Labour Cost = $2800000 \times ₹ 5 = ₹ 140$ Lacs

- 8) Labour cost variance = $₹ 140 - ₹ 137 = ₹ 3 (F)$
- 9) Labour volume variance = $120/6 = ₹ 20(A)$
- 10) Labour efficiency variance = $2 \times 5 = ₹ 10 (F)$
- 11) Labour rate variance = $20 - 3 - 10 = ₹ 7 (A)$

D. Overhead Variance

Standard variable overheads = $₹ 60 + (₹ 60 \times 16.67\%) = ₹ 70$

Standard variable overheads rate per hour = $₹ 60 / 24 = ₹ 2.5$

- 12) VOH cost variance = $70 - 69 = ₹ 1(F)$
- 13) VOH volume variance = $60/6 = ₹ 10(A)$
- 14) VOH efficiency variance = $200000 \times 2.5 = ₹ 5 (F)$
- 15) VOH expenditure variance = $10 - 1 - 5 = ₹ 4(A)$
- 16) FOH cost variance = $₹ 70(A)$



Profit reconciliation statement:

		Rs in lakhs
Profit for 1987		40
(+)sales variance:		
Price	70	
Volume	100	
Material variance:		
Usage	12.50	
Price	13.50	
Labour variance-efficiency	10	
VOH efficiency variance	<u>5</u>	<u>211</u>
		251
(-) material volume variance	50	
Labour variance:		
Volume	20	
Rate	7	
VOH variances:		
Volume	10	
Expenditure	4	
FOH cost variance	70	<u>161</u>
Profit for 1988		<u>90</u>

Illustration 12.

The following data have been obtained from the records of a machine shop for an average month:

	Budget
No.of working days	25
Working hours per day	8
No.of direct workers	16
Efficiency	One standard hour per clock hour
Down time	20%
Fixed	₹ 15,360
Variable	20,480

The actual data for the month of September 1985 are as under:

Overheads: Fixed	16,500
Variable	14,500
Net operator hours worked	1,920
Standard hours produced	2,112

There was a special holiday in September 2015. Required to present reports to Departmental Manager:

- (i) Showing the three cost ratios you have chosen: (ii) Setting out the analysis of variances.



Solution:

(i) Cost Ratios:

- Efficiency ratio = $(SH/AH) \times 100 = (2112/1920) \times 100 = 110\%$
- Activity ratio = $(SH/BH) \times 100 = (2112/2560) \times 100 = 82.5\%$
- Capacity utilization ratio = $(\text{actual hours}/\text{budgeted hours}) \times 100$
 $= (1920/2560) \times 100 = 75\%$
- Capacity usage ratio = $(\text{budgeted hours}/\text{maximum possible hours}) \times 100$
 $= (2560/3200) \times 100 = 80\%$
- Idle capacity ratio = $100\% - 80\% = 20\%$
- Calendar ratio = $(\text{actual days}/\text{budgeted days}) \times 100$
 $= (24/25) \times 100 = 96\%$

(ii) Analysis of Variances

Variable OHs:

(1)	(2)	(3)
SRSH	SRAH	ARAH
8 x 2112	8 x 1920	
₹ 16896	₹ 15360	₹ 14500

- VOH efficiency variance = ₹ 1536(F)
- VOH budget variance = ₹ 860(F)
- VOH cost variance = ₹ 2396(F)

Fixed OHs:

(1)	(2)	(3)	(4)	(5)
SRSH	SRAH	SRRBH	SRBH	ARAH
6 x 2112	6 x 1920	6 x 2457.6		
₹ 12672	₹ 11520	₹ 14746	₹ 15360	₹ 16500

- (1) SRSH = Standard Cost of Standard Fixed Overheads = ₹ 12,672
- (2) SRAH = Standard Cost of Actual Fixed Overheads (or)
 Fixed Overheads absorbed or recovered = ₹ 11,520
- (3) SRRBH = Revised budgeted Fixed overheads = ₹ 14,746
- (4) SRBH = Budgeted Fixed overheads = ₹ 15,360
- (5) ARAH = Actual Fixed Overheads = ₹ 16,500
 - (a) FOH efficiency variance = 1-2 = ₹ 1,152(F)
 - (b) FOH capacity variance = 2-3 = ₹ 3,226(A)
 - (c) FOH calendar variance = 3-4 = ₹ 614(A)
 - (d) FOH volume variance = 1-4 = ₹ 2,688(A)
 - (e) FOH budget variance = 4-5 = ₹ 1,140(A)
 - (f) FOH cost variance = 1-5 = ₹ 3,828(A)



Illustration 13.

The standard cost sheet per unit for the product produced by Modern Manufactures is worked out on this basis.

Direct materials 1.3 tons @ ₹4 per ton

Direct labour 2.9 hours @ 2.3 per hour

Factory overhead 2.9 hours @ ₹2 per hour

Normal capacity is 2,00,000 direct labour hours per month.

The factory overhead rate is arrived at on the basis of a fixed overhead of ₹1,00,000 per month and a variable overhead of ₹1.50 per direct labourhour.

In the month May,50,000 units of the product was started and completed. An investigation of the raw material inventory account reveals that 78,000 tons of raw material were transferred into and used by the factory during May. These goods cost ₹4.20 per ton. 1,50,000 hours of direct labour were spent during May at cost of ₹2.50 per hour. Factory overhead for the month amounted to ₹3,40,000 of which 1,02,000 was fixed.

Compute and identify all variances under Material, Labour and Overhead as favourable or adverse. Also identify one or more departments in the Co. who might be held responsible for each variance.

Solution:

Calculation of Material Variance:

(1)	(2)	(3)
SQSP	AQSP	AQAP
65000 x 4	78000 x 4	78000 x 4.20
260000	312000	327600

SQ = 50000 x 1.3 = 65000 units

- (a) Material usage variance (1-2) = ₹ 52000 (A)
- (b) Material Price Variance (2-3) = ₹ 15600 (A)
- (c) Material Cost Variance (1-3) = ₹ 67600 (A)

Calculation of Labour Variances:

(1)	(2)	(3)
SRSH	SRAH	ARAH
2.3 x 145000	2.3 x 150000	2.50 x 150000
₹ 333500	₹ 345000	₹ 375000

SH = 50000 x 2.90 = 145000

50000 = Actual Production

- (1) SRSH = Standard Cost of Standard Labour = ₹ 3,33,500
- (2) SRAH = Standard Cost of Actual Labour = ₹ 3,45,000
- (3) ARAH = Actual Cost of Labour = ₹ 3,75,000
- (a) Labour efficiency Variance (1-2) = ₹11500 (A)
- (b) Labour Rate Variance (2-3) = ₹30000 (A)
- (c) Labour Cost Variance (1-3) = ₹41500 (A)

Calculation of Variable Overhead Variances:

(1)	(2)	(3)
SRSH	SRAH	ARAH
1.5×145000	1.5×150000	
₹ 217500	₹ 225000	₹ 238000 (340000 – 102000)

- (a) Variable Overhead efficiency Variance (1-2) = ₹ 7500 (A)
 (b) Variable Overhead Budget/exp. Variance (2-3) = ₹ 13000 (A)
 (c) Variable Overhead Cost Variance (1-3) = ₹ 20500 (A)

Calculation of Fixed Overhead Variances:

(1)	(2)	(3)	(4)
SRSH	SRAH	SRBH	ARAH
0.5×145000	0.5×150000		
₹ 72500	₹ 75000	₹ 100000	₹ 102000

- Fixed Overhead efficiency Variance (1-2) = ₹ 2500 (A)
 (b) Fixed Overhead Capacity Variance (2-3) = ₹ 25000 (A)
 (c) Fixed Overhead Volume Variance (1-3) = ₹ 27500 (A)
 (d) Fixed Overhead Budget/Exp Variance (3-4) = ₹ 2000 (A)
 (e) Fixed Overhead Cost Variance (1-4) = ₹ 29500 (A)

Illustration 14.

Budgeted and actual sales for the month of December, 2005 of two products A and B of M/s. XY Ltd. were as follows:

PRODUCT	BUDGETED UNITS	SALES PRICE/UNIT	ACTUAL UNITS	SALES PRICE / UNIT (₹)
A	6,000	₹ 5	5,000	5.00
			1,500	4.75
B	10,000	₹ 2	7,500	2.00
			1,750	8.50

Budgeted costs for Products A and B were ₹4.00 and ₹ 1.50 unit respectively. Work out from the above data the following variances.

Sales Volume Variance, Sales Value Variance, Sales Price Variance, Sales Sub Volume Variance, Sales Mix Variance.

Solution:

	SQSP	AQSP	RSQSP	AQAP
A	5000×5.00	6500×5	5906.25×5	6000×5
	1500×4.75			
B	7500×2.00			
	1750×1.90	9250×2	9843.75×2	10000×2



A	25000	32500	29531.25	30000
	7125			
B	15000			
	3325	18500	19687.5	20000
	₹50450	₹51000	₹49219	₹50000

Revised Standard Quantity for

$$A = 6000/16000 \times 15750 = 5906.25 \text{ units}$$

$$B = 10000/16000 \times 15750 = 9843.75 \text{ units}$$

- 1) AQAP = Actual Sales or Actual Quality Sold = ₹50450
- 2) AQSP = Actual Quantity of Sales at Standard Price = ₹51000
- 3) RSQSP = Revised Budgeted or standard Sales = ₹49219
- 4) SQSP = Standard or Budgeted Sales = ₹50000
 - a) Sales Sub usage variance = 3-4 = ₹781 (A)
 - b) Sales Mix Variance = 2-3 = ₹1781 (F)
 - c) Sales Volume Variance = 2-4 = ₹1000 (F)
 - d) Sales Price Variance = 1-2 = ₹550 (A)
 - e) Sales Value Variance = 1-4 = ₹450 (F)

Illustration 15.

	₹ In lakhs	
	31-3-2014	31-3-2015
	₹	₹
Sales	120	129.6
Prime cost of sales	80	91.1
Variable Overheads	20	24.0
Fixed expenses	15	18.5
PROFIT	5	(4.0)

During 2014-15, average prices increased over these of the previous years

(1) 20% in case of sales (2) 15% in case of prime cost (3) 10% in case of Overheads.

Prepare a profit variance statement from the above data.

Solution:

Calculation of variances:

- 1) Sales price Variance : $129.60 - (129.60 \times 100/120) = ₹21.60$ (F)
- 2) Sales Volume Variance : $(129.60 \times 100/120) = ₹ 12$ (A)



- 3) Sales Value Variance : $129.60 - 120 = ₹9.60$ (F)
 Decrease in volume = $\frac{12}{120} \times 100 = 10\%$
- 4) Prime Cost price Variance : $(91.10 \times 100/115) - 91.10 = ₹11.88$ (A)
- 5) Prime Cost Volume Variance = $80 \times 10/100 = ₹8$ (F)
- 6) Prime Cost Usage or efficiency Variance = $(80 \times 90/100) - (91.10 \times 100/115) = ₹7.22$ (A)
- 7) Prime Cost Variance : $80 - 90.1 = ₹11.1$ (A)
- 8) Variable Overhead Price Variance = $(24 \times 100/110) - 24 = ₹2.18$ (A)
- 9) Variable Overhead Volume Variance = $20 \times 10/100 = ₹2$ (F)
- 10) Variable Overhead Efficiency Variance = $(20 \times 90/100) - (24 \times 100/110) = ₹3.82$ (A)
- 11) Variable Overhead Cost Variance = $20 - 24 = ₹4$ (A)
- 12) Fixed Overhead Price Variance = $(18.50 \times 100/110) - 18.50 = ₹1.68$ (A)
- 13) Fixed Overhead Efficiency Variance = $15 - (18.50 \times 100/110) = ₹1.82$ (A)
- 14) Fixed Overhead Cost Variance = $15 - 18.50 = ₹3.5$ (A)

Profit Variance Statement:

		₹
Budgeted Profit		5.00
Add: Sales Price Variance	21.60	
Prime Cost Variance	8.00	
Variable Overhead Variance	2.00	31.60
		36.60
Less: Sales Volume Variance	12.00	
Price Cost Price Variance	11.88	
Price Cost usage Variance	7.22	
Variable Overhead Price Variance	2.18	
Variable Overhead Efficiency Variance	3.82	
Fixed Overhead Price Variance	1.68	
Fixed Overhead Efficiency Variance	1.82	40.60
Actual Loss		4.00

**Illustration 16.**

ABC Ltd; adopts a standard costing system. The standard output for a period is 20,000 units and the standard cost and profit per unit is as under:

	₹
Direct Material (3 units @ ₹1.50)	4.50
Direct Labour (3 Hrs. @ Re.1.00)	3.00
Direct Expenses	0.50
Factory Overheads : Variable	0.25
Fixed	0.30
Administration Overheads	0.30
TOTAL COST	8.85
PROFIT	1.15
SELLING PRICE (FIXED BY GOVERNMENT)	10.00

The actual production and sales for a period was 14,400 units. There has been no price revision by the Government during the period.

The following are the variances worked out at the end of the period.

Direct Material		Favourable (₹)	Adverse (₹)
	Price		4,250
	Usage	1,050	
Direct labour			
	Rate		4,000
	Efficiency	3,200	
Factory Overheads			
	Variable – Expenditure	400	
	Fixed – Expenditure	400	
	Fixed – Volume		1,680
Administration Overheads			
	Expenditure		400
	Volume		1,600

You are required to:

- Ascertain the details of actual costs and prepare a Profit and Loss Statement for the period showing the actual Profit/Loss. Show working clearly.
- Reconcile the actual Profit with standard profit.

Solution:**Statement Showing the actual profit and loss statement:**

Particulars	Amount	Amount
	₹	₹
Standard Material Cost (14400 x 4.50)	64800	
Add: Price Variance	4250	
Less: Usage Variance	(1050)	68000
Standard Labour Cost (14400 x 3)	43200	
Add: Rate Variance	4000	
Less: Efficiency Variance	(3200)	44000
Direct Expenses (14400 x 0.50)		7200



Factory Overhead:		
Variable (14400 x 0.25)	3600	
Less: Expenditure Variance	(400)	3200
Fixed (14400 x 0.30)	4320	
Add: Volume Variance	1680	
Less: Expenditure Variance	(400)	5600
Administration Overhead (14400 x 0.3)	4320	
Add: Volume Variance	1680	
Add: Exp. Variance	400	6400
Total Cost		134400
Profit (B/F)		9600
Sales		144000

(c) Statement showing reconciliation of standard profit with actual profit

Particulars	Amount	Amount
	₹	₹
Standard Profit (14400 x 1.15)		16560
Add: Material usage variance	1050	
Labour efficiency Variance	3200	
Variable Overhead expenditure variance	400	
Fixed Overhead expenditure variance	400	5050
		21610
Less: Material price variance	4250	
Labour Rate Variance	4000	
Fixed Overhead volume variance	1680	
Administration Expenditure Variance	400	
Administration Volume Variance	1680	12010
Actual Profit		9600

Illustration 17.

You have been appointed as Management Accountant of S.M. Ltd. Given below is the Company's operating profit and loss Statement for the month of April, 2015.

	Standard and Variances	Actual
	₹	₹
Budgeted Sales:	90,000	
Variances due to Volume of Orders	5,000	
Selling prices	2,000	97,000
Budgeted profit	19,000	
Profit Variance due to Sales Volume	1,200	
Profit variance due to Selling price	2,000	22,200



<u>Production cost Variances:</u>		
<u>Materials</u>		
Price	750	
Usage	(300)	450
<u>Labour</u>		
Rate	(1,250)	
Efficiency	(500)	(1,750)
<u>Overheads Expenditure: Fixed</u>		
Variable	(1,250)	
Efficiency	1,000	
Capacity	500	750
Operating Profit		21,650

The costing department provides you with the following information about sales and cost for the month of May, 2015.

Product	Standard Cost per unit ₹	Budgeted Sales		Actual Sales	
		Number of Units	Sales Value ₹	Number of Units	Sales Value ₹
A	31	1,250	50,000	1,400	54,000
B	25	1,000	30,000	950	27,500
C	15	750	15,000	900	17,500

Materials:	₹
Standard cost of materials actually used	26,150
Standard cost of materials allowed	26,650
Actual cost of materials used	27,150
Labour:	
Standard labour cost per hour	₹ 0.90
Actual clocked hours	22,000
Actual labour cost	₹ 21,300
Budgeted hours	20,000
Standard hours produced	22,500

Overheads:

Budgeted rates of overheads recovery per direct labour hour:

Variable ₹ 1.00 Fixed ₹ 0.50

Actual Overhead Costs.

Variable ₹ 21,500 Fixed ₹ 12,000

Prepare an operating profit and loss statement for May, 2015 in the same form as for April, 2015.

**Solution:**

	(1)	(2)	(3)
	AQAP	AQSP	SQSP
A	54000	56000	50000
B	27500	28500	30000
C	17500	18000	15000
	₹99000	₹102500	₹95000

- (1) AQAP = Actual Sales = ₹ 99,000
 (2) AQSP = Actual Quality of Sales = ₹1,02,500
 (3) SQSP = Standard or Budgeted Sales = ₹ 95,000
 (a) Sales volume Variance = 2 – 3 = ₹ 7500 (F)
 (b) Sales Price Variance = 1 – 2 = ₹ 3,500 (A)

Profit Variance:

	(1)	(2)	(3)
	AQAR	AQSR	SQSR
A	1440 X 7.5714	1400 X 9	1250 X 9
B	950 X 3.9473	950 X 5	1000 X 5
C	900 X 4.4444	900 X 5	750 X 5
A	10600	12600	11250
B	3750	4750	5000
C	4000	4500	3750
	₹ 17350	₹ 21850	₹ 20000

SR = Standard Selling Price – Standard Cost per unit

AR = Actual Selling Price – Standard Cost per unit

SR: A = 9; B = 5; and C = 5

AR:

A = (54000/1400) - 31 = ₹ 7.5714

B = (27500/950) - 25 = ₹ 3.9473

C = (17500/900) - 15 = ₹ 4.4444

- 1) AQAR = Actual Profit = ₹ 17.350
 2) AQSR = Actual Sales at Standard Rate of Profit = ₹ 21,850
 3) SQSR = Budgeted Profit = ₹ 20,000
 (a) Profit Variance Due to sales Volume = 2 – 3 = ₹ 1850 (F)
 (b) Profit Variance due to selling price = 1 – 2 = ₹ 4500 (A)



Material Variance:

(1)	(2)	(3)
SQSP	AQSP	AQAP
26650	26150	27150

- 1) SQSP = Standard Cost of Standard Material = ₹ 26,650
 - 2) AQSP = Standard Cost of Actual material = ₹ 26,150
 - 3) AQAP = Actual Cost of Material = ₹ 27,150
- a) Material usage Variance = 1-2 = ₹ 500 (F)
- b) Material Price Variance = 2-3 = ₹ 1,000 (A)

Labour Variances:

(1)	(2)	(3)
SRSH	SRAH	ARAH
0.9 X 22500	0.9 X 22000	
20,250	19,800	21,300

- 1) SRSH = Standard Cost of Standard Labour = ₹ 20,250
 - 2) SRAH = Standard Cost of Actual labour = ₹ 26,150
 - 3) ARAH = Actual Cost of Labour = ₹ 21,300
- a) Labour efficiency Variance = 1 – 2 = ₹ 450 (F)
- b) Labour Rate Variance = 2-3 = ₹ 1500 (A)

Variable Overhead Variances:

(1)	(2)	(3)
SRSH	SRAH	ARAH
1 x 22500	1 x 22000	
₹ 22500	₹ 22000	₹ 21500

- 1) SRSH = Standard Cost Standard Variable Overheads = ₹ 22,500
 - 2) SRAH= Standard Cost of Actual Variable Overheads = ₹ 22,000
 - 3) ARAH = Actual Variable Overheads = ₹ 21,500
- a) Variable Overheads efficiency Variance = 1-2 = ₹ 500 (F)
- b) Variable Overheads expenditure variance = 2-3 = ₹ 500 (F)

Fixed Overhead Variances:

(1)	(2)	(3)	(4)
SRSH	SRAH	SRBH	ARAH
0.5 X 22500	0.5 X 22000	0.5 X 20000	
₹11250	₹11000	₹10000	₹12000

- 1) SRSH = Standard Cost of Standard Fixed Overheads = ₹ 11,250
- 2) SRAH = Standard Cost of Actual Fixed Overheads = ₹ 11,000
- 3) SRBH = Budgeted Fixed Overheads = ₹ 10,000
- 4) ARSH = Actual Fixed Overheads = ₹ 12,000
- a) Fixed Overheads efficiency Variance = 1-2 = ₹ 250 (F)
- b) Fixed Overheads capacity variance = 2-3 = ₹ 1000 (F)
- c) Fixed Overheads expenditure variance = 3-4 = ₹ 2000 (A)

Operating Profit and Loss Statement for the month of May, 2009:

	Standard & Variances	Actual Variances
	₹	₹
Budgeted Sales	95000	
Variances due to Volume	7500	
Variances due to Selling prices	(3500)	99000
Budgeted Profit	20000	
Variance due to sales Volume	1850	
Variance due to Selling prices	(4500)	17350
Production Cost Variances:		
Material usage	500	
Material Price	(1000)	(500)
Labour efficiency	450	
Labour Rate	(1500)	(1050)
Overheads variance:		
Expenditure: Variable	1000	1000
Expenditure: Fixed	(2000)	
Fixed Overheads Efficiency	250	
Fixed Overheads Capacity	1000	(750)
Fixed Overheads Operating Profit		16050

Illustration 18.

The budgeted output of a single Product manufacturing company for 2014-15 was 5,000 units. The financial results in respect of the actual output of 4,800 units achieved during the year were as under:-

	₹
Direct Material	29,700
Direct wages	44,700
Variable Overheads	72,750
Fixed Overheads	39,000
Profit	36,600
Sales	2,22,750

The standard direct wage rate is ₹4.50 per hour and the standard variable overhead rate is ₹7.50 per hour.



The cost accounts recorded the following variances for the year.

Variances	Favourable	Adverse
	₹	₹
Material Price	-	300
Material Usage	-	600
Wage Rate	750	-
Labour Efficiency	-	2,250
Variable Overhead Expense	3,000	-
Variable Overhead Efficiency	-	3,750
Fixed Overhead Efficiency	-	1,500
Selling Price	6,750	-

Required:

- (i) Prepare a statement showing the original budget.
- (ii) Prepare the standard product cost sheet per unit.
- (iii) Prepare a statement showing the reconciliation of originally budgeted profit and the actual profit.

Solution:

Statement showing original budget and standard cost per unit:

Element	Actual (₹)	Variance (₹)	Standard Cost 4800 (₹)	Standard Cost Per unit (₹)	Original Budget 5000 units (₹)
Material	29700	300A	28800	6.00	30000
Direct Wags	44700	750	46200	9.00	45000
		2250A			
Value Overhead	75750	3000	72000	15.00	75000
		3750A			
Fixed Overhead	39000	1500A	37500	7.50	37500
	186150	3750F	181500	37.50	187500
Profit (b/f)	36600	8400A	34500	7.50	37500
		2100F			
Sales	222750	6750F	216000	45.00	225000

Statement showing reconciliation of budgeted profit with Actual profit:

	(₹)
Budgeted Profit	37500
Add: All favourable variances	10500
	48000
Less All adverse variance	8400
	39600
Less: (5000-4800) 7.5 profit variances	1000



Less: (5000-4800) 7.5 profit variances	1500
Actual Profit	36600
(or)	
Standard Profit	34500
Add	10500
	45000
Less:	8400
Actual Profit	36600
Budgeted Profit	37500
Less: 8400 + 9000	17400
	20100
Add:	3750
Variable Cost	6000
Sales price variance	6750
	36600

Illustration 19.

In a company operating on a standard costing system for a given four week period budgeted for sales of 10,000 units. at ₹ 50 per unit, actual sales were 9,000 units at ₹51.25 per unit. Costs relating to that period were as follows:

	STANDARDS (₹)	ACTUALS (₹)
Materials	₹ 2,50,000	2,57,400
Wages	75,000	70,875
Fixed Overhead	20,000	18,810
Variable Overhead	10,000	9,250
Semi-variable overhead	2,700	2,430
Standard hours 50,000		
Actual hours 40,500		

- 1) The Standard material content of each unit is estimated at 25 kg. at ₹1 per kg. actual figures were 26 kg. at ₹1.10 per kg.
- 2) Semi-variable Overhead consists of FIVE - NINTHS fixed expenses and FOUR - NINTHS variable.
- 3) The Standard wages per unit are 5 hours at ₹1.50 per Unit actual wages were 4.5 hours at ₹1.75.
- 4) There were no opening stocks and the whole production for the period was sold.
- 5) The four week period was normal period.

You are Required:

- a) To compute the variances in Sales, Materials, Labour and Over heads due to all possible causes; and
- b) with the help of such a computation draw a statement reconciling the actual profit for the period with the standard profits.

**Solution:**

Working notes:

	<u>Budget</u>	<u>Actual</u>
	₹	₹
Fixed overhead	20000	18810
Share in semi variable OHs (5/9)	<u>1500</u>	<u>1350</u>
	<u>21500</u>	<u>20160</u>
Variable OHs	10000	9250
Share in semi variable OHs(4/9)	<u>1200</u>	<u>1080</u>
	<u>11200</u>	<u>10330</u>

Variances:

⇒ Sales

(1)	(2)	(3)
AQAP	AQSP	SQSP
51.25 x 9000	50 x 9000	50 x 10000
₹ 461250	₹ 450000	₹ 500000

AQAP = actual value of sales = 461250

SQSP = actual sales at standard prices = 450000

AQSP = standard value of sales = 500000

- (a) Sales volume variance = (2) – (3) = 50000(A)
 Sales price variance = (1) – (2) = 11250(F)
- (b) Sales value variance = (1) – (3) 38750(A)

⇒ Material

(1)	(2)	(3)
SQSP	AQSP	AQAP
1 x 225000	1 x 234000	1.1 x 234000
225000	234000	257400

AQ = 9000 x 26 = ₹ 234000

SQ = 9000 x 25 = ₹ 225000

- 1) Standard cost of standard material = ₹ 225000
 - 2) Standard cost of actual material = ₹ 234000
 - 3) Actual cost of material = ₹ 257400
- (a) Material usage variance = (1) – (2) = ₹ 9000(A)
 (b) Material price variance = (2) – (3) = ₹ 23400(A)
 (c) Material cost variance = (1) – (3) = ₹ 32400(A)

⇒ Labour

(1)	(2)	(3)
SRSH	SRAH	ARAH
1.5 x 45000	1.5 x 40500	1.75 x 40500
₹ 67500	₹ 60750	₹ 70875



$$SH = 9000 \times 5 = 45000$$

- 1) SRSH = standard cost of standard labour = ₹ 67500
- 2) SRAH = standard cost of actual labour = ₹ 60750
- 3) ARAH = actual cost of labour = ₹ 70875
 - (a) Labour efficiency variance = (1) – (2) = ₹ 6750(F)
 - (b) Labour rate variance = (2) – (3) = ₹ 10125(A)
 - (c) Labour cost variance = (1) – (3) = ₹ 3375(A)

⇒ Variable OHs

(1)	(2)	(3)
SRSH	SRAH	ARAH
0.224 x 45000	0.224 x 40500	10330
₹ 10080	₹ 9072	₹ 10330

$$SR = 11200/50000 = ₹ 0.224$$

- 1) SRSH = standard cost of standard variable OHs = ₹ 10080
- 2) SRAH = standard cost of actual variable OHs = ₹ 9072
- 3) ARAH = actual cost of variable OHs = ₹ 10330
 - (a) Variable OHs efficiency variance = (1) – (2) = ₹ 1008(F)
 - (b) Variable OHs budget variance = (2) – (3) = ₹ 1258(A)
 - (c) Variable OH cost variance = (1) – (3) = ₹ 250(A)

⇒ Fixed OHs

(1)	(2)	(3)	(4)
SRSH	SRAH	SRBH	ARAH
0.43 x 45000	0.43 x 40500	0.43 x 50000	
₹ 19350	₹ 17415	₹ 21500	₹ 20160

$$SR = 21500/50000 = 0.43$$

- 1) SRSH = Standard cost of standard fixed OHs = ₹ 19350
- 2) SRAH = standard cost of actual fixed OHs = ₹ 17415
- 3) SRBH = budgeted fixed OHs = ₹ 21500
- 4) ARAH = actual fixed OHs = ₹ 20160
 - (a) Fixed OHs efficiency variance = (1) – (2) = ₹ 1935(F)
 - (b) Fixed OHs capacity variance = (2) – (3) = ₹ 4085(A)
 - (c) Fixed OHs volume variance = (1) – (3) = ₹ 2150(A)
 - (d) Fixed OHs budget variance = (3) – (4) = ₹ 1340(F)
 - (e) Fixed OH cost variance = (1) – (4) = ₹ 810(A)



Statement showing reconciliation of actual & standard profits:

		₹
Budgeted sales		500000
(+) sales price variance	11250	
(-) sales volume variance	(50000)	(38750)
Actual sales		461250
<u>(-) standard cost of sales</u>		
Material {250000 x (9/10)}	225000	
Wages {75000 x (9/10)}	67500	
Fixed OHs {21500 x (9/10)}	19350	
Variable OHs {11200 x (9/10)}	<u>10080</u>	<u>321930</u>
Standard profit		<u>139320</u>
<u>Add favorable variances</u>		
labour efficiency variance	6750	
Variable OH efficiency	1008	
Fixed OH efficiency	1935	
Fixed OH budget	<u>1340</u>	<u>11033</u>
		150353
<u>Less adverse variances</u>	₹	₹
material usage variance	9000	
Material price variance	23400	
Labour rate variance	10125	
Variable OH budget	1258	
Fixed OH capacity variance	<u>4085</u>	<u>47868</u>
Actual profit		<u>102485</u>

Illustration 20.

A Company manufactures two products X and Y. Product X requires 8 hours to produce while Y requires 12 hours. In April, 2013, of 22 effective working days of 8 hours a day, 1,200 units of X and 800 units of Y were produced. The company employs 100 workers in production department to produce X and Y. The budgeted hours are 1,86,000 for the year.

Answer:

Calculate Capacity, Activity and Efficiency ratios and establish their relationship.

		(Hours)
Standard hours of production		
Product X (1,200 units x 8 hrs.)		9,600
Product Y (800 units x 12 hrs.)		9,600
Total standard hours		19,200
Actual hours worked (100 workers x 8 hrs. x 22 days)		17,600
Budgeted hours per month (1,86,000 hrs./ 12 months)		15,500



$$\begin{aligned} \text{Capacity Ratio} &= \frac{\text{Actual hours worked}}{\text{Budgeted hours p.m.}} \times 100 = \frac{17,600}{15,500} \times 100 = 113.55\% \\ \text{Efficiency Ratio} &= \frac{\text{Standard hours of production}}{\text{Actual hours worked}} \times 100 = \frac{19,200}{17,600} \times 100 = 109.09\% \\ \text{Activity Ratio} &= \frac{\text{Standard hours of production}}{\text{Budgeted hour p.m.}} \times 100 = \frac{19,200}{15,500} \times 100 = 123.87\% \end{aligned}$$

Relationship of Ratios

$$\text{Activity ratio} = \text{Efficiency Ratio} \times \text{Capacity Ratio}$$

$$123.87 = \frac{109.09 \times 113.55}{100}$$

Illustration 21.

F Manufacturing Ltd., uses the three variances method to analyze the manufacturing overhead variances. Manufacturing overhead variances for the fiscal year just ended were computed as follows:

Spending - ₹ 86,000 Adverse Efficiency - ₹ 36,000 Favourable Volume - ₹ 80,000 Favourable

The manufacturing overhead application rate for the year was ₹ 160 per machine hour of which ₹ 60 per machine hour was the variable component. The year end balance in the Manufacturing Overhead Control Account was ₹ 16,50,000 and the standard machine hours for the year were 11,300.

From the above data compute: (i) Budgeted machine hours, (ii) Actual machine hours, (iii) Applied manufacturing overhead, (iv) Total amount of fixed overhead cost.

Answer:

(i) Calculation of Budgeted Machine Hours

Volume variance = ₹ 80,000 (F) given

Volume variance = Std. fixed overhead rate per hour (Std. machine hours for actual output - Budgeted machine hours for actual output)

$$₹ 80000(F) = ₹ 100 (11,300 - x)$$

$$800 = 11,300 - x$$

$$x = 11,300 - 800$$

$$x = 10,500$$

∴ Budgeted Machine hours for actual output = 10,500 hours

(ii) Actual Machine Hours

Efficiency variance = ₹ 36,000 (F) (given)

Efficiency variance = Std. variable overhead rate per hour (Std. hours for actual output - Actual hours for actual output)

$$₹ 36000(F) = ₹ 60 (11300 \text{ hours} - x)$$

$$600 = 11300 - x$$

$$x = 10,700$$

∴ Actual Machine hours = 10,700 hours



(iii) Applied Manufacturing overhead

$$= \text{Actual overhead incurred} + \text{Total variance}$$

$$= ₹ 16,50,000 + ₹ 30,000 = ₹ 16,80,000$$

Working Notes

$$\text{Total variance} = \text{Spending variance} + \text{Efficiency variance} + \text{Volume variance}$$

$$= ₹ 86,000 (A) + ₹ 36,000 (F) + ₹ 80,000 (F) = ₹ 30,000 (F)$$

(iv) Total amount of Fixed overhead cost

Spending variance = Flexible budget for actual hours - Actual factory overhead incurred

$$₹ 86,000 (A) = (10,700 \text{ hours} \times ₹ 60 + \text{Total amount of fixed overhead} - ₹ 16,50,000)$$

$$₹ 86,000 (A) = ₹ 6,42,000 + \text{Total amount of fixed overhead (budgeted)} - ₹ 16,50,000$$

$$\text{Total amount of fixed overhead} = ₹ 10,08,000 - ₹ 86,000 = ₹ 9,22,000$$

Illustration 22.

Despite the increase in the sales price of its sole product to the extent of 20%, a company finds that it has incurred a loss during the year 20 12-13 to the extent of ₹ 4 lakhs as against a profit of ₹ 5 lakhs made in 201 1-12. This adverse situation is attributed mainly to the increase in prices of materials and overheads, the increase over the previous year being on the average, 15% and 10% respectively.

The following figures are extracted from the books of the company:

(₹)

	31-3-2012	31-3-2013
Sales	1,20,00,000	1,29,60,000
Cost of sales:		
Material	80,00,000	91,10,000
Variable overhead	20,00,000	24,00,000
Fixed overhead	15,00,000	18,50,000

Required: Analyze the variances over the year in order to bring out the reasons for the fall in profit.

Answer:

Statement of figures extracted from the books of the company

(₹ lakhs)

Year	2011-12	2012-13 (based on 2011-12 prices)	Difference
(a)	(b)	(c)	(b) - (c)
Sales (W.N. 1)	120	*108.00	12
Cost of sales:			
Material (W.N. 2)	80	79.22	
Variable overhead (W.N. 3)	20	21.82	
Fixed overhead (W.N. 4)	15	16.82	

*Decrease in sales = ₹ 120 - ₹ 108 = ₹ 12 lakhs or 10% of 2011-12 sales figure at 2012-13 rate

$$\text{Contribution to sales ratio during 2011-12} = \frac{\text{Sales} - \text{Variable costs}}{\text{Sales}}$$

$$= \frac{₹ 120 - ₹ 100}{₹ 120} \text{ or } (1/6) \text{ of per rupee sale}$$



Loss of contribution during 2012-13 on the sale of 12 lakhs = ₹ 12 lakhs × 1/6 = ₹ 2 lakhs

Computation of Variances

Sales Price Variance

= Actual sales - Standard sales
= ₹ 129.60 - ₹ 108 = ₹ 21.60 lakhs (F)

Material Price Variance

= Standard cost of actual quantity - Actual cost
= ₹ 79.22 - ₹ 91.10 = ₹ 11.88 lakhs (A)

Variable Overhead Expenditure Variance

= Budgeted variable overhead for actual hours - Actual variable overhead
= (₹ 21.82 - ₹ 24) = ₹ 2.18 lakhs (A)

Variable Overhead Efficiency Variance

= Std. variable overhead for standard hours - Std. variable overhead for actual hours
= ₹ 18 - ₹ 21.62 = ₹ 3.62 lakhs (A)

* Variable overhead in 2011-12 was ₹ 20 lakhs. Since there was a decrease in sales in 2012-13 to the extent of 10% of 2011-12 sales figure (based on 2011-12 prices). Therefore, the standard variable overhead for standard hours at this reduced sales in 2012-13 would be equal to (₹ 20 lakhs minus 10% of 20 lakhs) i.e. (₹ 20 lakhs - ₹ 2 lakhs) = ₹ 18 lakhs.

Fixed Overhead Expenditure Variance

= Budgeted fixed overhead - Actual fixed overhead
= ₹ 16.82 - ₹ 18.50 = ₹ 1.68 lakhs (A)

Fixed Overhead Volume Variance

= Std. fixed overhead for actual output - Std. fixed overhead for budgeted output
= (16.82-15) = ₹ 1.82 lakhs (A)

Reconciliation Statement

Particulars		(₹)
Profit during 2011 -12		5,00,000
Add: Net increase in profit due to the sales of 2011-12		19,60,000
[after taking into account increase in sales price but decrease in contribution margin due to decrease in quantum (vol. of sales)] (Refer to working note 5)		24,60,000
Less: Usage/Efficiency variance		
Material	7,22,000	
Variable overhead	3,82,000	
Fixed overhead volume variance	1,82,000	12,86,000
Less: Price variances		
Material price variance	11,88,000	
Variable overhead expenditure variance	2,18,000	
Fixed overhead expenditure variance	1,68,000	15,74,000
Loss during 2012-13 (Difference figure)		4,00,000



Conclusion: The reasons for the decrease in the total profit figure of the year 2012-13 (inspite of the increase in sales price) are due to adverse - (i) Usage/efficiency variances to the extent of ₹ 12,86,000 and (ii) Price variances to the extent of ₹ 15,74,000.

Working Notes:

(1) Sales during 2010-11 at 2009-10 price level	$= \frac{129.60}{120} \times 100$	= ₹ 108 lakhs
(2) Material cost of 2010-11 at 2009-10 price level	$= \frac{91.10}{115} \times 100$	= ₹ 79.22 lakhs
(3) Variable overhead of 2010-11 at 2009-10 price level	$= \frac{24}{110} \times 100$	= ₹ 21.82 lakhs
(4) Fixed overhead of 2010-11 at 2009-10 price level	$= \frac{18.50}{110} \times 100$	= ₹ 16.82 lakhs
(5) Net increase in profit due to rise of 20% of S.P. and reduction in contribution due to reduction in sales	$= 129.6 - 108 - 2$	= ₹ 19.6 lakhs

Illustration 23.

X uses traditional standard costing system. The inspection and setup costs are actually ₹ 1,760 against a budget of ₹ 2,000.

ABC system is being implemented and accordingly, the number of batches is identified as the cost driver for inspection and setup costs. The budgeted production is 10,000 units in batches of 1,000 units, whereas actually, 8,800 units were produced in 11 batches.

- Find the volume and total fixed overhead variance under the traditional standard costing system.
- Find total fixed overhead cost variance under the ABC system.

Answer:

- Calculation of volume and total fixed overhead under Traditional Standard Costing System

Budgeted overhead cost per unit	$= ₹ 2,000/10,000$ units	= ₹ 0.20
Actual overhead cost per unit	$= ₹ 1,760/8,800$ units	= ₹ 0.20
Total fixed overhead variance	= Absorbed budgeted overhead - Actual overhead	
	$= (₹ 0.20 \times 8,800 \text{ units}) - ₹ 1,760$	= Nil
Fixed overhead expenditure variance	= Budgeted overhead - Actual overhead	
	$= 2,000 - 1,760$	= ₹ 240 (F)
Standard absorption rate	$= ₹ 2,000/10,000$ units	= ₹ 0.20 per unit
Fixed overhead volume variance	= Standard absorption rate x (Budgeted units - Actual units)	
	$= ₹ 0.20 (10,000 \text{ units} - 8,800 \text{ units})$	= ₹ 240 (A)

Verification:

Total fixed overhead variance	= Expenditure variance + Volume variance	
	$= 240 (F) + 240 ((A))$	= Nil

(ii) Calculation of fixed overhead cost variance under ABC System

Particulars	Budget	Actual	ABC standard
Total cost (₹)	2,000	1,760	1,800
Production (units)	10,000	8,800	8,800
No. of batches	10	11	9
Batch size (units/batch)	1,000	800	1,000
Cost per batch	200	160	200

Under ABC 8,800 units should have been produced in standard batch size of 1,000 units/batch.

No. of batches = $8,800/1,000 = 9$ approx.

Standard cost under ABC = Budgeted cost per batch × ABC standard number of batches
 = ₹ 200 × 9 = 1,800

Under ABC, variability is with respect to batches and not units

Absorbed overheads = 9 batches × Standard rate per batch
 = 9 × ₹ 200 = ₹ 1,800

Actual overheads = ₹ 1,760

Total overheads cost variance = ₹ 40 (F)

Illustration 24.

X Ltd. produces and sells a single product. Standard cost card per unit of the product is as follows: (₹)

Direct materials: A	(10 kg. @ ₹ 5 per kg.)	50
B	(5 kg. @ ₹ 6 per kg.)	30
Direct wages	(5 hours @ ₹ 5 per hour)	25
Variable production overheads	(5 hours @ ₹ 12 per hour)	60
Fixed production overheads		25
Total standard cost		190
Standard gross profit		35
Standard selling price		225

A fixed production overhead has been absorbed on the expected annual output of 25,200 units produced evenly throughout the year. During the month of December, 2013, the following were the actual results for an actual production of 2,000 units. (₹)

Sales	(2,000 units @ ₹ 225)	4,50,000
Direct materials: A	18,900 kg.	99,225
B	10,750 kg.	61,275
Direct wages	10,500 hours (actually worked 10,300 hours)	50,400
Variable production overheads		1,15,000
Fixed production overheads		56,600
Total		3,82,500
Gross profit		67,500

The material price variance is extracted at the time of receipt of materials. Material purchase were a 20,000 kg. @ ₹ 5.25 per kg; B 11,500 kg. @ ₹ 5.70 per kg.



Required:

- (i) Calculate all variances.
- (ii) Prepare an operating statement showing standard gross profit, variances and actual gross profit.
- (iii) Explain the reason for the difference in actual gross profit given in the question and calculated in (ii) above.

Answer:

Material Variances

Standard quantity for actual output	A = 2,000 × 10	= 20,000 kg.
	B = 2,000 × 5	= 10,000 kg.
Revised standard quantity :	A = 20,000/30,000 × 29,650	= 19,766.67 kg.
	B = 10,000/30,000 × 29,650	= 9,883.33 kg.
Standard yield	= (2,100/31,500) × 29,650	= 1,976.67
(a) Material price variance	= (SP - AP) AQ	
	A = (5 - 5.25) × 20,000	= 5,000 (A)
	B = (6 - 5.7) × 11,500	= 3,450 (F) = ₹ 1,550 (A)
(b) Material usage variance	= (SQ - AQ) SP	
	A = (20,000 - 18,900) × 5	= 5,500 (F)
	B = (10,000 - 10,750) × 6	= 4,500 (A) = ₹ 1,000 (F)
(c) Material mix variance	= SP (RSQ - AQ)	
	A = (19,766.67 - 18,900) × 5	= 4,333.33 (F)
	B = (9,883.33 - 10,750) × 6	= 5,200.00 (A) = ₹ 866.67 (A)
(d) Material yield variance	= SR (AY - SY)	
	= (2,000 - 1,976.67) × 80	= ₹ 1,866.67 (F)

Labour Variances

(a) Labour rate variance	= (SR - AR) AH	
	= (5 - 4.8) × 10,500	= ₹ 2,100 (F)
(b) Labour efficiency variance	= SR (SH - AH)	
	= (10,000 - 10,300) × 5	= 1,500 (A)
(c) Labour idle time variance	= Idle hours × SR	
	= 200 × 5	= 1,000 (A)

Variable Overhead Variances

(a) V. OH. cost variance	= Recovered overhead - Actual overhead	
	= (2,000 × 60 - 1,15,000)	= ₹ 5,000 (F)
(b) V. OH. exp. variance	= Standard variable overhead - Actual variable overhead	
	= (10,300 × 12) - 1,15,000	= 8,600 (F)



$$\begin{aligned} \text{(c) V. OH. efficiency variance} &= \text{Recovered variable overhead} - \text{Standard variable overhead} \\ &= 1,20,000 - 1,23,600 &= ₹ 3,600 \text{ (A)} \end{aligned}$$

Fixed Overhead Variances

$$\begin{aligned} \text{(a) Fixed OH. cost variance} &= \text{Recovered overhead} - \text{Actual overhead} \\ &= (2,000 \times 25) - 56,600 &= ₹ 6,600 \text{ (A)} \end{aligned}$$

$$\begin{aligned} \text{(b) Fixed OH. exp. variance} &= \text{Budgeted overhead} - \text{Actual overhead} \\ &= (25,200 \times 25) + 12 - 56,600 &= ₹ 4,100 \text{ (A)} \end{aligned}$$

$$\begin{aligned} \text{(c) Fixed OH. volume variance} &= \text{Recovered overhead} - \text{Budgeted overhead} \\ &= (50,000 - 52,500) &= ₹ 2,500 \text{ (A)} \end{aligned}$$

(ii) Reconciliation Statement (₹)

Standard profit (35 x 2,000)	Price	Favourable	Adverse	70,000
Variances				
Material		-	1,550.00	
	Mix	-	866.67	
	Yield	1,866.67	-	
Labour	Rate	2,100.00	-	
	Efficiency	-	1,500.00	
	Idle time	-	1,000.00	
Variable overheads	Expenditure	8,600.00	-	
	Efficiency	-	3,600.00	
Fixed overheads	Expenditure	-	4,100.00	
	Volume	-	2,500.00	
		12,566.67	15,116.67	2,550 (A)
Actual profit				67,450

(iii) Actual gross profit given in the question is 67,500 while calculated operating profit in statement is Rs.67,450. The difference amount is due to material price variance that is calculated at the time of receipt of material instead of consumption of material.

Material price variance

$$A = 18,900 \times (5 - 5.25) = 4,725 \text{ (A)}$$

$$B = 10,750 \times (6 - 5.70) = 3,225 \text{ (F)} = ₹ 1,500 \text{ (A)}$$

Over recovery in the operating statement is 50 (i.e. 1,550 - 1,500), should be added in actual profit ₹ 67,500. (i.e. 67,450 + 50).



3.2 UNIFORM COSTING IN PROFIT PLANNING

Introduction:

Uniform Costing is not a separate method or type of Costing. It is a technique of Costing and can be applied to any industry. *Uniform Costing may be defined as the application and use of the same costing principles and procedures by different organisations under the same management or on a common understanding between members of an association.* The main feature of uniform costing is that whatever be the method of costing used, it is applied uniformly in a number of concerns in the same industry, or even in different but similar industries. This enables cost and accounting data of the member undertakings to be compiled on a comparable basis so that useful and crucial decisions can be taken. The principles and methods adopted for the accumulation, analysis, apportionment and allocation of costs vary so widely from concern to concern that comparison of costs is rendered difficult and unrealistic. Uniform Costing attempts to establish uniform methods so that comparison of performances in the various undertakings can be made to the common advantage of all the constituent units.

Scope of Uniform Costing:

Uniform Costing methods may be advantageously applied:

- (a) In a single enterprise having a number of branches or units, each of which may be a separate manufacturing unit.
- (b) In a number of concerns in the same industry bound together through a trade association or otherwise, and
- (c) In industries which are similar in nature such as gas and electricity, various types of transport, and cotton, jute and woolen textiles.

The need for application of Uniform Costing System exists in a business, irrespective of the circumstances and conditions prevailing therein. In concerns which are members of a trade association, the procedure for Uniform Costing may be devised and controlled by the association or by any other central body specially formed for the purpose.

Requisites for Installation of a Uniform Costing System:

The organisational set up for implementing the principles and methods of Uniform Costing may take different forms. It may range from a small association of a number of concerns who agree to have uniform information regarding a few specific cost accounting respects, to be a large organisation which has a fully developed scheme covering all the aspects of costing. The success of a uniform costing system will depend upon the following:

- (a) There should be a spirit of mutual trust, co-operation and a policy of give and take amongst the participating members.
- (b) There should be a free exchange of ideas and methods.
- (c) The bigger units should be prepared to share with the smaller ones, improvements, achievements of efficiency, benefits of research and know-how.
- (d) There should not be any hiding or withholding of information.
- (e) There should be no rivalry or sense of jealousy amongst the members.

In the application of Uniform Costing, the fundamental requirement is, therefore, to locate such differences and to eliminate or overcome, as far as practicable, the causes giving rise to such differences. The basic reasons for the differences may be as follows:

(a) **Size and organisational set up of the business:**

The number and size of the departments, sections and services also vary from one concern to another according to their size and organisation. The difficulty in operating Uniform Cost Systems for concerns which



vary widely in regard to size and type of business may to some extent be overcome by arranging the various units in a number of size or type ranges, and applying different uniform systems for each such type.

(b) **Methods of production:**

The use of different types of machines, plant and equipments, degree of mechanization, difference in materials mix and sequence and nature of operations and processes are mainly responsible for the difference in costs.

(c) **Methods and principles of cost accounting applied:**

It is in this sphere that the largest degree of difference arises. Undertakings manufacturing identical or similar products and having the same system of cost accounting would generally employ different methods of treatment of expenditure on buying, storage and issue of materials, pricing of stores issues, payment to workers, basis of classification and absorption of overhead, calculation of depreciation, charging rent on freehold or leasehold assets etc.

Fields covered by Uniform Costing:

There is no system of Uniform Costing which may be found to fit in all circumstances. The system to be installed should be tailored to meet the needs of each individual case. The essential *points* on which uniformity is normally required may be summarized as follows:

- (a) Whether costs are required for the individual products i.e for the cost units or for cost centres.
- (b) The method of costing to be applied.
- (c) The technique employed such as Standard Costing, Marginal Costing.
- (d) Items to be excluded from costs.
- (e) The basis of departmentalization.
- (f) The basis of allocation of costs to departments and/or service department costs to production departments.
- (g) The methods of application administration, selling and distribution overhead to cost of sales.
- (h) The method of valuation of work-in-progress.
- (i) Methods of treating cost of spoilage, defective work, scrap and wastage.
- (j) Methods of accounting of overtime pay bonus and other miscellaneous allowances paid to workers.
- (k) Whether purchase, material handling and upkeep expenses are added to the cost of stores or are treated as overhead expenses.
- (l) The system of materials control-pricing of issues and valuation of stock.
- (m) The system of classification and coding of accounts.
- (n) The method of recording accounting information.

Advantages of Uniform Costing:

Main advantages of a Uniform Costing System are summarised below:

- (i) It provides comparative information to the members of the organisation / association which may by them to reduce or eliminate the evil effects of competition and unnecessary expenses arising from competition.
- (ii) It enables the industry to submit the statutory bodies reliable and accurate data which might be required to regulate pricing policy or for other purposes.



- (iii) It enables the member concerns to compare their own cost data with that of the others detect the weakness and to take corrective steps for improvement in efficiency.
- (iv) The benefits of research and development can be passed on the smaller members of the association lead to economy of the industry as a whole.
- (v) It provides all valuable features of sound cost accounting such as valued and efficiency of the workers, machines, methods, etc., current reports of comparing major cost items with the predetermined standards, etc.
- (vi) It serves as a prerequisite to Cost Audit and inter firm comparison.
- (vii) Uniform Costing is a useful tool for management control. Performance of individual units can be measured against norms set for the industry as a whole.
- (viii) It avoids cut-throat completion by ensuring that competition among member units proceeds on healthy lines.
- (ix) The process of pricing policy becomes easier when Uniform Costing is adopted.
- (x) By showing the one best way of doing things, Uniform Costing creates cost consciousness and provides the best system of cost control and cost presentation in the entire industry.
- (xi) Uniform costing simplifies the work of wage boards set up to fix minimum wages and fair wages for an industry.

Limitations of Uniform Costing:

- (i) Uniform costing presumes the application of same principles and methods of Costing in each of the member firms. But individual units generally differ in respect of certain key factors and methods.
- (ii) For smaller units the cost of installation and operation of Uniform Costing System may be more than the benefits derived by them.
- (iii) Uniform costing may create conditions that are likely to develop monopolistic tendencies within the industry. Prices may be raised artificially and supplies curtailed.
- (iv) If complete agreement between the members is not forthcoming, the statistics presented cannot be relied upon. This weakens the Uniform Costing System and reduces its usefulness.

3.3 INTER FIRM COMPARISON

Inter-firm comparison as the name denotes means the techniques of evaluating the performances, efficiencies, deficiencies, costs and profits of similar nature of firms engaged in the same industry or business. It consists of exchange of information, voluntarily of course, concerning production, sales cost with various types of break-up, prices, profits, etc., among the firms who are interested of willing to make the device a success. The basic purposes of such comparison are to find out the work points in an organisation and to improve the efficiency by taking appropriate measures to wipe out the weakness gradually over a period of time.

The benefits which are derived from Inter-firm Comparison are appended below :

- (a) Inter-firm Comparison makes the management of the organisation aware of strengths and weakness in relation to other organisations in same industry.
- (b) As only the significant items are reported to the Management time and efforts are not unnecessary wasted.
- (c) The management is able to keep up to data information of the trends and ratios and it becomes easier for them to take the necessary steps for improvement.
- (d) It develops cost consciousness among the members of the industry.



- (e) Information about the organisation is made available freely without the fear of disclosure of confidential data to outside market or public.
- (f) Specialized knowledge and experience of professionally run and successful organisations are made available to smaller units who can take the advantages it may be possible for them to have such an infrastructure.
- (g) The industry as a whole benefits from the process due to increased productivity, standardization of products, elimination of unfair comparison and the trade practices.
- (h) Reliable and collective data enhance the organising power in deal in with various authorities and Government bodies.
- (i) Inter firm comparison assists in a big way in identifying industry sickness and gives a timely warning so that effective remedial steps can be taken to save the organisation.

Limitations of Inter-firm Comparison:

The practical difficulties that are likely to arise in the implementation of a scheme of inter-firm comparison are:

- (a) The top management may not be convinced of the utility of inter-firm comparison.
- (b) Reluctance to disclose data which a concern considers to be confidential.
- (c) A sense of complacency on the part of the management who may be satisfied with the present level of profits.
- (d) Absence of a proper system of Cost Accounting so that the costing figures supplied may not be relied upon for comparison purposes.
- (e) Non-availability of a suitable base for comparison.

These difficulties may be overcome to a large extent by taking the following steps:

- (a) 'Selling' the scheme through education and propaganda. Publication of articles in journals and periodicals, and lecturers, seminars and personal discussions may prove useful.
- (b) Installation of a system which ensures complete secrecy.
- (c) Introduction of a scientific cost system.

Illustration 24.

The share of total production and the cost-based fair price computed separately for each of the four units in industry are as follows:

	₹ per unit			
	40%	25%	20%	15%
Share of Production	40%	25%	20%	15%
Material Costs	150	180	170	190
Direct Labour	100	120	140	160
Depreciation	300	200	160	100
Other Overheads	300	300	280	240
	850	800	750	690
20% return on capital employed	630	430	350	230
Fair Price	1,480	1,230	1,100	920
Capital employed per unit is worked out as follows:				
Net Fixed Assets	3,000	2,000	1,600	1,000
Working Capital	140	150	150	150
Total	3,140	2,150	1,750	1,150

Indicate with reasons, what should be the Uniform Price fixed for the product.



Solution:

Computation of Uniform Price :

$$\begin{aligned}\text{Weighted Average Cost} &= [850 \times 40\%] + [800 \times 25\%] + [750 \times 20\%] + [690 \times 15\%] \\ &= 340 + 200 + 150 + 103.5 \\ &= ₹ 793.5\end{aligned}$$

Weighted Average Return on Capital Employed (profit)

$$\begin{aligned}&= [630 \times 40\%] + [430 \times 25\%] + [350 \times 20\%] + [230 \times 15\%] \\ &= 252 + 107.5 + 70 + 34.5 \\ &= ₹ 464\end{aligned}$$

$$\text{Uniform Price} = 793.5 + 464 = ₹ 1,257.5$$

Study Note - 4

ACTIVITY BASED COST MANAGEMENT - JIT AND ERP



This Study Note includes

- 4.1 Activity Based Cost Management
- 4.2 Just-In-Time (JIT)
- 4.3 Enterprise Resource Planning (ERP)
- 4.4 Bench Marking

4.1 ACTIVITY BASED COST MANAGEMENT

Introduction

A powerful tool for measuring performance, Activity-Based Costing (ABC) is used to identify, describe, assign costs to, and report on agency operations. A more accurate cost management system than traditional cost accounting; ABC identifies opportunities to improve business process effectiveness and efficiency by determining the "true" cost of a product or service. Activity Based Costing is a method for developing cost estimates in which the project is subdivided into discrete, quantifiable activities or a work unit. ABC systems calculate the costs of individual activities and assign costs to cost objects such as products and services on the basis of the activities undertaken to produce each product or services. It accurately identifies sources of profit and loss.

Limitations of Traditional Costing System

The cost of product arrived in traditional accounting system is not so accurate due to following reasons:

- (i) The present Costing system has developed convenient overhead recovery basis and blanket overhead recovery are acceptable when valuing stocks for financial reporting, but they are inappropriate when used for decision making and typical product strategy decisions. Such decisions have implications over 3-5 years and over this period many fixed costs become variable.
- (ii) The traditional fixed verses variable cost split is often unrealistic since, as business grows they often become more complex.
- (iii) In case of companies manufacturing and selling multiple products usually make decisions on pricing, product-mix, process technology etc., based on distorted cost information due to difficulties in traditional costing system in collection, classification, allocation and recovery of overheads to individual products.
- (iv) The cost structure is changing especially when making direct labour component to small proportion.
- (v) Traditional accounting was confined merely to furnishing information at product level. The new manufacturing technology demands the feed back of performance while production is still in progress rather than history.
- (v) There is also an urgent need to integrate the activity measurement and financial measurement.

Therefore, in order to overcome the inadequacies of traditional methods of overhead absorption and short-term biasing of marginal costing, Activity Based Costing (ABC) has been researched.

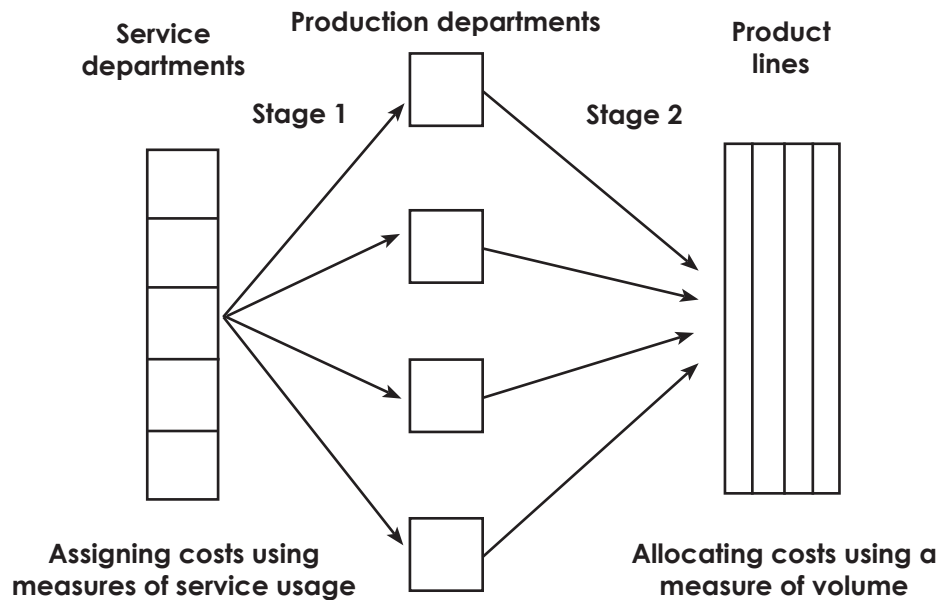

Activity-Based Costing

The concepts of ABC were developed in the manufacturing sector of the United States during the 1970s and 1980s. It is a practice in which activities are identified and all related costs of performing them are calculated, providing actual costs chargeable. The focus of activity based costing is activities. Thus identifying activities is a logical first step in designing an activity based costing. An activity is an event, task or unit of work with a specified purpose. For example; designing products, setting up machines, operating machines and distributing products.

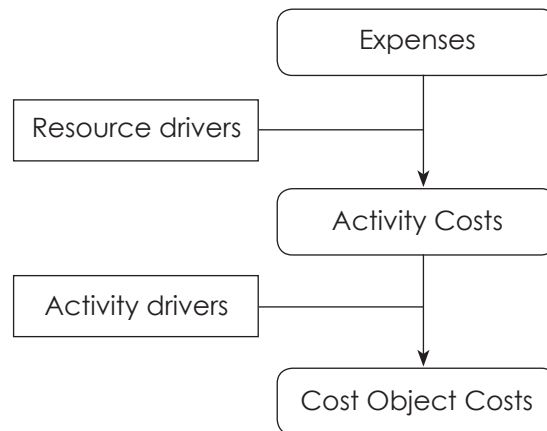

The CIMA terminology defines ABC as a cost attribution to cost units on the basis of benefit received from indirect activities. Peter B. B. Turney defines ABC as "a method of measuring the cost and performance of activities and cost objects. Assigns cost to activities based on their use of resources and assigns cost to cost objects based on



their use of activities. ABC recognizes the causal relationship of cost drivers to activities." ABC can be defined by the following equation:

$$C/A = HD + M + E + S$$

Where C/A = Estimated cost per activity

H = Number of labor hours required to perform the activity one time

D = Wages per labor hour

M = Material costs required to perform the activity one time

E = Equipment costs to perform the activity one time

S = Subcontracting costs to perform the activity one time

The total cost for performing the activity will be based on the number of times the activity is performed during a specific time frame. An activity based costing system first traces costs to activities and then to products and other cost objects. The following figure diagrammatically explains the basic flow of Activity-Based Costing.

Activity-based Costing

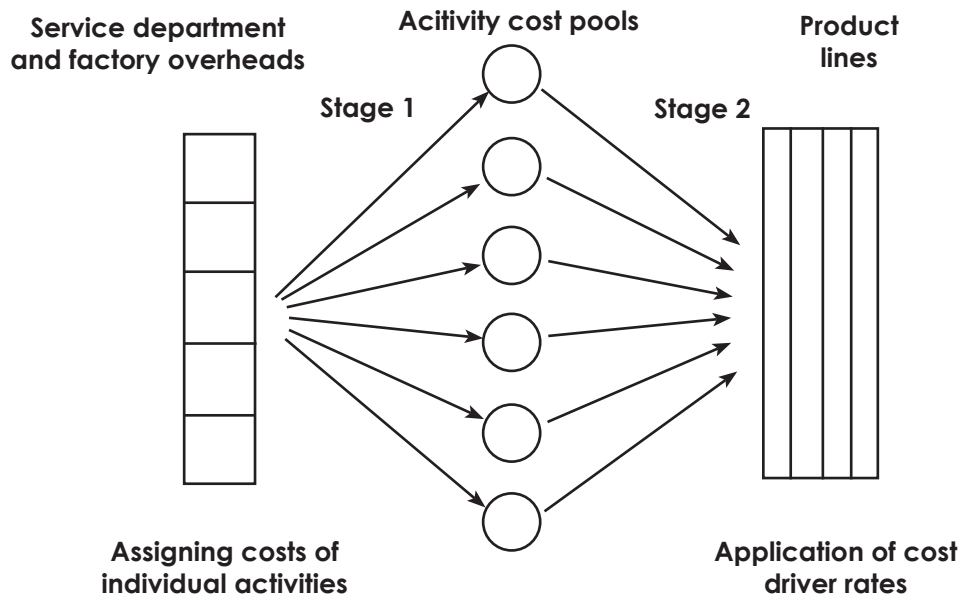

Important Terms in Activity Based Costing

The operation of the ABC system involves the use of the following terms:

Activity: An activity means an aggregate of closely related tasks having some specific functions which are used for completion of goal or objectives. For example, customer order processing is an activity. It includes receiving order from customers, interacting with production department regarding capacity to produce and giving commitment to the customer regarding delivery time. Other activities may be assembling, packaging, advertising etc.

Resource : Resources are elements that are used for performing the activities or factors helping in the activities. For example, order receiver, telephone, computers etc. are resources in customer order processing activity. It may include material, labour, equipment, office supplies etc.

Cost : Cost is amount paid for resource consumed by the activity. For example, salaries, printing stationary, telephone bill etc. are cost of customer order processing activity. It is also known as activity cost pool.



Cost object: It refers to an item for which cost measurement is required. e.g. a product, a service, or a customer.

Cost pool: A cost pool is a term used to indicate grouping of costs incurred on a particular activity which drives them.

Cost driver: Any element that would cause a change in the cost of activity is cost driver. Actually cost drivers are basis of charging cost of activity to cost object. Cost drivers are used to trace cost to product by using a measure of resources consumed by each activity. For example, frequency of order, number of order etc. may be cost driver of customer order processing activity. Cost driver may be involved two parts:

1. Resource cost driver
2. Activity cost driver

A resource cost driver is a measure of the quantity of resources consumed by an activity. An activity cost driver is a measure of the frequency and intensity of demand, placed on activities by cost objects.

For example

Activities	Resources	Cost pools	Cost driver
Consulting	Consultant, computer	Employee cost, maintenance cost	Level of consultant, time spent
Laser printing	Printing staff, printer	Colour cost, maintenance cost, printing stationary	No. of pages printed, font
Accounting administration	Administration staff	Salaries	No. of times account produced
Customer service	Telephone, staff	Telephone bill, salaries	Frequency of order, no. of order, time spent in servicing, no. of service calls
Research development	Staff, equipment, material	Salaries, maintenance cost, material cost	No. of research projects, time spent on a project, technical complexities of project

The cost drivers for various functions i.e., production, marketing, research, and developments are given below.

Production	Number of units Number of set-ups
Marketing	Number of sales personnel Number of sales orders
Research & development	Number of research projects Personnel hours spend on projects Technical complexities of the projects
Customer service	Number of service calls Number of products serviced Hours spend on servicing products

Let's illustrate the concept of activity based costing by looking at two common manufacturing activities: (1) the setting up of a production machine for running batches of products, and (2) the actual production of the units of product.

We will assume that a company has annual manufacturing overhead costs of ₹2,000,000—of which ₹200,000 is directly involved in setting up the production machines. During the year the company expects to perform 400 machine setups. Let's also assume that the **batch sizes** vary considerably, but the setup efforts for each machine are similar.

The cost per setup is calculated to be ₹500 (₹200,000 of cost per year divided by 400 setups per year). Under activity based costing, ₹200,000 of the overhead will be viewed as a **batch-level cost**. This means that ₹200,000 will



first be allocated to batches of products to be manufactured (referred to as a **Stage 1 allocation**), and then be assigned to the units of product in each batch (referred to as **Stage 2 allocation**). For example, if Batch X consists of 5,000 units of product, the setup cost per unit is ₹0.10 (₹500 divided by 5,000 units). If Batch Y is 50,000 units, the cost per unit for setup will be ₹0.01 (₹500 divided by 50,000 units). For simplicity, let's assume that the remaining ₹1,800,000 of manufacturing overhead is caused by the production activities that correlate with the company's 100,000 machine hours.

For our simple two-activity example, let's see how the rates for allocating the manufacturing overhead would look with activity based costing and without activity based costing:

	With ABC	Without ABC
Mfg overhead costs assigned to setups	₹200,000	₹-0-
Number of setups	400	Not applicable
Mfg overhead cost per setup	₹500	₹-0-
Total manufacturing overhead costs	₹2,000,000	₹2,000,000
Less: Cost traced to machine setups	200,000	-0-
Mfg O/H costs allocated on machine hours	₹1,800,000	₹2,000,000
Machine hours (MH)	100,000	100,000
Mfg overhead costs per MH	₹18	₹20
Mfg Overhead Cost Allocations	₹500 setup cost per batch + ₹18 per MH	₹20 per MH

Next, let's see what impact these different allocation techniques and overhead rates would have on the per unit cost of a specific unit of output. Assume that a company manufactures a batch of **5,000** units and it produces 50 units per machine hour, here is how the cost assigned to the units with activity based costing and without activity based costing compares:

	With ABC	Without ABC
Mfg overhead for setting up machine	₹500	₹-0-
No. of units in batch	5,000	Not applicable
Mfg O/H caused by Setup – Per Unit	₹0.10	Not applicable
Mfg overhead costs per machine hour	₹18	₹20
No. of units produced per machine hour	50	50
Mfg O/H caused by Production – Per Unit	₹0.36	₹0.40
Total Mfg O/H Allocated – Per Unit	₹0.46	₹0.40

Stages of Activity Based Costing

The different steps or stages in ABC system can be given as follows:

1. Identify the chosen cost objects

The cost objects of any organization are the products or services and the goal is to first calculate the total cost of manufacturing and distributing these products and their unit cost.



2. Identify the different activities within the organization

After the identification of cost objects, the main activities, which are being performed in the organization, have to be identified. Usually the number of activities over cost centers in ABC will be much more as compared to traditional overhead system. The exact number will depend on how the management subdivides the organizations activities.

3. Identifying the direct cost of products

The direct cost of products or objects may comprise direct material cost, direct labor cost and direct expenses. Classification of as many of the total costs as direct costs as is economically feasible should be made. It reduces the amount of costs classified as indirect.

4. Relating the overhead to the activities

After identifying the organizations activities, the various items of overhead are related to activities both support and primary, that caused them. As a result of relating the items of overhead to various activities, cost pool or cost buckets are created.

5. Spreading the support activities across the primary activities

The spreading of support activities (i.e., activities which support or assist manufacturing) across the primary activities (correlated to the number of units produced) is done on some suitable base which reflects the use of support activity. The base is the cost driver and is measured of how the support activities are used.

6. Determining the activity cost drivers

The determination of the activity cost drivers is done in order to relate the overhead collected in cost pools to the cost objects of products. It is done on the basis of the factor that drives the consumption of the activities.

7. Calculating the activity cost driver rates

The activity cost rates for each activity are calculated in the way in which overhead absorption rates would be calculated under the traditional system. It can be presented as follows:

Activity cost driver rate = Total cost of activity/Activity driver

These activity cost driver rates are to be used for ascertaining the amount of overhead chargeable to various cost objects or products.

8. Computing the total cost of products or cost objects

The total costs of the products shall be computed by adding all direct and indirect costs assigned to them. The amount of overhead chargeable to a product or cost object shall be calculated by multiplying the activity cost drivers rates by different amounts of each activity that each product or other cost object consumes.

Significance of Activity Based Costing

The following list reflects the results of several surveys of practice in the United States, the United Kingdom, and Canada to determine why companies choose ABC.

- Cost Reduction: ABC measures how much activities that are costly and then take steps to reduce their costs by changing the productions process or outsourcing those activities.
- Product pricing and decisions of whether to continue producing a product or keeping a particular customer. ABC implementers generally believe that ABC provides more accurate cost information than conventional costing does. Management can use this information to negotiate price increases with customers or to drop unprofitable products.
- Budgeting and performance measurement: Management can use more accurate cost information to improve budgets and measures of department and division performance.



Advantages of Activity Based Costing

- (i) It provides more accurate product costing information by reducing arbitrary cost allocations.
- (ii) It improves the quality of information available for decision making by answering the questions such as what activities and events are driving cost and where efforts should be made to control cost ?
- (iii) It is easiest way to allocate overhead in the product.
- (iv) It helps to identify the activities that can be eliminated.
- (v) It links up cause and effect relationship.
- (vi) ABC helps to identify the value added activities (that increase the customer's satisfaction) and non- value added activities (that creates the problems in customer's satisfaction)
- (vii) ABC translates cost in to a language that people can understand and that can be linked up to business activities.

Limitations of Activity Based Costing

- (i) More time consuming to collect data
- (ii) Cost of buying, implementing and maintaining activity based system
- (iii) In some cases, the establishment of cause and effect relationship between cost driver and costs not be a simple affair.
- (iv) ABC does not conform to generally accepted accounting principles in some areas.

Conclusion

Activity based costing has revolutionized product costing, planning, and forecasting in the last decade. It is based on a philosophy of estimation that: "it is better to be approximately right, than precisely wrong." In summary, activity-based costing is a management decision-making tool. It provides financial support data structured in a fashion fundamentally different from accounting data provided in the general ledger. By associating cost to the activity, a clear relationship can be established between sources of activity demand and the related costs. This association can benefit the distributor in determining where costs are being incurred, what is initiating the costs and where to apply efforts to curb inflationary costs. This can be of particular value in tracking new products or customers.

Traditional vs. Activity Based Costing

Activity-Based Costing (ABC) is a system that focuses on activities as the fundamental cost objects and uses the cost of these activities for computing the costs of products. There are several reasons why managers are preferring ABC to traditional system.

- (i) In the traditional system cost analysis is done by product. In ABC managers focus attention on activities rather than products because activities in various departments may be combined and costs of similar activities ascertained, e.g. quality control, handling of materials, repairs to machines etc. If detailed costs are kept by activities, the total company costs for each activity can be obtained, analysed, planned and controlled.
- (ii) Managers manage activities and not products. Changes in activities lead to changes in costs. Therefore, if the activities are managed well, costs will fall and resulting products will be more competitive.
- (iii) Allocating overhead cost to production based on a single cost driver (allocation base, such as unit basis, percentage of material, percentage of prime cost, labour hour rate, machine hour rate etc.) can result in an unrealistic product cost because the traditional system fails to capture cause-and-effect relationships. To manage activities better and to make wiser economic decisions, managers need to identify the relationships of causes (activities) and effects (costs) in a more detailed and accurate manner.
- (iv) ABC highlights problem areas that deserve management's attention and more detailed analysis. Many actions are possible, on pricing, on process technology, on product design, on operational movements and on product mix.

Traditional costing can lead to undercosting or overcosting of products or services. Over or under costing of products distorts cost information. A poor quality of cost information causes management to make poor decisions for pricing, product emphasis, make or buy etc. ABC differs from the traditional system only in respect of allocations of overheads or indirect costs. Direct costs are identified with, or assigned to, the cost object, in the same manner as is done in case of traditional costing system. Overhead costs are linked to the cost objects based on activities. This is shown in the following figure:

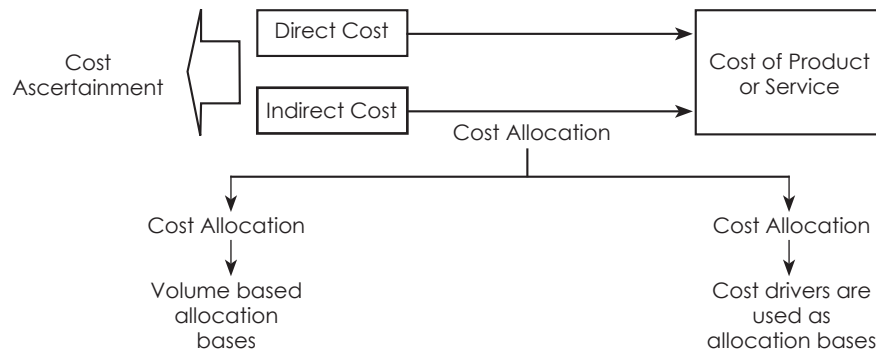

The following figure explains the entire process of cost allocation under ABC.



Illustration 1.

The budgeted overheads and cost driver volumes of XYZ are as follows.

Cost Pool	Budgeted Overheads (₹)	Cost Driver	Budgeted Volume
Material procurement	5,80,000	No. of orders	1,100
Material handling	2,50,000	No. of movements	680
Set-up	4,15,000	No. of set ups	520
Maintenance	9,70,000	Maintenance hours	8,400
Quality control	1,76,000	No. of inspection	900
Machinery	7,20,000	No. of machine hours	24,000

The company has produced a batch of 2,600 components of AX-15, its material cost was ₹ 1,30,000 and labor cost ₹ 2,45,000. The usage activities of the said batch are as follows.

Material orders – 26, maintenance hours – 690, material movements – 18, inspection – 28, set ups – 25, machine hours – 1,800

Calculate – cost driver rates that are used for tracing appropriate amount of overheads to the said batch and ascertain the cost of batch of components using activity Based Costing.

Solution:

Computation of Cost Driver Rates

	Particulars		Amount (₹)
1.	Material procurement	580000/1100	527
2.	Material handling	250000/680	368
3.	Set-up	415000/520	798
4.	Maintenance	970000/8400	115
5.	Quality control	176000/900	196
6.	Machinery	720000/24000	30

**Computation of Batch Cost of 2600 units of AX-15**

		₹
Material cost		1,30,000
Labour Cost		2,45,000
Prime Cost		3,75,000
Add: Overheads		
Material orders 26 x 527	13,702	
Material handling 18 x 368	6,624	
Set-up 25 x 798	19,950	
Maintenance 690 x 115	79,350	
Quality Control 28 x 196	5,488	
Machinery 1800 x 30	54,000	1,79,114
Total Cost		5,54,114

Illustration 2.

A company produces four products, viz. P, Q, R and S. The data relating to production activity are as under

Product	Quantity of production	Material cost/unit ₹	Direct labour hours/unit	Machine hours/unit	Direct Labour cost/unit ₹
P	1,000	10	1	0.50	6
Q	10,000	10	1	0.50	6
R	1,200	32	4	2.00	24
S	14,000	34	3	3.00	18

Production overheads are as under:

	₹
(i) Overheads applicable to machine oriented activity:	1,49,700
(ii) Overheads relating to ordering materials	7,680
(iii) Set up costs	17,400
(iv) Administration overheads for spare parts	34,380
(v) Material handling costs	30,294

The following further information have been compiled:

Product	No. of set up	No. of materials orders	No. of times materials handled	No. of spare parts
P	3	3	6	6
Q	18	12	30	15
R	5	3	9	3
S	24	12	36	12

Required:

- Select a suitable cost driver for each item of overhead expense and calculate the cost per unit of cost driver.
- Using the concept of activity based costing, compute the factory cost per unit of each product.

**Solution:****Computation of Cost Driver Rates**

- 1) Overheads relating to Machinery oriented activity
Cost Driver → Machine Hour Rate
 $(1000 \times 0.5) + (1000 \times 0.5) + (1200 \times 2) + (14000 \times 3)$
 $1,49,700/49,900 = ₹ 3$ per hour
- 2) Overheads relating to ordering materials
Cost driver → No. of Material orders
 $7680/30 = ₹ 256$ per order
- 3) Set up costs
Cost driver → No. of set ups
 $17400/50 = ₹ 348$ per set up
- 4) Administrative Overheads for spare parts
Cost driver → No. of spare parts
 $34380/36 = ₹ 955$ per spare part.
- 5) Material Handling costs
Cost driver → No. of times materials handled
 $30294/81 = ₹ 374$ per material handling

Computation of factory cost for each product

	P		Q		R		S	
Materials		10.00		10.00		32.00		34.00
Labour		6.00		6.00		24.00		18.00
Overheads								
Machine oriented activity	1.500		1.50		6.00		9.00	
Ordering of Materials	0.768		0.31		0.64		0.22	
Set up costs	1.044		0.63		1.45		0.60	
Administrative Spare Parts	5.730		1.43		2.39		0.82	
Material handling	2.244	11.29	1.12	4.99	2.81	13.29	0.96	11.60
Factory Cost (₹)		27.29		20.99		69.29		63.60

Illustration 3.

Precision Auto comp Ltd. Manufactures and sells two automobile components A and B. Both are identical with slight variation in design. Although the market for both the products is the same, the market share of the company for product A is very high and that of product B very low. The company's accountant has prepared the following profitability statement for the two products Cost of production: (same for both the products)

Direct Material	₹	125
Dirbect Labour	₹	24
Direct Expenses (sub-contract charges)	₹	36
Overheads (400% of direct labour)	₹	96
Total Cost	₹	281



		Product A	Product B	Total
Quantity sold	No.	1,24,000	23,150	1,47,150
Unit sale price	₹	300	290	
Total sales realisation	₹			4,39,13,500
Cost of sales as above	₹			4,13,49,150
Margin	₹			25,64,350

The company's marketing manager, after attending a workshop on activity-based costing challenges the accountant's figures. The nearest competitor's prices for the two products are ₹ 330 and ₹ 275 per unit respectively and, if the company can match the competitor's prices, it can sell 75,000 nos. each of the two products. The Production Manager confirms that he can produce this product mix with the existing facilities. The management engages you as consultant, and the following facts have been identified by you:

- product A undergoes 5 operations and product B undergoes two operations by sub-contractors, although the total subcontract charges are the same for both the products, and
- 75% of the overheads is accounted for by three major heads relating to sub-contracting operations, viz., ordering, inspection and movement of components, to and from the sub-contractor's works.

Prepare a revised profitability statement to find out if the marketing manager's proposal is viable.

Solution:

$$\text{Total overheads} = 1,47,150 \times 96 = ₹ 1,41,26,400$$

$$\text{Operations overhead} = 1,41,26,400 \times 75/100 = ₹ 1,05,94,800$$

Balance 25% assumed to be fixed i.e. ₹ 35,31,600

Allocation of Variable Overheads under ABC

$$A = 1,05,94,800 \times 5/7 = ₹ 75,67,714$$

$$B = 1,05,94,800 \times 2/7 = ₹ 30,27,086$$

Statement showing computation profit under Activity Based Costing as per Manager's suggestion:

No. of units		A		B		Total
		Units	75000	Units	75000	
Materials	₹	125	93,75,000	125	93,75,000	1,87,50,000
Labour	₹	24	18,00,000	24	18,00,000	36,00,000
Direct expenses	₹	36	27,00,000	36	27,00,000	54,00,000
Prime Cost	₹	185	1,38,75,000	185	1,38,75,000	2,77,50,000
Variable Overheads	₹	101	75,67,714	40	30,27,086	1,05,94,800
Fixed Overheads	₹	24	17,65,800	24	17,65,800	35,31,600
Total Cost	₹	310	2,32,08,514	249	1,86,67,886	4,18,76,400
Profit	₹	20	15,41,486	26	19,57,114	34,98,600
Sales	₹	330	2,47,50,000	275	2,06,25,000	4,53,75,000

As the profit is more at the Marketing Manager's proposal by ₹ 9,34,250 and hence this proposal may be accepted.

**Illustration 4.**

Relevant data relating to a company are:

	Products			
	P	Q	R	Total
Production and sales (units)	60,000	40,000	16,000	
Raw material usage in units	10	10	22	
Raw material costs	₹ 50	40	22	24,76,000
Direct labour hours	2.5	4	2	3,42,000
Machine hours	2.5	2	4	2,94,000
Direct labour costs	₹ 16	24	12	
No. of production runs	6	14	40	60
No. of deliveries	18	6	40	64
No. of receipts	60	140	880	1,080
No. of production orders	30	20	50	100

Overheads:

₹

Setup	60,000
Machines	15,20,000
Receiving	8,70,000
Packing	5,00,000
Engineering	7,46,000

The company operates a JIT inventory policy and receives each component once per production run.

Required:

- Compute the product cost based on direct labour-hour recovery rate of overheads.
- Compute the product cost using activity based costing.

Solution:**(i)**

Traditional Method of absorption of overhead i.e. on the basis of Direct Labour Hours

$$\begin{aligned} \text{Total overheads} &= \frac{36,96,000}{\text{Hours } (60000 \times 2.5) + (40000 \times 4) + (16000 \times 3)} \\ &= \frac{36,96,000}{3,42,000} = ₹ 10.81 \text{ per labour hour} \end{aligned}$$

Calculation of Factory cost of the products

	P	Q	R
	₹	₹	₹
Raw Material	50=000	40=00	22=00
Direct Labour	16=000	24=00	12=00
Overheads (2.5 x 10.81)	27=025	43=24	21=62
Factory cost	93=000	107=24	55=62

**(ii) Under Activity Based Costing System**

Computation of Cost Drivers Rates.

- 1) Set up cost : Cost driver → No. of Production run
 $60000/60 = ₹ 1000/\text{per run}$
- 2) Machines : Cost driver → Machine hour rate
 $15,20,000/2,94,000 = ₹ 5.17 \text{ per Machine hour rate}$
- 3) Receiving cost: Cost driver → No. of Receipts
 $8,70,000/1080 = ₹ 805.56$
- 4) Packing : Cost driver → No. of deliveries
 $5,00,000/64 = ₹ 7812.5 \text{ per delivery}$
- 5) Engineering: Cost driver → No. of Production order
 $7,46,000/100 = ₹ 7,460 \text{ per order}$

Calculation of Factory Cost per unit of Production

	P		Q		R	
	₹	₹	₹	₹	₹	₹
Materials		50.00		40.00		22.00
Direct Labour		16.00		24.00		12.00
Overheads						
Setup cost	0.10		0.35		2.50	
Machines	12.93		10.34		20.68	
Receiving cost	0.81		2.82		44.31	
Packing	2.34		1.17		19.53	
Engineering	3.73	19.91	3.73	18.41	23.31	110.33
Factory Cost		85.91		82.41		144.33

Illustration 5.

Trimake Limited makes three main products, using broadly the same production methods and equipment for each. A conventional product costing system is used at present, although an Activity Based Costing (ABC) system is being considered. Details of the three products, for typical period are:

	Labour Hours per unit	Machine Hours per unit	Material Per unit	Volumes Units
Product X	½	1 ½	₹ 20	750
Product Y	1 ½	1	12	1,250
Product Z	1	3	25	7,000

Direct labour costs ₹ 6 per hour and production overheads are absorbed on a machine hour basis. The rate for the period is ₹ 28 per machine hour.

You are required:

- (a) to calculate the cost per unit for each product using conventional methods.



Further analysis shows that the total of production overheads can be divided as follows

	%
Costs relating to set-ups	35
Costs relating to machinery	20
Costs relating to materials handling	15
Costs relating to inspection	<u>30</u>
Total production overhead	<u>100%</u>

The following activity volumes are associated with the product line for the period as a whole.

Total activities for the period

	Number of Set-ups	Number of movements of materials	Number of Inspections
Product X	75	12	150
Product Y	115	21	180
Product Z	480	87	670
	<u>670</u>	<u>120</u>	<u>1,000</u>

You are required:

- (b) To calculate the cost per unit for each product using ABC principles; c) to comment on the reasons for any differences in the costs in your answers to (a) and (b)

Solution:

(a) Computation of cost per unit using Conventional Methods:

Total overheads	₹
X = 750 x 1.5 x 28 =	31,500
Y = 1250 x 1 x 28 =	35,000
Z = 7000 x 3 x 28 =	<u>5,88,000</u>
	<u>6,54,500</u>

Computation of Cost

	X	Y	Z
	₹	₹	₹
Materials	20	12	25
Labour	3	9	6
Overheads	42	28	84
Factory Cost	65	49	115

(b) Under ABC Costing

		Setup Cost	Machine Cost	Material Handling Cost	Inspection Expenses	Total
Costs	₹	2,29,075	1,30,900	98,175	1,96,350	6,54,500
Cost Driver		No. of setups	Machine hours	No. of Moment of Materials	No. of Inspections	
Cost driver rates	₹	341.90	5.6	818.125	196.35	
		(229075/670)	(130900/23375)	(98,175/120)	(196350/1000)	

Cost per unit under ABC costing

	X		Y		Z	
	₹	₹	₹	₹	₹	₹
Materials		20.00		12.00		25.00
Labour		3.00		9.00		6.00
Overheads						
Setup Cost	34.19		31.45		23.44	
Machine cost	8.40		5.60		16.80	
Machine Handling Cost	13.09		13.74		10.17	
Inspection Cost	39.27	94.95	28.27	79.06	18.79	69.20
Total Cost		117.95		100.06		100.20

Note: Computation of Machine Hours = $(750 \times 1.5) + (1250 \times 1) + (7000 \times 3) = 23,375$.

4.2 JUST-IN-TIME (JIT)

Just in time (JIT) is a 'pull' system of production, so actual orders provide a signal for when a product should be manufactured. Demand-pull enables a firm to produce only what is required, in the correct quantity and at the correct time.

This means that stock levels of raw materials, components, work in progress and finished goods can be kept to a minimum. This requires a carefully planned scheduling and flow of resources through the production process. Modern manufacturing firms use sophisticated production scheduling software to plan production for each period of time, which includes ordering the correct stock. Information is exchanged with suppliers and customers through **EDI (Electronic Data Interchange)** to help ensure that every detail is correct.

Supplies are delivered right to the production line only when they are needed. For example, a car manufacturing plant might receive exactly the right number and type of tyres for one day's production, and the supplier would be expected to deliver them to the correct loading bay on the production line within a very narrow time slot.

The JIT Strategy

By taking a JIT approach to inventory and product handling, companies can often cut costs significantly. Inventory costs contribute heavily to the company expenses, especially in manufacturing organizations. By minimizing the amount of inventory you hold, you save space, free up cash resources, and reduce the waste that comes from obsolescence.

JIT Systems

To facilitate a JIT approach, you need a variety of systems in place. The most notable is a kanban. This is a Japanese approach to ensuring a continuous supply of inventory or product. Kanbans were designed to support the JIT philosophy.

A kanban is a visual signal that indicates it is time to replenish stock and possibly reorder. For instance, as the supply of bolts in a bin on the assembly line falls below a certain number, it may uncover a yellow line painted around the inside of the storage bin. This yellow line indicates to the foreman that he needs to prepare a requisition for more bolts. That requisition is given to the purchasing department, which processes the order. This prevents the supply of bolts from dropping below a critical amount and allows production continues to flow smoothly.

JIT also exists in concert with continuous improvement systems. Total Quality Management and Six Sigma are overarching programs that help you take a detailed look at every point of the production process and identify ways to make improvements. By applying JIT, you are continuously monitoring the production process. This gives you opportunities for making the production process smoother and more efficient.



Because JIT is intended to spread throughout the organization, it can have an impact on many areas through improvements in processes. When the emphasis is on lean production, systems tend to be made simpler and more predictable. From how a product moves through the building to ways to increase worker involvement in system design, JIT improves efficiency.

Advantages of Just-In-Time System

Following are the advantages of adopting Just-In-Time Manufacturing System:

- (i) Just-in-time manufacturing keeps stock holding costs to a bare minimum. The release of storage space results in better utilization of space and thereby bears a favorable impact on the rent paid and on any insurance premiums that would otherwise need to be made.
- (ii) Just-in-time manufacturing eliminates waste, as out-of-date or expired product; do not enter into this equation at all.
- (iii) As under this technique, only essential stocks are obtained, less working capital is required to finance procurement. Here, a minimum re-order level is set, and only once that mark is reached fresh stocks are ordered, making this a boon to inventory management too.
- (iv) Due to the afore-mentioned low level of stocks held, the organization's return on investment (referred to as ROI, in management parlance) would generally be high.
- (v) As just-in-time production works on a demand-pull basis, all goods made would be sold, and thus it incorporates changes in demand with surprising ease. This makes it especially appealing today, where the market demand is volatile and somewhat unpredictable.
- (vi) Just-in-time manufacturing encourages the right first time concept, so that inspection costs and cost of rework is minimized.
- (vii) High quality products and greater efficiency can be derived from following a just-in-time production system.
- (viii) Close relationships are fostered along the production chain under a just-in-time manufacturing system.
- (ix) Constant communication with the customer results in high customer satisfaction.
- (x) Over production is eliminated, when just-in-time manufacturing is adopted.

Disadvantages:

Following are the disadvantages of adopting Just-In-Time Manufacturing Systems:

- (i) Just-in-time manufacturing provides zero tolerance for mistakes, as it makes re-working very difficult in practice, as inventory is kept to a bare minimum.
- (ii) There is a high reliance on suppliers, whose performance is generally outside the purview of the manufacturer.
- (iii) As there will be no buffers for delays, production downtime and line idling can occur, which would bear a detrimental effect on finances and on the equilibrium of the production process.
- (iv) The organization would not be able to meet an unexpected increase in orders, due to the fact that there are no excess finish goods.
- (v) Transaction costs would be relatively high, as frequent transactions would be made.
- (vi) Just-in-time manufacturing may have certain detrimental effects on the environment, due to the frequent deliveries that would result in increased use of transportation which in turn would consume more fossil fuels.

Precautions:

Following are the things to Remember When Implementing a Just-In-Time Manufacturing System:

- (i) Management buy-in and support at all levels of the organization are required; if a just-in-time manufacturing system is to be successfully adopted.



- (ii) Adequate resources should be allocated, so as to obtain technologically advanced software, that is generally required if a just-in-time system is to be a success.
- (iii) Building a close, trusting relationship with reputed and time-tested suppliers will minimize unexpected delays in the receipt of inventory.
- (iv) Just-in-time manufacturing cannot be adopted overnight. It requires commitment in terms of time and adjustments to corporate culture would be required, as it is starkly different to traditional production processes.
- (v) The design flow process needs to be redesigned and layouts need to be re-formatted, so as to incorporate just-in-time manufacturing.
- (vi) Lot sizes need to be minimized.
- (vii) Work station capacity should be balanced whenever possible.
- (viii) Preventive maintenance should be carried out, so as to minimize machine breakdowns.
- (ix) Set up times should be reduced wherever possible.
- (x) Quality enhancement programs should be adopted, so that total quality control practices can be adopted.
- (xi) Reduction in lead times and frequent deliveries should be incorporated.
- (xii) Motion waste should be minimized, so the incorporation of conveyor belts might prove to be a good idea when implementing a just-in-time manufacturing system.

Just-in-time manufacturing is a philosophy that has been successfully implemented in many manufacturing organizations.

It is an optimal system that reduces inventory whilst being increasingly responsive to customer needs. This is not to say that it is not without its pitfalls.

However, these disadvantages can be overcome, with a little forethought and a lot of commitment at all levels of the organization.

Illustration 6.

B Ltd. has decided to adopt JIT policy for materials. The following effects of JIT policy are identified-

- (1) To implement JIT, the company has to modify its production and material receipt facilities at a capital cost of ₹10,00,000. The new machine will require a cash operating cost ₹1,08,000 p.a. The capital cost will be depreciated over 5 years.
- (2) Raw material stockholding will be reduced from ₹40,00,000 to ₹10,00,000.
- (3) The company can earn 15% on its long-term investments.
- (4) The company can avoid rental expenditure on storage facilities amounting to ₹33,000 per annum. Property Taxes and insurance amounting to ₹22,000 will be saved due to JIT programme.
- (5) Presently there are 7 workers in the store department at a salary of ₹5,000 each per month. After implementing JIT scheme, only 5 workers will be required in this department. Balance 2 workers' employment will be terminated.
- (6) Due to receipt of smaller lots of Raw Materials, there will be some disruption of production. The costs of stock-outs are estimated at ₹77,000 per annum.

Determine the financial impact of the JIT policy. Is it advisable for the company to implement JIT system?

**Solution:****Cost-Benefit Analysis of JIT policy**

Costs	₹	Benefits	₹
Interest on capital for modifying production facilities (₹10,00,000×15%)	1,50,000	Interest on investment on released funds (₹40,00,000-₹10,00,000) ×15%	4,50,000
Operating Costs of new production facilities	1,08,000	Saving in salary of 2 workers terminated (₹5,000×12 months×2)	1,20,000
Depreciation of new production facilities	Nil	Saving in rental Expenditure	33,000
Stock-Outs Costs (given)	77,000	Saving in Property Tax & Insurance	22,000
Net Benefit due to JIT policy	2,90,000		
Total	6,25,000	Total	6,25,000

Conclusion: The JIT policy may be implemented, as there is a Net Benefit of ₹2,90,000 per annum.

Note: Depreciation, being apportionment of capital cost, is ignored in decision-making, Tax Saving on Depreciation is not considered in the above analysis.

Illustration 7.

Dandia Ltd. follows JIT system. It had following transactions in May, 2014:

- (i) Raw materials were purchased for ₹2,00,000.
- (ii) Direct labour cost incurred ₹36,000
- (iii) Actual overhead costs ₹3,00,000
- (iv) Conversion costs applied ₹3,16,000

All materials, that were purchased, were placed into production and the production was also completed and sold during the month. The difference between actual and applied costs is computed.

You are required to pass both Traditional journal entries and Backflush journal entries.

Solution:

In the books of Dandia Ltd.
Journal Entries (Traditional)

Particulars	Debit (₹)	Credit (₹)
Material A/c.....Dr.	2,00,000	
To, Accounts Payable		2,00,000
(being purchase of raw materials)		
WIP A/c.....Dr.	2,00,000	
To, Materials A/c		2,00,000
(being materials issued to production)		
WIP A/c.....Dr.	36,000	
To, Direct wages A/c		36,000
(being direct labour cost incurred)		
Overhead Control A/c.....Dr.	3,00,000	
To, Accounts Payable		3,00,000



(being overhead cost incurred)		
WIP A/c.....Dr.	2,80,000	
To, Overhead Control A/c		2,80,000
(Being application of overhead)		
Finished Goods A/c.....Dr.	5,16,000	
To, WIP A/c		5,16,000
(Being completion of goods)		
Cost of Goods Sold A/c.....Dr.	5,16,000	
To, Finished Goods		5,16,000
(being cost of finished goods sold transferred)		
Cost of Goods Sold A/c.....Dr.	20,000	
To, Overhead Control A/c		20,000
(being variance is recognized)		

In the books of Dandia Ltd.

Journal Entries (Backflush)

Particulars	Debit (₹)	Credit (₹)
Raw Material in Process A/c.....Dr.	2,00,000	
To, Accounts Payable		2,00,000
(being purchase of raw materials)		
Conversion Cost Control A/c.....Dr.	3,36,000	
To, Direct wages A/c		36,000
To, Accounts Payable		3,00,000
(being overhead cost incurred)		
Finished Goods A/c.....Dr.	5,16,000	
To, Raw Material in Process A/c		2,00,000
To, WIP A/c		3,16,000
(Being completion of goods)		
Cost of Goods Sold A/c.....Dr.	5,16,000	
To, Finished Goods		5,16,000
(being cost of finished goods sold transferred)		
Cost of Goods Sold A/c.....Dr.	20,000	
To, Overhead Control A/c		20,000
(being variance is recognized)		

Illustration 8.

Altra Video Company sells package of blank Video tapes to its customers. It purchases video tapes from Yash Tape Company at ₹150 per packet. Yash Tape Company pays all freight to Altra Video Company. No incoming inspection is necessary because Yash Tape Company has a superb reputation for delivery of quality merchandise. Annual demand of Altra Video Company is 15,600 packages. Altra Video Company requires 10% annual return on its investment. The purchase order Lead time is 2 weeks. The purchase order is passed through internet and it costs ₹20 per order. The relevant insurance, material handling etc. is ₹10 per package per year.

Altra Video has to decide whether or not to shift to JIT purchasing. Yash Tape Company agrees to deliver 100 packages of Video tapes 156 times per year (6 times every 2 weeks) instead of existing delivery system of 1,200 packages 13 times a year, with additional amount of Re.0.05 per package. Altra Video Company incurs no stock out under its current purchasing policy. It is estimated that Altra Video Company will incur stock out cost on 50 video tape packages under a JIT purchasing policy. In the event of stock out, Altra video company has to rush order tape packages, which costs ₹8 per package. Comment whether Altra Video Company should implement JIT purchasing system.

Ram Co. also supplies video tapes. It agrees to supply at ₹145 per package under JIT delivery system. If video tape is purchased from Ram Co. relevant carrying cost would be ₹9 per package against ₹10 in case of purchasing from Yash Tape Company. However Ram Co. does not enjoy a sterling reputation for quality, Altra Video Company anticipates the following negative aspects of purchasing tapes from Ram Co.

- (1) Incurring additional inspection cost of ₹0.05 per package.
- (2) Average stock out of 360 tape packages per year would occur, largely resulting from late deliveries. Ram Co. cannot rush order at short notice. Altra Video Company anticipates lost contribution margin per package of ₹10 from stock out.
- (3) Customers would likely return 2% of all packages due to poor quality of the tape and to handle this return, an additional cost of ₹25 per package would be incurred.

Comment on whether Altra Video Company can place an order with Ram Co.

Solution:

(1) Computation of Carrying Costs

Carrying Cost = Interest + Others (Insurance, Material Handling, etc.), which is calculated as under:-

Particulars	Current Policy	JIT with Yash Tape Co.	JIT with Ram Co.
(i) Interest cost	₹150×10% = ₹15.00	₹150.05×10% = ₹15.005	₹145×10% = ₹14.50
(ii) Others	₹10.00	₹10	₹9.00
(a) Total carrying cost p.u. p.a.	₹25.00	₹25.005	₹23.50
(b) Average Inventory	1/2 x 1200 = 600 units	1/2 x 100 = 50 units	1/2 x 100 = 50 units
(c) Carrying Costs p.a. (a× b)	₹15,000	₹1,250	₹1,175

(2) Comparative Statement of Relevant Annual Costs of Purchasing Policies

Particulars	Current policy	JIT with Yash Tape Co.	JIT with Ram Co.
(a) Cost of tapes purchased	15,600 tapes×₹150 =₹23,40,000	15,600 tapes×₹150.05 =23,40,780	15,600 tapes ×₹145 =₹22,62,000
(b) Ordering or buying costs	13 orders×₹20=₹260	156 orders×₹20=₹3,120	156 orders×₹20=₹3,120
(c) Carrying costs [As calculated in (1)]	₹15,000	₹1,250	₹1,175
(d) Stock out costs	Nil	50 units×₹8=₹400	360 units×₹10=₹3,600
(e) Inspection Costs	Nil	Nil	15,600 units×0.05=₹780
(f) Customer Return costs	Nil	Nil	15,600 units×2%×₹25 =₹7,800
Total Relevant costs	₹23,55,260	₹23,45,550	₹22,78,475



Conclusions:

- (1) Compared to present system, JIT with Yash Tape Co. will result in cost saving of ₹23,55,260 - ₹23,45,550 = ₹9,710. Hence, JIT system may be implemented.
- (2) Comparing present system, JIT with Yash Tape Co and Ram Co., JIT with Ram Co. results in the least total cost. Hence, the packages may be bought from Ram Co.

4.3 ENTERPRISE RESOURCE PLANNING (ERP)

Enterprise Resource Planning (ERP) is the latest high-end solution which information technology has lent to business application. The ERP solution seek to streamline and integrate operation process and information flows in the company to synergies the resources of an organisation namely men, material, money and machine though information. Initially implementation of an ERP packages was possible only for large multinationals and infrastructure companies due to high cost. Today, many companies in India have gone in for implementation of ERP. It is expected that in the next future, 60 per cent of the companies will be implementing one or the other ERP packages since this will become a must for gaining competitive advantage.

Meaning of ERP : Enterprise resource planning software or ERP attempts to integrate all departments and functions across a company into a single computer system that can serve all those different departments particular needs. In fact ERP combines all computerised departments together with the help of a single integrate software program that runs off as single database so that various department can more easily share information and commission with each other.

The need for ERP : Most organisation across the world have realised that in a rapidly changing environment, it is impossible to creates and maintain customer designed software package which will cater to all their requirements and be up-to-date. Realising the requirement of user organisations, some of the leading software companies have designed Enterprise Resource Planning software, which offers an integrated software solution to all the function of an organisation.

Components of ERP : To enable the easy handling of the system, ERP has been divided the following core subsystems, sales and marketing, master scheduling, materials requirements planning, capacity requirement planning, bill of materials, purchasing, shop floor control, accounts payable/receivable , logistic, assets management and financial accounting.

Features of Enterprise Resource Planning

Some of the major features of ERP and What ERP can do for the business system are :

- (i) ERP facilities company—wide Integrated Information System covering all functional areas like manufacturing, selling and distribution, payables, receivables, inventory, accounts, human resources, purchases etc.
- (ii) ERP perform core activities and increases customers service, thereby augmenting the corporate image.
- (iii) ERP bridge the information gap across organisations.
- (iv) ERP provides complete integration of system not only across departments but also across companies under the same management.
- (v) ERP is the solution for better project management.
- (vi) ERP allows automatic introduction of the latest technologies like Electronic Fund Transfer (EFT). Electronic Data Interchange (EDI), Internet, Intranet, Video conferencing, E—commerce etc.
- (vii) ERP eliminates most business problems like materials shortages, productivity enhancements, customer service, cash management, inventory problems, quality problems, prompt delivery etc.
- (viii) ERP not only addresses the current requirement of the company but also provide the opportunity of continually improving and refining business Processes.



- (ix) ERP provides business intelligence tools like Decision Support Systems (DSS), Executive Information System (EIS), Reporting, Data Mining and Early warning systems (Robots) for enabling people to make better decisions and thus improve their business processes.

Benefits of Enterprise Resource Planning

In an industry this is sensitive to dynamic market forces, cost fluctuations and manufacturing responsiveness, there are many benefits to be gained from investing in ERP. ERP application have shifted from assisting after—the—fact monitoring to real—time analysis, control and forecasting and from facilitating standardization, economies to scale and cost reduction in product, to enabling fast, flexible and accurate response and customization.

The benefits accruing to any business enterprise by implementing an ERP package are unlimited.

1. **Product Costing** : Determination of cost of products correctly, is quite critical for every industry. ERP supports advance costing methods, including standard costing, actual costing and activity –based costing. Additionally, all costing methods and information can be fully integrated with finance. This provides the company with essential financial information for monitoring controlling costs.
2. **Inventory Management** : ERP can be used in multi-national, multi – company, and multi—site manufacturing and distribution environments. This system simplifies complicated logistics by allowing one to plan and manage companies in different countries as a single unit and its advanced functionality allows one to process product and financial information flows in several different ways.

Enterprise and managing the basis data required to effectively run one's business is an important start for effective warehouse management. The basis data includes warehouse, locations, items containers, lot and serial number, units of measures (including conversion), alias numbers, replacement and substitute items and more.

Inventory reporting supports all reporting of specific and general types of stock transaction such as various types of stock transfers, re-classification, ID changes and physical inventory results. Additionally, functions are available for managing different stock and purchase requisitions as well as supporting the selection of appropriate locations for receipts. Inventory valuation involves both warehouse management and cost accounting. ERP supports several valuation methods including standard cost, average cost, FIFO and batch—specific prices.

3. **Distribution & Delivery** : Delivery and distribution in ERP lets one to define logistics processes, flexibly and efficiently to deliver the right product from the right warehouse to the right customer at the right time –every time. To the customer, the most important element of quality is one-time delivery. It doesn't matter how well a product is made if arrives late. Processing distribution or acquisition orders involves several closely related activities.
4. **E – Commerce** : Internet enables ERP offers Internet, Intranet and extranet solutions for business, business to consumer, employee self-service and more.
5. **Automatic Control** : It ensure automatic quality control procedure.
6. **After Sales Service** : It ensures better after sales service.
7. **Improvement in Production Planning** : It improved production planning.
8. **Quick response** : It enables quick response to change in business operations & market conditions.
9. **Cumulative Edge's** : It helps to achieve competitive advantages by improving business process.

Reasons for the Implementation of ERP by Companies

1. **Improve a company's business performance** : ERP automates the tasks involved in performing a business process – such as order fulfillment which involves taking an order from a customer, shipping it and billing for it. With ERP, When a customer service representative takes an order from a customer, he or she has all the



information necessary to complete the order (the customer's credit rating and order history, the company's inventory levels and the shipping dock's trucking schedule). Everyone else in the company sees the same computer screen and has access to the single database that holds the customer's new order. When one departments finishes with the order it automatically routed via the ERP system to the next department. To find out where the order is at any point, one need only to log into the ERP system and track it down. With luck, the order process moves like a bolt of lightning through the organisation, and customers get their orders faster and with fewer errors than before. ERP can apply that same magic to the other major business processes, such as employee benefits or financial reporting.

2. **Standardize manufacturing processes** : Manufacturing companies --- especially those with an appetite for mergers and acquisitions --- often find that multiple business units across the company make the same widget using different methods and computer systems, Standardizing those processes and using a single, integrated computer system can save time, increase productivity & reduce headcount.
3. **Integrate Financial data** : As the CEO tries to understand the company's overall performance, he or she may find many different versions of the truth. Finance has its own set of revenue numbers, sales has another version, and the different business units may each have their own versions of how much they contributed to revenues. ERP creates a single version of the truth that cannot be questioned because everyone is using the same system.
4. **To standardise HR information** : Especially in companies with multiple business units, HR may not have a unified, simple method for tracking employee time and communicating with them about benefits and services. ERP can fix that.
5. **Reduction in cycle time** : Cycle time is the time between receipt of the order and delivery of the product. ERP systems are helpful in both make-to -order and make-to-stock situations. In both cases, cycle time can be reduced by the ERP systems, but the reduction will be more in the case of make-to-order systems. ERP packages go a long way in reducing the cycle times due to automation achieved in material procurement, production planning and the efficiency achieved through the plant maintenance and production systems of the ERP packages.
6. **Improved Resource Utilization** : As manufacturing processes become more sophisticated and as the philosophies of elimination of waste and constraint management achieve broader acceptance, manufacturer place increased emphasis upon planning and controlling capacity. The capacity planning feature of ERP systems offer both rough-cut and detailed capacity planning. The system loads each resource with production requirements from Master Production Scheduling, Materials Requirements Planning and Shop-floor Control. The ERP systems have simulation capabilities that help the capacity and resource planners to simulate the various capacity and resource utilization scenarios and choose the best option. The ERP systems help the organisation in drastically improving the capacity and resource utilization.
7. **Better Customer Satisfaction** : Customer satisfaction means meeting or exceeding customer's requirements for a product or service. The customer could get technical support by either accessing the company's technical support knowledge base (help desk) or by calling the technical support. Since all the details of the product and the customer are available to the person at the technical support department, the company will be able to better support the customer. All this is possible because of use of latest developments in information technology by the ERP systems.
8. **Improved Supplier Performance** : The quality of the raw materials or components and the capability of the vendor to deliver them ontime are of critical importance for the success of any organisation. For this reason, an organisation chooses its suppliers or vendors very carefully and monitor their activities very closely. To realise these benefits, corporations rely heavily on supplier management and control systems to help, plan, manage and control the complex processes associated with global supplier partnerships.



4.4 BENCH MARKING

Definitions:

Benchmarking: Traditionally control involves comparison of the actual results with an established standard or target. The practice of setting targets using external information is known as 'Benchmarking'.

Benchmarking is the establishment - through data gathering of targets and comparatives, with which performance is sought to be assessed.

After examining the firm's present position, benchmarking may provide a basis for establishing better standards of performance. It focuses on improvement in key areas and sets targets which are challenging but evidently achievable. Benchmarking implies that there is one best way of doing business and orients the firm accordingly. It is a catching-up exercise and depends on the accurate information about the comparative company - be it inside the group or an outside firm.

Benchmarking is the continuous process of enlisting the best practices in the world for the process, goals and objectives leading to world-class levels of achievement.

Types of Benchmarking:

The different types of Benchmarking are:

- (i) Product Benchmarking (Reverse Engineering)
- (ii) Competitive Benchmarking
- (iii) Process Benchmarking
- (iv) Internal Benchmarking
- (v) Strategic Benchmarking
- (vi) Global Benchmarking

(i) Product Benchmarking (Reverse Engineering): is an age old practice of product oriented reverse engineering. Every organization buys its rival's products and tears down to find out how the features and performances etc., compare with its products. This could be the starting point for improvement.

(ii) Competitive Benchmarking: This has moved beyond product-oriented comparisons to include comparisons of process with those of competitors. In this type, the process studied may include marketing, finance, HR, R&D etc.,

(iii) Process Benchmarking: is the activity of measuring discrete performance and functionality against organization through performance in excellent analogous business process e.g. for supply chain management - the best practice would be that of Mumbai Dabbawallas.

(iv) Internal Benchmarking: is an application of process benchmarking, within an organization by comparing the performance of similar business units or business process.

(v) Strategic Benchmarking: differs from operational benchmarking in its scope. It helps to develop a vision of the changed organizations. It will develop core competencies that will help sustained competitive advantage.

(vi) Global Benchmarking: is an extension of Strategic Benchmarking to include benchmarking partners on a global scale. E.g. Ford Co. of USA benchmarked its A/c payable functions with that of Mazda in Japan and found to its astonishment that the entire function was managed by 5 persons as against 500 in Ford.

Benchmarking and difference with Benchmarking

Benchmarking: Continuous monitoring of specific process performance with a selected group of benchmarking is a systematic and continuous measurement process of comparing through measuring an organization business processes against business leaders (role models) anywhere in the world, to gain information that will help



organization take action to improve its performance. The continuous process of enlisting the best practices in the world for the processes, goals and objectives leading to world class levels of achievement.

Benchmarking is the process of comparing the cost, time or quality of what one organization does against what another organization does. The result is often a business case for making changes in order to make improvements.

Benchmarking is a powerful management tool because it overcomes "paradigm blindness". Paradigm Blindness can be summed up as the mode of thinking, "the way we do it is the best because this is the way we've always done it". Bench Marking opens organizations to new methods, ideas and tools to improve their effectiveness. It helps crack through resistance to change by demonstrating other methods of solving problems than the one currently employed and demonstrating that they work, because they are being used by others.

- (a) Identify your problem areas.
- (b) Identify other industries that have similar processes.
- (c) Identify organizations that are leaders in these areas.
- (d) Survey companies for measures and practices
- (e) Visit the "best practice" companies to identify leading edge practices.
- (f) Implement new and improved business practices.

Stages in the process of Bench Marking

The process of benchmarking involves the following stages:

Stage	Description
1	Planning -
	a) Determination of Benchmarking goal statement,
	b) Identification of best performance
	c) Establishment of the benchmarking or process improvement team, and
	d) Defining the relevant benchmarking measures
2	Collection of Data and Information
3	Analysis of the findings based on the data collected in Stage 2
4	Formulation and implementation of recommendations
5	Constant monitoring and reviewing

Various stages in the process of Bench Marking detailed understanding

Stage 1: Planning

- (a) Determination of benchmarking goal statement: This requires identification of areas to be benchmarked, which uses the following criteria –

Benchmark for Customer Satisfaction	Benchmark for improving Bottom line (Profit)
• Consistency of product or service	• Waste and reject levels
• Process cycle time	• Inventory levels
• Delivery performance	• Work-in-progress
• Responsiveness to customer requirements	• Cost of Sales
• Adaptability to special needs	• Sales per employee

- (c) Identification of best performance: The next step is seeking the "best". To arrive at the best is both expensive and time consuming, so it is better to identify a Company which has recorded performance success in a similar area.



- (d) Establishment of the benchmarking or process improvement team: This should include persons who are most knowledgeable about the internal operations and will be directly affected by changes due to benchmarking.
- (e) Defining the relevant benchmarking measures: Relevant measures will not be restricted to include the measures used by the Firm today, but they will be refined into measures that comprehend the true performance differences. Developing good measurement is key or critical to successful benchmarking.

Stage 2: Collection of data and information: This involves the following steps –

- (a) Compile information and data on performance. They may include mapping processes.
- (b) Select and contact partners.
- (c) Develop a mutual understanding about the procedures to be followed and, if necessary, prepare a Benchmarking Protocol with partners.
- (d) Prepare questions and agree terminology and performance measures to be used.
- (e) Distribute a schedule of questions to each partner.
- (f) Undertake information and data collection by chosen method for example, interviews, site-visits, telephone fax and e-mail.
- (g) Collect the findings to enable analysis.

Stage 3: Analysis of findings:

- (a) Review the findings and produce tables, charts and graphs to support the analysis
- (b) Identify gaps in performance between our Firm and better performers.
- (c) Seek explanations for the gaps in performance. The performance gaps can be positive, negative or zero.
- (d) Ensure that comparisons are meaningful and credible
- (e) Communicate the findings to those who are affected.
- (f) Identify realistic opportunities for improvements. The negative performance gap indicates an undesirable competitive position and provides a basis for performance improvement. If there is no gap it may indicate a neutral position relative to the performance being benchmarked. The zero position should be analysed for identifying means to transform its performance to a level of superiority or positive gap.

Stage 4: Recommendations:

Making recommendations	Implementing recommendations
<ul style="list-style-type: none"> • Deciding the feasibility of making the improvements in the light of conditions that apply within own Firm 	Implement the action plans
<ul style="list-style-type: none"> • Agreement on the improvements that are likely to be feasible 	Monitor performance
<ul style="list-style-type: none"> • Producing a report on the Benchmarking in which the recommendations are included 	Reward and communicate success.
<ul style="list-style-type: none"> • Obtaining the support of owners/management for making the changes needed. 	Keep owners/management informed of progress
<ul style="list-style-type: none"> • Developing action plan(s) for implementation. 	

Stage 5: Monitoring and reviewing: This involves –

- (a) Evaluating the benchmarking process undertaken and the results of the improvements against objectives and success criteria plus overall efficiency and effectiveness.
- (b) Documenting the lessons learnt and make them available to others.
- (c) Periodically re-considering the benchmarks for continuous improvement.



Pre-requisites of Bench Marking

1. **Commitment:** Senior Managers should support benchmarking fully and must be committed to continuous improvements.
2. **Clarity of Objectives:** The objectives should be clearly defined at the preliminary stage. Benchmarking teams have a clear picture of their Firm's performance before approaching others for comparisons.
3. **Appropriate Scope:** The scope of the work should be appropriate in the light of the objectives, resources, time available and the experience level of those involved.
4. **Resources:** Sufficient resources must be available to complete projects within the required time scale.
5. **Skills:** Benchmarking teams should have appropriate skills and competencies.
6. **Communication:** Stakeholders, and also staff and their representatives, are to be kept informed of the reasons for benchmarking.

Define difficulties in implementation of Bench Marking

1. **Time consuming:** Benchmarking is time consuming and at times difficult. It has significant requirement of staff time and Company resources. Companies may waste time in benchmarking non-critical functions.
2. **Lack of management Support:** Benchmarking implementation requires the direct involvement of all managers. The drive to be best in the industry or world cannot be delegated.
3. **Resistance from employees:** It is likely that there may be resistance from employees.
4. **Paper Goals:** Companies can become pre-occupied with the measures. The goal becomes not to improve process, but to match the best practices at any cost.
5. **Copy-paste attitude:** The key element in benchmarking is the adaptation of a best practice to tailor it to a company's needs and culture. Without that step, a company merely adopts another company's process. This approach condemns benchmarking to fail leading to a failure of benchmarking goals.



Study Note - 5

COST OF QUALITY AND TOTAL QUALITY MANAGEMENT



This Study Note includes

- 5.1 Total Quality Management (TQM)
- 5.2 Praise Analysis
- 5.3 Six Sigma
- 5.4 Pareto Analysis
- 5.5 Quality Costs

5.1 TOTAL QUALITY MANAGEMENT (TQM)

Total Quality Management is a philosophy of continuously improving the quality of all the products and processes in response to continuous feedback for meeting the customers' requirements. It aims to do things right the first time, rather than need to fix problems after they emerge (A company should avoid defects rather than correct them). Its basic objective is customer satisfaction.

The elements of TQM are:

Total	Quality involves everyone and all activities in the company (Mobilizing the whole organization to achieve quality continuously and economically)
Quality	Understanding and meeting the customers' requirements. (Satisfying the customers first time every time)
Management	Quality can and must be managed (Avoid defects rather than correct them)

TQM is a vision based, customer focused, prevention oriented, continuously improvement strategy based on scientific approach adopted by cost conscious people committed to satisfy the customers first time every time. It aims at Managing an organization so that it excels in areas important to the customer.

The underlying principles of TQM:

The philosophy of TQM rest on the following principles which are enlisted below:

1. Clear exposition of the benefits of a project.
2. Total Employee involvement (TEI).
3. Process measurement.
4. Involvement of all customers and contributors.
5. Elimination of irrelevant data.
6. Understanding the needs of the whole process.
7. Use of graphical and pictorial techniques to achieve understanding.
8. Establishment of performance specifications and targets.
9. Use of errors to prompt continuous improvement.
10. Use of statistics to tell people how well they are doing



Steps in Total Quality Management:

Step 1: Identification of customers/customer groups:

Through a team approach (a technique called Multi-Voting), the Firm should identify major customer groups. This helps in generating priorities in the identification of customers and critical issues in the provision of decision-support information.

Step 2: Identifying customer expectations:

Once the major customer groups are identified, their expectations are listed. The question to be answered is - What does the customer expect from the Firm?

Step 3: Identifying customer decision-making requirements and product utilities:

By identifying the need to stay close to the customers and follow their suggestions, a decision-support system can be developed, incorporating both financial and non-financial information, which seeks to satisfy user requirements. Hence, the Firm finds out the answer to - What are the customer's decision-making requirements and product utilities? The answer is sought by listing out managerial perceptions and not by actual interaction with the customers.

Step 4: Identifying perceived problems in decision-making process and product utilities:

Using participative processes such as brainstorming and multi-voting, the Firm seeks to list out its perception of problem areas and shortcomings in meeting customer requirements. This will list out areas of weakness where the greatest impact could be achieved through the implementation of improvements. The Firm identifies the answer to the question - What problem areas do we perceive in the decision-making process?

Step 5: Comparison with other Firms and benchmarking:

Detailed and systematic internal deliberations allow the Firm to develop a clear idea of their own strengths and weaknesses and of the areas of most significant deficiency. Benchmarking exercise allows the Firm to see how other Companies are coping with similar problems and opportunities.

Step 6: Customer Feedback:

Steps 1 to 5 provide a information base developed without reference to the customer. This is rectified at Steps 6 with a survey of representative customers, which embraces their views on perceived problem areas. Interaction with the customers and obtaining their views helps the Firm in correcting its own perceptions and refining its processes.

Steps 7 & 8: Identification of improvement opportunities and implementation of Quality Improvement Process:

The outcomes of the customer survey, benchmarking and internal analysis, provides the inputs for Steps 7 and 8, i.e. the identification of improvement opportunities and the implementation of a formal improvement process. This is done through a six-step process called **PRAISE**, for short.

6C's and 4P's

The essential requirements for successful implementation are described as the six C's of TQM. These are:

The 6C's	
Commitment	If a TQM culture is to be developed, total commitment must come from top management. It is not sufficient to delegate 'quality' issues to a single person. Quality expectations must be made clear by the top management, together with the support and training required for its achievement.
Culture	Training lies at the centre of effecting a change in culture and attitudes. Negative perceptions must be changed to encourage individual contributions and to make 'quality' a normal part of everyone's job.



Continuous improvement	TQM should be recognised as a 'continuous process'. It is not a 'one-time programme'. There will always be room for improvement, however small it may be.
Co-operation	TQM visualises Total Employee Involvement (TEI). Employee involvement and co-operation should be sought in the development of improvement strategies and associated performance measures.
Customer focus	The needs of external customers (in receipt of the final product or service) and also the internal customers (colleagues who receive and supply goods, services or information), should be the prime focus.
Control	Documentation, procedures and awareness of current best practice are essential if TQM implementations are to function appropriately. Unless control procedures are in place, improvements cannot be monitored and measured nor deficiencies corrected.

It is possible that the organisation is led to Total Quality Paralysis, instead of improvement, by improper implementation of TQM. To avoid such disruption and paralysis the following principles (called the four P's) of TQM should be followed:

The 4P's	
People	To avoid misdirection, TQM teams should consist of team spirited individuals who have a flair for accepting and meeting challenges. Individuals who are not ideally suited to the participatory process of TQM, should not be involved at all, e.g. lack of enthusiasm, non-attendance at TQM meetings, failure to complete delegated work, remaining a "Mute Spectator" at TQM meetings, etc.
Process	It is essential to approach problem-solving practically and to regard the formal process as a system designed to prevent participants from jumping to conclusions. As such, it will provide a means to facilitate the generation of alternatives while ensuring that important discussion stages are not omitted.
Problem	Problems need to be approached in a systematic manner, with teams tackling solvable problems with a direct economic impact, allowing for immediate feedback together with recognition of the contribution made by individual participants.
Preparation	Additional training on creative thinking and statistical processes are needed in order to give participants a greater appreciation of the diversity of the process. This training must quickly be extended beyond the immediate accounting circle to include employees at supervisory levels and also who are involved at the data input stagey

5.2 PRAISE ANALYSIS

Identification of improvement opportunities and implementation of quality improvement process, of the TQM Process is through a six-step activity sequence, identified by the acronym 'PRAISE'.

Step	Activity	Elements
1	Problem Identification	<ul style="list-style-type: none"> • Areas of customer dissatisfaction. • Absence of competitive advantage.
2	Ranking	<ul style="list-style-type: none"> • Prioritise problems and opportunities by – <ol style="list-style-type: none"> 1. Perceived importance, and 2. Ease of measurement and solution.
3	Analysis	<ul style="list-style-type: none"> • Ask "Why?" to identify possible causes. Keep asking 'Why?' beyond to the move symptoms and to avoid jumping to premature conclusion;.. • Ask 'What?' to consider potential implications. • Ask 'How much?' to quantify cause and effect.

4	Innovation	<ul style="list-style-type: none"> Use creative thinking to generate potential solutions. Operationalise these solutions by identifying – <ol style="list-style-type: none"> Barriers to implementation, Available enablers, and People whose co-operation must be sought.
5	Solution	<ul style="list-style-type: none"> Implement the preferred solution. Take appropriate action to bring about the required changes. Reinforce with training and documentation back-up.
6	Evaluation	<ul style="list-style-type: none"> Monitor the effectiveness of actions. Establish and interpret performance indicators to track progress towards objectives Identify the potential for further improvements and return to Step 1.

Difficulties in PRAISE Analysis

Step	Activity	Difficulties	Remedies
1	Problem Identification	<ul style="list-style-type: none"> Effects of a problem are apparent, but the problems themselves are difficult to identify. Problem may be identifiable, but it is difficult to identify a measurable improvement opportunity. Some problems are too vague to define e.g. morale, communication, productivity etc. 	<ul style="list-style-type: none"> Participative approaches like brainstorming, multi-voting, panel discussion. Quantification and precise definition of problems.
2	Ranking	<ul style="list-style-type: none"> Difference in perception of individuals in ranking Difference in preferences based on functions, e.g. production, finance, marketing etc. Lack of consensus between individuals. 	<ul style="list-style-type: none"> Participative Approach. Subordination of individual to group interest.
3	Analysis	<ul style="list-style-type: none"> Adoption of adhoc approaches and quick-fix solutions. 	<ul style="list-style-type: none"> Lateral Thinking. Brainstorming.
4	Innovation	<ul style="list-style-type: none"> Lack of creativity or expertise. Inability to operationalise ideas, i.e. convert thoughts into action points. 	<ul style="list-style-type: none"> Systematic evaluation of all aspects of each strategy.
5	Solution	<ul style="list-style-type: none"> Resistance from middle managers. 	<ul style="list-style-type: none"> Effective internal communication. Training of personnel and managers. Participative approach.
6	Evaluation	<ul style="list-style-type: none"> Problems in implementation. Lack of measurable data for comparison of expectations with actuals. 	<ul style="list-style-type: none"> Effective Control System to track actuals. Feedback system.

Central to the PRAISE system are - (a) Quality Control - the search for continuous improvements in quality -and (b) Total Employee Involvement - the co-operation and commitment of employees. This dual approach provides a single focus - the customer - whose increased satisfaction remains the primary goal of the procedure.

Implementation of PRAISE Process

A three-point action plan for implementation of the process is -

- Small to Big Issues: Big improvement opportunities are generally complex and require extensive interdepartmental co-operation. The choice of a relatively small problem in the first instance provides a greater chance of success. Therefore, the TQM team has to proceed from small to big issues gradually.



2. Solvable problem: The problem selected should not be trivial, but it should be one with a potential impact and a clear improvement opportunity. Measurable progress towards implementation should be accomplished within a reasonable time in order to maintain the motivation of participants and advertise the success of the improvement itself.
3. Recognition of participants: The successful projects and team members should receive appropriate recognition. Prominent individuals should be rewarded for their efforts through monetary / non-monetary prizes as a measure of personal recognition and as encouragement to others.

5.3 SIX SIGMA

Six Sigma has two key methodologies: DMAIC and DMADV, both inspired by W. Edwards Deming's Plan-Do-Check-Act Cycle: DMAIC is used to improve an existing business process, and DMADV is used to create new product or process designs for predictable, defect-free performance.

DMAIC

- t Basic methodology consists of the following five (5) steps:
- t *Define* the process improvement goals that are consistent with customer demands and enterprise strategy.
- t *Measure* the current process and collect relevant data for future comparison.
- t *Analyze* to verify relationship and causality of factors. Determine what the relationship is, and attempt to ensure that all factors have been considered.
- t *Improve* or optimize the process based upon the analysis using techniques like Design of Experiments.
- t *Control* to ensure that any variances are corrected before they result in defects. Set up pilot runs to establish process capability, transition to production and thereafter continuously measure the process and institute control mechanisms.

DMIADV

Basic methodology consists of the following five steps:

- t *Define* the goals of the design activity that are consistent with customer demands and enterprise strategy.
- t *Measure* and identify CTQs (critical to qualities), product capabilities, production process capability, and risk assessments.
- t *Analyze* to develop and design alternatives, create high-level design and evaluate design capability to select the best design.
- t *Design* details, optimize the design, and plan for design verification. This phase may require simulations.
- t *Verify* the design, set up pilot runs, implement production process and handover to process owners.

Some people have used DMAICR (Realize). Others contend that focusing on the financial gains realized through Six Sigma is counter-productive and that said financial gains are simply byproducts of a good process improvement.

Key roles required for successful implementation of Six Sigma

Six Sigma identifies several key roles for its successful implementation:

1. **Executive Leadership** includes CEO and other key top management team members. They are responsible for setting up a vision for Six Sigma implementation. They also empower the other role holders with the freedom and resources to explore new ideas for breakthrough improvements.
2. **Champions** are responsible for the Six Sigma implementation across the organization in an integrated manner. The Executive Leadership draws them from the upper management. Champions also act as mentors to Black Belts. At GE this level of certification is now called "Quality Leader".



3. **Master Black Belts**, identified by champions, act as in-house expert coaches for the organization on Six Sigma. They devote 100% of their time to Six Sigma. They assist champions and guide Black Belts and Green Belts. Apart from the usual rigour of statistics, their time is spent on ensuring integrated deployment of Six Sigma across various functions and departments.
4. **Experts** this level of skill is used primarily within Aerospace and Defense Business Sectors. Experts work across company boundaries, improving services, processes, and products for their suppliers, their entire campuses, and for their customers. Raytheon Incorporated was one of the first companies to introduce Experts to their organizations. At Raytheon, Experts work not only across multiple sites, but across business divisions, incorporating lessons learned throughout the company.
5. **Black Belts** operate under Master Black Belts to apply Six Sigma methodology to specific projects. They devote 100% of their time to Six Sigma. They primarily focus on Six Sigma project execution, whereas Champions and Master Black Belts focus on identifying projects/functions for Six Sigma.
6. **Green Belts** are the employees who take up Six Sigma implementation along with their other job responsibilities. They operate under the guidance of Black Belts and support them in achieving the overall results.
7. **Yellow Belts** are employees who have been trained in Six Sigma techniques as part of a corporate-wide initiative, but have not completed a Six Sigma project and are not expected to actively engage in quality improvement activities.

Six Sigma process in Quality Control Process.

Six Sigma is a set of practices originally developed by Motorola to systematically improve processes by eliminating defects. A defect is defined as non-conformity of a product or service to its specifications.

While the particulars of the methodology were originally formulated by Bill Smith at Motorola in 1986, Six Sigma was heavily inspired by six preceding decades of quality improvement methodologies such as quality control, TQM, and Zero Defects. Like its predecessors, Six Sigma asserts the following:

- (a) Continuous efforts to reduce variation in process outputs is key to business success
- (b) Manufacturing and business processes can be measured, analyzed, improved and controlled
- (c) Succeeding at achieving sustained quality improvement requires commitment from the entire organization, particularly from top-level management.

The term "Six Sigma" refers to the ability of highly capable processes to produce output within specification. In particular, processes that operate with six sigma quality produce at defect levels below 3.4 defects per (one) million opportunities (DPMO). Six Sigma's implicit goal is to improve all processes to that level of quality or better.

5.4 PARETO ANALYSIS

Pareto Analysis is a rule that recommends focus on the most important aspects of the decision making in order to simplify the process of decision making. It is based on the 80 : 20 rule that was a phenomenon first observed by Vilfredo Pareto, a nineteenth century Italian economist. He noticed that 80% of the wealth of Milan was owned by 20% of its citizens. This phenomenon, or some kind of approximation of it say, (70: 30 etc.) can be observed in many different business situations. The management can use it in a number of different circumstances to direct management attention to the key control mechanism or planning aspects. It helps to clearly establish top priorities and to identify both profitable and unprofitable targets.

Usefulness of Pareto Analysis: It provides the mechanism to control and direct effort by fact, not by emotions. It helps to clearly establish top priorities and to identify both profitable and unprofitable targets.

Pareto analysis is useful to:

- (i) Prioritize problems, goals, and objectives to Identify root causes.
- (ii) Select and define key quality improvement programs.
- (iii) Select key customer relations and service programs.
- (iv) Select key employee relations improvement programs.



- (v) Select and define key performance improvement programs.
- (vi) Maximize research and product development time.
- (vii) Verify operating procedures and manufacturing processes.
- (viii) Product or services sales and distribution.
- (ix) Allocate physical, financial and human resources.

Application of Pareto Analysis:

Pareto analysis may be applicable in the presentation of Performance Indicators data through selection of representative process characteristics that truly determine or directly or indirectly influence or conform the desired quality or performance result or outcome. The Pareto Analysis is generally applicable to the following business situations:

(i) Pricing of a product:

- In the case of a firm dealing with multi products, it would not be possible for it to analyse cost-profit- price -volume relationships for all of them. In practice, in case of such firm approximately 20% of products may account for about 80% of total sales revenue. Pareto Analysis is used for analysing the firm estimated sales revenues from various products and it might indicate that approximately 80% of its total sales revenue is earned from about 20% of its products.
- Such analysis helps the top management to delegate the pricing decision for approximately 80% of its products to the lower levels of management, thus freeing themselves to concentrate on the pricing decisions for products approximately 20% which are essential for the company's survival.
- Thus, a firm can adopt more sophisticated pricing methods for small proportion of products that jointly accounts for approximately 80% of total sales revenue. For the remaining 80% of the products which account for 20% of total sales revenue the firm may use cost based pricing method.

(ii) Customer Profitability analysis:

- Instead of analysing products, customers can be analysed for their relative profitability to the organisation.
- Again it is often found that approximately 20% of customers generate 80% of the profit.. There will always be some customers who are less profitable than others, just as some products are less profitable than others.
- Such an analysis is useful tool! for evaluation of the portfolio of customer profile and decision making such as whether to continue serving a same customer group, what is the extent of promotion expenses to be incurred.

(iii) ABC analysis- Stock Control: Another application of Pareto analysis is in stock control where it may be found that only a few of the goods in stock make up most of the value. In practice approximately 20% of the total quantity of stock may account for about 80% of its value. The outcome of such analysis is that by concentrating on small proportion of stock items that jointly accounts for 80% of the total value, a firm may well be able to control most of monetary investment in stocks.

(iv) Application in Activity Based Costing: In Activity Based Costing it is often said that 20% of an organisation cost drivers are responsible for 80% of the total cost. By analysing, monitoring and controlling those cost drivers that cause most cost, a better control and understanding of overheads will be obtained.

(v) Quality Control:

- Pareto analysis seeks to discover from an analysis of defect report or customer complaints which "vital few" causes are responsible for most of the reported problems.
- Often, 80% of reported problems can usually be traced to 20% of the various underlying causes. By concentrating once efforts on rectifying the vital 20%, one can have the greatest immediate impact on product quality.
- The Pareto Analysis indicates how frequently each type of failure (defect) occurs. The purpose of the analysis is to direct management attention to the area where the best returns can be achieved by solving most of quality problems, perhaps just with a single action.

Example:

A Toy company performs a Pareto analysis, given a set of 'defect types' and frequencies of their occurrence. The sample data consists of information about 84 defective items. The items have been classified by their 'defect types' as follows:

Defect Types	No. of items
Cracks (due to mishandling of raw material)	10
Improper shapes	8
Incomplete	8
Surface scratches	53
Other (due to bad quality raw material)	5

Frequency table indicating the frequency of occurrence of defects in decreasing order of their occurrence will be as follows:

Defect type	No. of items	(%)	Cumulative %
Surface scratches	53	63.0952	63.0952
Cracks	10	11.9048	75.0000
Improper shape	8	9.5238	84.5238
Incomplete	8	9.5238	94.0476
Other	5	5.9524	100.00

The Pareto chart is then constructed for defect type.

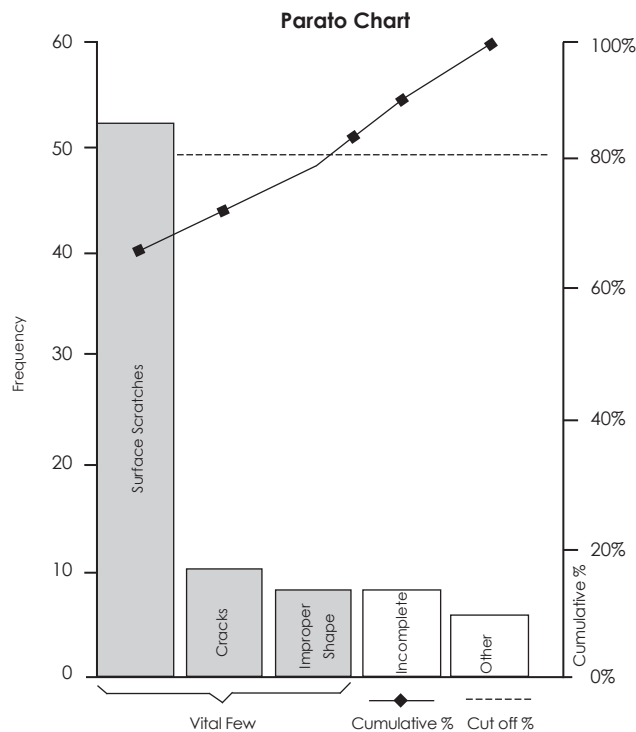

The purpose of Pareto analysis in this example, is to direct attention to the area where best returns can be achieved by solving most of the quality problems, perhaps just with a single action. In this case, use of good quality raw material say plastic may solve 63% of problem and if raw material is handled properly at least 75% the problems may be overcome.



5.5 QUALITY COSTS

Quality of product or service is decided by the customer and is built into the service on product through the design for it. A customer has certain needs or requirements for product or service. It is the design of product or service which builds these requirements as product or service specifications into the product or service—including the way the product or service would be delivered to the customer. The way the product is made or the service is delivered is according to a set of processes which are in sequence. This set of processes, their sequence and interdependence gets defined while the design activity is performed and the design of process has a direct impact on the outcome, that is, the extent to which the outcome meets the specifications developed during design. Process design also contributes to quality.

Concept of Quality

Quality as perception: You will not be wrong when you state that the term quality is a perception which is personal to an individual. In plain terms, quality is “features” or “worth” or “value”. You will realise how this is true when you read the following phrases picked from literature on quality.

- (i) “Quality is not an act. It is a habit”- Aristotle. This is true and applicable to any act of a human being.
- (ii) “Quality is conformance to requirements”: This in line with the concept that quality is decided by the customer.
- (iii) “Quality is zero defects”: No customer wants defects in the products or services he or she pays for. This is a totally different idea on quality and is true when you make quality a habit.
- (iv) “Quality is free” - Phil Crosby. This is the utopian situation. When there are no defects then there is no wastage and thus quality becomes free.
- (v) “Quality is the degree to which a set of inherent characteristics fulfils requirements”- ISO 9000. This is an attempt to give universality to the term quality.

Today, there is no single universal definition of quality. Some people view quality as “performance to standards.” Others view it as “meeting the customer's needs” or “satisfying the customer.” Let's look at some of the more common definitions of quality.

- **Conformance to specifications** measures how well the product or service meets the targets and tolerances determined by its designers. For example, the dimensions of a machine part may be specified by its design engineers as $3 \pm .05$ inches. This would mean that the target dimension is 3 inches but the dimensions can vary between 2.95 and 3.05 inches. Similarly, the wait for hotel room service may be specified as 20 minutes, but there may be an acceptable delay of an additional 10 minutes. Also, consider the amount of light delivered by a 60 watt light bulb. If the bulb delivers 50 watts it does not conform to specifications. As these examples illustrate, conformance to specification is directly measurable, though it may not be directly related to the consumer's idea of quality.
- **Fitness for use** focuses on how well the product performs its intended function or use. For example, a Mercedes Benz and a Jeep Cherokee both meet a fitness for use definition if one considers transportation as the intended function. However, if the definition becomes more specific and assumes that the intended use is for transportation on mountain roads and carrying fishing gear, the Jeep Cherokee has a greater fitness for use. You can also see that fitness for use is a user-based definition in that it is intended to meet the needs of a specific user group.
- **Value for price paid** is a definition of quality that consumers often use for product or service usefulness. This is the only definition that combines economics with consumer criteria; it assumes that the definition of quality is price sensitive. For example, suppose that you wish to sign up for a personal finance seminar and discover that the same class is being taught at two different colleges at significantly different tuition rates. If you take the less expensive seminar, you will feel that you have received greater value for the price.
- **Support services** provided are often how the quality of a product or service is judged. Quality does not apply only to the product or service itself; it also applies to the people, processes, and organizational environment associated with it. For example, the quality of a university is judged not only by the quality of staff and course offerings, but also by the efficiency and accuracy of processing paperwork.

- Psychological criteria** is a subjective definition that focuses on the judgmental evaluation of what constitutes product or service quality. Different factors contribute to the evaluation, such as the atmosphere of the environment or the perceived prestige of the product. For example, a hospital patient may receive average health care, but a very friendly staff may leave the impression of high quality. Similarly, we commonly associate certain products with excellence because of their reputation; Rolex watches and Mercedes-Benz automobiles are examples.

Differences Between Manufacturing and Service Organizations

Defining quality in manufacturing organizations is often different from that of services. Manufacturing organizations produce a tangible product that can be seen, touched, and directly measured. Examples include cars, CD players, clothes, computers, and food items. Therefore, quality definitions in manufacturing usually focus on tangible product features.

The most common quality definition in manufacturing is *conformance*, which is the degree to which a product characteristic meets preset standards. Other common definitions of quality in manufacturing include *performance*—such as acceleration of a vehicle; *reliability*—that the product will function as expected without failure; *features*—the extras that are included beyond the basic characteristics; *durability*—expected operational life of the product; and *serviceability*—how readily a product can be repaired. The relative importance of these definitions is based on the preferences of each individual customer. It is easy to see how different customers can have different definitions in mind when they speak of high product quality.

In contrast to manufacturing, service organizations produce a product that is intangible. Usually, the complete product cannot be seen or touched. Rather, it is experienced. Examples include delivery of health care, experience of staying at a vacation resort, and learning at a university. The intangible nature of the product makes defining quality difficult. Also, since a service is experienced, perceptions can be highly subjective. In addition to tangible factors, quality of services is often defined by perceptual factors. These include responsiveness to customer needs, *courtesy* and *friendliness* of staff, *promptness* in resolving complaints, and *atmosphere*. Other definitions of quality in services include *time*—the amount of time a customer has to wait for the service; and *consistency*—the degree to which the service is the same each time. For these reasons, defining quality in services can be especially challenging. Dimensions of quality for manufacturing versus service organizations are shown in the Table.

Dimensions of Quality for Manufacturing Versus Service Organizations

Manufacturing organizations	Service organizations
Conformance to specifications	Tangible factors
Performance	Consistency
Reliability	Responsiveness to customer needs
Features	Courtesy/friendliness
Durability	Timeliness/ promptness
Serviceability	Atmosphere

Concepts of Quality Management

Quality management is defined as “coordinated activities to direct and control an organization with regard to quality” (ISO 9000:2000). The activities are normally integrated into a system.

This is known as the systems approach to managing quality and the same approach needs to be adapted to business operations. Starting from early 60s and migrating to the 70s, the practices of quality management have shown an evolution. In the following paragraphs, you will get an overview of the way these evolution started from the activity or process of “Inspection”.

Inspection: Inspection is defined as “Activities such as measuring, testing and gauging one or more characteristics of a product or service and comparing with specifications as in design to determine its conformity”. This approach is the “after the event” approach, meaning the things which have happened and then which you verify by, measuring or testing and screen out those which do not meet specifications. Organisation is said to be working in a “detection” mode, having things or events which have happened! The result is that the nonconforming products are cost as they are a waste of material and as well as that of efforts or needing some rework or being sold as “seconds” at a lower price all resulting into a dent in profits. This also creates the culture of “somebody else will check my outcome and it is that somebody’s responsibility to give the conforming product”. This approach had several limitations and had to be replaced by another effective way of attaining quality and the concept of Quality Control was the result.



Quality Control: Defined as “Operational techniques and activities that are used to fulfill requirements for quality”. Organisations realized that “Inspection” alone was a costly affair as all that was segregated was a waste and a cost to the organisation, thus reducing profitability. The result was the idea of “control on operations,” as Quality control. This was not necessarily very different from Inspection but had a new look at inspection. Under a system of quality control, there was a need to find controls for an activity, in the form of procedures, intermediate stage inspections and recording of performance of a process for giving feedback. The methods of inspection got sophisticated with addition of tools like sample checks, lot size, etc for inspections at identified stages. However, the intention and activity of preventing a non-conforming product reaching a customer depended solely on the screening inspection at the final stage of production or service delivery. Application of this concept of course resulted into lesser defects but remained in nature as “detection mode”, which we have discussed earlier.

Quality Assurance: From the business point of view, eliminating non-conformance was the key to a better level of quality and assurance of quality. And then the concept of Quality Assurance (QA) was developed. The central idea is to identify the root cause of non- conformity, take steps to eliminate the cause and thus remove recurrence of the nonconformity in future deliveries to the customer. QA is defined as “All those planned and systematic actions necessary to provide an adequate confidence that a product or service will satisfy the given requirements for quality”.

Quality assurance is a prevention based system. The system improves product and service quality and increases productivity by placing emphasis on the design of product or service and relevant processes. The basis is that the process that makes the product or a service needs to be designed in such a manner that the variation in the process outcome is minimal in reference to design specifications, thus eliminating non-conformance. This is a proactive approach as compared to the reactive one in the “detection mode” discussed above.

In this system of operations, quality is created in the design stage and not in the control stage. The premise is that the design of the products and the processes makes the quality happen and not any verification or inspection as in the detection mode. Changing from “detection mode” to “prevention based system” requires the use of a set of quality management tools and techniques along with a new operating philosophy and approach –even of thinking, by the top management.

The new philosophy demands a change in the management style to integrate various functions or departments to work together to discover the root cause of non-conformance or variation and to pursue elimination. Quality planning and improvements begin when the top management includes prevention, as opposed to detection, in organisational policies because this philosophy directs the business towards the future.

Integrating various processes of the business into “a whole” was at the basis and thus a true system approach to business. Such thinking resulted into a new practice which came to be known as the “Total Quality Management” (TQM). To get an insight into this concept, you need to understand that no-business process can work in isolation. Interdependence and an interaction between each of the business processes exist, and must be addressed while operating a business. This is the systems approach.

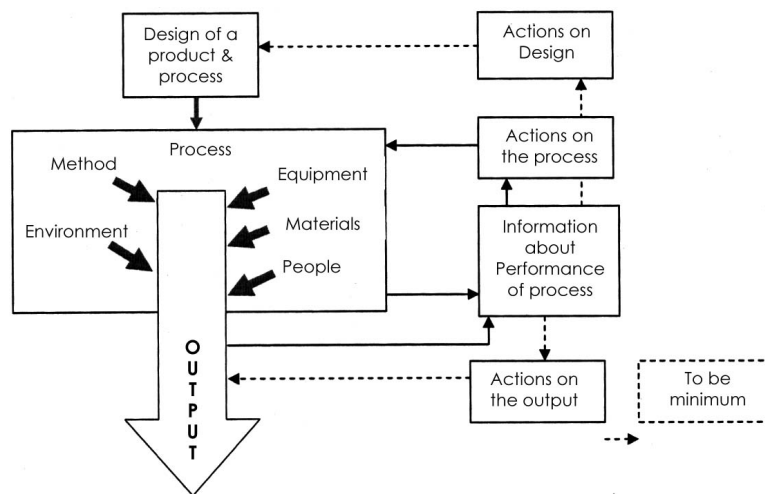

Schematic for a Prevention Based System



COST OF QUALITY

The reason quality has gained such prominence is that organizations have gained an understanding of the high cost of poor quality. Quality affects all aspects of the organization and has dramatic cost implications. The most obvious consequence occurs when poor quality creates dissatisfied customers and eventually leads to loss of business. However, quality has many other costs, which can be divided into two categories. The first category consists of costs necessary for achieving high quality, which are called *quality control costs*. These are of two types: *prevention costs* and *appraisal costs*. The second category consists of the cost consequences of poor quality, which are called *quality failure costs*. These include *external failure costs* and *internal failure costs*. The first two costs are incurred in the hope of preventing the second two.

Prevention costs are all costs incurred in the process of preventing poor quality from occurring. They include quality planning costs, such as the costs of developing and implementing a quality plan. Also included are the costs of product and process design, from collecting customer information to designing processes that achieve conformance to specifications. Employee training in quality measurement is included as part of this cost, as well as the costs of maintaining records of information and data related to quality.

Appraisal costs are incurred in the process of uncovering defects. They include the cost of quality inspections, product testing, and performing audits to make sure that quality standards are being met. Also included in this category are the costs of worker time spent measuring quality and the cost of equipment used for quality appraisal.

Internal failure costs are associated with discovering poor product quality before the product reaches the customer site. One type of internal failure cost is *rework*, which is the cost of correcting the defective item. Sometimes the item is so defective that it cannot be corrected and must be thrown away. This is called *scrap*, and its costs include all the material, labor, and machine cost spent in producing the defective product.

External failure Costs are incurred when inferior products are delivered to customers. They include cost of handling customer complaints, warranty replacements, repairs of returned products and cost arising from a damaged company reputation.

Hence we can tabulate the above details with suitable examples as below:

Prevention costs	Ensuring the failures do not happen Example: <ul style="list-style-type: none">• Quality training• Quality circles• Statistical process control activities• System Development for prevention• Quality improvement
Appraisal costs	Checking for failures Example: <ul style="list-style-type: none">• Testing and inspecting materials• Final product testing and inspecting• WIP testing and inspecting• Package inspection• Depreciation of testing equipment
Internal failure costs	Keeping defective products from falling into the hands of customers Example: <ul style="list-style-type: none">• Cost of Scrap (net of realization)• Cost of Spoilage• Cost of Rework• Down time due to defect in quality• Retesting



External failure cost	Costs of defects discovered by the customers Example: <ul style="list-style-type: none"> • Cost of field servicing • Cost of handling complaints • Warranty repairs • Lost sales • Warranty replacements
-----------------------	--

Illustration 1.

Draw the control charts for \bar{x} (mean) and R (Range) from the following data relating to 20 samples, each of size 5. Only the control line and the upper and lower control limits may be drawn in each chart.

Sample No.	\bar{x}	R	Sample No.	\bar{x}	R
1	38.2	15	11	32.6	31
2	33.8	1	12	22.8	12
3	24.4	22	13	21.6	29
4	36.6	24	14	28.8	22
5	27.4	18	15	28.8	16
6	30.6	33	16	24.4	19
7	31.2	21	17	30.4	20
8	27.0	29	18	25.4	34
9	24.0	29	19	37.8	19
10	29.4	18	20	31.4	17

(For sample of size 5- $d_2 = 2.326$, $d_3 = 0.864$)

Solution:

Given sample size $n = 5$
 No. of samples $k = 20$

Sample No.	\bar{x}	R
1	38.2	15
2	33.8	1
3	24.4	22
4	36.6	24
5	27.4	18
6	30.6	33
7	31.2	21
8	27.0	29
9	24.0	29
10	29.4	18
11	32.6	31
12	22.8	12
13	21.6	29



14	28.8	22
15	28.8	16
16	24.4	19
17	30.4	20
18	25.4	34
19	37.8	19
20	31.4	17
Total	586.6	429

Therefore, $\bar{X} = 586.6 / 20 = 29.33$

$$\bar{R} = 429/20 = 21.45$$

Control Limits for \bar{X} - Chart

$$\begin{aligned}\text{Central Line (C.L.)} &= \bar{X} \\ &= 29.33\end{aligned}$$

$$\text{Lower Control Limit (L.C.L.)} = \bar{X} - A_2 \bar{R}$$

$$\begin{aligned}\text{Where } A_2 &= \frac{3}{d_2 \sqrt{n}} = \frac{3}{2.326 \sqrt{5}} \\ &= \frac{3}{2.326 \times 2.2361} \\ &= \frac{3}{5.2012} \\ &= 0.5768\end{aligned}$$

$$\begin{aligned}\text{Therefore L.C.L.} &= 29.33 - 0.5768 (21.45) \\ &= 29.33 - 12.3724 \\ &= 16.9576\end{aligned}$$

$$\begin{aligned}\text{Upper Control Limit U.C.L.} &= \bar{X} + A_2 \bar{R} \\ &= 29.33 + 0.5768 (21.45) \\ &= 29.33 + 12.3724 \\ &= 41.7024\end{aligned}$$

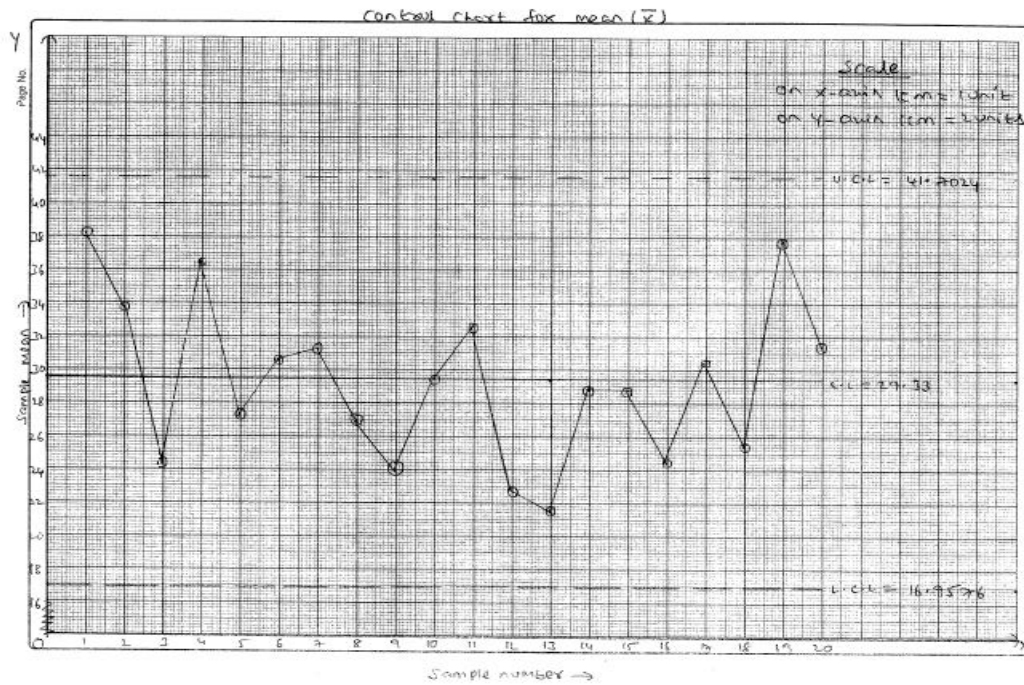

Control Limits for R-Chart:

Central Line (C.L) = \bar{R}
 = 21.45

Lower Control Limit (L.C.L) = $D_3 \bar{R}$

Where $D_3 = 1 - \frac{3d_3}{d_2}$
 = $1 - \frac{3(0.864)}{2.326}$
 = $1 - \frac{2.592}{2.326}$
 = $1 - 1.1143$
 = -0.1143
 $\cong 0$ Since negative

Therefore L.C.L = $0 \times 21.45 = 0$

Upper Control Limit (U.C.L) = $D_4 \bar{R}$

Where $D_4 = 1 + \frac{3d_3}{d_2}$
 = $1 + \frac{3(0.864)}{2.326}$
 = $1 + \frac{2.592}{2.326}$
 = $1 + 1.1143$
 = 2.1143

Therefore U.C.L = $2.1143 (21.45) = 45.3517$

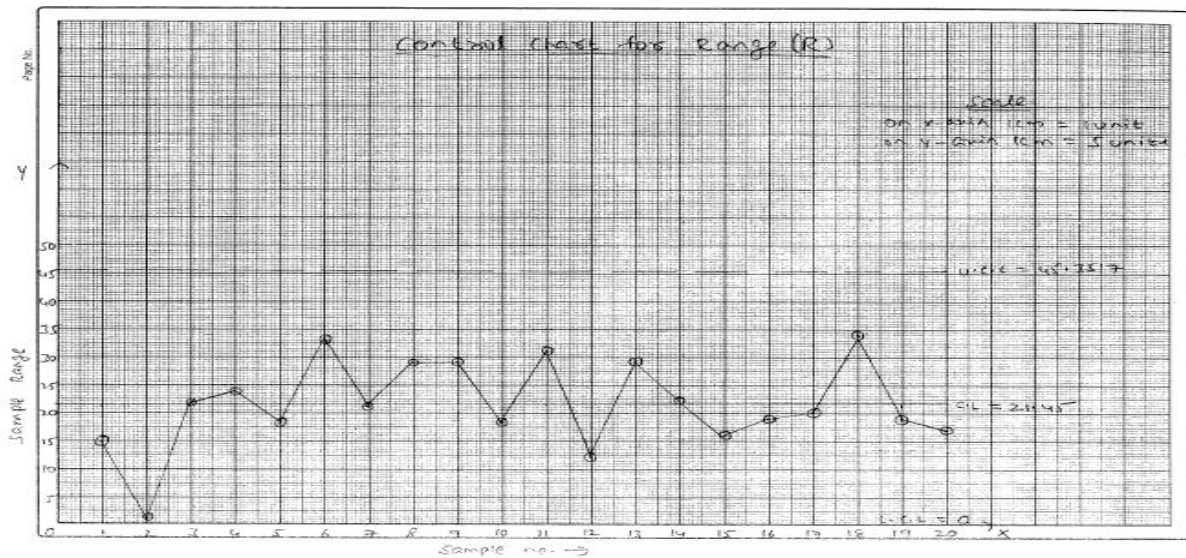

From the graph we observe that all the plotted points lies within the 3σ control limits. Hence the production process is in the state of statistical quality control.

Illustration 2.

15 Samples of size 4 each were taken and the observed values are given below:

Samples		Observed values		
1	32	20	33	6
2	42	36	52	50
3	25	15	52	63
4	22	33	34	23
5	29	30	27	31
6	30	34	26	16
7	34	31	28	34
8	11	21	20	16
9	11	22	28	31
10	36	30	35	26
11	34	16	37	26
12	27	36	51	53
13	26	35	32	37
14	25	36	37	24
15	10	28	14	13

Calculate UCL and LCL for X Chart and R chart. Also prepare the chart on graph paper. For a sample size 4 the control factors are —

$A_2 = 0.729, d_2 = 2.059, D_3 = 0, D_4 = 2.282.$



Solution:

Given Sample size $n = 4$

No. of samples $k = 15$

Sample No.	Sample Mean	Sample Range
1	$91/4 = 22.75$	$33 - 6 = 27$
2	$180/4 = 45$	$52 - 36 = 16$
3	$155/4 = 38.75$	$63 - 15 = 48$
4	$112/4 = 28$	$34 - 22 = 12$
5	$117/4 = 29.25$	$31 - 27 = 4$
6	$106/4 = 26.5$	$34 - 16 = 18$
7	$127/4 = 31.75$	$34 - 28 = 6$
8	$68/4 = 17$	$21 - 11 = 10$
9	$92/4 = 23$	$31 - 11 = 20$
10	$127/4 = 31.75$	$36 - 26 = 10$
11	$113/4 = 28.25$	$37 - 16 = 21$
12	$167/4 = 41.75$	$53 - 27 = 26$
13	$130/4 = 32.5$	$37 - 26 = 11$
14	$122/4 = 30.5$	$37 - 24 = 13$
15	$65/4 = 16.25$	$28 - 10 = 18$
Total	443	260

We have , $\bar{\bar{X}} = 443/15 = 29.5333$

$$\bar{\bar{R}} = 260 / 15 = 17.3333$$

Control Limits for \bar{X} - Chart

Central Line C.L = $\bar{\bar{X}} = 29.5333$

$$\begin{aligned} \text{Lower Control Limit (L.C.L)} &= \bar{\bar{X}} - A_2 \bar{\bar{R}} \\ &= 29.5333 - 0.729 (17.3333) \\ &= 29.5333 - 12.6360 \\ &= 16.8973 \end{aligned}$$

$$\begin{aligned} \text{Upper Control Limit (U.C.L)} &= \bar{\bar{X}} + A_2 \bar{\bar{R}} \\ &= 29.5333 + 0.729 (17.3333) \\ &= 29.5333 + 12.6360 \\ &= 42.1693 \end{aligned}$$

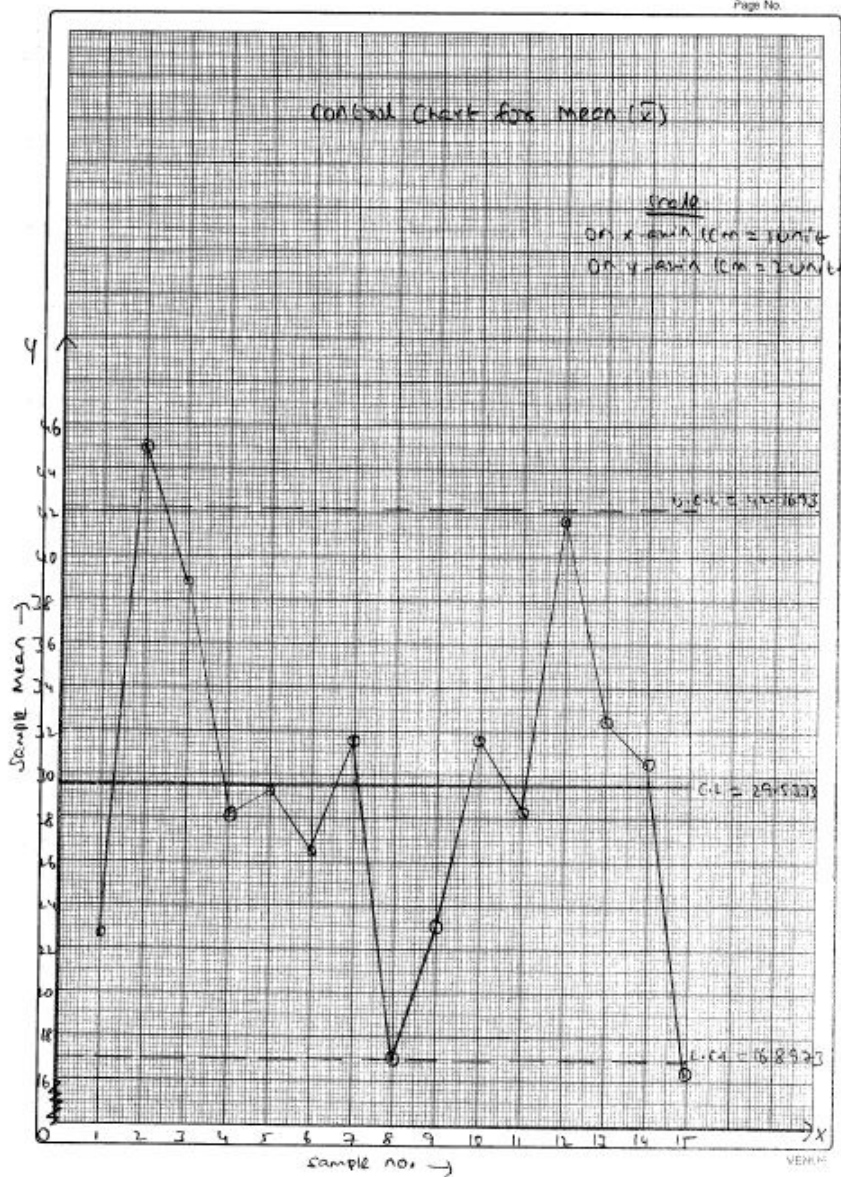

Control Limits for R - Chart

Central Line (C.L) = \bar{R} = 17.3333

Lower Control Limit (L.C.L) = $D_3 \bar{R}$
 = 0×17.3333
 = 0

Upper Control Limit (U.C.L) = $D_4 \bar{R}$
 = $2.282 (17.3333)$
 = 39.5546

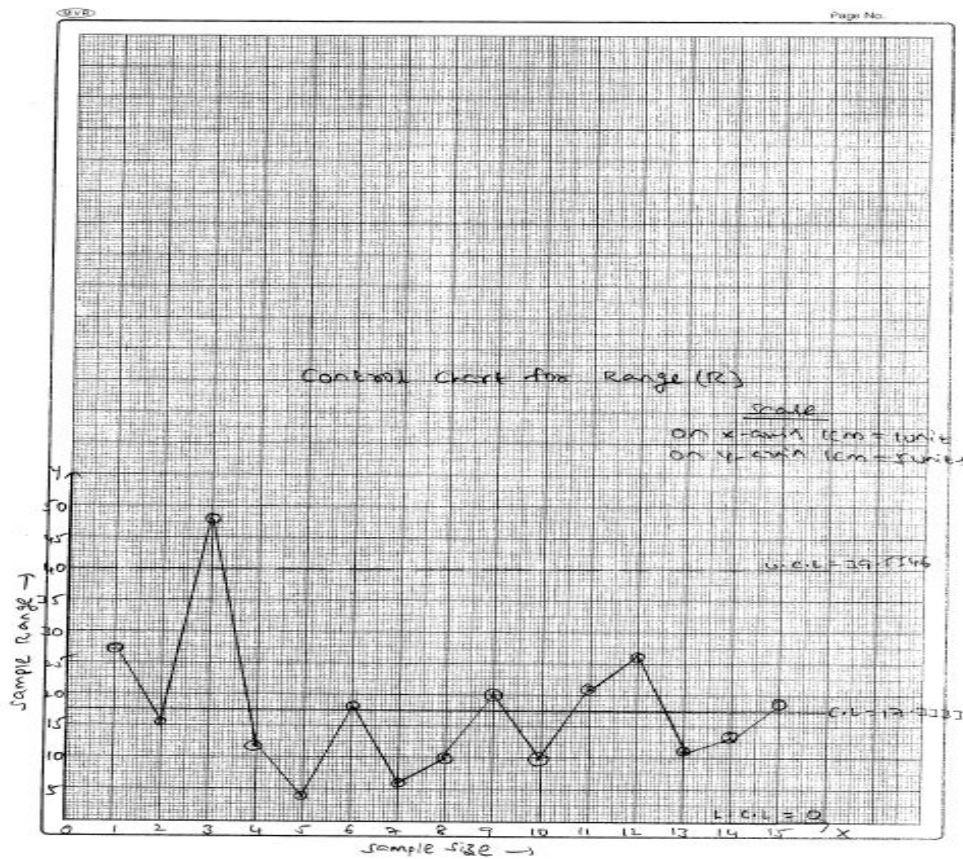

From $\bar{X}\bar{X}$ - chart we observe that the 15th samples lies below L.C.L and 2nd samples goes outside U.C.L. Hence the production process is not in control w.r.t. $\bar{X}\bar{X}$ - chart.

From R - Chart we observe that the 3rd sample lies above U.C.L. So the production process is not in control w.r.t to R - Chart.

Therefore, we infer that the entire production process is not in the state of Statistical Quality.

Illustration 3.

The following table gives the result of inspection of 20 samples of 100 items each taken on 20 working days. Draw a P-chart. What conclusion would you draw from the chart?

Sample No.	1	2	3	4	5	6	7	8	9	10
No. of defectives	9	17	8	7	12	5	11	16	14	15
Sample No.	11	12	13	14	15	16	17	18	19	20
No. of defectives	10	6	7	18	16	10	5	14	7	13

**Answer:**Given sample size $n = 100$

Sample No.	d_i	$p_i = d_i/100$
1	9	0.09
2	17	0.17
3	8	0.08
4	7	0.07
5	12	0.12
6	5	0.05
7	11	0.11
8	16	0.16
9	14	0.14
10	15	0.15
11	10	0.10
12	6	0.06
13	7	0.07
14	18	0.18
15	16	0.16
16	10	0.10
17	5	0.05
18	14	0.14
19	7	0.07
20	13	0.13
Total	--	2.20

We have $\bar{p} = 2.2/20 = 0.11$

$$\square \bar{q} = 1 - \bar{p} = 0.89$$

Therefore, the 3σ control limits for P – chart are

$$\bar{p} \pm 3 \sqrt{\frac{\bar{p}\bar{q}}{n}}$$

Therefore Central Line C. L = $\bar{P} = 0.11$

$$\begin{aligned} \text{Lower Control Limit (L.C.L)} &= \bar{p} - 3 \sqrt{\frac{\bar{p}\bar{q}}{n}} \\ &= 0.11 - 3 \sqrt{\frac{(0.11)(0.89)}{100}} \\ &= 0.11 - 0.09387 \\ &= 0.01613 \end{aligned}$$

$$\text{Upper Control Limit (U.C.L)} = \bar{p} + 3 \sqrt{\frac{\bar{p}\bar{q}}{n}}$$



$$\begin{aligned}
 &= 0.11 + \sqrt[3]{\frac{(0.11)(0.89)}{100}} \\
 &= 0.11 + 0.09387 \\
 &= 0.20387
 \end{aligned}$$

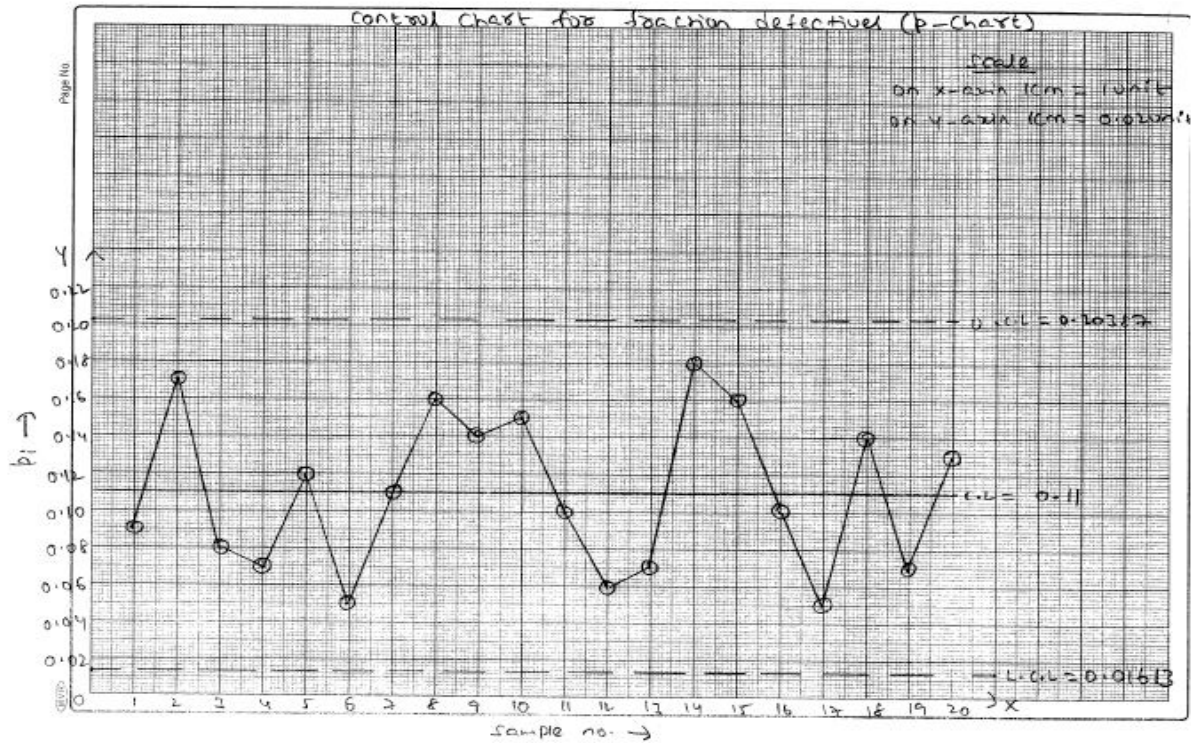

From the P chart we observe that all the sample points lies within the 3σ control limits. Hence the production process is in the state of statistical quality control.





Section C

Strategic Cost Management – Application of Statical Techniques in Business Decisions

(Syllabus - 2016)



Study Note - 6

APPLICATION OF OPERATION RESEARCH AND STATISTICAL TOOLS IN STRATEGIC DECISIONS MAKING



This Study Note includes

- 6.1 Learning Curve
- 6.2 Linear Programming
- 6.3 Assignment
- 6.4 Transportation
- 6.5 Simulation
- 6.6 Network Analysis – CPM/PERT

6.1 LEARNING CURVE

Learning Curve Theory is concerned with the idea that when a new job, process or activity commences for the first time it is likely that the workforce involved will not achieve maximum efficiency immediately. Repetition of the task is likely to make the people more confident and knowledgeable and will eventually result in a more efficient and rapid operation. Eventually the learning process will stop after continually repeating the job. As a consequence the time to complete a task will initially decline and then stabilise once efficient working is achieved. The cumulative average time per unit is assumed to decrease by a constant percentage every time that output doubles. Cumulative average time refers to the average time per unit for all units produced so far, from and including the first one made.

Learning is the process by which an individual acquires skill, knowledge and ability. When a new product or process is started, the performance of a worker is not at its best and learning phenomenon takes place. As the experience is gained, the performance of a worker improves, time taken per unit of activity reduces and his productivity goes up. This improvement in productivity of a worker is due to learning effect. Cost predictions especially those relating to direct labour cost must allow for the effect of learning process. This technique is a mathematical technique. It can be very much used to accurately and graphically predict cost. It is a geometrical progression, which reveals that there is steadily decreasing cost for the accomplishment of a given repetitive operation, as the identical operation is increasingly repeated. The amount of decrease is less and less with each successive unit produced. The slope of the decision curve can be expressed as a percentage. Experience curve, improvement curve and progress curve are other terms which can be synonymously used. Learning curve is essentially a measure of the experience gained in production of an article by an individual or organization. As more units are produced, people involved in production become more efficient than before. Each subsequent unit takes fewer man-hours to produce. The amount of improvement will differ with each type of article produced. This improvement or experience gain is reflected in a decrease in man-hours or cost.

Phases in Learning Curve

The learning curve will pass through three different phases. In the first phase, there will be gradual increase in production rate until the maximum expected rate is reached and this phase is generally steep. In the second phase, the learning rate will gradually deteriorate because of the limitations of equipment. In the third phase, the production rate begins to decrease due to a reduction in customer requirements and increase in costs.

Under the Learning curve model, the cumulative average time per unit produced is assumed to fall by a constant percentage every time total output of the unit doubles. Learning curve is a geometrical operation, as the identical operation is increasingly repeated.

Learning curve is essentially a measure of the experience gained in production of an article by an organization. As more and more units are produced, workers involved in production become more efficient than before. Each subsequent unit takes fewer manhours to produce. The Learning curve exists during a worker's startup or familiarization period on a particular job. After the limits of experimental learning are reached, productivity tends to stabilize and no further improvement is possible. The learning curve ratio can be calculated with the help of the following formula :

$$\text{Learning curve ratio} = \frac{\text{Average labour cost of first 2 units}}{\text{Average labour cost of first units}}$$

Areas of consequence:

- (i) A Standard Costing system would need to set standard labour times after the learning curve had reached a plateau.
- (ii) A budget will need to incorporate a learning cost factor until the plateau is reached.
- (iii) A budgetary control system incorporating labour variances will have to make allowances for the anticipated time changes.
- (iv) Identification of the learning curve will permit the company to better plan its marketing, work scheduling, recruitment and material acquisition activities.
- (v) The decline in labour costs will have to be considered when estimating the overhead apportionment rate.
- (vi) As the employees gain experience they are more likely to reduce material wastage.

Graphical presentation of learning curve

The learning curve (not to be confused with experience curve) is a graphical representation of the phenomenon explained by Theodore P. Wright in his "Factors Affecting the Cost of Airplanes", 1936. It refers to the effect that learning had on labour productivity in the aircraft industry, which translates into a relation between the cumulative number of units produced (X) and the average time (or labour cost) per unit (Y), which resulted in a convex downward slope, as seen in the adjacent diagram.

There is a simple rationalisation behind all this: the more units produced by a given worker, the less time this same worker will need to produce the following units, because he will learn how to do it faster and better. Therefore, when a firm has higher cumulative volume of production, its time (or labour cost) per unit will be lower. Wright's learning curve model is defined by the following function:

$$Y = a \times \frac{\log b}{\log 2}$$

- where:
- Y = average time (or labour cost) per unit
 - a = time (or labour cost) per unit
 - X = cumulative volume of production
 - b = learning rate (%)

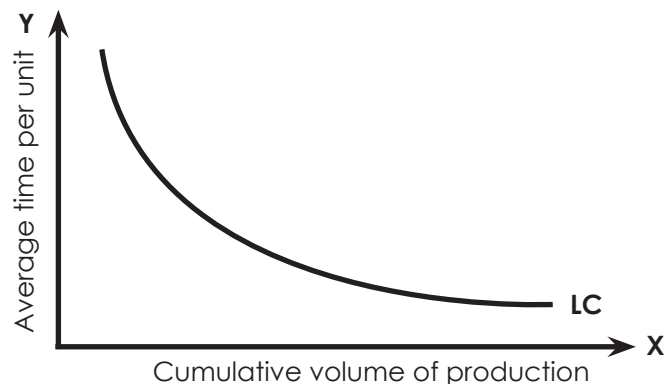



Some important implications arise from this curve. If the time (or labour cost) per unit decreases as the cumulative output increases, this will mean that firms that have been producing more and for a longer period, will have lower average time per unit and thus dominate the market.

Uses of Learning curve.

Learning curve is now being widely issued in business. Some of the uses are as follows:

1. Where applicable the learning curve suggest great opportunities for cost reduction to be achieved by improving learning.
2. The learning curve concept suggests a basis for correct staffing in continuously expanding production. The curve shows that the work force need not be increased at the same rate as the prospective output. This also helps in proper production planning through proper scheduling of work; providing manpower at the right moment permitting more accurate forecast of delivery dates.
3. Learning curve concept provides a means of evaluating the effectiveness of training programs. What level of cumulative cost reduction do they accomplish? How does the learning curve for this group or shop compare with others? Whether any of the employees who lack the aptitude to meet normal learning curve should be eliminated.
4. Learning curve is frequently used in conjunction with establishing bid price for contracts. Usually, the bid price is based on the cumulative average unit cost for all the units to be produced for a given contract. If production is not interrupted. Additional units beyond this quantity should be costed at the increment costs incurred, and not at the previous cumulative average. If the contract agreement so provides, a contract may be cancelled and production stopped before the expected efficiency is reached. This would mean that the company having quoted on the basis of cumulative average unit cost is at a disadvantage because it can not reap the benefit of leaning. The contractor must provide for these contingencies so that it will be reimbursed for such loss.
5. The use of learning curve, where applicable, is important in the working capital required. If the requirement is based on average cumulative unit cost, the revenues from the first few units may not cover the actual expenditures. For instance, if the price was based on the average cumulative unit cost of 328 hours the first unit when produced and sold will cause a deficit of 4.72 hours (8.00 – 3.28). Provision should therefore, be made to cover the deficit of working capital in the initial stages of production.
6. As employees become more efficient, the rate of production increases and so more materials are needed, the work-in-progress inventory turns over faster, and finished goods inventory grows at an accelerated rate. A knowledge of the learning curve assists in planning the inventories of materials. Work-in-progress, and finished goods.
7. Learning curve techniques are useful in exercising control, Variable norms can be established for each situation, and a comparison between these norms and actual expenses can be made. Specific or average incremental unit cost should be used for this purpose.
8. The learning curve may be used for make-or- buy decisions especially if the outside manufacturer has reached the maximum on the learning curve. Help to calculate the sensitive rates in wage bargaining.

Limitations to the usefulness of the learning curve:

The following points limiting the usefulness of learning curves should be noted:-

1. The learning curve is useful only for new operations where machines do not constitute a major part of the production process. It is not applicable to all productions. E.g. new and experienced workmen.
2. The learning curve assumes that the production will continue without any major interruptions. If for any reason the work is interrupted, the curve may be deflected or assume a new slopes
3. Charges other than learning may effect the learning curve. For example, improvement in facilities, arrangements, and equipment as well as personnel morale and performance may be factors influencing



the curve. On the other hand, negative developments in employee attitudes may also affect the curve and reverse or retard the progress of improvement.

4. The characteristic 80 percent learning curve as originally obtained in the air force industry in U.S. A. has been usually accepted as the percentage applicable to all industries. Studies show that there cannot be a unique percentage which can be universally applied.

Factors affecting Learning Curve:

1. While pricing for bids, general tendency is to set up a very high initial labour cost so as to show a high learning curve. This should be the learning curve useless and sometimes misleading.
2. The method of production, i.e. whether it is labour oriented or machine oriented influences the slope of the learning.
3. When labour turnover rate is high management has to train new workers frequently. In such situations the company may never reach its maximum efficiency potential. One of the important requisites of the learning curve concept is that there should be uninterrupted flow of work. The fewer the interruptions, the greater will be the improvement in efficiency.
4. Changes in a product or in the methods of production, designs, machinery, or the tools/used affect the slope of the learning curve. All these have the effect of starting learning a fresh because of new conditions. If the changes are frequent, there may be no learning at all.
5. Also other factors influencing the learning curve are labour strikes, lock outs and shut downs due to other cause also/affect the learning curve. In each such case there is interruption in the progress of learning.

As far as possible the effects of above factors should be carefully separated from the data used to establish the curve. The effects of these factors must also be separated from the actual costs used to measure the performance. Unless this is done analysis of the projected cost or the actual cost will not be meaningful.

The experience curve

The more experience a firm has in producing a particular product, the lower its costs.

The experience curve is an idea developed by the Boston Consulting Group (BCG) in the mid-1960s. Working with a leading manufacturer of semiconductors, the consultants noticed that the company's unit cost of manufacturing fell by about 25% for each doubling of the volume that it produced. This relationship they called the experience curve: the more experience a firm has in producing a particular product, the lower are its costs. Bruce Henderson, the founder of BCG, put it as follows:

Costs characteristically decline by 20-30% in real terms each time accumulated experience doubles. This means that when inflation is factored out, costs should always decline. The decline is fast if growth is fast and slow if growth is slow.

There is no fundamental economic law that can predict the existence of the experience curve, even though it has been shown to apply to industries across the board. Its truth has been proven inductively, not deductively. And if it is true in service industries such as investment banking or legal advice, the lower costs are clearly not passed on to customers.

By itself, the curve is not particularly earth shattering. Even when BCG first expounded the relationship, it had been known since the second world war that it applied to direct labour costs. Less labour was needed for a given output depending on the experience of that labour. In aircraft production, for instance, labour input decreased by some 10-15% for every doubling of that labour's experience.

The strategic implications of the experience curve came closer to shattering earth. For if costs fell (fairly predictably) with experience, and if experience was closely related to market share (as it seemed it must be), then the competitor with the biggest market share was going to have a big cost advantage over its rivals. QED: being market leader is a valuable asset that a firm relinquishes at its peril.

This was the logical underpinning of the idea of the growth share matrix. The experience curve justified allocating financial resources to those businesses (out of a firm's portfolio of businesses) that were (or were going to be) market leaders in their particular sectors. This, of course, implied starvation for those businesses that were not and never would be market leaders.

Over time, managers came to find the experience curve too imprecise to help them much with specific business plans. Inconveniently, different products had curves of a different slope and different sources of cost reduction. They did not, for instance, all have the same downward gradient as the semiconductor industry, where BCG had first identified the phenomenon. A study by the Rand Corporation found that "a doubling in the number of [nuclear] reactors [built by an architect-engineer] results in a 5% reduction in both construction time and capital cost".

Part of the explanation for this discrepancy was that different products provided different opportunities to gain experience. Large products (such as nuclear reactors) are inherently bound to be produced in smaller volumes than small products (such as semiconductors). It is not easy for a firm to double the volume of production of something that it takes over five years to build, and whose total market may never be more than a few hundred units.

In theory, the experience curve should make it difficult for new entrants to challenge firms with a substantial market share. In practice, new firms enter old industries all the time, and before long many of them become major players in their markets. This is often because they have found ways of bypassing what might seem like the remorseless inevitability of the curve and its slope. For example, experience can be gained not only first-hand, by actually doing the production and finding out for yourself, but also second-hand, by reading about it and by being trained by people who have first-hand experience. Furthermore, firms can leapfrog over the experience curve by means of innovation and invention. All the experience in the world in making black and white television sets is worthless if everyone wants to buy colour ones.

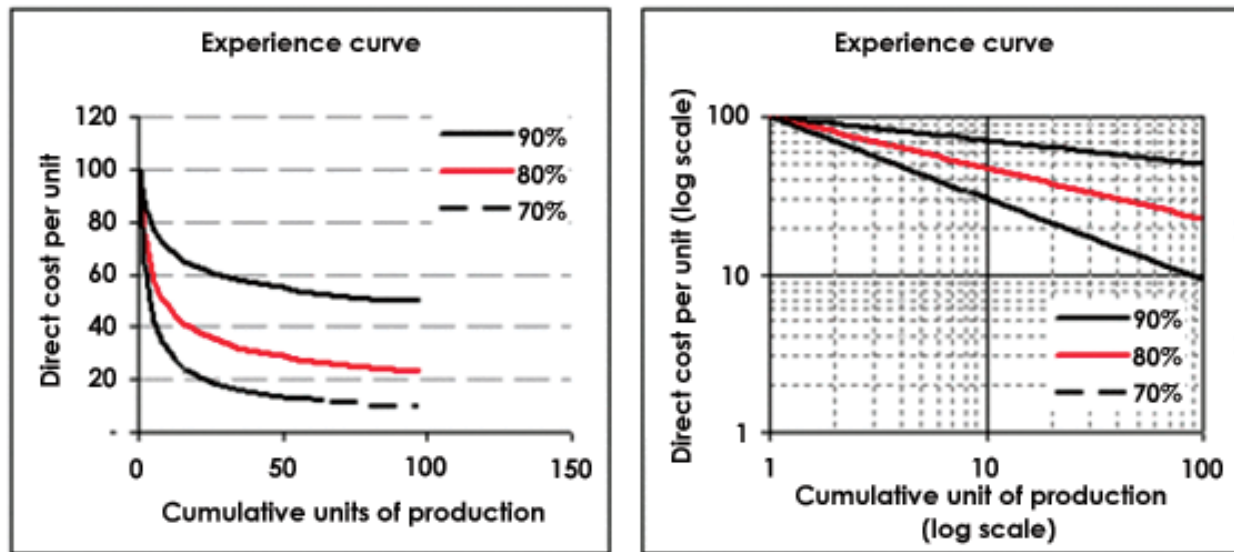

Illustration 1.

The usual learning curve model is $Y = ax^b$ where

Y is the average time per unit for x units.

a is the time for first unit

x is the cumulative number of units

b is the learning coefficient and is



equal to $\frac{\log 0.8}{\log 2} = -0.322$ for a learning rate of 80%

Given that $a = 10$ hours and learning rate 80%, you are required to Calculate:

- (i) The average time for 20 units.
- (ii) The total time for 30 units.
- (iii) The time for units 31 to 40.

Given that $\log 2 = 0.301$, Antilog of 0.5811 = 3.812
 $\log 3 = 0.4771$, Antilog of 0.5244 = 3.345.
 $\log 4 = 0.6021$, Antilog of 0.4841 = 3.049.

Solution:

(i) $Y = AX^b$

$$Y = 10(20)^{-0.322}$$

Taking log on both sides

$$\text{Log } y = \log 10 + \log 20^{(-0.322)}$$

$$\text{Log } y = \log 10 - (0.322) \log 20$$

$$= 1 - (0.322) \log 20$$

$$= 1 - (0.322) \times (1.3010)$$

$$= 1 - 0.41892 = 0.5811$$

$$\text{Log } y = 0.5811$$

$$Y = \text{Anti log } (0.5811) = 3.812 \text{ hrs (average time)}$$

$$\text{Total Time} = 3.812 \times 20 = 76.24 \text{ hours}$$

(ii) $\text{Log } y = \log 10 + \log 30^{(-0.322)}$

$$\text{Log } y = 1 - (0.322) \times (1.4771)$$

$$= 1 - (0.4756) = 0.5244$$

$$Y = \text{anti log } (0.5244) = 3.345 \text{ hrs (average time)}$$

$$\text{Total time} = 3.345 \times 30 = 100.35 \text{ hrs}$$

(iii) $\text{Log } y = \log 10 + \log 40^{(-0.322)}$

$$= 1 - (0.322) \times (1.6021)$$

$$\text{Log } y = 0.4841$$

$$Y = \text{anti log } (0.4841) = 3.049 \text{ hrs}$$

$$\text{Total time} = 40 \times 3.049 = 121.96 \text{ hrs}$$

$$\text{Time from 31 to 40 units} = 121.96 - (100.35) = 21.61 \text{ hrs}$$

**Illustration 2.**

The learning curve as a management accounting has now become or going to become an accepted tool in industry, for its applications are almost unlimited. When it is used correctly, it can lead to increase business and higher profits; when used without proper knowledge, it can lead to lost business and bankruptcy. State precisely:

- (i) Your understanding of the learning curve;
- (ii) The theory of learning curve;
- (iii) The areas where learning curves may assist in management accounting; and
- (iv) Illustrate the use of learning curves for calculating the expected average units cost of making.
 - (a) 4 machines
 - (b) 8 machines

Using the data below:

Data:

Direct Labour need to make first machine	= 1000 hrs.
Learning curve	= 90%
Direct Labour cost	= ₹15/- per hour.
Direct materials cost	= ₹1,50,000
Fixed cost for either size orders	= ₹60,000.

Solution:

Statement showing computation of cost of making 4 machines & 8 machines:

No of machines	Average time	Labour cost	Material	Fixed cost	Total
	Hours	₹	₹	₹	₹
1	1000	15000	150000	60000	225000
2	900	13500	150000	30000	193500
4	810	12150	150000	15000	177150
8	729	10935	150000	7500	168435

Average cost of making 4 machines ₹ 177150

Average cost of making 8 machines ₹ 168435

Illustration 3.

Z.P.L.C experience difficulty in its budgeting process because it finds it necessary to qualify the learning effect as new products are introduced.

Substantial product changes occur and result in the need for retraining.

An order for 30 units of a new product has been received by Z.P.L.C So far, 14 have been completed; the first unit required 40 direct labour hours and a total of 240 direct labour has been recorded for the 14 units. The production manager expects an 80% learning effect for this type of work.

The company use standard absorption costing. The direct costs attributed to the centre in which the unit is manufactured and its direct materials costs are as follows:

	₹
Direct material	30.00 per unit.
Direct Labour	6.00 per hour.
Variable overhead	0.50 per direct labour hour.
Fixed overhead	6,000 per four-week operating period.



There are ten direct employees working a five-day week, eight hours per day. Personal and other downtime allowances account for 25% of total available time.

The company usually quotes a four-week delivery period for orders.

You are required to:

- (i) Determine whether the assumption of an 80% learning effect is a reasonable one in this case, by using the standard formula $y = ax^b$
 Where Y = the cumulative average direct labour time per unit (productivity)
 a = the average labour time per unit for the first batch.
 x = the cumulative number of batches produced.
 b = the index of learning.
- (ii) Calculate the number of direct labour hours likely to be required for an expected second order of 20 units.
- (iii) Use the cost data given to produce an estimated product cost for the initial order, examine the problems which may be created for budgeting by the presence of the learning effect.

Solution:

(i) Total time taken to produce 14 units

$$Y = ab^x$$

$$Y = 40 (14)^{-0.322}$$

$$\text{Log } Y = \text{log } 40 + \text{log } 14^{0.322}$$

$$\text{Log } Y = \text{log } 40 - (0.322) \text{ log } 14$$

$$= 1.60221 - (0.322) \times 1.1461$$

$$= 1.60221 - 0.3690 = 1.233$$

$$Y = \text{Antilog } (1.233) = 17.14$$

$$\text{Total time} = 17.14 \times 14 = 239.96$$

$$= 240 \text{ hours}$$

It is true that learning ratio 80% is effective.

(ii) 30 units

$$Y = 40 (30)^{-0.322} = 13.380 \text{ hours (Average time)}$$

50 units

$$Y = 40 (50)^{-0.322} = 11.35 \text{ hours (Average time)}$$

$$\text{Total time for 30 units} = 13.38 \times 30 = 401.4 \text{ hours}$$

$$\text{Total time for 50 units} = 11.35 \times 50 = 567.5 \text{ hours}$$

$$\text{Time taken for 20 units from 31 to 50 units } (567.5 - 401.4) = 166.1 \text{ hours}$$

(iii)

$$\text{Man hours} = 10 \times 8 \times 5 \times 4 = 1600$$

$$(-) \text{ down time} = \underline{400}$$

$$\underline{1200}$$

$$\text{Fixed Cost per hour} = 6000/1200 = ₹ 5$$

Computation of total cost for the initial order

	=	₹
Material (30 x 30)	=	900.0
Labour (401.4 x 6)	=	2408.4
Variable Overheads (0.5 x 401.4)	=	200.7
Fixed Overheads (5 x 401.4)	=	<u>2007.0</u>
	=	<u>5516.1</u>

**Illustration 4.**

A firm received an order to make and supply eight units of standard product which involves intricate labour operations. The first unit was made in 10 hours. It is understood that this type of operations is subject to 80% learning rate. The workers are getting a wages rate of ₹ 12 per hour.

- (i) What is the total time and labour cost required to execute the above order?
- (ii) If a repeat order of 24 units is also received from the same customer, what is the labour cost necessary for the second order?

Solution:

80% Learning Curve results are given below:

Production (Units)	Cumulative Average Time (hours)	Total Time (hours)
1	10	10
2	8	16
4	6.4	25.6
8	5.12	40.96
16	4.096	65.54
32	3.2768	104.86

Labour time required for first eight units = 40.96 hours

Labour cost required for 8 units = 40.96 hours x ₹ 12/hr = ₹ 491.52

Labour time for 32 units = 104.86 hours

Labour time for first eight units = 40.96 hours

Labour time required for 2nd order for 24 units = 63.90 hours

Labour cost for 24 units = 63.90 hours x ₹ 12/hr = ₹ 766.80

6.2 LINEAR PROGRAMMING

Introduction:

Linear Programming is an optimization technique. It is "**a technique for specifying how to use limited resources or capacities of a business to obtain a particular objective, such as least cost, highest margin or least time, when those resources have alternate uses**".

The situation which require a search for "**best**" values of the variables, **subject to** certain constraints, are amenable to programming analysis. These situations cannot be handled by the usual tools of calculus or marginal analysis. The calculus technique can only handle **exactly equal** constraints, while this limitation does not exist in case of linear programming problem.

A linear programming problem has two basic parts.

- The first part is the objective function, which describes the primary purpose of the formulation – to maximize some return (for example, profit) or to minimize some cost (for example, production cost or investment cost).
- The second part is the constraint set. It is the system of equalities and/or inequalities, which describes the restrictions (conditions or constraints) under which optimization is to be accomplished.



Definition of Linear Programming:

According to Kohlar "A method of planning and operation involved in the construction of a model of a real situation containing the following elements: (a) variables representing the available choices, and (b) mathematical expressions (i) relating the variables to the controlling conditions, and (ii) reflecting the criteria to be used in measuring the benefits derivable from each of the several possible plans, and (iii) establishing the objective. The method may be so devised as to ensure the selection of the best of a large number of alternatives".

Samuelson, Dorfman and Solow defines LP as "The analysis of problems in which a linear function of a number of variables is to be maximized (or minimized) when those variables are subject to a number of restraints in the form of linear inequalities".

In the words of Loomba, "LP is only one aspect of what has been called a system approach to management wherein all programmes are designed and evaluated in terms of their ultimate affects in the realization of business objectives".

Limitations of Linear Programming:

Although linear programming is a very useful technique for solving optimization problems, there are certain important limitations in the application of linear programming. Some of these are discussed below:

1. Firstly, the linear programming models can be applied only in those situations where the constraints and the objective function can be stated in terms of linear expressions.
2. In linear programming problems, coefficients in the objective function and the constraint equations must be completely known and they should not change during the period of study.
3. Yet another important limitation of linear programming is that it may give fractional valued answers.
4. Linear programming will fail to give a solution if management have conflicting multiple goals.
5. Linear programming problem requires that the total measure of effectiveness and total resource usage resulting from the joint performance of the activities must equal the respective sums of these quantities resulting from each activity being performed individually.
6. Many real-world problems are so complex, in terms of the number of variables and relationships constrained in them, that they tax the capacity of even the largest computer.
7. Other limitations of LP includes:-
 - Does not take into consideration the effect of time and uncertainty.
 - Parameters appearing in the model are assumed to be constants but in real-life situations they are frequently neither known nor constants.

APPLICATION AREAS OF LINEAR PROGRAMMING:

In practice linear programming has proved to be one of the most widely used technique of managerial decision making in business, industry and numerous other fields.

1. Industrial Applications:

Linear programming is extensively used to solve a variety of industrial problems. In each of these applications, the general objective is to determine a plan for production and procurement in the time period under consideration. It is necessary to satisfy all demand requirements without violating any of the constraints. Few examples of industrial applications are as follows:

- (a) Product Mix-Problem.
- (b) Production Scheduling.
- (c) Production Smoothing Problem.



- (d) Blending Problems.
- (e) Transportation Problems.
- (f) Production distribution problems.
- (g) Trim Loss.
- (h) Linear programming is also used by oil refineries to determine the optimal mix of products to be produced by the refinery during a given period.
- (i) Communication Industry. LP methods are used in solving problems involving facilities for transmission, switching, relaying etc.
- (j) Rail Road Industry: An LP model for optimal programming of railway freight, and train movements has been formulated to handle scheduling problems as found at large terminal switching rail points.

2. Management Applications:

- (a) Portfolio Selection.
- (b) Financial Mix Strategy.
- (c) Profit Planning.
- (d) Media Selection.
- (e) Travelling Salesmen Problem.
- (f) Determination of equitable salaries.
- (g) Staffing problem.

3. Miscellaneous Applications:

The additional application of Linear Programming are as follows:

- (a) Form planning.
 - The particular crops to be grown or cattle to keep during a period
 - The acreage to be devoted to each, and
 - The particular production methods to be used.
- (b) Airline routine.
- (c) Administration, Education and Politics have also employed linear programming to solve their problems.
- (d) Diet Problems. The diet problem, one of the earliest applications of linear programming was originally used by hospitals to determine the most economical diet for patients.

4. Administrative applications of Linear Programming:

Linear programming can be used for administrative applications. Administrative applications of Linear Programming are concerned with optimal usage of resources like men, machine and material.

5. Non-Industrial applications of linear programming:

Linear programming techniques/tools can be applied in the case of non-industrial applications as well. Examples of the use of L.P techniques for non-industrial applications are given below:

- Agriculture.
- Environmental Protection.
- Urban Department.
- Facilities Location.



6. Further applications of Linear Programming are:

- (i) In structural design for maximum product.
- (ii) In balancing assembly lines.
- (iii) In scheduling of a military tanker fleet.
- (iv) In determining which parts to make and which to buy to obtain maximum profit margin.
- (v) In selecting equipment and evaluating methods improvements that maximize profit margin.
- (vi) In planning most profitable match of sales requirements to plant capacity that obtains a fair share of the market.
- (vii) In design of optimal purchasing policies.

FORMULATION OF LINEAR PROGRAMMING PROBLEM:

The formulation of linear programming problem as a mathematical model involves the following basic steps:

- Step 1:** Find the key-decision to be made from the study of the solution. (In this connection, looking for variables helps considerably).
- Step 2:** Identify the variables and assume symbols x_1, x_2, \dots for variable quantities noticed in step 1.
- Step 3:** Express the possible alternatives mathematically in terms of variables. The set of feasible alternatives generally in the given situation is:

$$[(x_1, x_2); x_1 > 0, x_2 > 0]$$

- Step 4:** Mention the objective quantitatively and express it as a linear function of variables.
- Step 5:** Express the constraints also as linear equalities/inequalities in terms of variables.

Some Definition:

(a) Solution:

Values of decision variables x_j ($j = 1, 2, \dots, n$) which satisfy the constraints of a general L.P.P., is called the solution to that L.P.P.

(b) Feasible Solution:

Any solution that also satisfies the non-negative restrictions of the general L.P.P., is called a feasible solution.

(c) Basic Solution:

For a set of m simultaneous equations in n unknowns ($n > m$), a solution obtained by setting $(n-m)$ of the variables equal to zero and solving the remaining m equations in m unknowns is called a *basic solution*. Zero variables $(n-m)$ are called *non basic variables* and remaining m are called *basic variables* and constitute a basic solution.

(d) Basic Feasible Solution:

A feasible solution to a general L.P. problem which is also basic solution is called a basic feasible solution.

(e) Optimal Feasible Solution:

Any basic feasible solution which optimize (maximize or minimize) the objective function of a general L.P.P. is called an optimal feasible solution to that L.P. problem.

(f) Degenerate Solution:

A basic solution to the system of equations is called degenerate if one or more of the basic variables become equal to zero.

**Illustration 5.**

A firm manufactures and sells two products Alpha and Beta. Each unit of Alpha requires 1 hour of machining and 2 hours of skilled labour, whereas each unit of Beta uses 2 hours of machining and 1 hour of labour. For the coming month the machine capacity is limited to 720 machine hours and the skilled labour is limited to 780 hours. Not more than 320 units of Alpha can be sold in the market during a month.

- (i) Develop a suitable model that will enable determination of the optimal product mix.
- (ii) Determine the optimal product-mix and the maximum contribution. Unit contribution from Alpha is ₹6 and from Beta is ₹ 4.
- (iii) What will be the incremental contribution per unit of the machine hour, per unit of labour, per unit of Alpha saleable?

Solution:

Products	Machining	Skilled Labour	Contribution
Alpha	1 hr	2 hr	6/-
Beta	2 hr	1 hr	4/-
Available hours	720 hr	780 hr	

Let x_1 be the no. of units of Alpha produced

x_2 be the no. of units of Beta produced.

Objective function:

$$\text{Max. } Z = 6x_1 + 4x_2.$$

Subject to constraints

$$x_1 + 2x_2 \leq 720$$

$$2x_1 + x_2 \leq 780$$

$$x_1 \leq 320 \text{ and}$$

$$x_1, x_2 \geq 0$$

$$x_1 + 2x_2 + S_1 = 720$$

$$2x_1 + x_2 + S_2 = 780$$

$$x_1 + S_3 = 320$$

$$\text{Max. } Z = 6x_1 + 4x_2 + 0.S_1 + 0.S_2 + 0.S_3$$

Illustration 6.

A company possesses two manufacturing plants each of which can produce three products x, Y and Z from a common raw material. However, the proportions in which the products are produced are different in each plant and so are the plant's operating costs per hour. Data on production per hour costs are given below, together with current orders in hand for each product.

	Product			Operating cost/ hour in ₹
	X	Y	Z	
Plant A	2	4	3	9
Plant B	4	3	2	10
Orders on hand	50	24	60	



You are required to use the simplex method to find the number of production hours needed to fulfill the orders on hand at minimum cost.

Interpret the main features of the final solution.

Solution:

Let α be no. of hours of plant A in use

Let β be no. of hours of plant B in use

Objective function: $\text{Min } Z = 9\alpha + 10\beta$

Subject to constraints:

$$2\alpha + 4\beta \geq 50$$

$$4\alpha + 3\beta \geq 24$$

$$3\alpha + 2\beta \geq 60$$

$$\text{And } \alpha, \beta \geq 0$$

Illustration 7.

A Company produces the products P, Q and R from three raw materials A, B and C. One unit of product P requires 2 units of A and 3 units of B. A unit of product Q requires 2 units of B and 5 units of C and one unit of product R requires 3 units of A, 2 unit of B and 4 units of C. The Company has 8 units of material A, 10 units of B and 15 units of C available to it. Profits/unit of products P, Q and R are ₹3, ₹5 and ₹4 respectively.

- (a) Formulate the problem mathematically,
- (b) Write the Dual problem.

Solution:

Raw Materials	P	Q	R	Available units
A	2	-	3	8
B	3	2	2	10
C	-	5	4	15

Profits 3/- 5/- 4/-

Let x_1 be the no. of units of P

Let x_2 be the no. of units of Q

Let x_3 be the no. of units of R

Objective function: $\text{Max. } Z = 3x_1 + 5x_2 + 4x_3$

Subject to constraints:

$$2x_1 + 3x_3 \leq 8$$

$$3x_1 + 2x_2 + 2x_3 \leq 10$$

$$5x_2 + 4x_3 \leq 15$$

$$\text{And } x_1, x_2, x_3 \geq 0.$$

Primal

$$\text{Max. } Z = 3x_1 + 5x_2 + 4x_3$$

Subject to



$$2x_1 + 3x_3 \leq 8$$

$$3x_1 + 2x_2 + 2x_3 \leq 10$$

$$5x_2 + 4x_3 \leq 15$$

$$\text{And } x_1, x_2, x_3 \geq 0$$

Dual

$$\text{Min. } Z = 8y_1 + 10y_2 + 15y_3$$

Subject to

$$2y_1 + 3y_2 \geq 3$$

$$2y_2 + 5y_3 \geq 5$$

$$3y_1 + 2y_2 + 4y_3 \geq 4$$

$$\text{And } y_1, y_2, y_3 \geq 0$$

$$2x_1 + 3x_2 + S_1 = 8$$

$$3x_1 + 2x_2 + 2x_3 + S_2 = 10$$

$$5x_2 + 4x_3 + S_3 = 15$$

$$\text{Max } Z = 3x_1 + 5x_2 + 4x_3 + 0.S_1 + 0.S_2 + 0.S_3$$

$$\therefore x_1 = 23/20 \quad x_2 = 19/10 \quad x_3 = 11/8$$

$$Z = 18.45$$

Illustration 8.

A Factory manufactures 3 products which are processed through 3 different production stages. The time required to manufacture one unit of each of the three products and the daily capacity of the stages are given in the following table:

State	Time/unit in minutes			Stage capacity (minutes)
	Product 1	Product 2	Product 3	
1	1	2	1	430
2	3	-	2	460
3	1	4	-	420
Profit/unit	₹3	₹2	₹5	

- (i) Set the data in a simplex table.
- (ii) Find the table for optimum solution

Solution:

Let x_1 be the no. of units of product 1

Let x_2 be the no. of units of product 2

Let x_3 be the no. of units of product 3



Objective function: $\text{Max } Z = 3x_1 + 2x_2 + 5x_3$

Subject to constraints:

$$x_1 + 2x_2 + x_3 \leq 430$$

$$3x_1 + 2x_3 \leq 460$$

$$x_1 + 4x_2 \leq 420$$

$$\text{And } x_1, x_2, x_3 \geq 0$$

$$x_1 + 2x_2 + x_3 + S_1 = 430$$

$$3x_1 + 2x_3 + S_2 = 460$$

$$x_1 + 4x_2 + S_3 = 420$$

$$\text{Max } Z = 3x_1 + 2x_2 + 5x_3 + 0.S_1 + 0.S_2 + 0.S_3$$

$$\therefore x_1 = 0$$

$$x_2 = 100$$

$$x_3 = 230$$

$$z = 1350$$

6.3 ASSIGNMENT

ASSIGNMENT

Assignment is a special linear programming problem. There are many situations where the assignment of people or machines etc. may be called for. Assignment of workers to machines, clerks to various check-out counters, salesmen to different sales areas are typical examples of these. The Assignment is a problem because people possess varying abilities for performing different jobs and therefore the costs of performing jobs by different people are different. Thus, in an assignment problem, the question is how the assignments should be made in order that the total cost involved is minimized.

There are four methods of solving an assignment problem and they are

- (1) Complete Enumeration Method
- (2) Simplex Method
- (3) Transportation Method and
- (4) Hungarian Method

Hungarian Method:

The following are the steps involved in the minimization of an assignment problem under this method:

Step 1: Row Operation

Locate the smallest cost element in each row of the cost table. Now subtract this smallest element from each element in that row. As a result, there shall be at least one zero in each row of this new table, called the reduced cost table.

Step 2: Column Operation

In the reduced cost table obtained, consider each column and locate the smallest element in it. Subtract the smallest value from every other entry in the column. As a consequence of this action, there would be at least one zero in each of the rows and columns of the second reduced cost table.



Step 3: Optimality

Draw the minimum no. of horizontal and vertical lines (not the diagonal ones) that are required to cover all the zero elements. If the no. of lines drawn is equal to 'n' (the no. of rows/columns) the solution is optimal and proceeds to step 6. If the no. of lines drawn is smaller than 'n' go to step 4.

Step 4: Improved Matrix

Select the smallest uncovered (by the lines) cost element. Subtract this element from all uncovered elements including itself and add this element to each value located at the intersection of any two lines. The cost elements through which only one line passes remain unaltered.

Step 5: Repeat step 3 and 4 until an optimal solution is obtained.

Step 6: Given the optimal solution, make the job assignments as indicated by the 'zero' elements. This is done as follows:

- Locate a row which contains only one zero element. Assign the job corresponding to this element to its corresponding person. Cross out the zero's if any in the column corresponding to the element, which is indicative of the fact that the particular job and person are no more available.
- Repeat (a) for each of such rows which contain only one zero. Similarly, perform the same operation in respect of each column containing only one 'zero' element, crossing out the zero(s), if any, in the row in which the elements lies.
- If there is no row or column with only a single 'zero' element left, then select a row/column arbitrarily and choose one of the jobs (or persons) and make the assignment. Thus in such a case, alternative solutions exists.

Illustration 9.

Average time taken by an operator on a specific machine is tabulated below. The management is considering replacing one of the old machines by a new one and the estimated time for operation by each operator on the new machine is also indicated.

Operation	Machines						New
	M ₁	M ₂	M ₃	M ₄	M ₅	M ₆	
01	2	3	2	1	4	5	6
02	4	4	6	3	2	5	1
03	6	10	8	4	7	6	1
04	8	7	6	5	3	9	4
05	7	3	4	5	4	3	12
06	5	5	6	7	8	1	6

- Find out an allocation of operators to the old machines to achieve a minimum operation time.
- Reset the problem with the new machine and find out the allocation of the operators to each machine and comment on whether it is advantageous to replace an old machine to achieve a reduction in operating time only.
- How will the operators be reallocated to the machines after replacement?



Solution:

Operation	M ₁	M ₂	M ₃	M ₄	M ₅	M ₆	New
01	2	3	2	1	4	5	6
02	4	4	6	3	2	5	1
03	6	10	8	4	7	6	1
04	8	7	6	5	3	9	4
05	7	3	4	5	4	3	12
06	5	5	6	7	8	1	6

(a)

Row Operation

2	3	2	1	4	5
4	4	6	3	2	5
6	10	8	4	7	6
8	7	6	5	3	9
7	3	4	5	4	3
5	5	6	7	8	1

1	2	1	0	3	4
2	2	4	1	0	3
2	6	4	0	3	2
5	4	3	2	0	6
4	0	1	2	1	0
4	4	5	6	7	0

Column Operation

0	2	0	0	3	4
1	2	3	1	0	3
1	6	3	0	3	2
4	4	2	2	0	6
3	0	0	2	1	0
3	4	4	6	7	0

Improved matrix

0	2	0	1	4	5
0	1	2	1	0	3
0	5	2	0	3	2
3	3	1	2	0	6
3	0	0	3	2	1
2	3	3	6	7	0

01	M ₃	-	2
02	M ₁	-	4
03	M ₄	-	4
04	M ₅	-	3
05	M ₂	-	3
06	M ₆	-	1

17 Hours Minimum Operation Time



(b) & (c)

Row Operation

2	3	2	1	4	5	6
4	4	6	3	2	5	1
6	10	8	4	7	6	1
8	7	6	5	3	9	4
7	3	4	5	4	3	12
5	5	6	7	8	1	6
0	0	0	0	0	0	0

1	2	1	0	3	4	5
2	2	4	1	0	3	0
2	6	4	0	3	2	0
5	4	3	2	0	6	1
4	0	1	2	1	0	9
4	4	5	6	7	0	5
0	0	0	0	0	0	0

Improved Matrix

0	1	0	0	3	4	5
2	2	4	2	1	4	0
4	8	6	3	6	5	0
4	3	2	2	0	6	1
4	0	1	3	2	1	10
3	3	4	6	7	0	5
0	0	0	1	1	1	1

01	M ₁	-	2
02	M ₄	-	3
03	New	-	1
04	M ₅	-	3
05	M ₂	-	3
06	M ₆	-	1
07	M ₃	-	0

13 Hours Minimum time

In Place of M₃ new machine is to be replaced.

0	2	0	0	4	5	6
1	2	3	1	1	4	0
3	8	5	2	6	5	0
3	3	1	1	0	6	1
3	0	0	2	2	1	10
2	3	3	5	7	0	5
0	1	0	1	2	2	2

0	2	0	0	5	6	7
0	1	2	0	1	4	0
2	7	4	1	6	5	0
2	2	0	0	0	6	1
3	0	0	2	3	2	11
1	2	2	4	7	0	5
0	1	0	1	3	3	3

Illustration 10.

Six salesmen are to be allocated to six sales regions so that the cost of allocation of the job will be minimum. Each salesman is capable of doing the job at different cost in each region. The cost matrix is given below:

		Region					
		I	II	III	IV	V	VI
Salesmen	A	15	35	0	25	10	45
	B	40	5	45	20	15	20
	C	25	60	10	65	25	10
	D	25	20	35	10	25	60
	E	30	70	40	5	40	50
	F	10	25	30	40	50	15

(Figures are in ₹)



- Find the allocation to give minimum cost what is the cost?
- Now suppose the above table gives earning of each salesman at each region. How can you find an allocation so that the earning will be maximum? Determine the solution with optimum earning.
- There are restrictions for commercial reasons that A cannot be posted to region V and E cannot be posted to region II. Write down the cost matrix suitably after imposing the restrictions.

Solution:

15	35	0	25	10	45
40	5	45	20	15	20
25	60	10	65	25	10
25	20	35	10	25	60
30	70	40	5	40	50
10	25	30	40	50	15

Row Operation

15	35	0	25	10	45
35	0	40	15	10	15
15	50	0	55	15	0
15	10	25	0	15	50
25	65	35	0	35	45
0	15	20	30	40	5

Column Operation

15	35	0	25	10	45
35	0	40	15	0	15
15	50	0	55	5	0
15	10	25	0	5	50
25	65	35	0	25	45
0	15	20	30	30	5

Improved Matrix

20	35	0	30	0	45
40	0	40	20	0	15
20	50	0	60	5	0
15	5	20	0	0	45
25	60	30	0	20	40
0	10	15	30	30	0

A	III	-	0
B	II	-	5
C	VI	-	10
D	V	-	25
E	IV	-	5
F	I	-	10

₹ 55 Minimum Cost

(b)

Loss Matrix

55	35	70	45	60	25
30	65	25	50	55	50
45	10	60	5	45	60
45	50	35	60	45	10
40	0	30	65	30	20
60	45	40	30	20	55

Row Operation

30	10	45	20	35	0
5	40	0	25	30	25
40	5	55	0	40	55
35	40	25	50	35	0
40	0	30	65	30	20
40	25	20	10	0	35



Column Operation

25	10	45	20	35	0
0	40	0	25	30	25
35	5	55	0	40	55
30	40	25	50	35	0
35	0	30	65	30	20
35	25	20	10	0	35

Improved Matrix

5	10	25	20	35	0
0	60	0	15	50	45
15	5	35	0	40	55
10	40	5	50	35	0
15	0	10	65	30	20
15	25	0	10	0	35

0	10	20	20	30	0
0	65	0	50	50	50
10	5	30	0	35	55
5	40	0	50	30	0
10	0	5	65	25	20
15	30	0	15	0	40

A	I	-	15
B	III	-	45
C	IV	-	65
D	VI	-	60
E	II	-	70
F	I	-	50

₹ 305 Maximum

(c) The cost matrix after imposing the given restriction is

Region

	I	II	III	IV	V	VI
A	15	35	0	25	a	45
B	40	5	45	20	15	10
C	25	60	10	65	25	10
D	25	20	35	10	25	60
E	30	a	40	5	40	50
F	10	25	30	40	50	15

Illustration 11.

A company has four zones open and four salesmen available for assignment. The zones are not equally rich in their sales potentials. It is estimated that a typical salesman operating in each zone would bring in the following annual sales:

Zone: A: 1,26,000; Zone B:1,05,000; Zone C: 84,000; Zone D: 63,000.

The four salesmen are also considered to differ in ability. It is estimated that working under the same condition their yearly sales would be proportionately as follows:

Salesman P:7; Salesman Q: 5; Salesman R:5; Salesman S:4. If the criterion is maximum expected total sales, the intuitive answer is to assign the best salesman to the richest zone, the next best to the second richest zone and so on. Verify this by the method of assignment.



Solution:

Ratio of zone wise sales = 6 : 5 : 4 : 3

Ratio of Salesman ability = 7 : 5 : 5 : 4

Sales Matrix

Sales Man	A	B	C	D
P	42	35	28	21
Q	30	25	20	15
R	30	25	20	15
S	24	20	16	12

Loss Matrix

(Reducing all elements from highest element)

0	7	14	21
12	17	22	27
12	17	22	27
18	22	26	30

Row Operation

0	7	14	21
0	5	10	15
0	5	10	15
1	4	8	12

Column Operation

0	3	6	9
0	1	2	3
0	1	2	3
0	0	0	0

Improved Matrix 1

0	2	5	8
0	0	1	2
0	0	1	2
1	0	0	0

Improved Matrix 2

0	2	4	7
0	0	0	1
0	0	0	1
2	1	0	0

Allocation

P	A	-	42
Q	B	-	25
R	C	-	20
S	D	-	12

99 x 3000 = ₹ 2,97,000 Maximum sales

Illustration 12.

Four jobs can be processed on four different machines, one job on one machine. Resulting profits vary with assignments. They are given below:

Jobs	Machines			
	I	II	III	IV
I	42	35	28	21
II	30	25	20	15
III	30	25	20	15
IV	24	20	16	12

Find the optimum assignment of jobs to machines and the corresponding profit.



Solution:

Loss Matrix (Reducing all elements from highest element of profit matrix)

0	7	14	21
12	17	22	27
12	17	22	27
18	22	26	30

Row Operation

0	7	14	21
0	5	10	15
0	5	10	15
0	4	8	12

Column Operation

0	3	6	9
0	1	2	3
0	1	2	3
0	0	0	0

Improved Matrix

0	2	5	8
0	0	1	2
0	0	1	2
1	0	0	0

Further Improved

0	2	4	7
0	0	0	1
0	0	0	1
2	0	0	0

Allocation

I	-	1	-	42
II	-	2	-	25
III	-	3	-	20
IV	-	4	-	12
				<u>99</u>

Maximum Profit ₹ 99

**Illustration 13.**

A salesman has to visit five cities A,B,C,D and E. The inter-city distances are tabulated below. Note the distance between two cities need not be same both ways.

From / To	A	B	C	D	E
A	-	12	24	25	15
B	6	--	16	18	7
C	10	11	--	18	12
D	14	17	22	--	16
E	12	13	23	25	--

Note further that the distances are in km.

Required:

If the salesman starts from city A and has to come back to city A, which route would you advise him to take that total distance traveled by him is minimised?

Solution:**Profit Matrix**

-	12	24	25	15
6	-	16	18	7
10	11	-	18	12
14	17	22	-	16
12	13	23	25	-

Row Operation

-	0	12	13	3
0	1	10	12	1
0	1	-	8	2
0	3	8	-	2
0	1	11	13	-

Column Operation

0	4	5	2
0	2	4	0
0	1	-	0
0	3	0	-
0	1	3	5

A B E D C A

$$12 + 7 + 25 + 22 + 10 = 76 \text{ Kms}$$

Optimum Distance 76 Kms.



Illustration 14.

Six men are available for different jobs. From past records the time in hours taken by different persons for different jobs are given below.

Men		Jobs					
		1	2	3	4	5	6
1	2	9	2	7	9	1	
2	6	8	7	6	14	1	
3	4	6	5	3	8	1	
4	4	2	7	3	10	1	
5	5	3	9	5	12	1	
6	9	8	12	13	9	1	

Find out an allocation of men to different jobs which will lead to minimum operation time.

Solution:

Row Operation

2	9	2	7	9	1
6	8	7	6	14	1
4	6	5	3	8	1
4	2	7	3	10	1
5	3	9	5	12	1
9	8	12	13	9	1

1	8	1	6	8	0
5	7	6	5	13	0
3	5	4	2	7	0
3	1	6	2	9	0

Column Operation

0	7	0	4	1	0
4	6	5	3	6	0
2	4	3	0	0	0
2	0	5	0	2	0
3	1	7	2	4	0
7	6	10	10	1	0

Improved

0	7	0	4	1	1
3	5	4	2	5	0
2	4	3	0	0	1
2	0	5	0	2	1

Improved Matrix

0	9	0	6	3	1
1	5	2	2	5	0
0	4	1	0	0	1
0	0	3	0	2	1
0	0	4	1	3	0
4	5	7	9	0	0

Assignment

0	9	0	6	3	3
1	5	2	2	5	0
0	4	1	0	0	1
0	0	3	0	2	1
0	0	4	1	3	0
4	5	7	9	0	0



Optimal Assignment, then is

1	3	-	2
2	6	-	1
3	1	-	4
4	4	-	3
5	2	-	3
6	5	-	9
	<u>22</u>		Minimum Hours

Illustration 15.

A captain of a cricket team has to allot five middle batting positions to five batsmen. The average runs scored by each batsman at these positions are as follows:

		Batting Position				
		III	IV	V	VI	VII
Batsmen	A	40	40	35	25	50
	B	42	30	16	25	27
	C	50	48	40	60	50
	D	20	19	20	18	25
	E	58	60	59	55	53

Make the assignment so that the expected total average runs scored by these batsmen are maximum.

Solution:

Loss Matrix

	III	IV	V	VI	VII	
A	40	40	35	25	50	20 20 25 35 10
B	42	30	16	25	27	18 30 44 35 33
C	50	48	40	60	50	10 12 20 0 10
D	20	19	20	18	25	40 41 40 42 35
E	58	60	59	55	53	2 0 1 5 7

Row Operation

M_3

10	10	14	25	0
0	12	25	17	15
10	12	19	0	10
5	6	4	7	0
2	0	0	5	7

Column Operation

10	10	15	25	0
0	12	26	17	15
10	12	20	0	10
5	6	5	7	0
2	0	1	5	7



Improved Matrix

10	6	10	25	0
0	8	23	17	15
10	8	15	0	10
5	2	0	7	0
6	0	0	9	11

Maximum Average Runs

A	VII	-	50
B	III	-	42
C	VI	-	60
D	V	-	20
E	IV	-	60

6.4 TRANSPORTATION

Introduction:

The basic transportation problem was originally developed by F.L. Hitchcock (1941) in his study entitled “the distribution of a product from several sources to numerous locations”. In 1947, T.C. Koopmans independently published a study on “optimum utilization of the transportation system”.

Transportation models deals with the transportation of a product manufactured at different plants or factories (supply origins) to a number of different warehouses (demand destinations). The objective is to satisfy the destination requirements within the plants capacity constraints at the minimum transportation cost. Transportation models thus typically arise in situations involving physical movement of goods from plants to warehouses, warehouses to wholesalers, wholesalers to retailers and retailers to customers. Solution of the transportation models requires the determination of how many units should be transported from each supply origin to each demands destination in order to satisfy all the destination demands while minimizing the total associated cost of transportation.

Feasible Solution:

A set of non-negative values x_{ij} , $i=1, 2, \dots, m$; $j = 1, 2, \dots, n$ that satisfies no. of rows to no. of columns is called a feasible solution to the transportation problem.

Basic Feasible Solution:

An initial feasible solution with an allocation of $(m + n - 1)$ number of variables, x_{ij} , $i=1, 2, \dots, m$; $j = 1, 2, \dots, n$, is called a basic feasible solution.

Optimum Solution:

A feasible solution (not necessarily basic) is said to be optimum if it minimizes the total transportation cost.

Balanced or Unbalanced Transportation Problems:

A transportation problem can be balanced or unbalanced. It is said to be balanced if the total demand of all the warehouses equals the amount produced in all the factories. If in reality, capacity is greater than requirement, then a dummy warehouse may be used to create desired equality. If capacity is less than requirement, then a dummy factory may be introduced. The transportation cost in both the dummy cases is assumed to be zero.

Where the number of rows and columns are not equal, it is called unbalanced transportation problem.

Loops in Transportation Table:

In a transportation table, an ordered set of four or more cells is said to form a loop if any two adjacent cells in the ordered set lie either in the same row or in the same column. Moreover every loop has an even number of cells. It may be noted that a feasible solution to a T.P is basic if and only if the corresponding cells in the transportation table do not contain a loop.



Degeneracy of a Transportation Problem:

When the quantities are allocated to cost cells within the matrix and if such allocations are less than $m + n - 1$ allocations (where 'm' stands for no. of rows and 'n' stands for no. of columns), such a situation is said to be Degeneracy of a Transportation Problem.

METHODS OF SOLVING TRANSPORTATION PROBLEM:

The following are the methods of solving transportation problem:

1. The north-west corner rule
2. Lowest cost entry method
3. Vogel's approximation method

1. North West Corner Method (NWCM):

The simplest of the procedures used to generate an initial feasible solution is NWCM. It is so called because we begin with the north west or upper left corner cell of our transportation table. Various steps of this method can be summarized as under:

Step 1:

Select the north west (upper left-hand) corner cell of the transportation table and allocate as many units as possible equal to the minimum between available supply and demand requirement, i.e., $\min(s_1, d_1)$.

Step 2:

Adjust the supply and demand numbers in the respective rows and columns allocation.

Step 3:

- (a) If the supply for the first row is exhausted, then move down to the first cell in the second row and first column and go to step 2.
- (b) If the demand for the first column is satisfied, then move horizontally to the next cell in the second column and first row and go to step 2.

Step 4:

If for any cell, supply equals demand, then the next allocation can be made in cell either in the next row or column.

Step 5:

Continue the procedure until the total available quantity is fully allocated to the cells required.

2. Least Cost Method (LCM):

The allocation according to this method is very useful as it takes into consideration the lowest cost and therefore, reduces the computation as well as the amount of time necessary to arrive at the optimum solution. Various steps of this method can be summarized as under:

Step 1:

- (a) Select the cell with the lowest transportation cost among all the rows or columns of the transportation table.
- (b) If the minimum cost is not unique, then select arbitrarily any cell with this minimum cost.

Step 2:

Allocate as many units as possible to the cell determined in step 1 and eliminate that row (column) in which either supply is exhausted or demand is satisfied.

**Step 3:**

Repeat steps 1 and 2 for the reduced table until the entire supply at different factories is exhausted to satisfy the demand at different warehouses.

3. Vogel's Approximation Method (VAM):

This method is preferred over the other two methods because the initial basic feasible solution obtained is either optimum or very close to the optimum solution. Therefore, the amount of time required to arrive at the optimum solution is greatly reduced. Various steps of this method are summarized as under:

Step 1:

Compute a penalty for each row and column in the transportation table. The penalty for a given row and column is merely the difference between the smallest cost and the next smallest cost in that particular row or column.

Step 2:

Identify the row or column with the largest penalty. In this identified row or column, choose the cell which has the smallest cost and allocate the maximum possible quantity to the lowest cost cell in that row or column so as to exhaust either the supply at a particular source or satisfy demand at a warehouse.

If a tie occurs in the penalties, select that row/column which has minimum cost. If there is a tie in the minimum cost also, select that row/column which will have maximum possible assignments. It will considerably reduce computational work.

Step 3:

Reduce the row supply or the column demand by the amount assigned to the cell.

Step 4:

If the row supply is now zero, eliminate the row, if the column demand is now zero, eliminate the column, if both the row supply and the column demand are zero, eliminate both the row and column.

Step 5:

Recompute the row and column difference for the reduced transportation table, omitting rows or columns crossed out in the preceding step.

Step 6:

Repeat the above procedure until the entire supply at factories are exhausted to satisfy demand at different warehouses.

Illustration 16.

A manufacturer has distribution centres X, Y, and Z. These centres have 40,20 and 40 units of his product. His retail outlets at A, B, C, D and E require 25,10,20,30 and 15 units respectively. The transport cost in (Rupees/Unit) between each centre and each outlet is given in the following table:

Distribution Centre	Retail outlets				
	A	B	C	D	E
X	55	30	40	50	40
Y	35	30	100	45	60
Z	40	60	95	35	30

We have to find out the optimum distribution cost.



Solution:

	A	B	C	D	E	
X	55 5	30 10	40 20	50 5	40	40/20/10/5/0
Y	35 20	30	100	45	60	20/0
Z	40	60	95	35 25	30 15	40/25/0
	<u>25</u> 5 0	0	<u>10</u> 0	<u>20</u> 5 0	<u>30</u> 0	<u>15</u>
	<u>5</u> 5 5 5 15	0	55*	<u>10</u> 10 10 10 15*	<u>10</u> 10 10*	

	A	B	C	D	E	U_j
	55	30	40	50	40	0
	5	10	20	5	10	
	35	30	100	45	60	-20
	20	20	80	15	30	
	40	60	95	35	30	-20
	0	45	70	25	15	
V_j	55	30	40	50	50	

	A	B	C	D	E	U_j
	55	30	40	50	40	0
	5	10	20	5	5	
	35	30	100	45	60	-20
	20	20	80	20	40	
	40	60	95	35	30	-10
	-5	40	65	30	10	
V_j	55	30	40	45	40	

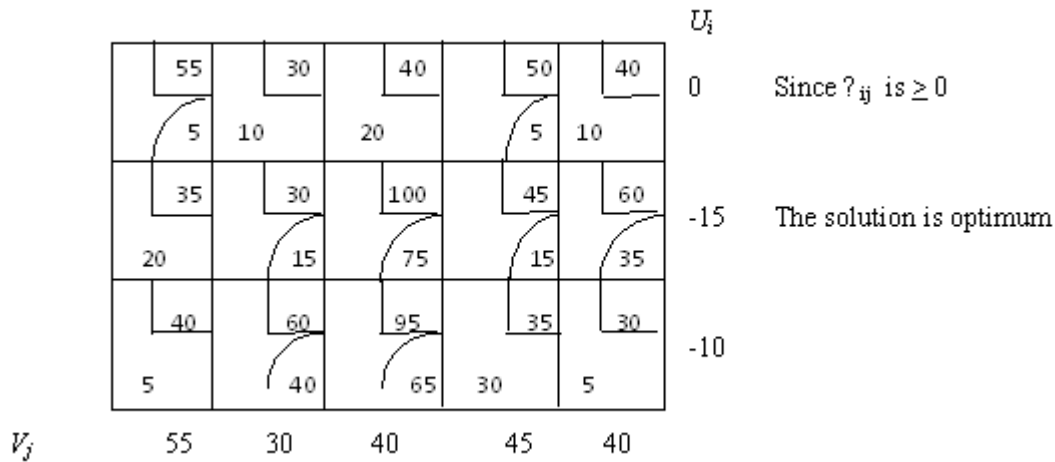

		Qty	Minimum Cost
X	→ B	10 x 30 =	300
	→ C	20 x 40 =	800
	→ E	10 x 40 =	400
Y	→ A	20 x 35 =	700
Z	→ A	5 x 40 =	200
	→ D	30 x 35 =	1050
	→ E	5 x 30 =	150
		100	₹ 3600

Illustration 17.

The cost conscious company requires for the next month 300, 260 and 180 tonnes of stone chips for its three constructions C1, C2 and C3 respectively. Stone chips are produced by the company at three mineral fields taken on short lease by the company. All the available boulders must be crushed into chips. Any excess chips over the demands at sites C1, C2 and C3 will be sold ex-fields.

The fields are M1, M2 and M3 which will yield 250, 320 and 280 tones of stone chips respectively.

Transportation costs from mineral fields to construction sites vary according to distances, which are given below in monetary unit (MU).

	To	C1	C2	C3
From	M1	8	7	6
	M2	5	4	9
	M3	7	5	5

- (i) Determine the optimal economic transportation plan for the company and the overall transportation cost in MU.
- (ii) What are the quantities to be sold from M1, M2 and M3 respectively?



Solution:

As the demand is not equal to supply, problem is not balanced. Therefore, we will insert a dummy column to balance the matrix

	C ₁	C ₂	C ₃	Dummy		Difference
M ₁	8	7	6	0	250/140	6*/1/1/1
M ₂	5	4	9	0	320/20/0	4/1/5*
M ₃	7	5	5	0	280/40/0	5/0/0/0
	<u>300</u>	<u>260</u>	<u>180</u>	<u>110</u>		
	0	<u>240</u>	0	0	850	—
		0				
Difference	$\frac{2}{*2}$	$\frac{1}{1}$ $\frac{1}{*2}$	$\frac{1}{1}$ $\frac{1}{1}$	0		

Hence There are $m + n - 1$ allocations. Hence Optimality test is to be performed.

	C ₁	C ₂	C ₃	Dummy	U _i
	8	7	6	0	0
	1	1	140	110	
	5	4	9	0	-2
	300	20	5	2	
	7	5	5	0	-1
	1	240	40	1	
V _j	7	6	6	0	

Since $\Delta_{ij} \geq 0$ Solution is optimum.

		Qty	Minimum Cost
M ₁	→ C ₃	140 x 6 =	840
	→ C ₄	110 x 0 =	0
M ₂	→ C ₁	300 x 5 =	1500
	→ C ₂	20 x 4 =	80
M ₃	→ C ₂	240 x 5 =	1200
	→ C ₃	40 x 5 =	200
		850	₹ 3820



Illustration 18.

Departmental store wishes to purchase the following quantities of Sprees:

Types of spreeds	A	B	C	D	E
Quantity	150	100	75	250	200

Tenders are submitted by 4 different manufacturers who undertake to supply not more than the quantities mentioned below (all types of spreeds combined):

Manufacturer	W	X	Y	Z
Total quantity	300	250	150	200

The store estimates that its profit/spreed will vary with the manufacturer as shown in the following matrix.

Spreeds					
Manufacturers	A	B	C	D	E
W	275	350	425	225	150
X	300	325	450	175	100
Y	250	350	475	200	125
Z	325	275	400	250	175

How should the orders be placed?

Solution:

As the demand is not equal to supply matrix is not balanced. Therefore we will insert a dummy column to balance the solution:

Profit matrix

	A	B	C	D	E	F	
W	275	350	425	225	150	0	300
X	300	325	450	175	100	0	250
Y	250	350	475	200	125	0	150
Z	325	275	400	250	175	0	200
	150	100	75	250	200	125	

Given matrix is profit matrix, therefore, we will convert it into loss matrix by reducing all the elements from the highest element i.e., 475.



Loss Matrix

	200	125	50	250	325	475	300/275/225/25	Difference
		25		50	200	25		75 75* 50 75 150*
150	175	150	25	300	375	475	250/100/0	25 25 125 75 100
						100		
	225	125	0	275	350	475	150/75/0	125* 100* -- -- --
		75	75					
	150	200	75	225	300	475	200/0	75 50 75 75* --
				200				

	150	100	75	250	200	125
Difference	0	25	0	50	0	100
		0		0		0
	25	0	25	25	25	0
	25	0		25	25	0
	25	25		25	25	0
	25			25	25	0
				25	25	0
				50	50	0

m + n – 1 allocation s are there, optimality test can be performed.

	200	125	50	250	325	475	
	25	25	50	50	200	25	0
150	175	150	25	300	375	475	0
		25	25	50	50	100	0
	225	125	0	275	350	475	0
		50	75	75	25	25	0
	150	200	75	225	300	475	-25
				200	0	25	
	175	125	0	250	325	475	

As $\Delta_j \geq 0$, maximum profit is as follows.

		Qty	Maximum Profit
W	B	25 x 350 =	8750
	D	50 x 225 =	11250
	E	200 x 150 =	30000
	F	25 x 0 =	0
X	A	150 x 300 =	45000
	F	100 x 0 =	0
Y	B	75 x 350 =	26250
	C	75 x 475 =	35625
Z	D	200 x 250 =	50000
Max. Profit.			₹ 2,06,875



Illustration 19.

The products of three plants F1, F2 and F3 are to be transported to 5 warehouses W1, W2, W3, W4 and W5. The capacities of plants, demand of warehouses and the cost of transportation from one plant to various warehouses are indicated in the following table:

	W1	W2	W3	W4	W5	Plant Capacity
F1	74	56	54	62	68	400
F2	58	64	62	58	54	500
F3	66	70	52	60	60	600
Warehouse Demand	200	280	240	360	320	1500/1400

Find out a distribution plan of products from plants to the warehouses at a minimum cost. What is the minimum cost?

- (b) Is there any surplus capacity of the plants? If so, in which plant should we associate that surplus capacity?
- (c) Is there any alternate solution for the optimum solution achieved in

Solution:

	74	56	54	62	68	0	400/300/20/0	Difference
		280		20		100		54/2/6/6/6/6
	58	64	62	58	54	0	500/300/0	*54/4/4/4/4
200							300	
	66	70	52	60	60	0	600/360/340/0	52/8/0/0/0/6
			240	340	20			

$\frac{200}{0}$	$\frac{280}{0}$	$\frac{240}{0}$	$\frac{360}{340}$	$\frac{320}{20}$	$\frac{100}{0}$
$\frac{8}{8}$	$\frac{8}{8}$	$\frac{2}{2}$	$\frac{2}{2}$	$\frac{6}{6}$	0
$\frac{8}{8}$	*8		$\frac{2}{2}$	$\frac{6}{6}$	
8*			$\frac{2}{2}$	$\frac{6}{6}$	
			$\frac{2}{2}$	$\frac{6}{6}$	
			$\frac{2}{2}$	6*	
			2	8*	

	W ₁	W ₂	W ₃	W ₄	W ₅	Dummy	U _i
F ₁	74	56	54	62	68	0	0
		280		20		100	
F ₂	58	64	62	58	54	0	-8
	200	16	18	4	300	8	
F ₃	66	70	52	60	60	0	-2
	2	16	240	340	20	2	
V _j	66	56	54	62	62	0	0



Since $m + n - 1$ allocation, optimality test can be performed.

Since Δ_j is ≥ 0 , the solution is optimal.

		Qty		Minimum Cost
F ₁ →	W ₂ —	280	× 56	= 15680
	W ₄ —	20	× 62	= 1240
	Dummy	100	× 0	= 0
F ₂ →	W ₁ —	200	× 58	= 11600
	W ₅ —	300	× 54	= 16200
F ₃ →	W ₃ —	240	× 52	= 12480
	W ₄ —	340	× 60	= 20400
	W ₅ —	20	× 60	= 1200
		1500		₹ 78800

Alternative Solution:

	74	56	54	62	68	0
		280	20			100
	58	64	62	58	54	0
200					300	
	66	70	52	60	60	0
			220	360	20	

F ₁	W ₂	280 × 56 =	15680
	W ₄	20 × 54 =	1080
	Dummy	100 × 0 =	0
F ₂	W ₁	200 × 58 =	11600
	W ₅	300 × 54 =	16200
F ₃	W ₃	220 × 52 =	11440
	W ₄	360 × 60 =	21600
	W ₅	20 × 60 =	1200
		1500	₹ 78800

Illustration 20.

A Company has 4 factories F₁, F₂, F₃ and F₄, manufacturing the same product. Production and raw material costs differ from factory to factory and are given in the table below in the first two rows. The transportation costs from the factories to the sales depots S₁, S₂ and S₃ are also given. The last two columns in the table below give the sales price and total requirements at each depot and the production capacity of each factory is given in the last row.



	F ₁	F ₂	F ₃	F ₄	Sales Price/Unit (Rs)	Requirement
Production Cost/Unit (₹)	15	18	14	13		
Raw Materials Cost/Unit (₹)	10	9	12	9		
Transportation Cost/Unit (₹)						
S ₁	3	9	5	4	34	80
S ₂	1	7	4	5	32	120
S ₃	5	8	3	6	31	150
Production capacity	10	150	50	100		

Determine the optimal solution and the associated profit by using the Vogel's Approximation Method (VAM).

Solution:

Step 1: To convert the above matrix into cost matrix by adding production cost, raw material cost and transportation cost.

	F ₁	F ₂	F ₃	F ₄	
S ₁	28	36	31	26	80
S ₂	26	34	30	27	120
S ₃	30	35	29	28	150
	10	150	50	100	350
					310

Step 2: Convert the cost matrix to profit matrix by reducing cost from sale price and inserting dummy column (F₅) to balance the matrix.

	F ₁	F ₂	F ₃	F ₄	F ₅	
S ₁	6	-2	3	8	0	80
S ₂	6	-2	2	5	0	120
S ₃	1	-4	2	3	0	150
	10	150	50	100	40	350
						350

Step 3: Convert the profit matrix to loss matrix.

	F ₁	F ₂	F ₃	F ₄	F ₅		
S ₁	2	10	5	0	8	80/0	2/0/0/0
S ₂	2	10	6	3	8	120/110/90/0	1/1/3*/2
S ₃	7	12	6	5	8	150/90/40/0	1/1/1/2*
	10	150	50	100	40		
	0	60	0	20	0		
		0		0	0		
	0	0	1	3*	0		
	5*	2	0	2	0		
		2	0	2	0		
		2	0	0			



$m + n - 1 = \text{No. of allocations}$

$\therefore 3 + 5 - 1 = 7$

$\therefore 7 = 7$

\therefore There is no degeneracy.

Hence optimality test can be performed.

						U_i
	2	10	5	0	8	-3
	3	3	4	80	5	
	2	10	6	3	8	0
	10	90	2	20	2	
	7	12	6	5	8	2
V_j	2	10	4	3	6	
	3	60	50	0	40	

As $\Delta_{ij} \geq 0$, the solution is optimum

		Qty	Maximum Profit
S_1	→ F_4	— 80 x 8 =	640
S_2	F_1	10 x 6 =	60
	F_2	90 x (-2) =	(-) 180
	F_4	20 x 5 =	100
S_3	F_2	60 x -4 =	(-) 240
	F_3	50 x 2 =	100
	F_5 (Dummy)	40 x 0 =	0
		350	₹ 480

Illustration 21.

The products of two plants A and B are to be transported to 3 warehouses W1, W2 and W3. The cost of transportation of each unit from plants to the warehouses are indicated below:

Warehouses				
Plants	(W1)	(W2)	(W3)	Capacities
A	25	17	25	300
B	15	10	18	500
Demand	300	300	500	800/1100

Find the optimum distribution and the optimum cost.



Solution:

	W1	W2	W3				
A	25	17	25	300/0	8	8	8
		100	200				
B	15	10	18	500/200/0	5	5	8
	300	200					
C	0	0	0	300/0	0	-	-
			300				
	300	300	500				
	0	100	200				
		0	0				
	15	10	18*				
	10*	7	7				
	-	7	7				

There are $m + n + 1$ allocation optimality is to be performed.

	W1	W2	W3	U_i
	25	17	25	0
	3	100	200	
	15	10	18	-7
300		200	0	
	0	0	0	-25
	3	8	300	
V_i	22	17	25	

As $\Delta_{ij} \geq 0$, the solution is optimum. Therefore the minimum cost is as follows:

		Quantity	Minimum Cost
A	W2	100 x 17	1700
	W3	200 x 25	5000
B	W1	300 x 15	4500
	W2	200 x 10	2000
	DummyW3	300 x 0	0
		1100	₹ 13200

Optimum cost: ₹ 13,200



Illustration 22.

A company has 3 plants located at different places but producing an identical product. The cost of production, distribution cost of each plant to the 3 different warehouses, the sale price at each warehouse and the individual capacities for both the plant and warehouse are given below:

Plants	F1	F2	F3		
Raw material	15	18	14		
Other expenses	10	9	12		
Distribution cost to warehouse				Sales Price in (₹)	Warehouse Capacity (No)
W1	3	9	5	34	80
W2	1	7	4	32	110
W3	5	8	3	31	150
Capacity of Plant (No.)	150	100	130		

Establish a suitable table giving net profit/loss for a unit produced at different plants and distributed at different locations.

- (b) Introduce a suitable dummy warehouse / plant so as to match the capacities of plants and warehouses.
- (c) Find distribution pattern so as to maximise profit / minimise loss.
- (d) Interpret zero value of square evaluation of an empty cell and find alternative solutions.

Solution:

Profit matrix

	6	-2	3	80
	6	-2	2	110
	1	-4	2	150
	0	0	0	40
150	100	130	380	



Loss Matrix:

40	0	40	8		3	80/40/0	3/3/5
110	0		8		4	110/0	4*
	5		10		4	150/20/0	1/1/6*
	6	20	6	130	6	40/0	0/0/0
		40					
	150	100		130			
	40	0		0			
	0						
	0	2		1			
	5*	2		1			
		2		1			

40	0	40	8		3	U
110	0		8		4	0
	5		10		4	0
	6	20	6	130	6	2
	6	40			6	-2
	0	8		2		

As there are (m+n) - 1 allocations, optimality test can be performed since $\Delta_{ij} \geq 0$.

		Quantity	Maximum Profit
F1	W1	40 x 6	240
	W2	40 x -2	-80
F2	W1	110 x 6	660
F3	W2	20 x -4	-80
	W3	130 x 2	260
F4 Dummy	W2	40 x 0	0
		380	₹ 1000

Profit ₹ 1,000/-



Illustration 23.

A company manufacturing television sets has four plants with a capacity of 125, 250, 175 and 100 units respectively. The company supplies T.V. sets to its four show rooms which have demand of 100,400,90 and 60 units respectively. Due to the differences in the raw material cost and the transportation cost, the profit per unit (in ₹) differ which are given in the following table:

Showroom					
		I	II	III	IV
	I	90	100	120	110
Plants	II	100	105	130	117
	III	111	109	110	120
	IV	130	125	108	113

By using Vogel's approximation method, plan the production programme so as to maximise the profit. Also determine the maximum total profit.

Solution:

Profit matrix

		Show Room				
		I	II	III	IV	
Plants	I	90	100	120	110	125
	II	100	105	130	117	250
	III	111	109	110	120	175
	IV	130	125	108	113	100
		100	400	90	60	650

Loss Matrix:

40	40	30	10	20	125/0	10/10/10
40	0	8	4	13	250/160/100/0	13/13*/12*
110	5	10	4	10	175/0	9/10/11
	20	130			100/0	5
	6	6	6	17		
	40					
	100	400	130	60		
	0	225	0	0		
		125				
		0				
	19*	16	10	3		
		4	10	3		
		4		3		



As there are $m+n-1=7$ but there are 6 allocations only. Therefore a notional allocation called ϵ (epsilon) is to be placed in the least cost unallocated cell.

	40		30		10		20	U
	15	125			5		2	5
	30		25		0		13	0
	10	100		90	2	60		
	19		10		20		10	-4
	3	175		130	16		1	
	0		5		22		17	-20
V	100	ϵ			2		10	
	20	25	0	13				

As $\Delta_{ij} = C_{ij} - (U_{ij} + V_{ij}) \geq 0$, the solution is optimum and therefore maximum profit is as follows:

		Quantity	Maximum Profit
I	II	125 x 100	12500
II	II	100 x 105	10500
	III	90 x 130	11700
	IV	60 x 117	7020
III	II	175 x 109	19075
IV	I	130 x 100	13000
Maximum profit			₹ 73795

Illustration 24.

A manufacturing company has three plants at locations X,Y and Z which supply to the distributors located at A, B, C, D and E. Monthly capacities are 80, 50 and 90 units respectively. Monthly requirements of distributors are 40,40,50,40 and 80 units respectively. Unit transportation costs are given below in Rupees.

	To	A	B	C	D	E
	X	5	8	6	6	3
From	Y	4	7	7	6	6
	Z	8	4	6	6	3

Determine an optimum distribution for the company in order to minimise the total transportation cost.



Solution:

X	5	8	6	6	3	80/0	2/2
	45				80		
Y	4	7	7	6	6	50/10/0	2/2/1/1
	40			10			
Z	8	4	6	6	3	90/50/0	1/1/2/2/0
	40	50					
Dum-my	0	0	0	0	0	30/0	0
				30			
	40	40	50	40	80		
	0	0	0	10	0		
				0			
	4	4	6	6*	3		
	1	3	1	0	3*		
	4*	3*	1	0			
			1*	0			

	5	8	6	6	3		U_i
	2	1	-3	3	80		3
	4	7	7	6	6		4
40		-1	-3	10			0
	8	4	6	6	3		0
	8	40	50	6	3		0
	0	0	0	0	0		0
€		-4	-6	30	0		0
V_j	0	4	6	0	0		

	5	8	6	6	3		U_i
	4	7	5	3	80		3
	4	7	7	6	6		6
40		3	1	10			0
	8	4	6	6	3		6
	4	40	50	0	-3		0
	0	0	0	0	0		0
	2	2	€	30	€		0
V_j	-2	-2	0	0	0		



	A	B	C	D	E	U_i
	5 1	8 4	6 0	6 0	3 80	0
40	4 4	7 3	7 1	6 10	6 3	0
	8 4	4 40	6 50	6 0	3 €	0
	0 2	0 2	0 €	0 30	0 3	6
V_j	4	4	6	6	3	

As $\Delta_{ij} \geq 0$, the solution is optimum. Hence the schedule and cost is as follows:

		Quantity	Minimum Cost
X	E	80 x 3	240
Y	A	40 x 4	160
	D	10 x 6	60
Z	B	40 x 4	160
	C	50 x 6	300
Dummy	D	30 x 0	0
		250	₹ 920

Minimum Cost ₹ 920/-

Illustration 25.

Anand Batteries have plants at X, Y and Z. Its products 'Torch Batteries' is sent in trucks to the warehouses situated at A, B, C and D for final delivery. The shipment, production runs and storage capacities are given on the basis of truckloads/week. The costing for transportation is also on the basis of truckloads.

The plants have their working capacities and the warehouses are of different sizes depending on market demand. The following tables show:

(i) The capacity details of the plants and the warehouses, and (ii) the transportation cost/truckload

Table-1:

Warehouse	Capacity Truckloads	Factory	Production Truckloads
A	16	X	48
B	20	Y	32
C	40	Z	40
D	44	-	—
Total	120		120



Table 2: Transportation cost per truckload in units of ₹100

	A	B	C	D
X	6	11	3.5	6
Y	2	6	5	4
Z	1.5	11	4.5	3

You are required to work out as to how the supplies from the plant be allocated to the warehouses to minimise total transportation cost. Determine the minimum total transportation cost.

Transport cost matrix					
Warehouses	A	B	C	D	Capacity/Production
Factory X	6	11	3.5	6	48
Y	2	6	5	4	32
Z	1.5	11	4.5	3	40
Demand	16	20	40	44	120

Solution:

	A	B	C	D		
X	6	11	3.5	6	48/8/0	2.5/2.5/0/0
Y	2	6	5	4	32/12/0	2/2/2*
Z	1.5	11	4.5	3	40/36/0	1.5/1.5/0.5/1.5
	16	20	40	44		
	4	0	0	8		
	0			0		
	0.5	5*	1	1		
	0.5		1	1		
	0.5			1		
	4.5*			3		

	6	11	3.5	6	U_i
	1.5	2.5	40	8	0
	2	6	5	4	-2.5
	12	20	4	0.5	
	1.5	11	4.5	3	-3
	4	5.5	4	36	
V_j	4.5	8.5	3.5	6	

As $\Delta_{ij} \geq 0$, the solution is optimum.

		Quantity	Minimum Cost '000
X	C	40 x 3.5	140
	D	8 x 6	48
Y	A	12 x 2	24
	B	20 x 6	120
Z	A	4 x 1.5	6
	D	36 x 3	108
Minimum Cost			₹ 446

Minimum Cost ₹ 4,46,000

6.5 SIMULATION

Simulation Technique

Effective evaluations of many real-world situations are too complex. Alternative methods must be used to evaluate the performance of such systems. Simulation is a modeling and analysis tool widely used for the purpose of designing, planning, and control of manufacturing systems. Simulation in general is to pretend that one deals with a real thing while really working with an imitation. In operations research, the imitation is a computer model of the simulated reality. The task of executing simulations provides insight and a deep understanding of physical processes that are being modeled.

Simulation is generally referred to as computer simulation, which simulates the operation of a manufacturing system. A computer simulation or a computer model is a computer program which attempts to simulate an abstract model of a particular system. Computer simulation was developed hand-in-hand with the rapid growth of the computer, following its first large-scale deployment during the Manhattan Project in World War II to model the process of nuclear detonation. Computer simulation is often used an adjunct to, or substitution for, modeling systems for which simple closed form analytic solutions are not possible. There are many different types of computer simulation; the common feature they all share is the attempt to generate a sample of representative scenarios for a model in which a complete enumeration of all possible states of the model would be prohibitive or impossible.

Computer simulations have become a useful part of modeling many natural systems in physics, chemistry and biology, human systems in economics and social science and in the process of new technology in the field of engineering, to gain insight into the operation of those systems. Traditionally, the formal modeling of systems has been via a mathematical model, which attempts to find analytical solutions to problems which enables the prediction of the behaviour of the system from a set of parameters and initial conditions. Computer simulations build on, and are a useful adjunct to purely mathematical models in science and technology and entertainment.

With a computer simulation model, a manager or system analyst is able to observe the behaviour of a process without the necessity of experimenting with the actual system. In order to evaluate the system's performance given various disturbances, or to identify the bottlenecks, they may try out different manufacturing runs, new operational conditions, new equipment layouts or different cycle times.

A simple example of a simulation involves the tossing of a ball into the air. The ball can be said to "simulate" a missile, for instance. That is, by experimenting with throwing balls starting at different initial heights and initial velocity vectors, it can be said that we are simulating the trajectory of a missile. This kind of simulation is known as analog simulation since it involves a physical model of a ball. A flight simulator on a PC is a computer model of some aspects of the flight: it shows on the screen the controls and what the "pilot" (the youngster who operates it) is supposed to see from the "cockpit" (his armchair).



Application of Simulation

- (i) Scheduling aircraft,
- (ii) Job-ship scheduling and personnel scheduling,
- (iii) Manpower-hiring decisions,
- (iv) Traffic light-timing,
- (v) Transport-scheduling,
- (vi) Evaluating alternative investment opportunities, and
- (vii) Design of parking lots, harbor, and communication systems etc.

Advantages of Simulation

- (a) Enables to experiment and study complex interactions of a system (e.g. company operations, economic policies).
- (b) Possible to study the effects of organizational environment informational changes in the operations of a system (e.g. number of stocking points, industrial policies).
- (c) Better insight and understanding of a complex system to indication for improvement.
- (d) Assists in teaching and training (management games).
- (e) New situations policies can be protested.
- (f) Probabilistic features can be easily incorporated.
- (g) A process can be studies in extended or compressed time.
- (h) Risks involved in experimenting with real problems can be eliminated.

Limitations of Simulations

- (a) Simulated results are not precise. Unlike mathematical models, it does not give optimum solutions. At times one may not be able to assess the extent of error in a simulated result.
- (b) Some situations are not amenable to simulation.
- (c) Simulation may be expensive needing advanced computer supports
- (d) Simulation by itself does not generate solutions, but only indicates a way of evaluating solutions.
- (e) It is often a long, complicated process to develop a model.

Steps involved in constructing and using a Simulation Model

All simulation projects follow the following steps :

- (i) Define the problem
- (ii) Data collection
- (iii) Problem analysis
- (iv) Simulation model specification
- (v) Model programming
- (vi) Model validation
- (vii) Simulation experimentation
- (viii) Evaluation and interpretation of simulation results
- (ix) Report generation and plans for implementation of the results



Design of Simulation Model

One should consider the characteristic of the system in question and the nature of the problems to be tackled while choosing a modeling approach. In general the simulation model used in the area of Manufacturing Systems Engineering (MSE) can be classified as :

- (i) Static and Dynamic Simulation Models
- (ii) Continuous and Discrete Simulation Model
- (iii) Stochastic and Deterministic Simulation Model
- (iv) Social Simulation
- (v) Web based Simulation
- (vi) Parallel and Distributed Simulation

Types of Simulation

Simulators are usually divided into the following categories or simulation modes :

- (i) Behavioral simulation
- (ii) Functional simulation
- (iii) Static timing analysis
- (iv) Gate-level simulation
- (v) Switch-level simulation
- (vi) Transistor-level or circuit-level simulation

This list is ordered from high-level to low-level simulation (high-level being more abstract, and low-level being more detailed). Proceeding from high-level to low-level simulation, the simulations become more accurate, but they also become progressively more complex and take longer to run. While it is just possible to perform a behavioral-level simulation of a complete system, it is impossible to perform a circuit-level simulation of more than a few hundred transistors.

There are several ways to create an imaginary simulation model of a system. One method models large pieces of a system as black boxes with inputs and outputs. This type of simulation (often using VHDL or Verilog) is called behavioral simulation . Functional simulation ignores timing and includes unit-delay simulation , which sets delays to a fixed value (for example, 1 ns). Once a behavioral or functional simulation predicts that a system works correctly, the next step is to check the timing performance. At this point a system is partitioned into ASICs and a timing simulation is performed for each ASIC separately (otherwise the simulation run times become too long). One class of timing simulators employs timing analysis that analyzes logic in a static manner, computing the delay times for each path. This is called static timing analysis because it does not require the creation of a set of test (or stimulus) vectors (an enormous job for a large ASIC). Timing analysis works best with synchronous systems whose maximum operating frequency is determined by the longest path delay between successive flip-flops. The path with the longest delay is the critical path .

Logic simulation or gate-level simulation can also be used to check the timing performance of an ASIC. In a gate-level simulator a logic gate or logic cell (NAND, NOR, and so on) is treated as a black box modeled by a function whose variables are the input signals. The function may also model the delay through the logic cell. Setting all the delays to unit value is the equivalent of functional simulation. If the timing simulation provided by a black-box model of a logic gate is not accurate enough, the next, more detailed, level of simulation is switch-level simulation which models transistors as switches—on or off. Switch-level simulation can provide more accurate timing predictions than gate-level simulation, but without the ability to use logic-cell delays as parameters of the models. The most accurate, but also the most complex and time-consuming, form of simulation is transistor-level simulation . A transistor-level simulator requires models of transistors, describing their nonlinear voltage and current characteristics.



Each type of simulation normally uses a different software tool. A mixed-mode simulator permits different parts of an ASIC simulation to use different simulation modes. For example, a critical part of an ASIC might be simulated at the transistor level while another part is simulated at the functional level. Be careful not to confuse mixed-level simulation with a mixed analog/digital simulator, these are mixed-level simulators .

Simulation is used at many stages during ASIC design. Initial prelayout simulations include logic-cell delays but no interconnect delays. Estimates of capacitance may be included after completing logic synthesis, but only after physical design is it possible to perform an accurate postlayout simulation .

Monte Carlo Simulation

Monte Carlo simulation, or probability simulation, is a technique used to understand the impact of risk and uncertainty in financial, project management, cost, and other forecasting models.

Uncertainty in Forecasting Models

When you develop a forecasting model – any model that plans ahead for the future – you make certain assumptions. These might be assumptions about the investment return on a portfolio, the cost of a construction project, or how long it will take to complete a certain task. Because these are projections into the future, the best you can do is estimate the expected value.

You can't know with certainty what the actual value will be, but based on historical data, or expertise in the field, or past experience, you can draw an estimate. While this estimate is useful for developing a model, it contains some inherent uncertainty and risk, because it's an estimate of an unknown value.

Estimating Ranges of Values

In some cases, it's possible to estimate a range of values. In a construction project, you might estimate the time it will take to complete a particular job; based on some expert knowledge, you can also estimate the absolute maximum time it might take, in the worst possible case, and the absolute minimum time, in the best possible case. The same could be done for project costs. In a financial market, you might know the distribution of possible values through the mean and standard deviation of returns.

By using a range of possible values, instead of a single guess, you can create a more realistic picture of what might happen in the future. When a model is based on ranges of estimates, the output of the model will also be a range.

This is different from a normal forecasting model, in which you start with some fixed estimates – say the time it will take to complete each of three parts of a project – and end up with another value – the total time for the project. If the same model were based on ranges of estimates for each of the three parts of the project, the result would be a range of times it might take to complete the project. When each part has a minimum and maximum estimate, we can use those values to estimate the total minimum and maximum time for the project.

Illustration 26.

State the major two reasons for using simulation to solve a problem.

A confectioner sells confectionery items. Past data of demand per week in hundred kilograms with frequency is given below:

Demand/Week	0	5	10	15	20	25
Frequency	2	11	8	21	5	3

Using the following sequence of random numbers, generate the demand for the next 10 weeks. Also find out the average demand per week

Random numbers	35	52	13	90	23	73	34	57
	35	83	94	56	67	66	60	

Solution:



Random No. Range Table for demand				
Demand per week	Frequency	Probability	Cumulative Probability	Range
0	2	.04	.04	0-3
5	11	.22	.26	4-25
10	8	.16	.42	26-41
15	21	.42	.84	42-83
20	5	.10	.94	84-93
25	3	.06	1.00	94-99
	Σf = 50	1.00		

Simulated Values for next 10 weeks		
Weeks	R. Nos.	Demand
1	35	10
2	52	15
3	13	5
4	90	20
5	23	5
6	73	15
7	34	10
8	57	15
9	35	10
10	83	15
		120

Average weekly demand = $\frac{120}{10} = 12$

Illustration 27.

The manager of a book store has to decide the number of copies of a particular tax law book to order. A book costs ₹ 60 and is sold for ₹ 80. Since some of the tax laws change year after year, any copies unsold while the edition is current must be sold for ₹ 30. From past records, the distribution of demand for this book has been obtained as follows:

Demand (No of copies)	15	16	17	18	19	20	21	22
Proportion	0.05	0.08	0.20	0.45	0.10	0.07	0.03	0.02

Using the following sequence of random numbers, generate the demand for 20 time periods(years). Calculate the average profit obtainable under each of the courses of action open to the manager. What is the optimal policy?

14 02 93 99 18 71 37 30 12 10
 88 13 00 57 69 32 18 08 92 73



Solution:

Random No. Range Table			
Demand	Probability	Cumulative Probability	Random Range
15	.05	.05	0-4
16	.08	.13	5-12
17	.20	.33	13-32
18	.45	.78	33-77
19	.10	.88	78-87
20	.07	.95	88-94
21	.03	.98	95-97
22	.02	1.00	98-99
	1.00		

Calculation of demand and profit for next 20 years					
Year	Random Numbers	Expected demand	No. of books unsold if stock is		
			16	17	18
1	14	17	-	-	1
2	02	15	1	2	3
3	93	20	-	-	-
4	99	22	-	-	-
5	18	17	-	-	1
6	71	18	-	-	-
7	37	18	-	-	-
8	30	17	-	-	1
9	12	16	-	1	2
10	10	16	-	1	2
11	88	20	-	-	-
12	13	17	-	-	1
13	00	15	1	2	3
14	57	18	-	-	-
15	69	18	-	-	-
16	32	17	-	-	1
17	18	17	-	-	1
18	08	16	-	1	2
19	92	20	-	-	-
20	73	18	-	-	-
Total			2	7	18



Statement Showing Computation of Profit			
No. of Books order	No. of Books sold	Profit	Average Profit
15	$15 \times 20 = 300$	₹ 6000	₹ 300
16	$16 \times 20 - 2 = 318$	₹ 6300 $(318 \times 20) - 2 \times 30$	₹ 315
17	$(17 \times 20) - 7 = 333$	₹ 6450 $(333 \times 20) - 7 \times 30$	₹ 322.5
18	$(18 \times 20) - 18$	₹ 6300 $(342 \times 20) - 18 \times 30$	₹ 315

Since profit is more at 17 books order, it is the best quantity and ordering is more optimum.

Illustration 28.

A Small retailer has studied the weekly receipts and payments over the past 200 weeks and has developed the following set of information:

Weekly Receipts (₹)	Probability	Weekly Payments (₹)	Probability
3000	0.20	4000	0.30
5000	0.30	6000	0.40
7000	0.40	8000	0.20
12000	0.10	10000	0.10

Using the following set of random numbers, simulate the weekly pattern of receipts and payments for the 12 weeks of the next quarter, assuming further that the beginning bank balance is ₹ 8000. What is the estimated balance at the end of the 12 weekly period? What is the highest weekly balance during the quarter? What is the average weekly balance for the quarter?

Random Numbers

For Receipts	03	91	38	55	17	46	32	43	69	72	24	22
For payments	61	96	30	32	03	88	48	28	88	18	71	99

According to the given information, the random number interval is assigned to both the receipts and the payments.

Solution:

Range of random numbers							
Receipt (₹)	Probability	Cumulative probability	Range	Payments (₹)	Probability	Cumulative probability	Range
3000	0.20	0.20	0-19	4000	0.30	0.30	0-29
5000	0.30	0.50	20-49	6000	0.40	0.70	30-69
7000	0.40	0.90	50-89	8000	0.20	0.90	70-89
12000	0.10	1.00	90-99	10000	0.10	1.00	90-99



Simulation of Data for a period of 12 weeks					
Week	Random No. for receipt	Expected Receipt (₹)	Random No. for payment	Expected Payment (₹)	Week end Balance (₹)
Opening Balance					8000
1	03	3000	61	6000	5000 (8000 + 3000 – 6000)
2	91	12000	96	10000	7000
3	38	5000	30	6000	6000
4	55	7000	32	6000	7000
5	17	3000	03	4000	6000
6	46	5000	88	8000	3000
7	32	5000	48	6000	2000
8	43	5000	28	4000	3000
9	69	7000	88	8000	2000
10	72	7000	18	4000	5000
11	24	5000	71	8000	2000
12	22	5000	99	10000	(3000)

Estimated balance at the end of 12th week = ₹ (3,000)
 Highest balance = ₹ 7,000
 Average balance during the quarter = 45,000/12 = ₹ 3,750

Illustration 29.

Patients arriving at a village dispensary are treated by a doctor on a first-come-first-served basis. The inter-arrival time of the patients is known to be uniformly distributed between 0 and 80 minutes, while their service time is known to be uniformly distributed between 15 and 40 minutes. It is desired to simulate the system and determine the average time a patient has to be in the queue for getting service and the proportion of time the doctor would be idle.

Carry out the simulation using the following sequences of random numbers. The numbers have been selected between 00 and 80 to estimate inter-arrival times and between 15 and 40 to estimate the service times required by the patients.

Series 1	07	21	12	80	08	03	32	65	43	74
Series 2	23	37	16	28	30	18	25	34	19	21

Solution:

Simulation of data at a village dispensary							
No. of patients	Inter arrival time Random No. (minutes)	Entry time in to queue (hrs)	Service Time Random No. (minutes)	Service Start time (hrs)	End time (hrs)	Waiting time of patient (minutes)	Idle time of doctor (minutes)
1	07	8.07	23	8.07	8.30	-	07
2	21	8.28	37	8.30	9.07	2	-
3	12	8.40	16	9.07	9.23	27	-
4	80	10.00	28	10.00	10.28	-	37



5	08	10.08	30	10.28	10.58	20	-
6	03	10.11	18	10.58	11.16	47	-
7	32	10.43	25	11.16	11.41	33	-
8	65	11.48	34	11.48	12.22	-	07
9	43	12.31	19	12.31	12.50	-	09
10	74	01.45	21	01.45	02.06	-	55
Total (in minutes)						129	115

Average waiting time of patient = $129/10 = 12.9$ minutes

Average waiting time of doctor = $115/10 = 11.5$ minutes

It has been assumed that starting time be 8.00 A.M.

Illustration 30.

An automobile production line turns out about 100 cars a day, but deviations occur owing to many causes. The production is more accurately described by the probability distribution given below

Production/Day	Prob.	Production/Day	Prob.
95	0.03	101	0.15
96	0.05	102	0.10
97	0.07	103	0.07
98	0.10	104	0.05
99	0.15	105	0.03
100	0.20		
		Total	1.00

Finished cars are transported across the bay, at the end of each day, by ferry. If the ferry has space for only 101 cars, what will be the average number of cars waiting to be shipped, and what will be the average number of empty space on the boat?

Solution:

Simulation of data of an Automobile Production line			
Production/day	Probability	Cumulative Probability	Random No. Range
95	0.03	0.03	0-2
96	0.05	0.08	3-7
97	0.07	0.15	8-14
98	0.10	0.25	15-24
99	0.15	0.40	25-39
100	0.20	0.60	40-59
101	0.15	0.75	60-74
102	0.10	0.85	75-84
103	0.07	0.92	85-91
104	0.05	0.97	92-96
105	0.03	1.00	97-99
	1.00		



Stimulated data				
Day	Random No.	Production	No. of cars waiting to be shipped	No. of empty space on the boat
1	20	98	-	3
2	63	101	-	-
3	46	100	-	1
4	16	98	-	3
5	45	100	-	1
6	41	100	-	1
7	44	100	-	1
8	66	101	-	-
9	87	103	2	-
10	26	99	-	2
11	78	102	1	-
12	40	100	-	1
13	29	99	-	2
14	92	104	3	-
15	21	98	-	3
Total			6	18

Average no. of cars waiting to be shipped = $6/15 = 0.40$

Average no. of empty space on the boat = $18/15 = 1.2$

Illustration 31.

A book store wishes to carry 'Ramayana' in stock. Demand is probabilistic and replenishment of stock takes 2 days (i.e. if an order is placed on March 1, it will be delivered at the end of the day on March 3). The probabilities of demand are given below

Demand (daily)	0	1	2	3	4
Probability	0.05	0.10	0.30	0.45	0.10

Each time an order is placed, the store incurs an ordering cost of ₹ 10 per order. The store also incurs a carrying cost of ₹ 0.50 per book per day. The inventory carrying cost is calculated on the basis of stock at the end of each day.

The manager of the bookstore wishes to compare two options for his inventory decision.

- A. Order 5 books when the inventory at the beginning of the day plus order outstanding is less than 8 books.
- B. Order 8 books when the inventory at the beginning of the day plus order outstanding is less than 8.

Currently (beginning 1st day) the store has a stock of 8 books plus 6 books ordered two days ago and expected to arrive next day.

Using Monte-Carlo Simulation for 10 cycles, recommend, which option the manager, should choose.

The two digit random numbers are given below:

89 34 70 63 61 81 39 16 13 73

**Solution:**

Demand	Probability	Cumulative Probability	Range
0	0.05	0.05	0-4
1	0.10	0.15	5-14
2	0.30	0.45	15-44
3	0.45	0.90	45-89
4	0.10	1.00	90-99

Option - A

Day	R No.	Demand	Option	Stock order	Closing Stock	Order Placed
1	89	3	8	-	5	-
2	34	2	5	6	9	-
3	70	3	9	-	6	0
4	63	3	6	-	3	5
5	61	3	3	0	0	-
6	81	3	0	5	2	5
7	39	2	2	-	0	5
8	16	2	0	5	3	-
9	13	1	3	5	7	-
10	73	3	7	-	4	5
					39+5=44	

Ordering cost 4 x 10	₹ 40
Carrying cost 0.5 x 44	₹ 22
Total Cost	₹ 62

Option B

Day	R No.	Demand	Option	Orders received	Closing Stock	No. of Orders
1	89	3	8	-	5	-
2	34	2	5	6	9	-
3	70	3	9	-	6	-
4	63	3	6	-	3	8
5	61	3	3	-	0	-
6	81	3	0	8	5	-
7	39	2	5	-	3	8
8	16	2	3	-	1	-
9	13	1	1	8	8	-
10	73	3	8	-	5	-
					45	

Ordering cost 2 x 10	₹ 20.0
Carrying cost 0.5 x 45	₹ 22.5
Total Cost	₹ 42.5

Option 'B' is better because it has low Inventory costs.



Illustration 32.

After observing heavy congestion of customers over a period of time in a petrol station, Mr. Petro has decided to set up a petrol pump facility on his own in a nearby site. He has compiled statistics relating to the potential customer arrival pattern and service pattern as given below. He has also decided to evaluate the operations by using the simulation technique.

Arrivals		Services	
Inter-arrival time (minutes)	Probability	Inter-arrival time (minutes)	Probability
2	0.22	4	0.28
4	0.30	6	0.40
6	0.24	8	0.22
8	0.14	10	0.10
10	0.10		

Assume:

- i) The clock starts at 8:00 hours
- ii) Only one pump is set up.
- iii) The following 12 Random Numbers are to be used to depict the customer arrival pattern:
78, 26, 94, 08, 46, 63, 18, 35, 59, 12, 97 and 82.
- iv) The following 12 Random Numbers are to be used to depict the service pattern:
44, 21, 73, 96, 63, 35, 57, 31, 84, 24, 05, 37

You are required to find out the

- i) probability of the pump being idle, and
- ii) Average time spent by a customer waiting in queue.

Solution:

Minutes	Inter-arrival time			Minutes	Service time		
	Probability	Cumulative probability	Range		Probability	Cumulative probability	Range
2	.22	.22	00-21	4	.28	.28	00-27
4	.30	.52	22-51	6	.40	.68	28-67
6	.24	.76	52-75	8	.22	.90	68-89
8	.14	.90	76-89	10	.10	1.00	90-99
10	.10	1.00	90-99				

Sl. No.	Random No. for inter arrival	Inter arrival time	Entry time in queue	Service start time	Random no for service.	Service time	Service end time	Waiting time of customer	Idle time
1	78	8	8.08	8.08	44	6	8.14	-	8
2	26	4	8.12	8.14	21	4	8.18	2	-
3	94	10	8.22	8.22	73	8	8.30	-	4
4	08	2	8.24	8.30	96	10	8.40	6	-
5	46	4	8.28	8.40	63	6	8.46	12	-
6	63	6	8.34	8.46	35	6	8.52	12	-



7	18	2	8.36	8.52	57	6	8.58	16	-
8	35	4	8.40	8.58	31	6	9.04	18	-
9	59	6	8.46	9.04	84	8	9.12	18	-
10	12	2	8.48	9.12	24	4	9.16	34	-
11	97	10	8.58	9.16	05	4	9.20	18	-
12	82	8	9.06	9.20	37	6	9.26	14	-
Total Time								140	12

Average waiting time spent by the customer = 140/12 = 11.67 minutes

Probability of idle time of petrol station = 12/86 = 0.1395

Illustration 33.

The Tit-Fit Scientific Laboratories is engaged in producing different types of high class equipment for use in science laboratories. The company has two different assembly lines to produce its most popular product 'Pressure'. The processing time for each of the assembly lines is regarded as a random variable and is described by the following distributions.

Process Time (minutes)	Assembly A1	Assembly A2
10	0.10	0.20
11	0.15	0.40
12	0.40	0.20
13	0.25	0.15
14	0.10	0.05

Using the following random numbers, generate data on the process times for 15 units of the item and compute the expected process time for the product. For the purpose, read the numbers vertically taking the first two digits for the processing time on assembly A1 and the last two digits for processing time on assembly A2.

4134	8343	3602	7505	7428
7476	1183	9445	0089	3424
4943	1915	5415	0880	9309

In the first stage, we assign random number intervals to the processing times on each of the assemblies.

Solution:

Computation of Random Interval for Processing Time

Process time Minutes	A1			A2		
	P _i	∑P _i	Range	P _i	∑P _i	Range
10	0.10	0.10	0-9	0.20	0.20	0-19
11	0.15	0.25	10-24	0.10	0.60	20-59
12	0.40	0.65	25-64	0.20	0.80	60-79
13	0.25	0.90	65-89	0.15	.095	80-94
14	0.10	1.00	90-99	0.05	1.00	95-99



Simulated data for 15 units

	Random No.	Process Time	Random No.	Process Time	Total
1	41	12	34	11	23
2	74	13	76	12	25
3	49	12	43	11	23
4	83	13	43	11	24
5	11	11	83	13	24
6	11	11	83	13	24
7	36	12	02	10	22
8	94	14	45	11	25
9	54	12	15	10	22
10	75	13	05	10	23
11	00	10	89	13	23
12	08	10	80	13	23
13	74	13	28	11	24
14	34	12	24	11	23
15	93	14	09	10	24
		182		167	349

Average Process time for

$A1 = 182/15 = 12.13$ Minutes

$A2 = 167/15 = 11.13$ Minutes

For product = $349/15 = 23.27$ Minutes

Expected process time for the product = 23.27 minutes (12 .13 + 11.13)

Illustration 34.

A businessman is considering taking over a certain new business. Based on past information and his own knowledge of the business, he works out the probability distribution of the monthly costs and sales revenues, as given here:

Cost (in ₹)	Probability	Sales Revenue (₹)	Probability
17000	0.10	19000	0.10
18000	0.10	20000	0.10
19000	0.40	21000	0.20
20000	0.20	22000	0.40
21000	0.20	23000	0.15
		24000	0.05

Use the following sequences of random numbers to be used for estimating costs and revenues. Obtain the probability distribution of the monthly net revenue.

Sequence 1	82	84	28	82	36	92	73	91	63	29
	27	26	92	63	83	02	10	39	10	10
Sequence 2	39	72	38	29	71	83	19	72	92	59
	49	39	72	94	04	92	72	18	09	00



b. Repeat the analysis in (a) by using the following random number streams:

Sequence 1	20	63	46	16	45	41	44	66	87	26
	78	40	29	92	21	36	57	03	28	08
Sequence 2	23	57	99	84	51	29	41	11	66	30
	41	80	62	74	64	26	41	40	97	15

Solution:

Cost (₹)	Probability	Cumulative Probability	Random Range	Cost (₹)	Probability	Cumulative Probability	Random Range
17000	0.1	0.1	00-09	19000	0.1	0.1	00-09
18000	0.1	0.2	10-19	20000	0.1	0.2	10-19
19000	0.4	0.6	20-59	21000	0.2	0.4	20-39
20000	0.2	0.8	60-79	22000	0.4	0.8	40-79
21000	0.2	1.0	80-99	23000	0.15	0.95	80-94
				24000	0.05	1.00	95-99

Month	Random No. for Cost	Cost (₹)	Random No. for Sales	Cost (₹)	Monthly Net Revenue (₹)
1	82	21000	39	21000	-
2	84	21000	72	22000	1000
3	28	19000	38	21000	2000
4	82	21000	29	21000	-
5	36	19000	71	22000	3000
6	92	21000	83	23000	2000
7	73	20000	19	20000	-
8	91	21000	72	22000	1000
9	63	20000	92	23000	3000
10	29	19000	59	22000	3000
11	27	19000	49	22000	3000
12	26	19000	39	21000	2000
13	92	21000	72	22000	1000
14	63	20000	94	23000	3000
15	83	21000	04	19000	(2000)
16	02	17000	92	23000	6000
17	10	18000	72	22000	4000
18	39	19000	18	20000	1000
19	10	18000	09	19000	1000
20	10	18000	00	19000	1000
					35000

Average = 35000/20=₹1750



6.6 NETWORK ANALYSIS – CPM/PERT

Network Analysis

Network analysis is the general name given to certain specific techniques which can be used for planning, management and control of project. It often acts as a network management tool for breaking down projects into components or individual activities and recording the result on a flow chart or network diagram. These results generally reveal information that is used to determine duration, resource limitations and cost estimates associated with the project.

It offers insight into what is occurring at each critical point of the network. Project management and efficient resource allocation are two critical aspects of the production and operations managers' responsibilities. Since a project is non-repetitive and temporal in nature, the mode of management differs from the usual job shop or other related types of scheduling.

Network analysis enables us to take a systematic quantitative structural approach to the problem of managing a project through to successful completion. Also, since it has a graphical representation, it can be easily understood and used by those with a less technical background.

Network is a graphical representation of all the Activities and Events arranged in a logical and sequential order. Network analysis plays an important role in project management. A project is a combination of interrelated activities all of which must be executed in a certain order for its completion. Activity is the actual performance of the job. This consumes resources (Time, human resources, money, and material. An event refers to start or completion of a job. This does not consume any resources.

Applications:

- (i) Construction of a Residential complex,
- (ii) Commercial complex,
- (iii) Petro-chemical complex
- (iv) Ship building
- (v) Satellite mission development
- (vi) Installation of a pipe line project etc...

The procedure of drawing a network is:

1. **Specify the Individual Activities:** From the work breakdown structure, a listing can be made of all the activities in the project. This listing can be used as the basis for adding sequence and duration information in later steps.
2. **Determine the Sequence of the Activities:** Some activities are dependent on the completion of others. A listing of the immediate predecessors of each activity is useful for constructing the CPM network diagram.
3. **Draw the Network Diagram:** Once the activities and their sequencing have been defined, the CPM diagram can be drawn. CPM originally was developed as an activity on node (AON) network, but some project planners prefer to specify the activities on the arcs.
4. **Estimate Activity Completion Time:** The time required to complete each activity can be estimated using past experience or the estimates of knowledgeable persons. CPM is a deterministic model that does not take into account variation in the completion time, so only one number is used for an activity's time estimate.
5. **Identify the Critical Path:** The critical path is the longest-duration path through the network. The significance of the critical path is that the activities that lie on it cannot be delayed without delaying the project. Because of its impact on the entire project, critical path analysis is an important aspect of project planning.

The critical path can be identified by determining the four parameters for each activity. The four parameters are Earliest Start, Earliest Finish, Latest Finish and Latest Start.



Rules for drawing the network diagrams.

In a network diagram, arrows represent the activities and circles represent the events.

- (i) The tail of an arrow represents the start of an activity and the head represent the completion of the activity.
- (ii) The event numbered 1 denotes the start of the project and is called initial event.
- (iii) Event carrying the highest number in the network denotes the completion of the project and is called terminal event.
- (iv) Each defined activity is represented by one and only arrow in the network.
- (v) Determine which operation must be completed immediately before other can start.
- (vi) Determine which other operation must follow the other given operation.
- (vii) The network should be developed on the basis of logical, analytical and technical dependencies between various activities of the project.

The basic network construction – Terminology used.

Network representation: There are two types of systems –

AOA system (Activity on Arrow system)	AON system (Activity on Node system)
In this activities are represented by an arrows.	In this method activities are represented in the circles.

A project consists of tasks with definite starting and ultimate ending points and hence a project manager is saddled with the responsibilities of getting job done on schedule within allowable cost and time constraint specified by the management. Typically all projects can be broken into:

Separate activities – where each activity has an associated completion time (time from the start of the activity to its finish).

Precedence relationships – which govern order in which we may perform the activities.

The main problem is to bring all these activities together in a coherent fashion to complete the project at a required time.

Apart from the traditional method of adding activity durations, these exist two different techniques for network analysis namely the PERT – Program Evaluation and Review Technique and CPM – Critical Path Management.

PERT has the ability to cope with uncertainty in activity completion times while CPM emphasized on the trade-off between cost of the project and its overall completion time.

The CPM has the advantage of decreasing completion times by probably spending more money.

Differences between PERT & CPM

PERT	CPM
1. It is a technique for planning scheduling & controlling of projects whose activities are subject to uncertainty in the performance time. Hence it is a probabilistic model.	1. It is a technique for planning scheduling & controlling of projects whose activities not subjected to any uncertainty and the performance times are fixed. Hence it is a deterministic model.
2. It is an Event oriented system	2. It is an Activity oriented system
3. Basically does not differentiate critical and non-critical activities.	3. Differentiates clearly the critical activities from the other activities.
4. Used in projects where resources (men, materials, money) are always available when required.	4. Used in projects where overall costs is of primarily important. Therefore better utilized resources.
5. Suitable for Research and Development projects where times cannot be predicted.	5. Suitable for civil constructions.



Critical Path Analysis and PERT are powerful tools that help you to schedule and manage complex projects. They were developed in the 1950s to control large defense projects, and have been used routinely since then.

As with Gantt Charts, Critical Path Analysis (CPA) or the Critical Path Method (CPM) helps you to plan all tasks that must be completed as part of a project. They act as the basis both for preparation of a schedule, and of resource planning. During management of a project, they allow you to monitor achievement of project goals. They help you to see where remedial action needs to be taken to get a project back on course.

Within a project it is likely that you will display your final project plan as a Gantt Chart (using Microsoft Project or other software for projects of medium complexity or an excel spreadsheet for projects of low complexity). The benefit of using CPA within the planning process is to help you develop and test your plan to ensure that it is robust. Critical Path Analysis formally identifies tasks which must be completed on time for the whole project to be completed on time. It also identifies which tasks can be delayed if resource needs to be reallocated to catch up on missed or overrunning tasks. The disadvantage of CPA, if you use it as the technique by which your project plans are communicated and managed against, is that the relation of tasks to time is not as immediately obvious as with Gantt Charts. This can make them more difficult to understand.

A further benefit of Critical Path Analysis is that it helps you to identify the minimum length of time needed to complete a project. Where you need to run an accelerated project, it helps you to identify which project steps you should accelerate to complete the project within the available time.

Critical Path Analysis (**CPA**) is a project management tool that:

- (i) Sets out all the individual activities that make up a larger project.
- (ii) Shows the order in which activities have to be undertaken.
- (iii) Shows which activities can only taken place once other activities have been completed.
- (iv) Shows which activities can be undertaken simultaneously, thereby reducing the overall time taken to complete the whole project.
- (v) Shows when certain resources will be needed – for example, a crane to be hired for a building site.

In order to construct a CPA, it is necessary to estimate the elapsed time for each activity – that is the time taken from commencement to completion.

Then the CPA is drawn up based on dependencies such as:

- (i) The availability of labour and other resources
- (ii) Lead times for delivery of materials and other services
- (iii) Seasonal factors – such as dry weather required in a building project

Once the CPA is drawn up, it is possible to see the CRITICAL PATH itself – this is a route through the CPA, which has no spare time (called 'FLOAT' or 'slack') in any of the activities. In other words, if there is any delay to any of the activities on the critical path, the whole project will be delayed unless the firm makes other changes to bring the project back on track.

The total time along this critical path is also the minimum time in which the whole project can be completed.

Some branches on the CPA may have FLOAT, which means that there is some spare time available for these activities.

What can a business do if a project is delayed?

- (i) Firstly, the CPA is helpful because it shows the likely impact on the whole project if no action were taken.
- (ii) Secondly, if there is float elsewhere, it might be possible to switch staff from another activity to help catch up on the delayed activity.
- (iii) As a rule, most projects can be brought back on track by using extra labour – either by hiring additional people or overtime. Note, there will be usually be an extra cost. Alternative suppliers can usually be found – but again, it might cost more to get urgent help.
- (iv) Nodes are numbered to identify each one and show the Earliest Start Time (EST) of the activities that immediately follow the node, and the Latest Finish Time (LFT) of the immediately preceding activities



- (v) The CPA must begin and end on one 'node' – see below
- (vi) There must be no crossing activities in the CPA
- (vii) Each activity is labelled with its name eg 'print brochure', or it may be given a label, such as 'D', below.
- (viii) The activities on the critical path are usually marked with a '//'

In the example below

- The Node is number 3
- The EST for the following activities is 14 days
- The LFT for the preceding activities is 16 days
- There is 2 days' float in this case (difference between EST and LFT)
- The activity that follows the node is labelled 'D' and will take 6 days

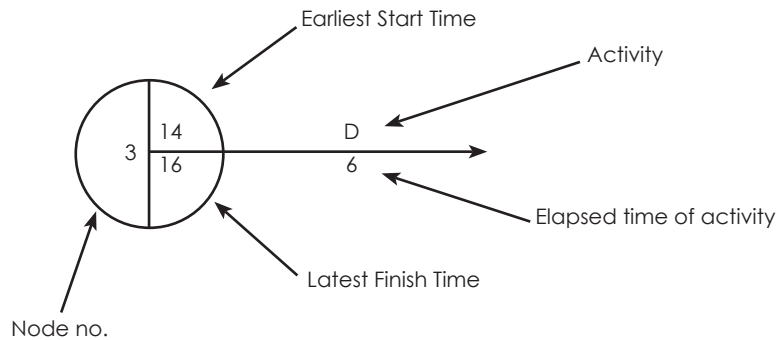

A simple example – baking a loaf of bread

Here is a simple example, in which some activities depend on others having been undertaken in order, whereas others can be done independently.

Activity	Preceded by	Elapsed time (minutes)
A - Weigh ingredients	-	1
B - Mix ingredients	A	3
C - Dough rising time	B	60
D - Prepare tins	-	1
E - Pre-heat oven	-	10
F - Knock back dough and place in tins	C&D	2
G - 2 nd dough rising time	F	15
H - Cooking time	E & G	45

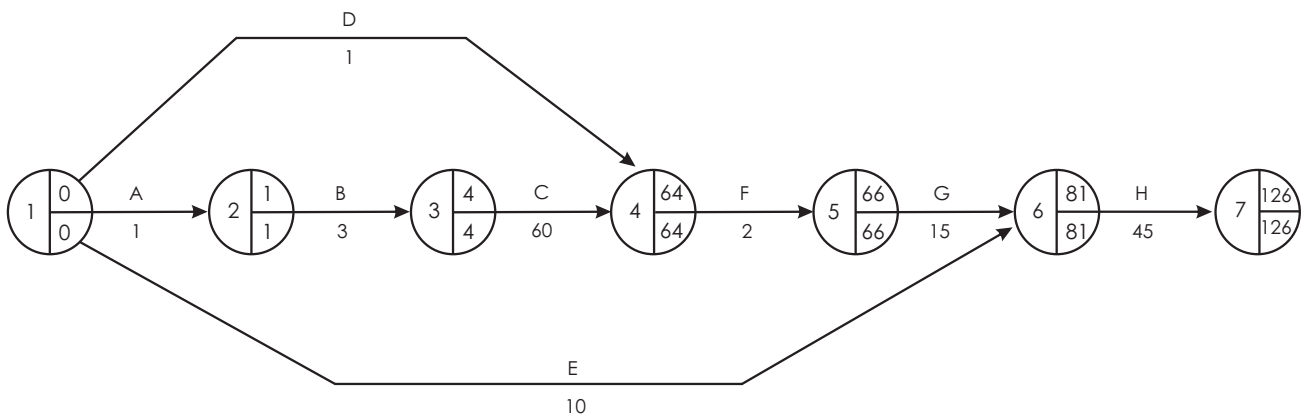



In this example, there is a clear sequence of events that have to happen in the right order. If any of the events on the critical path is delayed, then the bread will not be ready as soon. However, tasks D (prepare tins) and E (heat the oven) can be started at any time as long as they are done by the latest finish time in the following node.

So, we can see that the oven could be switched on as early as time 0, but we can work out that it could be switched on at any time before 71 – any later than this and it won't be hot enough when the dough is ready for cooking. There is some 'float' available for tasks D and E as neither is on the critical path.

This is a fairly simple example, and we can see the LST and LFT are the same in each node. In a more complex CPA, this will not necessarily be the case, and if so, will indicate that there is some 'float' in at least one activity leading to the node. However, nodes on the critical path will always have the same EST and LFT.

CPA is a planning and project management tool. Whilst it can help ensure a project is completed as quickly as possible, and resources used as efficiently as possible, it does depend on the accuracy of the information used.

Just drawing up a CPA will not in itself ensure a project runs to plan; most projects encounter some delay or something unexpected, so managers need to use tool such as CPA to monitor the project and take swift action to rectify any problems.

Drawing a Critical Path Analysis Chart

Use the following steps to draw a CPA Chart:

Step 1. List all activities in the plan

For each activity, show the earliest start date, estimated length of time it will take, and whether it is parallel or sequential. If tasks are sequential, show which stage they depend on.

Figure 1. Task List: Planning a custom-written computer project

Task	Earliest start	Length	Type	Dependent on...
A. High level analysis	Week 0	1 week	Sequential	
B. Selection of hardware platform	Week 1	1 day	Sequential	A
C. Installation and commissioning of hardware	Week 1.2	2 weeks	Parallel	B
D. Detailed analysis of core modules	Week 1	2 weeks	Sequential	A
E. Detailed analysis of supporting modules	Week 3	2 weeks	Sequential	D
F. Programming of core modules	Week 3	2 weeks	Sequential	D
G. Programming of supporting modules	Week 5	3 weeks	Sequential	E
H. Quality assurance of core modules	Week 5	1 week	Sequential	F
I. Quality assurance of supporting modules	Week 8	1 week	Sequential	G
J. Core module training	Week 6	1 day	Parallel	C,H
K. Development and QA of accounting reporting	Week 5	1 week	Parallel	E
L. Development and QA of management reporting	Week 5	1 week	Parallel	E
M. Development of Management Information System	Week 6	1 week	Sequential	L
N. Detailed training	Week 9	1 week	Sequential	I, J, K, M

Step 2. Plot the activities as a circle and arrow diagram

Critical Path Analyses are presented using circle and arrow diagrams.

In these, circles show events within the project, such as the start and finish of tasks. The number shown in the left hand half of the circle allows you to identify each one easily. Circles are sometimes known as nodes.

An arrow running between two event circles shows the activity needed to complete that task. A description of the task is written underneath the arrow. The length of the task is shown above it. By convention, all arrows run left to right. Arrows are also sometimes called arcs.

An example of a very simple diagram is shown below:

Figure 2: Simple Circle and Arrow Diagram



This shows the start event (circle 1), and the completion of the 'High Level Analysis' task (circle 2). The arrow between them shows the activity of carrying out the High Level Analysis. This activity should take 1 week.

Where one activity cannot start until another has been completed, we start the arrow for the dependent activity at the completion event circle of the previous activity. An example of this is shown below:

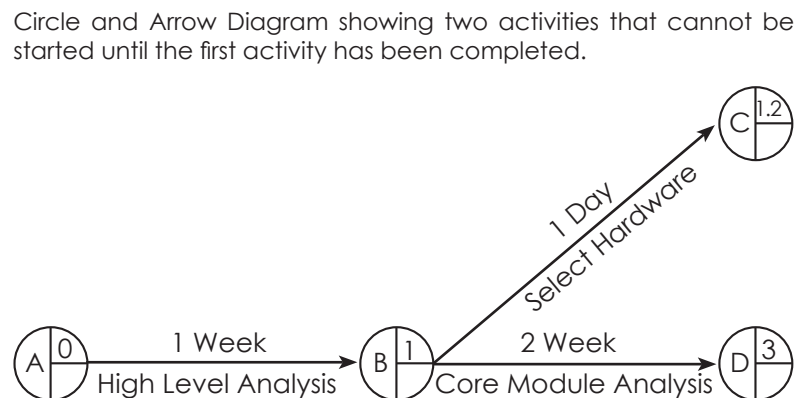

Here the activities of 'Select Hardware' and 'Core Module Analysis' cannot be started until 'High Level Analysis' has been completed. This diagram also brings out a number of other important points:

- Within Critical Path Analysis, we refer to activities by the numbers in the circles at each end. For example, the task 'Core Module Analysis' would be called activity 2 to 3. 'Select Hardware' would be activity 2 to 9.
- Activities are not drawn to scale. In the diagram above, activities are 1 week long, 2 weeks long, and 1 day long. Arrows in this case are all the same length.
- In the example above, you can see a second number in the top, right hand quadrant of each circle. This shows the **earliest start time** for the following activity. It is conventional to start at 0. Here units are whole weeks.

A different case is shown below:

Circle and Arrow Diagram showing an activity (6 to 7) that cannot start until other activities (11 to 6, 5 to 6, 4 to 6, and 8 to 6) have been completed.

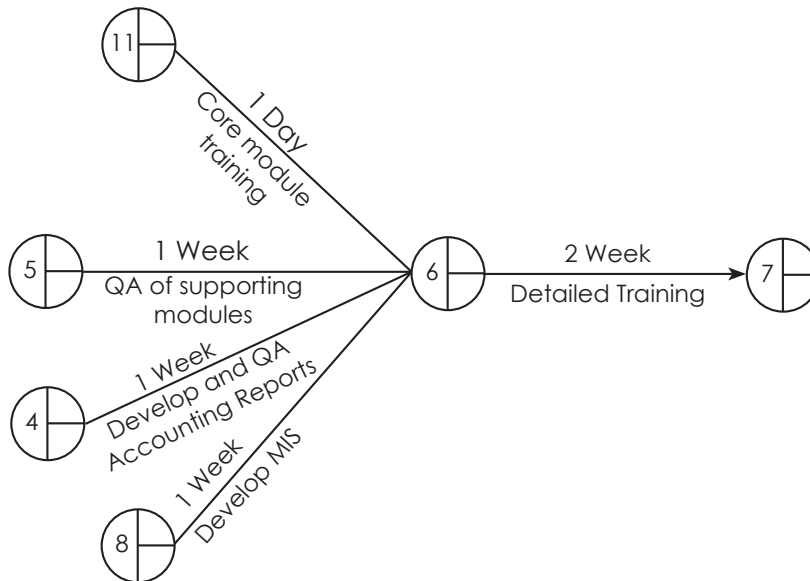

Here activity 6 to 7 cannot start until the other four activities (11 to 6, 5 to 6, 4 to 6, and 8 to 6) have been completed.

Click the link below for the full circle and arrow diagram for the computer project we are using as an example.

Critical Path Analysis for Example Computer Project

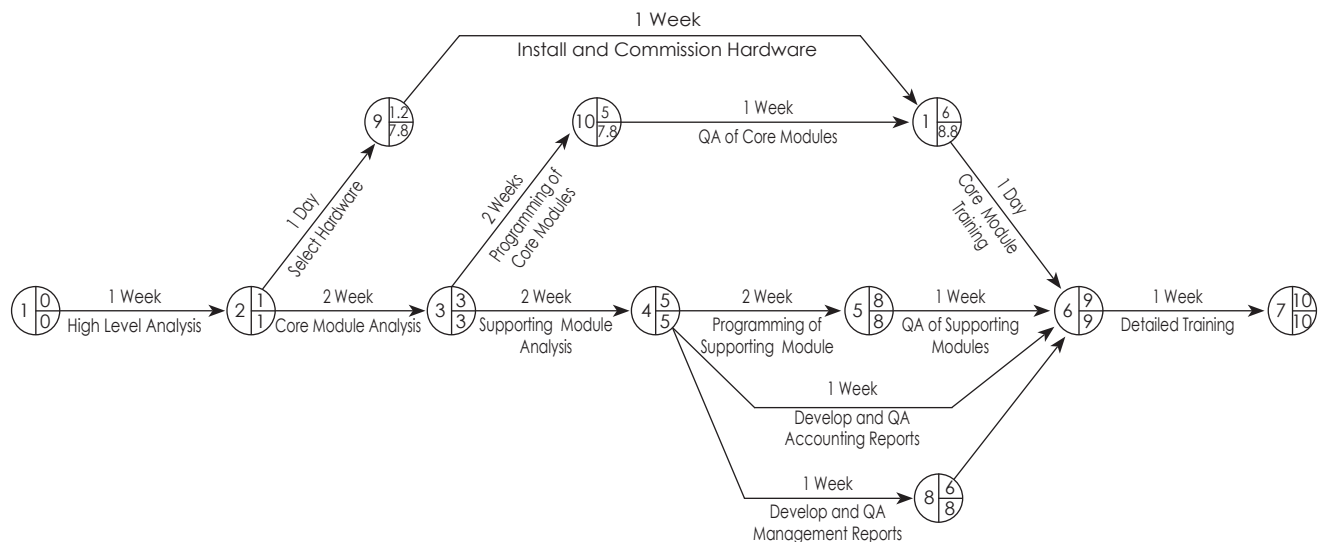

This shows all the activities that will take place as part of the project. Notice that each event circle also has a figure in the bottom, right hand quadrant. This shows the latest finish time that's permissible for the preceding activity if the project is to be completed in the minimum time possible. You can calculate this by starting at the last event and working backwards. The latest finish time of the preceding event and the earliest start time of the following event will be the same for circles on the critical path.

You can see that event M can start any time between weeks 6 and 8. The timing of this event is not critical. Events 1 to 2, 2 to 3, 3 to 4, 4 to 5, 5 to 6 and 6 to 7 must be started and completed on time if the project is to be completed



in 10 weeks. This is the 'critical path' – these activities must be very closely managed to ensure that activities are completed on time. If jobs on the critical path slip, immediate action should be taken to get the project back on schedule. Otherwise completion of the whole project will slip.

'Crash Action'

You may find that you need to complete a project earlier than your Critical Path Analysis says is possible. In this case you need to re-plan your project.

You have a number of options and would need to assess the impact of each on the project's cost, quality and time required to complete it. For example, you could increase resource available for each project activity to bring down time spent on each but the impact of some of this would be insignificant and a more efficient way of doing this would be to look only at activities on the critical path.

As an example, it may be necessary to complete the computer project in Figure 5 in 8 weeks rather than 10 weeks. In this case you could look at using two analysts in activities 2 to 3 and 3 to 4. This would shorten the project by two weeks, but may raise the project cost – doubling resources at any stage may only improve productivity by, say, 50% as additional time may need to be spent getting the team members up to speed on what is required, coordinating tasks split between them, integrating their contributions etc.

In some situations, shortening the original critical path of a project can lead to a different series of activities becoming the critical path. For example, if activity 4 to 5 were reduced to 1 week, activities 4 to 8 and 8 to 6 would come onto the critical path.

PERT (Program Evaluation and Review Technique)

PERT is a variation on Critical Path Analysis that takes a slightly more skeptical view of time estimates made for each project stage. To use it, estimate the shortest possible time each activity will take, the most likely length of time, and the longest time that might be taken if the activity takes longer than expected.

Use the formula below to calculate the time to use for each project stage:

$$\frac{\text{shortest time} + 4 \times \text{likely time} + \text{longest time}}{6}$$

This helps to bias time estimates away from the unrealistically short time-scales normally assumed.

Illustration 35.

XYZ Auto-manufacturing company has to prepare a design of its latest model of motorcycle. The various activities to be performed to prepare design are as follows:

Activity	Description of activity	Preceding activity
A	Prepare drawing	—
B	Carry out cost analysis	A
C	Carry out financial analysis	A
D	Manufacture tools	C
E	Prepare bill of material	B, C
F	Receive material	D, E
G	Order sub-accessories	E
H	Receive sub-accessories	G
I	Manufacture components	F
J	Final assembly	I, H
K	Testing and shipment	J

Prepare an appropriate network diagram.

Solution:

The network diagram will be as follows:

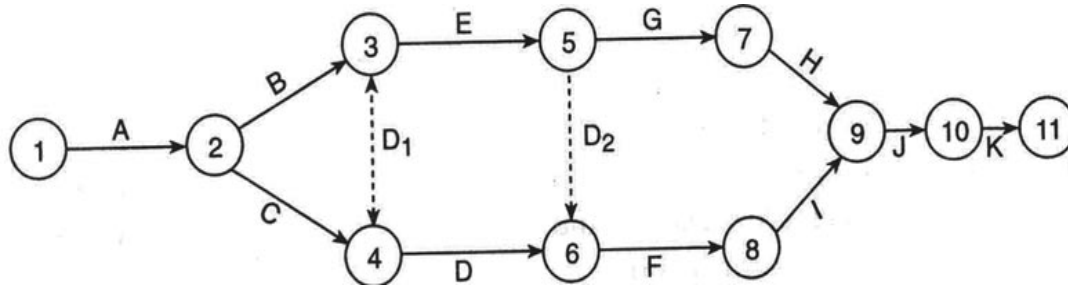

Where D_1 and D_2 are dummy activities.

Illustration 36.

A civil engineering firm has to bid for the construction of a dam. The activities and time estimates are given below:

Activity	DURATION		
	Optimistic	Most likely	Pessimistic
1—2	14	17	25
2—3	14	18	21
2—4	13	15	18
2—8	16	19	28
3—4 (dummy)			
3—5	15	18	27
4—6	13	17	21
5—7 (dummy)			
5—9	14	18	20
6—7 (dummy)			
6—8 (dummy)			
7—9	16	20	41
8—9	14	16	22

The policy of the firm with respect to submitting bids is to bid the minimum amount that will provide a 95% of probability of at best breaking even. The fixed costs for the project are 8 lakhs and the variable costs are ₹9,000 everyday spent working on the project. The duration is in days and the costs are in terms of rupees.

What amount should the firm bid under this policy? (You may perform the calculations on duration etc. upto two decimal places.



Solution:

The expected duration and variance of each activity is computed in the following table :

Activity	Optimistic (t _o)	Time most likely (t _m)	Pessimistic (t _p)	Expected duration $t_e = \frac{1}{6}(t_o + 4t_m + t_p)$	Variance $\left[\frac{1}{6}(t_p - t_o)\right]^2$
1—2	14	17	25	17.83	3.36
2—3	14	18	21	17.83	1.36
2—4	13	15	18	15.17	
2—8	16	19	28	20.00	
3—4	—	—	—	—	
3—5	15	18	27	19.00	4
4—6	13	17	21	17.00	
5—7	—	—	—	—	
5—9	14	18	20	17.67	
6—7	—	—	—	—	
6—8	—	—	—	—	
7—9	16	20	41	22.83	17.36
8—9	14	16	22	16.67	

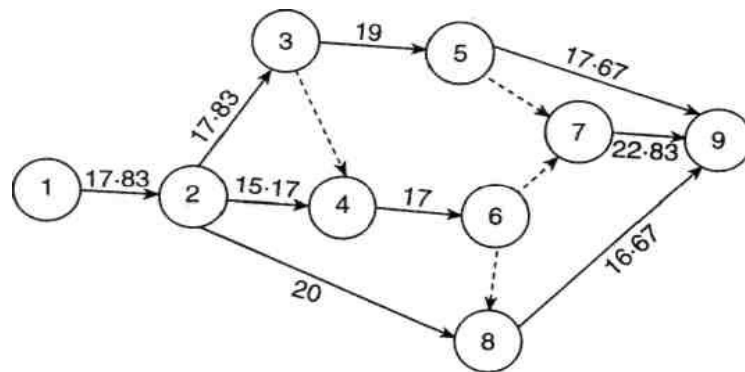

The various paths and their lengths are as follows:

	Path	Duration
I.	1-2-3-5-7-9	77.49*
II.	1-2-3-5-9	72.33
III.	1-2-3-4-6-7-9	75.49
IV.	1-2-3-4-6-8-9	69.33
V.	1-2-8-9	54.50
VI.	1-2-4-6-8-9	66.67
VII.	1-2-4-6-7-9	72.83



Thus, the critical path is 1—2—3—5—7—9 with project duration of 77.49 days. Project variance is obtained by summing variances of critical activities, $\sigma^2 = 3.36 + 1.36 + 4 + 17.36 = 26.08$.

∴ Standard duration of project length, $\sigma = \sqrt{26.08} = 5.11$

To calculate the project duration which will have 95% chances of its completion, we find the value of Z corresponding to 95% area from normal distribution area table which is 1.645. Thus

$$P(X \leq T_s) = P\left(Z \leq \frac{T_s - 77.49}{5.11}\right) = 0.95$$

$$= \frac{T_s - 77.49}{5.11} = 1.645 \quad \text{or} \quad T_s = 1.645 \times 5.11 + 77.49 = 86 \text{ days.}$$

Since the fixed cost of the project is ₹ 8 lakhs and the variable cost is ₹ 9000 per day, amount to bid = ₹ 8 lakhs + ₹ 9000 × 86 = ₹ 15,74,000.

Illustration 37.

The following table gives data on normal time & cost and crash time & cost for a project.

Activity	Normal		Crash	
	Time (days)	Cost (₹)	Time (days)	Cost (₹)
1—2	6	600	4	1,000
1—3	4	600	2	2,000
2—4	5	500	3	1,500
2—5	3	450	1	650
3—4	6	900	4	2,000
4—6	8	800	4	3,000
5—6	4	400	2	1,000
6—7	3	450	2	800

The indirect cost per day is ₹ 100.

- (i) Draw the network and identify the critical path.
- (ii) What are the normal project duration and associated cost?
- (iii) Crash the relevant activities systematically and determine the optimum project completion time and cost.

Solution:

- (i) The network for normal activity times indicates a project time of 22 weeks with the critical path 1-2-4-6-7.

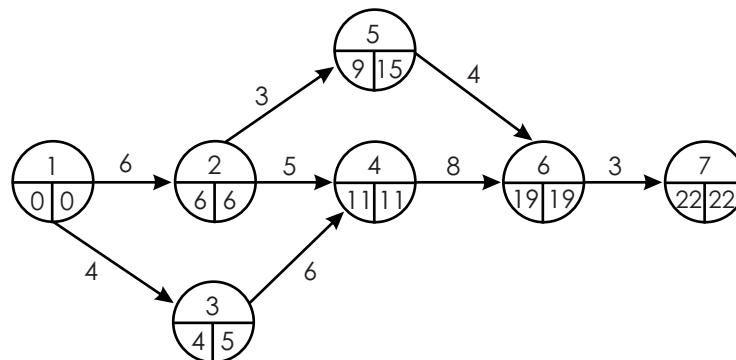

- (ii) Normal project duration is 22 weeks and the associated cost is as follows:

$$\begin{aligned} \text{Total cost} &= \text{Direct normal cost} + \text{Indirect cost for 22 weeks.} \\ &= 4,700 + 100 \times 22 = ₹ 6,900. \end{aligned}$$



(iii) For critical activities, crash cost - slope is given below:

Critical activity	Crash cost-slop
1-2	$\frac{1000 - 600}{6 - 4} = 200$
2-4	$\frac{1500 - 500}{5 - 3} = 500$
4-6	$\frac{3000 - 800}{8 - 4} = 550$
6-7	$\frac{800 - 450}{3 - 2} = 350$

Of the activities lying on the critical path, activity 1—2 has lowest cost slope Therefore, we shall first crash this activity by just one day.

Duration = 21 days, and cost = 4700 + 1 x 200 + 100 x 21 = ₹ 7000.

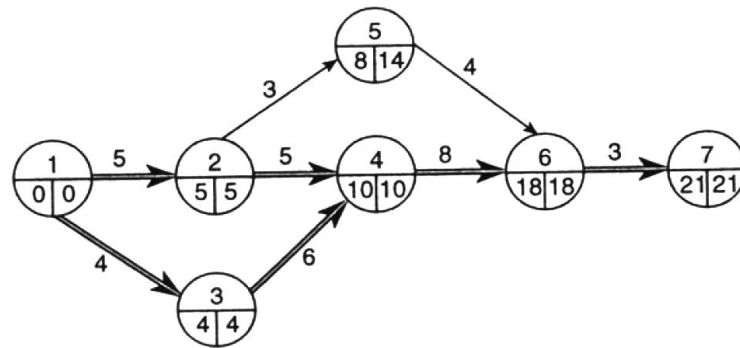

Other activities too have become critical. Now we have 2 critical paths:

1→2→3→6→7 and 1→3→4→6→7.

To reduce duration of the activity further, we shall have to reduce duration of both the paths. We have following alternatives:

Crash activity 6 — 7 by 1 day at a cost of ₹ 350.

Crash activity 4 — 6 by 4 days at the cost of ₹ 550 per day.

Crash activities 1—2 and 1 — 3 by 1 day each at a cost of ₹ (200 + 700) = ₹ 900.

Crash activities 2 — 4 and 3 — 4 by 2 days each at a cost of ₹ (500 + 550) = ₹ 1050/day.

Thus, we shall first crash activities 6 — 7 by 1 day and then activity 4 — 6 by 4 days.

On crashing activity 6 — 7 by 1 day, cost = 4900 + 350 x 1 + 100 x 20 = ₹ 7250, and duration = 20 days. Next we crash 4—6 by 4 days.

Cost = 5250 + 550 x 4 + 100 x 16 = ₹ 9050. Duration = 16 days.

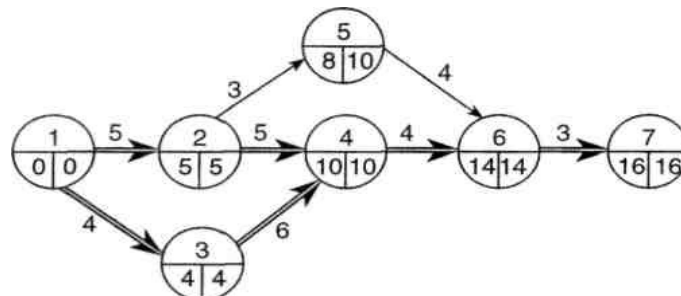



Next we crash activities 1—2 and 3—4 by 1 day each.

$$\text{Cost} = 7450 + 200 \times 1 + 550 \times 1 + 100 \times 15 = ₹ 9700.$$

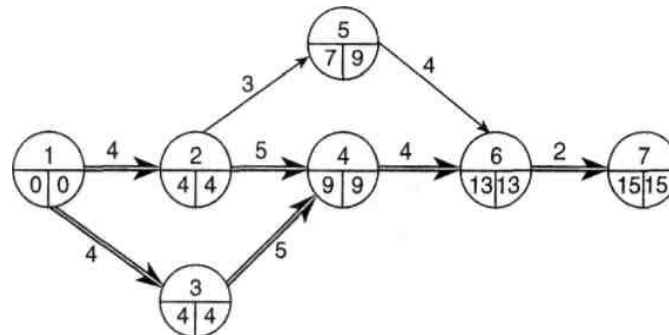

Next we crash activities 2 → 4 and 3 → 4 by 1 day each.

$$\text{Cost} = 8200 + 500 \times 1 + 550 \times 1 + 100 \times 14 = ₹ 10,650. \text{ Duration} = 14 \text{ days.}$$

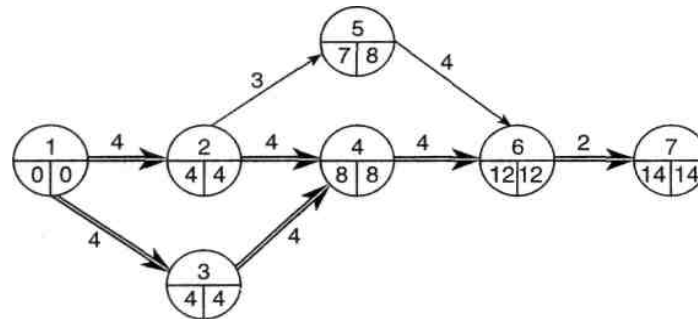

We crash activities 1—3 and 2—4 by 1 day each.

$$\text{Cost} = 9250 + 700 \times 1 + 500 \times 1 + 100 \times 13 = ₹ 11,750 \text{ Duration} = 13 \text{ days.}$$

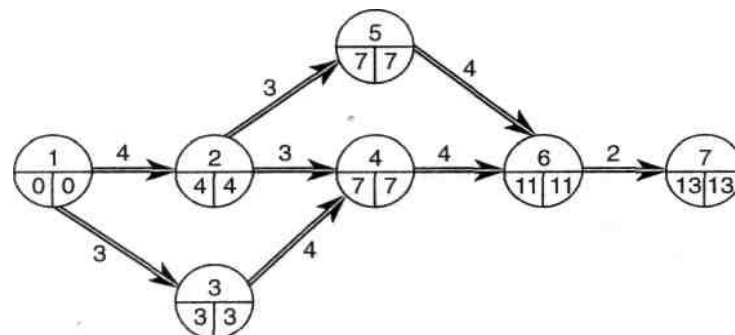

Now there are three critical paths:

1—2—5—6—7, 1—2—4—6—7, 1—3—4—6—7

Also, no further crashing is possible. Hence minimum duration of the project = 13 days with cost ₹ 11,750.



Illustration 38.

Draw a network of the following activities and tabulate earliest and latest starting and finishing times of each activity and the total and free floats of them:

Event numbers	Activity symbol	Activity description	No. of days
1—2	A	Study of plan layout	2
2—3	B	Clearance of site	4
3—4	C	Earth work	10
2—4	D	Procurement of line, sand, cement and concrete	4
4—5	E	Laying of foundations	10
2—5	F	Procurement of bricks	5
5—8	G	Construction of building	36
5—6	H	Laying of conduit pipe lines for electric wires	12
6—8	I	Laying of electric wires	4
5—7	J	Laying of drainage and sewage system	12
7—8	K	Laying of water pipe lines and taps	8
8—9	L	Connecting building to water and electricity	6
9—10	M	Finishing work in building	12

Solution:

The graphical representation of network and time schedule is shown in Fig. below:

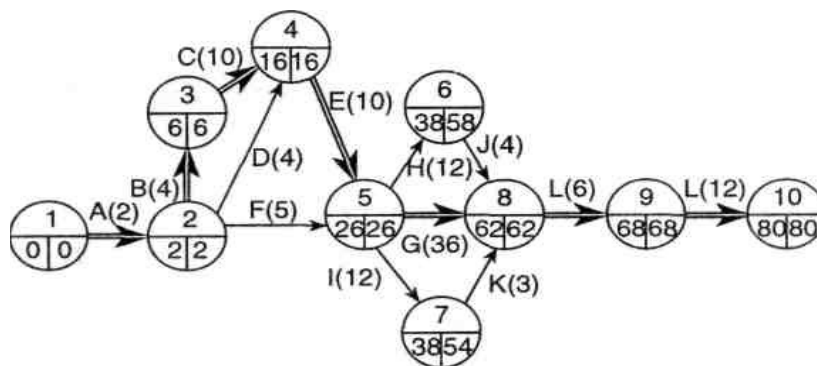

The critical path is : A—B—C—E—G—L—M.



TABLE: COMPUTATION OF SCHEDULING TIME ESTIMATES AND FLOATS

Activity	Sequence code	Duration	Earliest time		Latest time		Float	
			Start	Finish	Start	Finish	Start	Finish
A	1-2	2	0	2	0	2	0	0
B	2-3	4	2	6	2	6	0	0
C	3-4	10	6	16	6	16	0	0
D	2-4	4	2	6	12	16	10	10
E	4-5	10	16	26	16	26	0	0
F	2-5	5	2	7	21	26	19	19
G	5-8	36	26	62	26	62	0	0
H	5-6	12	26	38	46	58	20	20
I	6-8	4	38	42	58	62	20	20
J	5-7	12	26	38	42	54	16	16
K	7-8	8	38	46	54	62	8	8
L	8-9	6	62	68	62	68	0	0
M	9-10	12	68	82	68	80	0	0

Illustration 39.

The activities involved in a PERT project are detailed in the following table:

Job (i- j)	DURATION TIME (DAYS)		
	most optimistic time	most likely time	most pessimistic time
1-2	3	6	15
2-3	6	12	30
3-5	5	11	17
7-8	4	19	28
5-8	1	4	7
6-7	3	9	27
4-5	3	6	15
1-6	2	5	14
2-4	2	5	8

Draw a network diagram.

Solution:

Calculate feasible time = $\frac{\text{Optimistic Time} \times 4 \text{ Likely Time} + \text{Pessimistic Time}}{6}$

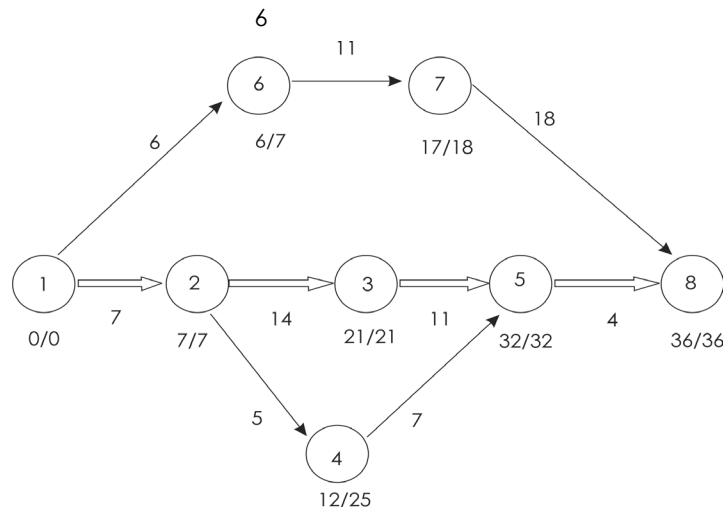



FINAL EXAMINATION

June 2019

**P-15 (SCMD)
Syllabus 2016**

Strategic Cost Management - Decision Making

Time Allowed: 3 Hours

Full Marks: 100

The figures in the margin on the right side indicate full marks.

Section - A

1. Choose the most appropriate answer to the following questions giving justification: 2x10=20

- (i) XYZ Ltd. has the following alternative planned activity levels.

Level	E	F	G
Total cost	₹ 1,00,000	₹ 1,50,000	₹ 2,00,000
No. of units produced	5000	10000	15000

If fixed overhead remains constant, then fixed overhead cost per unit at Level E is

- (A) ₹ 20
 (B) ₹ 15
 (C) ₹ 13.33
 (D) ₹ 10
- (ii) T Ltd. produces and sells a product. The company expects the following revenues and costs in 2018:

Revenues (400 sets sold @ ₹ 600 per product)	₹ 2,40,000
Variable costs	₹ 1,60,000
Fixed costs	₹ 50,000

What amount of sales must T Ltd. have to earn a target net income of ₹ 63,000 if they have a tax rate of 30%?

- (A) ₹ 4,20,000
 (B) ₹ 4,29,000
 (C) ₹ 3,00,000
 (D) ₹ 4,89,000
- (iii) Excel Products Ltd. manufactures four products e.g. Product E, Product F, Product G and Product H using same raw materials. The input requirements for Products E, F, G and H are 1kg, 2kgs, 5kgs and 7kgs, respectively. Product-wise Selling Price and Variable Cost data are given hereunder:

Products	E	F	G	H
Selling Price (₹)	100	150	200	300
Variable Cost (₹)	50	70	100	125



Assuming raw material availability is a limiting factor, the correct ranking of the products would be:

- (A) E, F, G & H
- (B) E, F, H & G
- (C) F, E, G & H
- (D) F, E, H & G

(iv) S Ltd. recently sold an order of 50 units having the following costs:

	₹
Direct materials	1,500
Direct labour (1000 hours @ ₹ 8.50)	8,500
Variable overhead (1000 hours @ ₹ 4.00) ¹	4,000
Fixed overhead ²	1,400
	<u>15,400</u>

¹ Allocated on the basis of direct labour-hours.

² Allocated at the rate of 10% of variable cost.

The company has now been requested to prepare a bid for 150 units of the same product.

If an 80% learning curve is applicable, Stone Isle's total cost on this order would be

- (A) ₹ 38,500
- (B) ₹ 37,950
- (C) ₹ 26,400
- (D) ₹ 31,790

(v) A company manufactures and sells packaging machines. It recently introduced activity-based costing to refine its existing system. Each packaging machine requires direct materials costs of ₹ 50,000; 50 equipment parts; 12 machine hours; 15 assembly line hours and 4 inspection hours. The details about the cost pools, allocation bases and allocation rates are given below:

<i>Indirect cost pool</i>	<i>Cost allocation base</i>	<i>Budgeted allocation rate</i>
Material handling	No. of component parts	₹ 8 per part
Machining	Machine hours	₹ 68 per machine hour
Assembly	Assembly line hours	₹ 75 per assembly hour
Inspection	Inspection hours	₹ 104 per inspection hour

The company has received an order for 40 can-packaging machines from a customer. Using activity-based costing, indirect costs allocated to the order of the customer would be:

- (A) ₹ 1,30,850
- (B) ₹ 1,25,280
- (C) ₹ 1,15,050
- (D) ₹ 1,10,280

(vi) AB Ltd. uses standard cost system. The following information pertains to direct labour for Product X for the month of March, 2019:

Standard rate per hour	₹ 8
Actual rate per hour	₹ 8.40
Standard hours allowed for actual production	2000 hours
Labour Efficiency variance	₹ 1,600 (Adverse)



- What were the actual hours worked?
- (A) 1,800
 - (B) 1,810
 - (C) 2,200
 - (D) 2,190
- (vii) X Ltd. has 1000 units of an obsolete item which are carried in inventory at the original price of ₹ 50,000. If these items are reworked for ₹ 20,000, they can be sold for ₹ 36,000. Alternatively, they can be sold as a scrap for ₹ 6,000 in the market. In a decision model used to analyse the reworking proposal, the opportunity cost should be taken as
- (A) ₹ 16,000
 - (B) ₹ 6,000
 - (C) ₹ 30,000
 - (D) ₹ 20,000
- (viii) Uniform Costing may *not* be successfully applied in the following case:
- (A) In a single enterprise having a number of branches, each of which manufactures the same set of products with the same facilities.
 - (B) In a number of entities in the same industry bound by a trade association.
 - (C) In a number of units across different geographical locations manufacturing one or more of a given set of products.
 - (D) In different branches of the same company, each branch making a different product using a unique process.
- (ix) Which of the following is a valid constraint for a linear programming problem?
- (A) $3x^2 + 4x + 1 = 0$
 - (B) $5x_1 + 2x_2 \leq 10$
 - (C) $4x_1 + 3x_2 > 7$
 - (D) $(12x_1 + 4x_2)/3x_2 \leq 8x_1$
- (x) The shadow price of skilled labour for SD Ltd. is currently ₹10 per hour. What does this mean?
- (A) The cost of obtaining additional skilled labour is ₹10 per hour.
 - (B) There is a hidden cost of ₹10 for each hour of skilled labour actively worked.
 - (C) Contribution will be increased by ₹10 per hour for each extra hour of skilled labour that can be obtained.
 - (D) The total costs will be reduced by ₹10 for each additional hour of skilled labour that can be obtained.

Section-B

Answer any five questions.

16x5=80

Each Question carries 16 marks.

2. (a) A toy manufacturing company produces different models of toy. The budget in respect of a model for the month of March, 2019 is as under:



		(₹ lakhs)	
Budgeted output	40000 units		
Variable costs:			
	Materials	528	
	Labour	104	
	Direct expenses	248	880
Fixed costs:			
	Specific fixed costs	180	
	Allocated fixed costs	225	405
Total costs			1285
Add: Profit			115
Sales			1400

Required:

- (i) Calculate profit with 10% increase in selling price with a 10% reduction in sales volume.
- (ii) Determine volume to be achieved to maintain the original profit after a 10% rise in material costs, at the originally budgeted selling price per unit.

(b) SRM Ltd. manufactures and sells a single product X whose selling price is ₹ 80 per unit and the variable cost is ₹ 32 per unit.

- (i) Assume that for first year fixed costs are ₹ 9,60,000 and the annual sales are at 60% margin of safety.
- (ii) For second year, it is proposed to add another product line Y whose selling price would be ₹ 100 per unit and the variable cost ₹ 20 per unit. The total fixed costs are estimated at ₹ 13,33,200. The sales mix of X : Y would be 7 : 3 based on value.

Required:

- (I) For the first year, calculate the rate of net return on sales, assuming an income tax level of 30%.
- (II) For second year, at what level of sales would SRM Ltd. break even? Give separately for both X and Y the break even sales in rupees and quantities. (4+2)+(5+5)=16

3. (a) Vikas Associates a firm of Chartered Accountants offers three different types of services, namely, accounting and auditing, taxation and management consultancy. Each service is charged on the basis of number of billable hours. The average charge per billable hours is ₹ 500. For the year ending 31.03.2019 the firm projects the following estimate of direct and indirect costs:

		₹ (Lakhs)	
Direct Costs:	Accounting and Auditing	100.00	
	Taxation	100.00	
	Management consultancy	50.00	250.00
Indirect Costs:	Planning and review	7.50	
	Computer processing	7.20	
	Professional salaries	5.60	



Books, Seminars, periodicals	1.80	
Programming costs	8.00	
Building costs	4.90	
General administration costs	15.00	50.00
TOTAL		<u>300.00</u>

Until 31.03.2018 the firm has been allocating the indirect costs on the basis of billable hours. For the year ending 31.03.2019 it was decided to introduce a system of activity based costing to capture the indirect cost more accurately. The following data were gathered accordingly:

Particulars	Accounting and Auditing	Taxation	Management Consultancy
Billable hours	55000	35000	10000
EDP hours	5000	2500	500
Professionals (No)	30	16	10
Books, Seminars and periodicals (₹)	57,500	62,500	60,000
Programming hours	1250	500	2250
Building (Sq ft) space occupied	8000	4000	2000
Administration (No. of clients)	150	250	100

Required:

- (i) Prepare a comparative profitability statement on the basis of (A) conventional costing and (B) activity-based costing (ABC)
- (ii) Any suggestion for improving the billable charge on the basis of ABC?

- (b) AB Ltd. produces a variety of products, each having a number of component parts. Product X takes 5 hours to produce on machine no. 55 which is working at full capacity. X has a selling price of ₹ 50 and a marginal cost of ₹ 30 per unit. Y-5, a component part, could be made on the same machine in 2 hours for a marginal cost of ₹ 5 per unit. The supplier's price is ₹ 13.50 per unit.

Required:

Should AB Ltd., make or buy Y-5?

$$(4+4)+(3+1)+4=16$$

4. (a) A company produces three products A, B and C, from a joint process. Costs and other details are given below:

Costs:	Joint Costs	Post-separation Costs		
	(₹)	A	B	C
		(₹)	(₹)	(₹)
Materials	20,000	1,500	3,500	2,000
Labour	8,000	1,000	1,000	1,500
Overhead	4,000	500	1,000	500
	<u>32,000</u>	<u>3,000</u>	<u>5,500</u>	<u>4,000</u>



Others:

Sales value (₹)	10,000	25,000	15,000
S & D Exp. (as % of sales)	20%	20%	20%
Estimated Net Profit (as % of sales)	20%	10%	20%

Required:

Prepare a statement showing the apportionment of joint costs over three products using Net Value Method.

- (b) Fifteen workers (10 Type I workers and 5 Type II workers) work in a production process during a month of 25 working days. Each Type I worker is expected to produce 8 units per day and Type II worker is expected to produce 12 units per day. They work on the regular shift from 9:00 a.m. to 5 p.m. and have a tea break between 10:30 to 10:45 a.m. and 3:00 to 3:15 p.m. and also have a lunch break from 1:00 to 1:30 p.m. The actual production was 1800 units by Type I workers and 1200 units by Type II workers. The standard wage rate per hour were ₹50 and ₹60 for Type I and Type II workers, respectively and corresponding actuals were 60 and 70, respectively. During the month, 16 hours were lost actually for both types of workers, which is also as per expectation for waiting for materials and inspection.

Required:

Calculate the following:

- (i) Standard labour cost for the month
- (ii) Labour cost variance
- (iii) Labour efficiency variance
- (iv) Idle time variance

Indicate (A) or (F) to denote whether the variances are adverse or favourable.

$$8+(3+3+1+1)=16$$

5. (a) X Ltd. manufactures and sells a special component. It follows a Standard Marginal Costing system. For the year ended 31.03.2019, it produced 1500 components against a budgeted capacity of 2000 components. Out of the production 100 components were scrapped. Due to a computer virus most of the financials could not be retrieved.

However, the Chief Cost Accountant gave the following information:

Particulars	(₹)
Selling Price per component	213
Direct materials total cost	84,000
Direct labour cost per component (Actual efficiency 80%)	?
Variable Manufacturing overhead per component	15
Variable Selling overhead per component	8
Fixed Selling and Administration overheads	48,000
Fixed overhead manufacturing absorption rate per component (on the basis of budgeted capacity)	30
Closing stock (200 units) (Valued at prime cost for financial purpose)	18,000

Required:

- (i) Prepare the Profitability statements as per Marginal Costing, Absorption Costing and the actual Profit & Loss Account.
- (ii) Reconcile the actual profit with that of the Break-even profit under Marginal Costing.



- (b) What do you understand by Learning Curve? What are its different phases? State the possible areas of application of Learning Curve. (6+2)+(2+2+4)=16

6. (a) AB Ltd. has two manufacturing divisions, A and B, operating as profit centres. A has a production capacity of 3500 units of product A per month, but presently, it produces 2000 units for a special customer S, @ a selling price of ₹ 400 per unit (which will not accept partial supply) and 1000 units for B. S has an agreement with AB that A shall not supply to the external market at any price lower than that to S, or it can supply to the market at any price after discontinuing supplies to S. Division B does some further work on A, incurs a variable processing cost of ₹ 220 per unit to produce its product B. The monthly fixed costs of Division A are ₹ 2,00,000. The monthly fixed costs of B are ₹ 1,50,000. Division A's raw material cost is ₹ 150 per unit and its variable manufacturing costs are ₹ 100 per unit. Variable selling overhead of ₹ 50 per unit of A and ₹ 70 per unit of B are incurred for sales other than transfers. A had been selling to the outside market at a price of ₹460 per unit. Due to competition, it has to reduce its price to ₹ 380 per unit on the entire supplies if it has to sell any quantity above 2000 units. At ₹ 380/unit, its entire output can be sold. B has an outside market price of ₹ 800 per unit and can sell up to 2500 units. If A does not supply to B, a close substitute is available in the market for purchase by B at ₹ 380, on which some additional work costing ₹ 40 per unit has to be done to make it comparable to A. Assume that B will accept partial supply from A and that both divisions have complete autonomy in deciding their strategy and they have the knowledge of costs/revenues/supply conditions in each other's divisions.

Required:

Using figures relevant for the following questions and calculations for the monthly period:

- (i) Find out the optimal strategy for A - how much to produce each month, how much to supply to external market and how much to supply to B and at what minimum cost to maximize its Divisional profits.
- (ii) What would be the range of transfer price per unit and the quantity that Manager of A will try to successfully negotiate with the Manager of B?
- (iii) What would be the range of transfer price that the Manager of B would consider to negotiate with A?
- (iv) As the top management person, what would you quote as the appropriate transfer price to be fair to A and B in their performance evaluation?

- (b) Briefly state the significance of Margin of Safety in management decisions. (4+4+2+2)+4=16

7. (a) In the manufacturing plant of Delite Industries Ltd., four jobs can be processed on four different machines, one job on one machine. Resulting profits vary with assignments. They are given below:

		Machines			
		I	II	III	IV
Jobs	I	42	35	28	21
	II	30	25	20	15
	III	30	25	20	15
	IV	24	20	16	12

Required:

Find the optimum assignment of jobs to machines and the corresponding profit.



(b) The following information are given:

Arrival of patients		Services	
Inter-arrival time (minutes)	Probability	Inter-Service time (minutes)	Probability
2	0.20	4	0.25
4	0.24	6	0.34
6	0.28	8	0.26
8	0.18	10	Balance
10	Balance		

The following random number are to be used for the simulation of arrival and service patterns:

Arrival	740	225	906	048	421
Service	402	183	706	923	638

Required:

- (i) Find out the average time spent by the patient in the queue by simulation. Assume that the time starts at 6:00 a.m. and that there is only one counter and there is no time gap between finishing with one patient and starting the next patient if the next patient is already in the queue.
- (ii) A second counter is to be set up if the probability of waiting beyond 3 minutes exceeds 40% or if the average waiting time of a patient exceeds 5 minutes if there is a wait. Should the second counter be set up? Substantiate based on the simulation results. $8 + (6 + 2) = 16$

8. Write short notes on any four of the following:

4×4=16

- (a) Principal Budget Factor
 - (b) Lean Accounting
 - (c) Differential Costs
 - (d) Product Life Cycle Costing
 - (e) Activity Ratio
-

**FINAL EXAMINATION**

December 2018

**P-15 (SCMD)
Syllabus 2016****Strategic Cost Management - Decision Making**

Time Allowed: 3 Hours

Full Marks: 100

*The figures in the margin on the right side indicate full marks.**Answer Question No. 1 in Section A, which is compulsory, carrying 20 marks.
Further, answer any 5(five) Questions from Section B, each carrying 16 marks.***Section - A****(20 marks)**

1. Choose the most appropriate answer to the following questions giving justification : 2x10=20
- (i) A company has a break even point when sales are ₹ 3,20,000 and variable cost at that level of sales are ₹ 2,00,000. How much would contribution margin increase or decrease if variable expenses are dropped by ₹ 30,000 ?.
- (A) Increase by 27.5%
(B) Increase by 9.375%
(C) Decrease by 9.375%
(D) Increase by 37.5%
- (ii) Twin Ltd. uses JIT and back flush accounting. It does not use a raw material stock control account. During September 2018, 10000 units were produced and sold. The standard cost per unit is ₹ 150 which includes materials of ₹ 60. During September 2018, ₹ 9,90,000 of conversion costs were incurred. The debit balance in cost of goods sold account for September 2018 was
- (A) ₹14,00,000
(B) ₹14,80,000
(C) ₹15,90,000
(D) ₹16,20,000
- (iii) A company operates a standard absorption costing system. The budgeted fixed production overheads for the company for last year were ₹ 3,30,000 and budgeted output was 220,000 units. At the end of the company's financial year, the total of the fixed production overheads debited to the Fixed Production Overhead Control Account was ₹ 2,60,000 and the actual output achieved was 2,00,000 units. The under/over absorption of overhead was
- (A) ₹ 40,000 over absorbed
(B) ₹ 40,000 under absorbed
(C) ₹ 50,000 over absorbed
(D) ₹ 50,000 under absorbed



- (iv) A company has the capacity of producing 80000 units and presently sells 20000 units at ₹ 100 each. The demand is sensitive to selling price and it has been observed that with every reduction of ₹ 10 in selling price the demand is doubled. What should be the target cost in selling price if the demand is doubled at full capacity and profit margin on sale is taken at 25%?
- (A) ₹75
(B) ₹90
(C) ₹25
(D) ₹60
- (v) A factory can make only one of the three products X, Y or Z in a given production period. The following information are given :

Per unit ₹	X	Y	Z
Selling Price	1500	1800	2000
Variable Cost	700	950	1000

- Assume that there is no constraint on resource utilization or demand and similar resources are consumed by X,Y and Z. The opportunity cost of making one unit of Z is
- (A) ₹ 850
(B) ₹ 800
(C) ₹ 1800
(D) ₹ 1500
- (vi) AB company is a supermarket group that incurs the following costs :
- (A) The bought-in price of the goods
(B) Inventory finance costs
(C) Self refilling costs
(D) Costs of repacking or 'pack out' prior to storage before sale
- AB company's calculation of direct product profit (DPP) would include
- (A) Costs (a) and (c) only.
(B) All of the above cost except (b)
(C) All of the above costs except (d)
(D) All of the above costs.
- (vii) S Ltd. manufactures a product whose time for the first unit is 1000 hours. It experience a learning curve of 80%, What will be the total time taken in hours for unit 5 to 8 ?
- (A) 4096 hours
(B) 3200 hours
(C) 1536 hours
(D) 2000 hours

- (viii) H Group has two divisions, Division P and Division Q. Division P manufactures an item that is transferred to Division Q. The item has no external market and 6000 units produced are transferred internally each year. The costs of each division are as follows ?

	Division P	Division Q
Variable Cost	₹ 100 per unit	₹ 120 per unit
Fixed cost each year	₹ 1,20,000	₹ 90,000



Head Office management decides that a transfer price should be set that provides a profit of ₹ 30,000 to Division P. What should be the transfer price per unit ?

- (A) ₹ 145
- (B) ₹ 125
- (C) ₹ 120
- (D) ₹ 135

(ix) In the context of Critical Path Analysis, the portion of the float of an activity which cannot be consumed without affecting adversely the float of the subsequent activities is called

- (A) Free float
- (B) Interfering float
- (C) Independent float
- (D) Total float

(x) In CPA (Critical Path Analysis) which of the following is not a correct step in sequence?

- (A) Understanding the logic of the system under consideration
- (B) Constructing the net work
- (C) Providing estimates for activity duration.
- (D) Implementing and controlling the net work.

SECTION – B

Answer any five question.

Each Question carries 16 Marks.

16 x 5 = 80

2. (a) You are given the following data for a period in respect of two products, X and Y, which consume support services in different proportions :

	Product X	Product Y
Unit produced	40	40
Material moves per product unit	12	28
Direct labour hrs. per unit	1740	1740

Budgeted material handling costs : ₹ 3,48,000

Required :

- (i) Determine cost per unit of X and Y using the volume-based allocation method (direct labour hrs.)
- (ii) Compute cost per unit of X and Y using ABC.
- (iii) How would you explain the results ?

1+3+4=8

2. (b) The profit for The Forward Look Ltd. works out to 12.5% of the capital employed and the relevant figures are as under :

	₹
Sales	5,00,000
Direct Materials	2,50,000
Direct Labour	1,00,000
Variable Overheads	40,000
Capital employed	4,00,000



The new Sales Manager who has recently joined the Company estimates for the next year a profit of about 23% on the capital employed provided the volume of Sales is increased by 10% and simultaneously there is an increase in Selling Price of 4% and an overall cost reduction in all the elements of cost by 2%.

Verify the contention of the Sales Manager by computing in detail the cost and profit for the next year and state whether his proposal can be adopted by the management. 8

3. (a) XYZ Ltd. produces three products. The cost data are as under :

Particulars	X	Y	Z		
Direct Materials	₹64	₹152	₹117		
Direct Labour :					
	Dept.	Rate per hour (₹)	Hrs.	Hrs.	Hrs.
	1	5	18	10	20
	2	6	5	4	6.5
	3	4	10	5	20
Variable overheads			₹16	₹9	₹24

Fixed overheads ₹ 4,00,000 per annum

The budget was prepared at a time, when market was sluggish. The budgeted quantities and selling prices are as under :

Product	Budged Quantity	Selling price (₹) unit
X	9750	270
Y	7800	280
Z	7800	400

Later the market improved and the sales quantities could be increased by 20% for product X and 25% each for products Y and Z. The Sales Manager confirmed that the increased quantities could be achieved at the prices originally budgeted. The Production Manager has stated that the output cannot be increased beyond the budgeted level due to limitation of direct labour hours in Department 2.

Required :

(i) Set optimal product mix.

(ii) State profit under optimal product mix.

6+6 = 12

- (b) A company is producing and selling three products. How would you determine relative profitability of products in each of the following independent situation ?

(i) Total sales potential in unit is limited,

(ii) Total sales potential in value is limited,

(iii) Raw materials are in short supply,

(iv) Production capacity (machine hours) is limited.

1+1+1+1 = 4



4. (a) A company is organized into two divisions, namely X and Y, and produces three products A, B and C. Data per unit are :

	A	B	C
Market price (₹)	240	230	200
Variable costs (₹)	168	120	140
Direct Labour (hours)	4	5	3
Maximum sales potential (units)	1600	1000	600

Division Y has a demand for 600 units of product B for its use. If Division X cannot supply the requirement, Division Y can buy a similar product from market at ₹ 224 per unit.

Required :

What should be the transfer price of 600 units of B for Division Y, if the total direct labour-hours available in Division X are restricted to 15000 ?

8

- (b) Prism Ltd. has decided to adopt JIT policy for materials. The following effects of JIT policy are identified :
- To implement JIT, the company has to modify its production and material receipt facilities at a capital cost of ₹ 2,00,000. The new machine will require a cash operating cost ₹ 2,16,000 p.a. The capital cost will be depreciated over 10 years.
 - Raw material stockholding will be reduced from ₹ 40,00,000 to ₹ 15,00,000.
 - The company can earn 12% on its long-term investments.
 - The company can avoid rental expenditure on storage facilities amounting to ₹ 66,000 per annum. Property Taxes and Insurance amounting to ₹ 44,000 will be saved due to JIT programme.
 - Presently there are 7 workers in the Store department at a salary of ₹ 10,000 each per month. After implementing JIT scheme, only 4 workers will be required in this department. Balance 3 workers' employment will be terminated.
 - Due to receipt of smaller lots of Raw Materials, there will be some disruption of production. The costs of stockouts are estimated at ₹ 1,54,000 per annum.
 - Since the supplier is new having no reputation as yet in the market, an additional inspection cost of ₹12,000 p.a. has to be incurred.

Required :

Determine the financial impact of the JIT policy. Is it advisable for the company to implement JIT system?

6+2= 8

5. (a) One kilogram of product 'K' requires two chemicals A and B. The following were the details of product 'K' for the month of June 2018 :
- Standard mix ratio is 1:1
 - Standard price per kilogram of chemical 'A' ₹ 12 and chemical 'B' ₹ 15
 - Actual input of chemical 'B' 70 kilograms
 - Actual price per kilogram of Chemical 'A' ₹ 15
 - Standard normal loss 10% of total input
 - Materials cost variance total ₹ 650 adverse and the same was fully attributable to Chemical 'B'
 - Materials yield variance total ₹ 135 adverse

Required :

Compute all missing variance and complete the Variance Report.

6+4=10



(b) For a machine the financial data are given below :

Time (Year)	0	1	2	3	4
Outlay (₹)	5000				
Operating Costs (₹)		1400	1500	1600	1700
Maintenance (₹)			300	400	500
Value if scrapped (₹)		3400	2000	800	600

The appropriate interest rate is 12% p.a. and the discount factor is as follows :

Year	0	1	2	3	4
12% Disc. Factor	1	0.893	0.797	0.712	0.636

Required :

Determine the optimal length of replacement cycle.

4+2=6

6. (a) The following is the information regarding turnover and quality cost of a company:

- (i) Sales revenue ₹ 10,000,000 ; net income ₹ 10,00,000
- (ii) During the year, customers returned 30000 units needing repair. Repair cost averages ₹ 7 per unit.
- (iii) Six inspectors are employed, each earning an annual salary of ₹ 25,000. These six inspectors are involved only with final section (Production acceptance).
- (iv) Total scrap is 30000 units. All scrap is quality related. The cost of scrap is about ₹ 15 per unit.
- (v) Each year, approximately 150000 units are rejected in final inspection. Of these units, 80 per cent can be recovered through rework. The cost of rework is ₹ 3.00 per unit.
- (vi) A customer cancelled an order that would have increased the profits by ₹ 2,50,000. The customer's reason for cancellation was poor product performance. The accounting and marketing departments agree that the company loses at least this much during the year for the same reason.
- (vii) The company employs five full time employees in its complaint department. Each earns ₹ 20,000 a year.
- (viii) The company gave sales allowances totaling ₹ 1,30,000 due to substandard products being sent to the customer.
- (ix) The company requires all new employees to take in three hour Quality-Training programme. The estimated cost for the programme is ₹ 80,000.
- (x) Inspection of the final product requires testing equipment. The annual cost operating and manufacturing this equipment is ₹ 1,20,000.

Required :

Prepare a simple quality cost report classifying costs by rational category.

8

(b) The following was the pattern for demand of cars rented out by a tourist operator observed for 100 days :

No. of cars	5	7	10	15
No. of days	20	30	40	10

The random numbers are 88, 76, 10, 05, 23

Required :

- (i) Simulate the demand for cars over five days.
- (ii) How many cars should the operator have in order to have at least 75% probability of fulfilling the demand based on your simulated results ?

5+3=8



7. (a) Given the following information regarding a project and the time duration of each activity :

Activity	Preceding activity	Normal Time (days)
A	---	16
B	---	20
C	A	8
D	A	10
E	B,C	6
F	D,E	12

Required :

- (i) Draw the activity network of the project.
- (ii) Find critical path and duration of the project.
- (iii) Find the total float and free-float for each activity.

2+2+4 = 8

(b) Coffee powder made by a shop by blending different flavours of coffee seeds. 520 gms of Plantation A seeds and 510 gms of Plantation B seeds are ground to yield 1000 gms of Special Blend power. 520 gms of Peaberry seeds and 560 gms of Plantation A seeds are ground to yield 1050 gms of Special Peaberry powder. 500 gms of Plantation B seeds and 510 gms of Robusta seeds are ground to get 980 gms of Normal Blend powder. The contribution per kg of Special Blend, Special Peaberry and Normal Blend are ₹100, 120 and 140 respectively. The following stock are available for the production period:

Plantation A : 200 kgs ; Plantation B : 300 kgs ; Peaberry : 250 kgs ; Robusta : 51 kgs.

Grinding capacity on a total is limited to 500 kgs of output in a production period.

Required :

Formulate the above as a linear programme with the objective to maximize contribution. Identify the variables and give the constraints. (Consider 1000 gms = 1 kg). 8

8. Write short notes on any four of the following :

4×4=16

- (a) Business Process Re-engineering
- (b) Assignment
- (c) Features of Target Costing
- (d) Differences between Standard Costing and Kaizen Costing
- (e) Methods of Solving Transportation Problem.



FINAL EXAMINATION

June 2018

**P-15 (SCMD)
Syllabus 2016**

Strategic Cost Management - Decision Making

Time Allowed: 3 Hours

Full Marks: 100

The figures in the margin on the right side indicate full marks.

Section - A

(20 marks)

1. Choose the most appropriate answer to the following questions giving justification: 2x10=20
- (i) A Company requires ₹ 85,00,000 in sales to meet its target net profit. Its contribution margin is 30% and the fixed costs are ₹ 15,00,000. What is the target net profit?
- (a) ₹ 10,50,000
(b) ₹ 19,50,000
(c) ₹ 25,50,000
(d) ₹ 35,00,000
- (ii) In a factory where standard costing system is followed, the production department consumed 1100 kgs of a material @ ₹ 8 per kg for product X resulting in material price variance of ₹ 2200 (Fav) and material usage variance of ₹ 1000 (Adv). What is the standard material cost of actual production of product X?
- (a) 11,000
(b) 20,000
(c) 14,000
(d) 10,000
- (iii) The following information relate to ABC company for two activity levels:
- | | | |
|--------------------|--------|--------|
| Activity level | 60% | 80% |
| Variable costs (₹) | 12,000 | 16,000 |
| Fixed costs (₹) | 20,000 | 22,000 |
- The differential cost for 20% capacity is
- (a) ₹ 4,000
(b) ₹ 2,000
(c) ₹ 6,000
(d) ₹ 5,000
- (iv) By making and selling 9,000 units of a product, a company makes a profit of ₹ 10,000, whereas in the case of 7,000 units, it would lose ₹ 10,000 instead. The number of units to break-even is
- (a) 7,500 units
(b) 8,000 units
(c) 7,750 units
(d) 8,200 units



- (v) 1200 units of microchips are required to be sold to earn a profit of ₹ 1,06,000 in a monopoly market. The fixed cost for the period is ₹ 74,000. The contribution in the monopoly market is as high as $\frac{3}{4}$ th of its variable cost. Determine the target selling price per unit.
- (a) 450
(b) 325
(c) 400
(d) 350
- (vi) An operation has a 90% learning curve and the first unit produced took 28 minutes. The labour cost is ₹ 20 per hour. How much should the second unit cost?
- (a) ₹ 9.80
(b) ₹ 7.60
(c) ₹ 8.40
(d) ₹ 6.60
- (vii) If project A has a net present value (NPV) of ₹ 30,00,000 and project B has an NPV of ₹ 50,00,000, what is the opportunity cost if project B is selected?
- (a) ₹ 23,00,000
(b) ₹ 30,00,000
(c) ₹ 20,00,000
(d) ₹ 50,00,000
- (viii) A company operates an activity based costing (ABC) system to attribute its overhead costs to cost objects. In its budget for the year-ending 31st August, 2018. The company expected to place a total of 2000 purchase orders at a total cost of ₹ 1,00,000. This activity and its related costs were budgeted to occur at a constant rate throughout the budget year which is divided into 13 four week periods.
- During the four week period ended 30th June 2017, a total of 200 purchase orders were placed at a cost of ₹ 9,000. The over recovery of these costs for the four week period was
- (a) ₹ 2,000
(b) ₹ 3,000
(c) ₹ 1,500
(d) ₹ 1,000
- (ix) Empire Hotel has a capacity of 100 single rooms and 20 double rooms. Average occupancy is 70% for 365 days of the year. The rent for a double room is kept at 130% of a single room. The total room occupancy days in a year in terms of single room is
- (a) 32193
(b) 30660
(c) 31660
(d) 30993
- (x) Which of the following is correct in the context of network analysis?
- (a) There can be one or more activities without a predecessor in a network.
(b) Where two activities have the same start and end events, the end event of one activity is numbered differently and then connected by a dummy to the original start event.
(c) When crashing is carried out, the non-critical paths have to remain non critical.
(d) If the critical path is longer than the other paths, the project may be completed by using a path having a shorter duration.



Section – B

Answer any five questions.

Each Question carries 16 Marks.

16×5=80

2. (a) Relevant data relating to Trident Industries Limited are:

	Products			
	P	Q	R	Total
Production and Sales (Units)	60,000	40,000	16,000	
Raw Material Usage (in Units)	10	10	22	
Raw Material Costs (₹)	50	40	22	24,76,000
Direct Labour Hours	2.5	4	2	3,42,000
Machine Hours	2.5	2	4	2,94,000
Direct Labour Costs (₹)	16	24	12	
No. of Production Runs	6	14	40	60
No. of Deliveries	18	6	40	64
No. of Receipts	60	140	880	1080
No. of Production Orders	30	20	50	100

Overheads:	₹
Set-up	60,000
Machines	15,20,000
Receiving	8,70,000
Packing	5,00,000
Engineering	7,46,000

The Company operates a JIT inventory policy and receives each component once per production run.

Required:

(a) (i) Compute the product cost based on direct labour hour recovery rate of overheads.

(ii) Compute the product cost using Activity Based Costing.

4+8=12

(b) What is Target Cost? How would you determine it?

2+2=4

3. An Engineering Co. manufactures a single product whose standard cost structure is as follows:

	₹
Direct materials: 2.4 kg at ₹ 30 per kg	72.00
Direct Labour : 6 hours at ₹ 4 per hour	24.00
Factory Overheads : 6 hours at ₹ 0.75 per hour	4.50
Total	<u>100.50</u>



The factory overheads are based on the following flexible budget:

Capacity	80%	90%	100%	100%
Production (units)	6,000	6,750	7,500	8,250
Overheads (₹)	29,250	3,150	33,750	36,000

Actual data for the month of January, 2018:

Budgeted production	7,500 units
Materials used	19,240 kg at ₹ 31 per kg
Direct labour	46,830 hours at ₹ 4.20 per hour
Actual factory overheads	₹ 36,340
Production completed	7,620 units

Details of Work-in-Progress:

Opening : 120 units, materials fully supplied, 50% converted.

Closing : 100 units, materials fully supplied, 50% converted.

Required:

- (i) Effective or Equivalent Production for each element of cost.
- (ii) Calculate:
 - (a) Material variances (cost, price and usage)
 - (b) Labour variances (cost, rate of pay and efficiency)
 - (c) Overhead variances (expenditure and volume variance, efficiency and capacity variance)

4+3+6=13

4. (a) A company manufactures two types of herbal product, A and B. Its budget shows profit figures after apportioning the fixed joint cost of ₹ 15 lakh in the proportion of the numbers of units sold. The budget for 2018 indicates:

Particulars	A	B
Profit (₹)	1,50,000	30,000
Selling price per unit (₹)	200	120
P/V Ratio (%)	40	50

Required to advise on the best option among the following, if the company expects that the number of units to be sold would be equal.

- (i) Due to change in manufacturing process, the joint fixed cost would be reduced by 15% and the variable cost would be increased by 7%.
- (ii) Price of A could be increased by 20% as it is expected that the price elasticity of demand would be unity over the range of price.
- (iii) Simultaneous introduction of both the options, viz. (i) and (ii) above.

4+4+4=12

- (b) What are the advantages of Inter-firm comparison?

4



5. A regional audit firm offers audit, tax and consulting services. The segmented profit and loss position for the next year shows the following position:

	Audit ₹	Tax ₹	Consulting ₹
1. Revenues	60,000	1,00,000	1,20,000
2. Costs:			
Service-level	50,000	60,000	70,000
Facility-level (apportioned)	10,000	12,000	16,000
Total	60,000	72,000	86,000
3. Operating Profit (1-2)	Nil	28,000	34,000

Partners are concerned about the profitability of their audit business and contemplate to close it down. In the event of closure of audit service, it might do more tax work. If audit service is discontinued, 50 per cent of the facility costs associated with auditing would be saved. More tax work would increase tax revenues by 45 per cent, but tax service-level costs would also increase by 45 per cent.

Required:

- (a) Determine whether the firm should drop auditing service and the impact on its closure on profit. Assume that audit centre facility level costs can be allocated to two other centres based on revenues. Compare Profitability of Tax and Consulting Services before and after closure of Audit Centre.
- (b) What other considerations are important to drop auditing service? 12+4=16
6. (a) Explain the concept of 'quality' and enumerate 'costs of quality' under different groups. 3+5=8
- (b) What is Learning Curve? What factors affect Learning Curve? 4+4=8
7. (a) A small project is composed of 8 activities whose estimated time are listed below:

Activity	1-2	2-3	2-4	3-5	4-6	5-6	5-7	6-7
Optimistic time (in weeks)	3	3	2	4	4	0	3	2
Most likely time (in weeks)	3	6	4	6	6	0	4	5
Pessimistic time (in weeks)	3	9	6	8	8	0	5	8

Required:

- (i) Draw the project network.
- (ii) Find the expected duration and variance for each activity.
- (iii) Find the critical path and expected project length.
- (iv) The probability that the project will be completed in 23 weeks.

Given that:

Z Value:	1.00	1.91	1.92	1.93	1.94
Probability:	0.9713	0.9719	0.9726	0.9732	0.9738

3+3+2+2=10



- (b) The management of SAB Ltd. has suggested that a linear programming model might be used for selecting the best mix of five possible products — A, B, C, D and E. The following information are available:

	Per Unit of Product				
	A	B	C	D	E
Selling Price (₹):	96	84	76	62	54
Costs (₹):					
Material	30	28	32	30	32
Direct Labour	36	32	12	8	8
Fixed Overhead	18	16	6	4	4
Total Costs	84	76	50	42	44

Expected maximum unit demand per week for each product at the prices indicated:

	A	B	C	D	E
	3000	2400	1800	1200	1200

Cost of material includes a special component which is in short supply. It costs ₹ 6 per unit. Only 11,600 units are available to the company during the week. The number of units of the special component needed for a unit of each product is:

	A	B	C	D	E
	2	1	4	3	6

The management of SAB Ltd. has ruled that expenditure on materials must not exceed a sum of ₹ 60,000. All other resources are freely available in sufficient quantities for planned need.

Formulate a linear programming model stating clearly the criterion you use.

6

8. Write short notes on *any four* of the following:

4x4= 16

- Backflush Accounting
- Relevant Cost Analysis
- Treatment of Variances in cost accounts
- Value Engineering
- Life Cycle Costing

The Directorate of Studies is committed to keep abreast of CMA Students with the latest amendments/notifications/advancements on each subject on regular basis. Students are requested to visit CMA Students' Portal [<https://icmai.in/studentswebsite/>] regularly to view the updates.

