

# Statim 2000 & 5000



## Field Technical Training Manual

## Table of Contents

Statim 2000 & 5000 Specifications	3
2000 Keypad	4
5000 Keypad, Installation & Language Selection	5
Display	6
Statim 2000 Unwrapped Cycle Description	7
Statim 2000 Wrapped Cycle Description	8
Statim 5000 Unwrapped Cycle Description	9
Statim 5000 Wrapped Cycle Description	10
Cassette Operation, Care & Maintenance, Seal Replacement	11
Statim 2000 & 5000 Cover Removal	12
Steam Flow Chart	13
Sequence of Operation	14
No Power PCB Revision 2.4-2.92 & 6.4	15
Pump, Solenoid & Compressor Testing	16
Pump Filter Cleaning Instructions	17
Thermal Fuse Location	18
Probe Bracket	19
Microswitch Location	20
Solenoid Valve	21
Boiler Calibration 2000 & 5000 Rev. 2.4-2.9	22
Boiler Calibration 2000 & 5000 Rev. 6.x & Adapter Boards with 44-pin Microprocessor	23
Water Testers	24
Water Quality Problems	25
Water Quality Check Revision 4XX or 5XX Software	26
Control Box Connections	27
Water Pump Filters Tech Service Bulletin	28
QA Supply Water Tester	29

## Statim 2000 & 5000 Specifications



The Statim 2000 & 5000 are tabletop steam sterilizers, which are designed to sterilize instruments and handpieces between patients.

<b>Statim 2000</b>	<b>Statim 5000</b>
External Size (LgthxWdthxHgth)	External Size (LgthxWdthxHgth)
17 3/4" x 16 1/4" x 6"	21 3/4" x 16 1/4" x 7 1/2"
Cassette Internal Dimensions	Cassette Internal Dimensions
11" x 7" x 1 1/2"	15" x 7" x 3"
Reservoir Capacity	Reservoir Capacity
4 Liters	4 Liters
Approximately 40 Cycles	Approximately 15-18 Cycles
Weight Without Water	Weight Without Water
46 Pounds	72 Pounds
Power Consumption	Power Consumption
1300 Watts	1300 Watts
Printer	Printer
Not Available	Type: Thermal Paper
	Print: 20 Characters Per Line
	Speed: 1 Line Per Second
	Capacity: 80 Cycles Per Roll
Cycle Time	Cycle Time
Unwrapped: 6 Minutes*	Unwrapped: 9 Minutes*
Wrapped: 12-15 Minutes*	Wrapped: 15-18 Minutes*
Rubber & Plastics: 20 Minutes*	Rubber & Plastics: 40 Minutes*
	Heavy Duty Unwrapped: 12 Minutes*
Warranty	Warranty
1 Year Parts (Excluding Seal)	1 Year Parts (Excluding Seal)
1 Year SciCan Labor	1 Year SciCan Labor

\*Cycle times will vary depending on load size in cassette.

## 2000 Keypad



	Cycle	Sterilization Time & Temperature
1	Unwrapped Instruments	3.5 Minutes 135°C
2	Wrapped Instruments	10 Minutes 135°C
3	Rubber & Plastics	15 Minutes 121°C
4	Air Dry Only	60 Minutes
5	Start	
6	Stop	

## 5000 Keypad, Installation & Language Selection



	Cycle	Sterilization Time & Temperature
1	Unwrapped Instruments	3.5 Minutes 132°C
2	Wrapped Instruments	6 Minutes 132°C
3	Rubber & Plastics	20 Minutes 121°C
4	Heavy Duty Unwrapped	6 Minutes 132°C
5	Start	
6	Stop	

### Installation

Adjust the bubble level, located in the right front corner of the Statim, so the bubble is in the 4 or 5 o'clock position.

The waste bottle should be placed below the Statim.

Install the exhaust tubing as short as possible with no complete loops and no dips below the waste bottle.

Make sure the mesh rack in the cassette, is positioned so there is a gap underneath for airflow.

Cassettes need to be treated with Stat-Dri Plus when water begins to cling to the cassette lid.

Do not stack bags in the cassette.

All the above will help to enhance drying in the Statim cassette.

### Selecting a Language

Turn the Statim OFF.

Hold down the wrapped instrument button and turn the Statim ON. Release the wrapped button when the display appears.

Press and release the wrapped button or the unwrapped button to scroll through the languages. You are looking for N A English (North American English).

When N A English appears on the display press the stop button.

## Display



**Statim 2000 S201R501**

**Select A Cycle**

When the Statim is turned ON the display will show Statim and model 2000 or 5000 then the software number. The last three digits of the software number (501) are the software revision. The revision number is required to answer numerous questions concerning the Statim. The display will change to Select A Cycle after approximately 5 seconds. To see the software revision number again the Statim will need to be turned OFF and then back ON. This display is for a Statim 2000, with revision **501** software.

Units manufactured from 1990 thru 1994 may say Select A Program with no software number when turned ON.

When using the Troubleshooting Guide there are three sets of error codes.

Statims that say "Select A Program" when turned ON, use original Statim error codes on page 17 in the troubleshooting guide.

Statims with software revision 2XX when turned ON, use 2XX error codes page 3 in the troubleshooting guide.

Statims with software revision 5XX when turned ON, use 5XX error codes page 10 in the troubleshooting guide.

For units with revision 4XX software most troubleshooting will be done using 2XX codes.

## Statim 2000 Unwrapped Cycle

Temperature rises to approx 102°C. Solenoid closes (new units 30 second delay after reaching 102°C before Solenoid closes). Unit then pressurizes to 135°C. Unit goes into sterilization for 3.5 minutes. Unit then depressurizes to 103°C, air-drying starts (on units with 4XX and 5XX software the air compressor will turn ON while unit is still venting). This feature is to prevent deposits from collecting in the boiler. The compressor turning ON during venting will remove moisture from the boiler. The operator is unable to remove the cassette from the Statim until the Stop button is pressed.

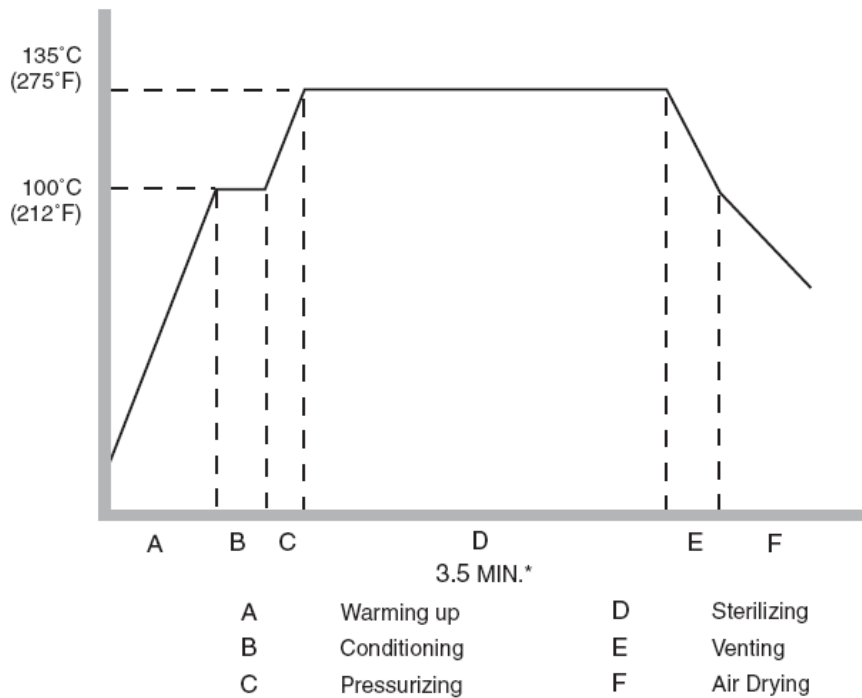

## Statim 2000 Wrapped Cycle

Temperature rises to approx 102°C. Solenoid closes (new units 30 second delay after reaching 102°C before Solenoid closes). Unit then conditions to 135°C. Unit will hold at 135°C for approximately 30 seconds, then the Solenoid opens and the unit depressurizes to 115°C. This depressurization is to remove air from the bags. The Solenoid then closes and the unit pressurizes to 135°C. The unit goes into sterilization for 10 minutes. Unit then depressurizes to 103°C and air-drying starts (on units with 4XX and 5XX software the air compressor will turn ON while unit is still venting). This feature is to prevent deposits from collecting in the boiler. The compressor turning ON during venting will remove moisture from the boiler. The operator is unable to remove the cassette from the Statim until the Stop button is pressed.

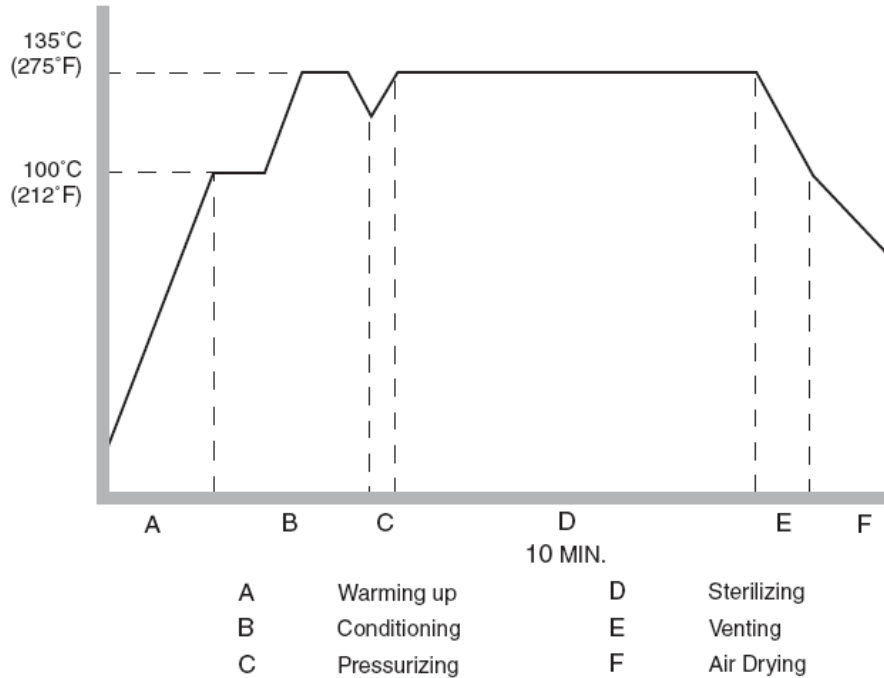



## Statim 5000 Unwrapped Cycle

Temperature rises to approx 102°C. Solenoid closes (new units 30 second delay after reaching 102°C before Solenoid closes). Unit then conditions to 132°C. The Solenoid opens and the unit depressurizes to 115°C. This depressurization is to remove air from the large chamber. The Solenoid then closes and the unit pressurizes to 132°C. The unit goes into sterilization for 3.5 minutes. Unit then depressurizes to 103°C and air-drying starts (on units with 4XX and 5XX software the air compressor will turn ON while unit is still venting). This feature is to prevent deposits from collecting in the boiler. The compressor turning ON during venting will remove moisture from the boiler. The operator is unable to remove the cassette from the Statim until the Stop button is pressed. Note: Heavy Duty Unwrapped Cycle operates the same as the Unwrapped Cycle with a six-minute sterilization time.

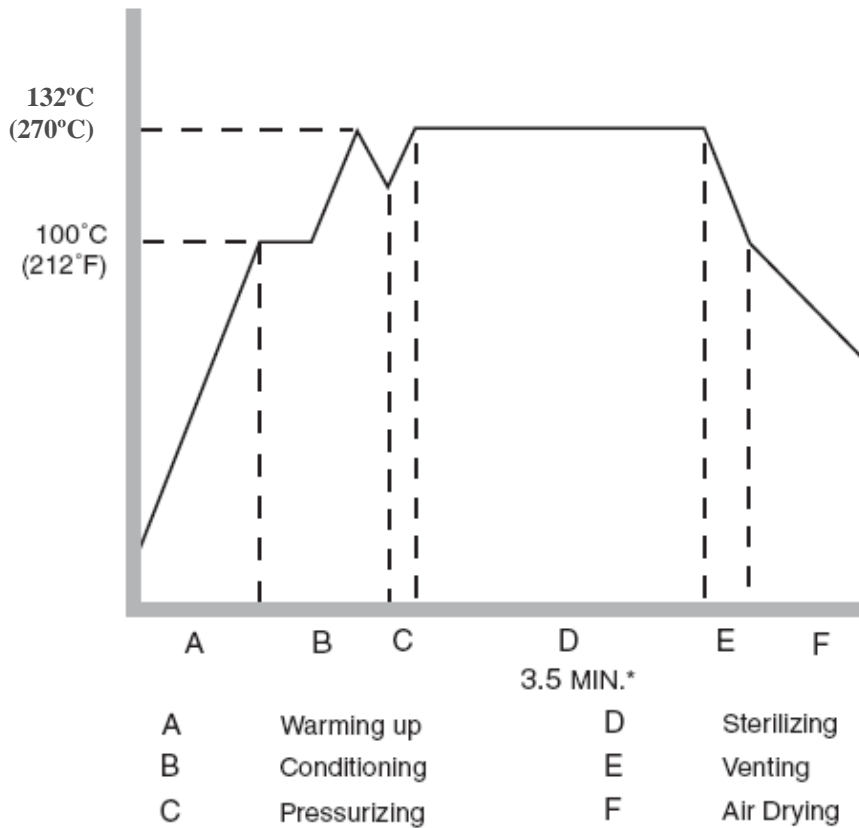

## Statim 5000 Wrapped Cycle

Temperature rises to approx 102°C. Solenoid closes (new units 30 second delay after reaching 102°C before Solenoid closes). Unit then conditions to 132°C. The Solenoid opens and the unit depressurizes to 115°C. The unit will condition up and down between 115°C and 132°C six times. This depressurization is to remove air from the cassette and bags. The Solenoid then closes and the unit pressurizes to 132°C. The unit goes into sterilization for 6 minutes. Unit then depressurizes to 103°C and air-drying starts (on units with 4XX and 5XX software the air compressor will turn ON while unit is still venting). This feature is to prevent deposits from collecting in the boiler. The compressor turning ON during venting will remove moisture from the boiler. The operator is unable to remove the cassette from the Statim until the Stop button is pressed.

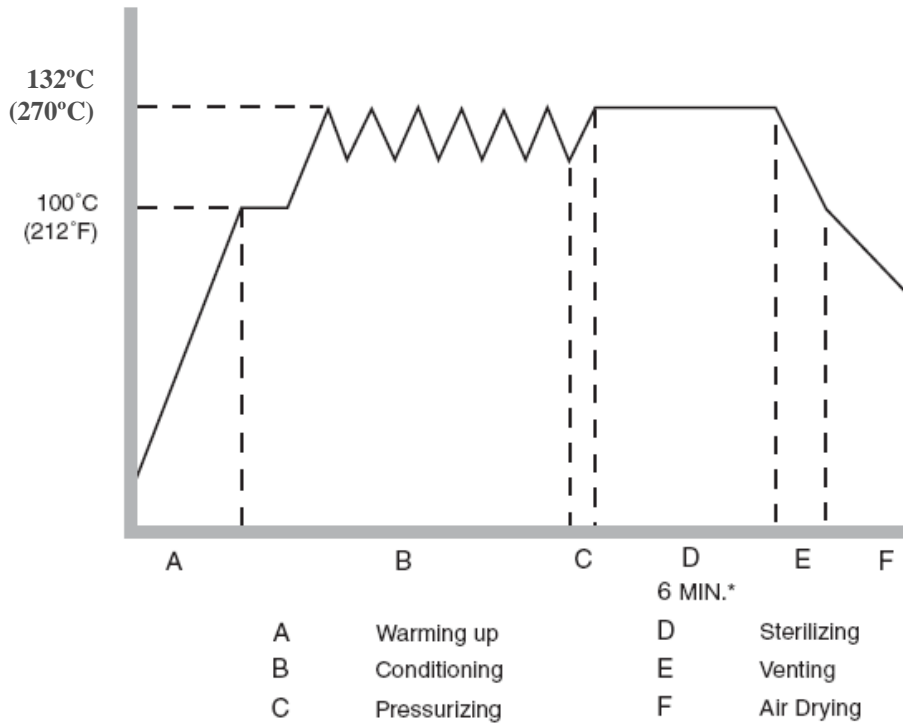

## Cassette Operation, Care & Maintenance, Seal Replacement



### Cassette Operation

The cassette is the chamber of the Statim sterilizer. Steam enters the cassette through a partially blocked port in the rear. Because this port is not open completely the steam is channeled inside the seal and released in the front of the cassette. The steam by entering the front of the cassette forces the air out of the exhaust port in the rear. This pulse pressure action allows us to remove the air and stop oxidation of instruments. We are also able to penetrate the turbine area and the water and air lines of handpieces. The seal located in the lid of the cassette keeps steam from leaking. If steam is leaking from the cassette the seal needs to be checked and changed if necessary. If no leaks are visible the seal is doing its job and does not need replaced. Large steam leaks may cause error codes 2, 3, 4 & 7 to occur.

### Care and Maintenance of the Statim Cassette

To clean the cassette, use a non-chloride cleanser (i.e. Cameo, Zud or Bar Keepers Friend) and a green scratchpad. At least once a week clean the inside of the cassette lid, inside of the tray and the outside edge of the tray. After cleaning, rinse and dry, then apply a liberal amount of Stat-Dri Plus to the inside metal surfaces. This SciCan product helps the water expel off of the inside surfaces of the cassette. When you open the cassette and see beads of water clinging to the cassette lid the cassette needs to be treated with Stat-Dri Plus. Failure to keep the cassette clean and treated with Stat-Dri Plus will cause poor drying. Clean the outside surface of the Statim with a mild soap and water. The seal in the cassettes will last approximately 800 cycles and if maintained properly could last longer.

### Cassette Seal Replacement

To replace the seal use a small flat blade screwdriver or small spatula. Slide the tool behind the corner of the seal and lift it out until you can grab the seal with your hand. Pull on the seal to remove it from the channel it is seated in. Clean inside the channel if necessary. You may use a non-chloride cleanser and a toothbrush or green scratchpad for cleaning. To install the new seal fill the palm of your hand with the lubricant provided or liquid hand soap then make a fist around the seal. Pull the seal so it rotates through your hand 3 or 4 rotations. Install the 2 holes in the seal into the holes in the cassette lid. Next install the 4 corners so the 2 indicator squares on the seal are visible in each corner. Install the long sides next. Slide the middle of the side into the channel and work from the middle to one corner then from the middle to the opposite corner. Do the 2 long sides then the 2 short sides always working from the middle to the corner. Once the seal has been inserted take your finger and lift up on the flap of the seal in the middle of a long side. As you are lifting up slide your finger along the side from corner to corner making sure the seal is seated firmly into the channel. Do this on all four sides. Recheck your corners to be sure all 8 squares are visible and check the 2 holes to make sure they are centered. Clean the outside edge of the tray to remove any dirt.

## Statim 2000 & 5000 Cover Removal

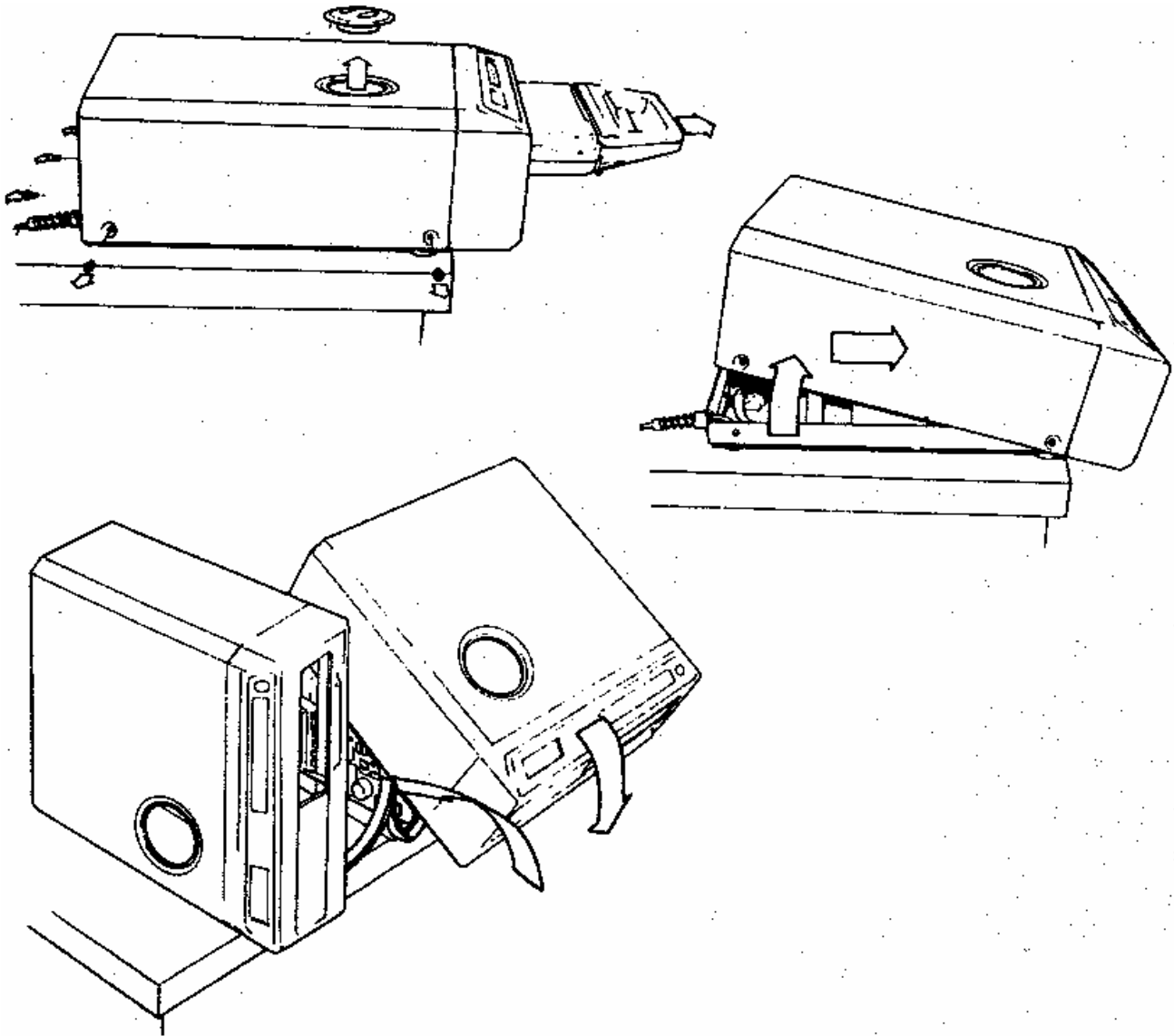

Unplug the Statim and remove the cassette and reservoir cap.

Remove 4 side screws and 3 rear screws.

On the Statim 5000 the center screw in the rear is behind the biological filter holding the filter bracket. With the front of the cover overhanging the edge of the counter, lift up the rear of the cover until it clears the internal components, and then slide the cover forward about an inch. Take care not to strain the ribbon cables connecting the display and keypad.

Gently rotate the cover up and pivot it around the front left corner of the machine.

When the cover is clear of the machine, rest it on its side.

## Statim Steam Flow Chart

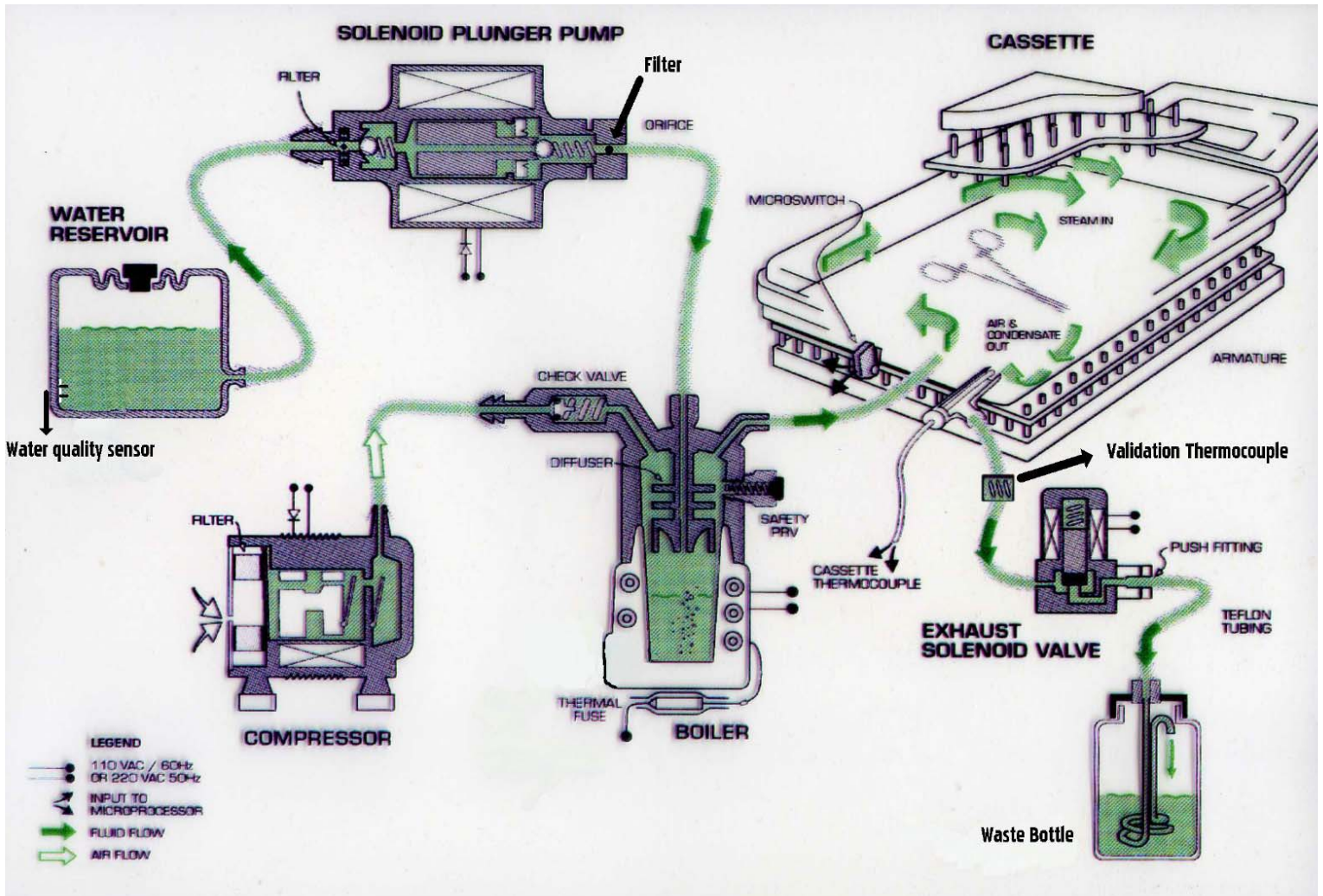

Fill Water Reservoir with steam-distilled water  
 Water Quality Sensor checks water level and quality of water  
 Water gravity flows into Water Pump  
 Water Pump has an input and output filter.  
 Water Pump sends water at 38PSI to the Boiler  
 Boiler produces steam, which is injected into Cassette.  
 Steam travels inside seal and releases in the front of the Cassette  
 Steam forces air and condensate out of the rear of the Cassette and Cassette Thermocouple monitors the chamber temperature.  
 Validation Thermocouple checks temperature as steam exhausts from the Cassette and compares to chamber temperature  
 Air, condensate and steam travel through the Solenoid and into the Water Bottle  
 When sterilization phase of the cycle is complete the Compressor turns ON and sends clean filtered air through the Check Valve and Boiler and into the Cassette.

## Sequence of Operation

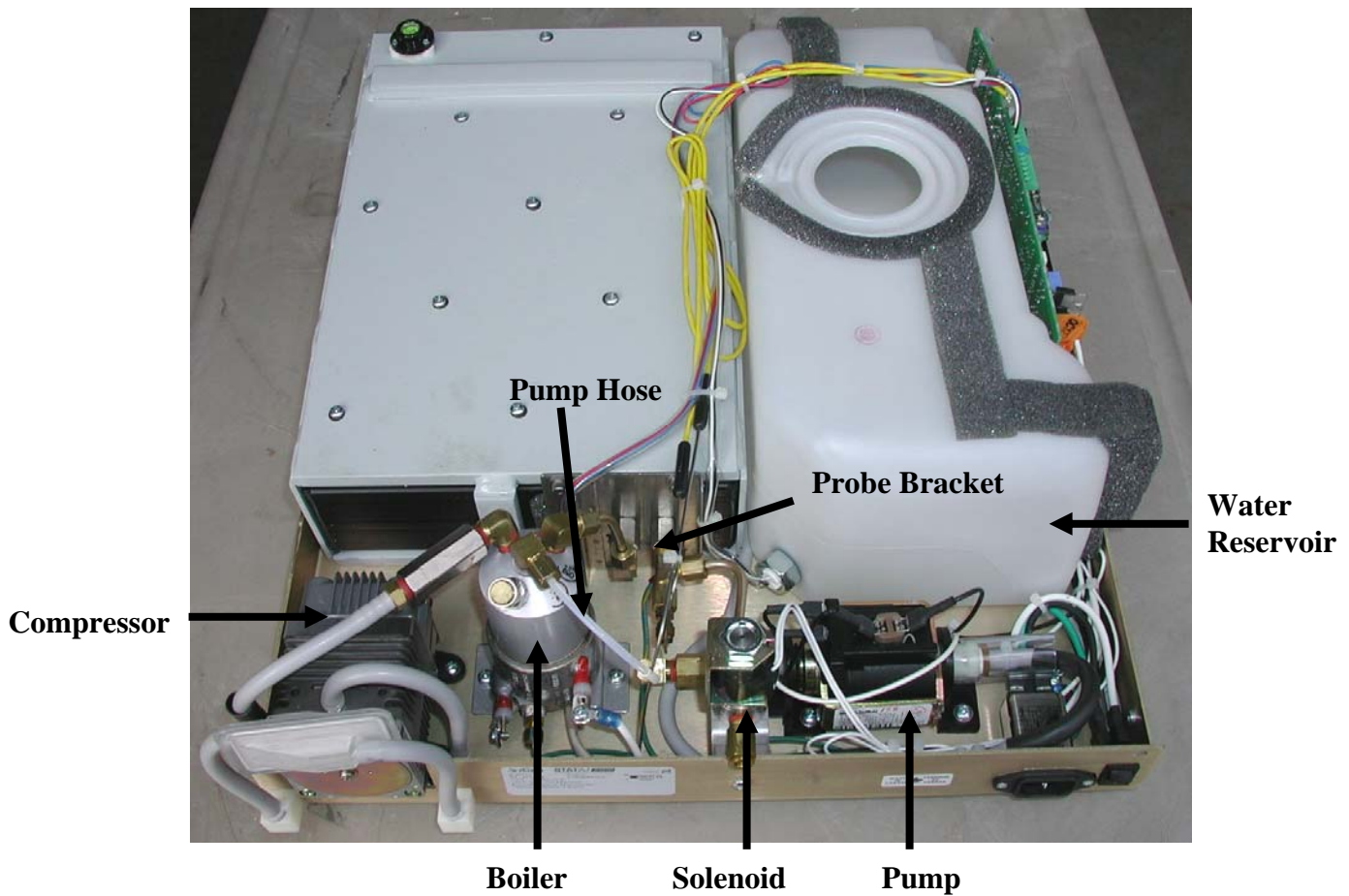

All Statim 2000 & 5000 sterilizers operate in the same manner. You will have different times and temperatures for the various cycles and the conditioning is different on each cycle but the pump, boiler, solenoid and air compressor will basically operate the same in each unit. The explanation below is for an Unwrapped Cycle for a Statim 2000.

When an Unwrapped Cycle is selected and the start button is pressed power is supplied to the boiler. The boiler begins to heat. The boiler thermocouple senses the temperature of the boiler and the pump will pump water into the boiler. As the water in the boiler changes to steam the pump continues to replenish the boiler. The steam travels through the probe bracket and into the cassette. The air in the cassette is forced out the back, through the solenoid and down into the condensing coil in the waste bottle. When the temperature in the cassette reaches approximately 102°C the solenoid will close and the cassette will pressurize. When the temperature in the cassette reaches 135°C sterilization will begin. A timer will run for 3.5 minutes. During this time the solenoid will open and close periodically and the pump will run as needed to provide water to produce steam. When the 3.5 minutes of time is complete the solenoid will open and vent the chamber into the waste bottle. The chamber should vent to 103°C in 30 seconds. When the temperature reaches 103°C the air compressor will turn on. The compressor will run for 60 minutes but may be stopped at any time by pressing the stop button.



## No Power PCB Revision 2.4-2.92 & 6.4

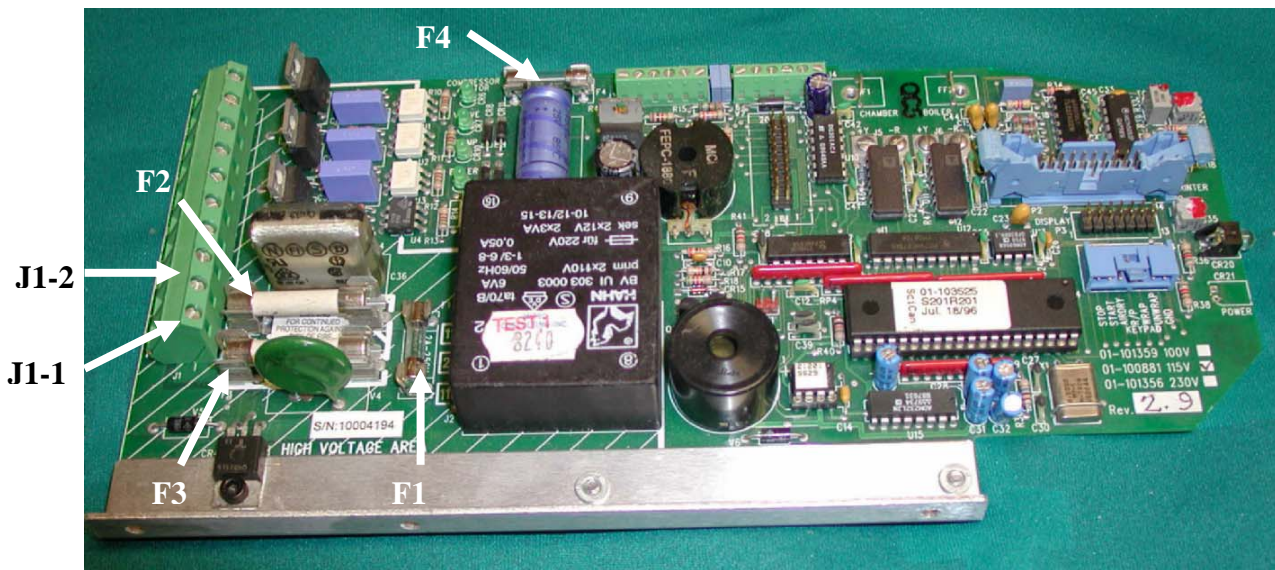

1. Verify that there is no display and no green power light.
2. Check outlet to make sure there is power.
3. Check that power cord is plugged into electrical outlet and back of Statim.
4. Verify power switch is turned **ON**.
5. With power switch **OFF** check all fuses for continuity.
6. Turn power switch **ON**.
7. Using a voltmeter check for line voltage at bottom two terminals on the left side of the PCB, J1-1 and J1-2. If line voltage is present proceed to step 8. If not check for burnt wiring from power cord to the power switch to the PCB.
8. Check for line voltage on the left side of the two 15 amp fuses. Place a meter lead on the left side of the upper fuse (F2) and a meter lead on the left side on the lower fuse (F3). If line voltage is present proceed to step 9. If not check the PCB for a bad connection between Terminal J1-1 and the lower 15 amp fuse (F3) or terminal J1-2 and the upper 15 amp fuse (F2).
9. Check for line voltage on the right side of the two 15 amp fuses. Place a meter lead on the right side of the upper fuse (F2) and a meter lead on the right side of the lower fuse (F3). If line voltage is present the PCB is bad. If line voltage is not present recheck 15 amp fuses or check for bad connection at fuse holders.

**Note: When replacing fuses always be sure the fuse holders are tight and the screws holding the power wires are tight.**

## Pump, Solenoid & Compressor Testing

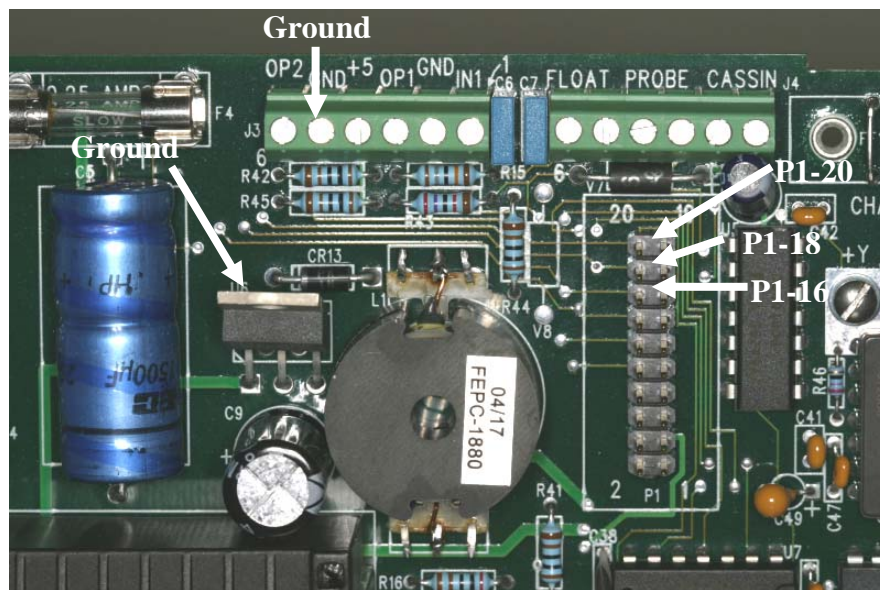
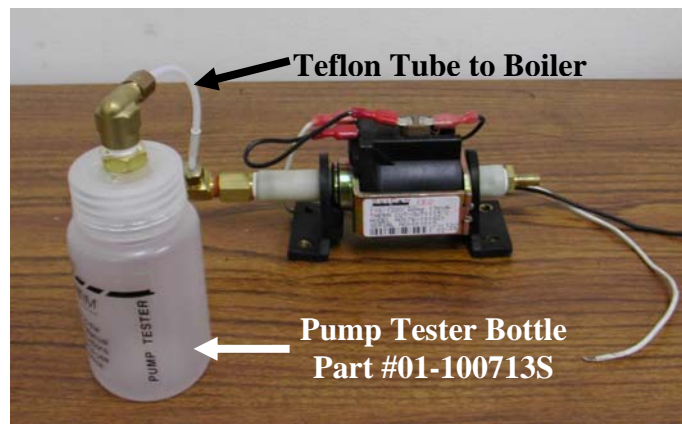

### Pump Tester Instructions

1. Disconnect the Teflon boiler inlet tube from the top of the boiler.
2. Connect the disconnected end of the inlet tube to the pump tester.
3. Activate the pump by shorting P1-16 to ground on the PCB for 2 seconds to purge any air that is trapped in the fittings. Empty any water that enters the pump tester. The pump tester must be empty before starting the pump test.
4. Be prepared to record the time it takes for the water level in the pump tester bottle to reach the line marked **MIN**. Activate the pump by shorting P1-16 to ground on the PCB.
5. For **Statim 2000** the water level should reach the **MIN** line within **23-24** seconds.
6. For **Statim 5000** the water level should reach the **MIN** line within **21-23** seconds.
7. If the pump fails the pump test clean the pump filters (see page 14).

### Solenoid & Compressor Tests

1. Short P1-18 to ground on the PCB to activate the solenoid.
2. Short P1-20 to ground on the PCB to activate the compressor.



## Pump Filter Cleaning Instructions

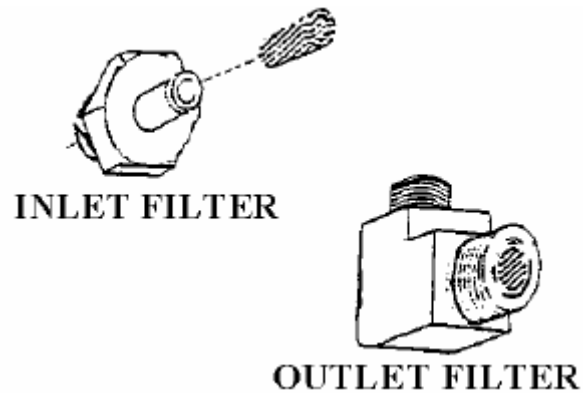
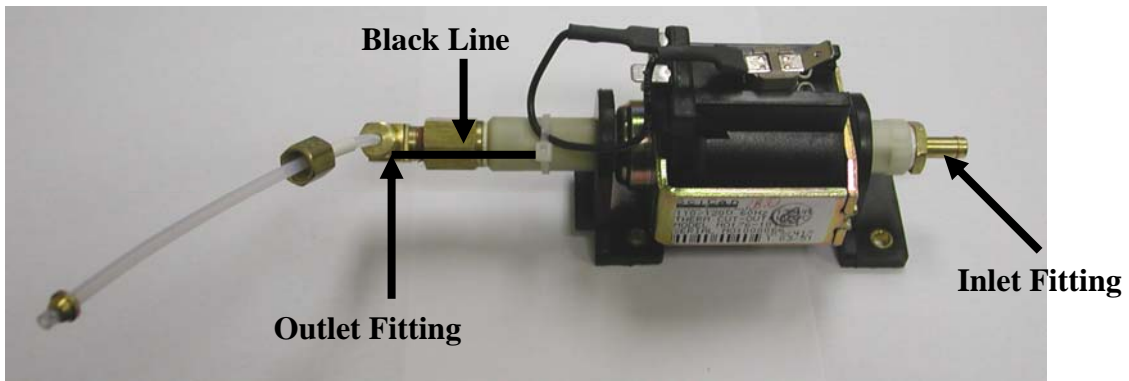

The inlet fitting of the SciCan pump contains a coarse mesh filter and the outlet elbow fitting contains a fine mesh filter. To clean the filters rinse them under clean running water and scrub with a toothbrush. **Note: Since June 2007 all filters have been removed from the Pump. Units without Pump Filters must have a Water Reservoir Filter. The part number for Reservoir Cap & Filter is 01-101783S. If the unit has a new style Reservoir Cap the Filter only part number is 01-109300S.**

## Thermal Fuse Location

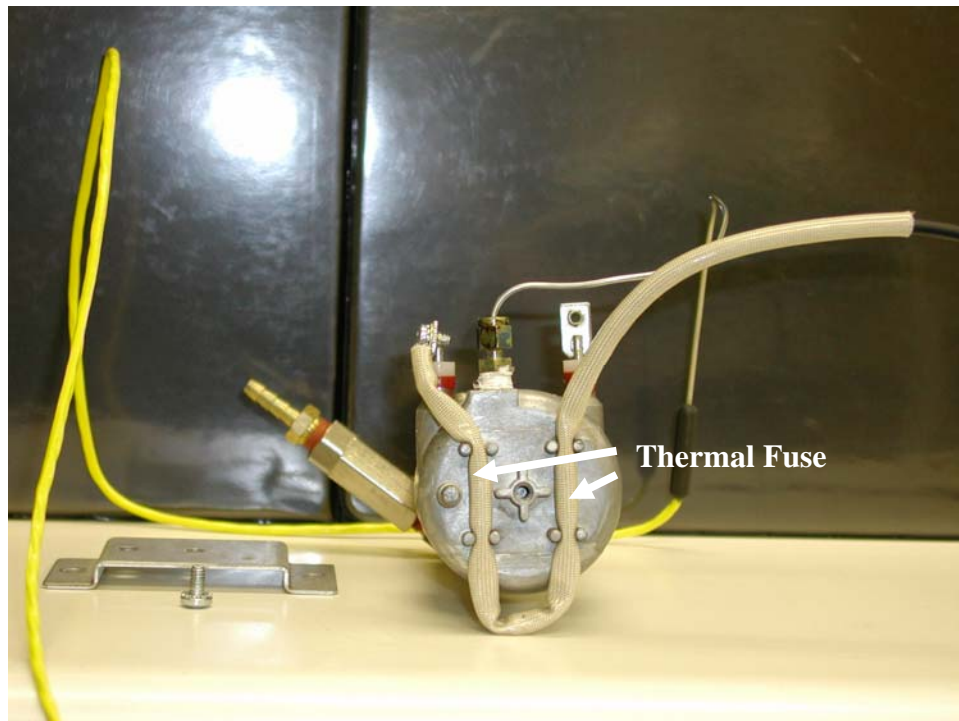
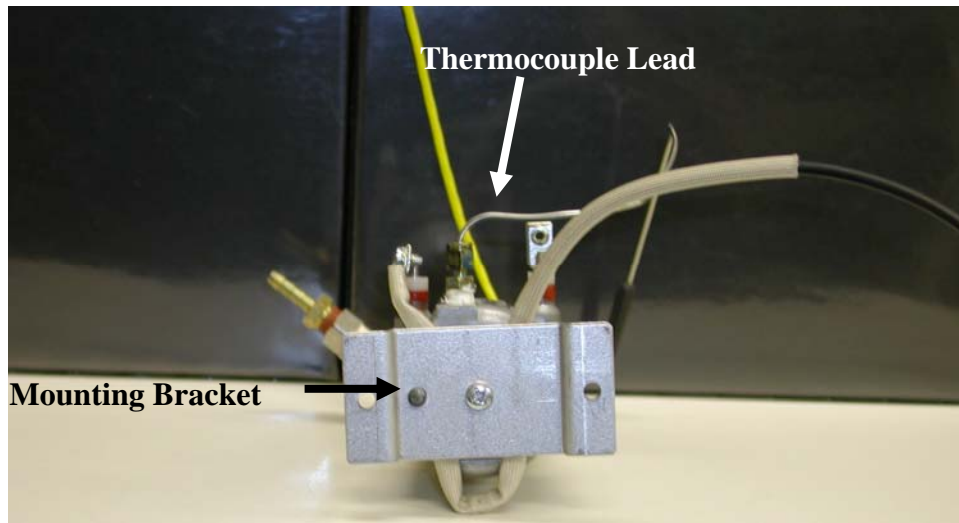

## Probe Bracket

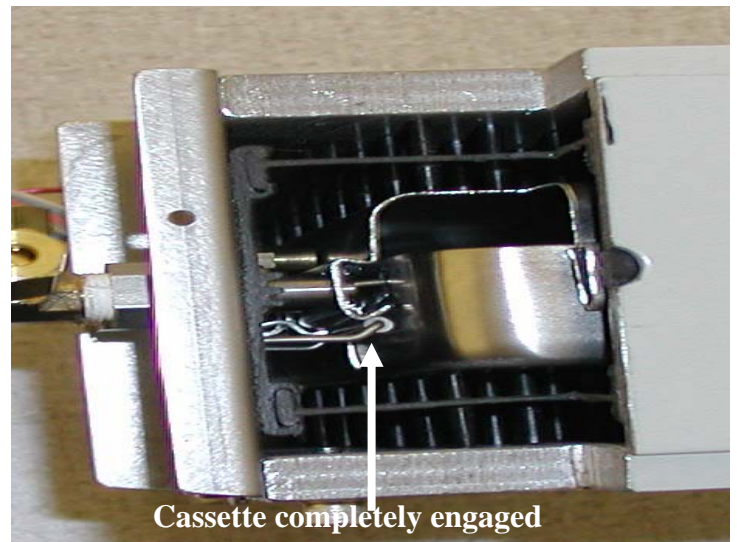
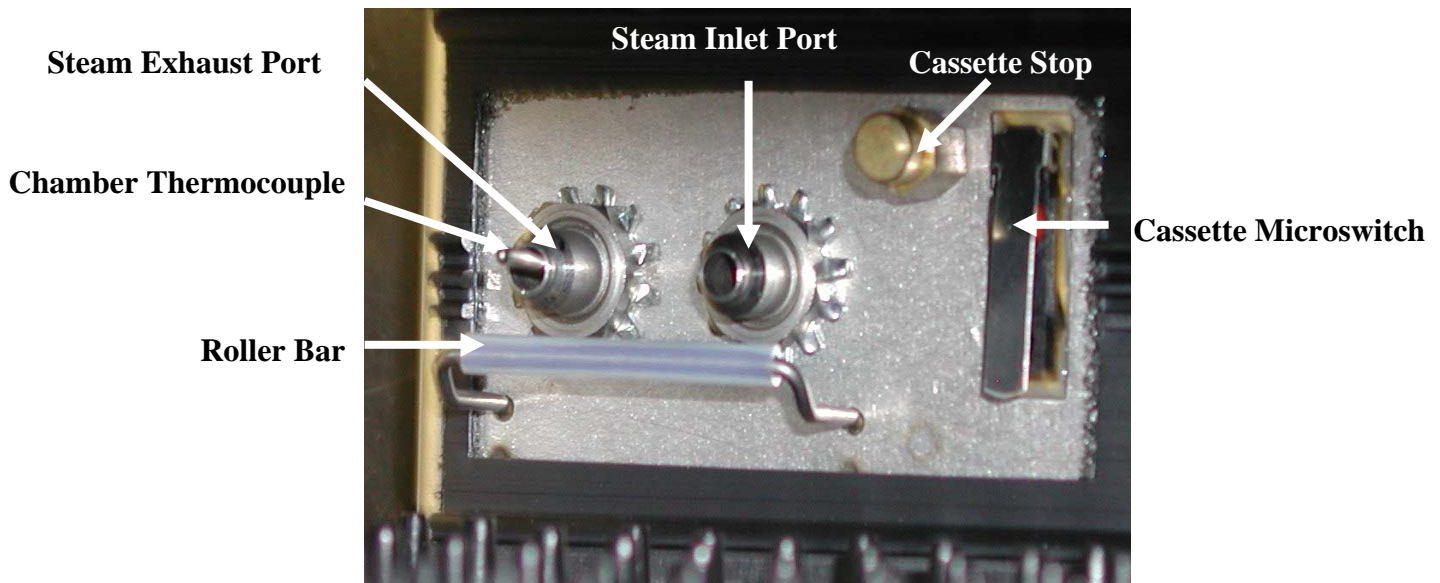

To avoid bending the chamber thermocouple, slide the cassette in gently until it reaches the roller bar, then push cassette firmly until cassette is completely engaged.

**Microswitch Location Statim 2000**

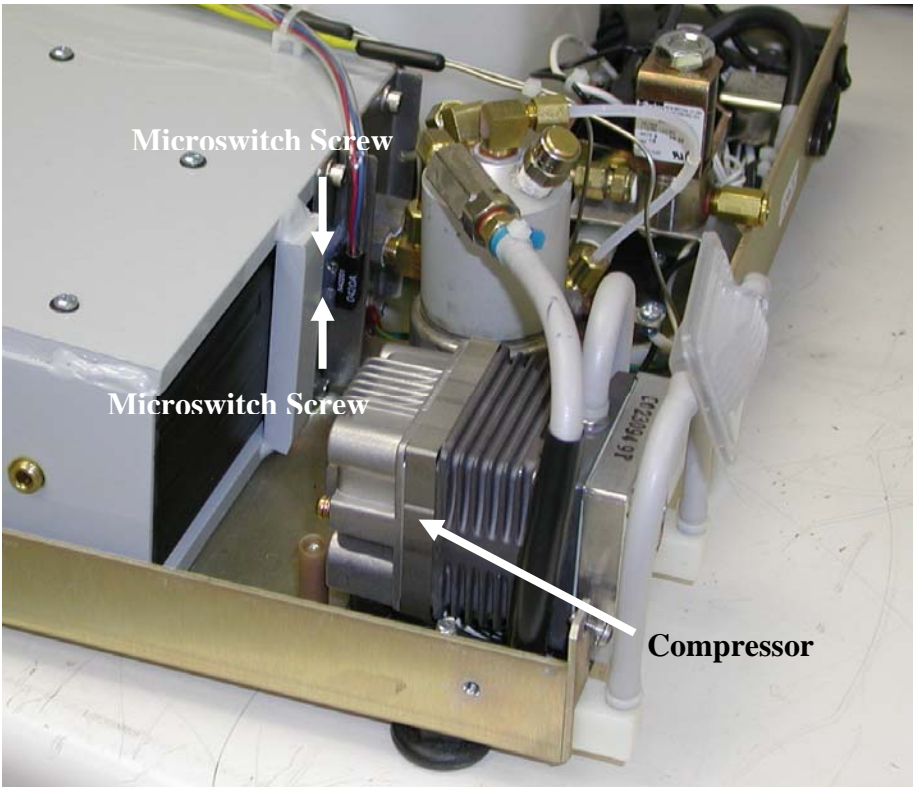

**Microswitch Location Statim 5000**





## Solenoid Valve Inspection and Repair

(Honeywell & Parker solenoids only)

1. Ensure that the power is off. Disassembly of the solenoid valve with the power on will cause valve coil damage.
2. Remove the retaining nut, yoke and coil from the top of the valve.
3. Unscrew the plunger tube assembly. The tube may be removed by carefully gripping the tube above the weld with a pair of pliers and turning counterclockwise.
4. Remove the plunger (take care not to lose the spring) and inspect the plunger seal. If the plunger seal is damaged replace it with solenoid repair kit (part #01-100998S).
5. Remove any debris found in the valve body and blow air through all orifices.
6. Clean the plunger and ensure that the plunger slides smoothly in the plunger tube.
7. Reassemble the solenoid valve.

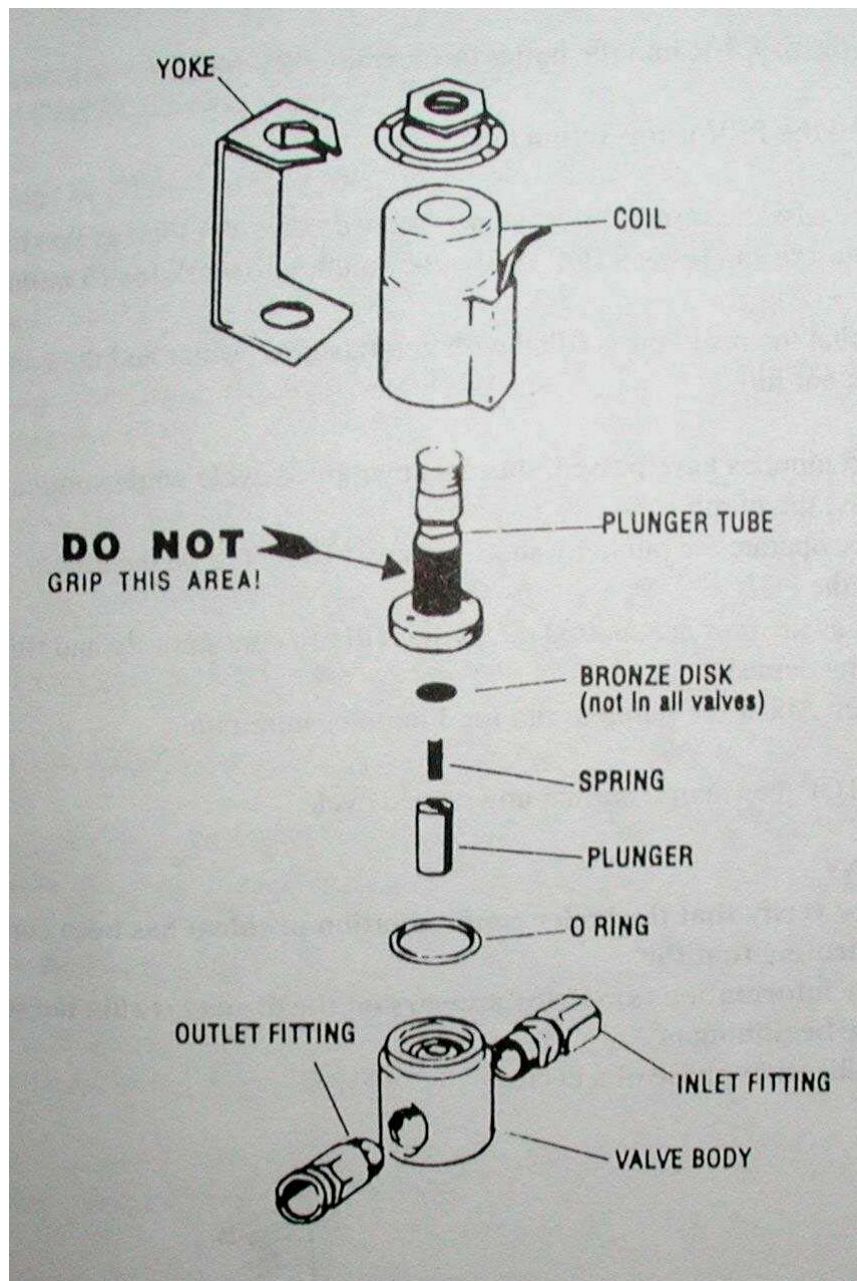

## Boiler Calibration 2000 & 5000 Rev. 2.4-2.9



Turn the main power switch OFF and remove the cover. Check to see that the reservoir has enough distilled water to cover the water quality sensor.

1. Short together pins W1 located to the left of the microprocessor on the PCB. Turn the power switch ON.
2. The LCD will show CALIBRATING with two digits in the upper left corner of the display and two digits in the upper right corner of the display. The value in the lower left corner of the display is the difference between the boiler (steam generator) and chamber temperatures. The value in the lower right corner of the display is the chamber temperature. The display should appear similar to example 1.

F9>	CALIBRATING	<C8
+32.00°C		65.00°C

EXAMPLE 1

4. **Insert a cassette.**
5. To start the boiler self-calibration cycle, hold down the UNWRAPPED button and press the START button. The two digits in the upper left corner will change to 00> and an asterisk\* will appear after the message CALIBRATING\*. The display should appear similar to example 2.

00>	CALIBRATING*	<C8
+32.00°C		65.00°C

EXAMPLE 2

6. The calibration cycle will last approximately 5 minutes. A long beep will sound when the calibration cycle is complete. The 00> in the upper left corner of the display should change to two digits. Once the 00> changes the. The display should appear similar to example 3.

F6>	CALIBRATING*	<C8
+2.00°C		135.00°C

EXAMPLE 3

7. Press the STOP button and allow the Statim to vent. When the display says PRESS STOP TO RESET the venting is complete press the STOP button again. The display should say SELECT A CYCLE. You may now run normal cycles.

## Boiler Calibration 2000 & 5000 Rev. 6.x & Adapter Boards with 44-pin Microprocessor



1. Turn the main power switch OFF and remove the cover. Check to see that the reservoir has enough distilled water to cover the water quality sensor.
2. Short together pins W1 located to the left of the microprocessor on the PCB. Turn the power switch ON.
3. The LCD will appear similar to example 1. The value in the lower right-hand corner of the display is the difference between the boiler and chamber temperatures. The value in the upper left corner is the boiler temperature. The following two digits in the upper left corner of the display represent the boiler-offset value in hexadecimal. The two digits in the upper right corner of the display represent the chamber-offset value in hexadecimal and to the left of the chamber-offset value is the chamber temperature.

25.5	C8	24.1	F9
			1.4

**EXAMPLE 1**

4. **Insert a cassette.**
5. To start the boiler self-calibration cycle, hold down the UNWRAPPED button and press the START button. The unit will beep three times and the boiler-offset value will change to 00, an asterisk will appear after the 00\* the display should appear similar to example 2.

25.5	00*	24.1	F9
			1.4

**EXAMPLE 2**

6. The calibration cycle will proceed and when the unit reaches the sterilization phase of the cycle the unit will beep twice. After 3.5 minutes the unit will vent indicating the boiler calibration is complete. The boiler-offset value in the upper left corner of the display has changed to display the new boiler-offset value. The display should appear similar to example 3

145.5	F3*	135.9	F9
			9.6

**EXAMPLE 3**

7. After venting is complete press the STOP button to end the boiler calibration cycle



## Water Testers



**Water Tester QA Supply**



**SciCan Water Tester**

The TDS 1 tester reads Parts Per Million (ppm) of Total Dissolved Solids (TDS). The display will read from 0 to 999 ppm.

The SciCan tester reads the conductivity of water, micro Siemens ( $\mu\text{S}$ ). The display will read from 0 to 99.9  $\mu\text{S}$ .

To convert  $\mu\text{S}$  to ppm, multiply the  $\mu\text{S}$  reading by .64. Example 1  $\mu\text{S}$  = .64 ppm.

### **SciCan Water Tester Operation**

1. Remove the protective cap.
2. Rinse the tester in distilled water up to the maximum immersion line.
3. Turn the H<sub>2</sub>O Tester on.
4. Immerse it in the sample without exceeding the maximum immersion level.
5. Read the value on the display in ppm or  $\mu\text{S}/\text{cm}$ .
6. Distilled water should read less than 5 ppm.
7. Conversion 1 $\mu\text{S}$  = .64 ppm



**Water Quality Problems**  
**Note: Always Test Water First**

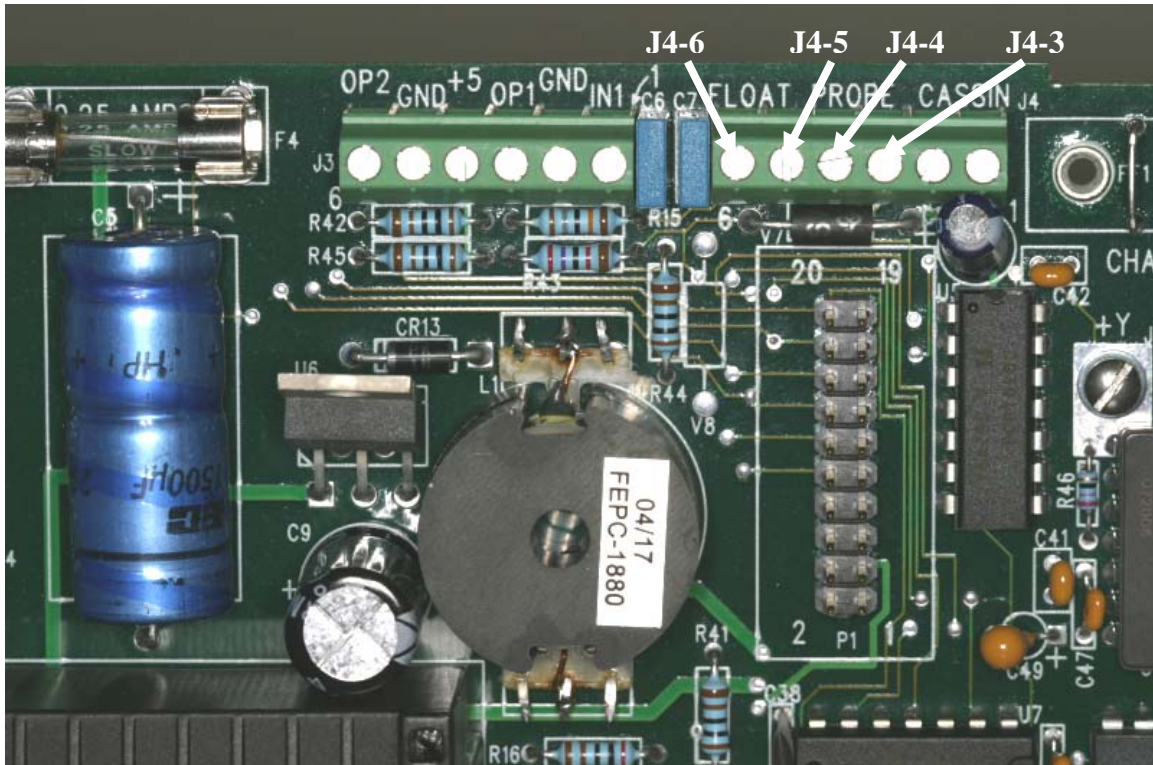

**Diagnosing Water Quality Sensor Problems**

1. Turn off the power; disconnect the sensor leads from the probe terminals J4-3 and J4-4.
2. Turn on the power and start an unwrapped cycle.
3. If a "Refill Reservoir Empty Waste Bottle" message appears on the LCD, proceed to step 4. If the cycle starts when the sensor leads are disconnected, the PCB is bad.
4. Short the probe terminals J4-3 and J4-4. Start a cycle. If the unit displays a "Water Quality Is Not Acceptable" message, proceed to step 5. If not the PCB is bad.
5. Remove the short from probe terminals J4-3 and J4-4. Short the float terminals J4-5 and J4-6. If the cycle starts the PCB is good, the sensor is bad. If the display reads, "Water Quality Is Not Acceptable" the PCB is bad.
6. To test the sensor, short the sensor posts using a long screwdriver. The sensor should read less than 1 ohm.

## Water Quality Check Revision 4XX or 5XX Software

*The water setting should not be changed without first testing the water quality using a conductivity meter. Increasing the high setting may shorten the life of the boiler.*

To check the water quality on a Statim with 4XX or 5XX software, follow these steps:

1. Short pins W1 and hold down the Unwrapped & Wrapped buttons on the keypad simultaneously while turning ON the power switch.
2. The display should appear similar to picture below, with the 30 flashing.



3. Water Cond. is the reading for the water in the unit. It must be between the low & high readings.
4. The settings may be changed when they are flashing. To increase the setting, press and release the unwrapped cycle button. To decrease the setting, press and release the wrapped cycle button. To change between the low and high setting, press and release the rubber and plastics button.

## Control Box Connections

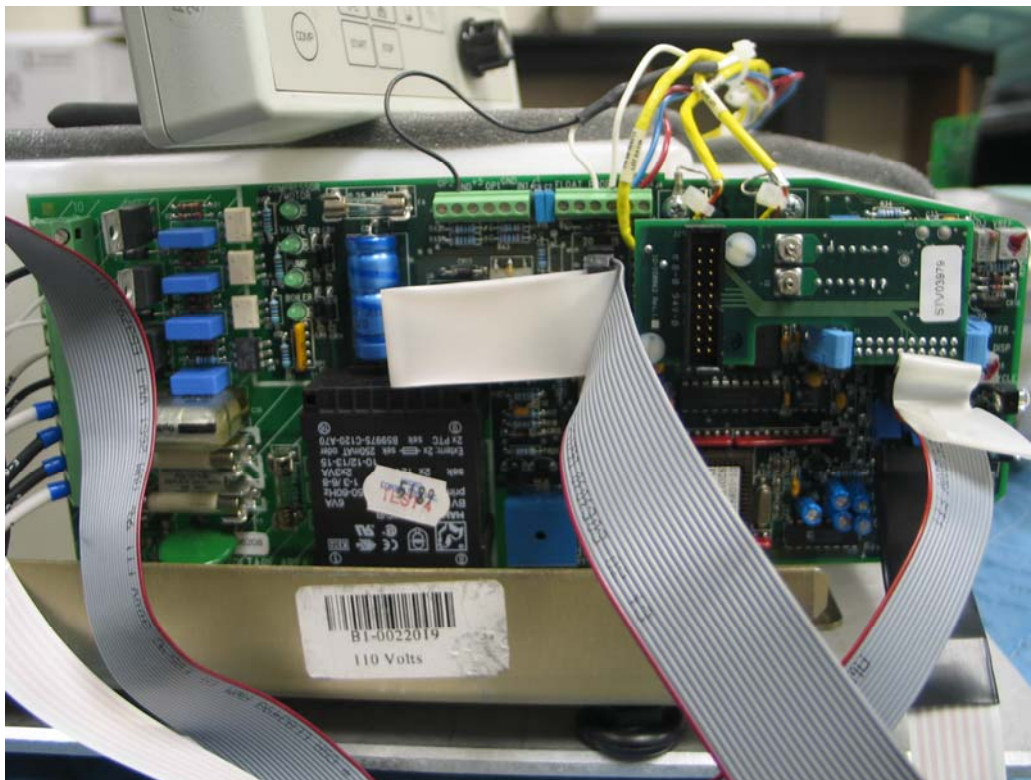
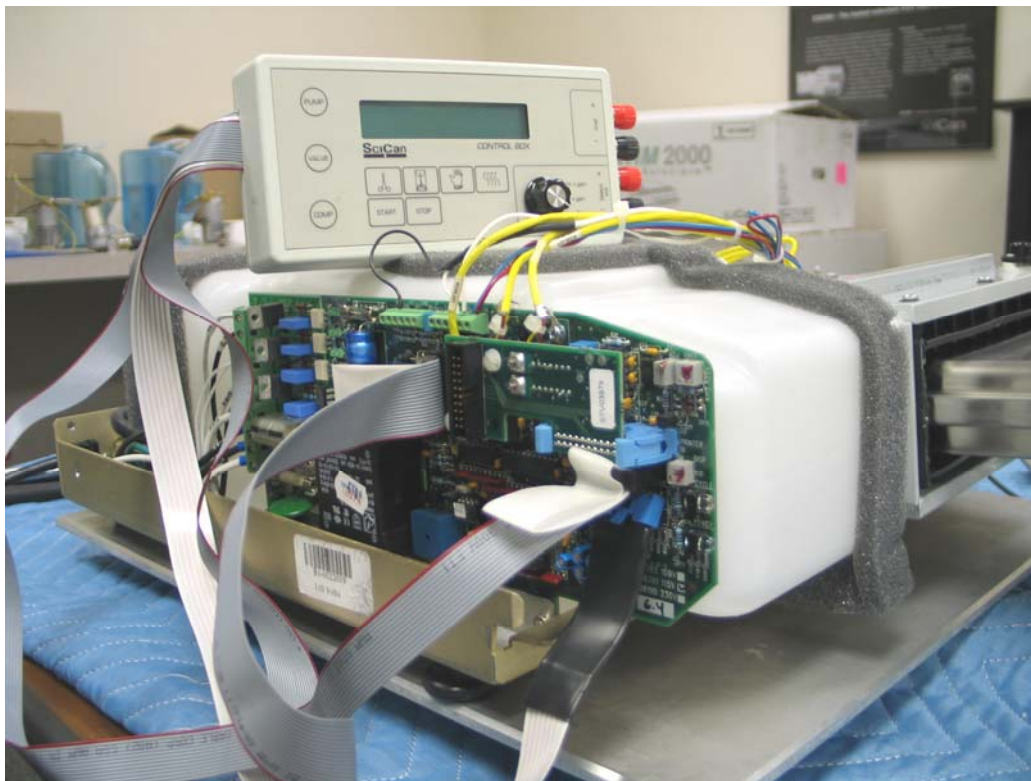



**Statim Water Pump Filters**  
*Statim 2000(S) & 5000(S)*  
**07-TSB-246**

Effective June 2007 SciCan removed the two filters located on each end of the water pump due to the implementation of the water reservoir filter in early 2006. In the past, when the water reservoir filter was not present, debris and dust that entered the reservoir had a chance of getting into the water pump. The two filters in the water pump fittings were required to catch this debris.

Since the water reservoir filter has been implemented in early 2006 (refer to 05-TSB-204), SciCan has decided to remove these unnecessary filters in the water pump and discontinue the replacement parts for these filters, 01-104501S (Filters Pump A/B/C/D), as they are no longer required once the water reservoir filter is installed.

Removal of these filters does not affect the operation of the Statim units in any way.

**Water pump maintenance**

1. Ensure a water reservoir filter is installed
  - a. New reservoir filter and reservoir cap (01-101783S)
  - b. Replacement reservoir filter (01-109300S)
2. Inspect and clean the water pump filters, if the machine is equipped with them.

**Below are the pictures of the filters that have been removed.**



Filter in the inlet fitting  
prior to Jun '07



Filter on the outlet fitting  
prior to Jun '07

- Temperature Monitor & Control
- Inspection Instrumentation
- Control, Monitor & Alarm Systems
- Weather Monitoring
- Air Analysis
- Water, Soil & Food Analysis
- Pallet Covers, Bags & Blankets
- Humidifiers, Hygrometers
- Insulated Clothing
- Ethylene: Ripening, Removal
- Pest Control
- Automotive
- Radio Controlled Clocks
- Shipping Info
- Specials
- Customer Service

[Home](#) > [Water, Soil & Food Analysis](#) > [Conductivity, TDS & Salinity](#) > **TDS 1 Tester**

### TDS 1 Tester



[\[+\] Click to Enlarge](#)

PRICE \$15.00

QUANTITY

QTY	PRICE	SALE !
1+	\$15.00	
10+	\$14.00	
20+	\$13.00	

**ADD TO CART>>**

**Item number:** 2009933

**Availability:** Usually ships the same business day.



The TDS 1 is a simple and affordable pocket tester for TDS measurements. The measurement is automatically compensated for temperature variations, thanks to its internal temperature sensor. Calibration can be performed in one point and batteries can be easily replaced after removing the top cover.

#### Features:

- Supplied with protective cap, calibration screwdriver, batteries and instructions

#### Specifications:

- Range: 0 to 999 ppm (mg/L)
- Accuracy (@20°C/68°F): ±2% F.S.
- Weight: 70g
- [Click here](#) for detailed specifications

**Other products you might find interesting:** Please select items below then press "Add to Cart" button on the top of the page.

#### HI70080P 800 ppm TDS solution

25 sachets of 20 mL each

**Availability:** Usually ships the same business day.

**Item number:** 2006127

PRICE \$21.00

QUANTITY

CALL US TOLL FREE  
**1.800.472.7205**

Same Day Shipping!  
Order in-stock items by  
3 p.m. (EST, Mon-Fri) & we  
will ship it that day

[SHIPPING INFO PAGE >>](#)



We are a  
5 Star Yahoo! Store >>  
with  
Secure shopping >>  
and excellent  
Customer Service >>



Sign up for our occasional e-  
Newsletter, which contains new  
product information and special  
offers! >>