

## SMP / SMP-COM / SMP-MAX series

R222

**RADIAL**   
The next conneXion



**Pages**

**SMP**

Introduction ..... 3-5

Interface ..... 3-6 to 3-7

Characteristics ..... 3-8

Plugs and jacks ..... 3-10

Receptacles ..... 3-11 to 3-13

Panel shroud ..... 3-13 to 3-14

Glass bead ..... 3-14

Adapters ..... 3-14 to 3-15

Packaging ..... 3-15

Assembly instructions ..... 3-16

Panel drilling ..... 3-20

**SMP-COM**

Introduction ..... 3-5

Interface ..... 3-7

Characteristics ..... 3-9

Plugs and jacks ..... 3-17 to 3-18

Receptacles ..... 3-18

Adapters ..... 3-19

Measurement ..... 3-19

Packaging ..... 3-19

Panel drilling ..... 3-20

Assembly instructions ..... 3-20

**SMP-MAX**

Introduction ..... 3-4 and 3-21

Characteristics ..... 3-22

Jacks ..... 3-23

Plugs ..... 3-23

Receptacles ..... 3-24

Adapters ..... 3-25

Panel drilling ..... 3-26

## INTRODUCTION

### BOARD TO BOARD SOLUTIONS

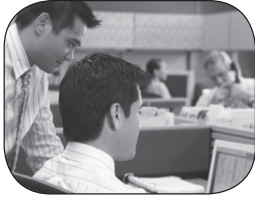

#### The Best Systems

Radiall's engineers work with your engineers allowing us to develop the best competitively priced misalignment RF coaxial interconnect solutions on the market today.

#### The Best Choices

Radiall offers more board 2 board choices with four different product groups and ten connector series that can address the most demanding wireless telecom applications required for the new generation of infrastructure compact equipment. From base stations to repeaters and even handheld and GPS devices, we have a tailored connector solution for you; including the new SMP-MAX, SMP-Spring, IMP-Spring and other large, limited and no misalignment solutions.



*SMP-MAX  
Receptacle*

#### SMP-MAX

Get the best for less with the new SMP-MAX large misalignment solution. Its patented impedance matching insulator is optimized for a larger operating gap between connectors making it easier for engineers to handle a board 2 board distance tolerance of at least .078" (2.0 mm) without a spring, which is 300% more than the standard SMP! It features a 3° minimum tilt (radial travel) and it has an operating frequency range of DC-6 GHz and a 1.2 max VSWR guaranteed at DC-3 GHz.



*SMP-MAX Adapter*

#### Spring-loaded Connectors

Radiall's one connector IMP-Spring and three connector SMP-Spring and MMBX-Spring large misalignment spring-loaded series are the best for increased maximum distance tolerances.

IMP-Spring is a cost effective unique one connector solution that offers up to .023" (.6 mm) board 2 board distance tolerance with a tilt (radial travel) up to 4.5°.

The new SMP-Spring and MMBX-Spring offer up to .078" (2 mm) board 2 board distance tolerance and a 4.5° tilt (radial travel).

All spring-loaded solutions feature consistent VSWR and low RF leakage.



*IMP-Spring and SMP-Spring*



*IMP*

#### Limited Misalignment

Radiall's one connector IMP and three connector SMP and MMBX limited misalignment series are designed for applications requiring relatively precise distance tolerance of up to .023" (.6 mm) with a tilt (radial travel) of up to 4.5°.

#### No Misalignment

Radiall's MMT, MMS and MCX series are designed for applications requiring little or no distance tolerance between boards.



	SMP	SMP-COM
50Ω	DC - 40 GHz	DC - 12.4 GHz

## GENERAL

- Microminiature
- Blindmate
- Excellent vibration and shock performances
- Allows axial and radial misalignments

## APPLICATIONS

- High density packaging
- Phased array antenna
- Satellite
- Airborne/Shipborne/Ground radar
- Communication equipment
- Board to board applications

The SMP series offers 3 levels of retention provided by the connectors with male center contact:

- **full detent** for a positive locking with a maximum retention
- **limited detent** for a positive locking with a medium retention
- **smooth bore** for the lowest retention.

The SMP series meets MIL STD 348 specifications the DESC specifications 94007 & 94008.

Their small size permits connector center-to-center spacing as low as 4.8 mm.

Radiall also offers multi-way connectors with SMP interface to optimize the positioning of connectors, increasing density and misalignment tolerances through the design of a metal bar. The metal bar, in which connectors are already inserted, permits the design engineer to connect several SMP connectors while at the same time maintain reasonable retention.

SMP-COM is fully intermateable with the standard SMP and has been optimized up to 12.4 GHz meeting the telecommunication applications needs.

Typical combinations of SMP connectors:

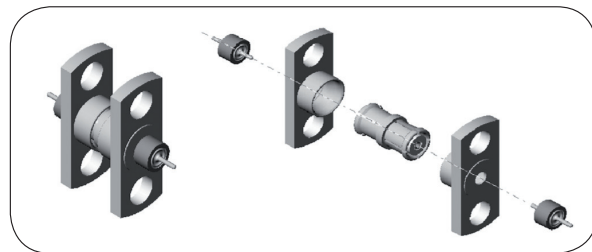

Module to module (2 hole flange shroud)

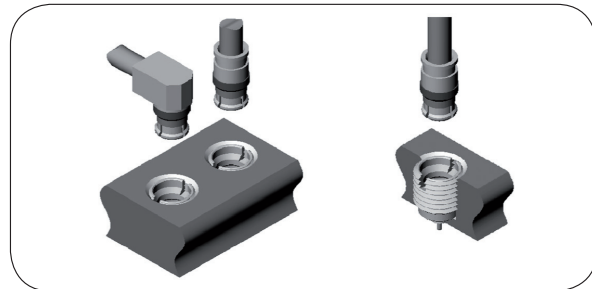

Cable to module

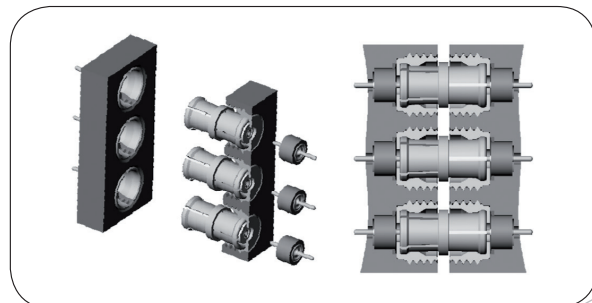

Thread-in shroud for limited space

**INTERFACE SMP**

**JACK WITH MALE CENTER CONTACT (Full Detent or Limited Detent)**

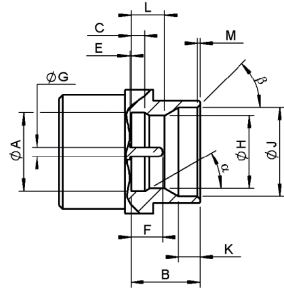

Letter	mm		inch		Note
	min.	max.	min.	max.	
A	3.15	3.20	.124	.126	Dia
B	2.74	2.84	.108	.112	
C	0.52	0.60	.0205	.0235	
E	0.00		0		Center contact recession
F	1.14	1.40	.045	.055	
G	0.36	0.41	.014	.016	Dia
H	2.90	3.00	.114	.118	Dia: Full Detent
	3.00	3.10	.118	.122	Dia: Limited Detent
J	3.53	3.68	.139	.145	Dia
K	0.84	0.94	.033	.037	
L	1.30	1.45	.051	.057	Full Detent
	1.37	1.52	.054	.060	Limited Detent
M	0.08	0.20	.003	.008	
α	30				Degree (nom.)
β	40	50	40	50	Degree

**JACK WITH MALE CENTER CONTACT (Smooth Bore)**

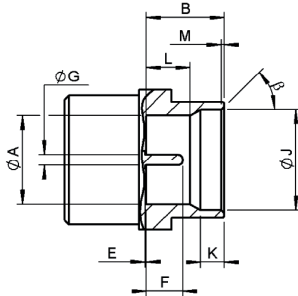

Letter	mm		inch		Note
	min.	max.	min.	max.	
A	3.12	3.23	.123	.127	Dia
B	2.74	2.84	.108	.112	
E	0.00		0		Center contact recession
F	1.14	1.40	.045	.055	
G	0.36	0.41	.014	.016	
J	3.53	3.68	.139	.145	Dia
K	0.84	0.94	.033	.037	
L	1.50	1.65	.059	.065	
M	0.08	0.20	.003	.008	
β	40	50	40	50	Degree

**PLUG WITH FEMALE CENTER CONTACT AND EMI SHIELD (Cabled connection)**

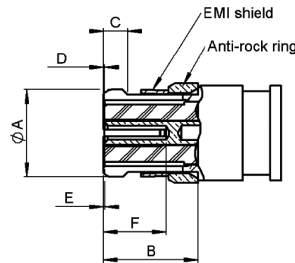

\* Accept .015 ±.001 dia pin

Letter	mm		inch		Note
	min.	max.	min.	max.	
A		3.43		.135	Dia
B	2.84		.112		
C	0.46	0.64	.018	.025	
D		0.00		0	Dielectric projection
E	0.00	0.20	0	.008	Center contact recession
F	1.78		0.70		

**PLUG WITH FEMALE CENTER CONTACT (Cabled connection)**

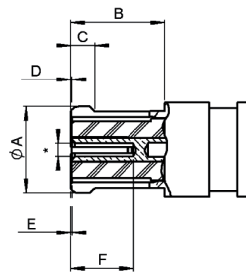

\* Accept .015 ±.001 dia pin

Letter	mm		inch		Note
	min.	max.	min.	max.	
A		3.43		.135	Dia
B	2.84		.112		
C	0.46	0.64	.018	.025	
D		0.00		0	Dielectric projection
E	0.00	0.20	0	.008	Center contact recession
F	1.78		0.70		

## JACK WITH MALE CENTER CONTACT (Catcher's Mitt)

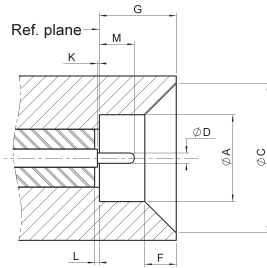

Letter	mm		inch		Note
	min.	max.	min.	max.	
A	3.12	3.23	.123	.127	Dia
C	5.40	5.50	.213	.217	Dia
D	0.37	0.39	.0146	.0154	Dia
F	1.10	1.18	.043	.046	
G	2.77	2.81	.109	.111	
K	0.00		0		Center contact recess
L	0.00		0		Insulator recess
M	1.15	1.39	.045	.055	

Note: Catcher's Mitt interface is not defined in MIL-STD-348 standard.

## INTERFACE SMP-COM

### MALE CONNECTOR (Full detent or Limited detent)

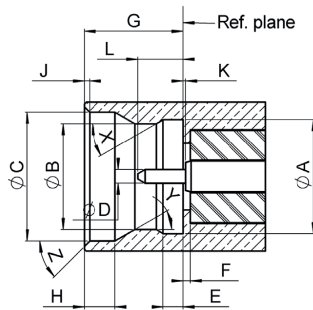

Dia A	3.18+/-0.02
Dia B (Full detent)	2.95+/-0.02
Dia B (Limited detent)	3.05+/-0.02
Dia C	3.59 +/-0.02
Dia D	0.38+/-0.02
E	0.56+/-0.03
F	0.2+/-0.025
G (Full detent)	2.79+/-0.02
G (Limited detent)	2.77+/-0.02
H	0.86+/-0.02
J	0.15+/-0.05
K	0.07+/-0.07
L	1.27+/-0.12
X	30°+/-0.5°
Y	30°+/-0.5°
Z	45° nom

### MALE CONNECTOR (Smooth bore)

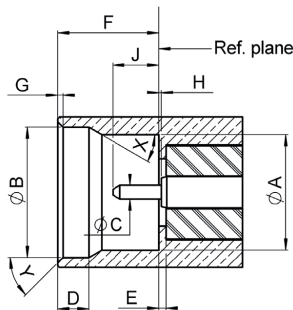

Dia A	3.18+/-0.02
Dia B	3.59+/-0.02
Dia C	0.38+/-0.02
D	0.86+/-0.02
E	0.2+/-0.025
F	2.79+/-0.02
G	0.15+/-0.05
H	0.07+/-0.07
J	1.27+/-0.12
X	30°+/-0.5°
Y	45° nom

### FEMALE CONNECTOR

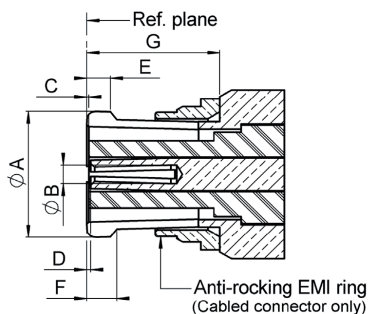

Dia A	3.275+/-0.025
Dia B	0.49+/-0.02
C	0.05+/-0.05
D	0.05+/-0.05
E	0.59+/-0.02
F	0.76+/-0.1
G	3.4+/-0.03

# CHARACTERISTICS

Test/characteristics	Values/remarks		
<b>ELECTRICAL CHARACTERISTICS</b>			
Impedance	50Ω		
Frequency range	DC - 40 GHz		
Typical V.S.W.R.	DC-12 GHz	12-26.5 GHz	26.5-40 GHz
• Straight styles	1.15	1.15	1.5
• Right angle styles	1.25	1.35	-
• Adapters	1.10	1.15	1.5
• Receptacles	1.30	-	-
Insertion loss (dB)	0.12 √F (F in GHz)		
Insulation resistance (MΩ)	5000		
Voltage rating (V.R.M.S.)	335		
Dielectric withstanding voltage (V.R.M.S.)	500		
RF leakage	-80 dB to 3 GHz -65 dB from 3 to 26.5 GHz		

## MECHANICAL CHARACTERISTICS

	smooth bore	limited detent	full detent
Mechanical endurance (matings)	1000	500	100
Engagement and separation force (N)	9 max. - 2.2 min.	45 max. - 9 min.	68 max. - 22 min.
Radial misalignment	± 0.25 mm (± .010")		
Axial misalignment	0, + 0.25 mm (0/ .010")		
Vibration	MIL-STD-202 method 204, test condition D		
Shock	MIL-STD-202 method 213, test condition I		
Thermal shock	MIL-STD-202 method 107, test condition B		
Cable retention (N) .047"	45		
.085"	200		
Contact captivation axial (N)	6.8		

## ENVIRONMENTAL CHARACTERISTICS

Operating temperature	-65°C / +165°C
-----------------------	----------------

## MATERIALS

Cable connector with female center contact	Beryllium copper
Cable connector with male center contact	
Bodies	Stainless steel
Soldering part	Brass
Receptacles, shrouds	Stainless steel
In series adapters	Beryllium copper
Center contacts	Beryllium copper
Center contacts for glass seal	Iron nickel cobalt sealing alloy
Insulators	PTFE

## PLATING

Cable connector with female center contact	Gold
Cable connector with male center contact	
Bodies	Passivated
Soldering part	Gold
Receptacles, shrouds	Passivated
In series adapters	Gold
Center contacts	Gold
Center contacts for glass seal	Gold

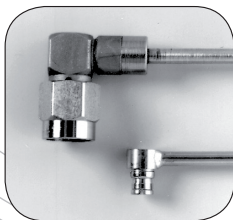

The SMP small size dramatically increases the packaging density of 40 GHz connections (see picture: SMA 2.9/SMP).

Standard packaging = 100 pieces.  
All dimensions are given in mm



Test/characteristics	Values/remarks
----------------------	----------------

## ELECTRICAL CHARACTERISTICS

Impedance	50Ω	
Frequency range	DC - 6 GHz (optimized) DC - 12.4 GHz (working range)	
Typical V.S.W.R. • Straight styles • Right angle styles • Receptacles	DC - 2.5 GHz 1.10 1.15 1.06	2.5 - 6 GHz 1.15 1.25 1.10
Insertion loss (dB)	0.12 √F (F in GHz)	
Insulation resistance (MΩ)	5000	
Voltage rating (V.R.M.S.)	750	
RF leakage	-55 dB 0 to 3 GHz -40 dB from 3 to 6 GHz	

## MECHANICAL CHARACTERISTICS

	smooth bore	limited detent	full detent
Mechanical endurance (matings)	100		
Engagement and separation force (N)	9 max. - 2.2 min.	45 max. - 9 min.	68 max. - 22 min.
Radial misalignment	± 0.25 mm		
Axial misalignment	0, +0.25 mm		
Moisture resistance	MIL-STD-202 method 106		
Cable retention (N) • .085" semi-rigid • 2/50/S • 2.6/50/S	200 35 58		
Contact captivation axial (N)	6.8		

## ENVIRONMENTAL CHARACTERISTICS

Operating temperature • Standard • Semi-rigid	-55°C / +125°C -55°C / +105°C
--	----------------------------------

## MATERIALS

Cable connectors	Beryllium copper or brass
Receptacles	Brass
In series adapters	Beryllium copper
Center contacts	Beryllium copper/brass
Insulators	PTFE/PEEK

## PLATING

Cable connectors	NPGR
Receptacles	NPGR
In series adapters	NPGR
Center contacts	NPGR

Standard packaging = 100 pieces.

All dimensions are given in mm

# PLUGS AND JACKS

## PLUG, SOLDER TYPE FOR SEMI-RIGID CABLES (with female center contact)

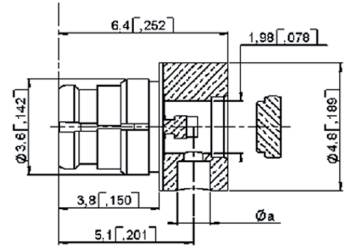
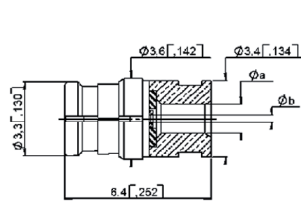
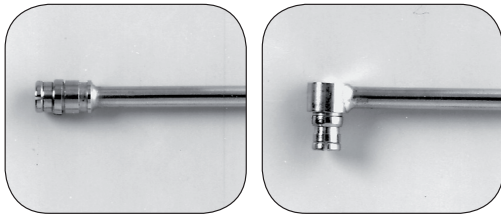
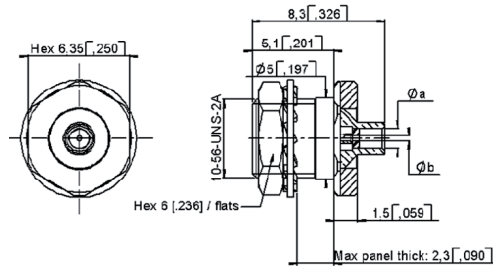

Fig. 1

Fig. 2

Cable group	Cable group dia.	Part number	Fig	Dimensions mm (inch)		Captive center contact	Orientation	Finish
				$\phi_a$	$\phi_b$			
.047" semi-rigid RG405	.047"	R222 051 000	1	1.30 (.050)	0.30 (.012)	no	straight	Gold
.047" semi-rigid RG405	.085"	R222 052 000		2.30 (.091)	0.53 (.021)			
.047" semi-rigid RG405	.047"	R222 151 000	2	1.30 (.050)		yes	right angle	
.047" semi-rigid RG405	.085"	R222 152 000		2.30 (.091)				

## BULKHEAD FEEDTHROUGH JACK, SOLDER TYPE FOR SEMI RIGID CABLES (with male center contact)



Cable group	Cable group dia.	Part number	Retention	Dimensions mm (inch)		Captive center contact	Panel drilling	Finish
				$\phi_a$	$\phi_b$			
RG405	.085"	R222 302 002	Full detent	2.30 (.091)	0.55 (.022)	no	P05	passivated + gold (soldering part)
		R222 302 302	Limited detent					
		R222 302 702	Smooth bore					

## TWO HOLE FLANGE JACK SOLDER TYPE FOR SEMI RIGID CABLES (with male center contact)

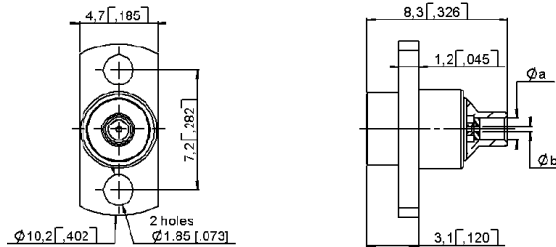
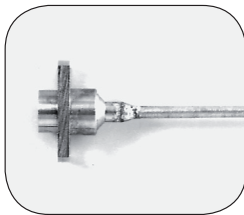

Cable group	Cable group dia.	Part number	Retention	Dimensions mm (inch)		Captive center contact	Panel drilling	Finish
				$\phi_a$	$\phi_b$			
RG405	.085"	R222 252 001	Full detent	2.30 (.091)	0.60 (.024)	no	P01	passivated + gold (soldering part)
		R222 252 301	Limited detent					
		R222 252 702	Smooth bore					

To download data sheets and assembly instructions, visit [www.radiall.com](http://www.radiall.com) & enter the part number in the Search box. **Bold** part numbers represent products typically in stock & available for immediate shipment. See page 8 and 9 for packaging information.

## PCB STRAIGHT RECEPTACLE, 4 SOLDER LEGS (with male center contact)

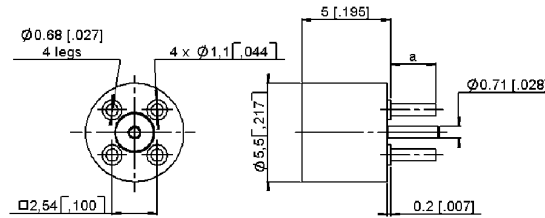
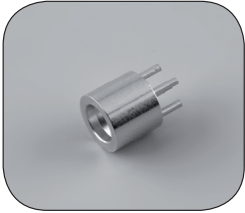

Part number	Retention	Dimensions mm (inch)	PCB mounting	Finish
		a		
R222 426 000	full detent	2.5 (.098)	P03	Gold
R222 426 300	limited detent			
R222 426 700	smooth bore			

## PCB STRAIGHT RECEPTACLE, SURFACE MOUNT (with male center contact)

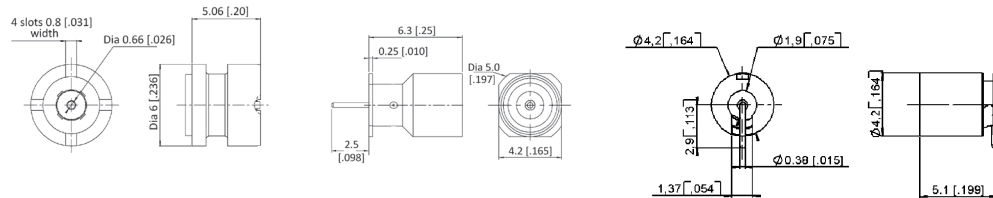

Fig. 1

Fig. 2

Fig. 3

Part number	Fig	Retention	Assembly instructions	Finish	Packaging
R222 408 350	1	limited detent	M04	Gold	Tape & reel - 500 pieces
R222 408 750		smooth bore			Tray 100 pieces
R222 409 030	2	full detent	M05		100 pieces
R222 508 000	3	full detent	M03	Passivated + gold (soldering area)	Tape & reel 500 pieces
R222 508 300		limited detent			
R222 508 700		smooth bore			
R222 508 722		catcher's mitt			

## PCB RECEPTACLE, EDGE CARD MOUNT (with male center contact)

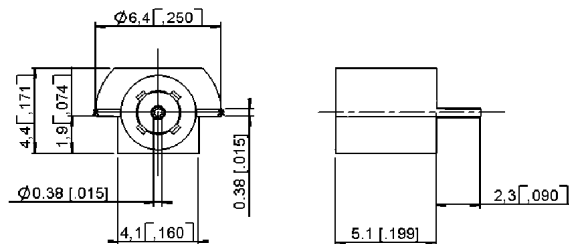
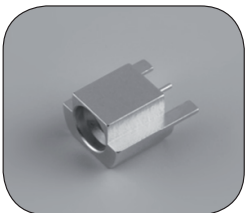

Part number	Retention	Assembly instructions	Finish	Packaging
R222 423 023	full detent	M01	Gold	Tape & reel - 100 pieces
R222 423 320	limited detent			
R222 423 720	smooth bore			

To download data sheets and assembly instructions, visit [www.radiall.com](http://www.radiall.com) & enter the part number in the Search box. **Bold** part numbers represent products typically in stock & available for immediate shipment. See page 8 and 9 for packaging information.

# RECEPTACLES

## PCB STRAIGHT RECEPTACLE, PIN & PASTE MOUNT (with male center contact)

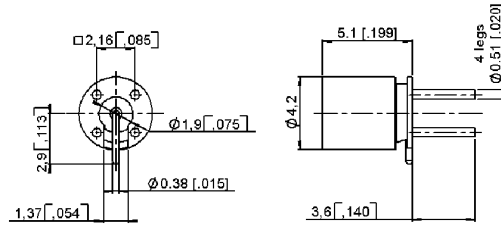

Part number	Retention	Assembly instructions	Finish
R222 428 000	Full detent	M02	passivated + gold (soldering part)
R222 428 300	Limited detent		
R222 428 700	Smooth bore		

## PCB RIGHT ANGLE RECEPTACLE, 4 SOLDER LEGS (with male center contact)

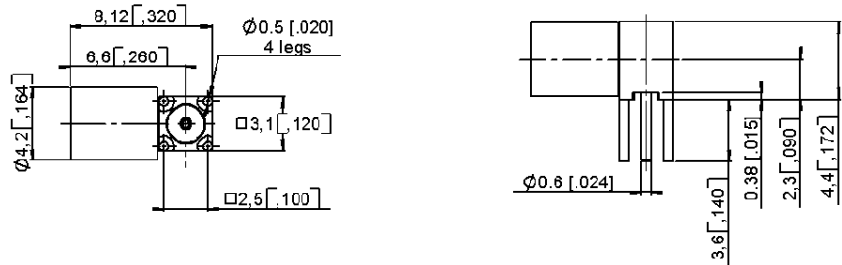

Part number	Retention	PCB mounting	Finish
R222 680 000	Full detent	P04	passivated + gold (soldering part)
R222 680 300	Limited detent		
R222 680 700	Smooth bore		

## SQUARE FLANGE EXTENDED DIELECTRIC RECEPTACLE

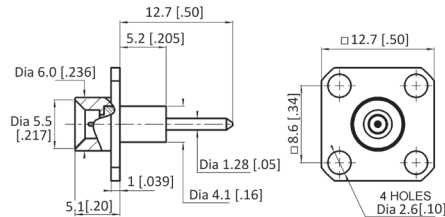

Part number	Retention	Captive center contact	Panel drilling	Finish
R222 414 701	Smooth bore	yes	P07	passivated

## THREAD-IN RECEPTACLE (with male center contact)

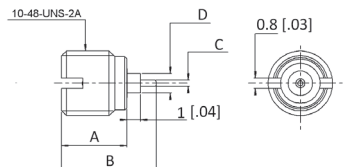
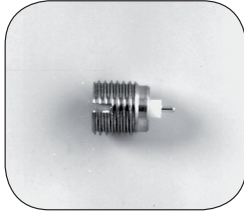

Part number	Retention	Dimensions mm (inch)				Finish
		A	B	C	D	
R222 561 001	Full detent	4.8 (.191)	7.1 (.278)	0.46 (.018)	1.45 (.057)	passivated
R222 561 301	Limited detent					
R222 561 701	Smooth bore					
R222 561 331	Limited detent	6.2 (.243)	8.3 (.326) adjustable pin +/-0.5	1.0 (.04)	0.3 (.012)	

## PANEL STRAIGHT HERMETIC RECEPTACLE, SOLDER MOUNT

(with male center contact)

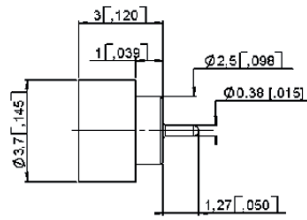
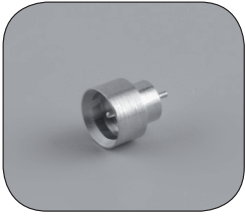

Fig. 1

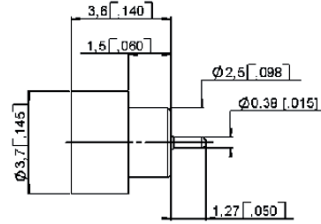
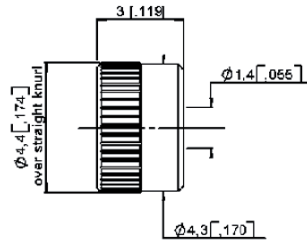
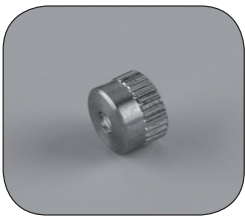

Fig. 2

Part number	Retention	Fig	Finish	Note
R222 645 020	Full detent	1	gold	Short body 1 mm glass seal
R222 645 300	Limited detent	2		1.5 mm glass seal
R222 645 700	Smooth bore			

## PANEL SHROUD, PRESS-IN MOUNT (no center contact)



Part number	Retention	Panel drilling	Finish
R222 402 021	Full detent	P06	passivated
R222 402 321	Limited detent		
R222 402 721	Smooth bore		

This shroud is designed to be used with hermetic glass seal R280 752 000 (see page 3-14)

## PANEL SHROUD, 2 HOLES FLANGE MOUNT (no center contact)

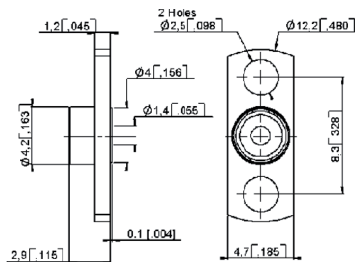
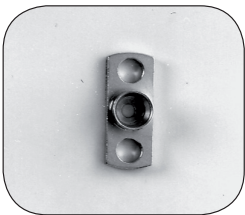

Part number	Retention	Panel drilling	Finish
R222 450 001	Full detent	P02	passivated

This shroud is designed to be used with hermetic glass seal R280 752 000 (see page 3-14)

To download data sheets and assembly instructions, visit [www.radiall.com](http://www.radiall.com) & enter the part number in the Search box.

**Bold** part numbers represent products typically in stock & available for immediate shipment.

See page 8 and 9 for packaging information.

# PANEL SHROUD, GLASS BEAD AND ADAPTERS

## PANEL SHROUD, THREAD-IN MOUNT (no center contact)

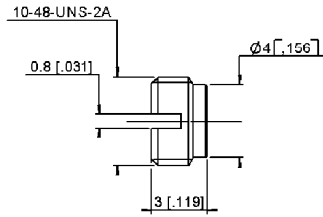

Part number	Retention	Finish
R222 550 001	Full detent	passivated
R222 550 301	Limited detent	
R222 550 701	Smooth bore	

This shroud is designed to be used with hermetic glass seal R280 752 000 (see page 3-14)

## HERMETIC GLASS BEAD

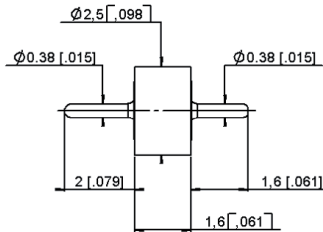

Part number
R280 752 000

This hermetic glass bead is designed to be used with the above shrouds.

## IN SERIES ADAPTERS (female to female center contact)

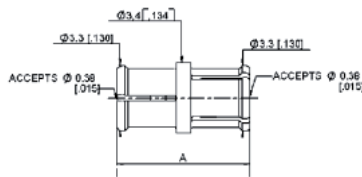
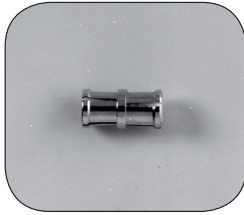

Fig. 1

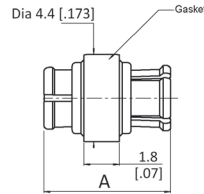

Fig. 2

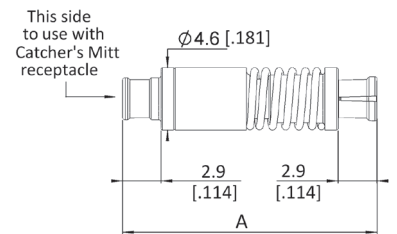

Fig. 3

Part number	Fig	Dimensions A mm (inch)	Type	Finish
R222 705 000	1	6.45 (.254)	Fixed length	gold
R222 705 200		5.7 (.224)		
R222 705 220		10.3 (.405)		
R222 705 230		10.0 (.395)		
R222 705 400	2	6.45 (.254)	Fixed length with sealing gasket	
R222 723 100	3	min 33.68 (1.326) max 34.85 (1.372)	Spring loaded axial travel 1.17mm (.046")	
R222 723 110		min 11.71 (.461) max 12.88 (.507)		
R222 723 120		min 17.65 (.695) max 18.82 (.741)		

Note: use removal tool R282 918 100 or R282 918 120 with SMP in series adapters  
Contact us for self aligning options in board to board or module to module applications.

# ADAPTERS

## BETWEEN SERIES ADAPTERS

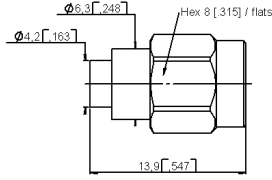
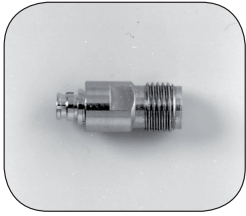

Fig. 1

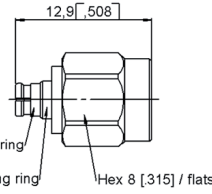

Fig. 2

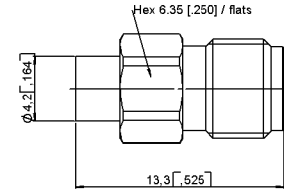

Fig. 3

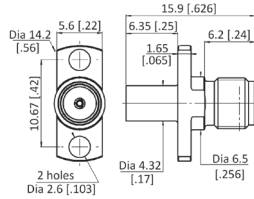

Fig. 4

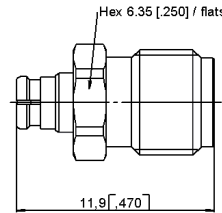

Fig. 5

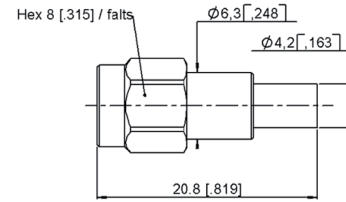

Fig. 6

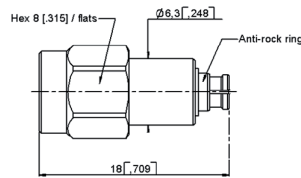

Fig. 7

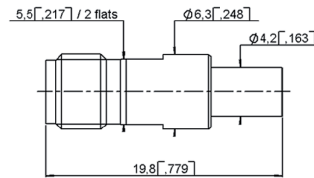

Fig. 8

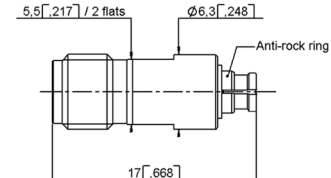
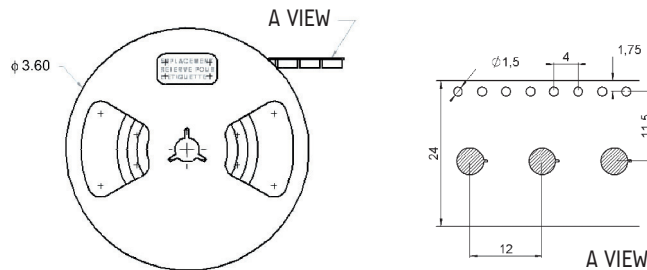

Fig. 9

Part number	Fig	Description	Captive center contact	Finish	Packaging
R191 841 001	1	SMA male/SMP male full detent	Yes	passivated	100
R191 842 002	2	SMA male/SMP female		passivated/gold	
R191 843 001	3	SMA female/SMP male full detent		passivated	
R191 843 401	4	SMA female/SMP male smooth bore		passivated	unit
R191 843 421		SMA female/SMP male full detent		passivated	
R191 844 002	5	SMA female/SMP female		passivated/gold	100
R191 966 001	6	SMA 2.9 male/SMP male full detent		passivated	
R191 967 002	7	SMA 2.9 male/SMP female		passivated/gold	
R191 968 001	8	SMA 2.9 female/SMP male full detent		passivated	
R191 969 002	9	SMA 2.9 female/SMP female	passivated/gold		



## PACKAGING

Connectors	Packaging
R222 508 000	Tape & reel 500 pieces
R222 508 300	
R222 508 700	
R222 508 722	

To download data sheets and assembly instructions, visit [www.radiall.com](http://www.radiall.com) & enter the part number in the Search box. **Bold** part numbers represent products typically in stock & available for immediate shipment. See page 8 and 9 for packaging information.

# ASSEMBLY INSTRUCTIONS

## M01

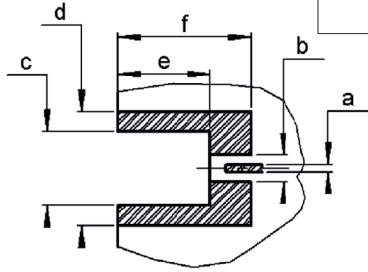

Connectors	
R222 423 023	R222 423 720
R222 423 320	

PCB mounting pattern

a	0.48
b	1.5
c	4.18 - 4.32
d	6.5
e	4.95 - 5.45
f	7.52

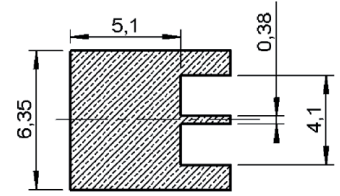

Shadow of receptacle for video camera

## M02

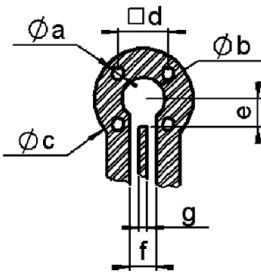

Connectors	
R222 428 000	R222 428 700
R222 428 300	

PCB mounting pattern

a	0.63
b	1.90
c	4.45 min.
d	2.16
e	2.29 max.
f	1.52 max.
g	0.45 min.

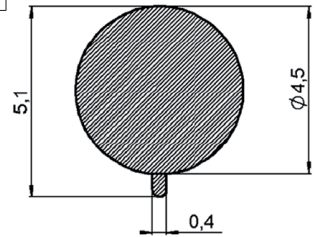

Shadow of receptacle for video camera

## M03

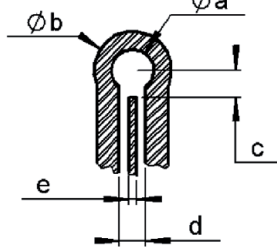

Connectors	
R222 508 000	R222 508 700
R222 508 300	R222 508 722

PCB mounting pattern

a	1.91
b	4.45 min.
c	2.29 min.
d	1.52
e	0.38 max.

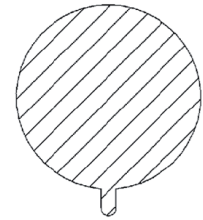

Shadow of receptacle for video camera

## M04

PCB mounting pattern

Connectors	
R222 408 350	R222 408 750

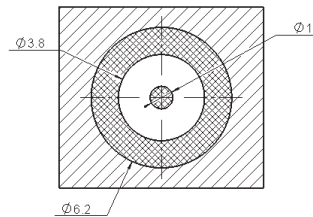

## M05

PCB mounting pattern

Connectors	
R222 409 030	

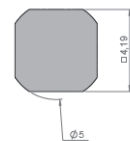
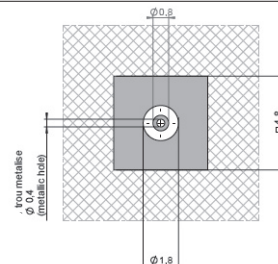

Shadow for video camera



## STRAIGHT PLUG, FULL CRIMP TYPE FOR FLEXIBLE CABLE

(female center contact)

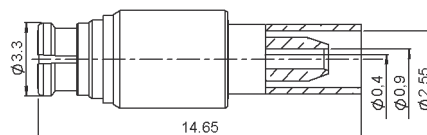

Cable group	Cable group dia.	Part number	Captive center contact
RG178/RG196	2/50/S	R222 900 100	yes

## STRAIGHT PLUG, SOLDER TYPE (female center contact)

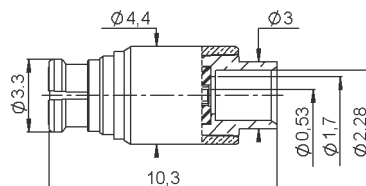

Cable group	Cable group dia.	Part number	Captive center contact
RG405	.085"	R222 900 200	no

## RIGHT ANGLE PLUGS, CRIMP TYPE FOR FLEXIBLE CABLE

(female center contact)

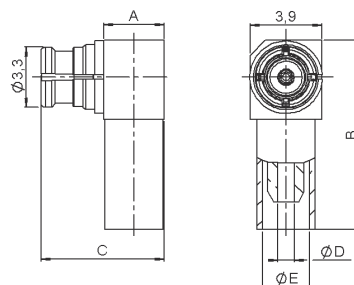
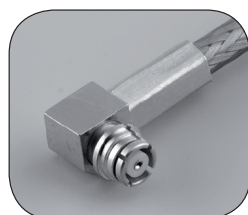

Cable group	Cable group dia.	Part number	Dimensions (mm)					Captive center contact
			A	B	C	D	E	
RG178/RG196	2/50/S	R222 900 310	3.3	10.3	6.7	0.9	2.55	yes
RD316	2.6/50/D	R222 900 330	3.7	13.3	7.4	1.58	3.50	

## RIGHT ANGLE PLUG, SOLDER TYPE (female center contact)

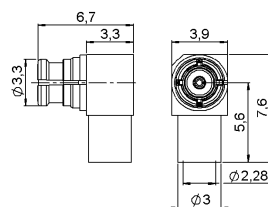
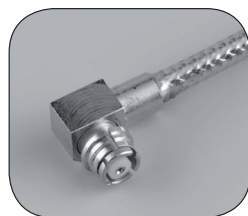

Cable group	Cable group dia.	Part number	Captive center contact
RG405	.085"	R222 900 340	yes

To download data sheets and assembly instructions, visit [www.radiall.com](http://www.radiall.com) & enter the part number in the Search box.  
**Bold** part numbers represent products typically in stock & available for immediate shipment.  
 See page 8 and 9 for packaging information.

# JACK AND RECEPTACLES

## STRAIGHT BULKHEAD JACK, FULL CRIMP TYPE (male center contact)

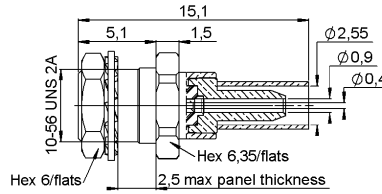

Cable group	Cable group dia.	Part number	Retention	Captive center contact	Panel drilling
RG178/RG196	2/50/S	R222 920 300	Limited detent	yes	P05

## STRAIGHT SMT RECEPTACLE (male center contact)

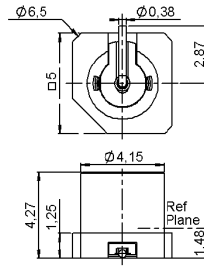

Part number	Retention	Captive center contact	Assembly instructions	Packaging
R222 941 100	Full detent	yes	M01	Tape & reel 500 pieces
R222 941 300	Limited detent			
R222 941 700	Smooth bore			

## STRAIGHT RECEPTACLES, PIN & PASTE MOUNT (male center contact)

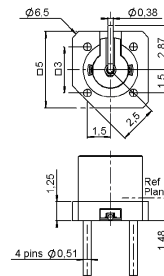
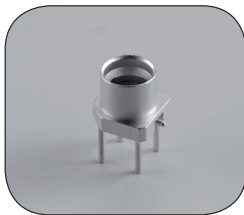

Part number	Retention	Captive center contact	Assembly instructions	Packaging
R222 940 100	Full detent	yes	M01	Tape & reel 500 pieces
R222 940 300	Limited detent			
R222 940 700	Smooth bore			

## IN SERIES ADAPTER (female to female center contact)

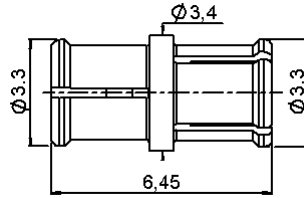
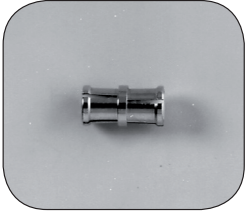

Part number	Finish	Packaging
R222 970 000	NPGR	100 pieces

## MEASUREMENT PCB WITH SMT RECEPTACLE

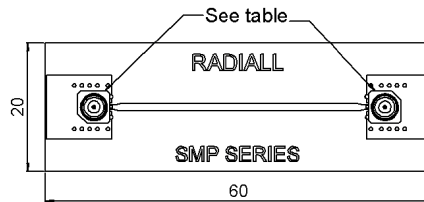
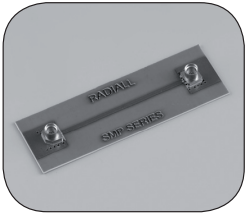

Part number	Packaging	Connector
R222 995 320	Unit	2 x R222 941 300

## PACKAGING

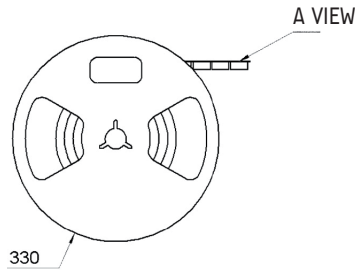

Part number	Packaging
R222 940 100	Tape & reel 500 pieces
R222 940 300	
R222 940 700	
R222 941 100	
R222 941 300	
R222 941 700	

### AIR SUNCTION

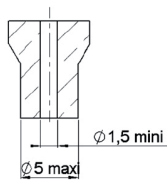

Connectors
R222 940 100
R222 940 300
R222 940 700

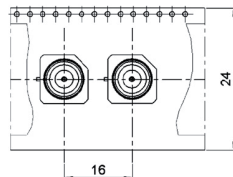

Connectors
R222 941 100
R222 941 300
R222 941 700

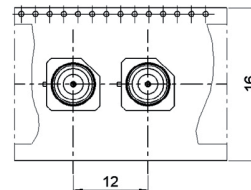

A VIEW

To download data sheets and assembly instructions, visit [www.radiall.com](http://www.radiall.com) & enter the part number in the Search box.  
**Bold part numbers** represent products typically in stock & available for immediate shipment.  
 See page 8 and 9 for packaging information.

**PANEL DRILLING**

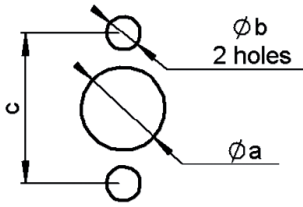

	P01	P02
a	4.7 - 4.8 (.185 - .189)	4.05 - 4.15 (.159 - .163)
b	1.8 - 1.9 (.071 - .075)	2.5 - 2.6 (.098 - .102)
c	7.11 - 7.21 (.280 - .284)	8.28 - 8.38 (.326 - .330)

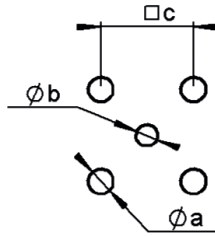

	P03	P04	P07
a	0.94 - 0.98 (.037 - .039)	0.71 - 0.81 (.028 - .032)	2.7 - 2.8 (.106 - .110)
b	0.79 - 0.86 (.031 - .034)	0.79 - 0.86 (.031 - .034)	4.1 - 4.15 (.161 - .163)
c	2.49 - 2.59 (.098 - .102)	2.49 - 2.59 (.098 - .102)	8.59 - 8.69 (.338 - .342)

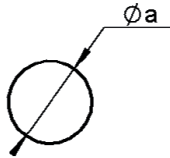

	P05	P06
a	5.20 - 5.30 (.205 - .209)	4.37 - 4.39 (.172 - .173)

**ASSEMBLY INSTRUCTIONS**

**M01**

**SOLDERING PATTERN**

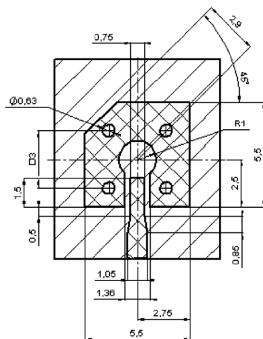

Connectors
R222 940 100
R222 940 300
R222 940 700

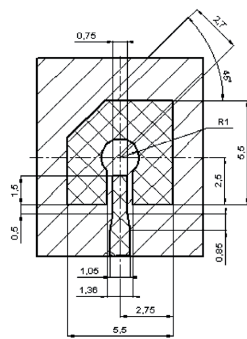

Connectors
R222 941 100
R222 941 300
R222 941 700

**VIDEO SHADOW**

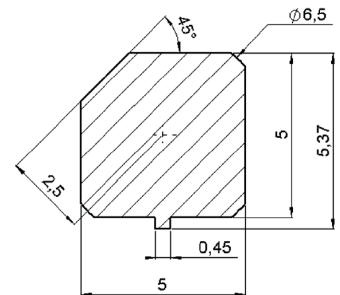

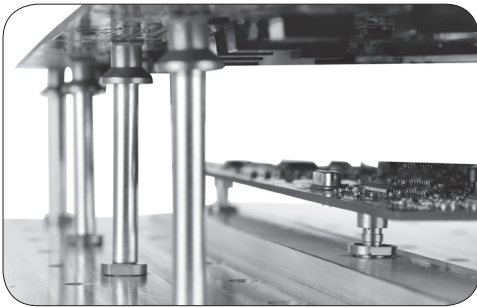
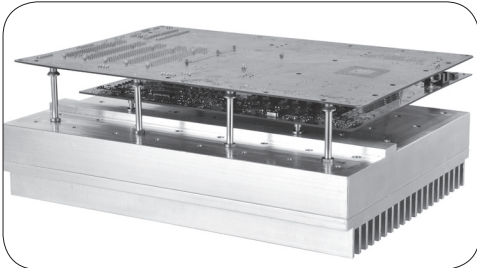

50Ω

DC - 6 GHz

## GENERAL

- Microminiature coaxial connectors
- Power up to 300 Watts
- Board to board distance misalignment of at least .078" (2.0 mm)
- Tilt (radial misalignment): 3° minimum
- 1.2 max VSWR at DC-3 GHz

## APPLICATIONS

- Broadcast
- RF components (filters, amplifiers, ...)
- Wireless communications

## The cost-effective solution for maximum mechanical misalignment

Of the several RF connectors available for interconnections in wireless remote radio heads, repeaters, base stations, GPS devices, and similar applications, the board to board style connector is growing in popularity. The product line has evolved from accommodating limited misalignment to offering the widest tolerances available.

SMP-MAX is introduced by RADIALl to provide larger misalignment tolerances than the early version board to board connectors like SMP or SMP-spring while offering lower cost.

Featuring an optimized interface, SMP-MAX can work up to 6 GHz board to board distance misalignment at least 2.0 mm and radial misalignment 3° minimum.

The SMP-MAX series offers 2 levels of retention provided by the receptacles:

- Slide-on, for the lowest retention
- Snap-on, for a positive locking with a retention

A complete SMP-MAX board to board system is made of 3 parts:

SMP-MAX Slide-on receptacle	SMP-MAX In series adapter	SMP-MAX Snap-on receptacle
		

Many other custom configurations are available. Larger distance misalignment and larger tilt versions are also available.

# CHARACTERISTICS

Test/characteristics	Values/remarks		
<b>ELECTRICAL CHARACTERISTICS</b>			
Impedance	50Ω		
Frequency	DC - 6 GHz		
Typical V.S.W.R. (Board to Board connection)	Misalignment	DC - 3 GHz	3-6 GHz
	Radial 0°, Axial 0 mm	< 1.15	< 1.25
	Radial 0°, Axial +/- 1 mm	< 1.20	< 1.35
	Radial 3°, Axial 0 mm	< 1.15	< 1.25
	Radial 3°, Axial +/- 1 mm	< 1.20	< 1.35
Insertion loss (Board to Board connection)	Misalignment	DC - 3 GHz	3-6 GHz
	Radial 0°, Axial 0 mm	0.10	0.15
	Radial 0°, Axial +/- 1 mm	0.12	0.25
	Radial 3°, Axial 0 mm	0.10	0.15
	Radial 3°, Axial +/- 1 mm	0.12	0.25
Insulation resistance	5000 MΩ		
Center contact resistance	< 3 mΩ		
Outer contact resistance	< 1.5 mΩ		
Working voltage	330 VRMS		
Dielectric withstanding voltage	1000 VRMS		
Power handling (typical)	> 300W @ 2.7 GHz, 25°C > 200W @ 2.7 GHz, 85°C		
RF leakage	-70dB to 3 GHz, axial misalignment 0mm		

## MECHANICAL CHARACTERISTICS

Mating cycles	100 cycles	
Engagement force	Slide-on	Snap-on
	< 14 N	< 45 N
Disengagement force	< 9 N	> 9, < 45 N
Center contact retention force	> 7 N	
Minimum distance between PCB	13 mm	
Radial misalignment tolerance	3°min	
Axial misalignment tolerance	2.0 mm	
	Larger axial misalignment version available	

## ENVIRONMENTAL CHARACTERISTICS

Temperature range	-55°C / +165°C
Thermal shock	MIL-STD-202, method 107, condition B
Vibration	MIL-STD-202, method 204, condition B
Shock	MIL-STD-202, method 213, condition A
Corrosion salt spray	MIL-STD-202, method 101, condition B
Moisture resistance	MIL-STD-202, method 106

## MATERIALS

Body	Brass/Beryllium copper
Male center contact	Brass
Female center contact	Beryllium copper
Gasket	Silicon rubber
Insulator	PTFE/PEEK

## PLATING

Body	NPGR/BBR
Male center contact	NPGR
Female center contact	NPGR

Packaging = 100 pieces box / 500 pieces reel.

All dimensions are given in mm

## BULKHEAD STRAIGHT SLIDE-ON MALE JACKS FOR CABLES

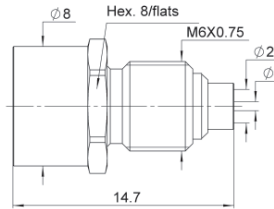

Fig. 1

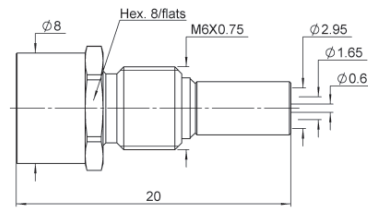
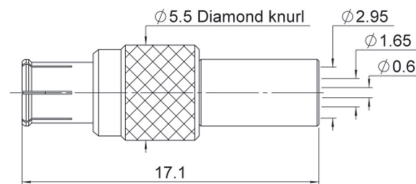

Fig. 2

Cable group	Cable group dia.	Part number	Fig	Captive center contact	Panel drilling	Packaging
RG405	.085"	R222 M20 700	1	yes	P01	Bulk 100 pieces
RG174/RG316	2.6/50/S	R222 M20 710	2			

## STRAIGHT FEMALE PLUG FOR FLEXIBLE CABLE



Cable group	Cable group dia.	Part number	Captive center contact	Packaging
RG174/RG316	2.6/50/S	R222 M80 400	yes	Bulk 100 pieces

## RIGHT ANGLE FEMALE PLUG FOR FLEXIBLE CABLE

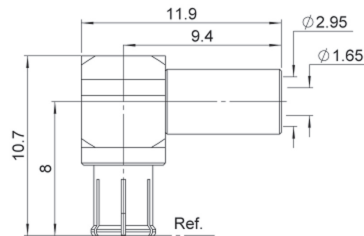

Cable group	Cable group dia.	Part number	Captive center contact	Packaging
RG174/RG316	2.6/50/S	R222 M80 500	yes	Bulk 100 pieces

To download data sheets and assembly instructions, visit [www.radiall.com](http://www.radiall.com) & enter the part number in the Search box. **Bold** part numbers represent products typically in stock & available for immediate shipment. See page 8 and 9 for packaging information.

# RECEPTACLES

## STRAIGHT SLIDE-ON MALE RECEPTACLES

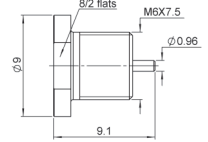
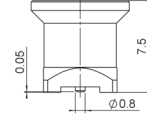
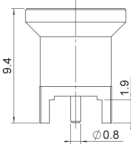
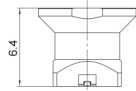
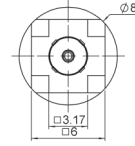
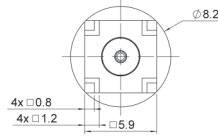
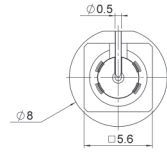

Fig. 1

Fig. 2

Fig. 3

Fig. 4

Part number	Fig	Captive center contact	Panel drilling	Packaging	Note
R222 M00 700	1	yes		Tape & reel 500 pieces	SMT
R222 M00 720	2		P02	Bulk 100 pieces	Solder legs
R222 M00 740	3			Tape & reel 500 pieces	SMT
R222 M10 700	4		P01	Bulk 100 pieces	Screw on

## STRAIGHT SNAP-ON MALE RECEPTACLES

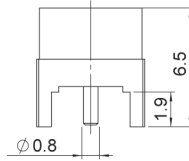
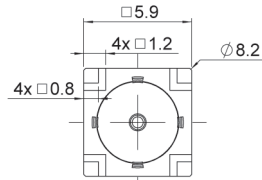

Fig. 1

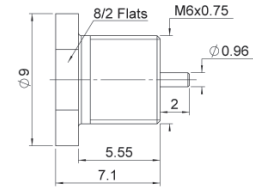

Fig. 2

Part number	Fig	Captive center contact	Panel drilling	Packaging	Note
R222 M00 080	1	yes	P02	Bulk 100 pieces	Solder legs
R222 M10 000	2		P01		Screw on

To download data sheets and assembly instructions, visit [www.radiall.com](http://www.radiall.com) & enter the part number in the Search box. **Bold** part numbers represent products typically in stock & available for immediate shipment. See page 8 and 9 for packaging information.



## IN-SERIES BOARD TO BOARD ADAPTERS



Part number	Lenght L (mm)	Series	Packaging
R222 M40 010	9.5	SMP-MAX female / SMP-MAX female	Bulk 100 pieces
R222 M40 050	25.3		

## BETWEEN-SERIES BOARD TO BOARD ADAPTERS

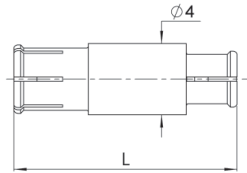

Part number	Lenght L (mm)	Series	Packaging
R191 996 110	12.6	SMP-MAX female / SMP female	Bulk 100 pieces
R191 996 130	8.9		
R191 560 000	7.5	SMP-MAX female / MMBX male snap	

## BETWEEN-SERIES ADAPTERS

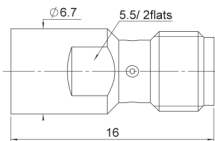

Fig. 1

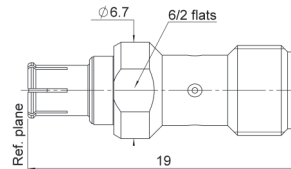

Fig. 2

Part number	Fig	Series	Packaging
R191 552 000	1	SMP-MAX male / SMA female	Unit
R191 553 000	2	SMP-MAX female / SMA female	

To download data sheets and assembly instructions, visit [www.radiall.com](http://www.radiall.com) & enter the part number in the Search box. **Bold** part numbers represent products typically in stock & available for immediate shipment. See page 8 and 9 for packaging information.

**PANEL DRILLING**

P01

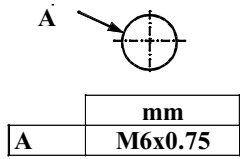

P02

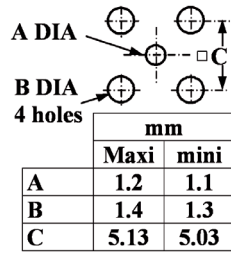



AEROSPACE



AUTOMOTIVE



DEFENSE



INDUSTRIAL



INSTRUMENTATION



MEDICAL



SPACE



TELECOM

## EUROPE

### France - RADIALL S.A.

101, Rue Ph. Hoffmann  
93116 ROSNY sous BOIS (Paris)  
Tel.: +33 1 49 35 35 35 - Fax: +33 1 48 54 63 63  
E-Mail: info@radiall.com

### Finland - RADIALL SF

P.O. Box 202 - 90101 OULU  
Tel.: +358 407 522 412  
E-Mail: infofi@radiall.com

### Germany - RADIALL GmbH

Carl-Zeiss Str. 10 Postfach 200143  
D63307 - RÖDERMARK (Frankfurt)  
Tel.: +49 60 74 91 07 0 - Fax: +49 60 74 91 07 70  
E-Mail: infode@radiall.com

### Italy - RADIALL Elettronica S.R.L.

Via Concordia, 5 - 20090 ASSAGO MILANO  
Tel.: +39 02 48 85 121 - Fax: +39 02 48 84 30 18  
E-Mail: infoit@radiall.com  
Regional office: Roma

### Netherlands - RADIALL B.V.

Hogebrinkerweg 15b - 3871 KM HOEVELAKEN  
Tel.: +31 33 253 40 09 - Fax: +31 33 253 45 12  
E-Mail: infofl@radiall.com

### Sweden - RADIALL A.B.

Sjöängsvägen 2 - SE-192 72 SOLLENTUNA (Stockholm)  
Tel.: +46 844 434 10 - Fax: +46 875 449 16  
E-Mail: infose@radiall.com

### U.K. - RADIALL Ltd.

Ground Floor, 6 The Grand Union Office Park,  
Packet Boat Lane  
UXBRIDGE Middlesex UB8 2GH (London)  
Tel.: +44 1895 425 000 - Fax: +44 1895 425 010  
E-Mail: infouk@radiall.com

## NORTH AMERICA

### USA - RADIALL USA, Inc.

6825 West Galveston Street  
CHANDLER, Arizona 85226  
Tel.: +1 480 682 9400 - Fax: +1 480 682 9403  
E-Mail: infousa@radiall.com

## ASIA

### China - SHANGHAI RADIALL Electronic Co., Ltd.

N° 390 Yong He Road 200072 - SHANGHAI  
Tel.: +86 21 66 52 37 88 - Fax: +86 21 66 52 11 77  
E-Mail: infosh@radiall.com

### Japan - NIHON RADIALL

Shibuya-ku Ebisu 1-5-2, Kougetsu Bldg 405  
TOKYO 150-0013  
Tel.: +81 3 3440 6241 - Fax: +81 3 3440 6242  
E-Mail: infojp@radiall.com

### Hong Kong - RADIALL Electronics Ltd.

Flat D, 6/F, Ford Glory Plaza,  
37-39 Wing Hong Street  
Cheung Sha Wan  
KOWLOON HONG KONG  
Tel: +852-2959-3833 - Fax: +852-2959-2636  
E-Mail: infohk@radiall.com

### India - RADIALL India Pvt. Ltd.

25 D, II Phase, Peenya Industrial Area  
BANGALORE 560058  
Tel.: +91 80 83 95 271 - Fax: +91 80 83 97 228  
E-Mail: infoin@radiall.com

## ALSO REPRESENTED IN

Australia	Hungary	Poland
Austria	Indonesia	Russia
Belgium	Israel	Singapore
Brazil	Korea	Spain
Czech Republic	Latvia	Switzerland
Denmark	Lithuania	Taiwan
Estonia	Malaysia	Thailand
Greece	Norway	Vietnam
	Philippines	South Africa

For the above countries, please contact the local agent or RADIALL at info@radiall.com

