



Schultz Resort Rod & Gun Club
W146 S8106 Schultz Ln.
Muskego, WI 53150

Table of Contents

Welcome	Page 2
Match Schedule	Page 3
Match Staff	Page 3
Area Map:	Page 4
Match Hotel:	Page 4
Match Sponsors	Page 5
Match Briefing	Page 10
Stage CoF's	Page 13
Results	Page 22
Staff Picture & Final Word	Page 29

Greetings, Fellow Shooters!

Welcome to the 12th Annual Wisconsin IDPA Championship.

It is a great honor to serve once again as your Match Director. For those attending the Wisconsin State IDPA Championship for the first time, welcome! For those that have shot one of our matches previously, welcome back! I'm confident that we will challenge your shooting skills and that your experience today will keep you coming back in following years.

As we all know, matches like this only happen through the unselfish dedication from every one of our volunteers. Please take a moment to thank our Safety Officers and Staff when you see them on the range today.

We also could not have a quality match without quality sponsorship! As you tour the prize table today, take note of the businesses that are supporting you both as an IDPA shooter and as a firearm owner. Be sure to let them know that you saw them at the 2012 Wisconsin IDPA State Championship and to thank them for their support.

Enjoy the match and best of luck to you!

Tom Ropers
Match Director

Match Schedule

07:30 Registration Opens
08:30 Competitor Safety Briefing
09:00 Shooting Begins
12:00 Lunch break
13:00 Shooting Resumes
15:00 Match End
15:15 Prize Table
15:45 Awards Ceremony

Match Staff

Match Director:	Tom Ropers
Registration:	Jan Ropers, Nancy Trepanier
Scoring:	Kea Trepanier, Julie Williams
Equipment Check/Chrono:	Mike Williams
Food Services:	Kellie Ropers
Wisconsin Area Coordinator:	Craig Dille
Match Book/CoF Designer:	Tom Ropers
Match Logo Design:	Dave Gares
Chief Safety Officer:	Craig Dille
Safety Officers/Scorekeepers:	John Alexander, Ron Bard, Don Chudnow, Mike Esser, Ray Feger, Tom Grant, William Henry, Mike Herro, Thomas Huffine, Adam Maxwell, Dave Nason, Colin Patel, Neil Pilling, Michael Ramps, Jeff Ropers, Patrick Scalise, Audrey Schmeckle, Ed Sendele, Perry Stevens, Jon Thompson, Gay Trepanier, Steve Van Dis
Misc:	Kimberly Hoffman, Kellie Ropers
Prize Table:	Steve Van Dis ,Tom Grant, Tom Ropers
Match Photography:	Dave Gares

Please take a moment to thank your Safety Officers, Scorekeepers, and Staff. They're working hard today!

Area Map

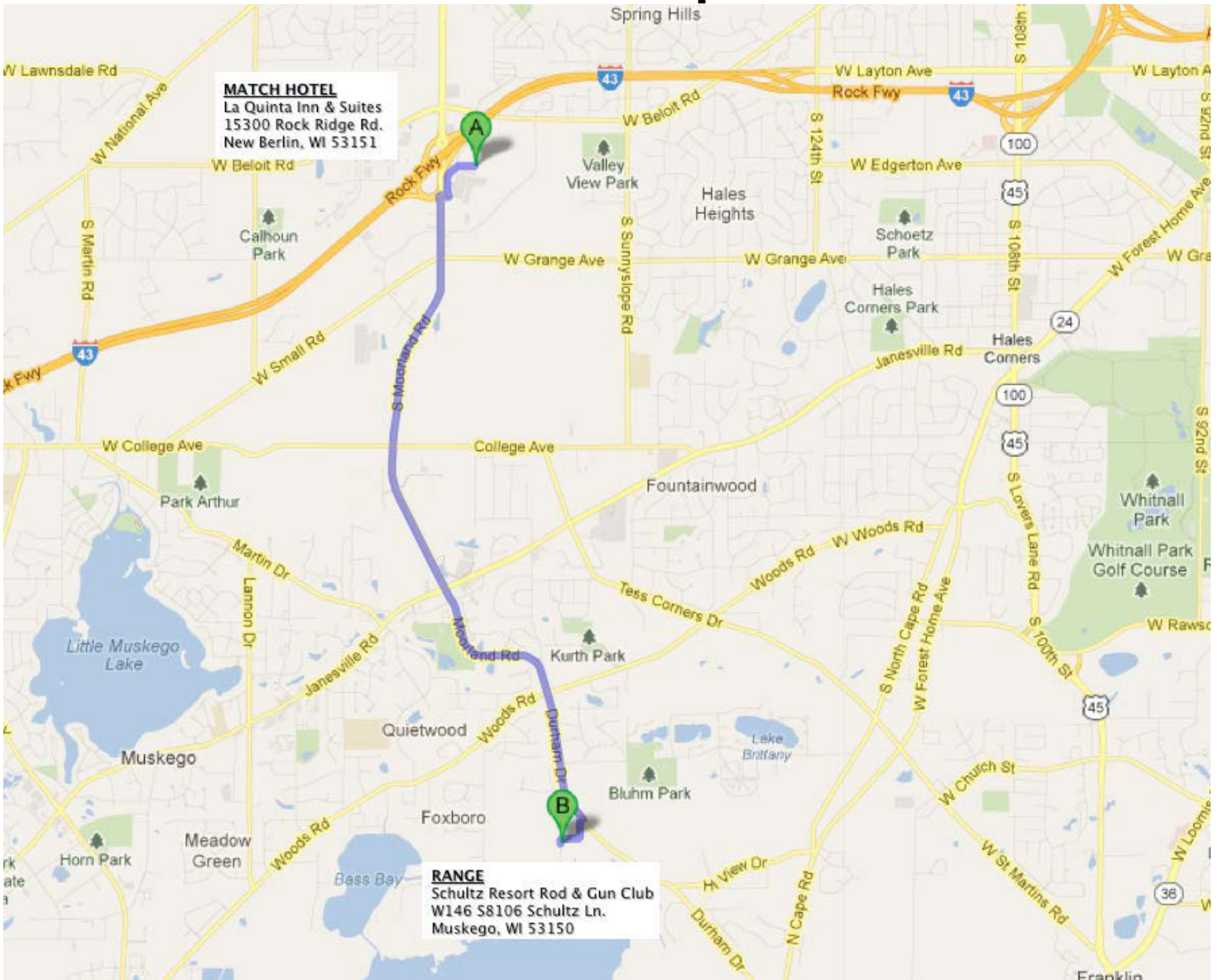

Match Hotel

La Quinta Inn & Suites, Milwaukee SW
15300 Rock Ridge Rd.
New Berlin, WI 53151
(262)717-0900

Match Sponsors

Our match could not function without the generous support of our sponsors. **Please thank them with your patronage.**

The First Name In American Firearms
**SPRINGFIELD
ARMORY USA®**
www.springfield-armory.com



Panteao Productions
www.panteaoproductions.com
Make Ready With The Experts.



www.gauntletwarbirds.com
Chicagoland Warbird, Aerobatic And Tailwheel Training Center



www.johnsonoutdoors.com
The Spirit Of Adventure



www.stagarms.com
Worldwide Leader In Manufacturing



www.benchmade.com
It's Not Just A Knife... It's A Benchmade



When Your Life Depends On It, You Can Depend On Cleveland's Holsters



www.hornady.com
Accurate. Deadly. Dependable.



www.starlinebrass.com
Makers of America's Finest Handgun Brass

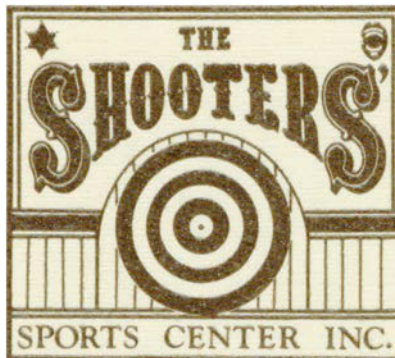

The Shooters' Sports Center, Inc.
Racine, WI



www.wilsoncombat.com
Creators of the World's Finest Firearms & Accessories

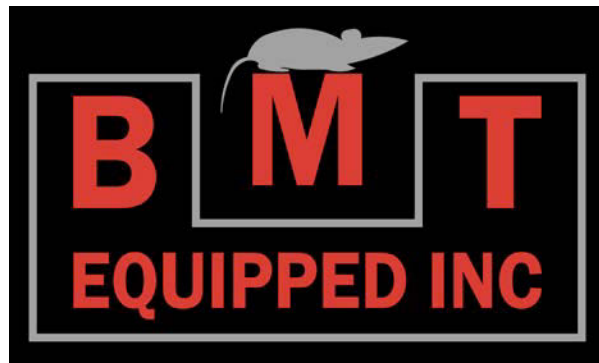

www.bmtequipped.com



www.crossbreedholsters.com
Will you be ready?

UniqueTek.com
UniqueTek.com™
Products for Shooting, Reloading & Competitive Marksmen



www.zerobullets.com



www.keeprs.com

Serving the public safety industry since 1998



www.leeprecision.com
The Innovative Leader



www.brownells.com



sport.birchwoodcasey.com
We've kept you shooting for more than 50 years.



www.riteintherain.com

GUN STORAGE SOLUTIONS

www.storemoreguns.com



www.versacarry.com
Clip. Click. Conceal.

Match Briefing

THESE POLICIES ARE JUST AS IMPORTANT AS THE RULES. YOU ARE EXPECTED TO READ AND UNDERSTAND ALL THE CONTENTS OF THIS MATCH PUBLICATION. QUESTIONS WILL BE ANSWERED AT THE SAFETY BRIEFING.

We will be shooting 9 stages in single flight, one day format. Most of the staff will have already shot on Friday. This will be a lost brass match, all brass will go to the range staff. If you have a scoring dispute, please allow the range staff to continue running their stage and seek out the Chief Safety Officer, Craig Dilley, or the Match Director, Tom Ropers. If it is a target scoring issue, the target will be pulled and replaced with a new one. The Match Director will have the final word in any dispute.

RULES: The match rules are found in the IDPA Rulebook, dated April 15, 2005, and the IDPA Rules Addendum, dated July 6, 2010. There are additional rules contained in this briefing.

OBEY YOUR S.O.'s: Safety Officers are here to assist you in completing a safe shooting contest. If there are indications that you are becoming unsafe, attempts will be made to warn you. If your gun handling has become unsafe, you will be stopped. When you hear STOP! You should immediately STOP with the gun muzzle pointing safely down range, finger outside the trigger guard, safety on, and await further instructions.

SET/PAINT STEEL & TAPE TARGETS: Competitors are expected to stay together as a squad, and to tape, set/paint steel, and help maintain efficiency on each stage. DO NOT paste targets until they have been scored! The S.O.'s and Scorekeepers will set any moving targets.

ALCOHOL/DRUGS: Alcohol and recreational drugs may not be consumed anywhere on the range. Competitors violating this policy will be disqualified and asked to leave the range.

DRESS CODE: No items of dubious taste are to be displayed or worn. The Match Director will be the final arbiter of dubious taste.

SCHEDULING: Competitors must compete for score according to the published match schedule. A competitor who is not present at the scheduled time and date for any stage may not attempt that stage without the prior approval of the Match Director, failing which the competitor's score for that stage will be a DNF. If a Competitor fails to attend the Safety Briefing, he or she will not be allowed to participate in the match.

WALK-THROUGHS: When the entire squad is assembled and the Scorekeeper has all of the squad's score sheets, a brief stage walkthrough will be given. **Per IDPA rules, no individual rehearsals of a CoF will be permitted.** This includes the taking of sight pictures or using your hands to visualize angles, etc. Shooters who violate this rule will incur penalties ranging from procedurals to a Match DQ. Please do not ask the S.O. or Scorekeeper for hints or strategy as to how to best complete the stage, as they will not be able to provide them.

TIME TO SHOOT: The range is closed to all regular competitors prior to the scheduled

match opening on August 4th, 2012. Attempts to view the stages prior to the start of shooting may incur penalties.

When called to the line, competitors are expected to load and make ready quickly. Shooters not ready within a reasonable time may be asked to move aside for the next competitor. If you show up without your gun or gear when your name is called, your score sheet goes to the bottom of the pile. Doing this intentionally may result in penalties.

EYE & EAR PROTECTION: All competitors and spectators must wear eye and ear protection while on the range.

D.Q. POLICY: Violation of safety and sportsmanship rules *anywhere* on the facility will result in match disqualification. This applies to any side matches, vendor tents, function fire and sign-in areas, as well as the match stages.

CHRONOGRAPH: Each Competitor's ammunition will be chronographed. A sample will be retrieved at random from each Competitor at some point during the match. The goal is to compete with "service type" ammunition, not light target ammunition. Therefore, the following minimum power floors will be in effect, per IDPA rules:

SSP- 125,000

ESP- 125,000

CDP- 165,000

ESR- 165,000

SSR- 105,000

Calculate power floor by multiplying the bullet weight in grains by the muzzle velocity in feet per second. Any non-tracer, non-armor piercing ammunition meeting or exceeding the power floor for the Division being competed in will be acceptable.

Official Chronograph Procedure Chronograph three (3) rounds at a distance of ten (10) feet using a gun of MAXIMUM barrel length for the DIVISION. If two (2) of the three (3) rounds exceed the power floor, the competitor is in compliance. Prior to each shot, the muzzle of the gun should be elevated to move the powder charge to the rear of the case, thus giving the competitor every chance to achieve maximum velocity. Should the competitor's ammunition fail to meet the power floor, the competitor will have the option to chronograph three (3) additional rounds through his or her gun. Prior to each shot, the muzzle of the gun should be elevated to move the powder charge to the rear of the case, thus giving the competitor every chance to achieve maximum velocity. If there is any question as to the bullet weight, a bullet should be pulled and weighed using a powder scale. Should the competitors declared bullet weight and the actual weight deviate by more than 3 grains lower than the declared weight, the competitor will receive a FTDR penalty. Any competitor whose ammunition fails to meet the minimum power floor will be disqualified from the entire match and will receive a DNF score.

EQUIPMENT: Your equipment must be IDPA Legal per the current rules. Safety Officer's may require you to submit to inspection at any time. If the Safety Officer believes you are using illegal equipment, the Chief Safety Officer or Match Director will

be called. Use of illegal equipment will result in a disqualification and match DNF.

IMPENETRABLE: All hard cover zones are impenetrable to a full bullet diameter.

Bullets holes that are partially or fully in the non-scoring border will score according to the circumstance. All walls, barricades, vision barriers and other props are considered hard cover unless otherwise noted.

TARGETS: IDPA cardboard targets and steel Poppers will be used. Steel must fall to score. Non-Threat targets will have obvious markings per IDPA rules.

METAL TARGET CALIBRATION: If a steel target has failed to fall and appears to be out of calibration, challenge it during the scoring. It will be checked and if recalibrated, a reshoot is required for that stage. If a popper has been shot down, it is asserted to be calibrated. Poppers are calibrated with .38 Special loads chronographed to a power factor as close as possible, but not less than 105,000.

MATCH SCORING: The championship will use the Beach Bunny Scoring Software.

COMPETITOR AGREEMENT: By competing in this event, you attest that you have read, you understand, and you agree to comply with the match rules and regulations.

DRAWINGS & DIMENSIONS: Drawings and dimensions shown in this booklet are approximate and may change due to safety or production considerations. There may be additional non-threat targets, vision barriers, or other changes. Listen to the CoF briefing, as it contains the final information about the stage.

REST ROOMS: Portable toilets are located conveniently around the range.

FOOD SERVICE: Lunch is free to all competitors. Spectators may purchase lunch tickets at the registration desk.

PARKING: Competitors may park in designated parking areas only. GUN HANDLING IN THE PARKING AREA IS PROHIBITED. Safety areas will be available to bag and unbag guns.

SPECTATORS: Spectators are welcome, however climbing on berms or otherwise interfering with the match is not allowed. Children must be under the direct supervision of a parent or guardian.

PRIZE TABLE: Donated and purchased prizes will be awarded on a random basis. Prize drawings will take place before awards ceremony. A ticket will be included in the shooter packet to claim a prize at the drawing. You must be present to win.

AWARDS: Awards will be given per the IDPA rulebook. Personalized Plaques will be handed out at the awards ceremony to all winners.

COLD RANGE: This is a cold range. Firearms are to be handled only in a safety area or under the direct command and supervision of a Safety Officer. You will find safety areas clearly marked in convenient locations around the range. Do not handle ammunition or ammunition carriers in the safety areas. Handling firearms in the parking lot is considered unsafe gun handling. Handling ammunition or ammunition carriers (magazines, speedloaders, etc.) in a safety area, or handling a firearm outside of a safety area and not under the direction of a Safety Officer will result in a match disqualification and a match DNF.



Stage 1 - Limited Progressive



Round Count: 12

Target Distance: 7 yards

Targets Required: 3x Standard Threats w/ T-Shirts

Scoring Method: Limited Vickers

Starting Position: Per String Description

Start Signal: Audible

Concealment: Not Required

Scenario: None. This is a Standards stage.

Procedure:

String 1: Standing at P1, hands relaxed at sides. On the start signal, draw and engage T1 with 1 round to the head, T2 with 1 round to the head and 1 round to the body, and T3 with 1 round to the head and 2 rounds to the body, all **Strong Hand Only**.

String 2: Standing at P1, loaded handgun in weak hand held at low ready. On the start signal, engage T3 with 1 round to the head, T2 with 1 round to the head and 1 round to the body, and T1 with 1 round to the head and 2 rounds to the body, all **Weak Hand Only**.

Scoring: All threats must have 4 hits, 2 of which must be head hits and 2 of which must be body hits.

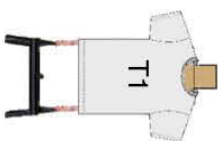
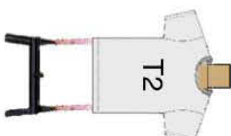
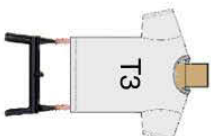

Notes: Targets **must** have 2 head hits and 2 body hits- any head or body hits beyond 2 will be scored as misses. Shooters shall shoot String 1 right to left for right-handed Shooters and left-to-right for left-handed Shooters. String 2 shall be shot left-to-right for right-handed Shooters, and right-to-left for left-handed Shooters.



Stage 2: Legal Issues

Round Count: 12

Scoring Method: Vickers Count

Starting Position: Seated in chair at position P1, hands on table.

Start Signal: Audible

Stop Signal: Last Shot Fired

Scenario: You're a lawyer wrapping up some business at the end of the day, when a group of armed men break in and threaten you and your coworkers' lives. One of the armed men is struggling with one of your coworkers and is attempting to stab him. The others all have handguns and are yelling "You're dead!". Three of the thugs seem to be wearing body armor, so failure drills are required.

Concealment Garment: Required

Procedure: On the start signal, draw and engage all threats, using the desk as cover. T4 may be engaged at any time once activated.

Scoring: T1 through T3 must have 3 hits, at least one of which must be a head hit. T4 must have 2 hits. All steel must fall to score.

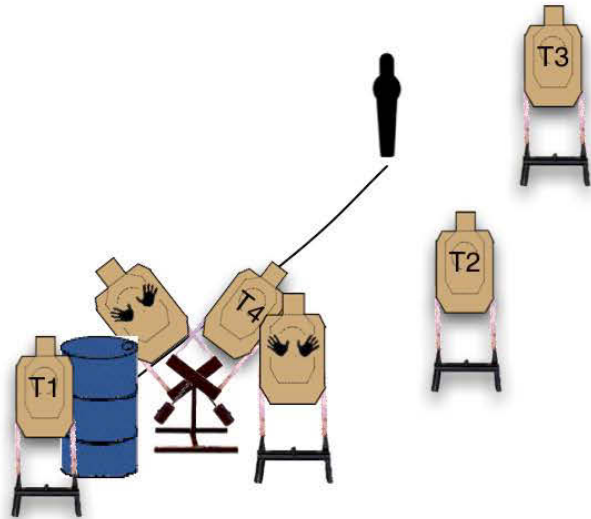



Stage 3: Jack This!



Round Count: 15

Scoring Method: Vickers Count

Starting Position: Sitting at position P1, hands in lap.

Start Signal: Audible

Stop Signal: Last Shot Fired

Scenario: You're in your car taking a shortcut through a bad part of town, when another car cuts in front of you and stops. All of a sudden, a bunch of Bad Guys pile out and rush you. You retrieve your handgun from the glove compartment and defend yourself!

Concealment Garment: Not Required

Procedure: On the start signal, retrieve your loaded handgun from the glove compartment of your car, then engage all threats.

Scoring: All threats must have two hits. All steel must fall to score.

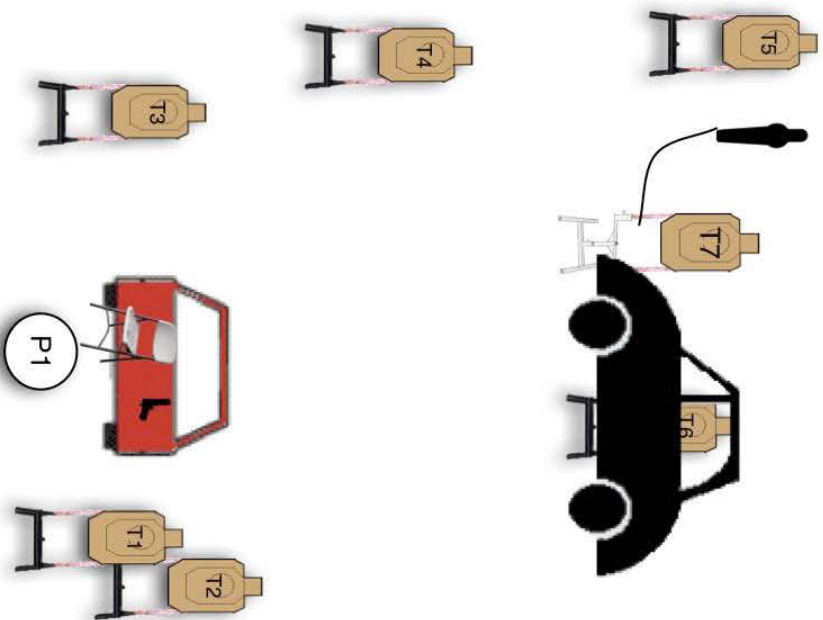

Note: The Bad Guy car is considered hard cover. All rounds must be fired through the side windows of your car.



Stage 4- Harder Cover



Round Count: 18

Scoring Method: Vickers Count

Starting Position: Standing at position P1, hands relaxed at sides

Start Signal: Audible

Concealment: Not Required

Scenario: None. This is a Standards stage.

Procedure: On the start signal, draw and engage threats T1 through T6, using Tactical Sequence, with at least three rounds each.

Scoring: All threats must have 3 hits, at least 1 of which must be a head hit.

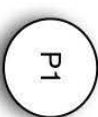
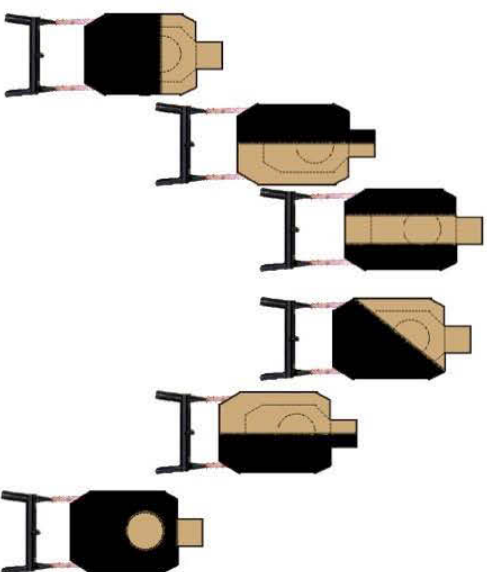

Notes: After each target has been engaged with one round, remaining rounds may be fired in any order.



Stage 5: Honey, I'm Home



Round Count: 17

Scoring Method: Vickers Count

Starting Position: Standing facing down range at position P1, hands relaxed at sides.

Start Signal: Audible

Stop Signal: Last Shot Fired

Scenario: You come home from work and are just about to walk inside your house when you hear your daughter scream. You rush inside to find that a group of armed men has broken in. Some of them are threatening your family, while the rest are ransacking the place for anything of value. You must defend your loved ones!

Concealment Garment: Required

Procedure: On the start signal, open the door and move to position P2. At P2, engage PP1 and T1 through T5. Move to position P3 and engage T6 through T8.

Scoring: All threats must have two hits. All steel must fall to score.

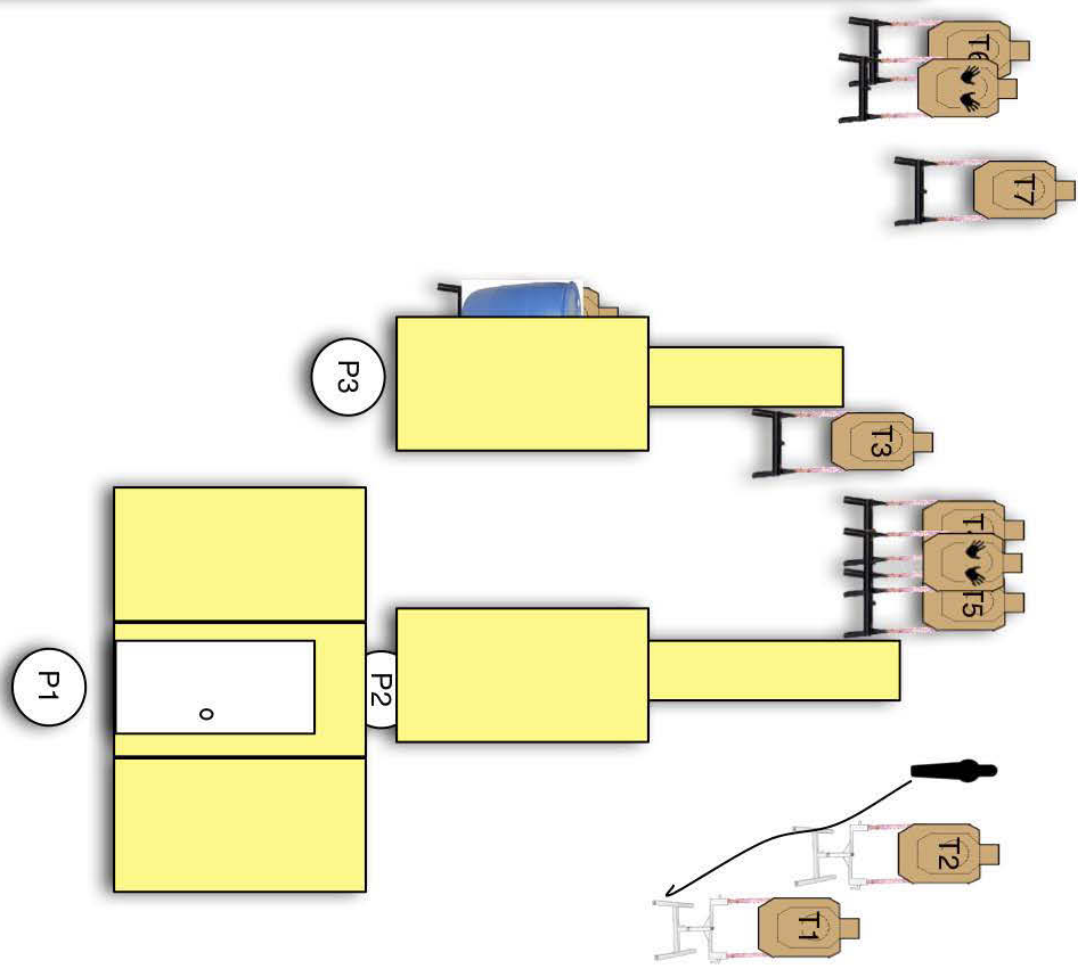

Notes: Shooter shall not draw their handgun until after stepping through the doorway at P1.



Stage 6: Small Craft Advisory



Round Count: 15

Scoring Method: Vickers Count

Starting Position: Seated in canoe, loaded handgun and ammunition in box on top of kayak, holding on to paddle with both hands.

Start Signal: Audible

Concealment Garment: Not Required

Scenario: You're out canoeing on Lake Michigan, when you encounter what appears to be a drug transfer at a small dock. The Bad Guys don't want witnesses and start shooting. A couple of them jump in the water and start swimming your way, while a few more start getting their boat ready to chase you down. Since you can't escape, you're forced to engage them.

Procedure: On the start signal, grab your handgun out of the box and engage all threats.

Scoring: All threats must have two hits. All steel must fall to score.

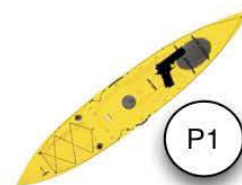
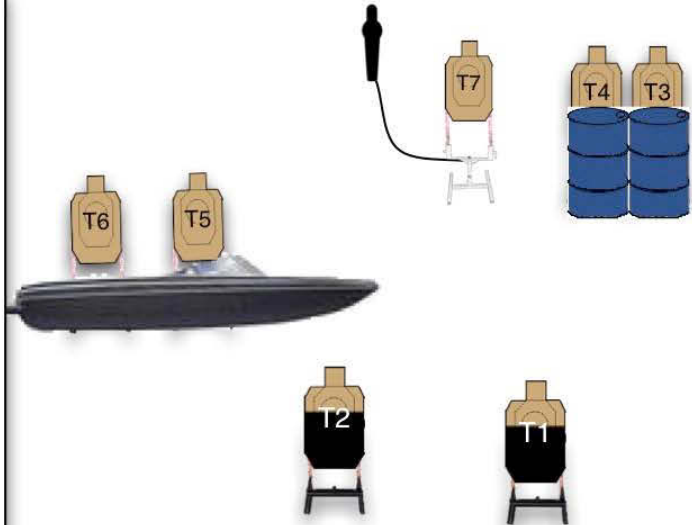

Note: The Shooter will start in the canoe leaning away from the targets.

2012 WI State Championship
Original CoF design by Tom Ropers



Stage 7: Escape



Round Count: 16

Scoring Method: Vickers Count

Starting Position: Kneeling at position P1, hands on top of head.

Start Signal: Audible

Concealment Garment: Not Required

Scenario: Your day was going okay until a group of armed robbers decided to hold up your business. One of them accidentally pulled off his mask, allowing to see his face, so they've decided that they can't leave any witnesses behind. It looks like this is the end, but you manage to get the Bad Guy's handgun away from him and are able to fight your way out of the building.

Procedure: At the start signal, pick up the pistol laying on the ground at P1 and engage targets T1, T2, and PP1. Move to position P2 and recover your handgun and reloads. Engage targets T3 through T5 while moving to position P3. Finally, engage targets T6, T7, and PP2 from position P3.

Scoring: All threats must have two hits, all steel must fall to score.

Notes: All shots with "stage" gun must be taken while kneeling. All of Shooter's reloads are on the barrel next to their handgun. Handgun must be laying flat on the top of the barrel. Shooter must take all reloads with them when they leave P2. The barrel at P2 is not considered cover. If PP1 must be engaged with the Shooters' handgun, it must be shot while moving to P3.

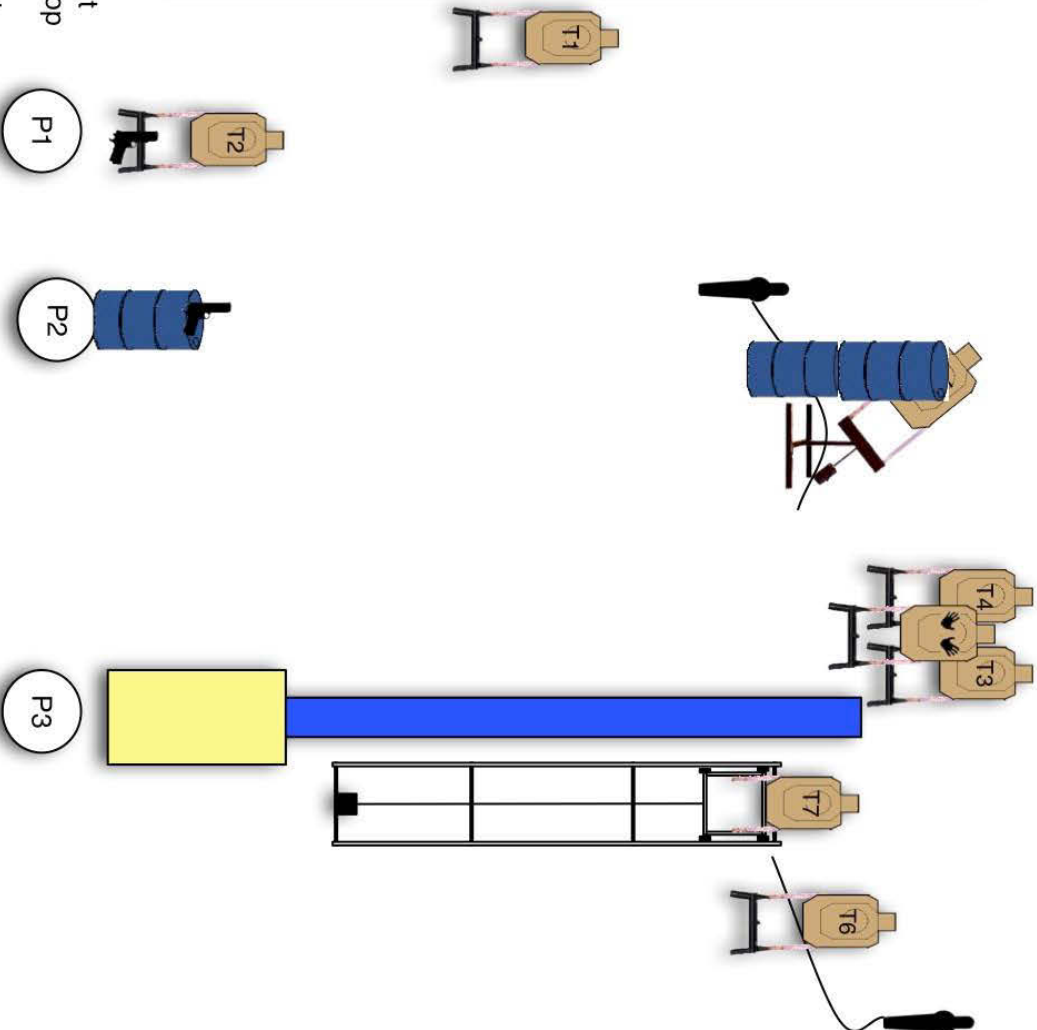



Stage 8: Fireworks



Round Count: 17

Scoring Method: Vickers Count

Starting Position: Standing at position P1, hands relaxed at sides.

Start Signal: Audible

Stop Signal: Last Shot Fired

Concealment Garment: Required

Scenario: You're at a friend's house for a 4th Of July party. During the nearby fireworks show, a group of thugs decides to rob everyone, since anyone nearby would likely mistake any gunfire for fireworks. It's up to you to save the day.

Procedure: On the start signal, draw and engage T1 and T2 while moving to position P2. From P2, engage targets T3 through T5. Move up to position P3 and engage targets T6 through T8 and popper PP1.

Scoring: All threats must have two hits. All steel must fall to score.

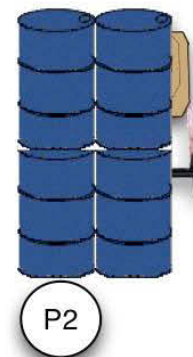
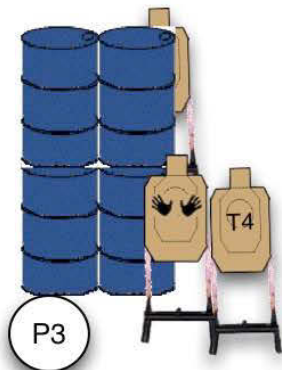
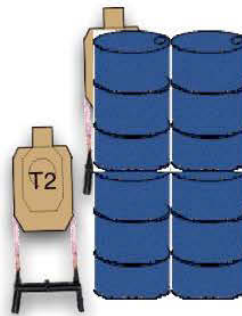
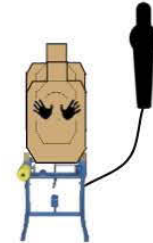

Notes: T8 (the MaxTrap) is a completely disappearing target. Shooter may not advance beyond P3.

2012 WI State IDPA Championship
Original CoF design by Tom Ropers



Stage 9- Dog Days Of Summer



Round Count: 4

Scoring Method: Vickers Count

Starting Position: Standing at position P1, hands on table, empty handgun laying on table, muzzle pointed down range, loose ammo, magazines/speedloaders/moonclips, and any loading aids on table.

Start Signal: Audible

Concealment: Not Required

Scenario: You are in your backyard cleaning your handgun. Your dog is roaming around the yard when two feral dogs jump over the fence and attack him. You have to quickly load your handgun and save your dog!

Procedure: On the start signal, load your handgun and engage T1 and T2 with at least two rounds each.

Scoring: All threats must have two hits.

Notes: Handgun may be positioned anywhere in the marked area on the table, but must be laying on it's side with the muzzle pointed downrange and action open. The handgun may not be propped up by anything. Loose ammunition, magazines/speedloaders/moonclips, and any loading aids may be positioned anywhere on the table between the Shooter and the handgun. A moonclip may be positioned in or on any moonclip loading aid. Shooter may have up to their normal Division limit of ammunition on the table (24rds for ESR/SSR, 25rds for CDP, 31rds for SSP/ESP). Ammo must be loose on table, not position in or on any loading aids.

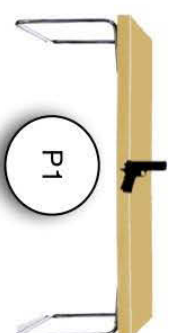
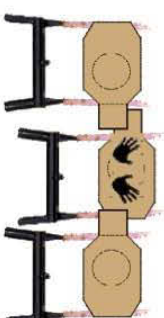



2012 Wisconsin State Match August 4, 2012

All Shooters

High Senior: Rich Eddington SSP - Expert 184.26 (32)
 High Lady: Julie Williams SSP - Expert 215.31 (53)
 High Law Enforcement: Rich Eddington SSP - Expert 184.26 (32)
 High Industry: Michael Brodzik SSP - Expert 189.86(101)
 High Junior: Alex Sliwinski SSP - Sharpshooter 223.40 (60)
 High Military: Michael Brodzik SSP - Expert 189.86(101)
 High Military Veteran: Michael Brodzik SSP - Expert 189.86(101)
 High Distinguished Senior: Stef Hobson ESP - Sharpshooter 234.47 (66)
 Most Accurate: Scott Gruenberg SSR - Expert 197.19 (18)

Match	--- Penalties ---												
	PD	NT	PE	FN	EDR	Stage 1	Stage 2	Stage 3	Stage 4	Stage 5	Stage 6	Stage 7	Stage 8

CDP - Master	1	Demondo, Richard	230.36	51	0	0	0	0	20.43(13)	18.37(5)	18.91(4)	34.33(4)	25.04(4)	24.31(11)	27.80(4)	45.02(6)	16.15(0)
---------------------	---	------------------	---------------	----	---	---	---	---	-----------	----------	----------	----------	----------	-----------	----------	----------	----------

CDP - Expert

1	Pruszyński, Charles	186.87	45	0	1	0	0	18.79(11)	14.65(2)	19.27(2)	27.10(3)	25.10(7)	25.08(13)	21.87(4)	24.13(3)	10.88(0)
2	Boller, Jeff	192.92	38	0	0	0	0	21.25(10)	14.43(1)	20.12(6)	25.68(2)	23.70(4)	20.50(5)	25.48(5)	27.57(5)	14.19(0)
3	Hefner, Randy	194.08	38	1	0	0	0	19.50(4)	17.14(3)	15.99(1)	26.82(3)	30.33(10)	21.19(8)	22.30(5)	31.47(3)	9.34(1)
4	Maxwell, Adam	196.45	68	0	0	0	0	17.04(11)	18.13(7)	16.68(3)	40.67(13)	26.03(7)	20.08(11)	22.69(2)	25.44(13)	9.69(1)
5	Bilsky, Matt	199.85	53	1	0	0	0	17.96(11)	17.26(2)	19.86(8)	26.76(2)	29.62(11)	31.10(14)	23.99(2)	23.15(3)	10.15(0)
6	Lawrence, Ollis	255.39	99	2	1	2	0	27.67(18)	16.16(1)	26.79(14)	27.07(0)	31.51(9)	46.70(36)	31.56(14)	36.41(7)	11.52(0)
7	Salas, Francisco	274.65	65	0	1	0	0	20.53(6)	24.42(1)	23.62(8)	41.40(11)	41.47(12)	32.83(15)	27.48(3)	46.93(9)	15.97(0)

CDP - Sharpshooter

1	Langum, Andrew	221.57	46	1	2	0	0	18.90(8)	17.91(0)	18.73(2)	28.00(2)	37.15(16)	26.11(4)	28.75(5)	35.34(9)	10.68(0)
2	Stevens, Perry	231.65	60	0	0	0	0	23.02(12)	20.89(1)	21.18(6)	31.64(3)	32.40(8)	25.93(8)	26.38(3)	35.66(19)	14.55(0)
3	Brimmer, James	237.93	85	1	1	0	0	29.58(20)	21.26(2)	24.35(4)	34.38(12)	43.32(22)	25.12(12)	25.91(9)	22.50(3)	11.51(1)
4	Trepanier, Gay	257.25	67	0	0	0	0	18.59(7)	21.14(7)	24.56(8)	42.91(16)	37.23(9)	34.08(10)	29.27(4)	38.25(6)	11.22(0)
5	Mitnick, Frank	258.52	76	1	3	1	0	31.09(20)	17.03(0)	25.04(11)	35.38(1)	41.29(17)	32.89(12)	32.00(6)	30.82(9)	13.00(0)
6	Casteele, Mallard	261.71	72	1	0	0	0	32.75(20)	19.28(1)	25.91(8)	30.79(10)	42.41(9)	30.22(15)	29.33(6)	36.33(3)	14.69(0)

Numbers in parenthesis are target points down **Bold** indicates stage winners



2012 Wisconsin State Match August 4, 2012

All Shooters

Match	--- Penalties ---			Stage 1	Stage 2	Stage 3	Stage 4	Stage 5	Stage 6	Stage 7	Stage 8	Stage 9
	SCORE	PD	NI									

CDP - Marksman																
1	Wiedemeyer, Ryan	230.14	47	1	2	0	0	18.92 (5)	19.50 (0)	26.84 (8)	26.99 (2)	33.38 (4)	21.91 (8)	36.55 (11)	35.42 (9)	10.63 (0)
2	Sivinski, Mark	259.22	53	1	0	0	0	18.01 (1)	21.33 (6)	21.09 (0)	35.60 (10)	44.32 (9)	33.04 (11)	32.13 (6)	40.14 (10)	13.56 (0)
3	Angelini, Bill	267.00	100	2	1	0	0	21.47 (17)	22.11 (1)	25.01 (14)	48.31 (9)	31.62 (12)	33.03 (27)	39.66 (12)	34.49 (8)	11.30 (0)
4	Dobering, James	275.36	54	0	3	0	0	25.78 (2)	20.71 (3)	28.46 (7)	42.98 (13)	45.32 (12)	26.22 (7)	32.55 (3)	39.51 (7)	13.83 (0)
5	Ramps, Michael	284.91	97	0	0	1	0	26.48 (16)	20.58 (2)	29.65 (5)	46.27 (35)	43.37 (10)	41.30 (21)	28.30 (2)	37.10 (6)	11.86 (0)
6	O'Hare, John	288.01	116	1	1	0	0	33.59 (42)	29.87 (10)	22.00 (7)	42.44 (18)	55.75 (18)	29.66 (10)	24.09 (7)	39.27 (4)	11.34 (0)
7	Henry, William	296.18	70	1	1	0	0	19.15 (8)	27.45 (3)	29.46 (3)	44.42 (30)	43.85 (9)	31.55 (5)	32.92 (8)	52.63 (4)	14.75 (0)
8	Bard, Ron	299.60	68	1	1	1	0	30.05 (13)	26.81 (1)	26.86 (11)	39.72 (8)	52.56 (20)	25.77 (3)	33.37 (4)	47.30 (8)	17.16 (0)
9	Hein, Stan	387.62	105	1	6	0	0	60.51 (34)	25.24 (0)	29.45 (10)	48.98 (5)	86.42 (28)	32.78 (17)	41.35 (7)	47.20 (4)	15.69 (0)

CDP - Novice																
1	Nason, David	351.96	98	2	0	0	0	24.02 (12)	38.70 (13)	33.81 (11)	42.29 (7)	52.31 (18)	50.71 (18)	46.80 (7)	50.19 (11)	13.13 (1)

ESP - Master																
1	Spencer, Ryan	155.09	46	1	0	0	0	16.44 (10)	10.45 (0)	14.66 (7)	17.80 (5)	19.27 (6)	17.16 (5)	28.63 (9)	19.10 (4)	11.58 (0)
2	Muchow, Todd	190.24	61	1	3	0	0	24.05 (18)	14.91 (4)	15.69 (4)	27.06 (1)	26.27 (7)	21.40 (7)	27.95 (8)	22.85 (12)	10.06 (0)

ESP - Expert																
1	Carillo, Jason	168.97	82	0	0	1	0	21.67 (17)	13.33 (1)	14.95 (6)	21.75 (11)	24.91 (11)	26.54 (18)	15.25 (6)	22.16 (12)	8.41 (0)
2	Brantley, Tom	180.03	52	0	0	0	0	27.48 (22)	17.50 (7)	16.58 (1)	24.55 (5)	21.91 (4)	18.38 (3)	19.59 (7)	22.24 (3)	11.80 (0)
3	Barera, Michael	207.03	77	0	0	1	0	23.52 (20)	17.56 (0)	18.66 (9)	32.27 (7)	24.66 (6)	34.11 (16)	22.14 (9)	24.68 (10)	9.43 (0)

Numbers in parenthesis are target points down **Bold** indicates stage winners Page 2 of 7



2012 Wisconsin State Match August 4, 2012

All Shooters

Match	--- Penalties ---			Stage 1	Stage 2	Stage 3	Stage 4	Stage 5	Stage 6	Stage 7	Stage 8	Stage 9
	SCORE	PD	NT									

1	Nuccio, Michael J.	163.99	43	0	0	0	17.77 (6)	15.43 (7)	15.47 (3)	25.25 (5)	20.00 (2)	18.59 (7)	19.17 (4)	23.32 (9)	8.99 (0)
2	Jacoby, Aaron	198.51	45	0	0	0	18.47 (9)	17.61 (1)	21.05 (6)	23.55 (5)	27.74 (5)	24.89 (5)	21.02 (3)	28.06 (9)	16.12 (2)
3	Pilling, Neil	203.12	48	0	0	0	18.24 (5)	16.73 (0)	18.71 (4)	32.67 (5)	28.62 (8)	26.72 (14)	20.16 (8)	30.31 (7)	10.96 (0)
4	Meyer, Jerry	225.64	66	0	0	1	23.46 (13)	22.62 (2)	20.12 (7)	25.31 (1)	32.09 (11)	32.10 (18)	27.55 (6)	29.42 (8)	12.97 (0)
5	Zudeima, Marvin	229.48	83	1	2	0	15.33 (0)	24.61 (1)	22.62 (10)	35.85 (37)	32.84 (6)	25.49 (14)	30.44 (10)	31.98 (4)	10.32 (1)
6	Hobson, Stef	234.47	66	0	0	0	19.45 (10)	21.20 (7)	21.46 (2)	34.82 (7)	33.04 (12)	30.87 (16)	30.83 (9)	27.04 (3)	15.76 (0)
7	Griffin, Jacob	241.36	55	0	0	0	21.27 (12)	29.00 (4)	25.09 (4)	31.76 (0)	36.66 (11)	20.48 (6)	32.32 (3)	29.88 (14)	14.90 (1)
8	Simons, Michael	272.33	98	1	1	1	35.15 (27)	22.18 (1)	25.45 (7)	32.88 (17)	35.17 (10)	35.12 (15)	38.19 (13)	31.94 (8)	16.25 (0)
9	Thompson, Jon	291.75	57	0	0	1	25.54 (10)	25.26 (0)	31.46 (12)	33.72 (7)	42.03 (17)	31.34 (6)	41.31 (4)	44.24 (1)	16.85 (0)
													Zimmerman, Don	DQ	

ESP - Marksman

1	Wendurski, Daniel	215.74	50	1	1	0	20.70 (11)	21.16 (2)	24.35 (3)	25.51 (2)	32.68 (11)	23.30 (10)	28.05 (8)	30.34 (3)	9.65 (0)
2	Nuccio, Michael F.	246.13	47	1	0	0	28.36 (15)	22.56 (5)	24.45 (4)	28.41 (1)	36.20 (13)	25.97 (5)	25.06 (2)	38.20 (2)	16.92 (0)
3	Rees, Pete	249.01	125	2	1	1	22.52 (17)	22.46 (5)	21.21 (5)	34.21 (26)	32.00 (19)	25.40 (14)	37.18 (16)	42.53 (22)	11.50 (1)
4	Tucker, Allen	263.98	94	1	2	0	22.94 (17)	18.59 (0)	25.56 (4)	35.97 (16)	39.13 (21)	33.46 (19)	40.45 (11)	31.55 (5)	16.33 (1)
5	Mell, John	265.55	81	0	0	0	25.51 (11)	21.42 (1)	25.08 (5)	29.85 (15)	45.18 (20)	28.45 (7)	31.81 (11)	42.10 (10)	16.15 (1)
6	Chvald, Neal	289.32	84	1	4	0	31.76 (6)	26.41 (10)	29.88 (9)	26.69 (13)	34.54 (12)	28.21 (14)	33.68 (9)	61.89 (8)	16.26 (3)
7	Loewe, Wade	320.61	83	3	4	1	26.67 (15)	32.20 (2)	26.05 (5)	48.49 (0)	47.54 (16)	46.14 (19)	40.97 (19)	40.01 (7)	12.54 (0)
8	Weber, Bill	341.81	98	0	3	0	22.54 (0)	34.09 (15)	35.95 (8)	74.98 (18)	47.17 (22)	37.50 (14)	28.87 (12)	42.22 (9)	18.49 (0)
9	Schmeckle, Audrey	404.96	140	2	2	0	37.94 (26)	34.49 (7)	53.44 (14)	38.92 (9)	65.77 (21)	43.90 (20)	47.14 (31)	66.53 (12)	17.73 (0)
10	Trepanier, Nancy	501.65	201	2	1	3	26.91 (11)	38.40 (14)	44.64 (18)	95.08 (56)	61.05 (27)	74.42 (31)	58.62 (15)	72.74 (23)	29.79 (6)

SSP - Master

1	Alleno, Anthony	160.75	55	0	0	0	18.80 (11)	13.31 (3)	16.42 (4)	23.27 (11)	23.20 (6)	18.14 (9)	15.89 (2)	21.71 (8)	10.01 (1)
2	Bitk, Dore	188.91	83	0	0	0	18.93 (15)	18.85 (10)	18.81 (5)	34.27 (22)	22.73 (5)	21.62 (12)	18.86 (2)	23.93 (12)	10.91 (0)
3	Scalise, Patrick	201.95	41	0	0	0	16.16 (9)	19.51 (4)	21.04 (2)	23.41 (10)	34.98 (2)	22.05 (1)	21.94 (1)	34.23 (12)	8.63 (0)
4	Ostrander, Mike	214.14	83	0	2	0	14.62 (7)	14.82 (2)	27.69 (15)	34.76 (8)	26.14 (11)	30.87 (18)	20.10 (9)	33.30 (12)	11.84 (1)

Numbers in parenthesis are target points down **Bold** indicates stage winners



2012 Wisconsin State Match August 4, 2012

All Shooters

Match	--- Penalties ---			Stage 1	Stage 2	Stage 3	Stage 4	Stage 5	Stage 6	Stage 7	Stage 8	Stage 9
	SCORE	PD	NI PE FN FDR									

SSP - Expert												
1 Eddington, Rich	184.26	32	0 0 0 0	14.87 (0)	18.54 (3)	20.80 (4)	24.09 (1)	24.67 (3)	23.73 (11)	22.53 (4)	23.49 (6)	11.44 (0)
2 Brodzk, Michael	189.86	101	0 1 0 0	17.81 (13)	14.57 (7)	17.44 (6)	32.14 (28)	28.67 (9)	19.82 (10)	21.78 (14)	26.36 (14)	11.27 (0)
3 Sendele, Ed	190.19	58	0 0 0 0	17.63 (10)	16.54 (3)	18.89 (6)	19.31 (0)	29.00 (6)	28.69 (15)	24.43 (15)	26.50 (3)	9.10 (0)
4 Gribble, Jacob	200.17	48	0 0 0 0	20.61 (16)	15.87 (2)	23.02 (6)	21.97 (1)	31.23 (8)	26.81 (10)	23.88 (4)	25.96 (0)	10.82 (1)
5 Feger, Ray	204.95	71	1 1 0 0	31.75 (28)	16.04 (3)	20.74 (8)	31.24 (4)	24.55 (10)	20.38 (6)	18.81 (7)	30.51 (5)	10.93 (0)
6 Grant, Tom	207.44	25	0 0 0 0	16.04 (6)	16.99 (1)	18.24 (1)	23.53 (5)	33.07 (6)	24.04 (6)	30.01 (0)	31.93 (0)	13.59 (0)
7 Williams, Julie	215.31	53	0 0 0 0	25.15 (14)	19.02 (0)	20.84 (2)	29.38 (2)	32.04 (15)	25.13 (11)	25.27 (6)	24.62 (2)	13.86 (1)
8 Esser, Mike	235.79	60	1 1 0 0	28.39 (13)	19.45 (0)	21.60 (5)	31.02 (4)	39.37 (7)	25.87 (12)	29.76 (12)	29.80 (7)	10.53 (0)
Sandridge, Gary												
DQ												

SSP - Sharpshooter												
1 Silivski, Alex	223.40	60	1 0 0 0	22.07 (11)	20.53 (1)	18.47 (2)	31.33 (17)	29.71 (8)	29.78 (14)	27.55 (2)	32.19 (5)	11.77 (0)
2 Fabian, Frank	224.63	71	0 2 2 0	18.11 (8)	15.58 (0)	31.64 (17)	32.64 (17)	26.70 (9)	30.77 (16)	21.81 (1)	35.19 (2)	12.19 (1)
3 Reeder, Jim	229.43	70	0 0 0 0	23.59 (18)	19.61 (2)	22.82 (4)	25.47 (5)	35.87 (12)	29.99 (20)	26.32 (2)	33.91 (7)	11.85 (0)
4 Gordon, Adam	233.59	118	1 1 2 0	19.20 (12)	15.87 (1)	20.18 (6)	29.47 (22)	33.92 (19)	35.33 (24)	25.90 (17)	39.56 (15)	14.16 (2)
5 Patel, Colin	242.70	68	3 2 1 0	19.68 (13)	23.06 (2)	23.07 (5)	24.63 (19)	31.26 (6)	30.91 (4)	39.25 (12)	30.93 (6)	19.91 (1)
6 Van Dis, Steve	251.92	58	1 0 1 0	21.86 (10)	22.08 (0)	22.11 (6)	30.29 (9)	40.42 (9)	26.22 (4)	31.48 (7)	44.83 (13)	12.63 (0)
7 Furno, William	252.67	31	1 1 0 0	23.32 (0)	25.94 (2)	21.58 (1)	26.01 (0)	41.47 (19)	24.67 (3)	30.30 (4)	41.44 (2)	17.94 (0)
8 Bublitz, Matthew	253.74	47	2 2 0 0	23.23 (13)	19.20 (1)	24.41 (9)	29.33 (6)	39.49 (7)	23.63 (4)	31.09 (3)	48.11 (3)	15.25 (1)
9 Chudnow, Donald	255.85	54	0 0 0 0	22.98 (5)	20.98 (1)	24.64 (7)	43.84 (11)	39.29 (18)	38.20 (5)	22.65 (3)	30.92 (4)	12.35 (0)
10 Wisler, Chuck	260.14	52	0 2 0 0	36.70 (11)	23.99 (1)	30.27 (5)	24.17 (1)	33.73 (5)	36.16 (11)	27.64 (5)	29.82 (5)	17.66 (8)
11 O'Keefe, David	263.35	43	1 2 0 0	30.83 (7)	19.14 (1)	27.10 (5)	35.08 (5)	34.02 (7)	30.85 (7)	37.51 (9)	34.05 (2)	14.77 (0)
12 Urgo, Richard	269.33	97	2 0 0 0	21.72 (11)	22.63 (1)	26.53 (4)	35.27 (33)	38.86 (12)	43.11 (21)	29.64 (5)	35.86 (4)	15.71 (6)
13 Callahan, Scott	279.63	80	0 1 0 0	22.95 (13)	18.85 (2)	28.69 (8)	42.91 (8)	33.45 (15)	32.33 (20)	36.69 (8)	36.82 (4)	26.94 (2)
14 Gares, David	281.00	82	0 0 0 0	26.38 (23)	31.51 (4)	26.50 (7)	50.89 (16)	39.58 (14)	27.71 (5)	28.78 (6)	36.43 (5)	13.22 (2)
15 Kelly, Michael	314.79	107	1 0 1 0	28.39 (23)	24.48 (1)	31.43 (13)	50.06 (15)	43.67 (17)	48.33 (25)	32.02 (2)	43.37 (11)	13.04 (0)
16 Preil, Loren	317.08	50	1 0 0 0	23.79 (14)	29.90 (0)	31.50 (3)	53.43 (11)	40.50 (10)	40.43 (9)	38.65 (3)	42.40 (0)	16.48 (0)

Numbers in parenthesis are target points down **Bold** indicates stage winners



2012 Wisconsin State Match August 4, 2012

All Shooters

Match	--- Penalties ---			Stage 1	Stage 2	Stage 3	Stage 4	Stage 5	Stage 6	Stage 7	Stage 8	Stage 9
	SCORE	PD	NI									

SSP - Marksman																
1	Richards, Russell	266.05	74	3	1	0	0	34.76 (2)	25.96 (6)	29.28 (4)	25.62 (2)	47.60 (12)	24.36 (17)	28.59 (19)	34.41 (11)	15.47 (1)
2	Preil, Daniel	282.99	85	1	1	0	0	33.63 (35)	25.06 (2)	24.58 (6)	35.13 (14)	41.34 (4)	31.35 (8)	34.82 (1)	41.47 (14)	15.61 (1)
3	Holsen, Benjamin	291.90	57	0	1	0	0	28.38 (11)	29.62 (2)	26.87 (2)	25.83 (0)	45.84 (14)	36.41 (8)	39.00 (13)	43.08 (6)	16.87 (1)
4	Anore, Corey	294.28	114	1	2	0	0	29.38 (16)	30.95 (8)	23.92 (7)	50.91 (37)	42.26 (11)	33.27 (18)	29.04 (4)	38.73 (12)	15.82 (1)
5	Cerneno, Victor	296.60	48	0	1	0	0	38.84 (26)	23.53 (0)	28.85 (2)	40.65 (0)	40.05 (1)	28.31 (12)	34.49 (2)	48.80 (5)	13.08 (0)
6	Hoffman, Kimberly	302.89	60	1	1	0	0	24.27 (11)	22.06 (0)	28.01 (6)	30.14 (2)	59.81 (19)	36.55 (7)	37.03 (5)	50.37 (10)	14.65 (0)
7	Roseberry, David	302.98	110	2	2	0	0	24.28 (15)	31.05 (6)	39.31 (23)	41.50 (9)	42.85 (18)	38.92 (23)	31.18 (10)	35.63 (5)	18.26 (1)
8	Grohmann, Gert	304.90	74	0	0	0	0	20.28 (1)	26.05 (3)	36.31 (10)	32.69 (9)	43.87 (25)	47.97 (17)	32.84 (5)	45.77 (4)	19.12 (0)
9	Huffine, Thomas Jr	318.97	132	2	1	0	0	32.02 (26)	34.19 (4)	24.33 (8)	40.67 (18)	43.68 (22)	37.13 (20)	32.84 (12)	59.09 (20)	15.02 (2)
10	Carver, Pat	321.19	76	1	0	0	0	30.07 (15)	32.46 (2)	32.61 (4)	34.96 (0)	48.18 (23)	40.27 (20)	34.66 (7)	47.48 (5)	20.50 (0)
11	Tanski, Ron	333.22	157	1	5	2	0	27.36 (21)	30.58 (6)	24.15 (8)	42.19 (35)	45.11 (21)	48.80 (32)	49.73 (14)	49.27 (19)	16.03 (1)
12	Skofstad, Dave	343.70	135	1	0	0	0	23.43 (4)	35.58 (7)	34.12 (10)	57.41 (46)	45.80 (10)	39.31 (22)	37.32 (22)	48.05 (8)	22.68 (6)
13	Urgo, Charles	354.60	89	1	3	0	0	36.96 (23)	28.16 (1)	33.41 (6)	48.64 (27)	53.48 (13)	33.03 (8)	39.66 (7)	60.75 (4)	20.51 (0)
14	Johnson, Michael	357.48	73	1	4	1	0	35.74 (11)	26.23 (0)	30.25 (1)	47.34 (0)	65.45 (18)	43.39 (15)	30.94 (17)	61.96 (11)	16.18 (0)

SSP - Novice																
1	Andries, Aaron	285.72	63	0	0	0	0	24.06 (16)	32.35 (1)	24.63 (5)	34.95 (1)	37.54 (13)	39.53 (16)	38.34 (8)	39.51 (3)	14.81 (0)
2	Grohmann, Lucas	417.04	108	1	0	0	0	42.58 (22)	42.02 (6)	39.45 (9)	46.60 (11)	59.74 (18)	55.15 (18)	43.37 (10)	61.39 (14)	26.74 (0)
3	Ropers, Kellie	496.17	151	2	1	0	0	35.07 (22)	53.17 (16)	54.60 (8)	63.59 (25)	72.18 (25)	71.99 (15)	55.10 (13)	61.24 (16)	29.23 (11)

ESR - Expert																
1	Williams, Mike	195.11	28	1	0	0	0	15.64 (5)	13.54 (0)	22.19 (2)	37.76 (4)	25.10 (4)	26.10 (8)	20.68 (4)	26.97 (1)	7.13 (0)

ESR - Sharpshooter																
1	Ropers, Thomas	286.86	116	1	0	1	0	30.53 (23)	16.84 (2)	32.97 (13)	49.63 (25)	36.80 (9)	35.54 (22)	27.64 (7)	46.34 (15)	10.57 (0)
2	Herro, Mike	299.75	95	0	0	0	0	31.54 (15)	37.65 (7)	34.24 (18)	47.07 (18)	42.76 (15)	33.49 (14)	31.37 (5)	29.71 (3)	11.92 (0)

SSR - Expert																
1	Guenberg, Scott	197.19	18	1	0	0	0	17.52 (6)	14.76 (0)	21.14 (2)	21.83 (0)	33.09 (0)	27.05 (6)	22.51 (1)	28.66 (3)	10.63 (0)
2	Skoclich, Jeffrey	215.77	41	0	0	0	0	18.54 (5)	15.12 (0)	22.20 (1)	32.38 (1)	34.19 (16)	29.14 (5)	20.86 (0)	31.68 (12)	11.66 (1)
3	Dilley, Craig	239.62	33	0	0	0	0	17.83 (5)	23.21 (1)	28.93 (2)	34.92 (5)	33.72 (4)	32.87 (2)	23.31 (2)	34.76 (12)	10.07 (0)
4	Lindsey, Travis	328.97	67	2	0	0	0	25.08 (3)	24.91 (9)	33.75 (10)	57.08 (9)	47.58 (11)	44.84 (16)	27.89 (2)	51.80 (7)	16.04 (0)

SSR - Sharpshooter																
1	Alexander, John	256.80	59	0	0	0	0	20.23 (9)	22.26 (3)	31.89 (11)	35.61 (6)	36.46 (7)	35.11 (10)	30.89 (7)	33.98 (6)	10.37 (0)

Numbers in parenthesis are target points down **Bold indicates stage winners**



2012 Wisconsin State Match August 4, 2012

All Shooters

SSR - Marksman

Match	--- Penalties ---			Stage 1	Stage 2	Stage 3	Stage 4	Stage 5	Stage 6	Stage 7	Stage 8	Stage 9		
	SCORE	PD	NT										PE	FN
1 Ropers, Jeffrey	355.17	99	4	0	0	22.99 (5)	35.94 (7)	29.01 (5)	48.00 (23)	48.61 (15)	57.58 (27)	43.24 (8)	55.31 (8)	14.49 (1)

Numbers in parenthesis are target points down **Bold** indicates stage winners



2012 Wisconsin State Match August 4, 2012

All Shooters

Total Match Penalties:

Target Points Down (PD) - 7,613
Hits on Non-Threats (NT) - 78
Procedural Errors (PE) - 91
Failures to Neutralize (FN) - 27
Failures to Do Right (FTDR) - 0
Shooter Disqualifications (DQ) - 3

Key to Penalties:

PD = Target Points Down. Each point down adds 1/2 second to your score.
NT = Hit on Non Threat target. Each HNT adds 5 seconds to your score.
PE = Procedural Error. Each adds 3 seconds to your score.
FN = Failure to Neutralize (no hits in the 0 or -1 zone) Each adds 5 seconds to your score.
FTDR = Failure To Do Right - adds 20 seconds to your score.

Key to Abbreviations:

CDP = Custom Defensive Pistol, such as 1911. Must be .45 ACP with maximum magazine load of 8 rounds
ESP = Enhanced Service Pistol, single action or SA/DA such as H&K P7 or CZ-75 or Springfield XD
SSP = Stock Service Pistol, double action or 'Safe Action' such as Glock or SIG
ESR = Enhanced Service Revolver, rimmed or rimless ammo, full moon clip, power factor of 165,000
SSR = Stock Service Revolver, rimmed case ammo, no full moon clips
DNF = Did Not Finish **DQ** = Disqualified



Now that the match is over, the range is cleaned up, and the competitors have headed back home, I'd like to offer a few words of thanks. First off, a heartfelt thanks to all of our volunteers this year. Based on the feedback I've received so far, everybody agrees that the staff were top notch. As we all know, it's impossible to put on a great match without great staff, and all of our volunteers stepped on whenever necessary to make sure that this match went well.

Another thanks is due to all of you, our Shooters! There's not much of a match if no one attends, and it's obvious that all of you did your share to keep the match moving along. We managed to just squeak in the awards ceremony before the weather turned sour. With the record turnout for the WI State Championship that we had this year, this speaks well of all of you- nine stages completed plus a lunch break in five and a half hours. Again, thanks!

If anyone has any feedback that they would like to share, positive or negative, please feel free to contact me. Any feedback will be kept private, unless you indicate that it should be shared. Thanks again for participating, and we hope to see you next year!

Tom Ropers
Match Director