

Columbia Phone 1-800-628-8600 | For parts or service | Parts - Angelo

SACHS MOTOR-SERVICE REPAIR MANUAL

**SACHS 505/1A
505/1D
MOPED MOTOR**



REVISED EDITION — 1980

REPRINTED IN THE U.S.A.

By Permission of FICHTEL & SACHS AG • D-8720 SCHWEINFURT • WEST GERMANY



CONTENTS

Introduction	1
Description on engine plate and engine type	1
Technical data	1
Repair tools and mounting jig	2
Disassembling the engine	3
Working on individual parts	
Exchange of crankshaft bearing	5
Mainshaft with layshaft gears ass'y	5
Pedal shaft	6
Carburettor	6
Magneto-generator	6
Decarbonizing the exhaust system and the cylinder	6
Rebuilding the engine	7
Ignition timing	9
Operations after engine overhaul	
Fitting and lubricating the control cables	10
Removing and connecting the starter clutch control cable in the engine	11
Adjusting the starter and decompressor lever	11
Test run	11
Directions for magneto-generator 6 Volt 23 Watt with tail-light armature	11
Tearing-up the engine	12
Lubrication and maintenance chart	12
Lubricants and sealants	12

INTRODUCTION

This repair manual is intended as a guide for an efficient repair and maintenance service.

It is in no way a substitute for the training of the repairmen in the After-Sales-Service school of our main factory.

We recommend, to use also the illustrated spare parts list as an additional source of information.

The proper place for this repair manual and for the technical information bulletins is the workshop and not the office filing cabinet.

FICHTEL & SACHS AG
D-8720 SCHWEINFURT
Service Department

For the Federal Republic of Germany, the law published on 2nd July 1969 on new units and measures came into effect on 2nd July 1970.

This implies necessarily an alignment to the international system of units (SI) that is already used by other countries.

The new units have been introduced in this repair manual.

Output: previously HP — now kW

Torque: previously kpm — now Nm

Revolutions: previously rpm — now 1/min

For an intermediary period, the previous units are shown in brackets.

Take care of the modified values,

e. g. 1 HP = 0.736 kW
1 kpm = 9.81 Nm (≈ 10 Nm)

In the interest of technical progress, we reserve the right to introduce modifications.

TECHNICAL DATA

Description:	SACHS 505/1 A	SACHS 505/1 A NL
	max. = 40 km/h	
Construction:	Single cylinder two-stroke petrol engine	
Cooling:	Air stream cooled	
Piston displacement:	47 cc	
Bore:	φ. 38 mm (1.496 in.)	
Stroke:	42 mm (1.653 in.)	
Compression:	8	
Output:	1.3 kW (1.8 HP) at 4500 1/min	1.25 kW (1.7 HP) at 4000 1/min
Engine lubrication:	Mixture of oil and petrol 1:50	
Gearbox:	Helical teeth spur gearwheels	
Gearbox lubrication:	250 cc of special SACHS gear oil or other oils, see oil level check, page 32	
Clutch:	Twin-plate centrifugal clutch with hand-operated starting clutch	
Ignition:	BOSCH-magneto-generator mainlight 6 Volt 15 Watt tail-light 6 Volt 2 Watt	
Spark advance:	2.5 . . . 3.0 mm (0.098 . . . 0.118 in.) before TDC	
Breaker points gap:	0.4 ± 0.05 mm	
Spark plug:	BOSCH W 175 T 1 electrode gap 0.5 mm (0.02 in.)	
Carburettor:	BING single slide carburettor *BING No. 85/12/101	
	Main jet	needle jet jet needle needle position slide
	52	2.17 2 II No. 2
Air cleaner:	Micronic air filter in intake silencer with built-in starting device	
Exhaust pipe:	26 mm I.D., length 400 mm and 24 mm I.D., length 200 mm inserted in the muffler	20 mm I.D., length 600 mm, 250 mm of which are inserted in the muffler
Engine sprocket:	11 teeth	

505/1 A NL Version SPARTA *BING No. 85/12/102 Main jet 50 (otherwise as 85/12/101)

DESCRIPTION ON ENGINE PLATE AND ENGINE TYPE

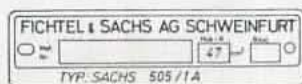

594

SACHS 505/1 A



REPAIR TOOLS AND MOUNTING JIG

TECHNICAL DATA - 505/1D - 30 mph Sachs Engine

Description	505/1D
Construction:	Single Cylinder two-stroke petrol engine
Cooling:	Air stream cooled
Piston displacement:	49 cc
Bore:	38 mm (1.496 in.)
Stroke:	44 mm
Compression:	8
Output:	N/A
Engine Lubrication:	Mixture of oil and regular gas at 1:50
Gearbox:	Helical teeth spur gearwheels
Gearbox lubrication:	250 cc of special SACHS gear oil or other oils, see page 12.
Clutch:	Twin-plate centrifugal clutch with hand operated starting clutch.
Ignition:	Bosch magneto-generator 6V 23/15W
Spark Advance:	1.75 ± .25 mm
Breaker point gap:	.016
Spark Plug:	Bosch W 175 T1 (gap .020)
Carburetor:	BING single slide carburetor BING No. 85/12/104 Main jet - #58 Slide #2
Air cleaner:	Micronic air filter intake silencer with built-in starting device.
Exhaust pipe:	26 mm ID, length 460 mm, 100 mm in muffler
Engine sprocket:	11 teeth

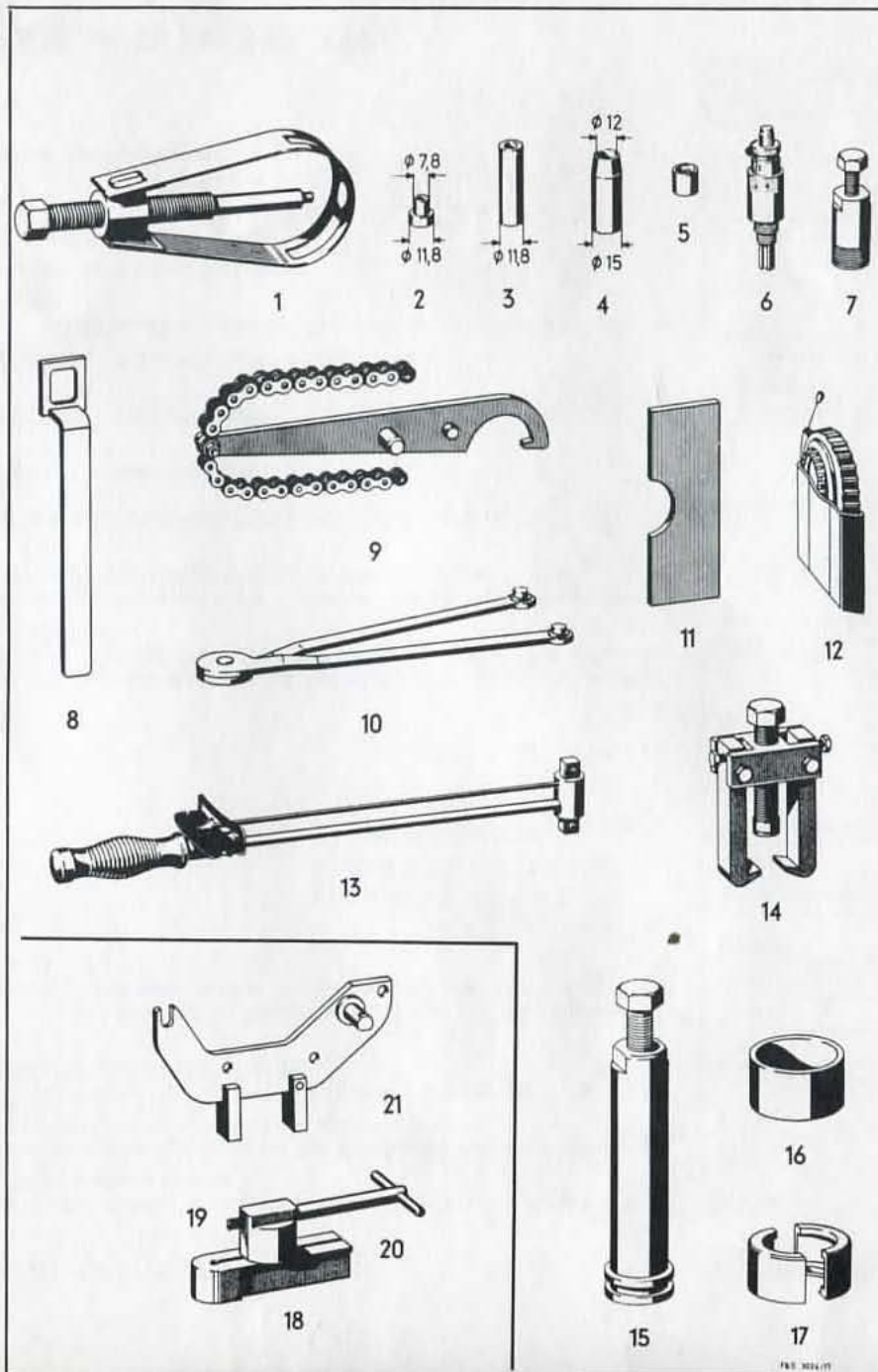

Repair Tools

- 1 Gudgeon pin extractor
- 2 Insert bush for gudgeon pin extractor
- 3 Gudgeon pin for piston
- 4 Protective sleeve for crankshaft (power take-off side)
- 5 Protecting cap, bore 10 mm
- 6 Spark advance timing gauge
- 7 Puller for magneto flywheel M 26 x 1.5
- 8 Holding tool for clutch
- 9 Hook wrench
- 10 Pin spanner, adjustable
- 11 Intermediate plate
- 12 Revolution counter
- 13 Torque wrench
- 14 Puller for sprocket
- 15 Puller sleeve ass'y.
 - Threaded sleeve
 - Hexagon bolt
 - Thrust bearing
 spare parts for 1476 013 000
- 16 Clamping ring, inner dia. \varnothing 58 mm (2.28")
- 17 Puller shells for grooved ball bearing

Mounting jig

- 18 Clamping base
- 19 Swivel unit
- 20 Clamping screw
- 21 Mounting bracket



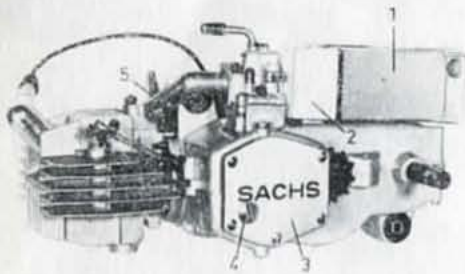

Bild/Fig. 1

DISMANTLING THE ENGINE

Remove the engine from the frame and clean it thoroughly before dismantling.

Intake silencer, carburettor and intake pipe

Remove the intake silencer cap (1) and the micro-nic air filter with the filter frame.

Remove starter slide with control cable and pressure spring.

Unscrew carburettor and intake pipe (5). Remove gasket or gasket, intermediate flange and gasket.

Unscrew the intake silencer housing (2) only in case of necessity.

Unscrew cover (3) with gasket.

Drain the gearbox oil.

Mount the engine

Mount the engine (lower part of crankcase upwards) with 2 hexagon head screws (1) M 8 x 65 and nuts to the mounting jig.

Cylinder

Unscrew the cylinder and remove the cylinder flange gasket.

Note:

The cylinder can be rebored once, to be used with the corresponding piston (see Spare Parts List). When fitting a new cylinder or a reconditioned cylinder with piston, the colour mark (red or white) on the piston crown and in the intake port of the cylinder must be of the same colour.

Piston and cover

Remove both wire circlips.

Push out the gudgeon pin with gudgeon pin extractor and insert bush (1).

Remove the needle cage.

Pry off the cover (2) or knock it off (use a screwdriver).

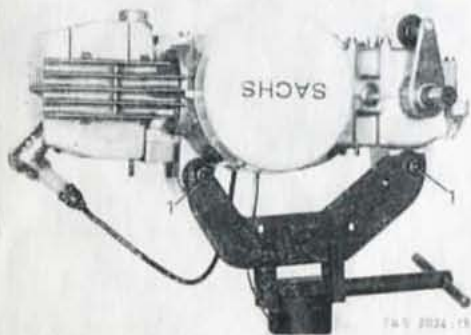

Bild/Fig. 2

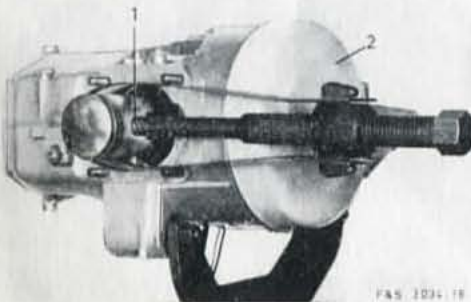

Bild/Fig. 3

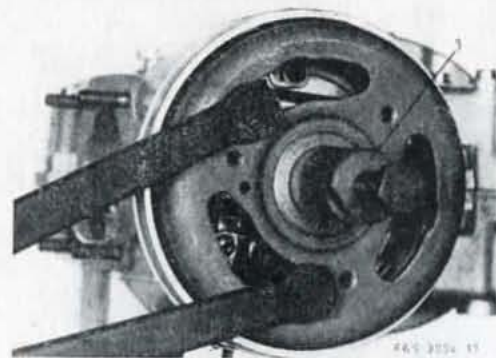

Bild/Fig. 4

Magneto flywheel

Insert adjustable pin spanner, as illustrated, unscrew the collar nut and remove the spring washer.

Slip on the protecting cap and pull the magneto flywheel with puller (1).

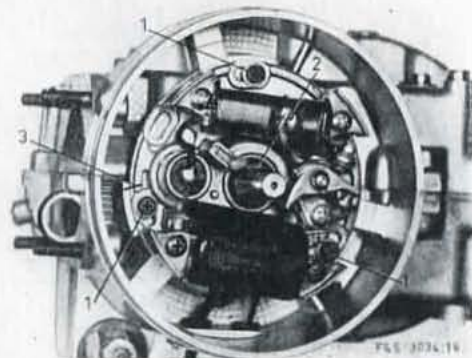

Bild/Fig. 5

Stator plate

Remove the spark plug connector from the ignition cable. Unscrew 3 cross head screw (1) with washers, remove the stator plate and the Woodruff key (2).

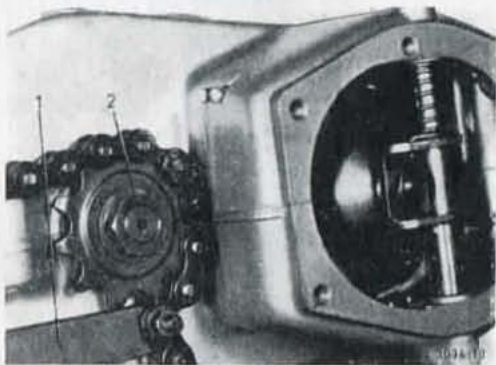

Bild/Fig. 6

Sprocket

Apply the hook wrench (1) with its chain to the sprocket, as illustrated, unscrew the nut (2) and remove the special washer.



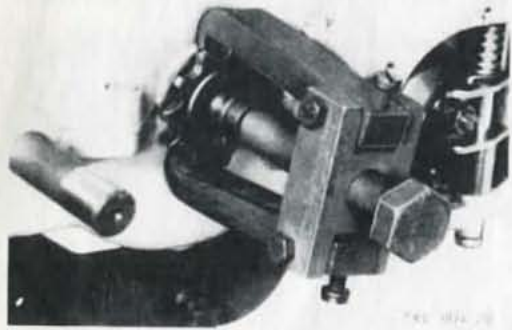

Pull off the sprocket.

Bild/Fig. 7

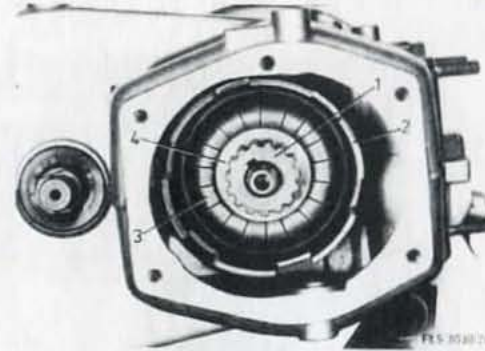

Remove the clutch hub (1) (if need be, loosen it with a slight blow).

Remove Woodruff key, if existing (to be omitted during remounting).

Remove the clutch case (2) with centrifugal weights (3), ring (4), clutch plate underneath it and the check plate.

Bild/Fig. 10

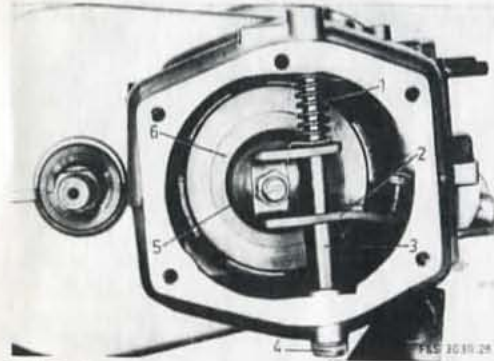

Starting and driving clutch

Unhook the torsion spring (1).

Unscrew the fillister head screw (4) with sealing ring, remove bush (3), clutch lever (2, with control cable) and torsion spring.

Remove thrust cup (5) with thrust pin.

Bild/Fig. 8

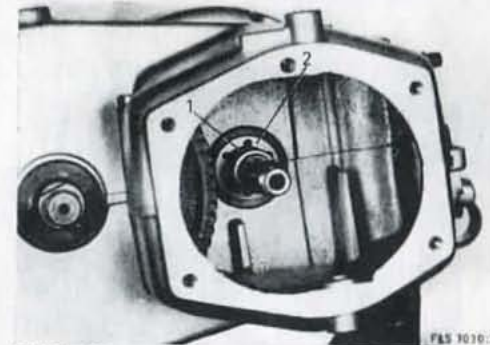

Remove bush (1) and check plate (2).

Note:

If the bush sticks, pull it off together with the grooved ball bearing (when exchanging the grooved ball bearings).

Bild/Fig. 11

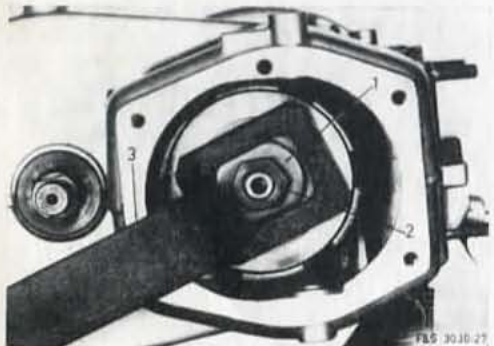

Hold the washer (1) with the holding tool, unscrew the nut (2).

Remove the washer (1), shims (6, Fig. 8), inner and outer plates with spring washers.

Bild/Fig. 9

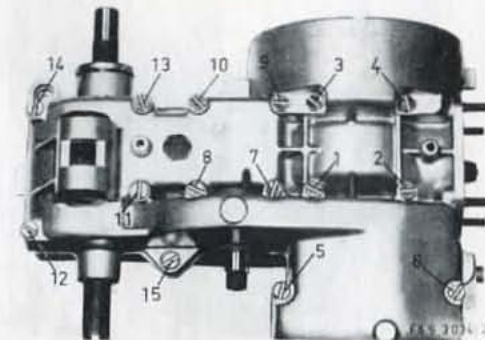

Splitting the crankcase

Unscrew 15 fillister head screws or internal hexagon head screws and remove the lower part of the crankcase.

Bild/Fig. 12



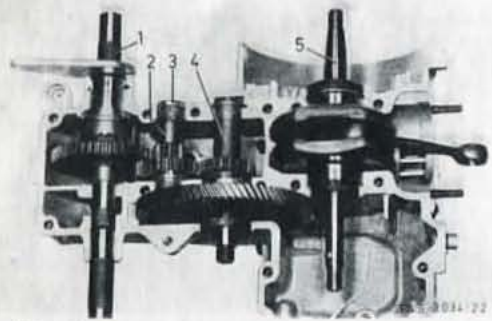

Bild/Fig. 13

Crankshaft and gearbox

Remove pedal shaft (1), gearshaft (2), cover plate (3), mainshaft (4) and crankshaft (5).

Unscrew the crankcase lower part from the mounting jig.

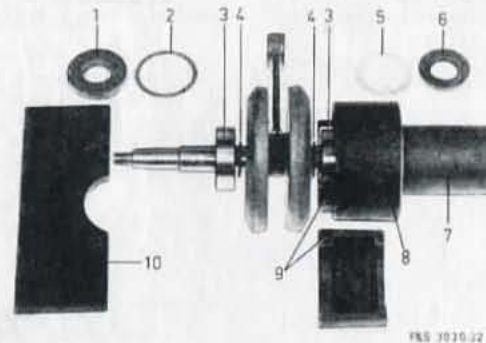

Bild/Fig. 14

Pre-assembly of crankshaft

Place the intermediate plate (10) between both crank webs and support it at both ends. The crankshaft must rest freely on it.

Heat the grooved ball bearings and press them home (3).

Fill the grooves of the oil seals with high melting point grease Alvania 3 and lubricate the sealing lips lightly.

Fit the washer (2) of 1.5 mm (0.059 in.) thickness and the oil seal (1) on magneto side crankshaft.

Fit the protective sleeve to the power take-off side crankshaft end and mount the 0.2 mm (0.007 in.) thick washer (5) and the oil seal (6).

WORKING ON INDIVIDUAL PARTS

Exchange of crankshaft bearings

Pulling the grooved ball bearings

Remove oil seals (1 and 6) and washers (2 and 5). Pull the grooved ball bearings (3) with puller shells (9), puller sleeve (7) and clamping ring (8).

Installation dimensions of crankshaft

The installation dimension of the crankshaft is, measured over both grooved ball bearings, 57.75 mm (2.273 in.).

There is no need to measure the crankcase.

Example:

Fitting dimension of crankshaft:	57.75 mm	2.273"
Dimension of crankshaft, measured over both crank webs:	34.20 mm	1.346"
Width of both grooved ball bearings:	+22.00 mm	0.866"
	<u>56.20 mm</u>	<u>-56.20 mm</u>
		2.212"
Difference to be compensated:	<u>1.55 mm</u>	<u>0.061"</u>

The difference of 1.55 mm (0.061 in.) is compensated by shimming washers to be fitted on the crankshaft directly under the inner races of the bearings.

Fit the 0.5 mm (0.020 in.) thick shimming washer on the clutch side and all others on the magneto side.

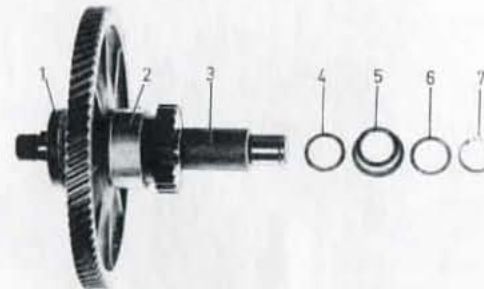

Bild/Fig. 15

Mainshaft with intermediate gear wheels ass'y

Disassembly

Remove oil seal (1), circlip (7), shim (6), sleeve (5) and shim (4).

Note:

The mainshaft (3) with layshaft gears and bearing (2) is available as an assembly only.

Assembly

Fill the groove of the oil seal with high melting point grease Alvania 3 and lubricate the sealing lip slightly.

For protecting the sealing lip of the oil seal, wrap the edges of the mainshaft with scotch tape and slide the oil seal on to a distance of approx. 6 mm (0.236 in.) to the layshaft gear.

Slide the 1 mm (0.039 in.) thick shim (4) and the bush (5, collar to the outside) on the mainshaft.

Fit shims (6) up to the groove for the circlip and insert the circlip (7).

Note:

The bush (5) must not have any axial play, but should still revolve easily.

Gearshaft

The gearshaft is available as an assembly only.

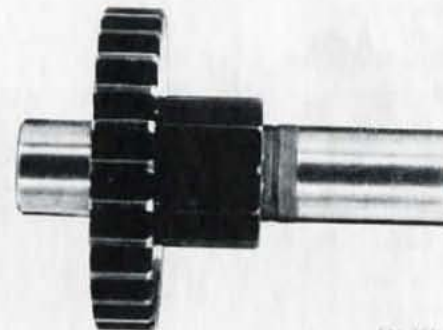

Bild/Fig. 16

Clean all parts, check them for wear and replace them if necessary.

It is advisable to replace all gaskets and seals when completely overhauling the engine.

Use only genuine **SACHS** spares!



NOTE: In wiring trouble shooting if field coils are correct voltage should occur in all wires except ground (green/black)

ATTENTION!

WHEN DISASSEMBLING THE MAIN JET ON THE BING CARBURETTORS 85/12/101 AND 85/12/102, THE LOOSE RING IN THE NEEDLE JET MUST NOT BE REMOVED, BECAUSE THE ENGINE FUNCTION WOULD SERIOUSLY BE AFFECTED!

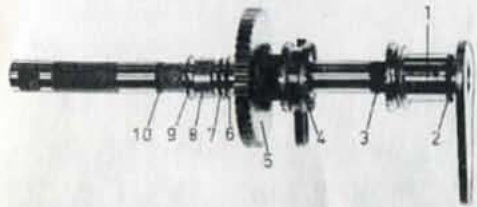

F&S 3034:25

Intake silencer and micronic air filter

Pay attention to versions, see spare parts list

Magneto-generator

Replacing the ignition or generating armature

Remove the defective armatures and replace them by new ones.

Ignition and generating armatures are available as spare parts ready to be fitted and can be mounted to the stator plate without special device. After fitting a new armature, it is absolutely necessary to check the air gap between the armature poles and the flywheel, because the maximum ignition and lighting output is achieved only with the specified air gap of 0.25 ... 0.35 mm (0.0098 ... 0.0138 in.).

A prerequisite for measuring and adjusting is a perfect condition of the crankshaft bearings. The air gap is to be measured at various positions through the recesses in the magneto flywheel. In case of deviations, slight corrections can be made by loosening the armature fitting screws and repositioning the armature. The adjustment can also be made through the recesses in the magneto flywheel.

Replacing the breaker points

1. Remove the breaker points. Unscrew pivot pin, if screwed in.

Attention!

Pivot pin is caulked. New breaker points (pivot pin riveted to contact carrier) and new stator plates are manufactured without threads. Use only the breaker points specified for this engine.

2. Lubricate the lubricating pad before installation with BOSCH grease Ft 1 v 4 and apply the grease wedge to the rub block. Make sure that no oil or grease gets on the breaker points.
3. Insert new breaker points into the through - or thread bore and fasten.
4. Fasten short-circuiting cable.

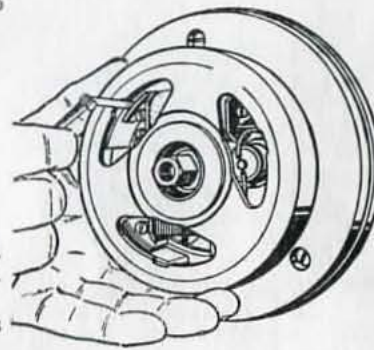

Fig. 10

Replacing the condenser

1. Unsolder both cables.
2. Press the condenser out of the stator plate with a wooden dowel.
3. Scrape the high spots at the bore for the condenser, caused by previous swaging.
4. Fit the new condenser and swage carefully.
5. Resolder both cables.

Decarbonizing the exhaust system and the cylinder

Carbon deposits in the combustion chamber, in the exhaust port of the cylinder and in the exhaust system must be removed at the latest when the engine output drops or if the engine tends to four-stroke in spite of correct carburettor setting.

Usually, cleaning will be required after 3000 ... 4000 km (1900 ... 2500 miles).

Exhaust system

Remove the exhaust system.

Clean the inside of the exhaust pipe by pulling a commercial wire brush through it.

The exhaust silencer should be stripped for cleaning; heat the insert to red-hot and knock or scrape off any remaining deposits. Remove carbon deposit from the tie-bar and in the end piece.

Do not modify or tamper with the inside of the exhaust system. Any such modifications not only adversely effect fuel consumption, engine performance and noise, but are also against regulations and will be prosecuted!

Cylinder

Unscrew the cylinder and remove carbon deposit in the combustion chamber with a screwdriver.

Avoid damages to the combustion chamber surface. Remove carbon deposit from the exhaust port and in the transfer ports with a screwdriver.

Piston

Carefully remove only large carbon deposits (flakes) from the piston head.

Do not attempt to scrape the piston head bright.



Bild/Fig. 17

Pedal shaft

Disassembly

Remove driving sleeve ass'y (1), driver (4) with brake spring, annular sealing rings (2, 3 and 10), washer (9), 1 mm thick, and sleeve (8).

Remove circlip (7), washer (6), 1 mm thick, and starting wheel (5).

Assembly

Mount the parts in reverse sequence.

Carburettor

The carburettor type and the jet sizes are selected by means of tests in the factory.

Final adjustments, if required, are to be made with the jet needle. Raising the jet needle position produces a richer mixture, lowering it produces a leaner one.

Changing the jet needle position can have an effect on the composition of the fuel mixture only in the lower and medium revolution range.

Upon opening the throttle, the engine should not "cough", nor should the revolutions drop at any throttle position. If the engine splutters or falters or if black fumes are coming out of the intake silencer, the mixture is too rich. Repeated short blow-backs or "sneezing" and starting difficulties denote too lean a fuel mixture.

Wash the carburettor from time to time in petrol, check all parts for wear and replace them, if necessary.

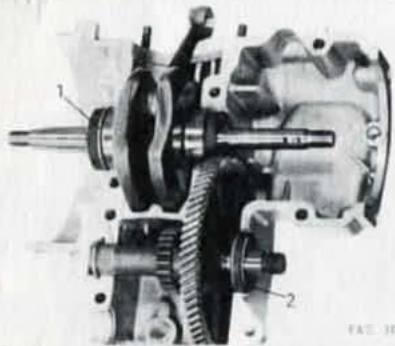

F&S 3034-20

Bild/Fig. 19

REBUILDING THE ENGINE

Mount the crankcase upper part with 2 hexagon head screws M 8 x 65 and nuts to the mounting jig (see Fig. 2).

Coat the mating surfaces of the crankcase parts with Loctite 572; do not apply sealing compound to the bearings.

Crankshaft and mainshaft

Insert the pre-assembled crankshaft.

Make sure that the washer (1) engages in the groove of the crankcase upper part and that both oil seals be uniformly in contact (to the inside).

Insert the pre-assembled mainshaft; the oil seal (2) must slightly protrude over the outer edge of crankcase.

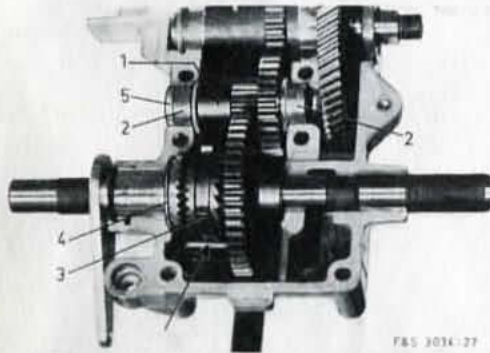

F&S 3034-27

Bild/Fig. 20

Gearshaft and pedal shaft

Insert gearshaft with distance sleeve (1), sleeves (2) and cover plate (5).

Insert pre-assembled pedal shaft, washer (4) must be in contact with the collar of the driver and brake spring (3) must engage between the two paths (see arrow).

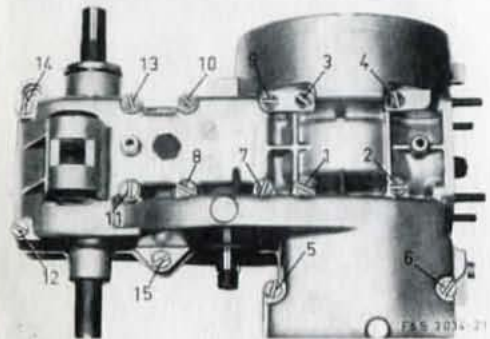

F&S 3034-21

Bild/Fig. 21

Put on the lower part of crankcase and fit the oil seal (2, Fig. 19) flush with the outer edge of crankcase.

Screw the parts of the crankcase together with 10 fillister head screws (1 ... 4, 7 ... 11 and 13) M 6 x 70, 4 fillister head screws (5, 6, 12 and 14) M 6 x 55 and 1 fillister head screw (15) M 6 x 22.

Attention!

Tighten the fillister head screws in the sequence depicted from 1 ... 15.

Tightening torque 10 ... 12 Nm (1 ... 1.2 kpm).

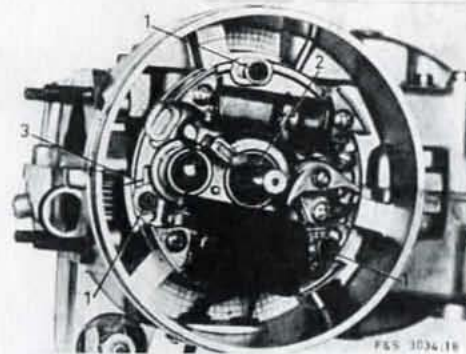

F&S 3034-18

Bild/Fig. 22

Stator plate

Insert woodruff key (2).

Pass the ignition-, lighting- and short-circuiting cable through the rubber grommets, fit the stator plate, taking care of the marking lines (3). New stator plates do not have marking lines and shall be fastened in the center of their fitting slots.

Coat 2 cross head screws (1) M 4 x 14 and washers with "Diamant" sealant and tighten them.

Tightening torque 3 ... 4 Nm (0.3 ... 0.4 kpm).

Fasten spark plug socket on the ignition cable.

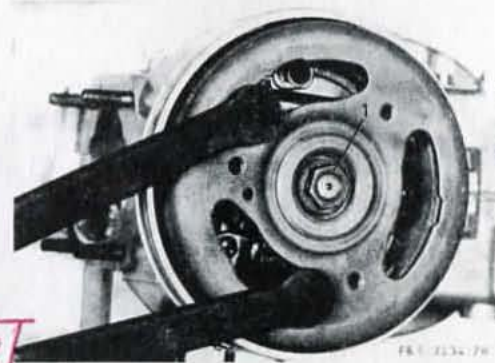

F&S 3034-19

Bild/Fig. 23

Magneto flywheel

Remove any traces of grease from the tapers of crankshaft and magneto flywheel (Tri or petrol).

Fit the magneto flywheel, pay attention to woodruff key, insert the spring washer and fasten it with the collar nut (1) M 10 x 1. Use adjustable pin spanner.

Tightening torque 37 ... 40 Nm (3.7 ... 4 kpm).

Use Liquid Gasket

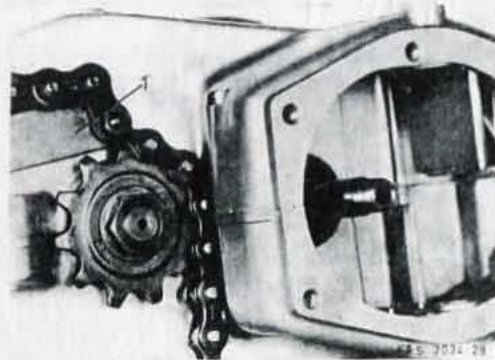

F&S 3034-29

Bild/Fig. 24

Sprocket

Fit the sprocket (ground face showing downwards), put on the special washer and fasten with nut M 12 x 1.

Use hook wrench (1) with chain, as illustrated.

Tightening torque 50 ... 60 Nm (5 ... 6 kpm).



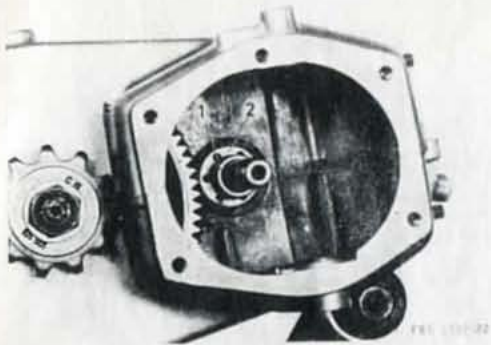

Bild/Fig. 25

Centrifugal clutch

(Starting and driving clutch)

Put on the thrust washer (2), its chamfer pointing to the crank web.

Fit the sleeve (1) completely into its seat, if necessary by tapping it slightly.

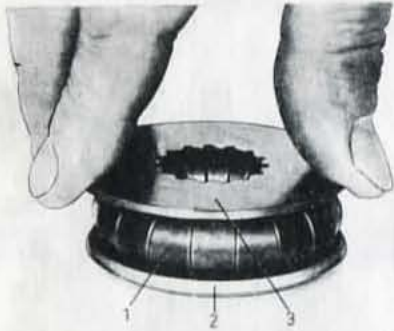

PLS 3010-34

In order to avoid a wrong adjustment of the axial play of the clutch plates, the flyweight must rest flatly on the plates when installing it.

Tap the flyweight (1) slightly on a flat surface, put it into the clutch plate (2), align it by pressing and turning the inner clutch plate (3).

Bild/Fig. 26

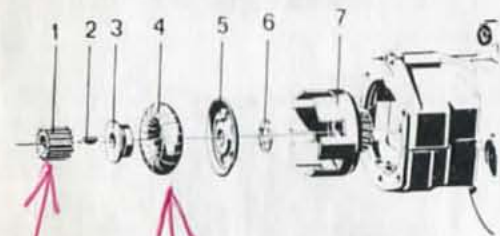

Bild/Fig. 27

Fit the clutch case (6) and put on the thrust washer (5, chamfered side showing downwards).

Mount the clutch plate (4), insert the flyweight (3), fit the ring (2) and mount the clutch hub (1).

Note:

Fit clutch hub, also when nut is existing, without Woodruff key.

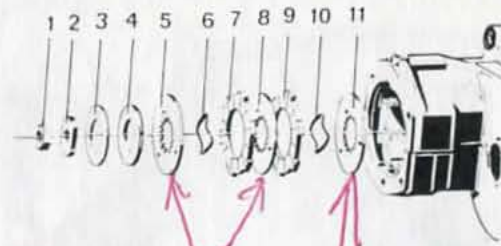

Bild/Fig. 28

thicker

thinner

On SACHS 505/1 A, 505/1 A NL and 505/1 C engines, insert inner plate (11) 1.7 mm thick, outer plate (9), spring washer (10), inner plate (8), 2.5 mm thick, outer plate (7), spring washer (6) and inner plate (5) 2.5 mm thick.

Fit shimming washers (3 and 4) as required, insert washer (2) and screw on nut (1), see axial play.

On SACHS 505/1 B engine, insert inner plate (11) 1.7 mm thick, outer plate (9), spring washer (10), inner plate (8) 1.7 mm thick, outer plate (7), spring washer (6) and inner plate (5) 1.7 mm thick.

Fit shimming washer (4) 1.7 mm thick and shimming washer (3) as required, insert washer (2) and screw on nut (1), see axial play.

← spacer shims Available

Check the axial play between shimming washers (3 and 4) and washer (2) and fit as many shimming washers as are necessary for achieving an axial play of 0.4 . . . 0.6 mm (0.016 . . . 0.024 in.).

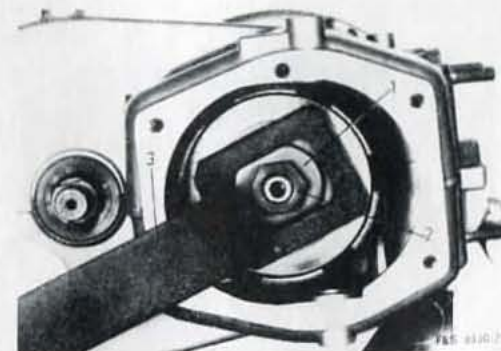

Bild/Fig. 29

Remove any traces of grease from the threads of crank pin and nut (Tri or petrol), coat them with Loctite AAV, screw on the nut, hold the washer (1) with holding tool (3) and fasten the nut.

Tightening torque 35 . . . 40 Nm (3.5 . . . 4 kpm = 25.3 . . . 28.9 ft lb).

Note:

When turning the chain sprocket, the clutch case must rotate freely.

centrifugal weight assembly

centrifugal hub



NOTE: TIMING NUMBERS, COMPASS SET FOR SPARK PLUG ANGLE

Picture upside down

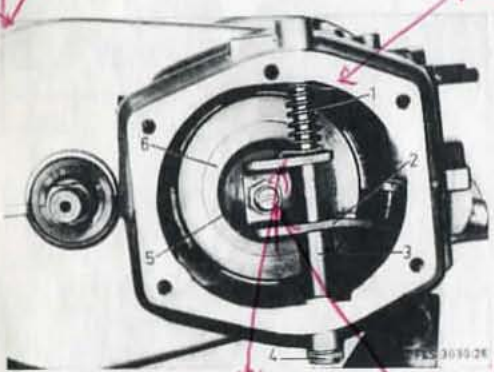

Mount thrust cup (5) with thrust pin.
 Hook the control cable for the starting clutch to the clutch lever (2) and pass it through the bore in the housing.
 Insert fillister head screw (4) M 8 x 1 x 100 with sealing ring, fitting at the same time the sleeve (3), clutch lever and the torsion spring (1), fasten the fillister head screw and hook the torsion spring on the housing.
 For adjusting the clutch lever, see Fig. 38.

Bild/Fig. 30



Bild/Fig. 31

Needle cage and piston

Put on the cylinder flange gasket, its graphitized side towards the crankcase.
 Install the oiled needle bearing in the connecting rod eye. Locate the piston with the locating pin (arrow pointing to exhaust) on the connecting rod. Use a self-made wooden fork (1).
 Push in the gudgeon pin (press fit, heat piston, if necessary) and install both wire spring rings.

Cylinder

Mount the cylinder, slightly oiled (exhaust pipe showing to the lower part of crankcase), (remove wooden fork) and fasten it with 4 nuts M 6 and washers diagonally.
 Tightening torque 8 ... 10 Nm (0.8 ... 1 kpm) = 5.7 ... 7.2 ft lb).

Bild/Fig. 32

Hook
Pin
Back off 1/4" from touching

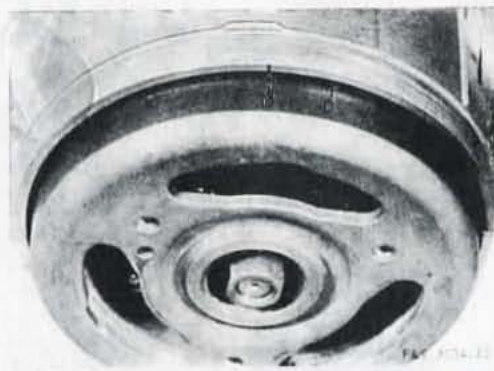

Bild/Fig. 33

Attention!

For a spark advance of 2.5 ... 3.0 mm (0.098 ... 0.118 in.) before TDC, it is necessary, owing to the inclination angle of 45° (spark plug bore in relation to the piston stroke) to set the F & S spark advance timing gauge at 3.5 ... 4.2 mm (0.138 ... 0.165 in.).

On the magneto flywheel and on the housing, marks have been punched.

"O" coincides with the chisel mark on the housing if the piston is at top dead center.

"M" coincides with the chisel mark on the housing in the firing position.

Ignition timing - 505/1D

It is recommended to check the ignition timing each time the engine is serviced, because the engine performance depends on it.

Also check the spark plug gap (0.5mm = 0.020 in.).

Spark advance: 1.75 ± .25 mm (20...30°) before TDC

Breaker points gap: 0.4 ± 0.05 mm

Measuring instruments:
 Spark advance timing gauge,
 Feeler gauge 0.4 mm

Attention!

For a spark advance before TDC, it is necessary, owing to the inclination angle of 45° (spark plug bore in relation to the piston stroke) to set the F & S spark advance timing gauge at 2.5 ± .25.

On the flywheel and on the housing, marks have been punched.

"O" coincides with the chisel mark on the housing if the piston is at top dead center.

"M" coincides with the chisel mark on the housing in the firing position.

Firing position for magneto generator:
 6V 23/15 W

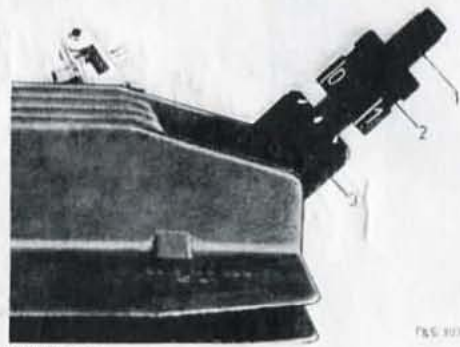

Bild/Fig. 34

Ignition timing - 505/1A

It is recommended to check the ignition timing each time the engine is serviced, because the engine performance depends on it.

Also check the spark plug gap (0.5mm = 0.020 in.).

Spark advance: 2.5 - 3 mm before TDC (0.098 ... 0.118 in.)

Breaker points gap: 0.4 ± 0.05 mm

Measuring instruments: Spark advance timing gauge, Feeler gauge 0.4 mm



Measuring and establishing ignition markings

If there are no ignition markings, the top dead center and the firing position must be determined anew with the spark advance timing gauge and marked.

Example:

1. Place piston at top dead center, using the spark advance timing gauge.
2. Punch the chisel mark on the crankcase (Fig. 34 or 35) or the "O" mark on the flywheel (Fig. 34 or 35).
3. Screw the adjusting nut (2, Fig. 36) until it slightly touches the bush (3, Fig. 36) and turn this nut back by the amount of the spark advance.
One whole turn of the adjusting nut corresponds to 1 mm (0.039"). The marks on the adjusting nut (= 0.25 mm = 0.0098") and on the guide bush (0.1 mm = 0.039") allow to set the spark advance correctly.
4. Turn the flywheel against the direction of rotation until the adjusting nut touches the bush (the piston must be in contact with the adjusting bolt (1, Fig. 36)).
5. Punch the "M" marking to the flywheel.

Adjustment procedure for ignition setting:

1. Set the breaker points gap at maximum lift of cam at 0.4 ± 0.05 mm.
2. Turn the flywheel so far until the "M" marking on the flywheel coincides with the chisel mark on the crankcase.
3. Turn the flywheel slightly in the direction of rotation; now, the breaker points must start opening. If not, adjust the ignition point by turning the stator plate in its slots.

Turning the stator plate against the direction of rotation of the flywheel advances the ignition, turning it in the direction of rotation retards the ignition.

4. After each adjustment, fasten the stator plate fitting screws.

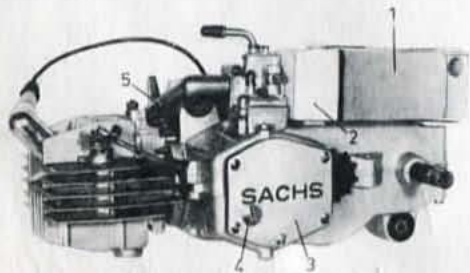

Bild/Fig. 35

Cover

Mount the cover (2, Fig. 3) with light rubber mallet blows.
Remove the engine from the mounting jig.

Intake pipe, carburettor and intake silencer

Put on gasket (or gasket, intermediate flange and gasket) and fit intake pipe by means of 2 hexagon head screws M 6 x 35 (for 505/1 C M 6 x 25) and washers.

Stick round sealing on the tightened collar of the intake pipe and put on and fasten the carburettor.

Put round sealing ring on the carburettor side of intake silencer housing (2), insert the plate into the housing and fasten it with 3 resp. 2 fillister head screws M 5 x 10 to the carburettor.

Fit pressure spring and choke slide over the control cable and insert it in the intake silencer housing.

Fit micronic air filter with filter housing into the intake silencer cap (1) and fasten it to the intake silencer housing with a clip.

Fill in the gearbox oil

Fill into the clutch housing 250 cc special SACHS gear oil (F & S part No. 0263 014 002) or other oils, see oil level check, page 33.

Coat only the mating surface of the clutch housing with sealing compound No. 40, put on the gasket and fasten the cover plate (3, Fig. 37) with 5 lens head screws M 5 x 14.

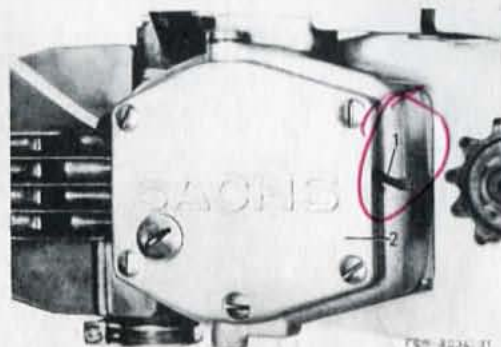

Bild/Fig. 36

OPERATIONS AFTER ENGINE OVERHAUL

Fitting and lubricating the control cables

Before mounting the engine into the frame, check the control cables, control levers and twist grips and replace damaged parts.

Control cables should be greased or oiled before fitting. Make sure that the control cables run in large curves and are not jammed. Control cables and control levers must always operate smoothly.

The diameter of the inner control wire should be 1.6 mm (0.063 in.), the inner diameter of the outer casing 2.5 mm (0.098 in.).

Make sure strings removed

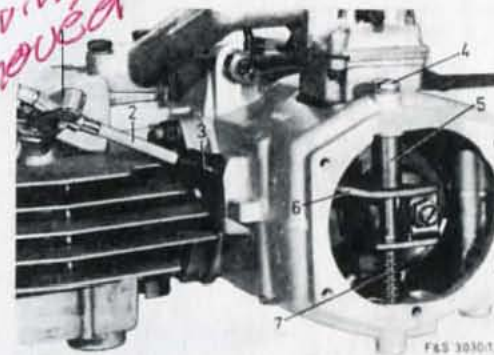

Bild/Fig. 37

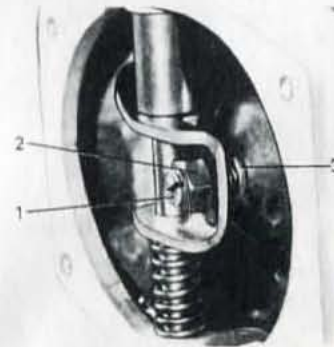

Bild/Fig. 38



Exhaust system

Tighten at first the cleaned exhaust system to the cylinder and tighten to the frame, in order to prevent stress within the system.

Connect fuel line to the **carburettor**.

Brake linkage

Fasten brake linkage in brake lever on engine.

Removing and connecting the starter clutch control cable in the engine

Removing

Loosen the control wire at the starter lever (handle bars). Unscrew the cover.

Unhook the torsion spring (7), unscrew the fillister head screw (4) with sealing ring, remove bush (5), clutch lever (6, with control wire) and torsion spring.

Connecting

Hook the new control wire at the clutch lever, insert it through the bore in the housing and mount the parts in the reverse order.

Fit the outer casing (2) with rubber cap (3), insert the control wire through the decompressor (1) and fit outer casing. Pass the control wire through the starter lever.

Adjusting the starter and decompressor lever

Screw the adjusting screw (1) up to the slightly perceptible stop at the pressure pin (3), then turn it back by $\frac{1}{4}$ turn, so that there is a slight play between the pressure pin and the adjusting screw. Lock the adjusting screw with nut (2).

Adjust the reach of screw of the adjusting screw at the starter lever (at the handle bars).

Pull the control wire out up to the stop and fasten it. Adjust the adjusting screw so that the starter lever has 1 ... 2 mm (0.04 ... 0.08 in.) play.

Lock the adjusting screw.

On starter levers without adjusting screw, pull the control wire out up to the stop and push it back until there is a play of 1 ... 2 mm (0.04 ... 0.08 in.) for the outer casing between the decompressor and the starter lever, then clamp the control wire fast.

Note:

If the starter clutch slips during the starting procedure, check the axial play of the clutch plates (see Fig. 38) and adjust it again.

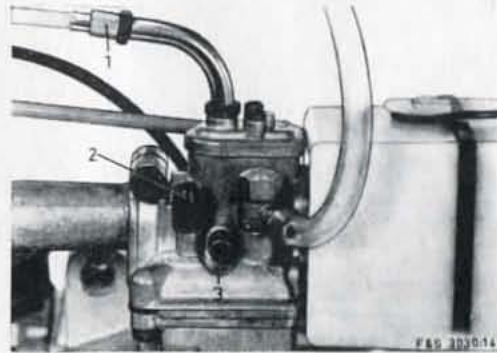

Bild/Fig. 39

Test run

Adjusting the carburettor

Adjust the carburettor while the engine is warm. In order to ensure that during normal operation the choke is out of operation, the control wire for the choke must have a play of 1 ... 2 mm (0.04 ... 0.08 in.).

Unscrew the throttle stop screw (3) and adjust the control wire so that the throttle is completely closed. Screw the throttle slide stop screw so that the engine, under operating temperature and with throttle twist grip closed, runs perfectly smooth.

Adjust the adjusting screw (1) so that the control wire between the carburettor and the throttle twist grip has a play of 1 ... 2 mm (0.04 ... 0.08 in.).

Note:

The above adjustment must be accomplished with utmost care, because the centrifugal clutch will engage if the engine idles too fast.

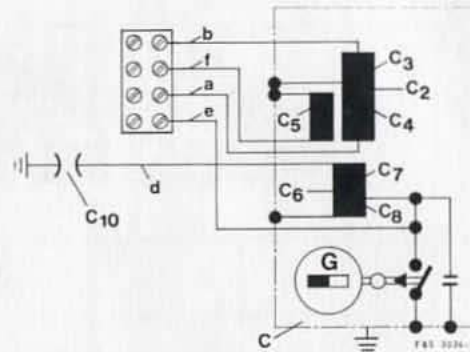

Bild/Fig. 41

*Normal clip
2 from top on
carburettor pin*

DIRECTIONS FOR MAGNETO-GENERATOR

6 Volt 23 Watt with tail-light armature

Terminals to:

Lighting circuit a (yellow)

Mainlight 6 Volt 15 Watt

Alternating current rattle (horn) 6 Volt

Stop-light circuit b (green)

Stop light 6 Volt 5 Watt

Tail-light circuit f (grey)

Tail-light 6 Volt 3 Watt

Short-circuiting wire e (black)

Short-circuiting switch or button

Ignition cable d

C = Magneto-generator

C₃ = Generator armature

C₅ = Stop light winding

C₄ = Mainlight winding

C₆ = Tail-light armature (inductive)

C₇ = Ignition armature

C₈ = Secondary winding

C₉ = Primary winding

C₁₀ = Spark plug

Note:

For terminal wirings (terminals and colour of winding) see wiring diagram of the vehicle manufacturers.



LAYING-UP THE ENGINE

If the engine is not used for a longer time, there arises danger of rust.

For preserving the bearings, the crankshaft and the piston sliding surface, remove the spark plug and squirt through the carburettor intake 8...10 cc (0.3...0.4 fl oz) of anti-corrosion oil (viscosity SAE 30) of well-known oil companies, while working the starting device several times.

For protecting the outside of the engine, we also recommend anti-corrosion oil of well-known oil companies.

Attention!

If the vehicle is being stored for a longer period with fuel in the tank, there arises the risk of dissociation of the oil/petrol mixture. In such cases we strongly recommend, before starting the engine again, to mix the oil/petrol mixture again by stirring or shaking or to replace it. Fuel residues in the fuel- or carburettor systems, as well as damages by rust inside and outside the engine, are not covered by the warranty.

LUBRICATION AND MAINTENANCE CHART	Service Every ▼			
	625 miles	1875 miles	3750 miles	if necessary
Lubricant, quantity of lubricant and maintenance operations				
Micronic air filter in the intake silencer If the micronic air filter is very dirty, replace it by a new one; if it is only slightly dirty, remove dust deposit by blowing it out cautiously. Clean the intake silencer halves in petrol.	X			X
Spark plug Provisional cleaning of the spark plug from carbon deposit on the ceramic insulator and between the electrodes. A complete cleaning can only be achieved with a sand blaster. Check the electrode gap (0.5 mm = 0.020 in.); if the electrodes are heavily burned, replace the plug.				X
Control cables If special lubricating nipples are fitted to the cables, lubricate them with thin oil, otherwise remove the control cables and grease the inner wires well.		X		
Chain Clean and lubricate with oil. The closed end of the spring clip of the chain link shows in the running direction of the chain. Chain sag approx. 3 cm (1.2 in.).	X			

LUBRICATION AND MAINTENANCE CHART

Lubricant, quantity of lubricant and maintenance operations	Service Every ▼			
	625 miles	1875 miles	3750 miles	if necessary
Oil level check Place the vehicle, with the engine at operating temperature, level and screw out the oil level check plug (4, Fig. 35). If the oil level in the crankcase is lower than the oil check bore, pour in special SACHS gear oil until it starts emerging from the oil check bore. New filling (upon assembling) 250 cc. Special SACHS gear oil (F & S part No. 0263 014 002) or SHELL-Donax T 6 BP-Automatic Transmission Fluid ESSO ATF 55 DEA Fluid 684 (ATF) SUNOCO Transmatic Fluid AQ-ATS 737 A. CASTROL-TQ OPTIMOL-H 1738 MOBIL-Fluid 200 Y Deutz oil HY-F GM	X			
Fuel strainer Clean the fuel strainer (screwed together with the fuel tap in the fuel tank).				X
Carburettor Clean the carburettor body and the components in petrol. Take care of the ring under the main jet (see page 15). Jet bores to be blown with compressed air only.				X
Starter clutch Adjusting (see page 28).				X
Ignition set Check and adjust the breaker points after 500 km, after 1000 km and then after 3000 km (after 310 miles, after 620 miles and then after every 1860 miles). Apply BOSCH grease Ft 1 v 4 to the lubricating pad for the breaker cam.		X		
Engine and exhaust system Decarbonizing (see page 17).			X	
Cylinder wall, con-rod bearings, crankshaft bearings Lubricate with two-stroke mixture, i. e. special SACHS engine oil (F&S part No. 0263 005 100, in tins containing 250 cc = 0.8 fl oz pre-mixed, for 1 l = 2.6 US gal of petrol) or preferably two-stroke oils, or, if need be, other branded oils (SAE 30 or 40) of leading oil companies, to be mixed with petrol in 1:50 ratio.				

LUBRICANTS AND SEALANTS

required for rebuilding the engines

Sealant No. 40 (F & S Part No. 0999 107 000)
Sealant "Diamant Typ OW"
Loctite AAV Loctite 572
Alvania 3 (High melting point grease)
BOSCH grease Ft 1 v 4



NOTES