

# **RTD COMMUTER RAIL DESIGN CRITERIA**



Prepared by the  
Engineering Division  
Regional Transportation District  
1560 Broadway  
Denver, CO 80202

September 2007  
**REVISION 01 - APRIL 2009**



April 20, 2009


The RTD Commuter Rail Design Criteria Manual includes general guidelines and specific criteria to be used in the planning, design and construction of Commuter Rail (CR) corridors within the Regional Transportation District (RTD). The RTD Commuter Rail Design Criteria Manual complies with safety and security requirements and is compatible with the intended future systems that RTD will construct. The Manual references and requires the use of the most current accepted industry practices and applicable codes.

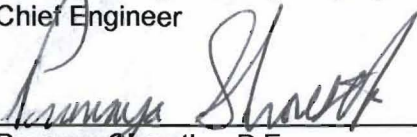
The CR Criteria have been prepared to interface with RTD's light rail and bus systems, forming an integrated public transportation network that addresses the transportation needs of the public within the District. This Manual establishes guidelines, criteria and standards to be used in the planning, design and construction process. Any deviations from these accepted criteria must be approved by RTD Engineering or the RTD Executive Safety and Security Committee, as specified.


Coordination with local agencies and jurisdictions is required to determine and approve fire protection, life safety and security measures that will be implemented as part of the planning, design and construction of the CR system. Conflicting information or directives within the criteria set forth in this Manual shall be brought to the attention of RTD and will be addressed and resolved between RTD and the local agencies and/or jurisdictions.


The initial version of the RTD CR Design Criteria Manual was published in September 2007. This version represents the first revision to the Manual. Any updates or modifications to the Manual shall take precedence over previous versions or sections of these criteria.


Approved by:

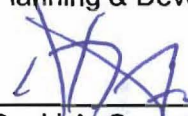
  
\_\_\_\_\_  
John C. Shonsey, P.E.  
Senior Manager of Engineering  
Chief Engineer


  
\_\_\_\_\_  
Pranaya Shrestha, P.E.  
Manager, Systems Engineering

  
\_\_\_\_\_  
Henry J. Stoppicamp, P.E.  
Engineering Technical Services Manager

  
\_\_\_\_\_  
Stan A. Szabelak, P.E.  
Civil Engineering Project Manager

  
\_\_\_\_\_  
Richard F. Clarke  
Acting Assistant General Manager  
Planning & Development/Engineering

  
\_\_\_\_\_  
David A. Genova  
Assistant General Manager  
Safety, Security and Facilities

  
\_\_\_\_\_  
Cal Shankster  
Acting Assistant General Manager  
Rail Operations

## TABLE OF CONTENTS

TITLE	SECTION
General Information .....	1
Operations Plan .....	2
Civil Engineering .....	3
Track Geometry and Trackwork.....	4
Station Design.....	5
Bridges and Structures.....	6
Communications and Central Control .....	7
Signal System .....	8
Traction Electrification System.....	9
Corrosion Control .....	10
Operations Facility .....	11
System-Wide Electrical .....	12
Commuter Rail Vehicles.....	13
System Safety and System Security .....	14

**TABLE OF CONTENTS**  
**SECTION 1 – GENERAL INFORMATION**

1.1	PURPOSE .....	2
1.2	SCOPE .....	2
1.3	PROCEDURES .....	3
1.4	DESIGN CODES AND MANUALS .....	3
1.5	CLIMATIC CONDITIONS FOR SYSTEMS DESIGN .....	5
1.6	CORRIDOR CONVENTION .....	7
1.7	ACRONYMS AND ABBREVIATIONS .....	7
1.8	UNITS OF MEASURE .....	12

## **SECTION 1 - GENERAL INFORMATION**

### **1.1 PURPOSE**

This manual establishes basic criteria to be used in the design of the Regional Transportation District's (RTD) Commuter Rail (CR) system. In addition, drafting standards, directive or sample drawings and management procedures have been prepared to standardize and guide the design activities and the preparation of contract documents. See separate design criteria for Light Rail Transit.

Design is to be directed toward minimum feasible costs for design, construction, capital facilities and operation; minimum energy consumption and minimum disruption of local businesses and communities. It should be consistent with system reliability, passenger comfort, mode of operation, type of Commuter Rail vehicles to be used and maintained. Safety for passengers, workers and the public is of primary importance.

### **1.2 SCOPE**

The Design Criteria will take precedence over all other standards referred to herein except those fixed by legislation. Where Commuter Rail operates on railroad trackage, or shares right-of-way with freight rail trackage, the design requirements and concepts of the dominant railroad (BNSF or Union Pacific Railroad (UPRR)) shall be used if more stringent than standards presented in this design criteria manual. This will be defined and finalized as the FasTracks Program proceeds on a corridor-by-corridor basis.

Specific attention should be given to the Americans with Disabilities Act (ADA), the ADA Accessibility Guidelines for Building and Facilities (ADAAG), the ADA Accessibility Guidelines for Transportation Vehicles and to any succeeding modifications that may be issued. The applicability of those documents is noted in several sections of this manual where it appears to be particularly appropriate. However, the regulations must be adhered to in all areas, whether or not mentioned herein.

The Design Criteria in this manual relates to the following elements of the Commuter Rail system:

- Operations
- Civil and Structural Engineering
- Track Geometry and Trackwork
- Utilities
- Landscaping
- Stations
- Operations Facility
- Signal System
- Communications and Central Control

- Fare Collection Equipment
- Commuter Rail Vehicles
- System Safety & System Security

### **1.3 PROCEDURES**

Design Engineers shall prepare drawings and technical specifications for each contract of the project in accordance with their design contract (if applicable) and the following RTD documents:

- Design Criteria Manuals
- CADD Standards
- Contract Requirements
- All other applicable requirements including codes, regulatory standards and environmental impact statements

Deviations may be made within the framework of the Design Criteria to meet the requirements of a particular issue. However, any deviation, discrepancy or unusual solution must be approved by RTD before it can be included in the design. It is the responsibility of the Design Engineer to identify, explain and justify any deviation from the established criteria and to secure the necessary approvals from RTD. Any variation from these Design Criteria must be submitted to and approved by RTD's Executive Safety and Security Committee.

All proposed deviations to these criteria shall be approved by RTD in writing.

### **1.4 DESIGN CODES AND MANUALS**

In addition to this Design Criteria Manual, the Design Engineer must comply with all other applicable engineering codes and standards, including those of the various Federal, State, and local jurisdictions.

If codes and/or manuals are specified herein for the design of an element of the RTD CRT system, then the most recent edition(s) shall be used. Responsibility for design remains with the Design Engineer in accordance with the terms and conditions of their contract with RTD.

Where design codes conflict with each other, the Design Engineer shall notify RTD in writing and recommend a solution. The Design Engineer shall also investigate those codes and manuals that have precedence.

Specific codes and standards include, but are not limited to, the following:

- Americans with Disabilities Act (ADA)
- Americans with Disabilities Act Accessibility Guidelines for Buildings and Facilities (ADAAG)
- Americans with Disabilities Act Accessibility Guidelines for Transportation Vehicles

- Colorado Department of Transportation (CDOT) - Standard Specifications for Road and Bridge Construction
- CDOT - Standard Plans (M&S Standards)
- CDOT - Highway Design Manual
- CDOT – Drainage Design Manual
- City and County of Denver - Rules for Street Standards
- City and County of Denver - Standard Construction Specifications
- FHWA - Manual on Uniform Traffic Control Devices for Streets and Highways (MUTCD)
- Colorado Public Utilities Commission (PUC)
- RTD - Light Rail Design Criteria
- RTD - Design Guidelines and Criteria for Bus Transit Facilities
- RTD - Standard Plans for Bus & Light Rail Transit Facilities
- 2006 International Building Code
- 2006 International Fire Code
- International Energy Conservation Code 2009 (IECC)
- American Association of State Highway and Transportation Officials (AASHTO) - Standard Specifications for Highway Bridges
- AASHTO - Standard Specifications for Structural Supports for Highway Signs, Luminaries, and Traffic Signals
- American Railway Engineering and Maintenance Association (AREMA)
- American Institute of Steel Construction (AISC)
- American Welding Society (AWS)
- American Concrete Institute (ACI)
- American Society for the Testing of Materials (ASTM)
- National Bureau of Standards
- National Electric Code (NEC)
- National Electric Safety Code (NESC)
- American National Standards Institute (ANSI)
- National Fire Protection Association (NFPA) including NFPA 130 and 101
- Burlington Northern Santa Fe (BNSF) Design Standards
- Union Pacific Railroad (UPRR) Design Standards
- National Railroad Passenger Corporation (Amtrak) Design Standards
- Local jurisdictional codes, requirements and ordinances, as applicable

Individual sections of these criteria may also define additional code requirements.

## 1.5 CLIMATIC CONDITIONS FOR SYSTEMS DESIGN

The Denver metropolitan area, within which RTD operates, is situated at the foot of the eastern slope of the Rocky Mountains in central Colorado. The area has a semi-arid climate that is somewhat characteristic of the High Plains, but is modified by the Rocky Mountains to the west. Because of this, Denver lies in a belt where there is a fairly rapid change in climate from the foothills to the plains. This change is largely caused by the increase in elevation as you travel west to the foothills. Denver has an elevation of 5,280 feet.

The average annual temperature is about 50°F at this elevation, though this varies a few degrees as elevation changes. The wide average range in daily temperature of 25° to 30°F in the Denver metropolitan area and a wide average range in annual temperature are typical for the High Plains. Variations in temperature are wide from day to day; extremely hot weather in summer and extremely cold weather in the winter normally do not last long and are followed by much more moderate temperatures.

System equipment including vehicles, electrification power and distribution system, signal system and fare collection/validation equipment along with trackwork, stations and other civil features shall be capable of maintaining operation within the following conditions:

**TABLE 1A – CLIMATIC CONDITIONS**

Ambient Temperature	-30°F to +110°F
Relative Humidity	8 to 100%
Maximum Rainfall in 24 Hours	1.88 inches
Maximum Snowfall in 24 Hours	10.1 inches
Maximum Wind Speed	54 mph
Average Elevation	5,280 Feet



**TABLE 1B – TEMPERATURE AND PRECIPITATION**

MONTH	TEMPERATURE				PRECIPITATION			
	AVERAGE DAILY MAXIMUM	AVERAGE DAILY MINIMUM	2 YEARS IN 10 WILL HAVE AT LEAST 4 DAYS WITH		AVG TOTAL	2 YEARS IN 10 WILL HAVE		AVG NO. DAYS WITH SNOW COVER
			MAX TEMP EQUAL OR HIGHER THAN	MIN TEMP EQUAL OR LOWER THAN		LESS THAN	MORE THAN	
	°F	°F	°F	°F	IN	IN	IN	
<b>JAN</b>	43	14	61	-6	0.43	0.1	0.8	8
<b>FEB</b>	47	18	64	-2	0.47	0.2	0.7	9
<b>MARCH</b>	52	23	70	4	0.87	0.4	1.6	7
<b>APRIL</b>	62	33	79	19	1.86	0.7	2.8	3
<b>MAY</b>	71	42	86	32	2.54	0.9	3.7	1
<b>JUNE</b>	84	51	96	40	1.58	0.7	2.6	0
<b>JULY</b>	91	57	99	50	2.01	1.0	3.2	0
<b>AUGUST</b>	89	56	98	49	1.49	0.7	2.1	0
<b>SEPT</b>	80	47	94	35	1.14	0.2	1.7	***
<b>OCT</b>	69	36	83	25	0.72	0.1	1.5	1
<b>NOV</b>	54	23	71	7	0.54	0.2	0.9	5
<b>DEC</b>	46	18	64	2	0.40	0.1	0.6	7
<b>YEAR</b>	66	35	*101	**14	14.05	9.2	18.3	41

\* Average annual highest temperature

\*\* Average annual lowest temperature

\*\*\* Less than one-half day

Data for long periods indicate that the average annual precipitation ranges from 13.5 to 14.5 inches, with the highest precipitation occurring at the western edge of the metropolitan area. Particularly in summer and spring, precipitation may vary from year to year and in different areas in the same year. Precipitation in the winter is more in the western part of the Denver metropolitan area than it is in other parts. These differences are small but consistent from October to May. The annual snowfall is about 59 inches. The eastern part of the metropolitan area, however, usually receives more rainfall in summer than the west, but local rainfall varies widely from year to year.

The relative humidity averages 39% during the day and 62% at night, but these averages are slightly higher in winter than in summer. In an average year, the percentage of sunshine is about 69%.

Hailstorms cause some local damage almost every year. The hail usually falls in strips 1 mile wide and 6 miles long. These storms are more common in the eastern part of the Denver metropolitan area than the western part and they generally occur from about May 15 to September 1 but are most common in June and July.

Requirements for climatic conditions defined in other sections of these Design Criteria take precedence.

## **1.6 CORRIDOR CONVENTION**

Southbound (inbound) is always towards Denver Union Station (DUS) and Northbound (outbound) is always away from DUS.

Tracks are referenced by number. The track toward the bottom of the drawing is the northbound track and it is numbered track 1. The track toward the top of the drawing is the southbound track and it is numbered track 2. Numbering for additional tracks shall be submitted to RTD for approval.

## **1.7 ACRONYMS AND ABBREVIATIONS**

The following acronyms and abbreviations appear in this document. They are defined as indicated:

AAR	Association of American Railroads
AASHTO	American Association of State Highways and Transportation Officials
AC	Alternating Current
ACI	American Concrete Institute
ACOE	Army Corps of Engineers
ADA	Americans with Disabilities Act
ADAAG	Americans with Disabilities Act Accessibility Guidelines for Buildings and Facilities
AFC	Automatic Fare Collection
AFI	Air Filter Institute
AFO	Audio Frequency Overlay
AISC	American Institute of Steel Construction
AISI	American Iron and Steel Institute
AMCA	Air Moving and Conditioning Association, Inc.
ANSI	American National Standard Institute
APTA	American Public Transportation Association
AREMA	American Railway Engineering and Maintenance Association

ARI	Air Conditioning and Refrigeration Institute
ASA	Acoustical Society of America
ASCII	American Standard Code for Information Interchange
ASHRAE	American Society of Heating, Refrigeration and Air Conditioning Engineers
ASIC	Application Specific Integrated Circuit
ASME	American Society of Mechanical Engineers
ASTM	American Society for Testing and Materials
ATP	Automatic Train Protection
ATS	Automatic Train Stop
AW0	Empty vehicle operating weight
AW1	Fully seated passenger load and one operator, plus AW0
AW2	Standees at four passengers per square meter of suitable standing space plus AW1 (Structural mean fatigue load, Propulsion performance load)
AW3	Standees at six passengers per square meter of suitable standing space plus AW1 (Braking performance load)
AW4	Standees at eight passengers per square meter of suitable standing space plus AW1 (Structural design load, not contemplated for revenue operation)
AWG	American Wire Gauge
AWS	American Welding Society
BLS	Bureau of Labor Statistics
BNSF	Burlington Northern Santa Fe
CCD	City and County of Denver
CCTV	Closed Circuit Television
CDOT	Colorado Department of Transportation
CDPHE	Colorado Department of Public Health and Environment
CFR	Code of Federal Regulations
CPM	Critical Path Method
CPTED	Crime Prevention through Environmental Design
CRB	Columbia River Basalt
CR	Commuter Rail
CTS	Cable Transmission System
DB	Dry Bulb

DBE	Disadvantaged Business Enterprise
DC	Direct Current
DF	Direct Fixation
DIN	Deutsche Industry Norm (German Industrial Standard)
DOGAMI	Department of Geology and Mineral Industries
DWG	Drawing
ECS	Environmental Control System
ECU	Electronic Control Unit
EIA	Electronic Industries Association
EMC	Electromagnetic Compatibility
EMI	Electromagnetic Interference
FAA	Federal Aviation Administration
FACP	Fire Alarm Control Panel
FCC	Federal Communications Commission
FOB	Fahrenheit Dry Bulb
FHWA	Federal Highway Administration
FEA	Finite Elements Analysis
FMP	Fire Management Plan
FRA	Federal Railroad Administration
FTA	Federal Transit Administration
FWB	Fahrenheit Wet Bulb
GSA	General Services Administration
HPCU	Hydraulic Pressure Control Unit
HVAC	Heating, Ventilating and Air Conditioning
IBC	International Building Code
ICEA	Insulated Cable Engineers Association
IEC	International Electro-technical Committee
IECC	International Energy Conservation Code
IEEE	Institute of Electrical and Electronic Engineers
IES	Illuminating Engineering Society
ISO	International Organization for Standards
JIG	Joint Industrial Council
LAHT	Low Alloy High Tensile Strength (Steel)

LED	Light Emitting Diode
LOS	Level of Service
LRT	Light Rail Transit
LRV	Light Rail Vehicle
LVPS	Low Voltage Power Supply
MB	Maximum Brake
MCE	Maximum Credible Earthquake
MDBF	Mean Distance Between Failure
MIL	Military Specification
MIS	Management Information System
MOV	Metal Oxide Varistor
MOW	Maintenance-of-Way
MSB	Maximum Service Brake
MSS	Manufacturers Standardization Society of the Valve and Fitting Industry
MTTR	Mean Time to Repair
NBS	National Bureau of Standards
NEC	National Electrical Code
NEMA	National Electrical Manufacturers Association
NESC	National Electrical Safety Code
NETA	National Electrical Testing Association
NFPA	National Fire Protection Association
NIOSH	National Institute for Occupational Safety and Health
OCS	Overhead Contact System
OSI	Open System Interconnect
OSHA	Occupational Safety and Health Administration
PA	Public Announcement
PABX	Private Automatic Branch Exchange
PE	Preliminary Engineering
PHA	Preliminary Hazard Analysis
PIV	Peak Inverse Voltage
PUC	Public Utilities Commission
RMS	Root Mean Square

ROW	Right-of-Way
RTU	Remote Terminal Unit
SAE	Society of Automotive Engineers
SCADA	Supervisory Control and Data Acquisition
SES	Subway Environment Simulation
SIC	Standard Industrial Code, U.S. Department of Labor
SMAC	Sheet Metal and Air Conditioning Contractor's National Association
SSP	System Safety Program
TES	Traction Electrification System
TIG	Tungsten Inert Gas
TIR	Total Indicated Runout
TOR	Top of Rail
TPSS	Traction Power Substation
TVM	Ticket Vending Machine
TWC	Train to Wayside Communication
UBC	Uniform Building Code
UDFCD	Urban Drainage and Flood Control District
UFC	Uniform Fire Code
UL	Underwriters Laboratories, Inc
UPRR	Union Pacific Railroad
UPS	Uninterruptible Power Supply
USASI	United States of America Standards Institute
USDCM	Urban Storm Drainage Criteria Manual
USDOT	United States Department of Transportation
VPI	Vacuum Pressure Impregnation
VSWR	Voltage Standing Wave Ratio
WB	Wet Bulb

## 1.8 UNITS OF MEASURE

A	Ampere
Amp	Ampere
BTU	British Thermal Unit
CFS	Cubic feet per second
dB	Decibel
dBA	Decibel on the 'A' weighted scale
FC	Foot-candles
ft	Foot or feet
ft/min	Foot per minute
ft <sup>3</sup> /mi	Cubic feet per minute (or cfm)
ft <sup>3</sup> /sec	Cubic feet per second (or cfs)
g	Acceleration due to Gravity (32.2 ft/s <sup>2</sup> =9.81 m/s <sup>2</sup> )
gpm	Gallons per minute
H	Hour
Hz	Hertz
In	Inch
J	Joule
kg	Kilogram
kHz	Kilohertz
km	Kilometer
km/h	Kilometer per hour
kWh	Kilowatt hour
l	Liter
lb	Pound
lbf	Pound force
m	Meter
MHz	Mega Hertz
mi	Mile
mph	Miles per hour
mphps	Miles per hour per second
min	Minute
mm	Millimeter
mV	Millivolt
μV	Microvolt
N	Newton
oz	Ounce
pcf	Pound per cubic foot
plf	Pound per linear foot
psf	Pound per square foot

psi	Pound force per square inch
s	Second
sec	Second
sq ft	Square Feet (or sf)
V	Volt
V <sub>ac</sub>	Volt alternating current
V <sub>dc</sub>	Volt direct current
°C	Degree Celsius
°F	Degree Fahrenheit

**END OF SECTION**



**THIS PAGE LEFT INTENTIONALLY BLANK**

**TABLE OF CONTENTS**  
**SECTION 2 - OPERATIONS PLAN**

2.1.0	GENERAL .....	2
2.2.0	MAINLINE .....	2
2.3.0	LRT STATIONS.....	3
2.4.0	LRV FLEET .....	3
2.4.1	Operations.....	3
2.4.2	Transit Integration .....	4
2.5.0	HOURS OF SERVICE AND TRAVEL TIME.....	4
2.6.0	SERVICE AND VEHICLE LOAD STANDARDS.....	4
2.7.0	STATION DWELL TIMES.....	5
2.7.1	City and County of Denver (CCD) Traffic Signals .....	5
2.7.2	Other Jurisdiction Signals.....	5
2.8.0	FACILITIES AND EQUIPMENT .....	5
2.9.0	COMMUNICATIONS EQUIPMENT.....	5
2.9.1	SCADA .....	6

## SECTION 2 - OPERATIONS PLAN

### 2.1 GENERAL

RTD's objective is to operate all Commuter Rail (CR), Light Rail (LRT) and bus routes safely, reliably and efficiently and to integrate CR operations with LRT and bus service for the greatest convenience to the public. The CR system is a means by which the integration of transportation services will assist the region in meeting clean air standards, alleviating traffic congestion and improving the overall quality of life in the area. RTD has two major goals:

- Provide improved transportation choices and options to the citizens of the District;
- Establish a proactive plan that balances transit needs with future regional growth.

Commuter Rail forms an integral part of RTD's comprehensive transit program. Currently, no such service exists in the Denver metro area, and Commuter rail presents its own unique needs and challenges. Commuter Rail is the mode chosen for the North Metro, Northwest, East and Gold Line Corridors, all originating at Denver's Union Station. Transfers at Union Station will be made to the three Light Rail (LRT) corridors. The most recent addition to RTD's LRT system is the Southeast Corridor (T-REX), a 19 mile long extension of light rail originating at I-25/ Broadway Station and extending south along I-25 to Lincoln Avenue in northern Douglas County, with a spur on I-225 connecting from the light rail on I-25 to Parker Road. T-REX also includes highway and access improvements. This segment opened in November, 2006. The updated FasTracks plan assumes full build-out of proposed rail lines by 2017, with improved service levels by the 2025 horizon year.

### 2.2 COMMUTER RAIL LINES

Commuter Rail components of the FasTracks plan are as follows:

- The North Metro corridor is planned to be operated with EMUs, with service between SH-7/160th Avenue and DUS.
- The US 36 corridor is planned to be operated with EMUs or DMUs, with service between Longmont and DUS.
- The East Corridor will be operated with EMUs, with service between DIA and DUS.
- The Gold Line will be operated with EMUs with service from DUS to Ward Road.

Commuter Rail lines will connect to the following LRT Rail components of FasTracks:

- The West Corridor, with LRT service from Denver Union Station to the Jeffco Government Center.
- The I-225 corridor, connecting the East CR Line with the Southeast LRT line.

The development of Union Station in Lower Downtown Denver into a Multi-Modal transit hub will serve many thousands of sports and entertainment spectators attending events at Invesco Field, Pepsi Center, Coors Field, and many major hotels and businesses in between. Additional feeder and disseminator bus service in Downtown Denver will accommodate circulation between these key downtown destinations.

The Design Engineer shall coordinate with RTD specific requirements for future corridors which include pocket track, tail track, end of line geometries, maximum speed, consists, minimum headway and cross over locations. Relocation of the railroad operating facilities for each affected corridor is required prior to construction of RTD rail corridors. Right-of-Way acquisition is typically done during Final Design, but may be done earlier for specific projects.

## **2.3 COMMUTER RAIL STATIONS**

As part of the FasTracks Project, approximately 30 Commuter Rail stations are planned to serve the north, northwest and eastern portions of metro Denver, including the Downtown Union Station (DUS) and Denver International Airport (DIA). Typically, the stations will be in one of three configurations: Center platform, Side/Center platform or Side/Side platform. The configuration chosen depends on location, contextual conditions and passenger capacity. Station platform lengths shall be in accordance with the appropriate environmental decision document, e.g. ROD or FONSI.

RTD will work closely with the public, officials and staff in each corridor during subsequent planning and engineering phases to identify and analyze specific station locations, parking and other improvements that are mutually desired and technically feasible and within budget. Final station locations and configurations for each corridor are subject to the final results of the EIS (or other environmental study) for that particular corridor. This will include the option to use DMUs as rail technology in these corridors.

## **2.4 COMMUTER RAIL FLEET**

Presently, RTD is considering Electric Multiple Units (EMU) or Diesel Multiple Units (DMU) for the planned Commuter Rail lines. These vehicles operate on a standard railroad track gauge of 4 feet 8 1/2 inches. Some track will be used exclusively by RTD for passenger Commuter Rail operations, within or beyond private RR ROW, and other track may be shared jointly by Union Pacific, BNSF Railway and/or RTD. EMUs are powered from an overhead contact system (OCS) wire via 25 KvAC (nominal) alternating current. DMUs are powered by a diesel engine similar to that of a bus engine. See Section 2.6 for service and vehicle load standards. See Section 13 for vehicle speed parameters.

### **2.4.1 Capacity/Train Consist Assumptions**

Train Consists are based on rail car capacities and peak hour ridership projections. Train capacities are based on RTD's rail service standards. See Section 2.6 for service and vehicle load standards. RTD's local/express fare boundaries are used to roughly determine seated vs. standing load standards. Some excess capacity is desired to provide for needs during "peak of the peak" time periods and special events. A minimum 2-car train consist is assumed for all lines in the peak periods.

### **2.4.2 Operations and Systems**

CR Vehicles will typically be operated manually. Automatic block wayside signals, traffic signals, radio communication, operational procedures and train orders govern operators regarding all movements of the vehicles. Appropriate

street traffic signals and wayside signals assist the operator in selecting proper movement sequence and speeds. Powered switches are operated by operators via carborne equipment.

High speed crossings may include gate crossings with flashers and warning bells. Medians may be installed at crossings to prevent traffic from driving around active gates. Gated crossings shall be monitored and recorded by video equipment. Multiple crossings will be jointly used and maintained by the applicable Freight Rail owner, Amtrak and RTD.

### **2.4.3 Transit Integration**

The system is operated by RTD as part of a fully integrated mass transit system which will add Commuter Rail to the existing mix of Light Rail, local bus routes, express bus routes, regional routes, shuttle bus routes, and demand-response service for passengers with disabilities. Future streetcar lines may also be considered. RTD provides transit services to one of the largest geographical districts in the United States. RTD has a service area of approximately 2,400 square miles and serves the City and County of Denver and Broomfield, and all or portions of Adams, Arapahoe, Boulder, Douglas, Jefferson and Weld counties. RTD serves 38 municipalities within those 8 counties and operates 176 total fixed bus routes and 11 call-n-Rides. The 2009 service area population is approximately 2.5 million. The size of the service area, population density, the nature of the roadway system and the development of suburban activity centers, has led to the creation of a system with a wide range of service types intended to most effectively serve this large and diverse region.

## **2.5 HOURS OF SERVICE AND TRAVEL TIME**

This section will be developed after the proposed route, stations and environmental document(s) are finalized.

## **2.6 SERVICE AND VEHICLE LOAD STANDARDS**

Commuter rail vehicles have a heavier frame and larger body than light rail vehicles. They operate over a longer distance with fewer stops than that of Light Rail. Service standards include vehicle loading standards and service frequency, and establish criteria to determine the maximum level of crowding and service frequencies that a passenger would experience on the Commuter Rail system. The load standards established for RTD's Commuter rail service will be determined once the vehicle type and capacity is selected. For purposes of preliminary design, the following values should be used, which assume 90 passenger seats, 1 operator seat and 23 square meters of usable floor area per vehicle:

- Off-peak periods – 90 passengers per vehicle + 1 operator per train consist (seated load)
- Standing load – 90 seated passengers per vehicle + 76 standing passengers per vehicle (166 passengers per vehicle) + 1 operator per train consist
- Maximum train capacity (special events) -- 206 passengers per vehicle

These values are subject to change during final vehicle selection.

## **2.7 STATION DWELL TIMES**

Train dwell times at each passenger station will provide sufficient time for normal boarding and exiting of passengers. At Union Station, additional dwell time is required for both large passenger loading and unloading as well as the need to adhere to transfer to other modes of public transportation. Adequate layovers at terminals for operators to use the restroom and switch vehicle ends are an essential part of the operating schedules.

### **2.7.1 City and County of Denver (CCD) Traffic Signals**

CR headways will be determined as part of the required operational plan. Traffic signal timing may be adjusted to best support the automobile traffic flows that intersect with the proposed CR tracks.

### **2.7.2 Other Jurisdiction Signals**

The Design Engineer shall coordinate with RTD and other jurisdictions (Adams, Boulder, Broomfield and Jefferson Counties and the cities of Arvada, Aurora, Boulder, Broomfield, Commerce City, Longmont, Louisville Niwot, Northglenn, Superior and Westminster) as necessary.

## **2.8 FACILITIES AND EQUIPMENT**

These criteria will provide an overview of the facilities and equipment required to operate and maintain RTD's CR system.

## **2.9 COMMUNICATIONS EQUIPMENT**

The key element of the communications system is the Supervisory and Control and Data Acquisition (SCADA) system and the radio. Each CR operating cab and mobile units will have fixed mobile radios installed. In addition, all Train Operators, Commuter Rail Supervisors, Shop Supervisors and Maintenance of Way (MOW) employees working in the field will carry portable radios while on duty. Mobile and portable radios will provide two-way voice communications over channels designated for Commuter rail use. The Operations channel will provide direct two-way communications between Central Control and all train operations personnel. A separate Maintenance channel may be utilized for communications between Maintenance personnel in the course of their activities and for exclusive use by operators/supervisors/maintenance personnel in moving vehicles during abnormal operations (dead car tow, foul weather, etc.) or other situations which may present a safety hazard.

In addition to the radio channel for Commuter Rail operations, a Light Rail, Bus Operations channel, and Supervisors' channel may be utilized by Commuter Rail Operations for security or coordination with Light Rail and Bus Operations Dispatch whenever required.

Additional communication equipment includes:

- Emergency and public pay telephones are provided on some platforms for passenger use. Telephones will also be used in Central Control for emergency

contact of Fire/Police and emergency medical services. Public pay telephones shall not be included on new platforms, but may be located near them. See Section 14 for emergency telephone requirements at new stations.

- Public Address (PA) equipment will be used for announcements on the CRVs, in the yard and the Maintenance shop.
- Automatic Vehicle Locator (AVL) will be utilized on CRVs and other mobile units as required.
- Public Address (PA) systems and variable message signs (VMS) will be installed at all station platforms.

### **2.9.1 SCADA**

The SCADA system provides for overall control and monitoring of traction power facilities, signals, station platform CCTV, ticket vending machines intrusion and fault alarms, passenger information systems and security systems. Information and signals for the SCADA system are transmitted through fiber optic cables with communications houses located at various points along the ROW.

**END OF SECTION**

**TABLE OF CONTENTS**  
**SECTION 3 – CIVIL ENGINEERING**

3.1 CIVIL ENGINEERING ..... 3

3.2 CONTROL SURVEY ..... 3

3.2.1 Horizontal Control ..... 3

3.2.2 Vertical Control..... 3

3.3 CLEARANCES ..... 4

3.3.1 General ..... 4

3.4 STREET DESIGN ..... 4

3.4.1 General ..... 4

3.4.2 Clearance to CR Facilities ..... 4

3.4.3 Signs, Bollards, and Markers ..... 4

3.4.4 Paving..... 5

3.4.5 Traffic Signals..... 5

3.4.6 At Grade Crossings ..... 5

3.4.7 Signage and Striping ..... 5

3.4.8 Curb Ramps ..... 5

3.4.9 Guardrail and Roadside Barriers ..... 6

3.5 DRAINAGE ..... 6

3.5.1 General ..... 6

3.5.2 Hydrologic Criteria – Major and Minor Storms..... 7

3.5.3 Hydraulic Criteria ..... 8

3.5.4 Bridges/Structures ..... 11

3.5.5 Detention Facilities ..... 12

3.5.6 Water Quality..... 12

3.5.7 Erosion Control ..... 12

3.5.8 Easements..... 12

3.5.9 Variances to Criteria..... 13

3.6 UTILITIES ..... 13

3.6.1 Introduction..... 13

3.6.2 General Location Criteria Requirements..... 14

3.6.3 General Design Criteria Requirements ..... 16



## LIST OF FIGURES

- 3.1 Utility Detail
- 3.2 Stress Influence Diagram
- 3.3 Influence of Utility Collapse

## **SECTION 3 CIVIL ENGINEERING**

### **3.1 CIVIL ENGINEERING**

This section of the Commuter Rail (CR) design criteria establishes the minimum standards to be used in the design of the Civil Infrastructure supporting the CR system. The criteria presented herein were developed considering safety, accepted engineering practices, and operation and maintenance of the CR system.

Per RR requirements, where the CR operates on freight rail trackage or in freight owned ROW, the design requirements and concepts of the dominant railroad take precedent.

### **3.2 CONTROL SURVEY**

#### **3.2.1 Horizontal Control**

The Horizontal Control for all alignments shall be based on the RTD FasTracks project datum using the Universal Transverse Mercator (UTM) North Zone 13. Units shall be converted from meters and reported in US Survey Feet (sft).

Project Units shall be modified as follows:

UTM coordinates are converted from meters to US Survey Feet by the ratio of one meter equal to 3937 / 1200 feet multiplied by the scale factor of 1.000650402

Truncation applied to the coordinates shall be as listed below:

Northing – 14,000,000 sft

Easting – 1,000,000 sft

The minimum accuracy of survey work based on the control network shall be one part in 20,000 for linear measurements and 5 seconds per transit station for angular measurements. Legal descriptions of transit R.O.W. shall be tied into the established property lines of adjacent properties and on established section monumentation.

#### **3.2.2 Vertical Control**

The Vertical Control for all projects shall be based on the North American Vertical Datum of 1988 (NAVD 88). Where the proposed work is to be in a certain relationship to an existing structure or facility, elevations of the existing structure or facility must be established by field survey and tied to existing benchmarks. Where the proposed CR project is to be coordinated with other work, the relationship between the project datum and other working datums shall be established by field survey and tied to existing benchmarks.

The error of closure in feet for establishment of vertical elevations shall not exceed  $0.05\sqrt{M}$ , where M is the distance in miles.

### **3.3 CLEARANCES**

#### **3.3.1 General**

Assurance of adequate and appropriate clearance for the passage of commuter rail vehicles throughout the mainline trackage, switches and special trackwork, stations, storage yards, and operations facilities is one of the most fundamental concerns inherent in the design process and must be rigorously monitored during the construction phase. Design criteria for clearances are complex and are based on numerous assumptions and interfaces.

The criteria developed in this manual apply to the design of the entire system. All designs shall meet the minimum clearances as specified in Sections 4 & 9 of this Design Criteria Manual.

### **3.4 STREET DESIGN**

#### **3.4.1 General**

Necessary repair or replacement of existing roadways shall, at a minimum, provide services equivalent to the existing facilities. The costs associated with betterments to roadways shall be the responsibility of the facility owner. Unless otherwise specified, all road and street design for at-grade crossings, grade-separated crossings, and for other associated facilities should be in accordance with the current specifications and design guidelines of the local jurisdictions. Where the local jurisdictions have no design guidelines, the most current versions of the Colorado Department of Transportation (CDOT) Design Guide, and/or A Policy on Geometric Design of Highways and Streets (Green Book) by the American Association of State Highway and Transportation Officials (AASHTO) should be used.

#### **3.4.2 Clearance to CR Facilities**

Where possible, the design of public streets adjacent to CR facilities shall not preclude the construction of future CR stations.

#### **3.4.3 Signs, Bollards, and Markers**

Wherever practicable, all posts, pipes, warning signs and other small obstructions should be given a side clearance of at least 10 feet measured from track centerline and meet standards of local jurisdiction, AASHTO and MUTCD. Breakaway units shall be used where the installation is in a location exposed to traffic, except where the purpose is protection of passengers (e.g., at platform ends).

### **3.4.4 Paving**

Necessary repair or replacement of existing pavements shall, at a minimum, provide services equivalent to the existing facilities. The costs associated with betterments to roadways shall be the responsibility of the facility owner. All new pavements in public streets shall be in conformance with the current specifications and practices of the local jurisdictions. In a case where the local jurisdictions have no codes or standards, the Metropolitan Government Pavement Engineering Council (MGPEC) standards shall be followed. Pavements on RTD facilities shall conform to the standards and specifications provided in the RTD Bus Transit Facility Design Manual.

### **3.4.5 Traffic Signals**

#### **3.4.5.1 Codes and Standards**

All relocations, temporary or permanent, and restoration of traffic signal facilities shall be in accordance with the practices of the local jurisdictions. In the case where the local jurisdictions have no standards, the Manual on Uniform Traffic Control Devices (MUTCD) including the supplement by the State of Colorado, shall be followed.

#### **3.4.5.2 New and Existing Signal Installations**

New traffic signal installations shall provide for all required auto and pedestrian movements in addition to signal preemption that may be required for commuter rail vehicles. All existing signals shall be modified to accommodate any revisions to auto and pedestrian movements and signal preemption for commuter rail vehicles where required. All revisions shall be compatible with the local jurisdiction's traffic signal control program.

### **3.4.6 At Grade Crossings**

The design of at-grade crossings shall conform to the most recent edition of the MUTCD, and shall be approved by the Colorado Public Utilities Commission (PUC) and the jurisdiction with authority for the cross street.

### **3.4.7 Signage and Striping**

All signage and striping in public areas shall conform to the current specifications and practices of the local jurisdictions. Where the local jurisdictions have no standards, the MUTCD (as supplemented by the State of Colorado) shall be followed.

### **3.4.8 Curb Ramps**

The Design Engineer shall coordinate with the local jurisdiction or proper authority for the geometry and locations of curb ramps. The design of curb ramps shall be in strict accordance with the applicable provisions of the ADAAG.

### **3.4.9 Guardrail and Roadside Barriers**

Where required, guardrail, roadside barriers (e.g. type 7 concrete or other type as approved by RTD) and appropriate attenuators shall meet the requirements and details of the CDOT Standard Specifications for Road and Bridge Construction and Standard Plans, M & S Standards, current edition. Guardrail and roadside barrier placement in conjunction with clear zone provisions should follow the guidelines of the AASHTO Roadside Design Guide.

See Section 14 for additional discussion on right-of-way fencing and barriers.

## **3.5 DRAINAGE**

### **3.5.1 General**

This section provides standards for the design of drainage facilities associated with the CR infrastructure and systems impacted by development of new CR systems. Drainage features may include storm sewer, cross-culverts, and/or open channels. Such features may serve the CR, adjacent properties, and/or may be a part of a regional drainage system.

The purpose of drainage facilities associated with CR and the goal of the CR drainage designer is to protect public safety, protect the CR infrastructure, and to protect adjacent public and private property from damage caused by flooding. Such protection shall be provided in accordance with locally and regionally accepted engineering standards and practices, as modified for CR by the standards presented in this Section.

Facilities placed within RTD-owned CR right-of-way shall conform to the standards provided in the AREMA Manual of Railway Engineering (Manual). Storm sewer construction shall conform to Volume 1, Chapter 1, Parts 4 and 5 and Volume 2, Chapter 8, Parts 10, 14 and 15 of the AREMA Manual.

Facilities to be placed within right-of-way that is owned by an entity other than RTD (BNSF, UPRR, or other entity) shall be designed to the standards of that entity.

The hydrologic and hydraulic design of facilities shall be in accordance with the criteria of the agency in whose jurisdiction each project or section of project is located. For work located within or adjacent to CDOT right-of-way, CDOT standards as specified in the CDOT Drainage Design Manual shall be followed. If local jurisdictions do not have applicable criteria or standards, the designer shall use the design standards and technical criteria presented in the Urban Drainage and Flood Control District Urban Storm Drainage Criteria Manual (UDFCD USDCM) Volumes 1, 2, and 3, and the CDOT Drainage Design Manual. Facility design shall be coordinated with local jurisdictions.

### 3.5.2 Hydrologic Criteria – Major and Minor Storms

Major Storms: The major storm drainage system is designed to convey runoff from the 100-year frequency storm event to minimize health and life hazards, damage to structures, and interruption of services.

Minor Storms: The minor storm drainage system transports runoff from minor frequency storm (5-year) events with minimum disruption to the urban environment. The minor storm may be conveyed in curb and gutter, roadside ditches, storm sewer, and CR drainage systems.

CR and appurtenant facilities shall be designed for both recurrence intervals with the following criteria:

- CR drainage facilities shall be designed to protect the CR system during the major storm. Storm sewer systems shall be designed to protect all parts of CR trackway, and CR stations from flooding at all times. CR trackway and station platforms shall not be located in a 100-year floodplain, and conveyance systems adjacent to CR trackway shall be designed so that the ballast and sub-ballast be above the energy grade line (EGL) during a 100-year event. The CR trackway (including paved sections) shall not be used for conveyance of stormwater.
- For facilities appurtenant to the CR, including roadway improvements, the minor storm system shall be designed for the 5-year recurrence interval storm. The major storm system shall be designed for the 100-year recurrence interval storm. Park-n-Ride facilities are addressed in the RTD Bus Transit Facility Design Manual.

Design peak runoff rates shall be determined using methods specified by the criteria of the local jurisdiction. If a method is not specified by the local jurisdiction, the Rational Method or the Colorado Urban Hydrograph Procedure (CUHP) and Storm Water Management Model (SWMM) as presented in the UDFCD USDCM shall be used, as applicable.

Federal Emergency Management Association (FEMA) Regulatory Floodplains:

Facilities that are located within or adjacent to a FEMA-regulated flood zone (Zone A, etc.) shall use FEMA jurisdictional flows for facility design. Facilities shall be designed in accordance with the floodplain ordinance of the local drainage authority. The design shall include preparation and submittal of CLOMR and LOMR documentation, if required.

### 3.5.3 Hydraulic Criteria

All storm sewer, hydraulic structures, and appurtenances shall be designed in accordance with the design standards and technical criteria of the local jurisdiction, as modified below:

- Drainage design shall consider areas adjacent to the tracks where elements such as streets, parking facilities, roads, landscaping, walls, etc. may have an impact on the drainage of the trackway area.
- Special attention shall be directed to providing drainage in all track areas. Ditches, grated inlets, curb and gutter, storm sewers, and/or underdrains shall be provided at the edges of the track to prevent water from ponding or covering any part of the track structure, or contributing to subgrade instability. Trackside ditches shall be provided wherever possible. Minimum ditch grades shall be 0.3%.

#### 3.5.3.1 Design Storms

Facilities shall be designed to convey peak flows for the design storm frequencies discussed in Section 3.5.2.

#### 3.5.3.2 Replacement of Existing Facilities

Necessary replacement of existing storm drainage facilities shall, at a minimum, provide services equivalent to the existing facilities. The costs associated with betterments to storm drainage facilities shall be the responsibility of the facility owner. Services to adjoining properties shall be maintained during construction.

#### 3.5.3.3 CR Trackway

Standard trackway drainage is shown in Figures 4-5 through 4-7. Wherever possible, ditches shall be located parallel to the trackway to convey trackway drainage and to intercept runoff entering the right-of-way.

Trackway (open ballast or paved) shall not be used for conveyance of stormwater. Stormwater runoff shall be intercepted and conveyed out of the right-of-way in ditches and storm sewer.

The designer shall check the hydraulics of ditches adjacent to the trackway to confirm that the 100-year will not be above the top of subgrade during the peak 100-year runoff. Where the CR operates on, or shares right-of-way with freight rail trackage, the design requirements and concepts of the dominant railroad shall be used, if more conservative than the standards presented in this section.

#### 3.5.3.4 Storm Sewer

Design and construction of all storm sewer facilities constructed within the CR right-of-way shall conform to the requirements of the AREMA Manual for Railway Engineering, Volume 1, Chapter 1, Parts 4 and 5 and Volume 2, Chapter 8, Parts 10, 14 and 15. The minimum pipe diameter shall be 15 inches. All storm sewer constructed within the CR right-of-way shall be constructed with pipe materials in accordance with the AREMA Manual for Railway Engineering, Volume 1, Chapter 1, Part 5.

Storm sewer constructed outside of the CR right-of-way shall be constructed with pipe materials in accordance with the AREMA Manual for Railway Engineering Volume 1, Chapter 1, Part 5.

The minimum distance from top of rail to the top of pipe shall be 5 feet. The 100-year EGL in the storm sewer system shall be below the top of subgrade.

Cross-culverts under the CRT trackway shall have a maximum headwater to depth ratio of 1.5. The EGL in cross-culverts shall be below the top of subgrade for all areas adjacent to the trackway.

Storm sewer structures including manholes, junction boxes, inlets, vaults, or other structures shall be placed outside of the CR right-of-way if possible. If located within CRT right-of-way, such structures shall be designed in conformance with AREMA standards. Any structures that vary from agency standards shall be subject to acceptance by RTD for maintenance.

Storm drainage facilities for the CR shall be designed for an expected functional life of 50 years as a minimum.

#### 3.5.3.5 Inlets

Inlet boxes and grates shall be within the CR right-of-way designed for CR loading. Flangeway drains or trench drains shall not be used within paved trackway. Inlet grates located adjacent to the CR trackway shall be designed to prevent ballast rock from passing into the storm sewer system through the use of ballast retaining walls or ballast-proof grates. Inlet grates in pedestrian areas shall be heel-proof and non-slip. Bicycle-safe grates are required at all locations subject to bicycle traffic. Inlets shall be located in sumps rather than on grade wherever possible. Inlets shall be located at the low points of the profile.



### 3.5.3.6 Underdrains

Design and construction of underdrains shall be in accordance with AREMA Manual for Railway Engineering. Volume 1, Chapter 1 Section 1.2.4.3. Where right-of-way constraints do not allow use of the standard ditch section, underdrains may be used. The engineer shall size underdrains based on a hydrologic and hydraulic analysis of local drainage. Under drain pipes shall be a minimum of 6 inches in diameter for lengths less than 500 feet, and a minimum of 8 inches in diameter for lengths greater or equal to 500 feet. The perforated pipe shall be surrounded by a minimum 4 inches of crushed rock or gravel drainage material, and the pipe crown placed a minimum of 12 inches below subgrade. The underdrain systems shall be wrapped with a filter fabric (minimum weight 4 ounces per square yard) by placing the fabric between the gravel drain material and the subgrade. Underdrain clean outs, pipes, and culverts shall be designed and located to facilitate maintenance and to reduce the possibility of becoming clogged. See Figure 4.9 and 4.10 for placement of the subdrain.

The designer shall check the hydraulic grade line (HGL) of the system where the underdrain outfalls to confirm that the 100-year HGL of the downstream system will not allow the introduction of stormwater into the trackway subgrade through the underdrain system. Flap gates shall not be used in the CR storm sewer system where underdrains are installed for the purpose of intercepting and conveying groundwater. Such underdrains shall not discharge directly to the storm sewer system, but shall discharge to and be conveyed in a separate system to a location where treatment can take place; if required.

### 3.5.3.7 Station Platforms

Station platforms should slope away from trackway to restrict runoff from entering trackway. Inlets shall not be located on station platforms.

### 3.5.3.8 Park-n-Rides

See the RTD Bus Transit Facility Design Criteria manual for park-n-Ride drainage design standards.

### 3.5.3.9 Rail Embankment Edge Treatment

In areas where more than 50 feet of trackbed width contributes runoff to a fill slope, or where the fill slope is steeper than 4:1, an interceptor ditch or drainage barrier (Type 7 barricade) in accordance with CDOT M606-13 and M606-14 shall be used to collect flow from the top of the slope and convey it to inlets or rundowns to prevent erosion of the embankment.

### **3.5.4 Bridges/Structures**

#### **3.5.4.1 Retaining walls**

Retaining wall drainage shall be coordinated with the retaining wall structural designer. Runoff from slopes above retaining walls including concentrated flows shall not be allowed to discharge behind any retaining wall. Such flows shall instead be intercepted and conveyed by pipe down to grade before reaching the wall.

#### **3.5.4.2 Bridges**

Ballast deck bridge structures shall be designed to include a suitable means of collecting and conveying runoff from the bridge deck. Runoff shall be intercepted at floor drains or drains located at the abutments and conveyed to ground in drain pipes, or drains located at the abutments.

#### **3.5.4.3 Bridges over Drainageways**

Existing bridges that would be overtopped during a 100-year event should be replaced with facilities that will pass the 100-year peak runoff without overtopping.

The abutments and piers of existing bridges shall be evaluated for scour in accordance with the Federal Highways Administration Hydraulic Engineering Circulars HEC-18 and HEC-20. If existing bridges are determined to be scour critical, redesign or scour mitigation shall be implemented. Bridges shall be protected with countermeasures designed in accordance with the Federal Highways Administration Hydraulic Engineering Circular HEC-23, if possible. Bridges that cannot be adequately protected shall be replaced.

New bridges shall be designed to accommodate the 100-year peak runoff without overtopping. New bridges shall be designed with freeboard between the bridge low girder elevation and the design approach water surface elevation. The required freeboard shall be determined using methods described in Chapter 10 of the CDOT Drainage Design Manual, where practicable. Freeboard requirements shall be subject to approval by RTD. New bridges shall be designed so that abutments and piers are not susceptible to scour. Bridges and structures across FEMA-regulated floodplains shall be designed so that impacts to the floodplain are within allowable limits in accordance with the criteria of FEMA and the local floodplain ordinance. Bridges and structures across floodways that are not FEMA-regulated shall be designed so that the improvements shall not adversely impact upstream or downstream properties.

### **3.5.5 Detention Facilities**

If required by the local jurisdiction, detention facilities shall be provided in accordance with local criteria. Underground detention shall not be used unless approved by RTD.

### **3.5.6 Water Quality**

Structural water quality facilities shall be provided for park-n-ride and station facilities if required by the local jurisdiction. Water quality facilities shall be designed with consideration for ease of long-term maintenance. Underground facilities (such as water quality vaults and inlets) shall not be used unless approved by RTD. Water quality facilities shall be designed to comply with RTD's Light Rail Corridor Storm Water Management Program and be in compliance with RTD's Municipal Stormwater Permit (MS4).

### **3.5.7 Erosion Control**

The designer shall prepare plans for erosion control Best Management Practices during construction in accordance with the standards and specifications of the local jurisdiction. If the local jurisdiction has no design standards, plans shall be prepared in accordance with UDFCD UDCM Volume 3.

Erosion control plans and Storm Water Management Plans (SWMPs) will be required of the construction contractor in accordance with the standards and criteria of the local jurisdiction and with the State of Colorado Department of Public Health and Environment (CDPHE) requirements. The CR construction contractor shall be responsible for obtaining local permits and coverage under the CDPHE Stormwater General Permit for Construction Activities.

All erosion control shall comply with the conditions of RTD's Light Rail Corridor Stormwater Management Program, most current version.

### **3.5.8 Easements**

All storm sewers crossing the CR right-of-way that serve upstream properties shall become the ownership of the local jurisdiction. Where such storm sewer facilities are located outside of public right-of-way, license agreements shall be prepared for the conduit crossing.

The designer shall identify any temporary or permanent easements required to construct and maintain storm water drainage facilities, and shall coordinate with RTD's Property Management Division to prepare any required agreements.

### **3.5.9 Variances to Criteria**

The design of drainage systems using the criteria contained herein is to protect the CR system and facilities from storm-runoff damage and to protect RTD from liability for damage to property from storm runoff either passing through or caused by CR construction. It is RTD's goal to design all drainage facilities in accordance with the Drainage Criteria. Deviations from the Drainage Criteria shall be evaluated only if meeting the requirements of the drainage criteria is determined by RTD to be impractical - not capable of being done within natural, social or economic constraints.

At the direction of RTD, the Design Engineer shall prepare an alternatives analysis that analyzes the cost associated with protecting the CR trackway and facilities from storm events ranging from a do nothing alternative to providing the drainage facilities in accordance with RTD Drainage Criteria (i.e. providing full protection of CR facilities from the 100 year storm event). An integral part of this analysis shall be identifying the mitigation measures required to protect the CR trackway and facilities from storm runoff damage for storm events up to the 100 year storm. For example, if the storm event that is being analyzed is less than the 100 year event, the design engineer shall analyze the effects to CR trackway and facilities from the 100 year storm including locations, flow depths, and velocities of storm water overtopping the rail. The design engineer shall evaluate impacts from storm runoff to assure that there is no adverse impact to either upstream or downstream properties from storm runoff either passing through or caused by CR construction.

Any deviation, discrepancy, or unusual solution must be approved by RTD before it can be included in the design. It is the responsibility of the Design Engineer to identify, explain and justify any deviation from the established criteria and to secure the necessary approvals from RTD. All variance to the Drainage Criteria shall be approved by RTD's Senior Manager of Engineering.

## **3.6 UTILITIES**

### **3.6.1 Introduction**

This section establishes design criteria for both existing and proposed Utilities within the RTD ROW. Utility Facilities designed to be installed within RTD's ROW, are to be in accord with the provisions of this Design Criteria.

All utilities specifically designed for RTD projects should meet the criteria, codes and requirements of the local jurisdiction where the project is located. Where Utility company criteria, public laws, or other standards applicable to the specific Utility require a higher degree of protection, those laws and standards will take precedence over these Design Criteria. RTD has the right to amend or waive these Design Criteria requirements.

All variances to RTD Design Criteria need to be documented and approved prior to being incorporated into the design.

In determining whether to grant a variance to these Design Criteria, RTD will consider all relevant factors, including whether:

- (1) A variance is reasonably necessary for the convenience, safety and welfare of the public.
- (2) There is exceptional or undue hardship on the applicant, or a physical impracticality.
- (3) A variance will not impair the railway operations, maintenance, or safety, nor otherwise conflict with the purposes of this Design Criteria.
- (4) A variance would not be detrimental to the public health, welfare, or safety.

### **3.6.2 General Location Criteria Requirements**

#### **3.6.2.1 Horizontal Placement:**

- (a) Existing and proposed Utilities shall be located outside the Trackway and the limits of the Track ROW, except for the purpose of crossing the tracks or servicing a RTD facility. Longitudinal utilities should not be located within the RTD ROW.
- (b) Utility Facilities should be located to avoid future conflict with planned or programmed changes within RTD's ROW. Known future conflicts will be identified by RTD.
- (c) Utilities should be designed to avoid placing facilities at the outside of track curves or the ends of bridges or other structures.
- (d) Horizontal clearances of Utilities shall be designed to conform to specific Utility company requirements and shall be sufficient so that any work on a Utility does not compromise any RTD facilities or other Utilities.
- (e) Utilities crossing the Track ROW should be designed, where practicable, to cross at a right angle to the track centerline.

#### **3.6.2.2 Vertical Placement:**

- (a) Vertical clearance (depth of cover) for buried Utilities crossing under the tracks shall be a minimum of 60" from the TOR to the top of a Utility or encasement (if encased), (Fig. 3.1).
- (b) Overhead Utility crossings shall not be allowed within the RTD ROW. Exceptions shall be made for electric transmission lines and where utilities are attached to a bridge structure.
- (c) Vertical clearances shall conform to specific Utility company requirements, applicable codes and shall be sufficient so that any work on a Utility does not compromise the RTD facilities or other Utilities.

### 3.6.2.3 Utility Appurtenances:

(a) Utility Appurtenances shall be located outside the RTD ROW and outside the track clearance envelope when serving RTD facilities.

(b) Surface Utility Appurtenances shall be designed in such a manner to allow automobile and pedestrian traffic safe sight lines to see approaching trains and shall be placed outside public pathways where they do not block pedestrian movements or create safety hazards.

(c) Utility poles should be located a minimum distance equal to the height of the pole above the ground line plus 10' from the RTD track centerline or from the RTD catenary wires (when catenary wires are located on the outside of the RTD track).

(d) The design of Utility pole supports shall prevent the pole from leaning/falling in the direction of the tracks.

(e) Accessible emergency shutoff valves, where warranted by local jurisdictions or utility owners, shall be located on each side of the crossing, outside of the Track ROW.

### 3.6.2.4 RTD Owned Structures and Facilities:

(a) Overhead and underground Utilities and appurtenances shall be located at a sufficient distance from RTD owned bridge, culvert, switch area, track clearance envelope and other structures or facilities to allow future maintenance to be performed by Utility companies without disruption to the operation or maintenance of the RTD structures or facilities.

(b) RTD has existing and will have proposed Utilities within the RTD ROW. The location of all existing and proposed RTD Utilities within the RTD ROW shall be identified prior to starting any utility design. RTD utilities shall be located before any construction begins. Utility designs shall accommodate RTD owned Utility Facilities.

### 3.6.2.5 Drainage:

Pipelines should, where practicable, be located where the ground surface slopes downward away from RTD tracks.

### 3.6.2.6 Markers, Location Aids, Location Assistance:

Utility locations shall be marked in accord with the project specifications.

### 3.6.2.7 As-Built Plans:

As-built plans of abandoned, retired, relocated, protect-in-place, adjusted, and modified Utilities shall show the final location of each Utility and shall be submitted to RTD in accord with the project specifications.

### 3.6.3 General Design Criteria Requirements

#### 3.6.3.1 Design Loads:

The material, class, thickness, and depth of all buried Utility Facilities, including carrier pipes, conduits and casings shall be designed to withstand the full range of expected internal and external pressures and loads, including internal pressures ranging from zero to maximum expected pressure, and external loads from the Trackway, vehicle loads, retaining walls, and all other structural loads. Designs shall be appropriate to support existing and future load conditions.

For guidance on depth design see Figure 3.2 'Stress Influence Diagram' to determine increased stress of the Tracks on the Utility at different depth zones, and Figure 3.3 'Influence of Utility Collapse' to determine appropriate depth in relation to the Utility diameter for non pressurized Utilities (including abandoned, retired, decommissioned, and active lines). Design depths shall be appropriate to protect both the Tracks and the Utility.

Design load calculations will be subject to review by RTD.

#### 3.6.3.2 Specifications:

Design of Utility installations shall conform to the current published issues, governing their specific type of Utility, as applicable:

(1) The design of electric power or communication facilities shall conform to the National Electric Safety Code and with the National Electric Code.

(2) The design of pipelines shall conform to the applicable provisions of industry codes and standards.

(3) The design of liquid petroleum pipelines shall conform to the recommended practice of the American Petroleum Institute for pipelines crossing under railroads and highways.

(4) The design of any pipeline carrying natural and other gas shall conform to the rules and regulations of the U.S. Department of Transportation, Title 49, CFR, Part 192.

(5) The design of any pipeline carrying hazardous liquids shall conform to the rules and regulations of the U.S. Department of Transportation governing the transportation of such materials, Title 49, CFR, Part 195.

(6) If Utilities are located within Railroad ROW, designs shall conform to both RTD and the governing Railroad design requirements. In the event of differing or conflicting design criteria, designs shall be submitted to RTD for final design criteria selection.

#### 3.6.3.3 Material:

The materials designed for Utility Facilities shall conform to accepted practices and industry standards and shall be designed for long service life and shall be relatively free from routine servicing and maintenance.

All new Utility Facilities shall be free of asbestos and asbestos containing materials.

#### 3.6.3.4 Service Interruptions:

Utility designs shall identify planned service interruptions as coordinated with utility owners and service interruption restrictions as directed by utility owners. The number and length of service interruption should be limited to only what is critically necessary for the design.

#### 3.6.3.5 Betterment:

Utility relocation designs shall provide service equal to that offered by the existing Utility. Betterments shall not be included in the design, unless approved by RTD and paid for by the party requesting the betterment.

#### 3.6.3.6 Abandoned, Retired, and Decommissioned Utilities:

(a) Existing Abandoned and existing Retired Utilities shall be capped, plugged, filled, removed, or otherwise addressed in a manner deemed necessary and as directed by RTD to protect the transportation facility and/or traveling public.

(b) Proposed Abandoned and proposed Retired Utilities shall be taken out of service using proper utility owner and/or industry standard procedures as directed and approved by RTD. In determining whether to allow proposed Abandoned or Retired facilities to remain in place rather than require the Utility Owner to remove the facility, RTD will consider such factors as: present or potential congestion of Utility installations; railway construction or maintenance requirements; cost and difficulty of removal; whether or not the facilities contain any hazardous materials, such as asbestos; the potential for the facilities to have to be removed by RTD itself at some future date; and traffic and safety requirements.

(c) Utility Facilities containing asbestos may not be Abandoned in-place. The design of Utility Facilities containing asbestos shall include taking the Utility out of service and removing it from RTD ROW. On a case-by-case basis, RTD may allow such Utility Facilities to be Retired in-place, with the owner retaining full legal ownership and responsibility for the Utility Facility.



(d) Decommissioned Utilities shall be designed to conform to the same criteria as active facilities. If a Decommissioned Utility conflicts with an RTD structure or facility, the Utility shall be relocated, modified, or protected in place as design requires.

#### 3.6.3.7 Trenched & Trenchless Construction Including Jacking Pits:

Excavation, digging, and soil disturbance activities shall be limited to outside the Zone of Influence. The Zone of Influence is defined as an area extending 10' either side of the edge of the track tie. Excavation, digging, and soil disturbance activities adjacent to the Zone of Influence (see Fig. 3.1) shall require shoring to protect the RTD sub-grade, tracks, facilities or structures from any possible damage.

#### 3.6.3.8 Encasement and Related Protection of Utility Facilities:

(a) Pressurized pipelines under the RTD Trackway shall be encased unless otherwise directed and approved by RTD and shall be insulated from underground conduits carrying electric wires.

(b) Casings may be omitted for gaseous products only under the following circumstances: (1) the carrier pipe wall thickness must be designed to support Commuter Rail loading requirements as described in section 6 of this manual; (2) the length of the thicker-walled pipe shall extend the full width of the RTD ROW; (3) all steel pipe shall be coated and cathodically protected.

(c) Buried Utility Facilities and Utilities attached to structures shall be protected as follows:

(1) Where buried facilities could be potentially subjected to damage from construction, operations, or maintenance, additional protective measures should be required, such as a concrete cap, concrete encasements, steel conduits, tunnel or gallery, or other appropriate protective measures.

(2) Where suspended from or in a structure, water, high-pressure gas, or hazardous material pipelines shall be in a casing pipe.

(3) Where buried Utilities are located outside the Zone of Influence additional protective measures may be required.

(d) Casing pipe shall be utilized in the design when: (1) it is necessary to facilitate bored or jacked installations and/or to protect coated carrier pipes from damage during installation; (2) as a means of conveying leaking fluids or gases to points safely throughout its length under track and the RTD ROW; or (3) it is necessary to provide for the future adjustment, removal or replacement of the carrier line without disturbing RTD facilities or operations.

(e) Tunnels or galleries shall be incorporated in the design in specific circumstances, including: (1) where several Utility Facilities must share a crossing location; (2) as a provision for future increase

in line size or additional lines; or (3) as a means of inspecting carrier lines in the crossing (4) or as determined by RTD to be appropriate.

(f) Utility crossing installations shall be designed to provide required protection, at a minimum, across the RTD Track ROW or further as required to allow access to the Utility and to prevent disturbing the structural integrity of the trackbed or other RTD facilities during future maintenance of the Utility.

(g) Casings shall be designed and installed with even bearing throughout its length and the casing shall be designed to slope to one end.

(h) The inside diameter of Casings shall be designed at least 10% larger than the outside diameter of the carrier pipe or to the utility owner specifications but no less than 2 inches greater than largest outside diameter of carrier pipe, joints or couplings.

(i) Where the ends of a casing are below ground, the casing shall be sealed to the outside of the carrier pipe to prevent the intrusion of foreign material which might prevent removal of the carrier pipe.

(j) Casing vent pipes shall be designed as follows:

(1) Casings must be properly vented above ground with vent pipes having inside diameter equal to 10% of nominal size of the carrier pipe but no less than 2 inches and extending not less than 4 feet above ground surface.

(2) The low end of casings shall be connected with the bottom of the casing and vent pipes at the high end of casings shall be connected with the top of the casing.

(3) The top of vent pipes shall be fitted with a down-turned elbow that is screened.

(k) Drainage for casings, tunnels, or galleries, which enclose carriers of liquid, liquefied gas, or heavy gas should be provided when practicable. Drainage for non-hazardous liquids may outfall outside the RTD ROW into ditches or natural watercourses. The design of drainage outfalls that have the potential to contain hazardous liquids shall incorporate additional measures that are determined to be suitable to protect against possible soil or water contamination. Additional protection measures may include construction of dikes or installation of liners. Proposed drainage outfalls shall not be used as a wasteway for purging the carrier pipe.

#### 3.6.3.9 Cathodic Protection:

All metallic Utility carrier pipes shall be designed with appropriate cathodic protection measures for internal and external corrosion in accord with Section 10 – Corrosion Control of this Commuter Rail Design Criteria manual.

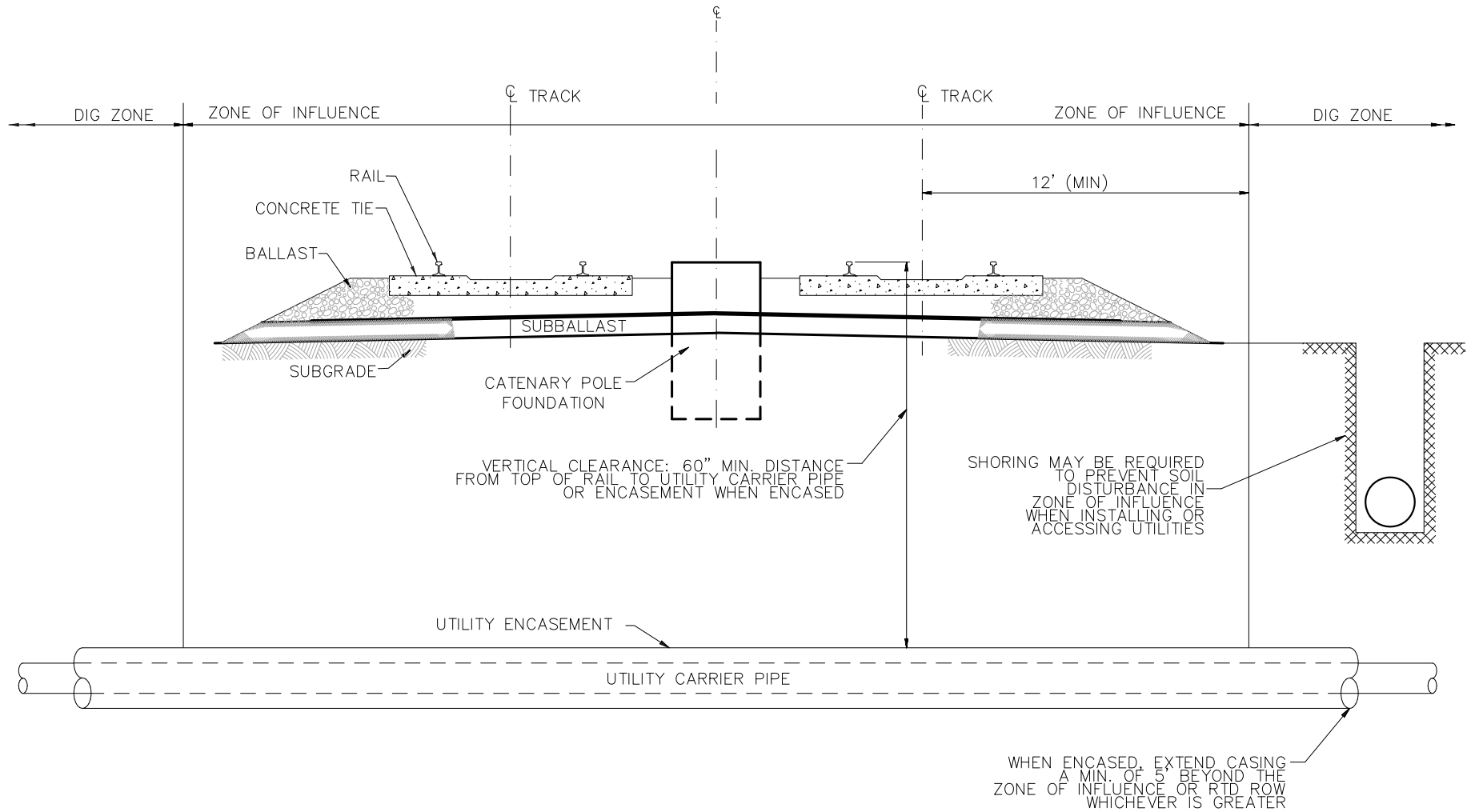
#### 3.6.3.10 Restoration of ROW:

Designs of Utility work in earthen areas within the RTD ROW that will disturb existing ground conditions shall include seeding or other protection methods as specified by RTD to control erosion.

**END OF SECTION**

**THIS PAGE LEFT INTENTIONALLY BLANK**

RTD TRACK SECTION

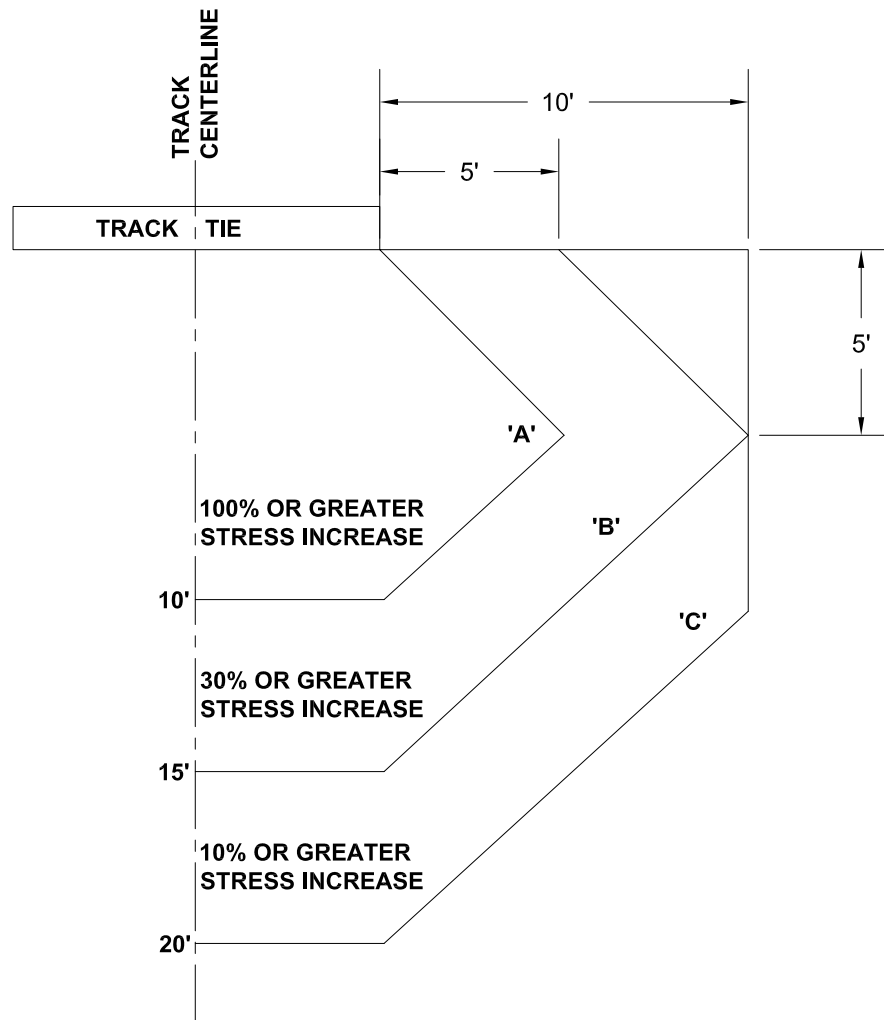


REGIONAL TRANSPORTATION DISTRICT  
1600 BLAKE STREET  
DENVER, COLORADO 80202  
(303) 628-9000

COMMUTER RAIL  
DESIGN CRITERIA

TITLE: UTILITY DETAIL

FIGURE: 3.1



### Stress Influence Diagram

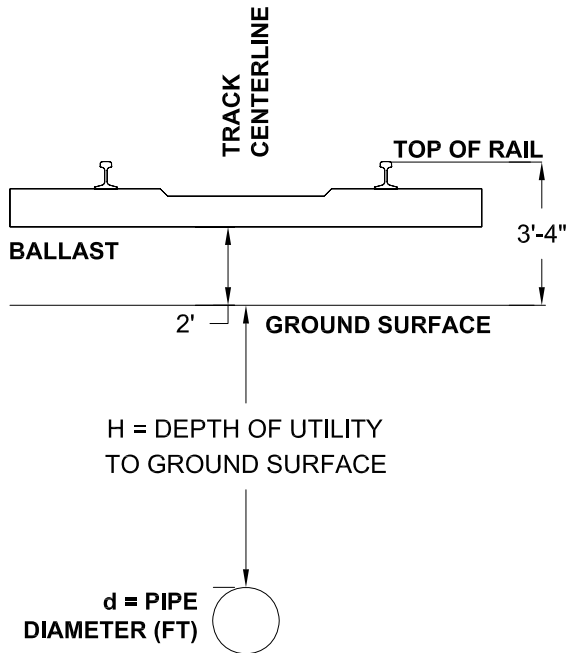
The 'Stress Influence' diagram is to be used to calculate the increase in stress on a pipe or utility facility installed in the ground under a trackway. The diagram shows three areas and the corresponding stress increase for each area. The percent of stress increase is to be added to the normal stress loads on the same pipe within the same depth without the track above it. Existing pipes that will fall under new track shall be analyzed using this diagram and calculations shall be provided to assure they will meet the added stress influence of the track.

- A pipe located 10' or less below the track tie and within area 'A' shall be designed for 100% or greater increase in stress.
- A pipe located 10' to 15' below the track tie and within area 'B' shall be designed for a 30% increase in stress.
- A pipe located 15' to 20' below the track tie and within area 'C' shall be designed from a 10% increase in stress.



**COMMUTER RAIL  
DESIGN CRITERIA**

**TITLE:** STRESS INFLUENCE DIAGRAM  
**FIGURE:** 3.2



Surface influence potential for clay soil ( $\phi = 20$  degrees)

For an overall 5% decrease in soil density due to collapse use:

$$H = (5 \cdot d) - 1$$

The depth to the pipe (h) is below the track ballast assumed to be 2 feet.

### Influence of Utility Collapse Diagram and Formula

The 'Influence of Utility Collapse' diagram and formula shall be used to calculate the minimum depth H (ft) a pipe of a diameter d (ft) must be located below the finished ground surface to avoid potential collapse due to loads. This formula applies to non-pressurized and/or empty pipes including abandoned, retired, decommissioned, and active lines that are not at full-flow (ie. communication ducts). This diagram and formula should be used for the following two purposes.

- Abandoned and Retired lines: Influence of Utility Collapse calculations will indicate the need to flow fill or remove the pipe. Any abandoned or retired pipe that does not meet the minimum depth H shall be removed or flow filled per RTD specifications.
- Active (new and existing) and Decommissioned lines: Influence of Utility Collapse calculations will indicate if the pipe installation meets the minimum depth H. Any active or decommissioned pipe that does not meet the minimum depth H shall be relocated to or below the minimum depth H or shall be replaced with a new pipe of an appropriate diameter d to prevent future collapse from causing damage to the rail line.

When a duct bank of pipes, conduits or ducts are buried beneath the tracks the equivalent diameter of all the pipes, conduits or ducts shall be used as the diameter d.

Example:

A 12" diameter pipe shall be buried at least H (ft) where:

$$H = [(5 \cdot d) - 1'] = 4' \text{ below finished ground surface}$$

Or buried to a depth of  $4' + 3'4" = 7'4"$  below top of rail

RTD

COMMUTER RAIL  
DESIGN CRITERIA

TITLE: INFLUENCE OF  
UTILITY COLLAPSE

FIGURE: 3.3

**TABLE OF CONTENTS**  
**SECTION 4 - TRACK GEOMETRY AND TRACKWORK**

4.1	GENERAL .....	3
4.1.1	Introduction .....	3
4.1.2	Track Gauge .....	4
4.2	GENERAL TRACK ALIGNMENT .....	4
4.2.1	Horizontal Track Alignment.....	4
4.2.2	Tangent Sections .....	4
4.2.3	Horizontal Curves .....	5
4.2.4	Track Centers .....	9
4.2.5	Clearances.....	10
4.3	VERTICAL TRACK ALIGNMENT .....	13
4.3.1	General .....	13
4.3.2	Grades .....	13
4.3.3	Vertical Curves.....	14
4.4	MAINLINE TRACK .....	15
4.4.1	Subgrade .....	15
4.4.2	Sub-ballast.....	15
4.4.3	Geotextile Fabrics .....	16
4.4.4	Ballast .....	16
4.4.5	Cross Ties.....	16
4.4.6	Switch Ties.....	16
4.4.7	Rail.....	16
4.4.8	Emergency Guard Rail .....	17
4.4.9	Rail Seats and Fastenings.....	17
4.4.10	Rail Welds.....	18
4.4.11	Rail Joints .....	18
4.4.12	Rail/Switch Heaters .....	18
4.4.13	Special Trackwork .....	18
4.4.14	Paved Track.....	20
4.4.15	Ballastless Track.....	20
4.4.16	Grade Crossings.....	21
4.4.17	Maintenance Access Point .....	21
4.4.18	Track Bumping Posts.....	22
4.4.19	Rail Expansion Joints .....	22
4.5	YARD TRACK .....	22
4.5.1	Sub-Ballast.....	22
4.5.2	Ballast .....	22
4.5.3	Cross Ties.....	22
4.5.4	Rail.....	22
4.5.5	Guard Rail.....	23
4.5.6	Rail Joints .....	23
4.5.7	Special Trackwork .....	23



4.5.8	Grade Crossings.....	23
4.5.9	Crosswalks.....	23
4.5.10	Yard Lighting.....	23
4.5.11	Service Roads.....	23

### LIST OF FIGURES

FIGURE 4.1	TRACK CONSTRUCTION TOLERANCES
FIGURE 4.2	CURVE & SPIRAL NOMENCLATURE
FIGURE 4.3	STANDARD VERTICAL CURVES
FIGURE 4.4	MINIMUM TRACKWAY CLEARANCES
FIGURE 4.5	BALLASTED DOUBLE TRACK SECTION AT 15 FT TRACK CENTERS
FIGURE 4.6	BALLASTED DOUBLE TRACK SECTION AT 25 FT TRACK CENTERS
FIGURE 4.7	BALLASTED SINGLE TRACK SECTION
FIGURE 4.8	EMERGENCY WALKWAY PLACEMENT FOR CONSTRAINED SECTIONS
FIGURE 4.9	RETAINED SECTION AT 15 FT TRACK CENTERS
FIGURE 4.10	RETAINED SECTION AT 25 FT TRACK CENTERS
FIGURE 4.11	REQUIRED TURNOUT SEPARATIONS
FIGURE 4.12	TYPICAL GRADE CROSSING DETAIL

## SECTION 4 - TRACK GEOMETRY AND TRACKWORK

### 4.1 GENERAL

#### 4.1.1 Introduction

This section of the Design Criteria Manual details minimum standards and design policies to govern the engineering, materials, and construction standards for trackwork and its interfaces with other elements of RTD's Commuter Rail (CR) system. The interfacing elements of the system include but are not limited to trackway, stations, structures, communications, signal systems, and drainage. Except for the requirements established in these criteria and RTD CADD Standards Manual, construction plans and specifications shall generally follow the AREMA Manual for Railway Engineering and Portfolio of Trackwork Plans. CR Track construction and maintenance standards shall meet or exceed the current track safety standards of the Federal Railroad Administration (FRA) for Class 4 Track.

In addition, where the CR operates on freight rail trackage or in freight owned ROW, the design requirements and concepts of the dominant railroad take precedent.

When to use the RTD CR Design Criteria

RTD owns the ROW and operates exclusively on its own tracks.

RTD owns the ROW directly adjacent and parallel to an existing freight corridor, but operates exclusively on its own tracks.

When RTD operates on Class 1 Track or operates on its own track but in the Class 1 Railroad ROW the Design Criteria of the Class 1 railroad must be used.

When operating adjacent to but not in freight ROW, extensive coordination is required between RTD and the Class 1 railroad to insure that the adherence to proper clearances, drainage and utility standards are achieved by both railroads.

Also, when designing crossings the design requirements and concepts of AASHTO, CDOT, Colorado State's Public Utility Commission, MUTCD and the local municipality shall also be utilized.

These Design Criteria take into consideration many factors including passenger safety, passenger comfort, vehicle-operating envelope, and track safety requirements. Passenger comfort requirements normally will drive the final track geometry design. For this reason there are desired RTD maximum and minimum values and absolute maximum and minimum. The desired values are based on passenger comfort, initial construction cost and maintenance considerations. Absolute values are determined primarily by the vehicle design, with passenger comfort a secondary consideration.

The track designer shall make every attempt not to exceed the desired values outlined in this design criteria manual. Where desired values cannot be met, absolute values may be used only with prior written variance. RTD staff will reject any proposed design that includes absolute maximum and minimum values that does not have this approval.

#### **4.1.2 Track Gauge**

Track gauge shall be a standard gauge of 4 feet 8-1/2 inches. The gauge is the distance between the inner sides of the head of rails measured 5/8 inches below the top of rails. CR track construction tolerances shall comply with Figure 4.1.

### **4.2 GENERAL TRACK ALIGNMENT**

The track alignment shall be designed to maximize passenger ride quality at the highest permissible operating speeds. Where cost, geometric or other physical constraints permit, the Design Engineer shall establish alignment, superelevation, and track clearance conditions, which will permit 79 mph (FRA class 4) operation.

The CR track alignment for each line section shall be stationed along the centerline of track "NB". Stationing along track "NB" shall be the basic control for locating all other system facilities along the route. Separate stationing shall be used for track "SB" where tracks are neither parallel nor concentric, where widened track centers are required around curves, or where tracks are in separate structures. Track alignments that are oriented east west shall use the east bound "EB" as the basic control. Track stationing shall generally start at the core or "hub" and increase toward the remote terminus.

#### **4.2.1 Horizontal Track Alignment**

In general the horizontal alignment shall consist of tangent sections connected by circular curves with spiral transition curves unless otherwise approved by RTD.

#### **4.2.2 Tangent Sections**

The minimum length of tangent track between curved sections is based on passenger comfort and vehicle truck/wheel forces. Based on the AREMA Manual, Chapter 5, the minimum length is equal to the longest car that will traverse the system. Due to the forces between the trucks/wheels on the CR vehicle it is recommended that all trucks be on tangent track before negotiating a curve, at a minimum two sets of trucks are on tangent track.

The minimum length of tangent between curved sections (except those with compound curves) shall be as follows:

<u>Condition</u>	<u>Tangent Length (greater than or equal to)</u>
*Desirable Minimum	200 feet
Minimum	100 feet or 3 times the design speed (in mph), whichever is larger
Absolute Minimum	68 feet

(\*Not to be exceeded without prior RTD approval)

The minimum length of tangent track preceding a point of switch shall be as follows:

<u>Condition</u>	<u>Tangent Length (greater than or equal to)</u>
*Desirable Minimum	100 feet
Minimum	85 feet
Absolute Minimum	65 feet

(\*Not to be exceeded without prior RTD approval)

The horizontal and vertical alignment shall be tangent along all station platforms and continue a minimum of 85 feet beyond each end of the platform.

All special trackwork shall be located on horizontal and vertical tangent track.

#### 4.2.3 Horizontal Curves

Horizontal curvature shall be designed for FRA Class 4 Track. Curves and spirals shall be selected based on the desired design speed of the line.

##### a) Circular Curves

Circular curves for CR designs shall be defined by the cord definition of curvature, and specified by their degree of curvature. If a comparison between curve radius and degree of curvature is required the following conversion can be made:

$$R = \frac{50}{\text{SIN}(Dc / 2)}$$

Where:

R= Radius

Dc= Degree of Curvature (Decimal Degree)

Radius (R) can be approximated by the formula  $R = \frac{5729.58}{Dc}$

The maximum degree of curvature for a given curve is based on design speed, length of spiral, and superelevation through the curve.

The maximum degree of curvature is determined by the characteristics of the CR vehicle. The distance between the truck centers on the CR vehicle play the critical role in determining minimum radius. For RTD the absolute minimum degree of horizontal curvature is 12° 30' (R=459.28 feet)

On existing corridors, no curves shall be constructed or realigned resulting in smaller than existing radii. Every opportunity should be taken to relax curvature.

Curves in or through At Grade Crossings are substandard and are not permitted without prior RTD approval.

The desirable minimum length in feet of each curve element (spiral, simple curve, spiral) is 3 times the maximum speed in MPH, or 100 ft whichever is longer.

<u>Condition</u>	<u>Curve Length (greater than or equal to)</u>
*Desirable Minimum	3X Max Speed
Absolute Minimum	100 feet

<u>Condition</u>	<u>Degree of Curve (less than or equal to)</u>
*Desirable Minimum	Based on Speed
Absolute Minimum	12° 30'
(*Not to be exceeded without prior RTD approval)	

b) Spiral Curves

Spiral curves shall be provided between circular curves and horizontal tangents. Spirals shall be Barnett or Talbot as defined by the AREMA Manual for Railway Engineering. See Figure 4.2 for spiral nomenclature.

Spirals are not allowed in or though At Grade Crossings.

The minimum length of spiral shall be the greatest length determined from the following formulas:

1.  $L_s = 1.63 E_u V$
2.  $L_s = 62 E_a$
3.  $L_s = 100 \text{ Feet}$

Where

$L_s$  = Length of spiral curve (in feet)

- $E_a$  = Track superelevation for the circular curve (in inches)
- $E_u$  = Unbalanced superelevation for the circular curve (in inches)
- $V$  = Design speed (in miles per hour)

c) Superelevation

Mainline tracks are designed with superelevations that permit desired design speeds to be achieved without resorting to excessively large curve radii. The design speed criteria stated below are based on a maximum lateral passenger acceleration of 0.1 g.

$$E_t = E_a + E_u = 0.0007 V^2 D_c \frac{4V^2}{R}$$

Where:

- $E_t$  = Total superelevation required to balance the centrifugal force at a given speed (in inches)
- $E_a$  = Actual track superelevation to be constructed (in inches)
- $E_u$  = Unbalanced superelevation the difference between  $E_t$  and  $E_a$  (in inches).
- $V$  = Design Speed (in miles per hour)
- $R$  = Radius of Curve (in feet)
- $D_c$  = Degree of Curve

The amount of  $E_u$  shall vary gradually as follows:

$$E_u = 1.33 \frac{V^2}{R} + 0.67$$

$$E_a = 2E_u - 2$$

Actual track superelevation ( $E_a$ ) shall not exceed 6 inches (5 inches on tracks shared with freight) with a desired 4 inch maximum.

A minimum of 1/2 inch of superelevation should be used on all mainline curves.

Unbalanced superelevation ( $E_u$ ) shall not exceed 4 inches [FRA Mandated] (1.5 inches on tracks shared with freight) with a desired 1.5 inch maximum. Actual superelevation should be attained and removed linearly throughout the full length of the spiral transition curve by raising the outside rail while maintaining the inside rail at the rail profile grade. Superelevation will not extend in tangent track without RTD approval.

## Superelevation Runoff

The change in superelevation should be in uniform increments and the rate of change per 31 ft of track should not be more than 3/8 inch. (FRA Class 4 track)

Yard tracks shall not be superelevated.

### Commuter Rail Only

<u>Condition</u>	<u>Ea</u>	<u>Eu</u>
*Desirable Maximum	4 inches	1.5 inches
Absolute Maximum	6 inches	4 inches

### Shared Freight and Commuter

<u>Condition</u>	<u>Ea</u>	<u>Eu</u>
*Desirable Maximum	3 inches	1.5 inches
Absolute Maximum	5 inches	1.5 inches

(\* Not to be exceeded without prior RTD approval)

#### d) Reverse Curves

Every attempt shall be made to use standard circular curves and spirals with tangent sections as described in Section 4.2.2, 4.2.3.a, and 4.2.3.b .

Tangent distance between reverse curves on main line track shall be no less than 100 ft.

#### e) Compound Circular Curves

Compound circular curves should be avoided; however they may be used provided that they are connected by an adequate spiral transition curve. Compound circular curves shall not be used without prior RTD approval. In order to provide a comfortable ride at lower speeds, the superelevation of the circular curve should be maintained through the spiral transition curve. The length of the spiral curve shall be determined by the criteria in Section 4.2.3.b.

For high-speed conditions where the spiral transition curves are longer, a differential in the superelevation of the two circular curves may be allowed, provided the design does not compromise safety or riding comfort and has prior approval from RTD. For this condition, the minimum length of spiral shall be the greatest length of spiral determined from the criteria in Section 4.2.3.

The minimum length of spiral between compound circular curves shall be 65 feet. Spiral transition curves need not be used between compound circular curves when:

$$R_L - R_S \text{ less than or equal to } 0.34 (R_S/V)^2$$

Where:

- $R_L$  = radius of the larger curve (in feet)
- $R_S$  = radius of the smaller curve (in feet)
- $V$  = design speed (in miles per hour)

#### 4.2.4 Track Centers

Track centers, including equivalent centers on curves, must NOT be reduced below the minimum established for the territory.

<b>Between:</b>	<b>Track Centers on Tangent</b>
Adjacent Class 1 Freight Mainline	25 feet
Adjacent Main, where third Main proposed in future	30 feet
Adjacent Main, in non constrained areas	25 feet
Adjacent Main, Yard and other Side Tracks (ABS Min)	15 feet
Adjacent Main, in Center Pole Electrified Territory	16 feet
Main Track and any adjacent track, other than another main track, other than a yard or ladder track	17 feet
Secondary Running, Industrial or Passing Track and any adjacent track	17 feet
Yard Ladder Track and adjacent track except other yard ladder	18 feet
Adjacent Yard Ladder Tracks	19 feet

Equivalent Track Centers: On curves, to provide clearance between cars and locomotives equivalent to that obtained on adjacent tangent track centers should be increased as follows:



Superelevation of Adjacent Tracks	Increase of Tangent Track Center Distance
Inner Track ≥ Outer Track	1" for each 0°-30'
Inner Track < Outer Track	1" for each 0°-30' plus 3½" for each 1" difference in elevation.

For Example: Double main tracks at 15 ft centers on a 5° Curve would need to have track centers through the curve of 15 ft 10 inches.

Superelevation of Tracks adjacent to center poles	Increase of Tangent Track Center Distance from Pole Face to Track Centerline
Center Pole	5.1" for each 1" of Actual Superelevation

#### 4.2.5 Clearances

Clearances shall conform to the AREMA Chapter 28: Clearances and "BNSF/UPRR Guidelines for Railroad Grade Separation Projects."

The criteria developed in this section apply to the design of the entire system. All designs shall provide not less than the minimum clearances as specified in this section.

Assurance of adequate and appropriate clearance for the passage of Commuter rail vehicles throughout the mainline trackage, switches and special trackwork, stations, storage yards and operations facilities is one of the most fundamental concerns inherent in the design process and must be rigorously monitored during the design and construction phase.

When the CR shares trackage in an existing freight corridor all clearances will conform to the guidelines of the controlling railroad's standard. In most cases this will be the class 1 freight railroad and follow "BNSF/UPRR Guidelines for Railroad Grade Separation Projects"

On dedicated ROW for RTD commuter rail trains only, RTD requires a vertical clearance of **23 foot 6 inches** from top of rail to any object and a Horizontal Clearance of **8 foot-6 inches** from centerline of track to non structural objects . This does not include electrical clearances. The minimum horizontal clearance to structural objects shall be 12 feet 6 inches.

Bridge piers or other structural elements within 25 ft of centerline of track shall require pier protection/crash projection in accordance with Section 6 of this manual. Whenever practicable, all posts, pipes, warning signs, and other small obstructions should be given a side clearance of at least 10 feet.

In electrified territories, OCS clearance requirements shall conform to Section 9 –Traction Electrification System and AREMA Chapter 33.2.2 Recommended Clearance Specification to Provide for Overhead Electrification. This may require vertical clearances higher than stated above.

When building new RTD Commuter Rail Tracks under existing structures on existing freight corridors, special consideration is given for existing substandard vertical clearances. Variances will be required.

### Clearance Envelope

The Clearance Envelope is defined as the space occupied by the Vehicle.

The clearance envelope represents the space in or into which no physical part of the system may be placed or constructed or may protrude (with the exception of Commuter rail vehicle). The clearance envelope is normally referenced from, or represented by its relationship to, the theoretical centerline of track at Top of Rail (TOR).

All commuter rail vehicles shall comply with the Section 13.. (Amtrak 1355 Revision E, Vehicle Static and Dynamic Clearance limits.)

See Figure 4.4 Minimum Trackway Clearances.

#### **4.2.6 Special Clearance Situations**

In addition to the more routine clearance envelope determinations above, there are several special clearance situations warranting further attention and definition. These special situations include undercar clearances, vehicle interface at station platforms, and general walkway areas along the ROW where applicable.

##### **a) Undercar Clearances**

Vertical undercar clearance is defined from TOR with the maximum suspension deflection and car body roll, minimum vertical curve radius, and fully worn wheels. The minimum vertical clearance envelope shall be 3 inches above TOR.

##### **b) Station Platform Interface**

The relationship of the vehicle at rest and the station platform is one of the most fundamental interfaces in any rail transit system. Horizontal and vertical static clearances or gaps (between platform edge and vehicle step) determine the ease of boarding/deboarding for passengers, and platform edges often must be placed within the strict confines of clearance envelopes so as to permit safe and practical passenger movement and meet or exceed all applicable ADA rules and regulations

Platform height shall be 48" from top of rail for RTD only track, and 8" above top of rail for shared mainline freight track. The maximum horizontal gap shall be three inches.

If the station platform is adjacent to a shared freight/commuter rail track, then, special provisions must be made at commuter rail stations to insure the safe clearance of wide freight loads.

See Figure 4.4 Minimum Trackway Clearances.

**c) Emergency Walkways along Structures, Retained and Constrained sections.**

An emergency/maintenance walkway shall be provided along structures retained and constrained sections and whenever the trackway has physical barriers adjacent. This walkway shall be above TOR at the track edge and shall be located at a absolute minimum horizontal distance from track centerline of 6 foot 6 inches. The walkway shall have a minimum width of 30 inches and shall extend to 6 feet-6 inches above the walkway. Walkways shall be provided on both sides of the right-of-way and shall provide unobstructed passage. See figure 4.8 for Emergency Walkway placement.

**(d) Maintenance Walkway Area along Trackway**

In addition to the envelope requirements per Figure 4.4, it is desirable that space be provided if possible for maintenance walkways adjacent to the trackway in typical Open Ballasted Track areas.

## 4.3 VERTICAL TRACK ALIGNMENT

### 4.3.1 General

Vertical alignment shall be defined by the "top-of-rail profile" along tangent sections and the low rail in superelevated sections. Parabolic vertical curves having a constant rate of change in grade shall be employed for changes in gradient.

### 4.3.2 Grades

Grades shall not exceed the maximums specified in the following table:

<b>Condition</b>	<b>Desirable</b>	<b>Absolute</b>
	<b>Maximum*</b>	<b>Maximum</b>
Mainline Track (shared)	1.5%	2.5%
Stations	0.5%	1.0%
Yard	0.0%	0.5%
Storage Track	0.0%	0.25%
Special Track	0.0%	2.0%
CR Only Track**	3.0%	4.0% (no more than 2500ft)

\* If the Desirable Maximum cannot be met, prior RTD approval will be needed in order to raise grades beyond Desirable Maximums, Absolute Maximum grades shall never be exceeded.

\*\* CR Only Track: mainline tracks in which "Electric Multiple Unit" and or "Diesel Multiple Units" vehicles that are specifically designed for higher grades are the only vehicles that operate on the alignment.

All tracks entering the yard shall be pitched downward away from the main line, or dished to prevent any vehicles from rolling onto the mainline tracks. The minimum length of constant profile grade between vertical curves shall be determined as follows:

$$L_g = 3V$$

where:

$L_g$  = Minimum length of constant profile grade (feet)

$V$  = Design velocity through tangent (miles per hour)

Absolute minimum  $L_g$  shall be 90 feet, unless otherwise approved by RTD.

### 4.3.3 Vertical Curves

#### a) Length of Vertical Curves

From AREMA:

The minimum length of vertical curve shall be determined as follows:

$$L = \frac{2.15 * D * V^2}{A}$$

Where:

$L$  = Length of vertical curve (in feet)

$D$  = Algebraic difference in grades (expressed as a decimal)

$V$  = Design velocity (in miles per hour)

$A$  = Vertical acceleration (0.6 for passenger rail)

Standard Vertical Curves are shown in Figure 4.3.

The minimum length of any vertical curve shall be as follows:

Condition	Length of Vertical Curve
*Desirable Minimum	200 feet
Absolute Minimum	150 feet

(\*If the Desirable Minimum cannot be met, prior RTD approval will be needed in order to lower curve length to any value smaller than the Desirable Minimum down to and including the Absolute Minimum length.)

#### b) Reverse Vertical Curves

Reverse vertical curves should be avoided, but may be used provided the minimum length of each curve is not less than that defined by Section 4.3.3.a, and prior RTD approval has been obtained.

#### c) Compound Vertical Curves

Compound or unsymmetrical vertical curves may be used provided the requirements of Section 4.3.3.a are met, and prior RTD approval has been obtained.

#### d) Vertical Curves in Special Trackwork

Turnouts should not be located on vertical curves.

In locations where a vertical curve is adjacent to a turnout, the vertical curve should end no closer than 25 ft from the point of switch and no closer than 10 ft from the heel of frog.

Vertical curves are not allowed in At Grade Crossings and for 70 ft either side of the last panel edge.

### 4.4 MAINLINE TRACK

For typical track sections, refer to Figures 4.5 thru 4.12.

#### 4.4.1 Subgrade

The subgrade 14 feet both sides of track centerline shall be compacted to at least 95% of maximum dry density as determined by the current revision of ASTM Specification, Designation D 698T (Procter Test). If laboratory results indicate that existing material is unsuitable (insufficient bearing capacity, poor drainage characteristics, etc.) the material must be removed and replaced with clean, sound and properly compacted material, per ASTM standards.

The compacted subgrade shall be sloped at 40:1 downward and away from the center point located midway between the two tracks in double track territory. In single track areas, the compacted subgrade shall slope toward the underdrain at 40:1. Refer to Figures 4.5-7 and 4.11-12 for typical subgrade configurations.

Configurations other than those mentioned above may be adopted if drainage requirements or specific locations dictate a special treatment with prior RTD approval.

#### 4.4.2 Sub-ballast

Subballast is the transition zone between the subgrade and the ballast. The subballast acts as a barrier filter separating the ballast section from the subgrade material. This material plays an integral role in the track structure. The quality of the subballast has a direct relationship to the overall performance of the track structure. This layer acts as a drainage medium for the track bed.

Prolonged water exposure can be harmful to the subgrade. Once the subgrade begins to break down the track geometry cannot be maintained.

A 12 inch layer of sub-ballast shall be installed on top of the subgrade. The sub-ballast shall conform to AREMA specifications. Subballast should extend the full width of the subgrade plus a minimum 18 inches past the toe of the ballast.

#### **4.4.3 Geotextile Fabrics**

Geotextile fabrics shall be evaluated for use in all main line track. Geotextile fabrics shall be placed under all special trackwork (on the mainline and in the yard) and tracks with potential subgrade stability issues. Fabric will extend the entire interface zone between the ballast and subballast. Fabric will extend 20 feet before point of switch and 10 feet after the last long tie.

#### **4.4.4 Ballast**

No. 4 (1-1/2 inches to 3/4 inches) ballast conforming to AREMA specifications shall be used on all main tracks except for those in streets and yards, where No. 5 (1 inch to 3/8 inch) ballast shall be used. All ballast is to be thoroughly washed prior to placement.

A minimum depth of 12 inches of ballast shall be used between the bottom of ties and top of the subballast. The ballast shoulder shall extend 16 inches beyond the ends of the ties parallel to the plane formed by the top of the rails. Ballast shoulder shall then slope downward to the subgrade at a 2:1 slope. The final top of ballast elevation shall be at the top of tie, when compacted. Refer to Figures 4.5-7 and 4.11-12.

#### **4.4.5 Cross Ties**

New mainline tracks shall use concrete cross ties, approximately 8 feet 6 inches in length and 8 3/4 inches by 11 inches in cross section spaced 24 inches, center to center. Tie spacing through curves with  $D_c=5^\circ30'$  or greater shall be 20 inches. All concrete cross ties shall conform to AREMA specifications.

Timber ties that meet the freight railroad standards may be used or retained in existing freight corridors that will be shared with commuter traffic.

#### **4.4.6 Switch Ties**

Timber or concrete switch ties shall be of various lengths conforming to the specific requirements of the turnouts used. Anti-splitting devices shall be used on all wood ties.

#### **4.4.7 Rail**

Rail for all mainline track shall have a base dimension of 6 inches. All rail shall be a 136 RE section, control-cooled carbon steel rail manufactured in accordance with current AREMA specifications. Only New No. 1 rails shall be used in main tracks, yard and other non-main tracks.

Heat-treated or alloy rails shall be used in all special trackwork and on all curves with  $D_c=5^\circ 30'$  or greater and extending into the spiral till the point of degree of curve on spiral exceeds  $D_c=5^\circ 30'$ . Heat-treated or alloy rails are not required to be installed on seldom used emergency or storage tracks, even though they may satisfy the above criteria. Heat-treated or alloy rails may be used, with RTD's approval, in other locations where excessive rail wear is anticipated.

#### **4.4.8 Emergency Guard Rail**

Emergency Guard Rail is used as a safety device. In the event of a derailment the guard rail is designed to catch the inside of the wheel and guide the CR along the track until it stops. Emergency guard rails shall be installed adjacent to the inside running rail of all tracks on bridges and fills with a vertical drop of more than 3 feet. Guard rail will extend over the length of the structure plus 50 feet in the inbound direction and 10 feet in the departing direction. Emergency guard rails shall not be installed within the limits of special trackwork.

Emergency guardrail shall be designed so as to retain the wheels of a derailed vehicle moving at maximum speed. The striking face of the emergency rail shall be uniformly located approximately 1 foot from the gauge line of the running rail. Guardrail shall be fastened to every second tie in ballasted track.

#### **4.4.9 Rail Seats and Fastenings**

Concrete and wooden cross ties will use spring clips isolated from the tie using plastic insulators and placed on an insulating pad.

Rail anchors may be required or retained on existing timber tie freight alignments near tight curves and or at grade road crossings. Rail anchors placement shall follow the design criteria of the dominant freight railroad.

Other rail fastening methods shall be evaluated for ballasted track.

Ballastless track (including direct fixation) rail fasteners shall provide the required lateral and longitudinal restraint for continuous welded rail and the electrical insulation required for the negative return current and the proper operation of 60 Hz track signal circuits. Ballastless track fasteners or concrete ties shall provide a 40:1 cant of the rail.

Ballastless track fasteners shall incorporate, or be placed on, a suitable elastomeric pad for reducing transmission of high frequency (i.e., greater than 30 Hz) loads to the support structure.

Rail fasteners for use in direct fixation special trackwork shall be of a design compatible with the standard fastener used in conventional direct fixation track.

Rail clips or other devices used in direct fixation fasteners shall produce the required longitudinal rail restraint after repeated load testing in accordance with AREMA Chapter 10, except load application angle in that test shall be 27 degrees.



#### **4.4.10 Rail Welds**

Rail shall be welded into Continuous Welded Rail (CWR) strings of site-specific length by the electric flash-butt or aluminothermic weld processes in accordance with AREMA specifications. The ends of the welded rail strings will then be field-welded together by the thermite welding or flash-butt process according to AREMA specifications.

#### **4.4.11 Rail Joints**

Insulated and standard rail joints shall be placed only at locations where required to accommodate signal track circuits and connections to special trackwork. The insulated rail joints for signal operations shall be prefabricated plugs, welded into the CWR rail. Insulated plugs should be trimmed down to 14 feet. If insulated kits are to be used RTD prior approval is required.

#### **4.4.12 Rail/Switch Heaters**

Electric switch heaters shall be installed on all power and spring operated turnouts in both mainline and yard tracks. Gas heaters may be used with prior RTD approval.

#### **4.4.13 Special Trackwork**

Special trackwork shall be manufactured and installed in accordance with RTD's specifications generally following AREMA plans and specifications. All frogs and flangeways shall be designed to accommodate the CR wheel profile.

The preferred location of special trackwork is in ballasted at-grade areas. Single crossovers shall be used in lieu of double crossovers unless space restrictions dictate their use, and then only with prior approval by RTD. Special trackwork in paved track shall be kept to an absolute minimum; however, when it must be so located, it shall be designed to reduce the exposure of pedestrians to the operating mechanisms. Switch points shall not be located in areas designated as pedestrian crossings.

All special trackwork shall be located on vertical and horizontal tangents. The desirable minimum horizontal and vertical tangent distance preceding a point of switch shall be 50 feet. Distances shorter than the desired minimum require prior RTD approval. Absolute minimum distances are shown for different turnout placements in Figure 4.13. In certain circumstances, special trackwork may be used on curves, but only with approval by RTD. Special trackwork shall not be superelevated.

As special trackwork is a source of noise and vibration, its location shall be selected to minimize their effect.

#### **Crossing Diamonds**

Rail crossings should be avoided if possible. If space is available double crossovers should be replaced with separate right and left hand crossovers. All crossings designs shall adhere to the AREMA Manual.

## Turnouts

Conventional Turnouts (For Class 4 and less) shall generally conform to the “BNSF/UPRR Combined Standard.” Operating speed through turnouts shall be as indicated. Turnouts and crossovers for various applications shall be selected in accordance with the following criteria:

Turnout	Switch Point Length/Type	Usage	Max Speed Thru Diverging Side
NO. 9	16' – 6" Straight	Yards, Terminals and where space limitations do not allow for No. 11.	15 MPH
No. 11	19' – 6" Curved	Yards, Terminals and on Main lines where space limitations do not allow for No. 15.	20 MPH
No.15	26' – 0" Curved	Main lines where space limitations do not allow for No. 20.	30 MPH
No. 20	39' – 0" Curved	Main lines	40 MPH

Advanced Technology Turnouts shall be considered for high speed movements (Class 4 and higher) as they provide superior ride quality through straight and diverging moves. All AT turnouts shall be constructed on concrete ties and generally conform to the Amtrak Standard Track Plan.

Turnout #	Switch Point Length/Type	Usage	Max Speed Thru Diverging side
No. 20MPF	55' – 4 ½"	Mainline track and interlocking plants	45 MPH
NO. 32.75MPF	85' – 4 ½"	Mainline track and interlocking plants above 45 mph.	80 MPH

MPF=Movable point frog.

Minimum required distances between turnouts are shown on Figure 4.11.

Where possible, turnouts should be oriented as “trailing point” so that trains moving in the predominant direction will move over the frog before moving over the point of switch.

All conventional turnouts shall use AREMA Point Detail 5100 with graduated risers. All mainline track frogs shall be of the rail-bound manganese type with heat-treated or alloy steel guard rails. Self guarded frogs are to be used in yard tracks. Special drainage provisions shall be made in track turnouts to preclude standing water in flangeways, switch points, and in switch-throwing mechanisms.

#### **4.4.14 Paved Track**

Paved track shall not be used in Commuter Rail design or construction.

#### **4.4.15 Ballastless Track**

Ballastless track designs may be required in some bridge and tunnel areas depending on the situation. Designs shall be reviewed by RTD staff prior to acceptance in overall design.

Direct Fixation (DF) track is a ballastless track structure in which the rail is mounted on direct fixation fasteners that are attached to a concrete deck or slab. Trackwork

located on DF shall use 136RE rail attached to the direct fixation fasteners using spring clips and isolated from the structure using elastomeric pad and plastic insulators. DF shall consist of a second pour concrete plinth block and a fastening system to hold the running rails onto the concrete surface canted 1:40 toward the track centerline.

Engineered transition zones shall be required between ballastless and ballasted track sections to reduce the impacts related to the different track modulus. An approach slab shall be provided at each transition between DF and ballasted track.

#### **4.4.16 Grade Crossings**

Mainline grade crossings shall be prefabricated and made of durable, long-lasting materials. Grade crossing panels shall be constructed with due regard to removability for track maintenance, electrical isolation, to non-interference with electrical track circuits or rail fastenings, tire adhesion, and slip resistance for vehicles and pedestrians.

Grade crossings should be on tangent level track wherever possible. Horizontal curves in Grade crossings are permitted only with prior RTD approval. Superelevation shall be minimized in Grade Crossings. Spiral curves are not allowed. Vertical curves are not allowed within 70ft of the edge of the last panel on either side.

Parallel adjacent CR tracks shall be coplanar through the Grade Crossing.

Grade crossings shall be located on tangent track and away from special trackwork areas unless otherwise approved by RTD. Rail joints and thermite welds shall not be located in grade crossings.

Cross tie type, size and spacing at grade crossings shall be in accordance with the grade crossing manufacturer's recommendations. If the grade crossing requires cross ties that differ in type from the mainline track, then transition zones shall be designed to accommodate for the change in track modulus.

Crosswalks shall be provided at areas where pedestrians will be crossing mainline tracks. They shall be located on tangent track, if possible, and away from special trackwork areas.

#### **4.4.17 Maintenance Access Point**

Access points for maintenance personnel and equipment shall be provided everywhere possible. Areas shall be provided at or near wayside equipment for the parking of maintenance vehicles to prevent infringing on roadway travel lanes or pedestrian areas.

High-rail access points shall be provided at least every 2 miles when possible and if deemed necessary. They shall be located on tangent track and be constructed of grade crossing materials durable enough to withstand maintenance vehicles. High-rail access points shall be adequately secured to prevent unauthorized entry.

#### **4.4.18 Track Bumping Posts**

Track bumping posts shall be designed to clear the coupler and engage the cars' anti-climber. They shall be installed at the ends of all stub-end yard and mainline tracks.

Design of bumping post at terminal passenger stations shall include train operations, platform designers, system safety and risk analysis.

#### **4.4.19 Rail Expansion Joints**

During final design, locations where rail expansion/contraction is anticipated to present a problem (on bridges and certain sharp curves on ballasted track), shall be analyzed for methods of control. If mechanical rail expansion joints are used, the expansion capacity of the joints shall be greater than the anticipated rail movement within the full range of rail temperatures.

### **4.5 YARD TRACK**

Yard tracks shall be constructed to the same standards as mainline track, with the following exceptions:

#### **4.5.1 Sub-Ballast**

Sub-ballast will not be required unless it is needed for subgrade stabilization.

#### **4.5.2 Ballast**

No. 5 ballast conforming to AREMA specifications shall be used on all yard tracks.

A minimum depth of 12 inches of ballast shall be used between the bottom of tie and top of subgrade. The top of ballast elevation shall be at least 1 inch below the base of rail and the ballast shoulder shall extend level 1 foot 6 inches to the field side, beyond the ends of the ties to form a suitable walking surface. Crushed slag ballast will not be permitted.

#### **4.5.3 Cross Ties**

Yard tracks shall use timber cross ties 9 feet in length spaced 24 inches center to center, except at braced and guarded track, where spacing shall be 22 inches. All cross ties shall be size 7 inches by 9 inches and conform to AREMA specifications. Switch ties shall be of various lengths as required for a No. 9 AREMA turnout with 16 feet-6 inch switch points.

#### **4.5.4 Rail**

Yard tracks shall be constructed with 136 pound new rail and shall be installed, continuous welded rail (CWR) shall be used.

#### **4.5.5 Guard Rail**

Emergency guardrail shall be installed on tracks adjacent to all major structures that may cause extensive damage to a car in the event of a derailment.

#### **4.5.6 Rail Joints**

Rail joints shall conform to the requirements of Section 4.4.11. 36 inch 6-hole bars may be used in the yard where required.

#### **4.5.7 Special Trackwork**

Special trackwork shall conform to the requirements of Section 4.4.13.

All yard turnouts shall be AREMA No. 9's with 16 feet-6 inch curved switch points conforming to AREMA Point detail 5100 with graduated risers. Self guarded frogs shall be used.

The operating speed through the turnouts shall be as indicated in Section 4.4.13.

#### **4.5.8 Grade Crossings**

Grade crossings shall conform to the requirements of Section 4.4.16, except yard grade crossings may consist of asphalt with flangeway liners.

#### **4.5.9 Crosswalks**

Crosswalks shall conform to the requirements of Section 3.4.7. In the yard, they may be located on curves and may consist of asphalt.

#### **4.5.10 Yard Lighting**

The yard is to be illuminated to provide a safe working environment for ultimate 24-hour operation of the facility. Yard lighting will also provide an element of security.

#### **4.5.11 Service Roads**

Service roads shall be provided around the operations facility and between alternate pairs of tracks in the CR storage areas. Service roads will also be provided to access switches within the yard.

**END OF SECTION**

THIS PAGE LEFT INTENTIONALLY BLANK

TYPE OF TRACK	GAUGE VARIATION <small>(NOTE 1)</small>	CROSS LEVEL AND SUPERELEVATION VARIATION <small>(NOTE 1)</small>	VERTICAL TRACK ALIGNMENT		HORIZONTAL TRACK ALIGNMENT	
			TOTAL DEVIATION <small>(NOTE 2)</small>	MIDDLE ORDINATE IN 62' CORD	TOTAL DEVIATION <small>(NOTE 2)</small>	MIDDLE ORDINATE IN 62' CORD
MAIN LINE	±1/8"	±1/8"	±1/2"	±1/8"	±1/2"	±1/8"
YARD	+1/4" - 1/8"	±1/4"	±1"	±1/4"	±1/2"	±1/8"

**NOTES:**

1. VARIATIONS OF GAUGE, CROSS LEVEL AND SUPERELEVATION SHALL NOT EXCEED 1/8" PER 31' OF TRACK.

2. TOTAL DEVIATION IS MEASURED BETWEEN THE THEORETICAL AND ACTUAL ALIGNMENTS AT ANY POINT ON THE TRACK. TOTAL DEVIATION IN STATION AREAS = 1/4"



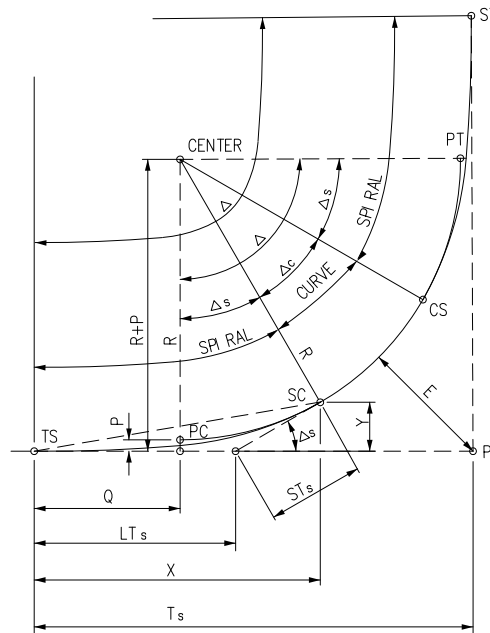
1560 BROADWAY, SUITE 700  
DENVER, COLORADO 80202  
(303) 299-6990

**DESIGN CRITERIA**

**TITLE: TRACK  
CONSTRUCTION TOLERANCES**

**FIGURE: 4.1**





SPIRAL TRANSITION CURVE

- R = RADIUS
- D = DEGREE OF CURVATURE
- P = OFFSET OF THE PC/PT OF SIMPLE CURVE, MEASURED FROM MAIN TANGENT OF SPIRAL
- Q = DISTANCE FROM TS/ST TO THE PC/PT OF SIMPLE CURVE, MEASURED ALONG MAIN TANGENT OF SPIRAL
- X = DISTANCE FROM TS/ST TO THE SC/CS MEASURED ALONG MAIN TANGENT OF SPIRAL
- Y = OFFSET OF SC/CS MEASURED PERPENDICULAR TO MAIN TANGENT OF SPIRAL
- E = EXTERNAL DISTANCE
- $L_s$  = LENGTH OF SPIRAL ARC (LIMITING VALUE OF  $L$ )
- $L_c$  = LENGTH OF CURVE
- L = LENGTH OF SPIRAL ARC FROM  $\Delta/30$  ANY POINT ON SPIRAL
- $LT_s$  = LONG TANGENT OF SPIRAL
- $ST_s$  = SHORT TANGENT OF SPIRAL
- $T_s$  = TOTAL TANGENT DISTANCE TS/ST TO PI
- $\Delta$  = TOTAL CENTRAL ANGLE
- $\Delta_s$  = TOTAL SPIRAL CENTRAL ANGLE
- $\Delta_c$  = SIMPLE CURVE CENTRAL ANGLE
- $I$  = DEFLECTION AT  $\Delta/30$  FROM TANGENT TO ANY SPIRAL POINT
- PI = POINT OF INTERSECTION OF MAIN TANGENTS

$$\Delta = \frac{DL_s}{200}$$

$$I = \frac{\Delta_s}{3}$$

$$S = \frac{DL^2}{200L_s}$$

$$X = L \cos I$$

$$Y = \frac{D(\text{RAD}) L_s^2}{600}$$

$$Q = X - R \sin \Delta_s$$

$$P = Y - R \text{ VERS } \Delta_s$$

(VERS)  $\Delta_s = 1 - \cos s \Delta$

$$T_s = (R+P) \tan \frac{\Delta}{2} + Q$$

$$E = (R+P) \text{ EX SEC } \frac{\Delta}{2} + P$$

$$LT_s = X - (Y/\tan \Delta_s)$$

$$ST_s = Y / \sin \Delta_s$$

$$T_c = R \tan \frac{\Delta_c}{2}$$

$$D = \frac{5730}{R}$$

$$L_c = \frac{100 \Delta_c}{D}$$



1560 BROADWAY, SUITE 700  
DENVER, COLORADO 80202  
(303) 299-6990

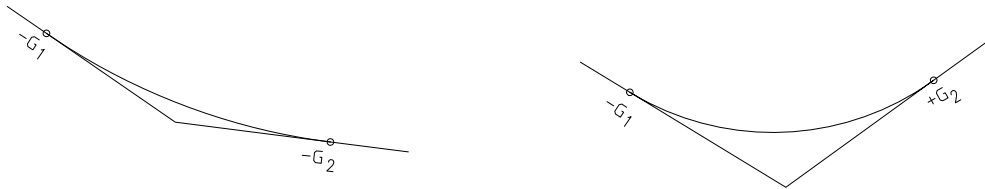
## DESIGN CRITERIA

TITLE: TRACK  
CURVE & SPIRAL NOMENCLATURE

FIGURE: 4.2



CREST TYPE VERTICAL CURVES

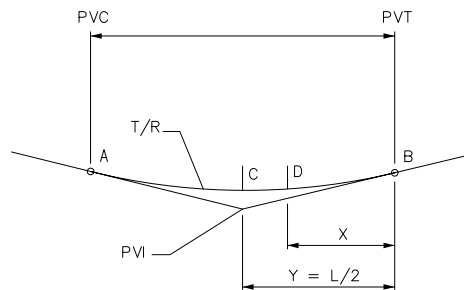


SAG TYPE VERTICAL CURVES

$$L = 70 (G_1 - G_2) \text{ FOR } V > 35$$

$$L = 40 (G_1 - G_2) \text{ FOR } 15 < V < 35$$

$$L = 20 (G_1 - G_2) \text{ FOR } V < 15$$



$$\text{ELEV C} = \frac{2 \text{ ELEV PVI} + \text{ELEV A} + \text{ELEV B}}{4}$$

OFFSET AT C = DIFFERENCE BETWEEN ELEV C & ELEV PVI

$$\text{OFFSET AT D} = \text{OFFSET AT C} \left(\frac{X}{Y}\right)^2$$

$$\text{T/R AT D} = \text{OFFSET AT D} * \text{GRADIENT ELEV AT D}$$

STANDARD VERTICAL CURVE



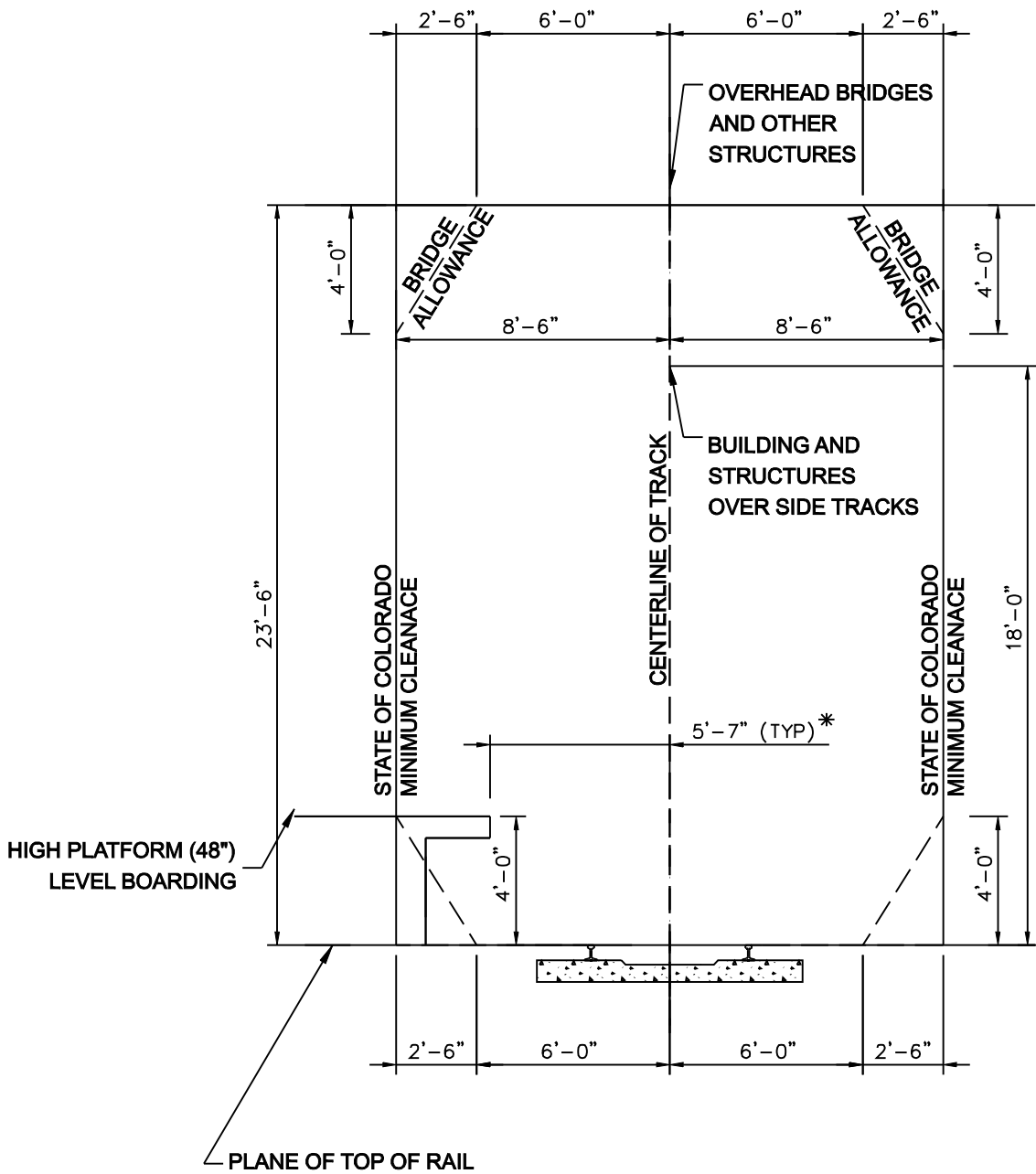
1560 BROADWAY, SUITE 700  
DENVER, COLORADO 80202  
(303) 299-6990

**DESIGN CRITERIA**

**TITLE: TRACK  
STANDARD VERTICAL CURVES**

**FIGURE: 4.3**

SEE SECTION 9 TRACTION ELECTRIFICATION FOR OCS AND WIRE CLEARANCES  
 THIS DIAGRAM IS NOT TO BE USED TO DETERMINE OVERHEAD ELECTRIFICATION CLEARANCES



\* MUST MEET ADA STANDARDS



1580 BROADWAY, SUITE 700  
 DENVER, COLORADO 80202  
 (303) 299-6990

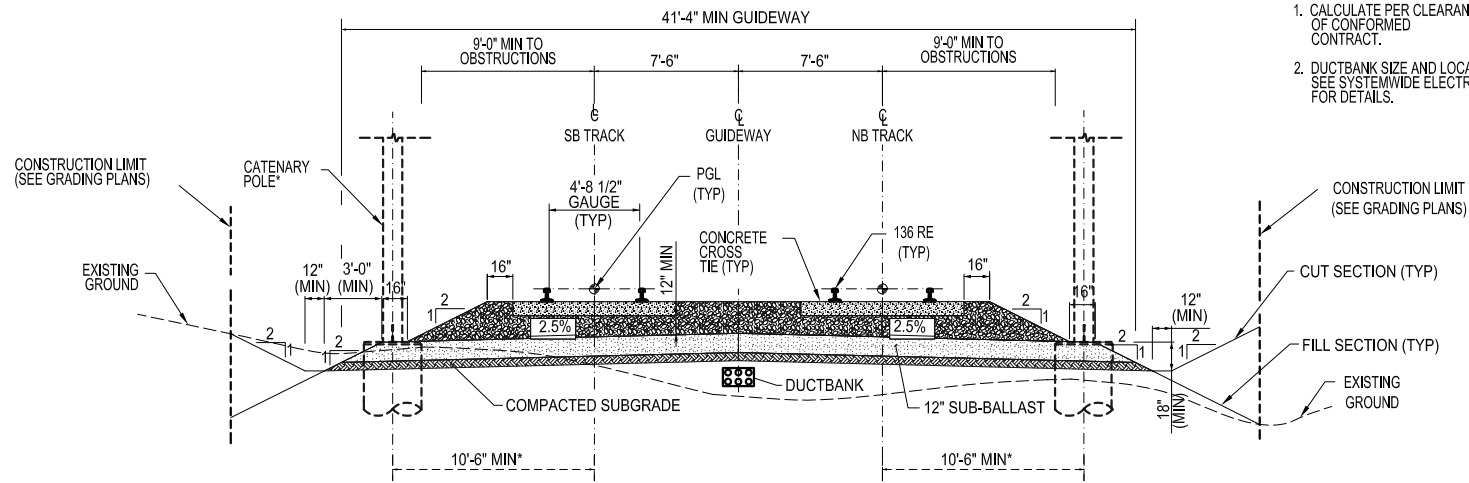
DESIGN CRITERIA

TITLE: TRACK  
 MINIMUM TRACKWAY CLEARANCES

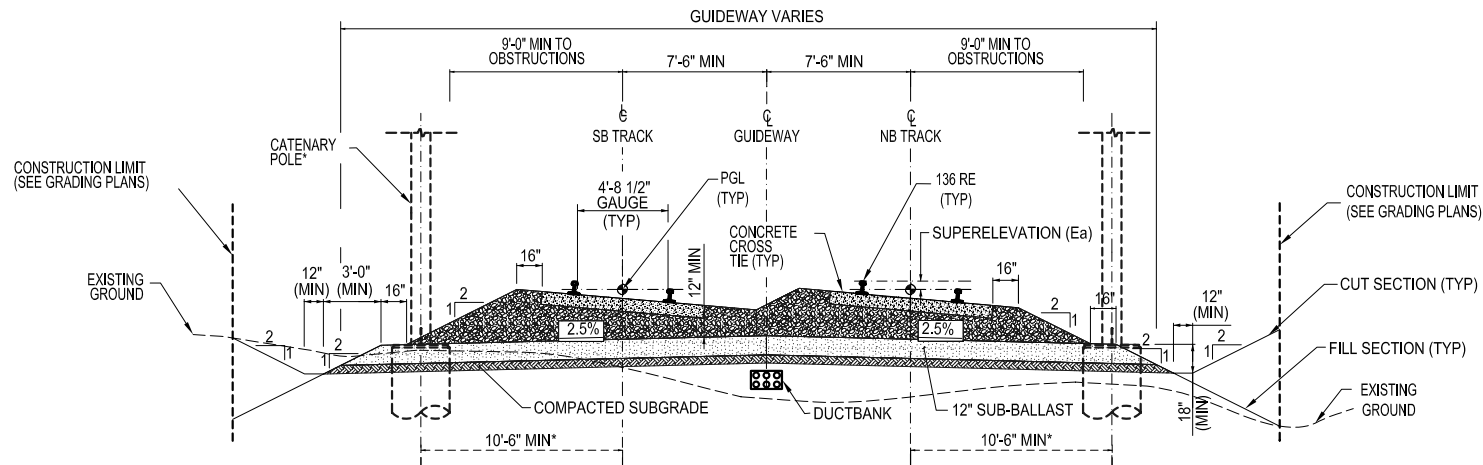
FIGURE: 4.4

NOTES FOR TRACKWORK TYPICAL SECTIONS:

1. CALCULATE PER CLEARANCE REQUIREMENTS OF CONFORMED CONTRACT.
2. DUCTBANK SIZE AND LOCATION VARIES. SEE SYSTEMWIDE ELECTRICAL PLANS FOR DETAILS.



**(A) BALLASTED DOUBLE TRACK - TANGENT SECTION - UNCONSTRAINED**



**(B) BALLASTED DOUBLE TRACK - SUPERELEVATED SECTION - UNCONSTRAINED**

\* WHERE APPLICABLE

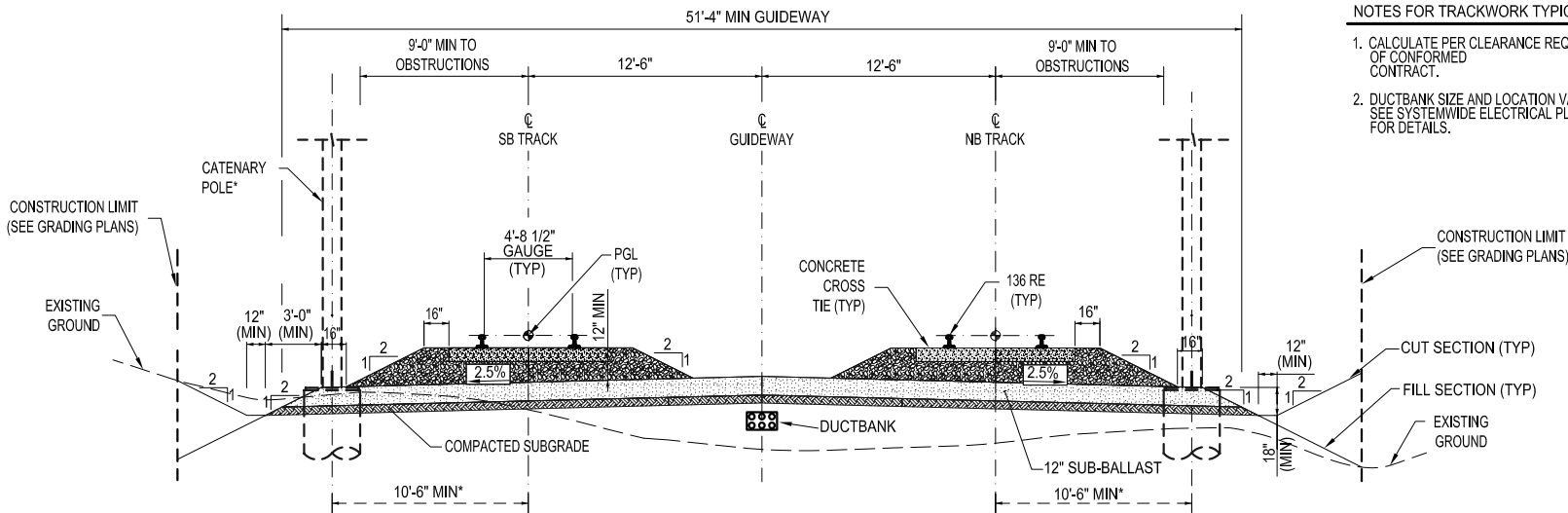


REGIONAL TRANSPORTATION DISTRICT  
1600 BLAKE STREET  
DENVER, COLORADO 80202  
(303) 628-9000

# DESIGN CRITERIA

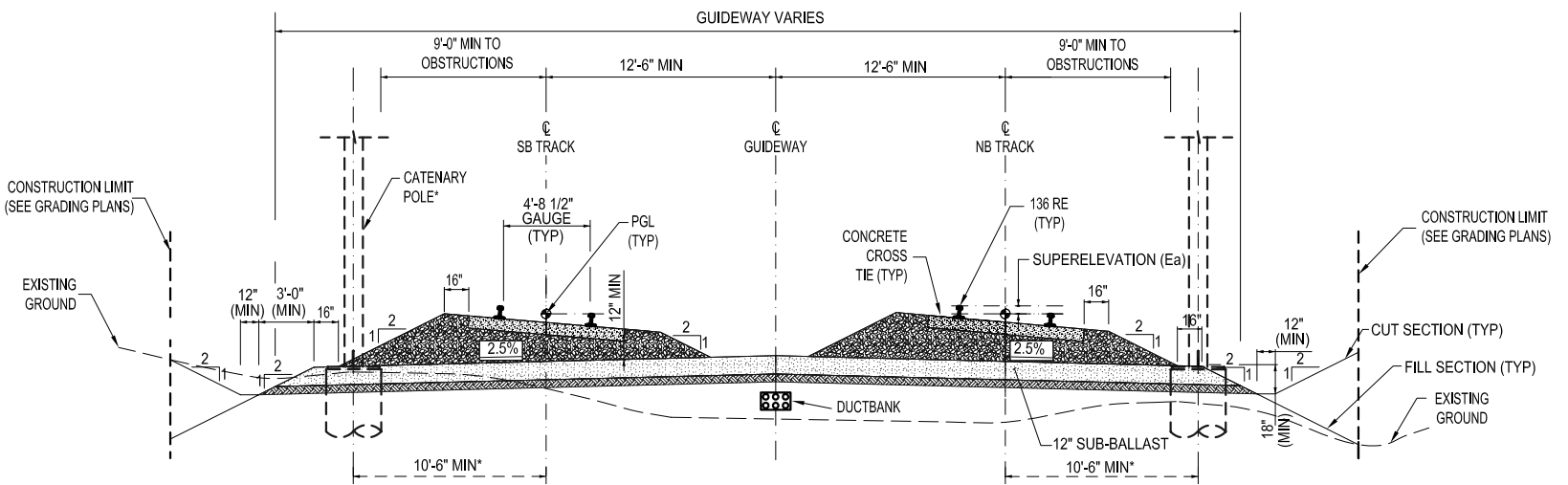
TITLE: TRACK  
BALLASTED DOUBLE TRACK TYPICAL SECTION  
15' TRACK CENTERS

FIGURE: 4.5



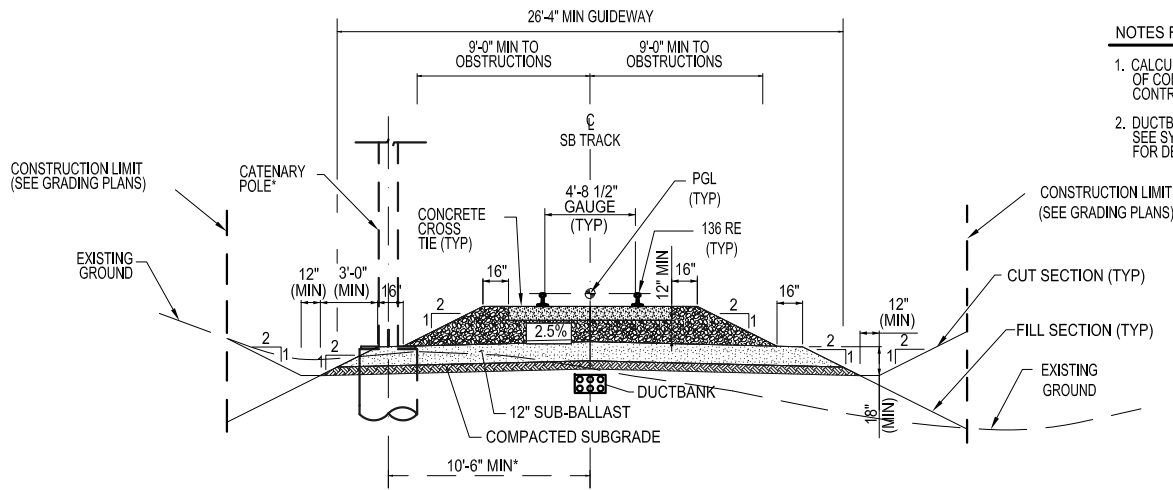
- NOTES FOR TRACKWORK TYPICAL SECTIONS:**
1. CALCULATE PER CLEARANCE REQUIREMENTS OF CONFORMED CONTRACT.
  2. DUCTBANK SIZE AND LOCATION VARIES. SEE SYSTEMWIDE ELECTRICAL PLANS FOR DETAILS.

**(A) BALLASTED DOUBLE TRACK - TANGENT SECTION - UNCONSTRAINED**



**(B) BALLASTED DOUBLE TRACK - SUPERELEVATED SECTION - UNCONSTRAINED**

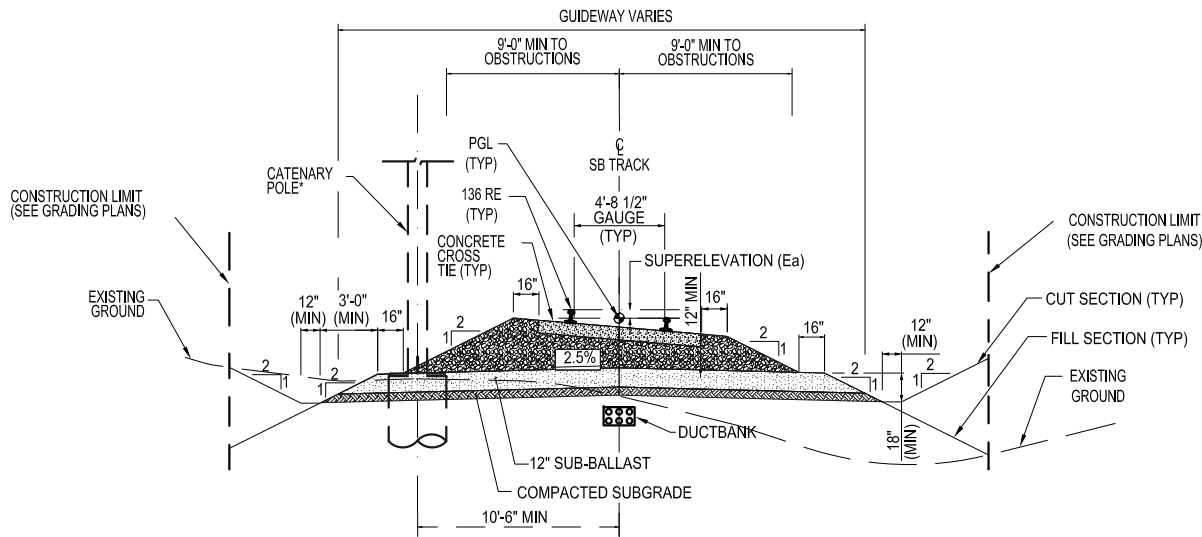
\* WHERE APPLICABLE



**NOTES FOR TRACKWORK TYPICAL SECTIONS:**

1. CALCULATE PER CLEARANCE REQUIREMENTS OF CONFORMED CONTRACT.
2. DUCTBANK SIZE AND LOCATION VARIES. SEE SYSTEMWIDE ELECTRICAL PLANS FOR DETAILS.

**(A) BALLASTED SINGLE TRACK - TANGENT SECTION - UNCONSTRAINED**



**(B) BALLASTED SINGLE TRACK - SUPERELEVATED SECTION - UNCONSTRAINED**

\* WHERE APPLICABLE

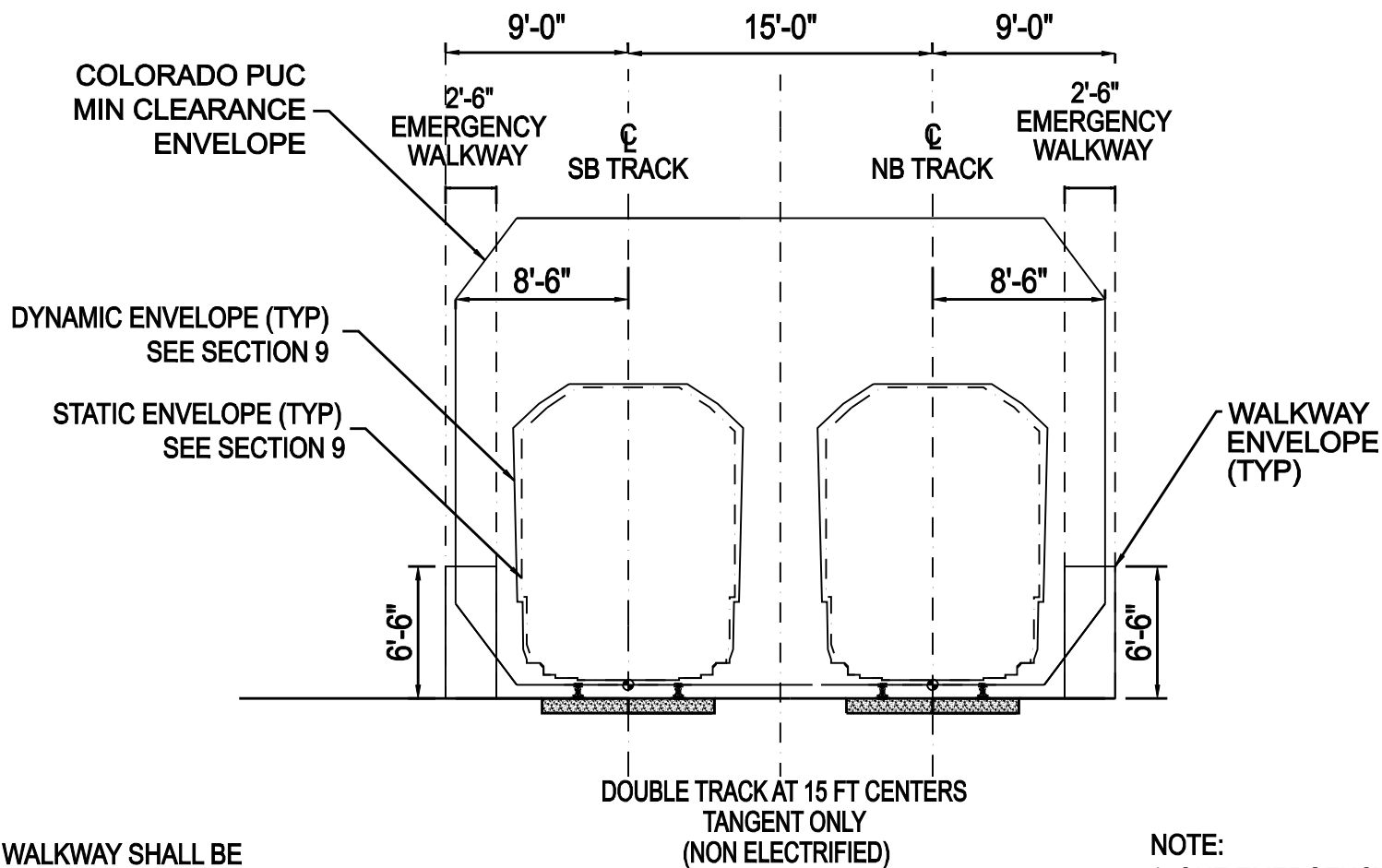


REGIONAL TRANSPORTATION DISTRICT  
1600 BLAKE STREET  
DENVER, COLORADO 80202  
(303) 628-9000

# DESIGN CRITERIA

**TITLE: TRACK  
BALLASTED SINGLE TRACK SECTION**

**FIGURE: 4.7**



FLOOR OF WALKWAY SHALL BE  
LOCATED ABOVE TOP OF TIE AND BELOW  
TOP OF RAIL ON RESTRAINED AND STRUCTURE  
SECTIONS

NOTE:  
1. ONE EMERGENCY WALKWAY IS REQUIRED  
FOR EACH TRACK.

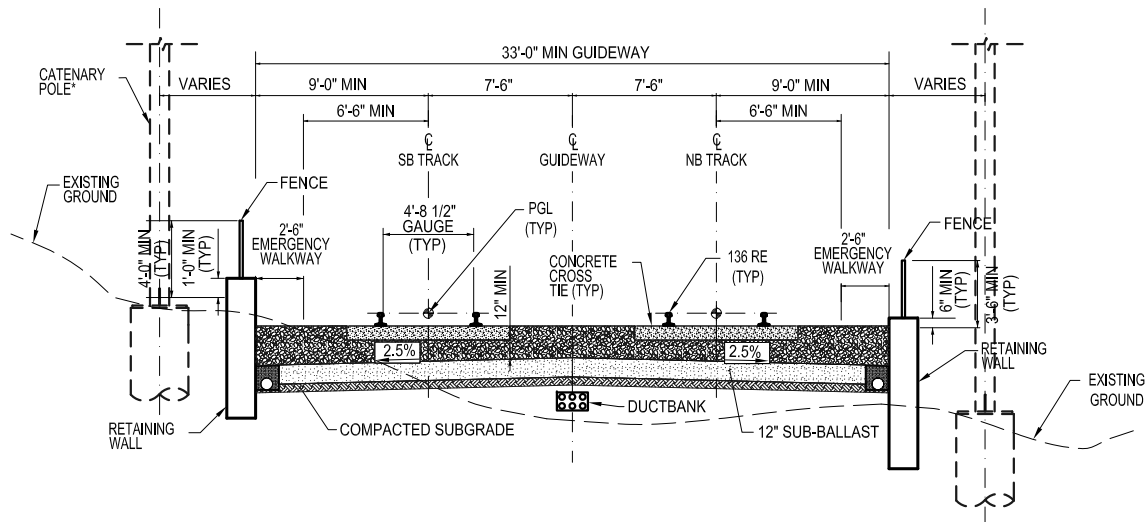


REGIONAL TRANSPORTATION DISTRICT  
1600 BLAKE STREET  
DENVER, COLORADO 80202  
(303) 628-9000

## DESIGN CRITERIA

TITLE: EMERGENCY WALKWAY PLACEMENT  
FOR CONSTRAINED SECTIONS

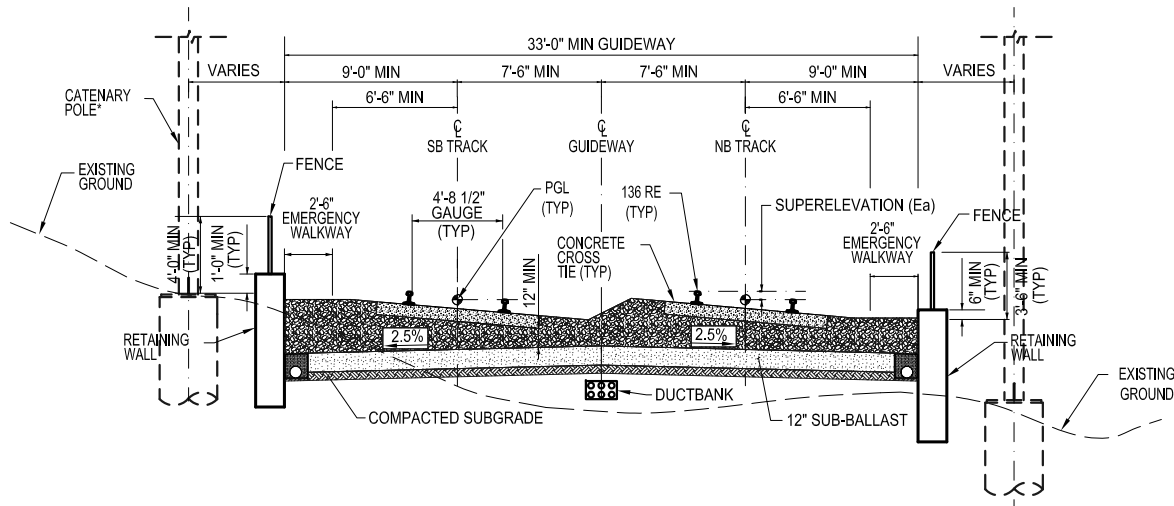
FIGURE: 4.8



**NOTES FOR TRACKWORK TYPICAL SECTIONS:**

1. CALCULATE PER CLEARANCE REQUIREMENTS OF CONFORMED CONTRACT.
2. DUCTBANK SIZE AND LOCATION VARIES. SEE SYSTEMWIDE ELECTRICAL PLANS FOR DETAILS.

**(A) BALLASTED DOUBLE TRACK - TANGENT SECTION - CONSTRAINED**



**(B) BALLASTED DOUBLE TRACK - SUPERELEVATED SECTION - CONSTRAINED**

\*WHERE APPLICABLE



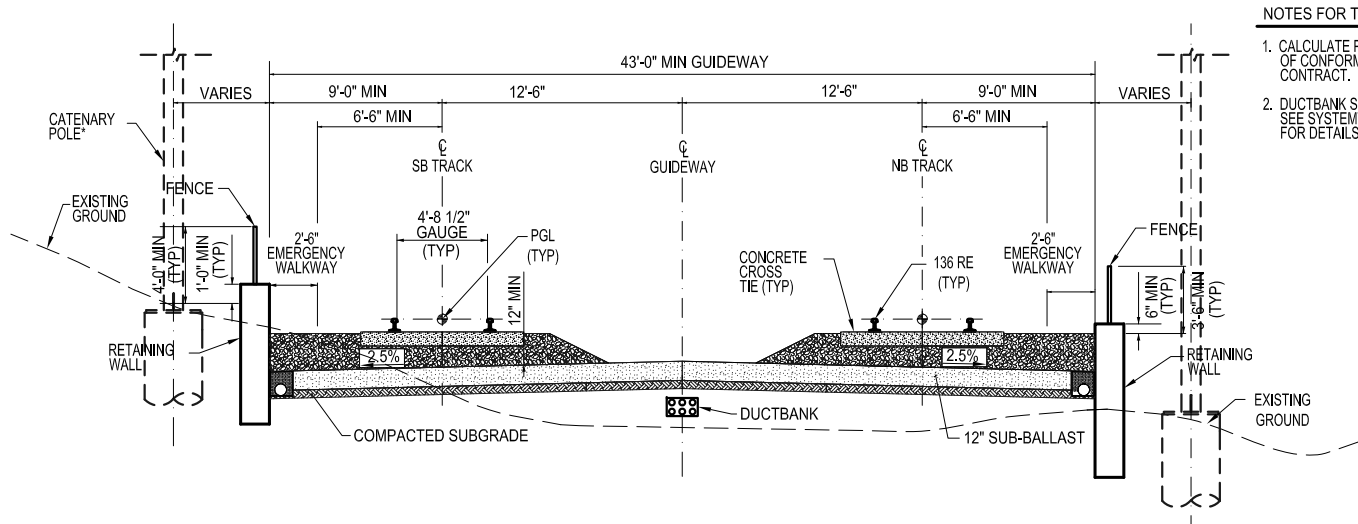
REGIONAL TRANSPORTATION DISTRICT  
1600 BLAKE STREET  
DENVER, COLORADO 80202  
(303) 628-9000

# DESIGN CRITERIA

**TITLE: TRACK  
RETAINED SECTION - 15' TRACK CENTERS**

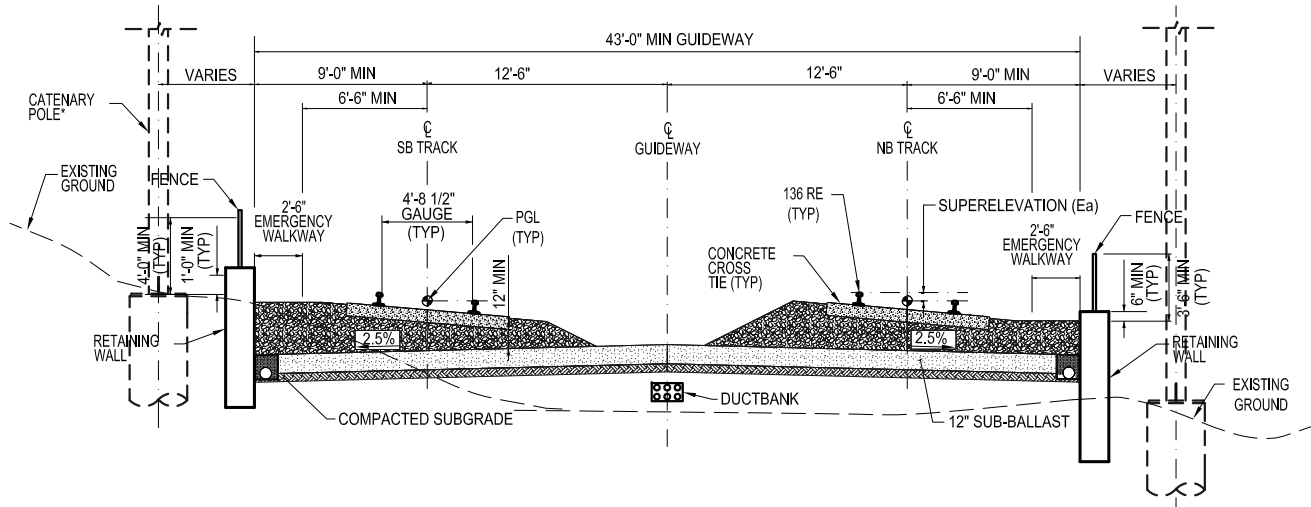
**FIGURE: 4.9**





- NOTES FOR TRACKWORK TYPICAL SECTIONS:**
1. CALCULATE PER CLEARANCE REQUIREMENTS OF CONFORMED CONTRACT.
  2. DUCTBANK SIZE AND LOCATION VARIES. SEE SYSTEMWIDE ELECTRICAL PLANS FOR DETAILS.

**(A) BALLASTED DOUBLE TRACK - TANGENT SECTION - CONSTRAINED**



**(B) BALLASTED DOUBLE TRACK - SUPERELEVATED SECTION - CONSTRAINED**

\* WHERE APPLICABLE



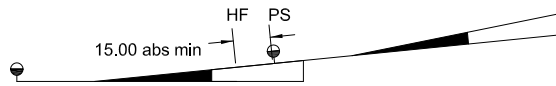
REGIONAL TRANSPORTATION DISTRICT  
1600 BLAKE STREET  
DENVER, COLORADO 80202  
(303) 628-9000

# DESIGN CRITERIA

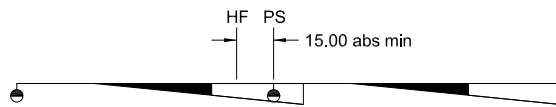
**TITLE: TRACK  
RETAINED SECTION - 25' TRACK CENTERS**

**FIGURE: 4.10**

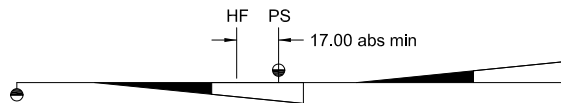
# REQUIRED TURNOUT SEPARATIONS



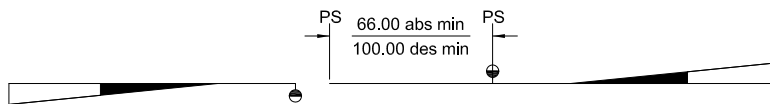
Heel of Frog to Point of Switch  
(same hand TO side)



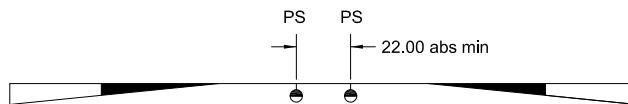
Heel of Frog to Point of Switch  
(same hand)



Heel of Frog to Point of Switch  
(opposite hand)



Point of Switch to Point of Switch  
(same hand)



Point of Switch to Point of Switch  
(opposite hand)

NTS  
(#10 TO shown)

N.T.S.

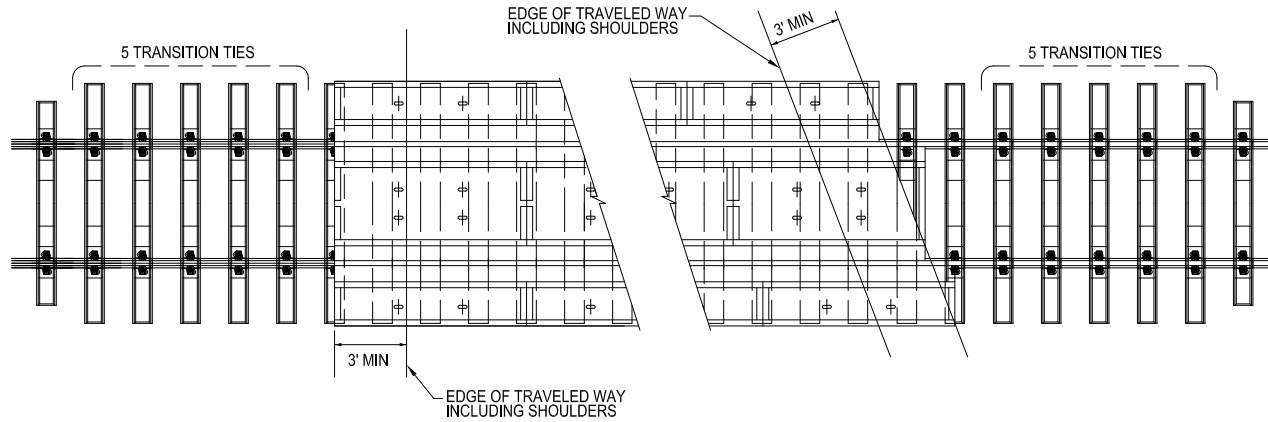


1560 BROADWAY, SUITE 700  
DENVER, COLORADO 80202  
(303) 299-6990

DESIGN CRITERIA

TITLE: TRACK  
REQUIRED TURNOUT SEPARATIONS

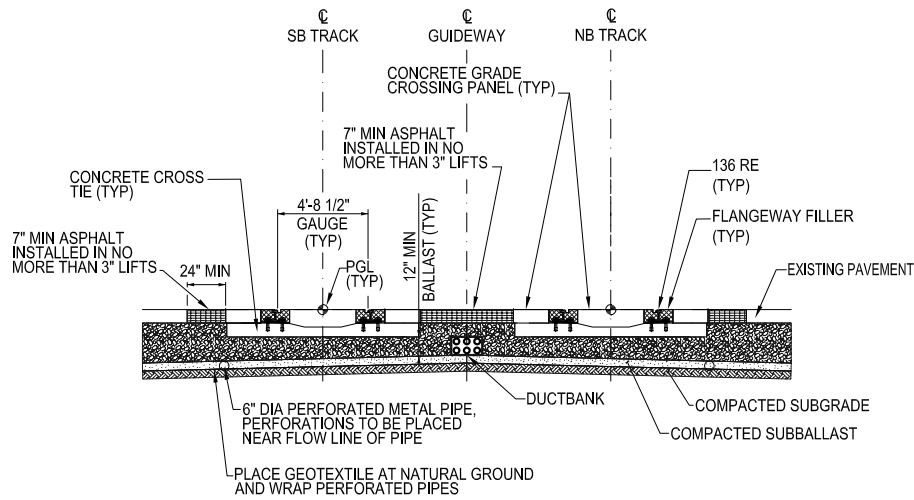
FIGURE: 4.11



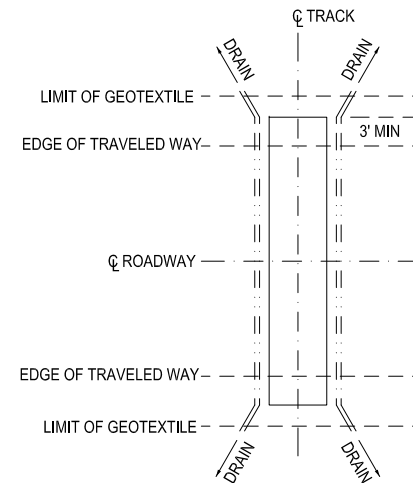
(A) PLAN VIEW

NOTES FOR GRADE CROSSING TYPICAL SECTION:

- CROSS TIE SIZE AND SPACING AT GRADE CROSSINGS SHALL BE IN ACCORDANCE WITH THE MANUFACTURER'S RECOMMENDATIONS.



(B) SECTION VIEW



(C) TYPICAL PIPE LAYOUT

N.T.S.



REGIONAL TRANSPORTATION DISTRICT  
1600 BLAKE STREET  
DENVER, COLORADO 80202  
(303) 628-9000

# DESIGN CRITERIA

TITLE: TRACK  
GRADE CROSSING TYPICAL SECTION

FIGURE: 4.12

**TABLE OF CONTENTS**  
**SECTION 5 – STATION DESIGN**

5.0 GENERAL.....	3
5.1.1 BASIC GOALS.....	3
5.1.2 JURISDICTIONAL CODES.....	4
5.1.3 LEVEL OF SERVICE CLASSIFICATION AND NFPA OCCUPANT LOADING .....	5
5.2 SITE PLANNING.....	5
5.2.1 SITE ANALYSIS.....	7
5.2.2 HISTORIC PRESERVATION.....	7
5.3 CIRCULATION AND SITE REQUIREMENTS .....	8
5.3.1 MODAL ACCESS.....	8
5.3.2 EMERGENCY EXITING.....	11
5.3.3 LANDSCAPING AND UTILITIES.....	11
5.4 STATIONS.....	12
5.4.1 PLATFORM ARRANGEMENTS .....	12
5.4.2 PLATFORMS (CONCOURSES).....	12
5.4.3 PEDESTRIAN AT-GRADE CROSSINGS .....	14
5.4.4 PEDESTRIAN CONTROL GATES .....	14
5.4.5 GRADE SEPARATED CROSSINGS.....	14
5.4.6 TRANSITION PLAZA.....	15
5.4.7 COMMUNITY RELATIONSHIP.....	15
5.5 SHELTERS AND FURNITURE.....	16
5.5.1 DESIGN OBJECTIVES .....	17
5.5.2 PASSENGER SHELTERS.....	17
5.5.3 WINDSCREENS .....	18
5.5.4 FURNITURE .....	18
5.5.5 SERVICE BUILDINGS .....	18
5.5.6 MATERIALS AND FINISHES.....	19
5.5.7 PERFORMANCE STANDARDS.....	19
5.6 STATION EQUIPMENT .....	21
5.6.1 PLUMBING .....	21
5.6.2 ELECTRICAL OUTLETS .....	22
5.7 COMMUNICATIONS.....	22
5.7.1 DIRECTIONAL SIGNS.....	22
5.7.2 DESIGN OBJECTIVES .....	22
5.7.3 TELEPHONES.....	22
5.7.4 CCTV DISPLAYS AND VARIABLE MESSAGE SIGNS (VMS) .....	23
5.7.5 SECURITY EQUIPMENT.....	23
5.8 ELECTRICAL SYSTEMS.....	23
5.8.1 STANDARDS AND CODES.....	24
5.8.2 STATION POWER AND ELECTRICAL SYSTEM .....	24
5.9 FARE COLLECTION SYSTEM.....	27

## LIST OF FIGURES

FIGURE 5.1	TYPICAL CR 8-CAR SIDE-SIDE 16' PLATFORM PLAN.....	26
FIGURE 5.2	Typical CR side-side 16' Platform Section w/ End grade crossings .....	27
FIGURE 5.3	Typical CR side-side 22' Grade Separation Crossing Platform Plan .....	28
FIGURE 5.4	Typical CR Side-Side 22' Grade Separation Platform Section .....	29
FIGURE 5.5	Typical CR 8-car Center 30' Platform Plan .....	30
FIGURE 5.6	Typical CR 8-car Center 30' Platform Section .....	31
FIGURE 5.7	Typical CR Center/Side 30' Grade separation Platform Plan.....	32
FIGURE 5.8	Typical CR Center/Side 30' Grade Separation Platform Section .....	33

## SECTION 5 - STATION DESIGN

### 5.1 GENERAL

These criteria are intended to provide definitive guidance to design professionals in the planning, design and preparation of Commuter Rail (CR) station contract documents.

These criteria have also been established to enhance the safety and quality of the system, which has a fundamental impact on the ability to attract and sustain patronage.

A commuter rail station comprises site access, parking (modal access), transition plaza, platform, tracks, and all appurtenances necessary to provide for the public safety, protection from the elements, and public information. The station also serves as a gateway in and out of a community as the origin/destination source of passenger traffic.

#### 5.1.1 BASIC GOALS

The basic goals for these criteria are to provide the design professionals with the information necessary to maximize the design effort in providing a safe functional station. The station area must provide a safe and efficient transition from multi-modal arrival areas through a space that provides ticketing, schedule and community/regional information; to a station platform (concourse) that provides a safe area from which to board the Commuter Rail trains. All station areas must take into account the safety and comfort of the patron through appropriate lighting and protection from the elements. This criteria covers that portion of station design from the bus boarding/alighting location to the train platform. For criteria on park and Ride design, reference the RTD Bus Transit Facility Design Guidelines and Criteria.

This criteria provides the basis for design decisions and shall be used to evaluate submitted designs for commuter rail facilities.

The criteria incorporates the influence of the following technical information on station design and layout:

- Facility Type
- Ridership levels
- Site conditions & physical location
- Levels of Service
- Operational Requirements

Commuter rail station design professionals shall incorporate sustainable design measures into the overall design and the station area design should be integrated into the communities they serve. Although RTD does not have an art-n-Transit program for Commuter Rail, in the event art opportunities become available, inclusion of opportunities for art elements at the station should be part of the design concepts.

### 5.1.2 JURISDICTIONAL CODES

The nature of Commuter Rail causes its alignment to travel through numerous districts, cities, and counties. Each of these legally defined areas has different land use and development regulations and legislative procedures directly affecting station site planning and design. Each individual jurisdiction may have special amendments or supplements to codes and standards that apply on a statewide and national basis. Therefore:

- Identify the governing jurisdiction for each site at every governmental level;
- Locate jurisdictional boundaries;
- Review applicable adopted master plans and municipal codes;
- Use the latest edition of the following:
  - International Building Code,
  - NFPA 130 fire protection code, NFPA 101
  - State of Colorado "Building Regulations for Protection from Fire and Panic,"
  - U.S. Department of Transportation's Transportation for Individuals with Disabilities; Final Rule, including 49 CFR Parts 27, 37 and 38 with Appendix A "Standards for Accessible Transportation Facilities,"
  - ANSI A17-1,
  - ADAAG,
  - AREMA,
  - Colorado PUC,
  - FTA (49 CFR),
  - FRA,
  - MUTCD and
  - Jurisdiction rail agency requirements.

Generally, station facilities should be designed to meet all requirements of all applicable federal, state, and local codes and regulations. Codes shall be analyzed with regard to this criteria manual, the governing jurisdictions interpretation and which ever interpretation and/or code provide the most stringent application for the public good.

### 5.1.3 LEVEL OF SERVICE CLASSIFICATION AND NFPA OCCUPANT LOADING

Queuing level of service standards for station platforms provides the designer a way to determine pedestrian space for transit patrons and platform sizes. Level of service standards for pedestrian queuing is provided in the table below.

Level of Service	Average Pedestrian Area Occupancy
A	13 SF/person or more
B	10-13 SF/person
C	7-10 SF/person
D	3-7 SF/person
E	2-3 SF/person
F	2 SF/person or less

Platform sizing is partially a function of the occupant loading. A minimum level of service D shall be provided to accommodate the “Platform Occupant Load” as defined by NFPA 130. This allows the platform to accommodate the peak period occupant load based on the simultaneous evacuation of an entraining load and a full train entering the station at maximum capacity. During regular service, the platforms then function at much higher levels of service.

When calculating platform area requirements, 3.5 feet in width (total) shall be added for ineffective area along the platform edges and 0.5 SF/person shall be added to accommodate amenities on the platform.

## 5.2 SITE PLANNING

The purpose of this section is to describe the system-wide design philosophy for station layout and related site development. The facilities to be designed shall address the following:

**Rail track way** – use existing commercial railroad right-of-way or public right-of-way where possible. Keep consistent with system goals and objectives.

**Rail platforms** – develop on tangent section of track, linear progression from train to platform to transition plaza to multi-modal means of station access. Site design should accommodate the possible future expansion of platforms up to 800-feet-long on tangent track.



**Bus and auto roadways** – usually a primary multi modal means of accessing station. Coordinate with local traffic patterns and segregate from secondary multi-modal means of access. It is also necessary to separate bus and automobile traffic particularly at the access and egress points of the park-n-Ride.

**Pedestrian walkways** – a secondary multi modal means of accessing station. Coordinate with local pedestrian access ways; segregate from motorized means of access.

**Bicycle paths** - a secondary multi modal means of accessing station. Coordinate with local bicycle access ways; segregate from motorized multi-modal means of access. Bicycle paths shall only cross platforms at grade when pedestrians cross at grade and when adjacent to station platforms shall be separated by an adequate barrier. Avoid placement of pedestrian crossings at platforms on line with local or regional bicycle travel routes.

**Auto and taxi drop off and waiting zones** – RTD’s Bus Transit Facility Design Criteria is to be used as a reference for this part of the overall station design or coordinated through the park-n-Ride design consultant or RTD staff.

**Kiss-n-Ride** - RTD’s Bus Transit Facility Design Criteria is to be used as a reference for this part of the overall station design or coordinated through the park-n-Ride design consultant or RTD staff.

**Parking structures** – determined by ridership and available land use and ownership. RTD’s Bus Transit Facility Design Criteria is to be used as a reference for this part of the overall station design or coordinated through the park-n-Ride design consultant or RTD staff.

**Parking areas zones** – RTD’s Bus Transit Facility Design Criteria is to be used as a reference for this part of the overall station design or coordinated through the park-n-Ride design consultant or RTD staff.

**Landscaping** is used to enhance the overall aesthetic value of the station design. Landscaping can be used to define the boundary from modal access to the transition plaza and from the transition plaza to the platform. At the transition plaza it can be used to define traffic patterns, provide shade and at the “border” between the transition plaza and the platform, landscaping can give definition to means of accessing the platform. Landscaping shall not impede visibility of platform areas or create hiding spaces. Generally speaking, there should be no landscaping planned for the platform. Refer to the RTD Bus Transit Facility Design Guidelines and Criteria for specific landscape requirements at stations.

**Elevators, ramps and stairs-** Site selection should be such as to minimize or negate the need for vertical circulation. In cases where this is not possible follow local jurisdictional agencies regulations, RTD standards and practices, local building codes; ADAAG, AMSI 117.1, NFPA 130, NFPA 101 and other applicable standards and practices. At a minimum, elevator shafts and elevator cars will have three sides that are transparent the full length of travel and full height of car, unless prohibited by code.

**Signage-** RTD's Transit Systems Signage Standards shall be used. Conform to MUTCD where applicable.

These elements are to be located at each station site in a manner that is functional, safe, easily maintained and attractive to passengers and neighboring residents.

### **5.2.1 SITE ANALYSIS**

Site analysis is the process in which the characteristics of a potential station site are gathered together. Typical physical characteristics to be evaluated are:

General circulation and access

Context;

Views to and from the site;

Weather conditions;

Topography;

Existing infrastructure and building improvements;

Land use;

Existing vegetation;

Drainage;

Solar Orientation;

Traffic Counts;

Soils Information; and

Existing Utilities.

### **5.2.2 HISTORIC PRESERVATION**

At the beginning of the station location process by the Design Engineers, potential applicability of requirements of the Historic Preservation Act and Section 4(f) of the Transportation Act of 1966 should be addressed.

Where CR stations may affect historical areas or structures, potential impact zones should be identified. These would include areas where station placement would block views or interfere with pedestrian circulation and access.

If joint use were to be planned, the Design Engineer should develop a design program which identifies those agencies or citizen groups which are likely to be involved and the procedure to be followed for approach of design. The program should also identify significant architectural features which should be taken into account in station and site design.

If a portion of an historic structure is to be retrofitted to accommodate a CR station, security and safety features necessary to preserve the significant historic characteristics of the structure should be incorporated into the station design.

### **5.3 CIRCULATION AND SITE REQUIREMENTS**

Each mode of transportation has specific circulation and operational requirements. While each mode has its own unique characteristics, it is recognized that all modes must respect and enhance the operation and access of other modes that interface in and around rail transit facilities.

Underlying site requirements that support transit such as parking, furnishings, operating equipment, shelters, and landscaping provide convenience, comfort, accessibility, and an enhanced transit experience for our passengers.

Performance standards based on design objectives shall be the basis for all design decisions. They provide the fundamental framework for resolving the inter-relationship between each of the station activities and the means for minimizing conflicts and maximizing efficiency.

The above is a broad description of circulation and site requirements, it and the following descriptions needs to be developed with the use of the RTD Bus Transit Facility Design Criteria.

#### **5.3.1 MODAL ACCESS**

CR is a more predictable and confined form of transit in that it operates within an exclusive fixed guide way right-of-way. Passengers tend to arrive at or near the scheduled CR departure time and do not spend a lot of time waiting. Therefore, modal interchange becomes a key consideration in station design.

Provide a safe, efficient, and convenient configuration for inter-modal transfer to the station.

Provide clear and easily understood transit information that can be referenced quickly and that minimizes disorientation.

Develop operational efficiencies that simplify modal interchange and passenger processing.

Minimize congestion and crossings of inter-modal functions.

Adhere to AREMA, FRA and PUC guidelines for at grade and grade separated crossings.

Locate station platforms on horizontal and vertical tangent sections.

Modes are the means that passengers access CR stations. Typical access modes considered in these criteria are:

Commuter Rail (CR)

Light Rail (LRT)

Street Car

Bus

Walk

Bike

Automobile

There are distinct differences between each mode in terms of maneuverability, safety, speed, visibility, space requirements, compatibility, and reliability. The following describes the basic characteristics for each mode.

#### **5.3.1.1 Bus Access**

The bus system will be integrated with CR and provide feeder routes to station facilities. Where applicable, there will be a hierarchy of vehicular modes of access, giving priority to feeder buses. The following are general criteria that will help guide the site planning process:

- Minimize situations where buses are required to cross CR tracks.
- Make provisions to provide emergency bus service in the event of a CR system failure.
- Bus and automobile access should be separated wherever possible.
- Minimize conflicts between buses, trains, automobiles, bicycles and pedestrians.
- Specific requirements for the design of bus facilities and access are provided in the RTD Bus Transit Facility Design Guidelines and Criteria.

### **5.3.1.2 Pedestrian Access**

Good pedestrian circulation to, from, and across train stations is essential for the smooth and safe operation of stations. Circulation patterns should be as simple, obvious, and comfortable as possible. Some of the points that warrant careful review for applicability and consideration in achieving good pedestrian orientation and circulation follow:

- Provide ramps and elevators in accordance with ADAAG and ANSI A17-1 as required for disabled patrons.
- Pedestrian access from bus, kiss-and-ride and park-and ride areas must be as clear and as simple as possible.
- Circulation elements shall use color, texture, and pattern and sight distances to increase visual pleasure, guidance, patron safety and security.
- Provide adequate space to avoid bottlenecks.
- Avoid cross-circulation at fare collection and decision points. Generally provide right-hand circulation.
- Provide well-lit pedestrian walkways.
- Provide a minimum of 8.5 ft of clear space between the edge of the platform and obstructions such as stairs, escalators, railings, or columns.
- Locate passageways, shelters, stairways, etc., to encourage balanced train loading and unloading. Passengers tend to board at such connection points on the platform.
- Grade changes are to be minimized, and where necessary they shall conform to slope criteria for disabled access.
- Cross flows, dead ends, and turns greater than 90 degrees are undesirable for both patron security and circulation.
- Circulation shall be designed to provide ample waiting space adjacent to, but out of the mainstream of, pedestrian flow.
- Surge and queuing spaces shall be provided ahead of every barrier and change in circulation, direction, or mode.
- Obstructions such as telephone booths, pylons, advertising displays, fare vending machines, benches, trash receptacles or maps are not allowed within the pedestrian through zone.

- Provide adequate sight distance and visibility along pedestrian routes.
- Provide at grade track-crossing clear of train with control gates for pedestrians to access other platforms. Grade separated crossings shall be provided as directed by RTD.
- Provide a minimum of two points of access/egress from the platform that meet requirements of NFPA 130, 5.5.3 and 5.5.3.5.

### **5.3.1.3 Bike Access**

Those passengers arriving by bicycle shall be accommodated in the safest and most inviting manner possible. Bike racks/lockers shall be located at park and rides within the guidelines of the System Safety and System Security Design Section. No bike lockers or racks shall be allowed on the platform. Bike lockers shall be placed subject to threat and vulnerability analysis and in accordance with the section on Publicly Accessible Receptacles in the System Safety and System Security Design chapter. No bike lockers shall be placed within 250 feet of a station area or patron gathering area.

### **5.3.1.4 Auto Access and Parking**

Auto access shall be provided in a manner that meets all state and local codes and does not interfere with access modes of higher priority. Refer to RTD's Bus Transit Facility Design Criteria.

## **5.3.2 EMERGENCY EXITING**

Design Objectives

Any fully loaded station platform shall be able to be evacuated in accordance with NFPA 130 paragraphs 5.5.3 Occupant Load through 5.5.3.5 Number and Capacity of Exits; and

Provide not less than two exits from any station area or platform. (See NFPA 130 reference)

## **5.3.3 LANDSCAPING AND UTILITIES**

Trees shall not be planted within 10 feet of water and sanitary sewer lines. Trees and shrubs shall not be planted within 5 feet of buried electrical cables, gas lines, and telephone lines. Trees and shrubs shall not be planted within a 15 foot radius of high mast lighting towers.

## 5.4 STATIONS

Stations consist of; **platform (concourse)-area** where passengers walk to and from trains and where passengers queue in anticipation of boarding trains; **transition plaza**, a space necessary to facilitate the movement of patrons from the parking areas or other means of (modal) access to the platform and from the platform to their modal access. The station basic design criteria are as follows:

- Coordinate platform and transition plaza with bus, kiss-n-ride, park-n-ride, pedestrian and bike access.
- Adhere to jurisdictions governing railroads and RTD guidelines for platform safety requirements.

### 5.4.1 PLATFORM ARRANGEMENTS

The following three alternative platform arrangements can be used for stations:

- Side Platforms - Side platforms are located directly opposite one another, each servicing one mainline track (Figures 5-1 & 5-2 and 5-3 & 5-4);
- Center Platform - Single platform to service tracks located on each side of the platform (Figures 5-5 & 5-6).
- Side Center Platform –Dual platform system located directly opposite of one another similar to side platforms, but with only one track between platforms (Figures 5-7 & 5-8).

The platform arrangement used for each station shall be coordinated with the track alignment design (see Section 4), and will depend on available right-of-way and other site constraints.

### 5.4.2 PLATFORMS (CONCOURSES)

Meet set back from centerline of track and dynamic envelope requirements for clearances at platforms. Station platforms shall be designed in accordance with the requirements of ADA, PUC, NFPA 130 and other applicable codes.

The following presents fundamental criteria that are intended to produce efficient and pedestrian oriented platforms:

All platforms shall be designed to conform with Section 10 of "Standards for Accessible Transportation Facilities," U.S. Department of Transportation, including detectable warning strips on platform edges, governing rail agency standards, this manual and other pertinent codes and regulations

Planned platform length should be for an 8 car consist (or as required by the environmental decision document), however platforms shall be constructed to accommodate the required number of vehicles per consist per the most recent model information. In all locations length shall be considered for future expansion to 800 foot long platforms (or as required by the environmental decision document) on tangent track regardless of the length of platform currently being contemplated for immediate construction. Pedestrian access between plazas shall be at grade for commuter rail corridors with dedicated track and ROW. Pedestrian access shall be grade separated for corridors where commuter trains share track with freight traffic, and where express (bypass) tracks are planned to be constructed between platforms. Where roadways separate patrons from station platforms, grade separated pedestrian crossings shall be considered on a case-by-case basis.

The horizontal gap between the platform edge and edge of vehicle floor shall comply with USDOT and ADAAG requirements. Beneath the platform edge, there shall be a recess on not less than 24 inches horizontal depth, providing a place of refuge.

All platforms shall provide full-length level-entry boarding to all cars of trains. The platform height at the edge of platform face shall be 48 inches above the top-of-rail profile. If full-length level-entry boarding is technically or operationally infeasible, other solutions meeting ADA and FTA requirements may be employed with RTD approval.

Minimum platform width for side platforms shall be 16 feet, when peak hour ridership for the platform is projected to be less than 500 people. Minimum platform width for side platforms shall be 18 feet, when peak hour ridership for the platform is projected to exceed 500 people. Minimum width for center platforms shall be 30 feet. The above provides a minimum size that may be affected by ROW, available land, changes in topography, ridership and ADAAG requirements. Any deviation to the minimum must be approved by RTD prior to finalizing plans for platforms.

Platforms shall only be located on tangent track sections with 85 feet of tangent track at both ends of the platform and 300 feet from any at grade vehicular crossing.

Platform cross slopes shall not exceed 2% with a minimum of 1% and the maximum longitudinal slope shall be no more than 0.5% unless approved by RTD.

Mechanical and electrical equipment shall be placed on vertical surfaces, rooms or underground to reduce obstructions. Consider maintenance implications for each piece of equipment prior to under-grounding.

Provide clear emergency exiting from platforms (NFPA 130, 5.5.3, 5.5.3.1).

Concentrate fixed objects such as furniture, signage, shelters, etc. outside of the defined clear zone while maintaining adequate distance between



elements for circulation. Keep as much of the platform clear of fixed elements as possible.

The track area between platforms shall be paved at designated pedestrian crossings only. The minimum width for paved crossings shall be 20 feet.

Platforms and station exits shall be sized to accommodate the estimated or expected volume of passengers at level of defined by NFPA 130, 5.5.3 Occupant Load.

Generally exits shall be located at both ends of the platform to provide uncontested passenger movement. Where vertical circulation is provided, passenger exiting may be in the middle of the platform.

Exits shall provide safe egress from trains and platforms under normal operational and emergency conditions.

Barriers should not trap anyone between the CR right of way and vehicular traffic on adjacent roadways.

Where possible, provide clear and unobstructed perpendicular (zee crossing where required) pedestrian access across platforms or wherever modal interchange occurs.

#### **5.4.3 PEDESTRIAN AT-GRADE CROSSINGS**

Track crossings should provide pedestrians with the quickest and safest route across the tracks from one platform to another. Pedestrian at-grade crossings shall be 20 feet wide with 2 foot tactile warning strip along the track side. The at-grade crossings must meet all requirements of ADAAG and the Colorado PUC.

#### **5.4.4 PEDESTRIAN CONTROL GATES**

All at-grade pedestrian crossings at the stations shall include warning bells, blinking lights and gates. Manual pedestrian control gates shall be incorporated as an integral part of the station design.

#### **5.4.5 GRADE SEPARATED CROSSINGS**

Grade separated crossings either above ground or underground shall be designed with stairs/ramps and elevators to be open, well lit, safe and secure. Overpasses are preferred to underpasses due to visibility. All grade separated structures shall incorporate barrier-free design. Minimum overpass clearance shall be 30 feet above top of rail. Overpasses shall have a minimum width of 12 feet and minimum clear height of 8 feet. Overpasses should have a protective canopy or roof and appropriate railing, fencing or side barriers.

Underpasses should only be considered when requirements for safety, security and control can be met. A minimum 20 feet width, underpass access point should be visible from adjacent streets or the station. Design should eliminate curves or corners and a large enough opening to allow daylight from at least one end. Grade separated crossings shall be equipped with CCTV and emergency phones.

#### **5.4.6 TRANSITION PLAZA**

Transition plaza is a space described as an area necessary to facilitate the movement of patrons from the parking areas or other means of access to the platform. The transition plaza is where patrons can obtain tickets, view public information systems, access public phones and wait for pick-up.

The following are basic design criteria:

Design shall conform to ADA standards and other code requirements see subsection 5.1.2.

Provide easy access to Ticket Vending Machines (TVM, Stand alone validating machines (SAV), Information technology and public communication systems without impeding the flow of patrons from modes of access to the platform.

Pedestrian flow shall be defined by a combination of pattern, texture, color and signage.

TVM, SAV, Information systems and other patron appurtenance must located adjacent to the line of travel without impeding the pedestrian flow and be screened from the sun and elements.

Vertical circulation, stairs, ramps and elevators, needed to reach the platform shall be constructed at the "border" of the transition plaza and platform, avoid intruding onto the platform area. ROW constraints and site design constraints could cause vertical circulation elements to be placed on platform. Conform to ADAAG for minimum circulation requirements.

Exiting requirements from the plaza are the same as the platform; follow NFPA 130, 5.5.3 and 5.5.3.5 Number and Capacity of Exits.

#### **5.4.7 COMMUNITY RELATIONSHIP**

Coordinate platform and transition plaza design with neighboring community. Community involvement is necessary to establish a sense of place of the station in the community and to develop a design for shelters, windscreens and other elements as a part of the community and overall corridor identity. As a part of the community development, RTD, its design team and community planners should facilitate transit oriented development (TOD) adjacent to the mass transit site. This is only viable if the governing body has zoning ordinances in place that facilitate a mixed use TOD, and a developer or group of developers with adjacent property is willing to work jointly with

RTD to facilitate a TOD that will enhance the transit facility and is a viable investment for the developer.

Protect, maintain and enhance existing community qualities that are valued.

Allow planning for transit-oriented development (TOD).

Recognize emerging development patterns that can be complemented, and that will compliment station development and increase ridership.

Initiate and coordinate programs with the community that limit local traffic impacts and minimize disruption during and after the implementation phase.

Work with local jurisdictional processes and agencies throughout project design and implementation.

Where feasible, implement an art-n-Transit program to instill a sense of ownership by the community and a sense of “place” for the station in the community and as a recognizable node along the corridor.

## **5.5 SHELTERS AND FURNITURE**

These criteria have been developed as a technical guide to safe and efficient station design while promoting community spirit. Stations are the focus of the rail system in that they are central to modal interchange and that thousands of passengers may circulate through rail platform areas daily. It is key to the operation of the entire transit system that station platforms are easily understood, friendly, and efficient for passengers, as well as RTD staff. Station design should not only consider the functional and operational efficiencies, but also integrate humanistic and community spirit into station design.

Plaza furnishings must be located so as not to impede the flow of patrons to the platform.

Create a commuter rail civic architecture that is permanent, functional and pleasant, and contributes to its context -- one that is not entirely a derivative of the transit system, but of the neighborhoods and community of which it is a part, yet maintains an overall line recognition and system identity.

Develop a family of station parts and furniture that are interchangeable and allow for the individual character of each neighborhood or community.

Protect transit passengers from adverse weather conditions (snow, rain, wind, and summer sun) and vehicular traffic. Provide seating at shelters and other protected locations on the platform.

Designs should interface with the master plans and code modifications of adjacent governing agencies.

Develop systems that use maintainable materials and minimize life cycle costs.

Provide an architectural and urban design framework that both defines and encourages joint development opportunities, yet maintains clear visibility of the station.

Develop station designs in conformance with RTD's standards for sustainable design.

Make transit a safe, secure, friendly and enjoyable experience

### **5.5.1 DESIGN OBJECTIVES**

Design objectives are identified as a means to achieving the basic goals of CR station design and site planning as follows:

Arrange station elements such that they provide safety and convenience for patrons and employees.

Arrange buildings so that they are accessible to those who use them, but out of the way of those who do not.

Use materials and construction practices that minimize maintenance requirements.

Use materials and construction practices that minimize life cycle costs.

Incorporate sustainable design practices in accordance with RTD's Sustainable Design Guidelines.

Standardize materials and construction practices.

Use materials and construction practices that are compatible with existing RTD facilities.

### **5.5.2 PASSENGER SHELTERS**

The following is a list of objectives that CR shelters should achieve:

- Provide passengers with comfort and protection from expected adverse weather conditions -- snow, rain, wind, and summer sun.
- Provide identity for the station as well as the surrounding area.
- Provide a feeling of security and means of surveillance.
- Provide adequate lighting per the minimum lighting requirements in Section 5.8.2.
- Utilize materials and construction practices that minimize maintenance requirements.
- Utilize materials and construction practices that minimize life cycle costs.
- Arrange and articulate shelters to create an enjoyable experience.
- Height of shelter shall match the exhibit.
- Minimum length of shelter shall be 40 feet. Longer or dual shelters to be determined by large ridership, local jurisdiction input and potential for shelter to tie to a transit oriented development (TOD).
- Width of shelter to be such as to not infringe on the vehicle clearance envelope. Minimum width shall be 12 feet.
- Passenger Shelters shall have snow and ice guards.

### **5.5.3 WINDSCREENS**

The following is a list of criteria for windscreens:

- Maximum height 6 feet 8 inches.
- 75% of the surface area must be translucent or transparent.
- Overall width depends on flow of pedestrians and location of the screen.
- Place where most effective in blocking prevailing winds.
- Provide minimum of one bench on lee side of the windscreen protecting from the prevailing winter wind.
- Comply with ADAAG for access and circulation around the wind screens.
- Windscreens should be constructed of materials that allow for the identification of persons and objects when looking through a windscreen from one side to the other side.

### **5.5.4 FURNITURE**

The following is a list of furniture to be used at the stations:

News rack locations must be approved by RTD's Security System's Administrator. No news racks shall be placed within 250 feet of a platform area or patron gathering area. Refer to the System Safety and System Security Design Section for specific requirements.

Trash receptacles shall be placed subject to threat and vulnerability analysis and in accordance with the section of Publicly Accessible Receptacles in the System Safety and System Security Design Section.

Bicycle lockers/rack. Do not place on platform, placement per the System Safety and System Security Design Section.

Four benches are the minimum per station.

See RTD's Facilities Maintenance Design Manual for preferred manufacturer and style.

Benches shall have anti-sleep rails that prevent persons from lying down on the bench.

### **5.5.5 SERVICE BUILDINGS**

Service buildings are defined as all structures not open to passengers, but which need to be accessible to RTD employees or contractors.

#### a) Equipment Rooms

Signal, electrical and communication rooms shall be sized according to the requirement identified by RTD Systems Engineering. Location shall be coordinated with Systems Engineering, Operations and Station Design team.

An enclosed storage area for facilities maintenance shall be provided at each station. The details for storage areas shall be prepared during site plan development in coordination with RTD.

#### b) Driver Relief Station

Driver relief stations (DRS) shall be provided at all RTD transit centers, park-n-rides and rail stations where bus or rail recoveries are scheduled, as part of new projects and future expansion of existing facilities. The DRS shall be provided where they can be used by both bus and CR operations per RTD direction. No access shall be provided for public use. Refer to RTD's Bus Transit Facility Design criteria for specific requirements.

### 5.5.6 MATERIALS AND FINISHES

The quality and character of station materials utilizing simple, durable materials has a direct effect on maintenance requirements and the image of each facility. Simple, durable materials in minimal sizes with long-standing availability, installed to facilitate replacement can diminish damage and maintenance while balancing the character and visual quality of each station. Because vandalism tends to breed upon itself, material and finish choice should minimize cleanup and repair time, and stations should never appear under-used or abandoned.

In specifying manufactured items or materials, preference shall be given to standard off-the-shelf items available from more than one supplier over custom-made or single-source items. In specifying finish, size, color, pattern or composition, slight variations in appearance should be allowed so less costly products or materials of equal quality can be utilized.

### 5.5.7 PERFORMANCE STANDARDS

#### 5.5.7.1 Durability

Durable and cost-effective materials shall be used that have consistent wear, strength, and weathering qualities. Materials shall be capable of good appearance throughout their useful life and shall be colorfast.

#### 5.5.7.2 Low Maintenance

Life cycle maintenance costs should be considered in the evaluation of all materials and finishes.

### **5.5.7.3 Quality of Appearance**

Materials should be appealing and harmonious in appearance and texture. They should reinforce system continuity while relating to the local context.

### **5.5.7.4 Cleaning**

Materials that do not soil nor stain easily shall be used and shall have surfaces that are easily cleaned in a single operation. Minor soiling should not be apparent. Commonly used equipment and cleaning agents should be utilized. All porous finishes subject to public contact shall be treated or finished in a manner that allows easy removal of "casual vandalism."

### **5.5.7.5 Repair or Replacement**

To reduce inventory and maintenance costs, materials shall be standardized as much as possible for easy repair or replacement with out undue cost or disruption of CR operation. For example, hose bibs, electrical outlets, lighting fixtures and lamps, information panels, signs, shelter materials, etc., shall be standardized on commonly available sizes and finishes for easy inventory stocking and installation.

### **5.5.7.6 Non-slip**

Entrances, stairways, platforms, platform edge strips, and areas around equipment shall have high non-slip properties. Floor finishes shall be non-slip even when wet. This is particularly important at stairs, elevators, and other areas near station entrances, as well as platform areas.

### **5.5.7.7 Corrosion Resistance**

Because of moisture and the electrical currents involved in transit operation, special consideration must be given to prevention of corrosion. Non-corrosive metals shall be utilized when possible or required.

### **5.5.7.8 Compatibility**

Selected materials shall be compatible with the Denver area climate and consistent with existing materials within the station vicinity. Materials for structures should harmonize with existing facilities on a site-specific basis.

### **5.5.7.9 Availability**

Selection of materials shall permit competitive bidding and emphasize regional products and processes over those not locally available.

#### **5.5.7.10 Fire resistance**

"Flame spread" ratings shall conform to the applicable building code definitions for the material use in a specified location.

#### **5.5.7.11 Finish Materials**

Dense, hard, nonporous materials shall be used in all applications. Finish materials shall be corrosion, acid, and alkali resistant and shall be compatible with chemical compounds required for maintenance.

#### **5.5.7.12 Detailing**

Detailing of finishes shall avoid unnecessary surfaces which may collect dirt and complicate cleaning. Wall surfaces shall be vertical and flush allowing for texture. All edge and finish materials shall be detailed, and incorporation of joints and textures should reduce the requirements for true, visually perfect installation over long distances.

#### **5.5.7.13 Waterproofing**

All finish materials in underground spaces shall be selected and detailed with proper attention to waterproofing, cavity walls, drainage, and venting. All drainage cavities shall have provisions for cleanout.

#### **5.5.7.14 Texture**

Materials within reach of passengers shall be easily cleaned, with a finish to prevent or conceal scratching, soiling, and minor reflective surfaces to maintain desired illumination levels. Materials with homogeneous colors shall be selected or those with surface finish or veneers. The use of paint, stains, and coatings shall be minimized. Graffiti proofing products shall be used to protect all surfaces susceptible to graffiti.

### **5.6 STATION EQUIPMENT**

This section includes all electromechanical equipment located on platforms other than communications equipment.

#### **5.6.1 PLUMBING**

A minimum of three in ground frost proof hose bibs shall be located at the station and platform areas. They shall be located to allow cleaning of the shelters, windscreens and furniture with the use of a 100-foot hose.

Coordinate utilities with driver relief station. See subsection 5.5.5b.



## **5.6.2 ELECTRICAL OUTLETS**

Provide a minimum of 3 duplex outlets 120V/20A, and one 240V/30A outlet.

Coordinate all outlet locations with RTD.

All outlets shall be waterproof. At least one 120V/20A duplex outlet shall be located in the roof structure of the shelter.

## **5.7 COMMUNICATIONS**

This section includes all communications media and devices used to communicate with transit passengers.

### **5.7.1 DIRECTIONAL SIGNS**

Clear, simple and consistent signage between modes of transportation and throughout stations reduces confusion and frustration while increasing patron comfort. The less time spent searching for connections, the more time will be available for enjoying the convenience of transit. Signage shall conform to Section 4.30 of "Standards for Accessible Transportation Facilities," U.S. Department of Transportation and RTD's most current version of its Transit Systems Signage Standards. See also NFPA 130 3-1.3, Warning Signs

### **5.7.2 DESIGN OBJECTIVES**

Minimize the number of decisions a passenger must make in order to transfer from mode to mode. At decision points it is preferable to limit the number of choices to two.

Arrange and distribute signage so that it is easily visible to passengers and employees who need to see it.

Utilize materials and construction practices that minimize maintenance requirements.

Utilize materials and construction practices that minimize initial cost as well as long-term maintenance expenditures.

Standardize materials and construction practices.

Utilize materials and construction practices that are compatible with existing RTD facilities and systems.

### **5.7.3 TELEPHONES**

Provide coin-operated telephones as required in each station, conforming to the requirements of Section 4.31 of "Standards for Accessible Transportation Facilities," U.S. Department of Transportation.

Public phones are not to be located on the platforms but should be located at or near the border between the platform and the transition plaza.

Public phones shall be easily visible from the station platforms, but located outside of circulation areas where the noise level is acceptable.

Emergency Telephone and Blue Light Station reference NFPA 130, 6.1.4.1 and 6.1.4.2

Refer to System Safety and System Security Design chapter for emergency telephone requirements.

#### **5.7.4 CCTV DISPLAYS AND VARIABLE MESSAGE SIGNS (VMS)**

Provisions shall be made for initial or future CCTV displays and VMS; either free standing or integrated, as required by RTD.

#### **5.7.5 SECURITY EQUIPMENT**

Provide security cameras and digital storage equipment as required in each station. Camera coverage of the stations shall be primarily confined to station platform and transition plaza areas, with special attention being paid to the fare collection equipment. Coordinate all design effort with RTD Safety and Security Group and Safety and Security Design Criteria. Refer to Section 14 System Safety and System Security for video surveillance and security requirements.

### **5.8 ELECTRICAL SYSTEMS**

This section establishes the design criteria for all electrical equipment for passenger stations. These criteria include functional and design requirements for the supply, control, and protection of AC power electrical systems. The electrical and mechanical equipment requiring power shall include the following:

- Lighting;
- Fare Collection Equipment;
- Communications and CCTV;
- Emergency Lighting (NFPA 130, 5.6, and NFPA 101) and Power Systems (if required); and
- Railroad Signal Equipment.

### **5.8.1 STANDARDS AND CODES**

AC power and electrical system design shall conform to the latest edition of the following standards and codes where applicable:

- National Electric Code (NEC), National Fire Protection Association (NFPA) No. 70
- National Electrical Safety Code (ANSI C.2)
- Electrical Codes of the local jurisdiction
- American National Standards Institute (ANSI)
- National Electrical and Electronic Engineers (IEEE)
- Life Safety Code (NFPA) - 101
- Insulated Power Cable (IPCEA)

### **5.8.2 STATION POWER AND ELECTRICAL SYSTEM**

These criteria establish the basic design requirements for AC Station Power Systems.

#### **STATION PLATFORM RACEWAYS AND PULL BOXES**

Station platform raceways shall be schedule 40 PVC conduits. Where station platforms are placed on fill, raceways shall be embedded in fill and located at a minimum depth of 18 inches below the finished grade of the platform slab. Where station platforms are not placed directly on fill, raceways shall be connected directly to the underside of the platform structure.

All conduit stub-ups through the platform slab or foundations shall be PVC/GRS conduit. Platform pullboxes shall be located along the platform, generally towards each end and in the middle of the platform to provide junction points for the communication cables and power wiring. Pullboxes shall be located at all Fare Collection locations. Pullboxes and covers shall be pre-cast high-density polymer concrete type with split covers if used for communication cables and power wiring and the box sections shall be divided. For all mainline platform conduit penetrations into the pullboxes, that run the length of the platform, they shall enter the side of the pullbox and be provided with bell ends. All lateral conduit penetrations into pullboxes shall enter the bottom of the pullbox and be provided with bell ends.

Communication conduits shall be provided to all planned and future communication and Fare Collection equipment on the station platforms. Spare conduits shall be provided to all mainline conduit runs along the length of the platform, and to all shelters including future shelters. All exposed conduits shall be painted to match the structure to which it is attached. All hookup wiring shall be with type XHHW insulated 600 volt stranded wire. The minimum wire size shall be No. 12 AWG.

## SYSTEM VOLTAGES

Service Voltage: All stations shall have 120/240V or 120/208V power supply. Please see Electrical Systems Design section for detail.

**Table 5.1**

### Utilization Voltages:

Type	Voltage
Lighting Fluorescent	120V 1 Phase
Lighting (Sodium/Metal Halide)	120V 1 Phase
Incandescent	120V 1 Phase
Fare Collection Equipment	120V 1 Phase
Communication and Cable TV	120V 1 Phase
Other loads	Use applicable voltage

Where single-phase power is taken from a 3-phase source, the loads shall be balanced among the three distribution phases.

## SYSTEM CAPACITY

Station power systems shall be structured from a single power distribution panel. The power distribution panel shall be of sufficient capacity to power all station loads plus a spare capacity of 20%.

## DEMAND FACTORS

In calculating system capacity, the following demand factors shall apply:

**Table 5.2**

### Demand Factors

Element	Demand Factor
Element	Demand Factor
Lighting (normal)	1.0
Incandescent	1.0
Fare Collection Equipment	1.0
Communication and Cable TV	1.0
Others:	Varies with duty cycle and NEC requirements

## **STATION LIGHTING**

### **PERFORMANCE STANDARDS**

Illumination Engineering Society Lighting Handbook

Underwriters Laboratories, Inc.

### **STANDARD ELEMENTS**

All luminaires and lamp types shall be standardized system wide to provide design and perceptual unity and simplify maintenance requirements. Refer to RTD's Bus Transit Facility Design Criteria for standard lighting elements.

### **ILLUMINATION LEVELS**

Illumination levels shall define and differentiate between task areas, decision and transition points, and areas of potential hazard. In addition to quantity of light, it is essential that illumination be designed to minimize glare and provide uniform distribution. Luminaires shall be selected, located, and/or aimed to accomplish their primary purpose while producing a minimum of objectionable glare and/or interference with task accuracy, vehicular traffic, and neighboring areas. All illumination levels shall be designed to meet the local approving authority requirements.

Minimum illumination levels are shown below:

**Table 5.3**

#### **Minimum Illumination Levels**

<b>Exterior Location</b>	<b>Minimum Foot-candles</b>
Station Platforms & Plaza Areas	5 minimum
Fare Vending Area	8 minimum
Pedestrian Tunnels & Pedestrian access ways	5 minimum
Parking Lots & Vehicle Access ways	2 average

### **STATION SITE LIGHTING**

Station lighting includes internal site circulation and access to the station. The placement of luminaires shall not obstruct the movement of vehicles. Luminary placement shall be coordinated with the landscape and site plan to protect light standards which are located adjacent to roadways, and to ensure that plantings will not obscure the lighting distribution pattern.

## **VEHICULAR ACCESS LIGHTING**

Vehicular access lighting shall provide a natural lead-in to the bus area and Kiss and Rides. The illumination on all access and egress roads shall be graduated up or down to the illumination level of the adjacent street or highway.

## **PEDESTRIAN ACCESS LIGHTING**

Pedestrian access lighting shall define pedestrian walkways, crosswalks, ramps, stairs and bridges.

## **PLATFORM LIGHTING**

Platform area lighting shall be in waiting and loading areas. The lighting elements shall extend the entire length of the platform and shall demarcate the platform and emphasize the platform edge, vertical vehicle surfaces. Care shall be taken to avoid "blinding" CR operators or other vehicle drivers with excessive or misdirected lighting.

## **CONTROL OF LIGHTING SYSTEMS**

Lighting control shall be designed to use energy efficiently. Automatic control arrangements shall ensure efficient utilization of energy and maintenance procedures. All exterior site areas shall be illuminated by fixtures that are controlled by a photocell integrated with a time clock for control of separate circuits after operational hours and before early morning start-up.

## **5.9 FARE COLLECTION SYSTEM**

### **5.9.1 GENERAL**

The Fare Collection System shall consist of Ticket Vending Machines (TVMs), a Central Data Collection & Information System (CDCIS), Smart Media Technology (SMT) System, Stand Alone Validators (SAVs), spare parts, special tools, test equipment, documentation, training, technical assistance and warranty as part of the System. The TVMs, SMTs and SAVs shall be designed for outdoor installation in an un-sheltered environment, including precipitation, sun glare, heat and solar loading. Any equipment supplied and/or installed, that is not housed in an environmentally controlled enclosure shall be rated to operate in the environmental conditions of the Denver Metro area.

It is required that the TVMs, SMTs and SAVs (Fare Collection Equipment) shall be service proven. The System shall be of materials that are new and free of defects and which conform to the requirements of the Technical Specification.

## **5.9.2 AUTOMATED FARE COLLECTION**

All platforms shall have provisions for free-standing TVMs, SMTs and SAVs.

RTD shall determine the number of initial machines and future provisions.

Weather protection should be provided and coordinated with RTD for each machine unless otherwise approved by RTD.

All TVMs & SMTs shall be protected from direct sunlight onto the screen.

## **5.9.3 TICKET VENDING MACHINES**

In general, TVMs shall be designed to sell tickets and passes to RTD's customers by coins, bills or credit/debit cards. TVMs shall be capable of printing and issuing different tickets, passes, mag cards, smart cards, RFID cards or combination thereof from within the same housing. The design of the TVMs shall be based on simple, clear and reliable construction, and modular components to make them easy to use and maintain.

Each TVM shall be equipped to:

Accept U.S. nickel (\$.05), dime (\$.10), quarter (\$.25), and post-1978 dollar (\$1.00) coins; RTD 0.0650 Token; U.S. one dollar, five dollar, ten dollar, twenty dollar, fifty dollar bills, credit/debit cards as payment;

Provide change in the fewest number of coins as required;

Respond to customer's choice of action;

Issue tickets and passes;

Register the number of media of each type and price range issued and total value of fare media sold;

Indicate malfunctions of the unit; and

Include complete on-line TVM, SMT & SAV network capability with remote status monitoring, automatic polling for sales information, a complete audit and accounting system, ability to remotely command the Fare Collection equipment to reset and self-diagnose, ability to remotely modify operating parameters such as fare tables and ticket print layouts, and process all credit/debit card authorizations.

## **5.9.4 MODULARITY**

Each TVM shall be a self-contained machine, complete with its own cabinet and mounting stand or base, and having integral light fixtures to illuminate the control face. Each TVM shall consist of a bill processing unit, coin processing unit, credit card processing unit (optional), debit card PIN pad (optional), display and information unit, change maker, ticket and pass issuing unit, key

pad and function keys, power supply, and processing and control unit, all located within a self-contained unit. Each of the basic functions within the machine shall be performed by modular components which readily permit field replacement of inoperative modules to return the machine to service in minimal time. Control and power connections shall be made via plug-in connections. Modules shall not be directly hard wired together and/or into the TVMs. The individual module shall be fixed in the unitized frame with fast latching devices and be secured by locks against unauthorized removal, where required.

#### **5.9.5 CODE REQUIREMENTS**

TVMs shall be designed to comply with all applicable local or national design codes, ordinances, and standards existing at the time of procurement. Listed below are the principal applicable codes:

National Electric Safety Code, American National Standard C2, latest edition

National Electric Code, National Fire Protection Association ANSI/NFPA 70, latest edition

Americans with Disabilities Act Accessibility Guidelines for Buildings and Facilities (ADAAG), latest edition

Underwriters Laboratories UL-751, "Vending Machines," latest edition

International Electrotechnical Commission standard 529 (IEC529)

#### **5.9.6 DESIGN LIFE**

The Fare Collection System shall be designed for a minimum service life of 10 years of normal operation in the Denver metropolitan area. All equipment shall be designed to operate seven days per week, twenty-four hours per day.

#### **5.9.7 OPERATING ENVIRONMENT REQUIREMENTS**

The Fare Collection System shall be capable of operating without shelter over an ambient temperature range of -15°F to 110°F. In the summer, direct sunlight conditions will cause cabinet temperature to rise considerably above ambient, in excess of 155°F. All equipment shall be capable of operating in relative humidity from 20% to 90% over the ambient temperature range given above. This shall include periods of condensation and wind-driven rain, freezing rain and snow. Equipment enclosures shall comply with International Electrotechnical Commission standard 529 (IEC529) level IP34 or equivalent.



## **5.9.8 ELECTRICAL**

The Fare Collection System shall be designed to accept standard 3-wire, 115 volt, single phase, 60 Hz power. Each TVM shall be powered by a separate 30-amp circuit protected by circuit breaker. In addition, each TVM shall provide its own circuit protection. Each SMT/SAV shall be powered by a separate 20-amp circuit protected by circuit breaker.

All equipment shall be designed to tolerate 10% fluctuation in line voltage without any damage or service interruption. Breaks in the voltage (below 10% of the source voltage) or supply interruptions shall cause an orderly shutdown of the Equipment.

Voltage transient suppression shall be provided where necessary. The Fare Collection System shall include a protection system capable of withstanding transients of 3.0 kV peak pulse with a total energy of 1000 joules without damage, improper operation or shutdown. The functional status of any such surge and transient suppressor circuitry must be visible at all times when the outer door is open.

## **5.9.9 PASSENGER ACCESS**

All functional controls, coin slots, bill slots, credit card slots, smart card readers, ticket slots and ticket and coin return bins shall be compliant with current Americans with Disabilities Act Accessibility Guidelines for Buildings and Facilities (ADAAG).

The TVM display shall use dark characters on a light background. Characters shall be at least 0.75 inches tall and be of sufficient contrast to make them easily readable in all ambient light conditions, including total darkness and direct sunlight. The TVM display shall utilize technology suitable for the environment and shall provide a viewing angle of least 45° from perpendicular in all directions. High-contrast raised lettering at least 0.625 inches high shall be used to label all controls, pushbuttons, coin and bill slots, and the ticket/coin return bin. All such labels shall also utilize standard Braille characters.

The TVM shall, on demand of the patron, provide audible voice instructions. The voice system shall utilize either stored human speech or synthesized speech using AT&T Natural Voices Software or approved equal. The messages shall be stored in digital form for operation and be modifiable by RTD. Context-sensitive voice messages shall provide, in audio form, the information shown on the TVM display or otherwise conveyed by the TVM. RTD will have final say in how the TVM looks and operates.

### **5.9.10 CONSTRUCTION/EQUIPMENT ENCLOSURE**

The Fare Collection System shall be designed to operate in unsheltered locations.

The overall dimension of an installed TVM shall not exceed 80 inches (height) by 38 inches (width) by 25 inches (depth). The equipment enclosure for the TVMs shall be of stainless steel with an unpainted random-orbital finish. The cabinet shall have a leveling base which shall accommodate the station platform surface slope. Mounting shall be by means of stainless steel bolts imbedded in concrete.

Frames shall be provided for graphic panels on the front of the TVM as required for explaining the operation of the TVM. The top of the TVM shall slant at least 5° downward and to the rear of the TVM to prevent any accumulation of rain. The interior of the equipment shall be designed to allow easy and safe access to service equipment and sub-assemblies.

### **5.9.11 MAINTAINABILITY AND ACCESSIBILITY**

In the design of The Fare Collection System, greatest emphasis shall be put on reliable operation of all components and equipment over their economic life, and to the minimization and simplification of scheduled and unscheduled maintenance tasks.

Equipment shall be modular in design to permit rapid field replacement of malfunctioning modules.

These units shall combine the advantages of relatively simple mounting and accessibility for maintenance. Adequate space shall be available to fit keys; to grasp, lift and turn internal components; and to remove and replace units, components, connections, and ticket stock. The weight of the units that must be lifted during servicing, except coin and bill vaults, and coin storage units when full, shall not exceed 37 pounds. Guide rails shall be provided to facilitate the removal of the modules. Adequate space for the use of tools shall be available as required. For ease of service, all electrical connections between components and sub-assemblies shall be established by means of coupling to allow rapid removal of a component and/or sub-assembly from the equipment.

### **5.9.12 SAFETY**

The interior of the equipment shall be similarly free of sharp edges or other hazards that may cause injury to maintenance personnel. Particular attention shall be given to protecting blind persons who may explore the exterior surface with their fingers.

The exterior panels and control shall be grounded to prevent electrical leakage or static charge.

### **5.9.13 SECURITY**

Access to the interior of the equipment enclosures and to the cash vaults shall be restricted on a "need to gain access" basis as approved by RTD.

The arrangement of modular mechanical and electrical components and money containers shall be such that normal maintenance, including change-out of defective modules, shall neither require removal of, nor access into, the coin and bill containers.

TVM location shall be coordinated with CCTV camera angles to ensure the TVM is viewed by a camera.

### **5.9.14 AESTHETIC REQUIREMENTS**

The Fare Collection System shall be designed with all controls and customer interface display and inputs on a common front face of the enclosure. Suitable graphics shall be provided explaining the operation of the equipment.

### **5.9.15 PROTECTION AGAINST VANDALISM AND BURGLARY**

For protecting against vandalism and burglary for each TVM, the following requirements shall be met:

All latches shall be secure and robust

All external screws and hinges must be covered

Security locks with profile catches must be used

Locks must be drill resistant, mounted flush with the outside surface of the door

The door must be locked with at least a three-point latching device with a bascule bolt and hook bar, or equivalent tools

Overlapping doors must be constructed with a joining gap equal to or less than 2 mm

Reinforcement must be provided at positions where there is danger of burglary

The display screen must be protected by a fixed, transparent shield

Each TVM shall be equipped with a signaling and alarm system. TVMs shall be capable of surviving a kick or punch from a large adult acting in an irrational manner (acceleration pulses of 5 gravities peak value with approximate duration of 10 milliseconds along each of three mutually perpendicular axes) while the equipment is operating.

The signaling and alarm system shall be equipped with an electronic or mechanical siren capable of emitting a sound level of at least 110 dB(A) measured at a distance of three feet with the door open. This siren shall sound whenever unauthorized entry is detected or when severe impacts to the front door are detected.

An internal momentary contact switch, hidden inside the TVM but readily accessible, shall permit an authorized technician to trigger a “silent” alarm. When activated, this switch shall cause the TVM to notify the central computer system and/or SCADA, but not activate the siren.

#### **5.9.16 CENTRAL DATA SYSTEM**

The Fare Collection System shall communicate over the most efficient communications medium available to a centrally located data system. The equipment shall report status, events, alarms, and other information when necessary. All equipment shall also be able to receive information from the central computer to update fare structures, ticket print layouts, patron display information, operating parameters, and to be remotely commanded to perform certain diagnostic exercises.

While the central data system will be installed in the revenue shops, remote workstations shall provide users access to the data for queries, report generation and status information.

One or more such workstations shall be at the maintenance facility.

##### **5.9.16.1 Data Networking**

Data communications shall be provided in a hierarchical network, with a central control computer at the top level, an Ethernet switch at the middle level, and the TVMs at the lowest level.

All Fare Collection System shall be networked back to the central computer via Ethernet. RTD will make available one 10/100 Mbps Ethernet port at each station for communications over RTD’s IP-based network between the station and the revenue shop.

Ethernet switches, cabling and connectors shall be provided by the Contractor to communicate between the equipment and the RTD provided communications network. An SNMP capable managed Ethernet switch shall be provided at the station with enough ports to accommodate twice the original number of Fare Collection Equipment installed.

All outdoor cabling shall be suitable for outdoor/wet installations. For cable runs greater than 75 meters fiber optic cabling and transceivers (suitable for the environmental conditions it is installed in) shall be provided. For shorter distances CAT 5 or 5e cabling is sufficient.

Five RU of rack space will be provided by RTD in the communications room for installation of the fare collection communications equipment.

#### **5.9.16.2 Central Computer**

The central computer shall be an IBM-compatible PC, suitably configured for the intended application. The computer shall be of a dual-server architecture, with the second server in a "hot" spare configuration.

To facilitate reduced maintenance costs the central computer shall be of the same manufacturer as used by RTD's corporate IT group.

#### **5.9.16.3 Application Software**

Application software shall permit the computer to simultaneously communicate with several stations, two or more users (on remote computers), and up to two financial clearing houses for credit/debit card authorizations should such an option be exercised. Application software shall utilize menu or icon-driven user interfaces. All access to application software shall be under strict password control.

#### **5.9.16.4 Database Software**

All transaction, event, sales, accounting, maintenance and other records shall be maintained in a commercially available relational database manager such as Ingress, Informix or Oracle. The database manager software shall be of the most recent version available at the time the system enters factory system testing.

#### **5.9.16.5 Report Generation**

The central computer system shall generate reports that shall enable RTD to analyze the fare collection system, revenues, trends, maintenance activities, security status and so on. All reports shall be available on demand, spanning any range of data stored (such as by date, station, TVM, ticket type, event type, etc.). Based on user selection, the computer system shall also generate reports automatically at programmed intervals (such as daily, weekly, monthly and quarterly).

In addition to those reports to be provided with the system, the computer system shall enable RTD to customize existing reports and create new reports using Structured Query Language (SQL) commands available from the relational database manager.

All reports shall be available locally on the computer screen, printed to any available printer, or on any other workstation networked to the central computer.

The system shall also provide line graphs, bar charts, pie charts and other common data presentation methods to represent summarized data.

#### **5.9.16.6 System Status and Security Monitoring**

The central computer system shall receive status information from the TVMs, SMTs & SAVs. All event information shall be stored on the central computer and depending on the priority of the event, displayed on the central computer screen.

Alarm information, such as intrusion alarms, out of service conditions and other high priority events shall be displayed without delay regardless of other activities in progress on the computer system.

The central computer shall also periodically poll all stations for status, to insure that all station network interfaces (master TVM or station computer) are functioning properly.

The central control computer system shall maintain a current understanding of the complete system status and permit authorized workstation operators to view the status of all equipment by station and by individual component.

The abilities to place an individual TVM in service and out of service, command a TVM to perform self-diagnostics, and reset the TVM shall also be provided from the central computer system.

The central computer system shall also monitor the status of connections to the clearinghouses for credit/debit card authorizations should such an option be exercised. In the event that all communication with the clearing house(s) is lost, the central computer shall inform the TVMs that credit card transactions are temporarily unavailable, and the TVMs shall act accordingly. Upon restoration of communication with the clearing house(s), the central computer shall so inform the TVMs.

#### **5.9.16.7 Configuration Management**

All configuration parameters of the Fare Collection Equipment shall be alterable remotely from the central computer system, including date and time, fare tables, security access codes, ticket printing formats, passenger display messages, in-service/out-of-service times, accepted types of credit/debit cards, etc.

### **5.9.17 SCADA INTERFACE**

The TVMs shall report simple status and alarms conditions to RTD's SCADA system via dry contacts. The conditions and the responses are:

TVM Intrusion Alarm (unauthorized entry) & (impact sensor activated)

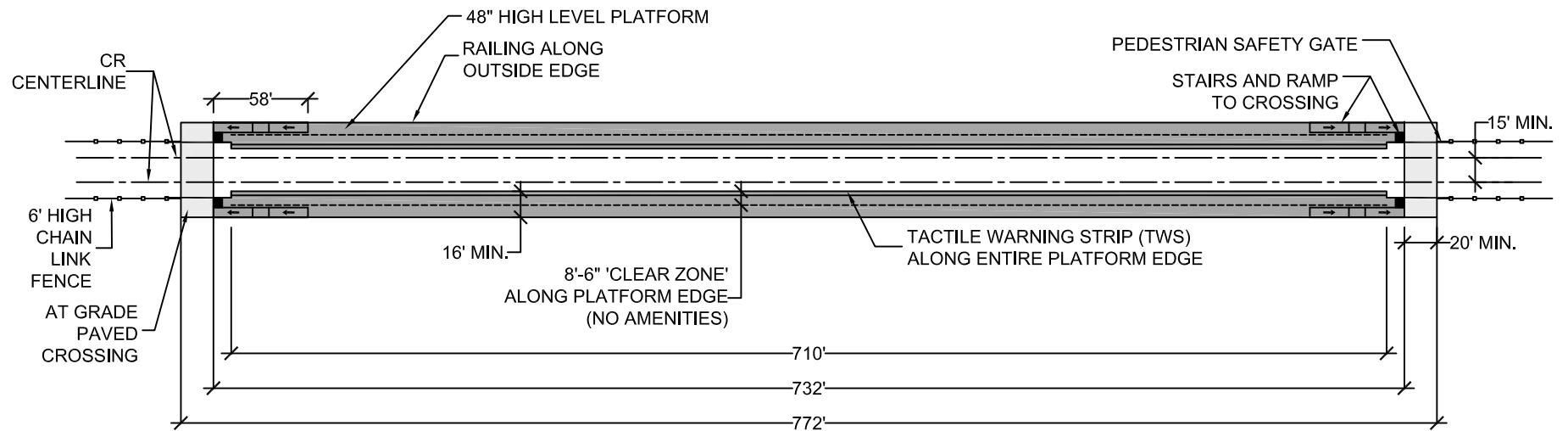
TVM/SMT/SAV Maintenance Alarm (inclusive of all maintenance alarms)

TVM Revenue Service Alarm (inclusive of all revenue service)

Silent Alarm. Activated (opened) whenever the silent alarm is initiated

The SCADA circuits shall be wired to the TVM relays so that any cable fault (such as intentional cutting the wire, forcible removal of the TVM or just a simple break in the cable) would be detected as an alarm. The TVM/SMT/SAV Maintenance Alarm should also be constantly powered (in the closed position) so that any loss of power will open the relay and trigger the alarm. In cases where there are multiple TVMs at a station, one TVM shall be designated as the Master TVM. The other TVMs shall have their SCADA contacts terminated in the Master TVM. The Master TVM will report to the SCADA system one master alarm per location.

**END OF SECTION**



	OVERALL LENGTH	MINIMUM PLATFORM WIDTH	MINIMUM ROW WIDTH
6 CAR	602'	16'	58'-2"
5 CAR	517'	16'	58'-2"
4 CAR	432'	16'	58'-2"

NOTES:

1. SITE AMENITIES NOT SHOWN FOR CLARITY.
2. TACTILE WARNING STRIP (TWS) ALONG ENTIRE PLATFORM EDGE.
3. RAILING ALONG OUTSIDE EDGE.
4. ALL PLATFORMS SHALL MEET ADA AND NFPA REQUIREMENTS.



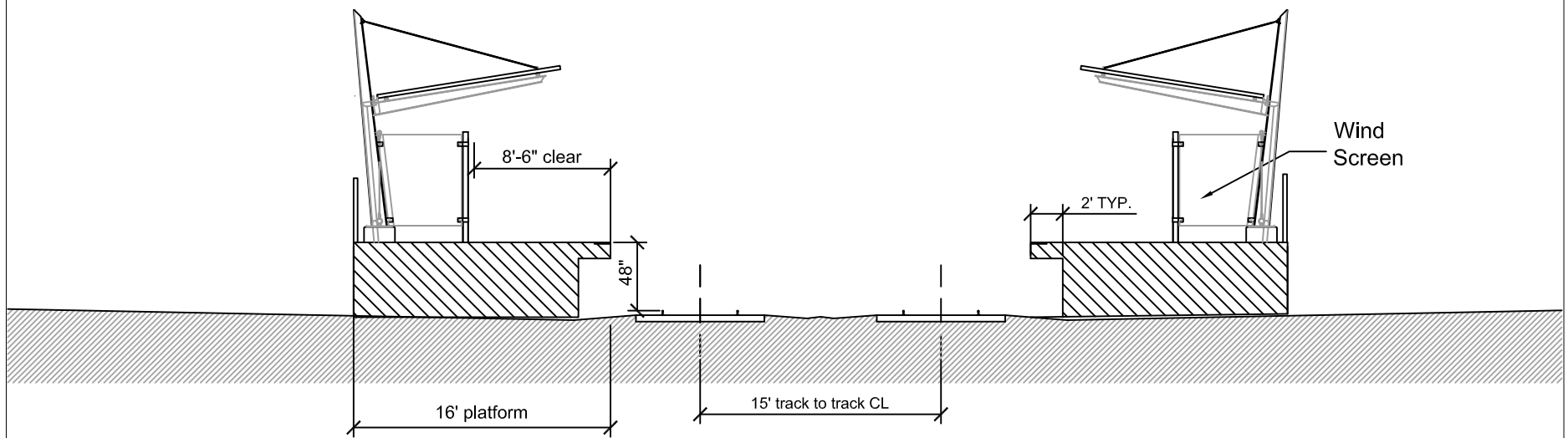
REGIONAL TRANSPORTATION DISTRICT  
1600 BLAKE STREET  
DENVER, COLORADO 80202  
(303) 628-9000

## COMMUTER RAIL DESIGN CRITERIA

TITLE: TYPICAL COMMUTER RAIL PLATFORM  
8 CAR: SIDE-SIDE CONFIGURATION N.T.S  
16' MINIMUM PLATFORM WIDTH

FIGURE: 5-1



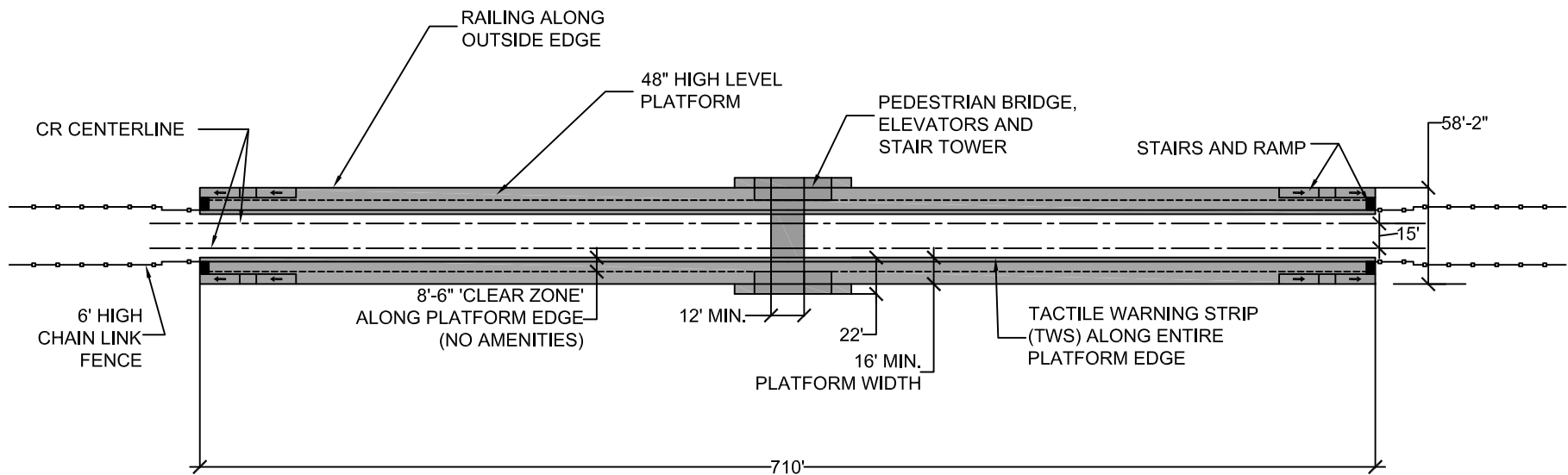


REGIONAL TRANSPORTATION DISTRICT  
 1600 BLAKE STREET  
 DENVER, COLORADO 80202  
 (303) 628-9000

## COMMUTER RAIL DESIGN CRITERIA

TITLE: COMMUTER RAIL SIDE LOADED PLATFORM  
 PLATFORM WIDTH - 16'-0". AT GRADE  
 CROSSINGS @ END OF PLATFORM

FIGURE: 5-2



NOTES:

1. SITE AMENITIES NOT SHOWN FOR CLARITY.
2. TACTILE WARNING STRIP (TWS) ALONG ENTIRE PLATFORM EDGE.
3. RAILING ALONG OUTSIDE EDGE.
4. ALL PLATFORMS SHALL MEET ADA AND NFPA REQUIREMENTS.

	OVERALL LENGTH	MINIMUM PLATFORM WIDTH	MINIMUM ROW WIDTH*
6 CAR	562'	16' W/22'@ELEVATOR	58'-2"
5 CAR	472'	16' W/22'@ELEVATOR	58'-2"
4 CAR	392	16' W/22'@ELEVATOR	58'-2"

\*70'-2" AT ELEVATORS/BRIDGE.

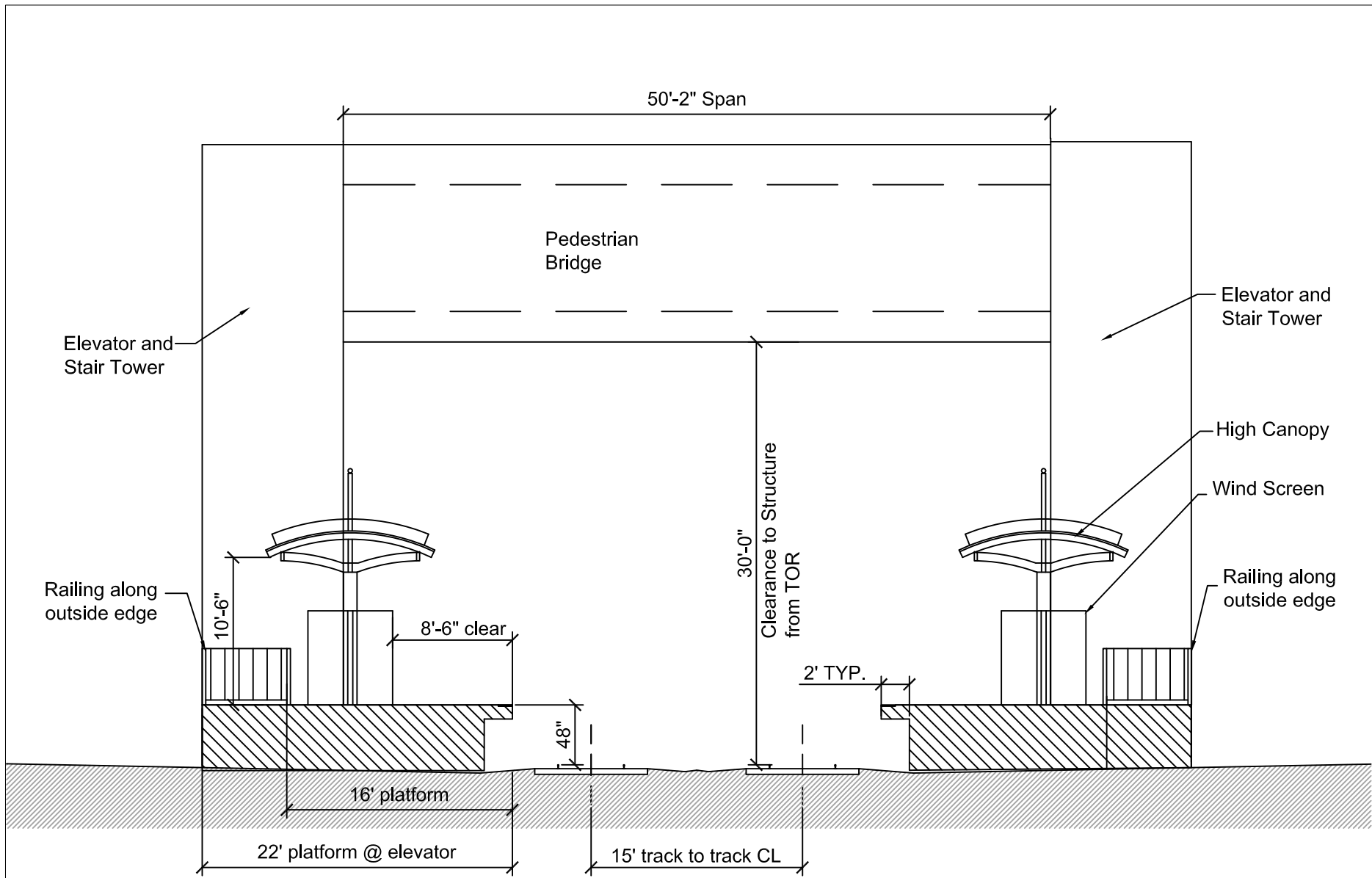


REGIONAL TRANSPORTATION DISTRICT  
1600 BLAKE STREET  
DENVER, COLORADO 80202  
(303) 628-9000

## COMMUTER RAIL DESIGN CRITERIA

TITLE: TYPICAL COMMUTER RAIL GRADE  
SEPERATED CROSSING PLATFORM - N.T.S.  
8 CAR: SIDE-SIDE CONFIGURATION

FIGURE: 5-3

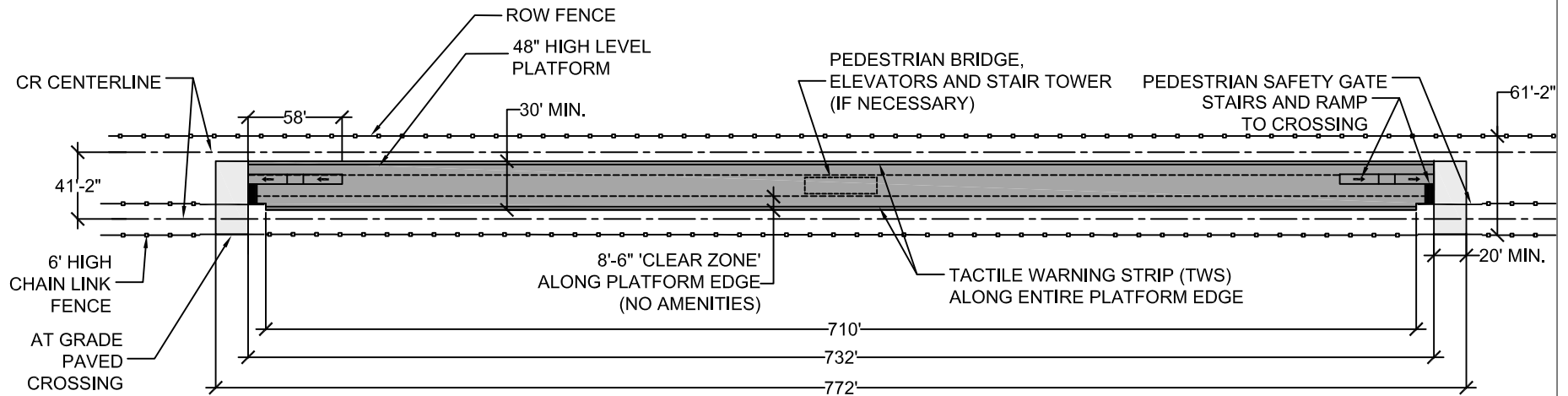


REGIONAL TRANSPORTATION DISTRICT  
 1600 BLAKE STREET  
 DENVER, COLORADO 80202  
 (303) 628-9000

## COMMUTER RAIL DESIGN CRITERIA

TITLE: COMMUTER RAIL SIDE LOADED PLATFORM  
 PLATFORM WIDTH - 22'-0". VERTICAL  
 CIRCULATION IN CENTER OF PLATFORM

FIGURE: 5-4



	OVERALL LENGTH	MINIMUM PLATFORM WIDTH	MINIMUM ROW WIDTH
6 CAR	602'	30'	61'-2"
5 CAR	517'	30'	61'-2"
4 CAR	432'	30'	61'-2"

NOTES:

1. SITE AMENITIES NOT SHOWN FOR CLARITY.
2. TACTILE WARNING STRIP (TWS) ALONG ENTIRE PLATFORM EDGE.
3. ALL PLATFORMS SHALL MEET ADA AND NFPA REQUIREMENTS.

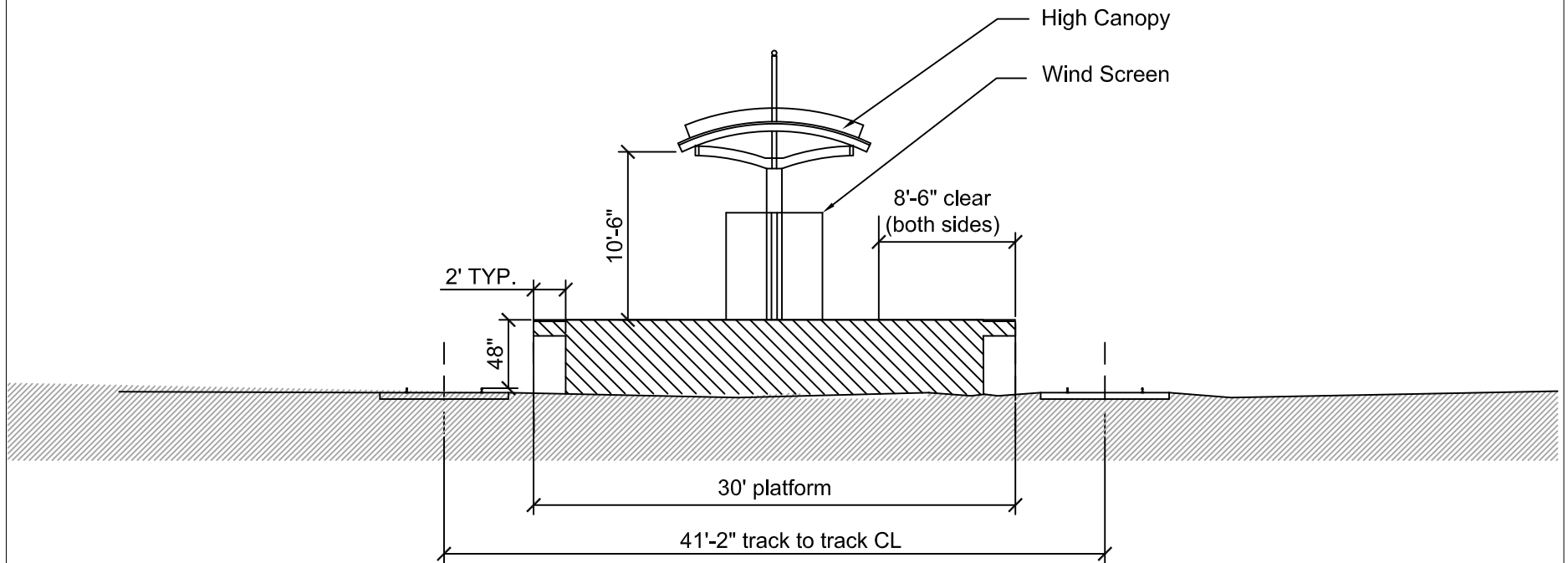


REGIONAL TRANSPORTATION DISTRICT  
1600 BLAKE STREET  
DENVER, COLORADO 80202  
(303) 628-9000

## COMMUTER RAIL DESIGN CRITERIA

TITLE: TYPICAL COMMUTER RAIL PLATFORM  
8 CAR: CENTER CONFIGURATION - N.T.S.  
30' PLATFORM WIDTHS

FIGURE: 5-5

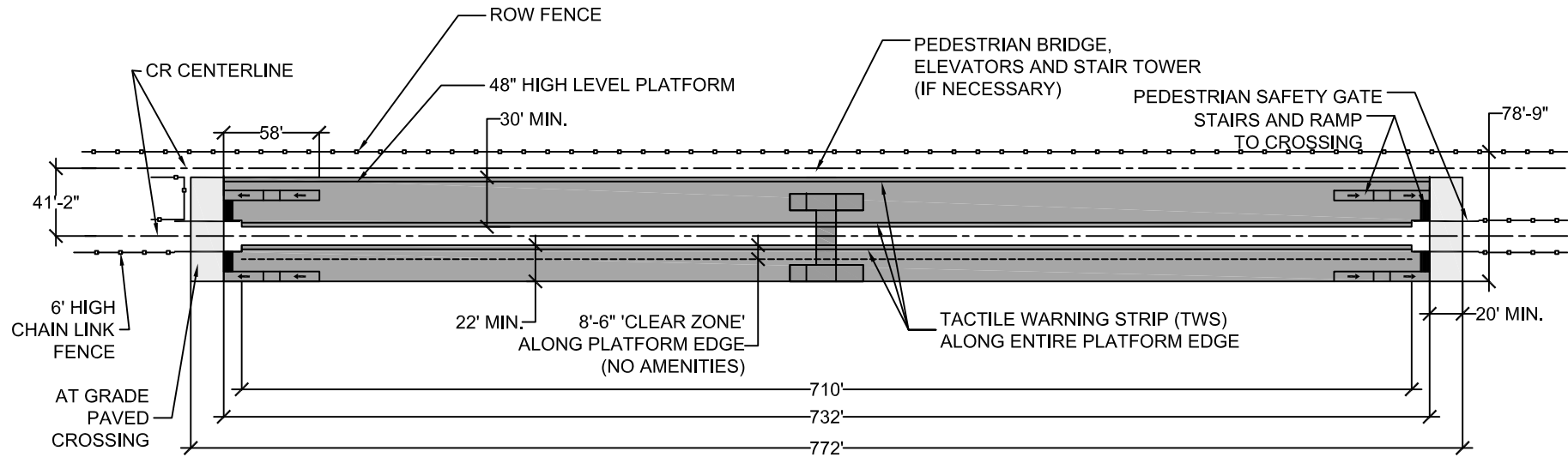


REGIONAL TRANSPORTATION DISTRICT  
 1600 BLAKE STREET  
 DENVER, COLORADO 80202  
 (303) 628-9000

## COMMUTER RAIL DESIGN CRITERIA

TITLE: COMMUTER RAIL  
 CENTER LOADED PLATFORM  
 PLATFORM WIDTH - 30'

FIGURE: 5-6



	OVERALL LENGTH	MINIMUM PLATFORM WIDTH	MINIMUM ROW WIDTH
6 CAR	602'	30' & 22' W/ELEVATOR	78'-9"
5 CAR	517'	30' & 22' W/ELEVATOR	78'-9"
4 CAR	432'	30' & 22' W/ELEVATOR	78'-9"

**NOTES:**

1. SITE AMENITIES NOT SHOWN FOR CLARITY.
2. TACTILE WARNING STRIP (TWS) ALONG ENTIRE PLATFORM EDGE.
3. RAILING ALONG OUTSIDE EDGE.
4. ALL PLATFORMS SHALL MEET ADA AND NFPA REQUIREMENTS.

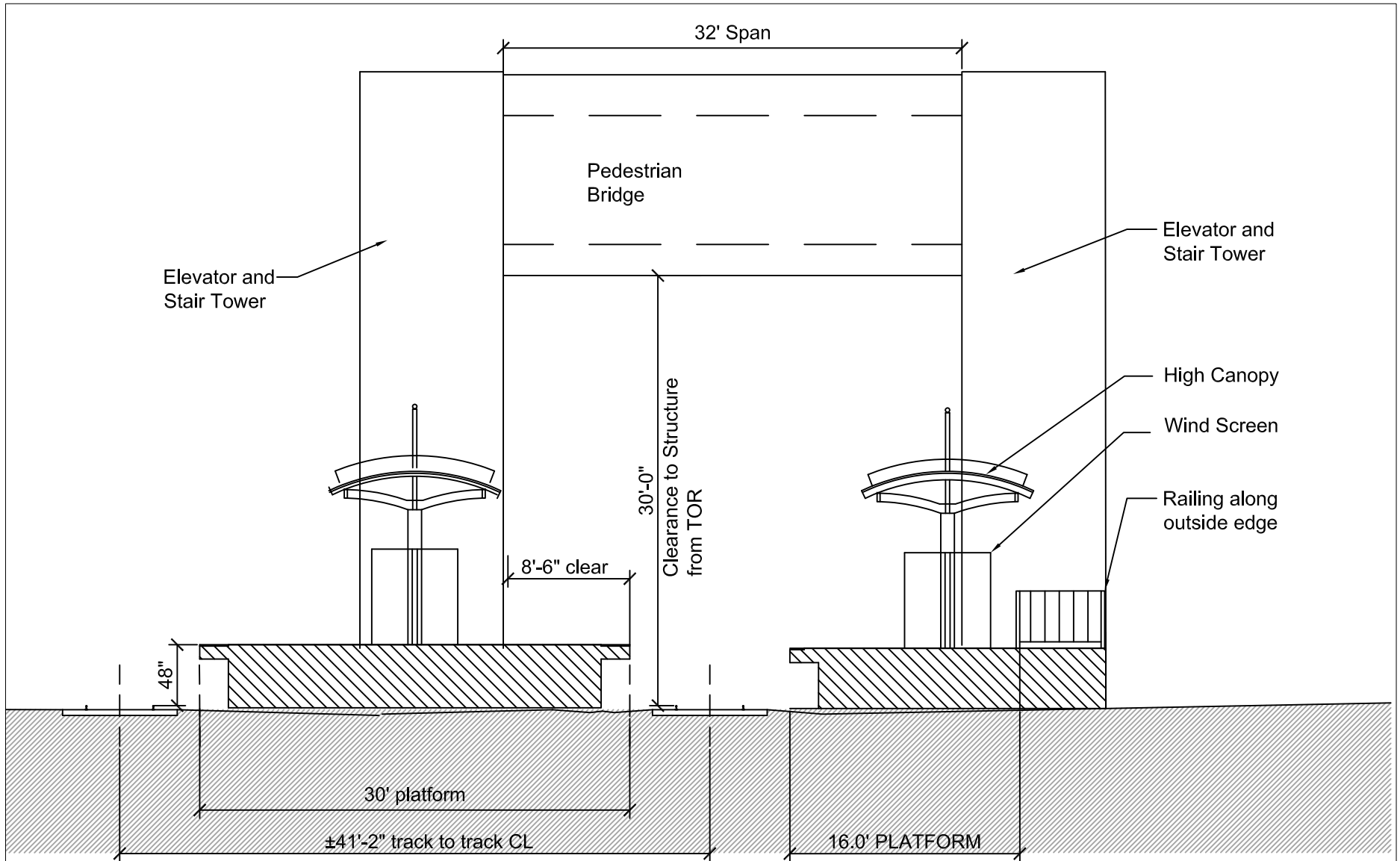


REGIONAL TRANSPORTATION DISTRICT  
1600 BLAKE STREET  
DENVER, COLORADO 80202  
(303) 628-9000

## COMMUTER RAIL DESIGN CRITERIA

TITLE: TYPICAL COMMUTER RAIL GRADE SEPERATED  
CROSSING PLATFORM - N.T.S.; 8 CAR SIDE-  
CENTER CONFIGURATION; 22'-30' PLATFORM WIDTHS

FIGURE: 5-7



REGIONAL TRANSPORTATION DISTRICT  
 1600 BLAKE STREET  
 DENVER, COLORADO 80202  
 (303) 628-9000

## COMMUTER RAIL DESIGN CRITERIA

TITLE: COMMUTER RAIL SIDE/CENTER LOADED  
 PLATFORM. PLATFORM WIDTH VARIES  
 VERTICAL CIRCULATION

FIGURE: 5-8

**TABLE OF CONTENTS**  
**SECTION 6 – BRIDGES & STRUCTURES**

6.1	GENERAL.....	3
6.2	STRUCTURE TYPES.....	3
6.3	DESIGN METHODS.....	3
6.3.1	Commuter Rail and Freight Rail Structures.....	3
6.3.2	Highway and Pedestrian Structures.....	4
6.4	LOADING.....	4
6.4.1	Dead Load.....	4
6.4.2	Live Load.....	4
6.4.3	Direct Fixation.....	4
6.4.4	Derailment Load.....	5
6.5	CLEARANCES.....	5
6.6	GEOTECHNICAL SUBSURFACE INVESTIGATION.....	6
6.7	EARTH RETAINING STRUCTURES.....	6
6.7.1	Geometry.....	6
6.7.2	Wall Types.....	6
6.7.3	Design Requirements.....	6
6.7.4	Characteristics.....	7
6.8	BRIDGES.....	8
6.8.1	Geometry.....	8
6.8.2	Inspection Access.....	8
6.8.3	Protection Fencing.....	9
6.8.4	Approach Slabs.....	9
6.8.5	Bridge Decks.....	9
6.8.6	Deck Joints.....	9
6.8.7	Bearings.....	10
6.8.8	Drainage.....	10
6.8.9	Protective Angles.....	10
6.8.10	Pier/Abutment Protection.....	10
6.9	WATERPROOFING AND DAMPPROOFING.....	10
6.10	STRAY CURRENT CONTROL.....	11
6.11	TEMPORARY STRUCTURES.....	12
6.12	CATENARY POLE FOUNDATIONS.....	12



## **LIST OF FIGURES**

- 6-1 CRT Loading Diagram – Corridor Vehicle (DMU)
- 6-2 CRT Loading Diagram – Corridor Vehicle (EMU)
- 6-3 Typical Depressed Section with One Adjacent Wall – Tangent Track
- 6-4 Typical Retaining Wall Approach – Tangent Track
- 6-5 Tunnel Section – Tangent Track (Long Tunnel >400')
- 6-6 Ballasted Deck Bridge – Tangent Track
- 6-7 Direct Fixation Deck Bridge – Tangent Track
- 6-8 Ballasted Deck Dual Track Bridge – Tangent Track
- 6-9 Direct Fixation Deck Dual Track Bridge – Tangent Track
- 6-10 Short Span Slab Girder Bridge With Steel Pile Bent – Tangent Track

## **SECTION 6 BRIDGES & STRUCTURES**

### **6.1 GENERAL**

The design and construction of Commuter Rail bridges and associated structures shall be in accordance with AREMA Manual for Railway Engineering, RTD Commuter Rail Design Criteria, and CDOT Bridge Design Manual. If RTD is operating on the ROW, or partially on the ROW, of either the BNSF Railway (BNSF) or Union Pacific Railroad (UPRR), the design and construction shall also be in accordance with BNSF/UPRR Guidelines for Railroad Grade Separation Projects.

The design and construction of freight rail bridges and associated structures shall be in accordance with AREMA Manual for Railway Engineering, BNSF/UPRR Guidelines for Railroad Grade Separation Projects, and CDOT Bridge Design Manual.

The design and construction of highway bridges, pedestrian bridges and associated structures shall be in accordance with AASHTO LRFD Bridge Design Specifications, CDOT Bridge Design Manual, BNSF/UPRR Guidelines for Railroad Grade Separation Projects, and RTD Commuter Rail Design Criteria. The vibration criteria for pedestrian bridges shall be in accordance with AASHTO Guide Specifications for Design of Pedestrian Bridges.

Where the requirements of the design documents are in conflict, the stricter shall apply unless otherwise approved by RTD.

### **6.2 STRUCTURE TYPES**

Structure types will be restricted to those historically used by RTD or those that have been accepted for general use by other transportation authorities and can be demonstrated that the design of the structure types and components will perform well for the intent of the project and under the project's environmental conditions, including frequent freeze-thaw cycles. Experimental structure types, timber bridges, masonry bridges and structural plate arches are not permitted. RTD reserves the right to reject the use of non-historic structure types proposed.

### **6.3 DESIGN METHODS**

#### **6.3.1 Commuter Rail and Freight Rail Structures**

- Concrete Structures – Load Factor Design Method
- Prestressed Concrete Structures – Service Load Design Method with check for Ultimate Strength
- Steel Structures – Service Load Design Method
- Abutments and Piers – Load Factor Design Method
- Foundations – Service Load Design Method

### 6.3.2 Highway and Pedestrian Structures

- Load and Resistance Factor Design Method

## 6.4 LOADING

Bridge structures shall be designed for all loads specified in the AREMA Manual or AASHTO Specifications and as modified by the appropriate RTD and railroad guidelines.

### 6.4.1 Dead Load

Track, rails, inside guard rails and fastenings	200 lbs per lineal foot
Ballast, including track ties	120 lbs per cubic foot
Timber	5 lbs per foot board measure
Reinforced concrete	150 lbs per cubic foot
Earth filling materials	120 lbs per cubic foot
Waterproofing and protective covering	Estimated weight
Catenary System	per catenary designer
Future Utilities	5 lbs per square foot/deck

### 6.4.2 Live Load

Commuter rail vehicle loading shall be as shown in Figure 6.1 and 6.2, or as recommended by vehicle manufacturers and accepted by RTD. A train shall consist of up to eight cars.

All structures carrying freight railroad loading shall be designed for AREMA Cooper E80 with other live loads and loading group combinations applied as specified in Chapter 8 and 15 of AREMA. On dedicated ROW for RTD Commuter Rail trains, AREMA Cooper E80 loading will be ignored.

For highway and pedestrian structures, AASHTO LRFD and CDOT Bridge Design Manual live load requirements shall be used.

### 6.4.3 Direct Fixation

For direct fixation bridges, analyses or justifications shall be performed to determine the design parameters such as live load distribution factor, impact factor, and forces due to temperature variations in the rail.

#### **6.4.4 Derailment Load**

##### Vertical

Vertical Derailment Load shall be produced by two to three vehicles placed with their longitudinal axis parallel to the track.

Lateral vehicle excursion shall vary from 4 inches minimum to 36 inches maximum for tangent track and curved track with radius greater than 5000 ft. For track with smaller radii, the maximum excursion shall be adjusted so that the derailed wheel flange is located 8 inches from the rail traffic face of the nearest barrier, if any, or the edge of deck. In any case, for tracks protected by guardrails, the maximum excursion shall be limited to that allowed by the placement of the guardrails.

A vertical impact factor of 100% of vehicle weight shall be applied in computing the equivalent static derailment load. The derailment impact shall be applied to any two adjacent axles (within a single truck assembly) at a time, and the normal vertical impact factor shall be used for all other axles, which produces the critical loading condition for the structure.

When checking any component of superstructure or substructure, which supports two or more tracks, only one train on one track shall be considered to have derailed, with one other track being loaded with a stationary train.

All elements of the structure shall be checked assuming simultaneous application of all derailed wheel loads. However, the reduction of positive moment in continuous slabs due to derailed wheel loads in adjacent spans shall not be allowed.

##### Horizontal

For cross-sections having clearance between vehicle and barrier wall of 6 inches to 36 inches, with maximum vehicle speeds of 60 mph, the force due to horizontal derailment loads shall be taken as 40% of a single vehicle weight acting two feet above top of rail and normal to the barrier wall for a distance of 10 feet along the wall. Barriers farther than 36 inches clear from vehicles are not contemplated. For tracks supported by guardrails, the guardrails will resist this force.

#### **6.5 CLEARANCES**

Minimum distance between centerlines of adjacent tracks on all new construction shall be 15'-0" for main tracks. ROW limitations, bridges, tunnels, and stations may impact the track spacing and cause closer track centers. Closer track spacing shall require the approval of RTD. Other typical dimensions and clearances are shown in Section 4 and Section 9 of this Design Criteria.

Where RTD tracks are adjacent to freight rail tracks, follow the greater of clearances specified by either the railroad or by RTD. At clearance locations where superelevation is present, vertical clearances shall be measured from the high rail.

## **6.6 GEOTECHNICAL SUBSURFACE INVESTIGATION**

Geotechnical subsurface investigations shall be conducted in accordance with AREMA Manual and as modified by the appropriate RTD and Railroad Guidelines.

## **6.7 EARTH RETAINING STRUCTURES**

### **6.7.1 Geometry**

Retaining wall layout shall address slope maintenance above and below the wall. Provide returns into the retained fill or cut at retaining wall ends where possible. Any residual wall batter should be into the fill. Design and construction shall consider surface and subsurface drainage. A drainage system shall be provided to intercept or prevent surface water from entering behind walls. A fence or protection railing with a minimum height of 42 inches above a standing surface shall be provided at the top of walls 30 inches or higher.

### **6.7.2 Wall Types**

Metal walls, including bin walls and sheet pile walls, recycled material walls, and timber walls will not be permitted for permanent retaining walls. The proposed wall types shall have been successfully used for similar loading, geotechnical, and environmental conditions.

### **6.7.3 Design Requirements**

Retaining walls shall be designed in accordance with the applicable standards and references outlined in this Design Criteria. The design of MSE and modular walls near or in bodies of water shall account for soft saturated soils and scour. Retaining walls near irrigation lines for landscaping shall account for the additional hydrostatic load due to a waterline break. The use of free draining backfill material and/or leak detection devices to reduce hydrostatic loads on retaining walls shall be included. Use section 206 of the CDOT Standard Specifications for Road and Bridge Construction for backfill requirements. Appropriate drainage details shall be provided for all retaining walls. Retaining walls shall be designed and constructed to have a minimum service life of 75 years.

The use of Mechanically Stabilized Earth (MSE) walls to support freight rail loadings must be approved by the controlling railroad. The design and construction of MSE walls shall be in accordance with the current AASHTO Standard Specifications for Highway Bridges except as modified by other provisions of AREMA and the appropriate Railroad Guidelines.

#### 6.7.4 Characteristics

Mechanically Stabilized Earth (MSE) Walls - Wall panels shall be constructed of reinforced concrete. Provide corrosion protection for prestressing or post-tensioning steel. Cover to reinforcing steel shall be a minimum of 2 inches. All reinforcing, mild or prestressed shall be galvanized or epoxy coated in splash zones of adjacent roadways. Panel joints shall accommodate differential settlement.

Modular wall height shall not exceed 15 feet. Modular walls cannot be used for primary mainline retaining walls. Modular walls may be used for secondary retaining wall locations, such as RTD park-n-Ride and stations.

A mechanical connection to the wall facing for soil reinforcement shall be provided; friction connections relying on gravity alone will not be acceptable.

Soil reinforcement for MSE and modular walls shall be galvanized, epoxy coated steel or geogrids meeting creep requirements of AASHTO Specifications. Design shall account for any item projecting through the soil reinforcement. Avoid placing culverts and utilities perpendicular to soil reinforcement within the reinforced soil mass. Soil reinforcement shall be protected from corrosion of metal due to stray electrical currents. Requirements for stray current control shall follow the project standards as defined by RTD.

Where the use of MSE is proposed on electric traction systems utilizing direct current, an Engineer specializing in corrosion protection/prevention shall investigate and make site-specific recommendations for special design considerations.

Consideration shall be given to the potential for accelerated corrosion or deterioration of structural elements of MSE due to the relatively high permeability of railroad roadbeds and the potential for precipitation and other potentially corrosive substances infiltrating the roadbed. The use of an impermeable geomembrane connected to lateral drains below the sub-ballast, but above the top level of reinforcements should be considered.

Consideration in design shall be given to placing soil reinforcements around intrusions such as catenary pole foundations, abutment caissons and piling, and vaults. Soil reinforcements shall be placed to protect the structural integrity of the MSE walls.

Consideration should be given to placing the uppermost level of reinforcing elements below the depth of excavation that would be reached in the placement of utilities within the ROW. Alternately, conduits for utilities should be placed during the MSE construction.

Excavation to, or below, the top level of reinforcing elements shall not be allowed following the construction of the MSE.

Cast-in-Place Walls - Cast in place walls shall be designed and constructed in accordance with the current AASHTO specifications and CDOT design manual and standards. Expansion joints and weakened planes shall be provided as necessary to accommodate differential movements.

Anchored Walls - Anchored wall design and construction shall use FHWA RD-82-046, FHWA RD-82-047 and FHWA-IF-99-015 as guidelines. Anchors shall be encapsulated with plastic sheathing. Proof load tests for anchors shall be provided in accordance with the above FHWA guidelines. Shotcrete shall meet the aesthetic requirements set by RTD.

Soil Nail Walls - Soil nail walls may be used when top-down construction is warranted. Soil nail walls shall not be used if ground water seepage will be a problem. Design and construction shall use FHWA-RD-89-93, FHWA-SA-93-086 and FHWA-SA-96-069 as guidelines. Load testing for nails shall be provided in accordance with the above FHWA guidelines. Shotcrete shall meet the aesthetic requirements, including final finish, as established by RTD.

Structural Diaphragm and Caisson Walls - Structural diaphragm walls and caisson walls may be used when top-down construction is warranted.

## **6.8 BRIDGES**

### **6.8.1 Geometry**

All fill and cut slopes along the longitudinal axis of bridges with spill through abutments shall not be steeper than 2:1 perpendicular to the face of each abutment. There shall be a 2-foot berm at the top of slopes in front of abutments. Along the commuter rail alignment, where the tracks are depressed or elevated on a structure, a 2 foot-6 inch emergency/maintenance walkway shall be provided for each track. Bridge supports shall be located radially for curved structures where practical. The maximum bridge skew shall be less than 30° away from radial supports, if practical.

Bridge deck and approach slab surface smoothness on Direct Fixation bridges shall not deviate more than 3/8 inch in 25 feet using a profilograph as described in Subsection 412.17(a) of the CDOT Standard Specifications for Road and Bridge Construction. The profile index shall start and terminate on the bridge approach slab. One profile shall be taken for each track lane.

### **6.8.2 Inspection Access**

All bridge superstructures, joints and bearings (type II or type III) shall be made accessible for long-term inspection. Superstructures consisting of I-girders with exposed cross frames shall be made accessible with walkways, ladders or by use of a snooper truck. Steel box girders, cast-in-place concrete box girders and precast prestressed concrete "U" girders with inside depth of 5 feet or more shall be made accessible for interior inspection. Bottom slab access doors shall be placed at locations which do not impact traffic under the bridge and shall swing into the box girder. Box girders shall be protected from access by vermin.

### **6.8.3 Protection Fencing**

All CR structures shall have a protection fence adjacent to the emergency/maintenance walkway with the top being no less than 42 inches above the walkway surface. The fence shall be vinyl-coated for bridges with 3/8 inch mesh in areas around stations and platforms that are adjacent to highways or where snow and ice may be thrown from snow removal equipment onto patrons. All walls greater than 30 inches above the adjacent surface outside of the CR envelope shall have protection fence or barrier 42 inches above the trackway or walkway surface.

### **6.8.4 Approach Slabs**

Special considerations for transition areas and treatment at slab ends shall be in accordance with AREMA Manual Chapter 8, Section 27.8.

Provide an approach slab at each end of each CR and freight rail bridge. The approach slab shall be a minimum of 25 feet in length measured along the centerline of the bridge. The end of the approach slab shall be perpendicular to the track centerline if at all possible. The approach slab shall be 2 feet wider than the track tie length at a minimum. The approach slab may be the same width as the bridge deck (minus the width of the protection rail or curb) and provide for the smooth transition from ballasted section to bridge structures. Track tie spacing shall be reduced to 21 inches on approach slabs.

An underdrain system shall be designed beneath all approach slabs to reduce water in embankment fills at bridge abutments. Bridge deck drains shall be located, so as to minimize the amount of water flowing across all joints.

Differential settlement across approach slabs shall be less than 1 inch. Ground improvement techniques to the approach embankment subgrade shall be implemented if necessary to meet this requirement.

### **6.8.5 Bridge Decks**

Provide a minimum deck thickness of 8 inches. Open or filled grating decks and orthotropic decks will not be permitted. Precast deck slabs shall require cast-in-place topping slabs and joint closures, and post tensioning across joints. Pretensioned, precast concrete deck forms shall be a minimum of 3 inches thick and have a full grout or concrete bearing. Stay-in-place (SIP) metal deck forms are permitted. Parallel bridges shall have a minimum 1 inch (4 inch preferred) longitudinal gap between decks or parapets, or shall be tied together to make one structure. Ballasted track bridges shall be protected with an appropriate waterproofing.

### **6.8.6 Deck Joints**

The number of deck joints shall be minimized. All expansion joints shall be a CDOT approved strip seal or modular joint. Design and location of joints shall provide for maintenance accessibility and future replacement. Modular joints shall be designed and tested for fatigue loading.



### **6.8.7 Bearings**

Provide design of bearings to allow maintenance accessibility and future replacement. Design and show jacking points for future maintenance and replacement. Elastomeric bearings are preferred. Sole plates, when used, shall have a 3/4 inch minimum thickness. At expansion bearings, the edge of the sole plate shall not slide past the edge of the elastomeric pad, by the use of a positive stop. Provide at least 3 inches of cover between anchor bolts and the edge of the concrete pedestals. Provide reinforcement for pedestals greater than 3 inches high.

### **6.8.8 Drainage**

Provide splash blocks at all deck drain daylight locations. The bridge deck drainage requirements shall be in accordance with the bridge drainage section in this Design Criteria.

Where direct fixation is used on CR bridges, a trench drainage system, perpendicular to the tracks, shall be used at the end of the bridge deck, prior to joint between the approach slab and the bridge superstructure.

### **6.8.9 Protective Angles**

For the freight rail bridges over roadways, the impact protection devices (protective angle) shown in the UPRR/BNSF Plan No. 711200 "Sacrificial Beams and Impact Protection Devices" shall be modified by RTD "Protective Angle Details". The protective angles are only required for the exterior girders exposed to approaching traffic. The sacrificial beam details shall be in accordance with the Plan No. 711200.

### **6.8.10 Pier/Abutment Protection**

Pier/Abutment protection shall be according to AREMA Manual, CDOT Bridge Design Manual, AASHTO LRFD Bridge Design Specifications and the Railroad Guidelines as appropriate. Criteria regarding vehicle and railway collision loads on structures included in AASHTO LRFD Bridge Design Specifications are also applicable to the design of pier/abutment protection, as appropriate.

## **6.9 WATERPROOFING AND DAMPPROOFING**

Waterproofing and dampproofing design, material specifications and applications shall be according to Chapter 8, Part 29 of AREMA Manual, and as modified by the appropriate Railroad Guidelines. Six inches of ballast shall be placed over waterproofing immediately upon acceptance. No construction traffic is allowed on waterproofing until the ballast is in place. Waterproofing installation shall be observed and approved by the manufacturer's representative.

For the structures used exclusively by commuter rail transit, and upon RTD's approval, designers may substitute a spray elastomer waterproofing coating system for either the Butyl Rubber or EPDM membrane denoted above. The elastomer bridge deck membrane shall be suitable for both concrete and steel deck surfaces.

The coating system shall be spray applied, 100% solids, and a fast cure high build system. Default thickness shall be 80 mils (2 mm). A polymer primer is required.

The membrane system shall be capable of sealing across the expansion joints in the concrete deck without the need to use a separate gland and bonding agents on the membrane. This will assure a continuous waterproofing membrane system across the entire deck.

Material requirements for the elastomer coating system are:

- a) Primer – 100% solids, two-component polymer primer, cures to 0° F.
- b) Deck Membrane – 100% solids, rapid curing elastomer, install by spray, conforming to:

<u>Property ~ Cured Product</u>	<u>Test Method</u>	<u>Typical Value</u>
Solids Content	---	100%
Shore Hardness	ASTM D 2240	50 D
Elongation	ASTM D 638	>400%
Tensile Strength, psi	ASTM D 638	>2500
Tear Strength, pounds force/inch, Die C	ASTM D 624	390
Taber Abrasion, mg. Loss (1000 gm, 1000 rev, H-18)	ASTM D 4060	250
Moisture Vapor Transmission	ASTM E 96	<0.025 perms
Gel Time	---	<10 Seconds
Tack Free	---	<30 Seconds
Open to Light Traffic	---	1 Hour
Electrical Resistance	ASTM D257	2.0 by 10 <sup>13</sup> ohm-cm
Ballast Test	Min. 2,000,000 cycles no damage. Performed with No. 4 bridge ballast to a depth of 8 inches.	

The use of protective asphaltic panels is not required with the Elastomer bridge deck membrane. However, a film thickness test is required before the deck membrane is accepted.

**6.10 STRAY CURRENT CONTROL**

Ensure that all structures and structural components shall be protected from corrosion of metal due to stray electrical currents. Reinforcing steel in bridge structures may either be protected by use of a continuously welded steel mat that has been properly grounded, epoxy coated steel or in the case of ballasted decks by use of an insulating membrane placed beneath the ballast. All structures placed

below grade or buried structures shall be properly protected and insulated from stray currents.

Structures and structural components shall be treated with Polyurea or approved equal for waterproofing and corrosion control.

#### **6.11 TEMPORARY STRUCTURES**

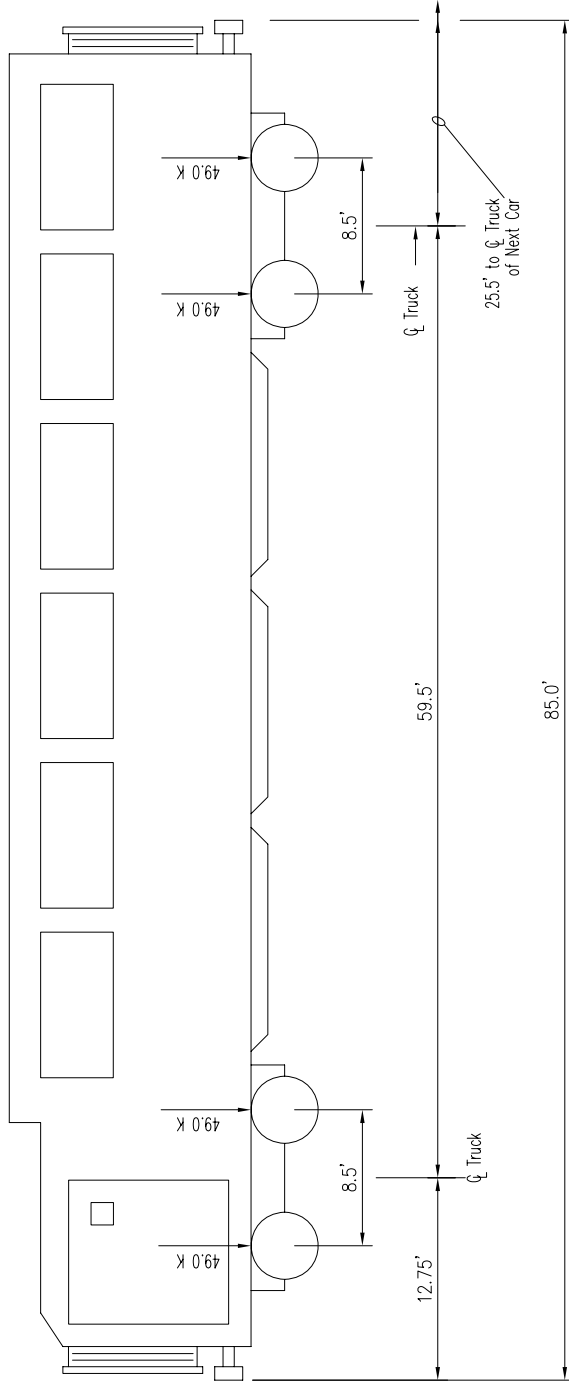
Temporary structures including falsework, and shoring systems consisting of cantilevered sheet piling, anchored sheet piles, cantilevered and anchored soldier beams with lagging, braced excavation, and cofferdams shall be designed and constructed in accordance with CDOT requirements, AREMA Chapter 8, and as modified by the appropriate Railroad Guidelines.

#### **6.12 CATENARY POLE FOUNDATIONS**

Foundations for catenary poles shall be either cast-in-place or precast reinforced concrete. The design of foundations for supporting structures and guy anchors shall be based on the structure loading calculations and soil data. The supporting structure foundations shall be designed to accept anchor bolts and base plates and shall have provision for feeder conduits and structure grounding.

**END OF SECTION**

**THIS PAGE LEFT INTENTIONALLY BLANK**



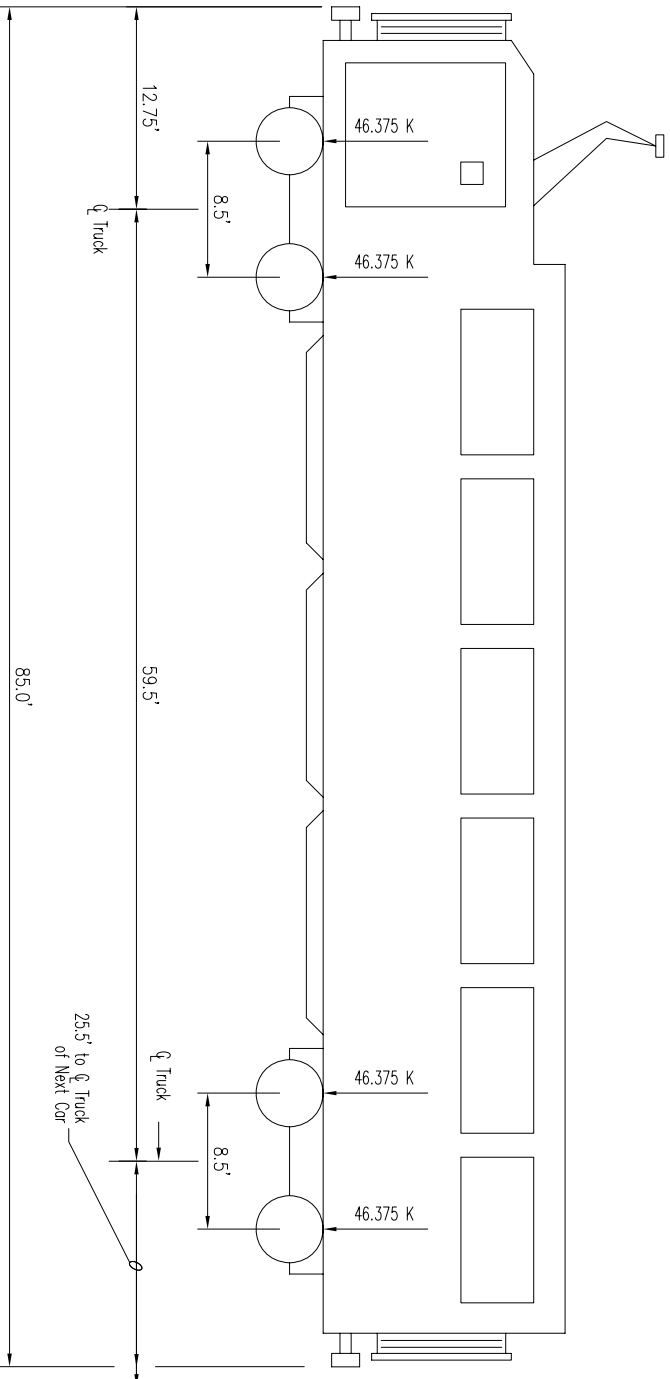
NOTES:

1. TOTAL CRUSH LOAD 196 KIPS/CAR.
2. ONE CAR SHOWN, EIGHT CARS OPERATING MAXIMUM.

**RTD**  
 REGIONAL TRANSPORTATION DISTRICT  
 1600 BLAKE STREET  
 DENVER, COLORADO 80202  
 (303) 628-9000

COMMUTER RAIL  
**DESIGN CRITERIA**

TITLE: CRT LOADING DIAGRAM  
 CORRIDOR VEHICLE  
 DIESEL MULTIPLE UNIT (DMU)  
 FIGURE: 6.1

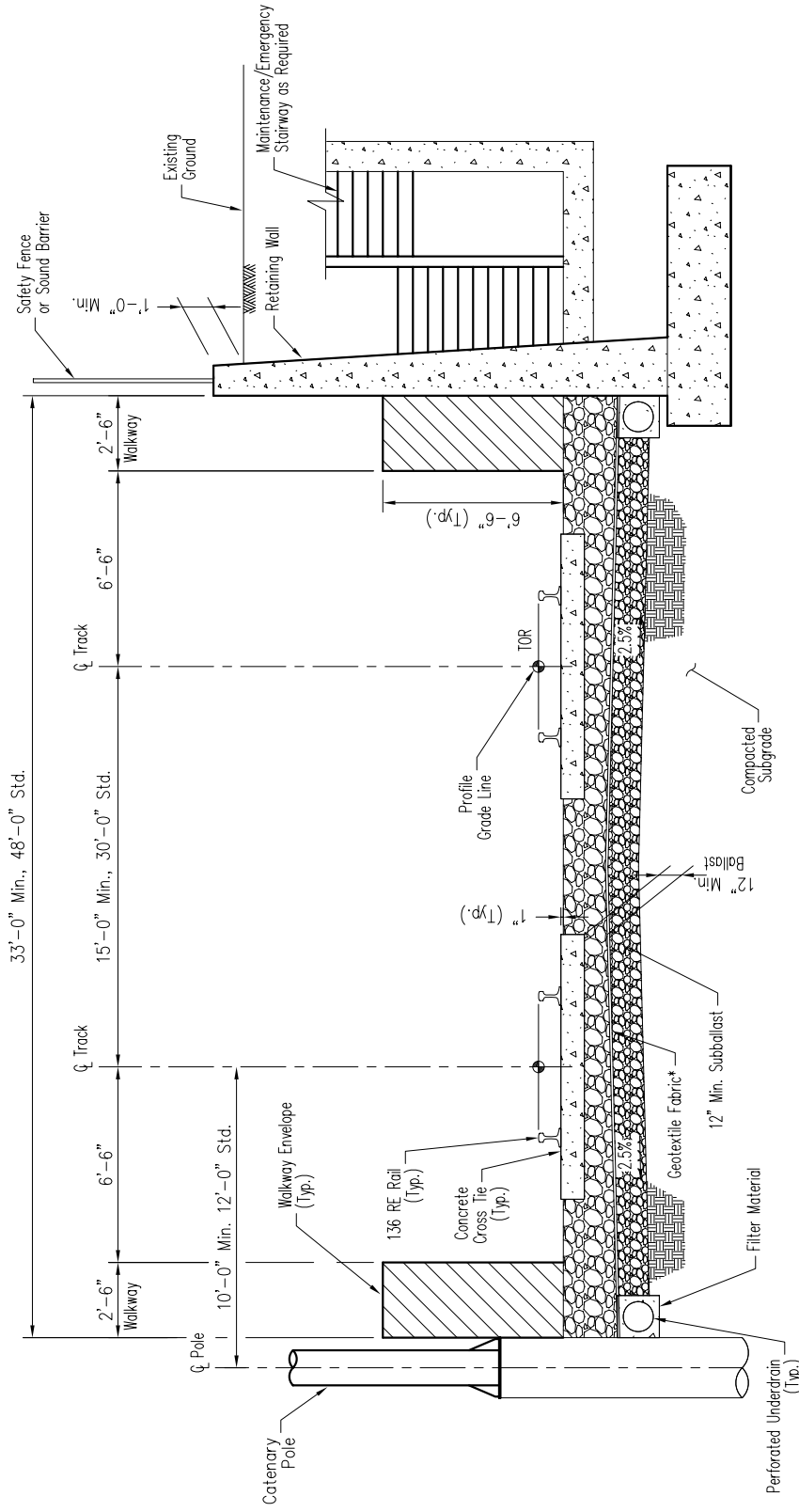


- NOTES:
1. TOTAL CRUSH LOAD 185.5 KIPS/CAR.
  2. ONE CAR SHOWN, EIGHT CARS OPERATING MAXIMUM.

**COMMUTER RAIL  
 DESIGN CRITERIA**

**TITLE: CRT LOADING DIAGRAM  
 CORRIDOR VEHICLE  
 ELECTRIC MULTIPLE UNIT (EMU)**

**FIGURE: 6.2**



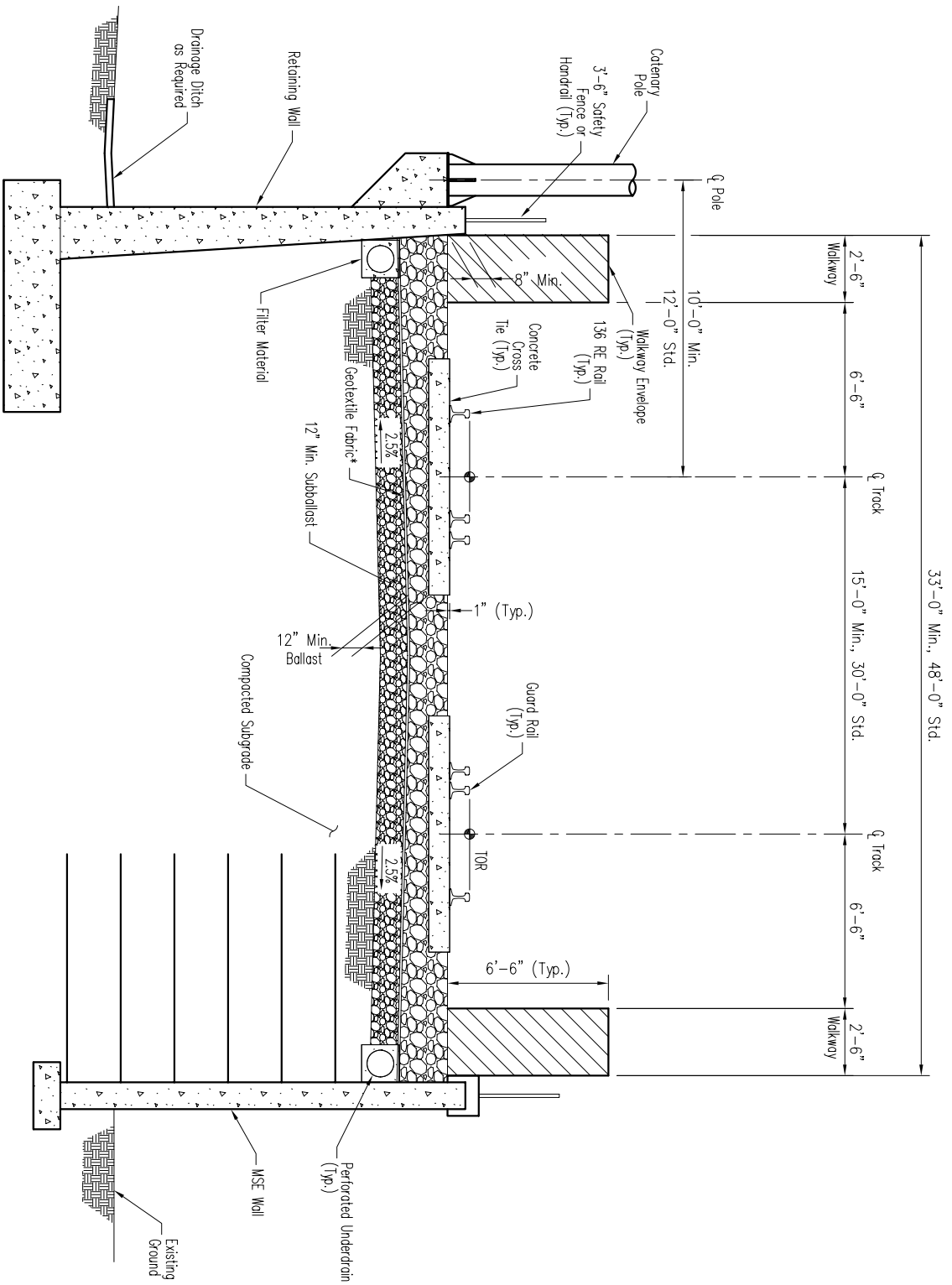
\* USE EITHER GEOTEXTILE AND/OR SUBBALLAST AT OPTION OF PROJECT GEOTECHNICAL ENGINEER

TITLE: TYPICAL DEPRESSED SECTION WITH ONE ADJACENT WALL TANGENT TRACK

FIGURE: 6.3

# COMMUTER RAIL DESIGN CRITERIA

**RTD**  
 REGIONAL TRANSPORTATION DISTRICT  
 1600 BLAKE STREET  
 DENVER, COLORADO 80202  
 (303) 628-9000



\* USE EITHER GEOTEXTILE AND/OR SUBBALLAST AT OPTION OF PROJECT GEOTECHNIC ENGINEER



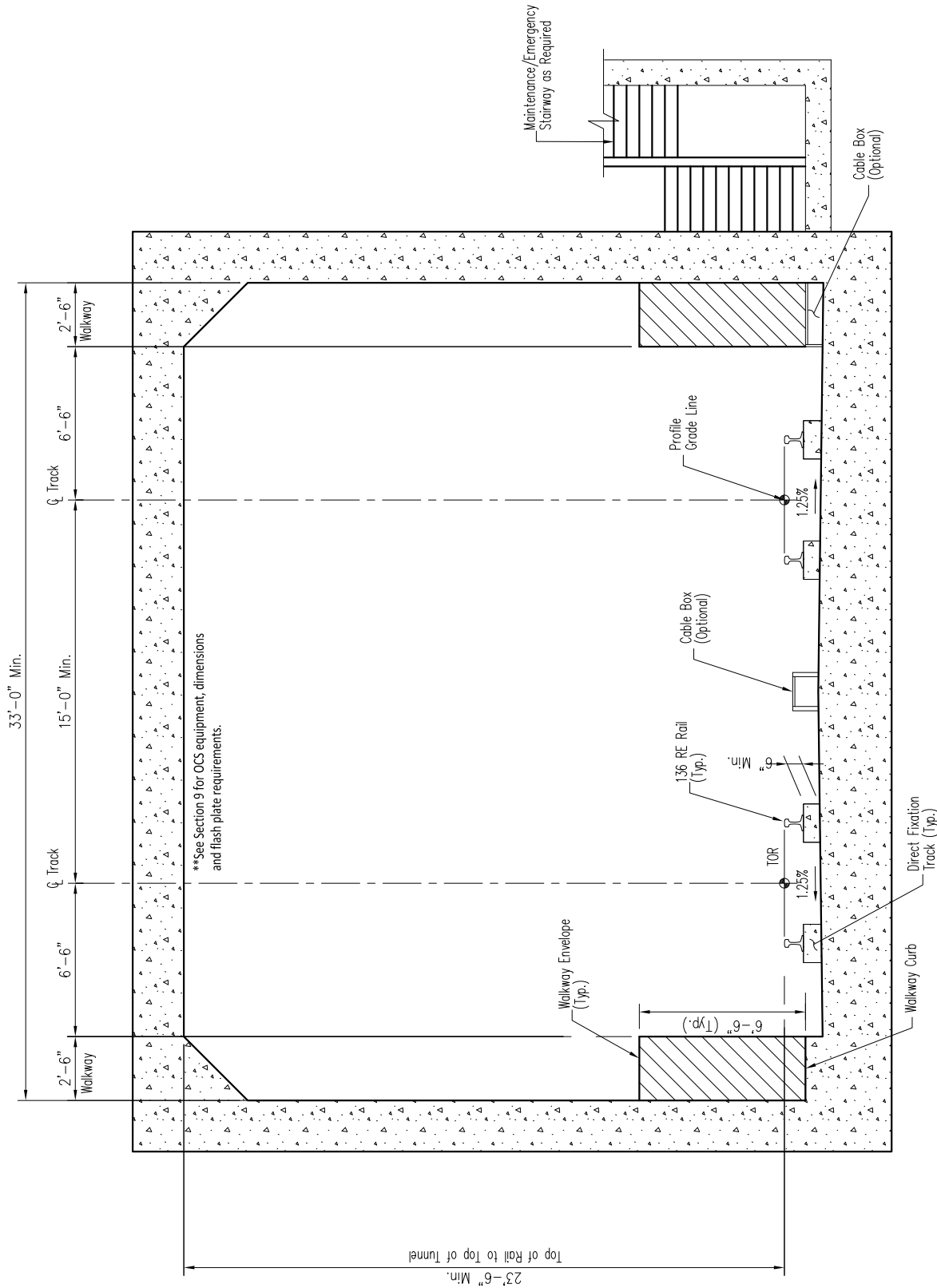
REGIONAL TRANSPORTATION DISTRICT  
 1600 BLAKE STREET  
 DENVER, COLORADO 80202  
 (303) 628-9000

# COMMUTER RAIL DESIGN CRITERIA

TITLE: TYPICAL RETAINING WALL APPROACH  
 TANGENT TRACK

FIGURE: 6.4

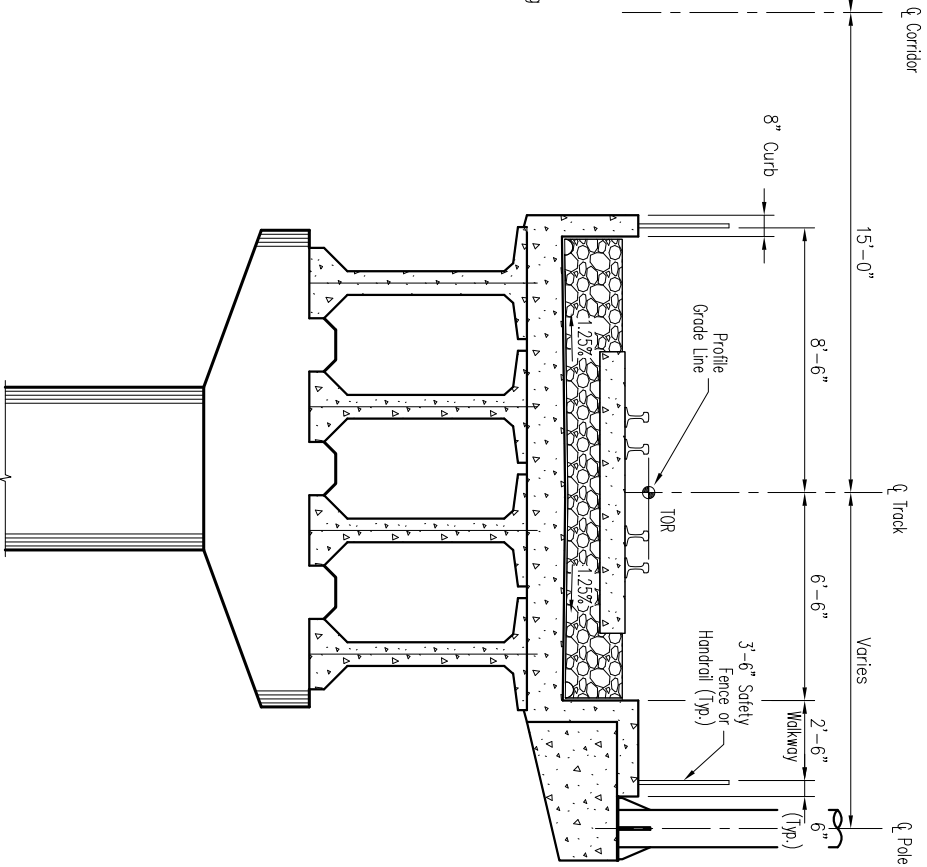
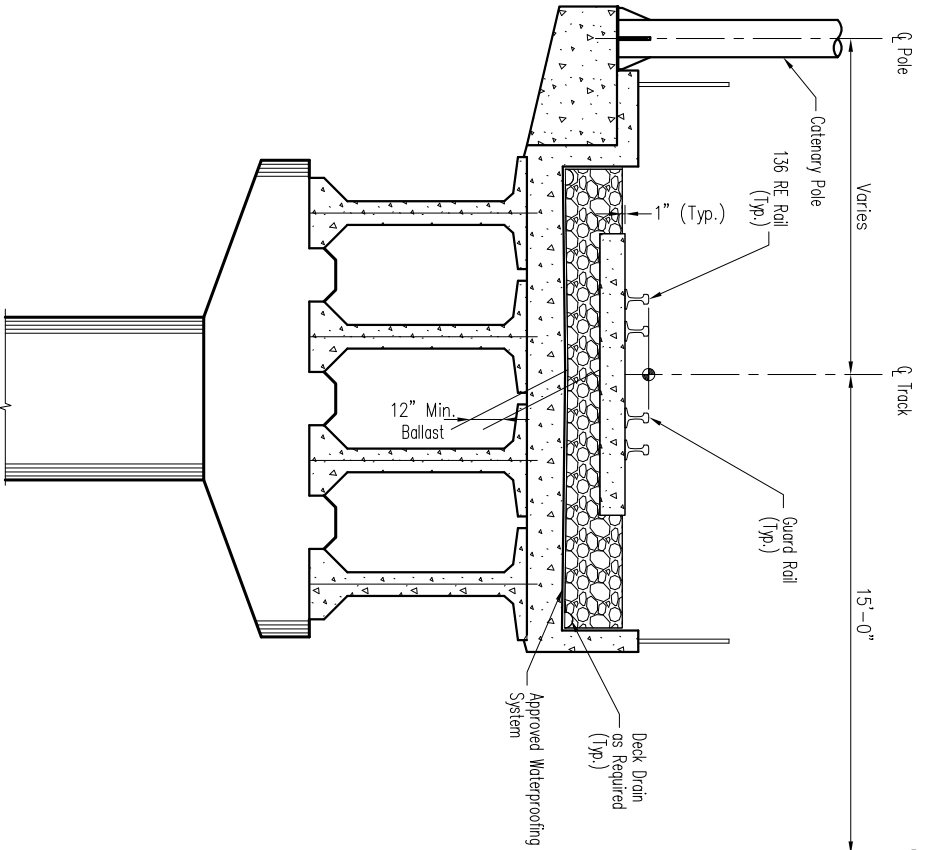




**TITLE: TUNNEL SECTION - LONG TUNNEL > 400' TANGENT TRACK**

**FIGURE: 6.5 (REV. 4/1/09)**

**COMMUTER RAIL  
DESIGN CRITERIA**

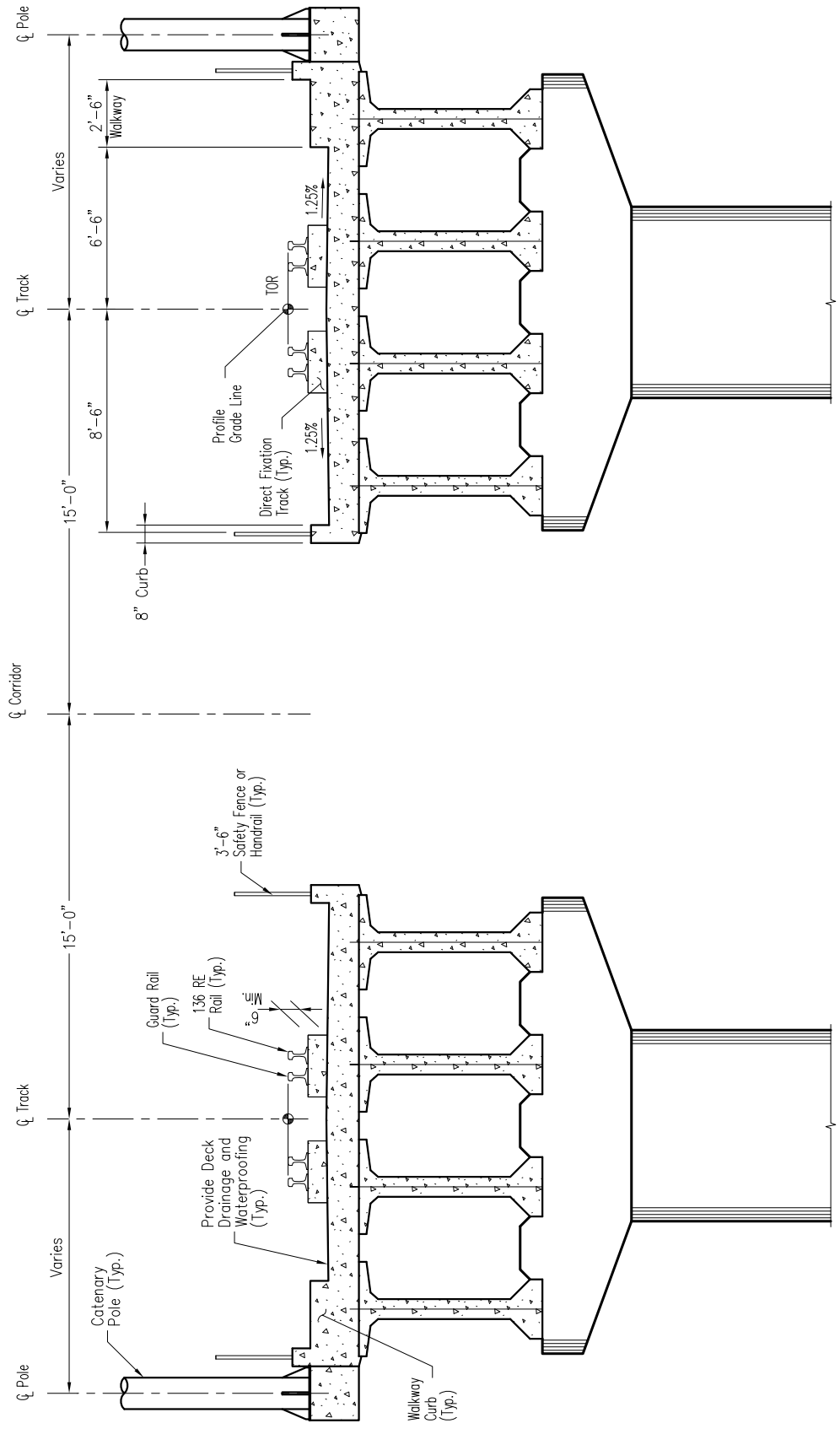


REGIONAL TRANSPORTATION DISTRICT  
 1600 BLAKE STREET  
 DENVER, COLORADO 80202  
 (303) 628-9000

COMMUTER RAIL  
**DESIGN CRITERIA**

TITLE: BALLASTED DECK BRIDGE  
 TANGENT TRACK

FIGURE: 6.6

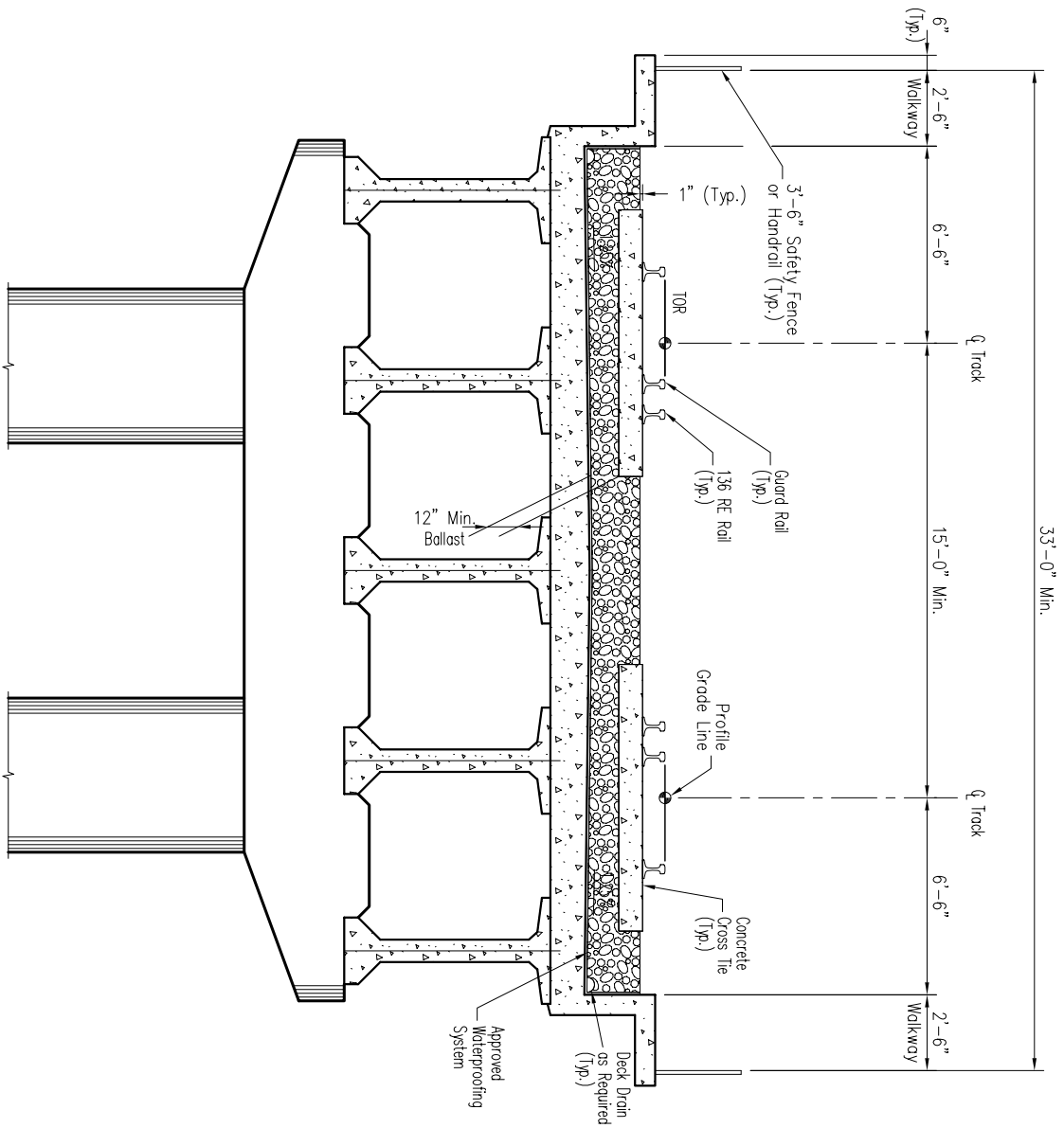


**TITLE: DIRECT FIXATION DECK BRIDGE  
TANGENT TRACK**

**FIGURE: 6.7**

**COMMUTER RAIL  
DESIGN CRITERIA**

**RTD**  
REGIONAL TRANSPORTATION DISTRICT  
1600 BLAKE STREET  
DENVER, COLORADO 80202  
(303) 628-9000



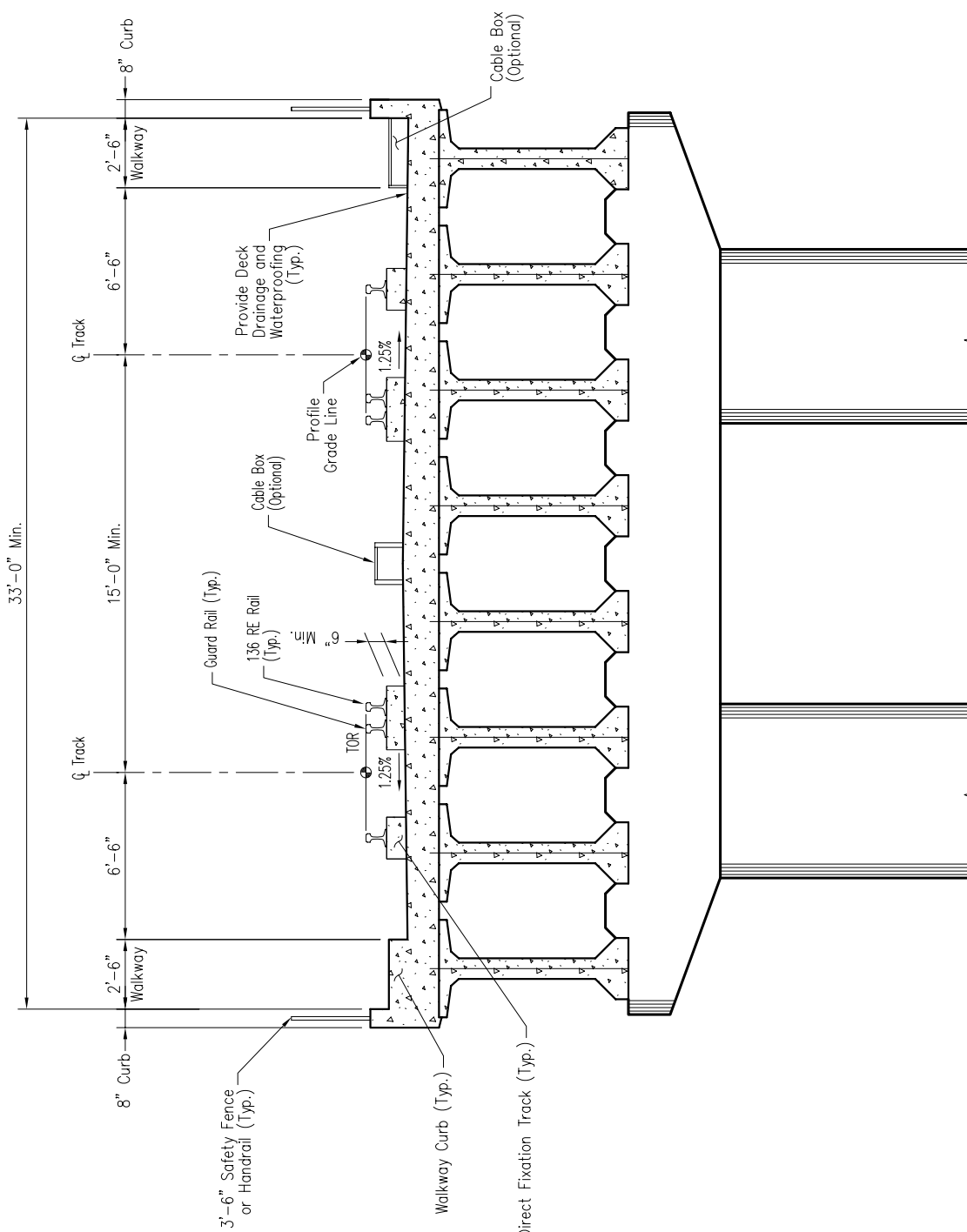
**COMMUTER RAIL  
DESIGN CRITERIA**

**TITLE: BALLASTED DECK DUAL TRACK BRIDGE  
TANGENT TRACK**

**FIGURE: 6.8**



REGIONAL TRANSPORTATION DISTRICT  
1600 BLAKE STREET  
DENVER, COLORADO 80202  
(303) 628-9000



TITLE: DIRECT FIXATION DECK  
 DUAL TRACK BRIDGE  
 TANGENT TRACK

FIGURE: 6.9

COMMUTER RAIL  
 DESIGN CRITERIA

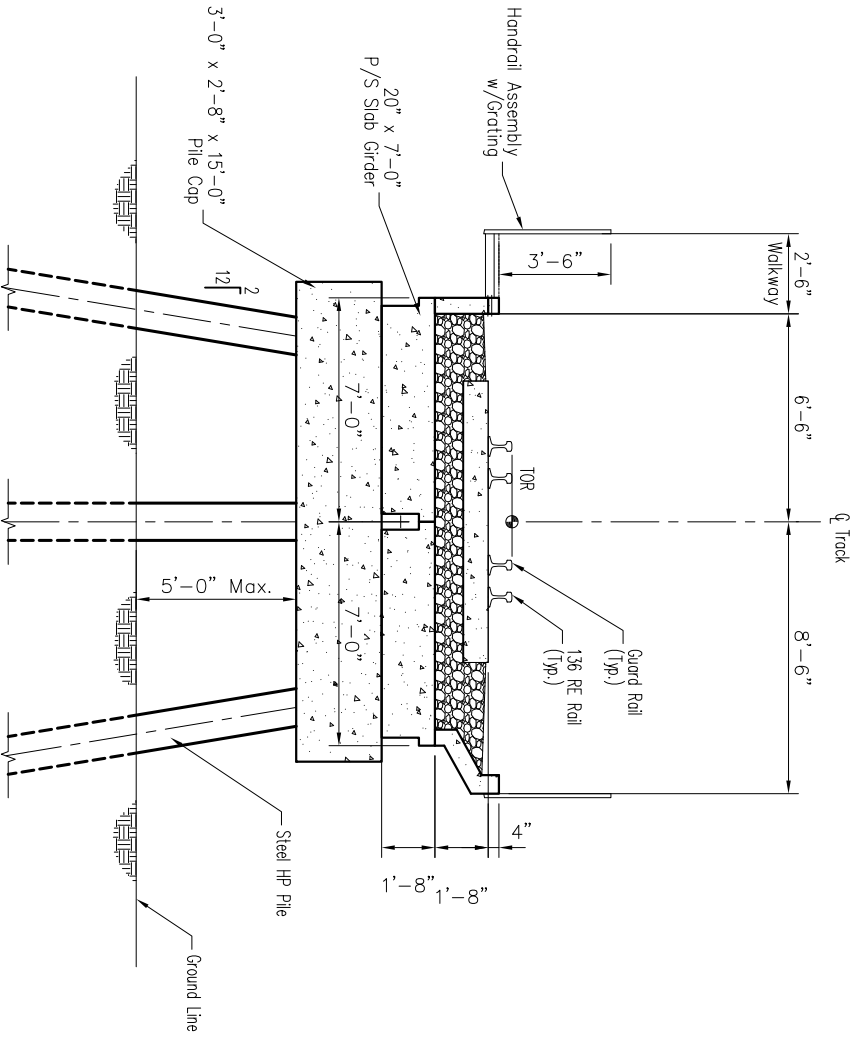


REGIONAL TRANSPORTATION DISTRICT  
1600 BLAKE STREET  
DENVER, COLORADO 80202  
(303) 628-9000

# COMMUTER RAIL DESIGN CRITERIA

TITLE: SHORT SPAN SLAB GIRDER BRIDGE  
WITH STEEL PILE BENT (30' MAX. SPAN)  
TANGENT TRACK

FIGURE: 6.10



## TABLE OF CONTENTS

### SECTION 7 – COMMUNICATIONS AND CENTRAL CONTROL

7.1	GENERAL.....	3
7.2	STANDARDS AND CODES.....	3
7.3	OPERATIONS CONTROL CENTER.....	4
7.3.1	Control Room Layout.....	4
7.3.2	Consoles.....	4
7.3.3	Environmental Considerations .....	5
7.4	SCADA .....	6
7.4.1	Safety Constraints on SCADA.....	6
7.4.2	System Operation .....	6
7.4.3	System Requirements .....	7
7.4.4	Displays .....	7
7.4.5	Software .....	8
7.4.6	Central Equipment.....	8
7.4.7	Remote I/O Equipment.....	9
7.4.8	Simulator .....	10
7.5	COMMUNICATIONS.....	10
7.5.1	Radio System.....	10
7.5.2	PBX/Telephone System.....	11
7.5.3	CCTV System.....	11
7.5.4	PA/VMS System .....	11
7.5.5	Communication Transmission System .....	12
7.5.6	Communication Power System.....	13
7.5.7	Location of Communication Enclosures and Equipment.....	13

7.6	INTERFACE REQUIREMENTS .....	13
7.6.1	Central Control Facility .....	13
7.6.2	SCADA Remote I/O Equipment .....	13



## **SECTION 7 COMMUNICATIONS AND CENTRAL CONTROL**

### **7.1 GENERAL**

The Communications and Central Control System (CCS) includes communications equipment, the remote I/O equipment, and the human interface equipment to help allow Controllers to monitor and control the wayside systems and facilities. Additionally, controllers shall supervise mainline rail operation as well as interface with regional Class 1 Railroads. The scope includes:

- A new Commuter Rail CCS with supervisory control to allow commuter rail operations personnel to remotely monitor and control the signal system, traction electrification system (TES), Ticket Vending Machines (TVM), and station and wayside facilities, issue route requests to the signal system and issue commands to open breakers to the TES.
- Remote I/O equipment interconnecting Commuter Rail (CR) Operations Control Center (OCC) with signal cases and houses, communications equipment houses and cabinets, and traction power substations (TPSS).
- Radio control equipment to be used at the control room.
- Telephone PBXs and telephones for voice communication from the control room to other RTD personnel and to outside personnel.
- Emergency telephones installed in elevators, CR tunnels, on platforms and other passenger waiting areas.
- A closed circuit television (CCTV) system to allow personnel at the control room and in the CR Security Command Center (SCC) to monitor activity at parking facilities, elevators and station platforms.
- A public address/variable message sign system (PA/VMS) and interface equipment, accessible from the control room to enable audible and visual text display of passenger information.
- An IP based network to facilitate a communications backbone system to carry voice, data, and video communication information.
- Communication houses, cabinets, batteries, chargers, raceway, etc. to enable reliable operation of wayside communications equipment.

### **7.2 STANDARDS AND CODES**

The communications and central control system shall be designed and implemented to the latest revision, at the time of award of contract, of the applicable codes and standards of the following organizations:

- American National Standards Institute (ANSI)
- Electronic Industries Association (EIA)

- Federal Communication Commission (FCC)
- Institute of Electrical and Electronics Engineers (IEEE)
- International Organization for Standardization (ISO)
- National Electrical Manufacturers Association (NEMA)
- National Fire Protection Association (NFPA)
- Building Industry Consulting Standards Institute (BICSI)
- Internet Engineering Task Force (IETF)

### **7.3 OPERATIONS CONTROL CENTER**

The CR OCC and SCC shall be designed to be a comfortable, quiet, and uncluttered working area, and shall meet the requirements of the Americans with Disabilities Act of 1990, including Appendix A to Part 37 of U.S. Department of Transportation, Final Rule - Transportation for Individuals with Disabilities.

#### **7.3.1 Control Room Layout**

The layout of the control room shall be such that the control room staff can work and interact with each other effectively and efficiently. To be most effective, the staff positions within the control room shall be within line-of-sight of one another to allow the use of visual signals to supplement their voices.

Access to the control room shall be located to minimize the disturbance to staff communications or their view of the overview display.

#### **7.3.2 Consoles**

Control room staff shall utilize consoles to supervise system activities. Each console within the control room shall contain the communications, reporting, controls, and monitoring equipment necessary to carry out the assigned functions by the Controllers. All Controller consoles shall be identical.

All consoles shall have the following design requirements:

- a) Like equipment and procedures shall be used for like functions and like functions shall be in the same general physical location in each console.
- b) Frequently used equipment shall be located most conveniently. Most-frequently used procedures shall require the fewest, least-extended motions possible.
- c) The amount of equipment and variety of procedures at a console shall be minimized, consistent with requirements for modular and expandable design.

- d) Voice communication interfaces shall be integrated such that CR OCC and SCC staff need not switch between more than two devices to interact with the several parties with whom they may need to maintain contact. Audio outputs shall have volume and tone controls.
- e) Console physical dimensions shall be consistent with ergonomic limits. Consoles shall be designed to accommodate the reach of a 5<sup>th</sup> percentile female and the size of a 95<sup>th</sup> percentile male.
- f) Console components shall be modular to allow replacement of a failed unit within 30 minutes, and replacement shall not require shutdown of the functioning portion of the console.
- g) Writing and documentation storage space shall be provided. The Controller consoles shall have the following design requirements:
  - 1) A keyboard and point-and-click device shall be able to be used for display item selection and function initiation. Single purpose function buttons and switches may be used for, but limited to, functions which are frequently used or require rapid activation.
  - 2) Console display monitors shall be high resolution with a minimum of 1280 x 1024 pixels, with a maximum 8ms response time. Contrast ratio shall be not less than 800:1. Color capabilities shall be 24-bit or true color which is comprised of three colors each with 8-bits of color. Brightness shall be a minimum of 300 cd/m<sup>2</sup>. Viewing angles shall be a minimum of 178° for both vertical and horizontal. Console monitors shall be selected and placed to minimize emission exposure. Monitors shall have easily accessible intensity and color controls.
  - 3) Console furniture and chairs shall be consistent with ANSI/HFS 100, "American National Standard for Human Factors Engineering of Visual Display Terminal Workstations".
- h) Controller consoles shall be assignable to a geographic portion of the CR system.

### **7.3.3 Environmental Considerations**

The following site requirements shall apply at the CR OCC and SCC:

- a) The CR OCC and SCC shall meet all applicable fire safety requirements, including NFPA 130. A fire alarm and suppression system shall be provided for the control room and equipment room.
- b) Raised flooring with removable tiles may be provided for the control room and equipment room. These tiles shall be covered with same sized removable carpet. The metallic floor framing shall be grounded.
- c) Wide door access shall be provided at the control room and equipment room to accommodate the movement and placement of equipment.

- d) The control room and equipment room shall each be fully enclosed to create a secure environment and to minimize noise. The Equipment Room shall also be a secure area.
- e) The lighting within the control room shall be generally uniform, and at a level of at least 50 foot-candles. Consoles shall have additional, locally controlled, adjustable spot lighting to 100 foot-candles.
- f) Reflected glare on display screens, overview display, and console work surfaces should be minimized.
- g) Noise within the control room should be minimized. There shall be acoustic treatment of the control room, including floors and walls, to absorb noise. Background noise, including background noise from Communications System equipment, shall not exceed 55 db.
- h) The control room and equipment room shall be provided with air conditioning. There shall be independent temperature controls for the control room and equipment room. The temperature in each area shall be adjustable to be within the comfort zone for humans for interior spaces. The air distribution shall minimize temperature gradient and drafts. The temperature shall be maintained in the range of 64° F-75° F with a humidity range of 30%-55% (non-condensing).
- i) Approximately two air exchanges per hour shall be provided for. The air distribution shall minimize temperature gradient and drafts.
- j) Electrostatic control shall be provided for in the control room and equipment room. Flooring and carpeting shall not allow static build up.

## **7.4 SCADA**

### **7.4.1 Safety Constraints on SCADA**

The relationship between the Communications System and the Signal System shall be such that no action or failure of the CCS/SCADA (nor any other Communications System element) can cause or allow an unsafe train operating condition. Should the CCS/SCADA become completely inoperative, for any reason, the CR system shall be able to continue to operate safely.

### **7.4.2 System Operation**

CCS/SCADA shall normally function without operator intervention except for routine service.

CCS/SCADA shall have the capability for performing orderly system start-up and shut-down as commanded by a system operator.

Remote CCS/SCADA equipment shall operate in an unattended mode. The central CCS/SCADA equipment shall continue operation in the event of a failure of remote SCADA equipment, and upon return to service of failed equipment, automatically resume normal monitoring and management of that equipment.

### **7.4.3 System Requirements**

#### **7.4.3.1 Response Times**

- a) The elapsed time from the first possible detection by remote I/O equipment of an alarm or device change of state until display at the control room shall not exceed 2.5 seconds.
- b) When a user enters a command for any individual device control, the remote I/O equipment shall generate the associated output signal, in the field, in no more than 2.5 seconds.
- c) When a user requests a display, the completed display shall appear on the screen in not more than two (2) seconds.

#### **7.4.3.2 Accuracy of Information**

Display of train position shall be accurate to within a track circuit for signaled territory.

#### **7.4.3.3 Availability**

CCS/SCADA is intended to operate 24 hours a day, seven days a week. The CCS/SCADA central system availability shall be at least 99.8% for all operating functions.

Any console shall be capable of fully backing-up a failed console of the same type. Back-up shall take the form of assuming the full geographic and functional responsibilities of the failed console.

The CCS/SCADA shall be constructed such that it can be put in place and continue to operate while:

- a) Already-operating lines are retrofitted for the new Communications System.
- b) New lines are equipped, tested and brought into service.

### **7.4.4 Displays**

Displays at the control room shall be graphic and text displays. Graphic displays shall be provided at both the overview display and at the console displays. The overview display and console graphics displays shall provide a semi-geographic representation of the CR system and its major subsystems. Information displayed shall be kept up-to-date.

At the control room, user interface equipment characteristics, equipment location, and

display contents shall be consistent with MIL-STD-1472 "Human Engineering Design Criteria for Military Systems, Equipment, and Facilities" or an approved equivalent human factors standard or guide such as the FAA's Human Factors Design Guide.

For all graphic displays, the following guidelines shall be followed:

- a) Distinct colors and display attributes (e.g., flashing) shall be used to draw attention to alarm or abnormal conditions.
- b) There shall be consistent use of colors, geographic orientation, labels, display attributes, and object symbols.
- c) Label and message contents shall be in language consistent with RTD train operations terminology.

#### **7.4.5 Software**

Software design and implementation of CCS shall:

- a) Follow guidelines for software design and documentation as defined in IEEE Std. 729
- b) Conduct a software quality assurance program for software development consistent with practices as defined in IEEE Std. 730

The CR software system shall be easily definable and modifiable so that: 1) the overview display and console display contents can change as track, stations, and devices are added; and 2) console display devices can be changed.

Application software shall be written in an industry-standard high level language. It shall be built on an approved commercially prevalent or industry-standard operating system and be portable to higher capacity computer system configurations running that standard operating system. All new software shall be compatible with existing CCS network software and network architecture. Networking system software shall satisfy the Open System Interconnect (OSI) requirements and/or utilize approved industry-standard physical level and link level communication protocols.

All CCS software shall be completely tested before it is used for train operations.

#### **7.4.6 Central Equipment**

The CCS central equipment shall:

- a) Utilize commercially available computer equipment and peripheral devices. Custom equipment shall be limited to special functions and interfaces.
- b) Normally operate unattended.

- c) Have sufficient redundant equipment to permit automatic switch-over so that no single failure shall interrupt operation for more than 30 seconds.
- d) Automatically detect equipment failures and provide corresponding failure indications.
- e) Where feasible, provide for on-line replacement of failed components, console devices, computers, peripheral devices, and data communications interface equipment while it continues to operate.
- f) Be sized to handle the defined CR system size under peak-period operating conditions and have provisions for future expansion.
- g) Be physically located and configured in such a way so as to provide for easy maintenance access.
- h) Be provided with an uninterruptible power supply (UPS), with a minimum capacity of 4 hours, and a redundant source of AC power.

#### **7.4.7 Remote I/O Equipment**

The Remote I/O Equipment (e.g. PLC's), which is the field portion of SCADA, shall:

- a) Be solid-state, microprocessor based with logic elements and auxiliary components configured on easily replaceable plug-in modules.
- b) Be of common design for all remote sites to provide interchangeability of modules.
- c) Be capable of continued operations with the loss of communication to the CR OCC as a result of either communication equipment failures or central equipment failures.
- d) Operate normally unattended. Remote I/O equipment logic and configuration data shall reside in non-volatile memory.
- e) Perform self-tests upon power up and on command from local test equipment and from CR OCC. Self-tests shall also be performed by input/output subsystems and input/output cards.
- f) Provide for maintenance of input/output circuits (including disabling power to output circuits) and safe replacement of input/output cards without the removal of any wiring.
- g) Be capable of continued operation between 32°F and 122°F with 95% humidity (non-condensing).
- h) Operate within a power supply range of 90 to 125 volts ac and a frequency between 57 to 63 Hz.

- i) Be capable of continued operation in the electromagnetic environment where the remote I/O equipment will be located, such as TES sub-stations, signal cases, and communications houses.
- j) Support local initialization and troubleshooting with either a local control panel or portable test equipment. Also support remote initialization and troubleshooting via the data communications network.
- k) Be modular in design to provide expansion of performance and capacity by adding subsystem modules. This shall include the ability to add a minimum of 20% more input/output subsystem modules.
- l) Be supplied with hardware and software tools and documentation for reconfiguration and expansion.

#### **7.4.8 Simulator**

The design shall include a CR CCS simulator for training of CCS users.

The simulator shall model the physical plant so as to present accurate representations of train movement, interlocking response, and traction power system response for the above purposes. The simulator shall model all discrete state indications, which are normally presented to the CCS. The simulator shall be deterministic. The simulator shall be capable of simulating normal and abnormal equipment operation. The simulator shall also provide the capability to playback (e.g. re-display) real wayside events as originally depicted on the Controllers' displays and the overview display.

The simulator shall provide both an Instructor user interface and a trainee user interface. The Instructor shall be able to alter the simulated behavior of trains as well as all wayside devices. The trainee's user interface to the simulator shall be the same displays as those used in normal operations at the Controller consoles. The simulator shall use the standard commands and displays, which normally support active operations, supplemented by simulator-specific commands.

The simulator shall model the entire physical plant including the traction power system. The simulator shall be capable of modeling train control and traction power simultaneously together. The simulator shall be capable of being upgraded to represent the latest physical plant layout.

### **7.5 COMMUNICATIONS**

#### **7.5.1 Radio System**

Modifications to RTD's radio system shall be made to enable communication between:

- a) CR trains and Controllers.
- b) CR trains and Rail Supervisors.



- c) CR Rail Supervisors and Controllers.
- d) CR non-revenue vehicles and Controllers.
- e) CR MOW personnel and Controllers.
- f) CR trains and maintenance personnel.
- g) CR Controllers and other CRT personnel along the ROW.

All commuter rail trains and Maintenance (MOW) non-revenue vehicles shall be equipped with mobile radio transceivers, with a minimum of 25 watts of radio frequency output power. A sufficient number of hand-held portable radios shall be furnished to allow CR train operators and maintainers along the CR right of way to carry a portable transceiver.

Radio coverage along the CR alignment including tunnel sections and within the rolling stock shall enable a two-watt portable radio to be heard with 20-dB quieting at the CR OCC along 98% of the alignment, 99% of the time. No "dead sections," with less than 20-dB quieting, longer than 50 feet shall be allowed.

### **7.5.2 PBX/Telephone System**

Each CR maintenance and operations facility shall be equipped with its own Private Automatic Branch Exchange (PBX). PBX, telephones, and interface equipment shall provide communications between Operations personnel and CR personnel and personnel outside of CR property.

The emergency telephone system shall be designed to permit passengers at stations, in elevators, walkway tunnels and at other passenger waiting areas to communicate with the SCC and the control room for emergency purposes. The phones shall be activated by push button and contain Braille lettering for ADA compliance.

The SCC personnel shall receive emergency phone calls from the passenger areas. Tunnel 'bluelight' phones shall be received by Controllers.

All phone conversations received/initiated by the Controllers shall be recorded.

### **7.5.3 CCTV System**

Refer to Section 14, System Safety and System Security for camera details.

### **7.5.4 PA/VMS System**

Station platforms and public areas will be equipped with PA/VMS equipment. PA/VMS equipment shall consist of amplifier-driven loudspeakers and variable message signs installed and operated in compliance with ADA requirements. Local input to both audible and visual portions of the PA/VMS system shall be provided at designated stations.

Text message entry shall be by way of easily and understandable graphical user interface with Windows-type entry screens and prompts. Audible and text messages shall be coordinated so that playback to the public occurs at the same time. It shall also be possible to transmit audio and text messages independent of each other.

Controllers at the control room shall be provided with the ability to distribute both pre-recorded and ad-hoc messages to passenger stations. This ability shall include provisions to send messages to an individual station, a group of stations, or all stations.

### **7.5.5 Communication Transmission System**

A fiber-optic IP-based high speed network communications transmission system (CTS) shall be installed along the CR right of way to inter-connect the various field SCADA, CCTV, data and voice signals to/from the field and from/to the CR OCC. The CTS includes a fiber-optic cable plant, optical and electronic transmission equipment, and other equipment necessary to provide communications between sites. The backbone, IP network system shall be configured to continue to operate normally on loss of a single fiber or any single equipment module. One high speed IP network shall be provided for all data, voice and CCTV.

There shall be a minimum of six single mode fibers pulled between Communication houses and Signal houses. There shall be a minimum of twelve single mode fibers pulled between Communication houses and TPSS.

#### **Communication Houses and Enclosures**

Field communications equipment shall be located in dedicated communications equipment houses or cabinets. Communication houses shall be a minimum size of 10x10 feet. All houses and cabinets shall be equipped with appropriately sized air-conditioning and heating equipment to maintain temperatures within the operating range of all equipment.

Outdoor security lighting shall be provided on and/or above communications houses. The security lighting shall be controlled by a photo-electric cell and shall not overflow into surrounding residential communities.

Communication house and cabinet foundations shall be designed to withstand all live and dead loads of the house and cabinet and equipment. Foundations shall be designed in accordance with all applicable standards as well as local Building Codes. An appropriate factor of safety according to the standards shall be applied at each site. Each foundation slab shall be provided with openings to connect the equipment to the local power supply system and to outside circuits.

Communication houses shall be of double roof and wall construction to accommodate insulation material to reduce heat transfer.

## **7.5.6 Communication Power System**

CTS, remote I/O equipment, network equipment, CCTV equipment, and radio equipment shall all be powered from an Uninterruptible Power System (UPS). The UPS shall be sized to carry the full load of the above equipment at a communication house for at least 4 hours. The charger shall be sized to carry the same load while recharging a completely discharged battery set. The charger shall be able to recharge the batteries under these conditions in less than 12 hours. The batteries shall be of maintenance free design and shall be sealed, non-spillable technology.

## **7.5.7 Location of Communication Enclosures and Equipment**

All communication devices, including platform mounted equipment, houses, cabinets, antennas and raceway shall be not less than 8' 6" from track centerline. This requirement includes clearance for enclosure doors in any open, intermediate, or closed position. Communication houses and cabinets shall be located so as not to obstruct the train operators', motorists' or pedestrians' view of trains.

## **7.6 INTERFACE REQUIREMENTS**

### **7.6.1 Central Control Facility**

The communications system and human interface equipment within the CR OCC, including consoles, radios, telephones and computers, shall be connected to essential power. Other equipment to be connected to essential power includes all CR OCC emergency systems and at least 40 percent of CR OCC and equipment room lighting.

The CR OCC system equipment shall utilize two independent grounding systems; one grounding system shall be for equipment grounding and the other for electronic signal grounding. The grounding systems shall interface to connection points in the equipment room and the CR OCC.

### **7.6.2 SCADA Remote I/O Equipment**

Remote I/O equipment shall support digital inputs and outputs via relay contact closures (or optically isolated solid state equivalents such as a silicon controlled rectifiers). All digital inputs to SCADA shall be of the same type. All digital outputs by SCADA shall be of the same type. The following SCADA input and output requirements shall be met:

- a) Digital inputs to SCADA shall be from normally open and normally-closed contacts. The operating voltage DC power supply shall nominally be in the SCADA domain. Contact ratings shall be as required for the circuit.
- b) Input and output signals shall be electrically isolated from SCADA equipment.

- c) SCADA shall generate outputs via relays. Transient suppression circuits shall be provided by the SCADA contractor. Contact ratings shall be as required for the circuit. SCADA interface relays and relay contacts shall have an MTBF, at rated loads, of 5,000,000 cycles or more.
- d) SCADA outputs shall be momentary contact closures with a time duration that is stable and adjustable.
- e) The remote SCADA equipment shall prevent unintended action such as energizing output circuits upon power-up and power-restore.

SCADA shall be designed and implemented so that wiring and cabling between remote I/O equipment and field devices are uniform in type, routing, and connection locations. The following interface requirements shall be met:

- a) I/O signals to/from SCADA at each signal facility shall terminate at one centralized location.
- b) I/O signals to/from SCADA at each TPSS site shall terminate at one centralized location.
- c) SCADA terminations shall include test points and rapid disconnect.
- d) All wires and cable shall be labeled using a logically consistent labeling convention.

Remote I/O equipment shall be equipped for protection from electromagnetic interference levels consistent with their locations. Bus bars shall be provided for grounding in all input/output termination cabinets.

Data communications between SCADA remote I/O equipment and the CR OCC shall utilize approved industry standard protocols, which support error detection and message retransmission.

**END OF SECTION**

**TABLE OF CONTENTS**  
**SECTION 8 – SIGNAL SYSTEM**

8.1	GENERAL.....	2
8.2	AUTOMATIC BLOCK/CAB SIGNAL SYSTEM.....	2
8.3	INTERLOCKINGS .....	3
8.4	HIGHWAY-RAIL GRADE CROSSINGS .....	3
8.5	STANDARDS AND CODES .....	4
8.5.1	Regulatory Documents.....	4
8.6	RTD GENERAL STANDARDS.....	5
8.7	SAFETY DESIGN.....	6
8.8	HEADWAYS AND BLOCK LAYOUT .....	7
8.9	SAFE BRAKING DISTANCE .....	7
8.10	ENVIRONMENTAL CONSIDERATIONS .....	7
8.11	SERVICE PROVEN EQUIPMENT AND DESIGN.....	7
8.12	TRAIN DETECTION .....	7
8.13	WAYSIDE SIGNALS.....	8
8.13.1	Color Light Signals.....	8
8.13.2	Signal Aspects .....	8
8.13.3	Light-Out Protection .....	9
8.13.4	Signal Locations.....	9
8.13.5	Signal Height.....	9
8.13.6	Signal Lighting.....	9
8.13.7	Signal Numbering.....	9
8.13.8	Red Signal Violation.....	9
8.13.9	Cab Signals.....	10
8.14	MAINLINE TRACK SWITCHES AND TURNOUTS .....	10
8.15	CONTROL CIRCUITRY.....	10
8.16	VITAL MICROPROCESSOR INTERLOCKING SYSTEMS.....	10
8.17	SIGNAL POWER.....	12
8.17.1	Power Line .....	12
8.17.2	Frequency Converters.....	12
8.17.3	Batteries .....	12
8.17.4	Redundant Signal Power .....	12
8.18	SCADA .....	12
8.19	CONTROLS (FROM THE OCC).....	12
8.20	INDICATIONS (TO THE OCC) .....	13
8.21	LIGHTNING AND TRANSIENT PROTECTION.....	15
8.22	WIRE AND CABLE .....	15
8.23	LOCATION OF SIGNAL EQUIPMENT .....	16

## **SECTION 8                      SIGNAL SYSTEM**

### **8.1            GENERAL**

Current state-of-the-art railway signaling techniques and products shall be applied throughout the Commuter Rail Transit (CRT) system to enhance safety in the movement of trains and improve the overall efficiency of train operations. The functions of the signal system shall include the protection and control of track switches; the protection and control of bi-directional train operation; and highway-rail grade crossing warning. The signaling needs and the type of signalization to be provided shall depend on whether the line is electrified or not. On electrified lines, the signalization to be provide shall be suitable for a 25kV, 60Hz AC traction power environment. On non-electrified lines, the signalization to be provided shall be a conventional system. The signal technology to be employed shall be a bi-directional, double track, cab signal type system. The signal system must comply with the Positive Train Control (PTC) requirements of the Railway Safety Act of 2008, and provide interoperability with Union Pacific Railroad (UPRR), Burlington Northern Santa Fe (BNSF), Amtrak, and as required, other existing private carriers where their trains operate on RTD controlled lines.

### **8.2            AUTOMATIC BLOCK/CAB SIGNAL SYSTEM**

An Automatic Block Signal (ABS) System shall be designed that utilizes a series of consecutive blocks/track circuits governed by cab signals that are controlled by conditions that affect the use of a block. The cab signal system shall be the continuous inductive type. If the line is used only by cab equipped commuter rail vehicles, wayside signals will only be required at interlocking limits. The cab signal system shall be supplemented with additional wayside signals at intermediate locations, spaced to meet the scheduled headways. The intent is that freight trains will not have to be equipped with cab signal equipment in order to operate on the line and commuter trains with equipment failure will not block the line.. But in no case shall any trains operating on the lines not be PTC compliant.

At a minimum, the signal system design shall comply with the following:

- U.S. CFR, Title 49, Part 236, Subpart B – Automatic Block Signal System
- U.S. CFR, Title 49, Part 236, Subpart E – Automatic Train Stop, Train Control, and Cab Signal Systems
- AREMA C&S Manual, Part 2.2.1 – Recommended Functional/Operating Guidelines for Automatic Block Signal Circuits and Systems
- AREMA C&S Manual, Part 16.4.50 – Recommended Design Guidelines for Automatic Speed Control with Continuous Cab Signaling

A cut-in/departure test circuit shall be provided at all entrances to Cab signal territory by means of which the carborne equipment shall be tested to prove it is in operative condition before the train enters signaled territory.

Each Commuter Rail cab car shall be equipped with a Cab Signal carborne package that is compatible with that of the Cab Signal wayside design. The cab shall have both an audible indicator (to sound under a predetermined condition or conditions) and a visual indicator (to indicate a condition affecting the movement of a train or engine).

### **8.3 INTERLOCKINGS**

Interlockings shall be provided at all mainline turnouts and crossovers. In conjunction with cab signals, wayside signals shall be provided at interlockings and controlled points.

Approach or time locking, route locking, and traffic locking shall be provided. Detector locking/loss of shunt of not less than five (5) seconds shall be provided on each route within interlocking limits.

All non-conflicting train movements shall be permitted simultaneously. If applicable, sectional releasing shall be permitted.

At a minimum, the interlocking design shall comply with the following:

- U.S. CFR, Title 49, Part 236, Subpart C – Interlocking
- AREMA C&S Manual Part 2.2.10 – Recommended Functional/Operating Guidelines for Interlockings

### **8.4 HIGHWAY-RAIL GRADE CROSSINGS**

Warning devices for highway-rail grade crossings shall be installed; and at a minimum shall include gate arms and mechanisms, gate arm lights, LED flashing light units, electronic bells, signs, approach and island track circuits, standby/backup battery, and associated control circuitry as required. High wind guards and gate keepers shall also be provided.

The design of each highway-rail grade crossing shall be determined based upon site specific requirements. The total warning time shall be based upon the maximum authorized speed (MAS), a minimum warning time of 25 seconds (30 seconds if rail or highway-rail grade crossing shared with freight), and additional warning time that may be required for buffer time, clearance time and/or advance traffic signal preemption time. Constant warning time devices shall be provided if applicable for the system. Where a station platform is within the start of a highway-rail grade crossing, location of the approach circuits shall take into consideration a station dwell time of 30 seconds, and shall be provided with circuitry to prevent unnecessary activation/operation of the highway-rail grade crossing warning devices and interconnected traffic signal control devices.

All locations shall be equipped with a data recorder, and space allocated for the installation of video monitoring equipment.

The standard highway-rail grade crossing configuration shall be two (2) gates with flashers and two (2) median flashers. In the event that highway constraints prevent the use of a median, four-quadrant gates (two entrance and two exit gates) shall be provided.

In the event that the highway-rail grade crossing warning system does not activate or is activated but one or more crossing gates are not horizontal, the crossing signal house shall interface with the appropriate signal relay house(s) to ensure that the cab signal is downgraded to the most restrictive cab rate.

At a minimum, the following interface circuits shall be provided at all shared highway-rail grade crossings:

- Crossing Control (XR)
- Gate Up (GPR)
- Gate Down (GDR)
- Exit Gate Down (EGDR – if applicable)

At a minimum, the design shall comply with the AREMA C&S Manual, Section 3 – Highway-Rail Grade Crossing Warning Systems and the MUTCD, Part 8 – Traffic Controls for Highway-Rail Grade Crossings.

## **8.5 STANDARDS AND CODES**

### **8.5.1 Regulatory Documents**

The signal system shall be designed to the latest revision of the following regulatory documents, at the time of contract award:

- U.S. Code of Federal Regulations (CFR), Title 49, Part 236
- American Railway Engineering and Maintenance-of-Way Association (AREMA) Communications & Signals Manual
- Rules and Regulations of the Colorado Public Utilities Commission (PUC)
- National Electrical Code (NEC)
- National Electrical Safety Code (NESC)
- Insulated Cable Engineers Association (ICEA)
- American Society for Testing and Materials (ASTM)
- American National Standards Institute, Inc. (ANSI)
- Underwriters' Laboratories, Inc. (UL)
- U.S. Department of Transportation, Federal Highway Administration, Manual on Uniform Traffic Control Devices (MUTCD)
- Institution of Electrical and Electronic Engineers (IEEE)



## 8.6 RTD GENERAL STANDARDS

In addition to the regulatory documents listed in 8.5.1, the following are some general RTD specific standards that shall be incorporated in the design:

The ID for a relay house/case shall be related to the nearest tenth of a milepost from DUS.

- The ID for track circuits outside of interlocking limits shall be related to the nearest tenth of a milepost and track number at the normal entering end, with track circuits on the northbound track 1 tied to the nearest odd tenth of a milepost, and track circuits on the southbound track 2 tied to the nearest even tenth of a milepost. For example for track circuit 91-1T the south end of the circuit would be 9.1 miles from DUS on track 1, and for track circuit 92-2T, the north end of the circuit would be 9.2 miles from DUS.
- The ID for automatic signals outside of interlocking limits shall be related to the nearest tenth of a milepost and track number, with northbound signals tied to the nearest odd tenth of a milepost, and southbound signals tied to the nearest even tenth of a milepost. For example signal 91-1EC would be on track 1 on the East Corridor 9.1 miles from DUS.
- The ID for interlocking signals shall be based on even numbers starting with 2 for track 1 and 4 for track 2 and adding N for northbound signals and S for southbound signals that oppose each other. For example, 2N would be the first interlocking signal on track 1 at the south end of the interlocking, with 2S being its opposing signal.
- The ID for interlocking track circuits shall be tied to the number of the signal controlling movements over the track circuit with A B C etc. added from the south end of the circuit to the north end of the circuit. For example 2T would be the track circuit associated with signals 2N and 2S. If there were two circuits, they would be 2AT and 2BT.
- The ID for interlocking switches shall be odd numbers beginning with 1 from the south end of the interlocking and proceeding to the north end of the interlocking. For switches with more than one end add A B C etc. for different ends of the switch again beginning at the south end of the switch and proceeding to the north end of the switch. For example and interlocking with two universal crossovers would have switches 1A and 1B at the south end of the interlocking and 3A and 3B on the north end of the interlocking.
- The ID for a relay house/case and an automatic signal shall include a two letter suffix which indicates the corridor that each relay house/case and signal is associated with (i.e. East Corridor suffix is EC, Gold Line suffix is GL, North Metro suffix is NM and Northwest Rail suffix is NW).

## 8.7 SAFETY DESIGN

Train safety shall be the prime consideration in the design of the signal system and in the selection of its components, including relays and other devices with moving parts, insulated wire, wire terminals, binding posts, housings, conduits, resistors, capacitors, transformers, inductors and other similar items. The signal circuit design shall conform to the regulatory standards and codes listed in Section 8.5.1.

The following requirements shall govern the design of the portions of the system or subsystem which affect train safety:

- Only components which have high reliability, predictable failure modes and rates, and which have been proven in conditions similar to the projected service shall be utilized.
- Components shall be combined in a manner that ensures that a restrictive rather than a permissive condition results from any component failure.
- All circuits which are not confined to one housing and which affect safety shall be double-wire, double-break, except signal and switch indicator light circuits.
- The design shall be based on closed circuit principles.
- Component or system failures shall cause a more restrictive signal indication than that permitted with no failure. The built-in fault detection and alarm generation capability are preferred.
- System safety design shall be such that any single independent component or subsystem failure results in a safe condition. Failures that are not independent (those failures which in turn always cause others) shall be considered in combination as a single failure and shall not cause an unsafe condition.
- Any latent failure of the equipment, that is a failure, which by itself does not result in an unsafe condition, but which in combination with a second or subsequent failure could result in an unsafe condition, must be detected and negated within a stipulated time period.
- Electronic circuit design shall insure that the following types of component failures have a restrictive rather than a permissive effect:
  - Two terminal devices: open, short, partial open or short
  - Multi-terminal devices: combination of opens, shorts, partial opens and/or partial shorts
- Wherever possible, built-in checks shall be included that impose a restriction and/or actuate an alarm whenever a device fails to assume its most restrictive position when conditions require that it should.

- Redundant design by itself shall not be considered an acceptable method of achieving design safety.

## **8.8 HEADWAYS AND BLOCK LAYOUT**

Headway is defined as the time separation between two trains both traveling in the same direction on the same track. It is measured from the time the rear of the leading train passes a given reference point to the time the front of the train immediately following passes the same reference point at a minimum speed of 30 MPH. The design of the CRT signal system shall provide for a minimum signal design headway of 5 minutes for all line segments with a scheduled headway of 10 minutes or more. On line segments with a scheduled headway of less than 10 minutes, the planned signal design headway must be approved by RTD. Maximum train length for the commuter rail network will be eight (8) cars under normal conditions, though not all corridors are required to accommodate this length.

Signal system design headways are calculated without regard for variations in vehicles, weather conditions, or train operators. Headway calculations shall assume that stops are made at all stations, and a station dwell time of 90 seconds maximum.

## **8.9 SAFE BRAKING DISTANCE**

Safe braking distances shall be calculated using a vehicle reaction time of five (5) seconds, a minimum adhesion which would allow a deceleration rate on level tangent track of 1.95 MPHPS, and a 35% (distance) safety margin. In addition, the calculation shall assume an overspeed of 2 MPH and a runaway acceleration time as defined by the manufacturer of the cab equipment. The assumed deceleration rate shall be reduced on downhill grades to compensate for the effects of gravity. In addition, all safe braking distance calculations shall include the maximum authorized speed (MAS) of 79 MPH or the MAS for the governed area.

## **8.10 ENVIRONMENTAL CONSIDERATIONS**

All signal equipment installed on the wayside or housed in wayside signal enclosures shall be designed and manufactured for a minimum operating temperature of -40°F and a maximum operating temperature of +160°F at 0% to 95% relative humidity, non-condensing; and a minimum storage temperature of -67°F and a maximum storage temperature of +185°F at 0% to 95% relative humidity, non-condensing.

## **8.11 SERVICE PROVEN EQUIPMENT AND DESIGN**

All signal equipment shall be proven in similar North American railroad or transit service. The signal system shall have an expected service life of 40 years at the specified level of service.

## **8.12 TRAIN DETECTION**

Train detection shall be accomplished by using one of the following types of track circuits.

- Within interlocking limits on electrified lines, double-rail, shunt type 100 Hz, phase selective track circuits with impedance bonds and solid state electronic vane relays.
- Within interlocking limits on non-electrified lines, double-rail, shunt type DC relay track circuits.
- Outside of interlockings on electrified lines, solid-state electronic, coded track circuits suitable for use in 25 kV AC propulsion territory with impedance bonds.
- Outside of interlockings on non-electrified lines, solid-state electronic, coded track circuits.

On electrified lines, Audio Frequency Overlay (AFO), shunt-type track circuits shall be used for train detection in the control of highway grade crossing warning equipment.

On non-electrified lines, Microprocessor controlled Grade Crossing Predictors shall be used for train detection in the control of highway grade crossing warning equipment.

On electrified lines the design of the commuter rail rolling stock propulsion and traction systems and selection of track circuit frequencies and modulation schemes shall be coordinated to preclude interference between the rolling stock design and the signal system.

A shunt with 0.06 ohm resistance or less at any point between the two rails of any track circuit shall cause the track circuit to indicate train occupancy. Shunt fouling shall not be allowed, and multiple track relays or series fouling shall be used for all turnouts. On electrified lines voltage regulating transformers in the feed to the track may be used or additional track circuits may be installed, if necessary, to provide this shunting capability. On electrified lines, tuned impedance bonds shall be used to enhance track circuit stability and power consumption. All track circuits and associated bonding shall be designed to provide broken rail protection.

## **8.13 WAYSIDE SIGNALS**

### **8.13.1 Color Light Signals**

Standard railroad LED color light signals, including backgrounds and hoods, and split junction box bases shall be provided at all interlockings and any intermediate signals needed to comply with the requirements of this specification. The final design shall determine which type of color light signal shall be provided.

### **8.13.2 Signal Aspects**

Each signal aspect shall have an indication (meaning/operating instructions), which is the same wherever it is displayed throughout the CRT system.

### **8.13.3 Light-Out Protection**

"Light-out" protection shall be provided on wayside signals to prevent a signal from displaying a more permissive aspect from that intended because of a burnt-out lamp or broken wire.

### **8.13.4 Signal Locations**

Signals shall be located to the right of the track governed. There may be locations where space constraints do not permit right-hand signals. However, every effort shall be made to adjust clearances so that the signals can be located on the right. Signals should be located to provide a non-obstructed view from the operator's cab, and should be viewable from a distance not less than 1,000 feet in approach to the signal.

### **8.13.5 Signal Height**

All wayside signals governing normal movements shall be close to the Train Operator's eye level depending upon possible interferences and constraints.

### **8.13.6 Signal Lighting**

Approach lighting shall be used and signal lamp(s) shall be extinguished when the track circuits in approach to a signal are unoccupied. Approach lighting shall be activated at least two blocks in advance of a signal. Exceptions to this will include the first signal approached when leaving non-signaled territory and entering signaled territory (these signals shall be lit continuously). Under all circumstances the over-riding requirement shall be to provide a clear and unmistakable aspect at least 1000 feet in advance of the approaching train.

### **8.13.7 Signal Numbering**

All CRT signals other than interlocking signals shall have number plates attached to facilitate identification and simplify record keeping. Interlocking signals shall be numbered on the plans, but not on the wayside signal itself. Signals shall be assigned numbers (See Section 8.6) which coincide with the physical track distance from Denver Union Station to the signal. Signal numbers shall reflect this distance rounded to the nearest 100th of a mile.

### **8.13.8 Red Signal Violation**

Where applicable, signals shall be equipped with a positive means of detecting a red signal violation. Red signal violations shall be recorded at the local data recorder, as well as being sent to the CRT OCC via the SCADA system.

### **8.13.9 Cab Signals**

Each cab signal shall have an indication (meaning/operating instructions), which is the same throughout the commuter rail fleet. The system shall have multiple cab rates, each used to indicate a different cab signal.

## **8.14 MAINLINE TRACK SWITCHES AND TURNOUTS**

Switches shall be dual control (motor driven/manual) switch machines. Power for the dual control switch machines shall be from the signal power line or from commercial 120 VAC power source with rectifiers and 110 VDC batteries. Switch machines shall be equipped with operating rods, lock rods and point detectors. Limiting speeds through turnouts can be found in the CRT Design Criteria Section 4-Trackwork. A helper rod assembly and associated switch circuit controller shall be provided for all #15 turnouts or greater.

Switch heaters/snow melters shall be provided at all power and spring switch locations where the presence of ice and snow could affect rail service. Heater pads, wired in parallel, shall be sufficiently rated and provide sufficient coverage of the switch points, rods, and stock rail to keep them free of ice and snow. Switch heaters shall operate automatically and manually. An indicator shall be provided at the control equipment enclosure and on the exterior of the signal house/case (amber lamp) to indicate that the unit is on. Switch heaters shall be powered from a 208 or 240 VAC source.

## **8.15 CONTROL CIRCUITRY**

All safety circuits or logic shall be designed using vital relays and/or vital microprocessors of proven design and successful operating record.

Non-vital logic circuits may be controlled either by non-vital relays and/or non-vital logic controllers or emulators.

All relays shall plug into separate relay bases. All non-vital relays shall be identical. All relays shall be furnished with at least one spare independent front-back contact.

The use of diodes, capacitors, or resistors to change the timing characteristics of a vital relay shall not be allowed. All such timing characteristics shall be accomplished magnetically.

## **8.16 VITAL MICROPROCESSOR INTERLOCKING SYSTEMS**

Vital Microprocessor Interlocking Systems (VMIS) shall be employed to execute all vital signal system safety functions. The VMIS system shall be compatible with the existing microprocessor equipment currently in-service on the RTD rail system.

The VMIS shall be capable of operating in a commuter rail transit environment including exposure to temperatures, humidity, and vibration. The VMIS shall be

capable of operating at a temperature range of -40F to +160F at 0% to 95% relative humidity, non-condensing.

The VMIS software systems shall be segregated into two independent software levels as follows:

- Executive Software shall consist of the coding that performs the input, internal and output operations that is defined within the individual interlocking application logic. The executive software shall be configured on a closed loop principle to ensure that the individual vital microprocessors operate in a fail-safe manner. The executive software shall reside in a read only memory.
- Application Software shall be segregated from the executive software and consists of the vital signal logic defining a specific interlocking configuration. The application software shall derive its safety from signal circuit design practices similar to that used for relay logic.

For large interlockings (more than four power switches and/or movable point frogs), the VMIS system shall be segregated into zones and configured in a manner that failure in one zone will not affect the operation of an adjacent zone.

Individual VMIS units shall include both vital serial ports to interface with an adjacent VMIS unit, and non-vital serial ports to interface with a non-vital control system. Interface connections to wayside signal equipment shall be designed to function with existing RTD signal equipment operating at a standard voltage for the type of equipment in-service. Where necessary, the VMIS system shall include vital relays to provide interface to wayside signal apparatus.

The VMIS shall be equipped with a data recorder and diagnostic system capable of being accessed on-site at the VMIS location, or remotely over telephone or dedicated data lines using a diagnostic terminal or standard laptop personal computer. Data shall be capable of being accessed remotely from the data recorder and in real time on-site directly from the VMIS equipment. The diagnostic system shall be capable of identifying a failure, the nature of the failure and failure location. In addition to the diagnostic system, individual cards including; input/output boards, central processor cards and internal power supply boards shall be equipped with indicator lights that illuminate when respective input/output devices or ports are active.

The VMIS system shall be configured to operate from local available signal system power supply sources. Individual VMIS units shall be equipped with protection against unwarranted power surges at the power supply input terminals. The VMIS units shall also be protected against high levels of electric noise transmitted from external sources including radio, vehicle propulsion systems and hi-tension commercial power lines. Lightning protection including appropriate lightning arresters and equalizers shall be provided at all input terminals interfacing with wayside signal apparatus.

VMIS units shall be modular and consist of stand alone card files capable of being mounted in standard instrument racks. Included in the instrument rack shall be all signal equipment required to provide a complete stand alone system.

## **8.17 SIGNAL POWER**

### **8.17.1 Power Line**

Primary power should be provided to the various signal locations by individual power drops provided by the local utility. Provisions shall be considered for alternate or backup power in the event that there is a loss of primary power or commercial power is unavailable. On electrified lines as the track relays shall be of the phase-selective, two-element type, it shall be necessary for a fixed-phase relationship to be maintained between adjacent track circuits and between the two ends of each individual track circuit. Reference voltage between locations may be required to be provided via line wire.

### **8.17.2 Frequency Converters**

On electrified lines, as 100 Hz (rather than 60 Hz) phase selective track circuits are necessary within interlocking limits due to 60 Hz traction power, 60 Hz to 100 Hz converters of solid state design shall be provided at interlockings.

### **8.17.3 Batteries**

All signal equipment shall be provided with standby/backup battery. Nickel-cadmium or sealed lead-acid batteries, with a minimum capacity of 240 Ampere-hours shall be provided. At highway-rail grade crossings, separate battery banks for the operations of gates and lights and other signal equipment shall be provided. Battery backup shall provide sufficient power to allow the signal equipment to operate for a minimum of eight (8) hours under normal operating conditions.

### **8.17.4 Redundant Signal Power**

Redundant signal power shall be provided at all locations.

## **8.18 SCADA**

Each signal relay house/case shall be equipped with a SCADA interface to provide the following controls and indications to the SCADA system:

### **8.19 CONTROLS (FROM THE OCC)**

- Central Control – Allows the OCC to take control of a controlled signal location.
- Switch Heat – Allows the OCC manual operation of the switch heaters. In no case shall this control override the safety control (over current, over heat, etc.).



- Switch Control – Allows the OCC to take control of a switch. Each power switch shall have two associated controls. One shall be used to request the switch normal and the other shall be used to request the switch reverse. Circuits shall be arranged such that it is not necessary for a switch to be in a valid route in order for it to be requested. Requesting both positions simultaneously shall generate no new switch request.
- Switch Blocking – Allows the OCC to block a switch to prevent operation
- Route Request – Allows the OCC to request a route (requests the switch or switches that are associated within the requested route and requests the entering signal for the associated route). Each operative signal shall have one or more associated route request, depending on whether there are one or more routes associated with the signal. At a minimum, each operative signal shall have a “normal” or “reverse” route request, or both. Additional controls may be required if there are several “normal” or “reverse” routes.
- Route Cancel – Allows the OCC to cancel a cleared signal. Each operative signal shall have an associated Route Cancel.
- Traffic Request – Allows the OCC to change the direction of traffic on a track between two interlocking or controlled point signals without requesting a route or a signal.
- Track Blocking – Allows the OCC to block a track between two interlocking or controlled point signals to prevent any signal from displaying a route into that track.
- Fleet – Allows the OCC to fleet a cleared signal. Fleeting shall be initiated by first clearing a signal and then selecting the associated Fleet control. Fleeting shall be canceled by operating the Fleet Cancel for the fleeted signal. Each operative signal, for a primary revenue route, shall have the capability of being fleeted.
- Fleet Cancel – Allows the OCC to cancel a fleeted signal without canceling the Route Request. Each operative signal shall have an associated Fleet Cancel.

## **8.20 INDICATIONS (TO THE OCC)**

- Track Circuit – Each track circuit shall indicate occupancy.
- Switch Position – Each power switch shall have three associated indications.
  - Switch is in correspondence in the normal position.
  - Switch is in correspondence in the reverse position.
  - Switch is electrically blocked.
  - Switch is electrically locked.
- Signal Aspect – Each signal aspect shall have an associated indication.

- Signal Time – Each signal shall have an indication that shall indicate when the signal/route has been canceled and the ASR is de-energized.
- Lamp Out – Each signal shall have an associated indication that shall indicate whenever a lamp is burned out.
- Overrun – If applicable, each signal shall have an associated indication that shall indicate whenever a train has bypassed a red signal.
- Track Blocking – Each track section between two interlocking or controlled point signals shall indicate blocked or unblocked.
- Traffic - Each track section between two interlocking or controlled point signals shall indicate the direction of established traffic and whether that traffic is locked or not.
- Mode of Operation – Each controlled location shall provide three indications which shall indicate the current mode of operation: Auto, Central/Office, or Local.
- Fleet – Each signal shall have an indication which shall indicate whenever the associated signal is fleeted.
- Route Stacking – Each interlocking that has route stacking logic shall provide the necessary indications identifying the positions of each of the route requests that have been initiated.
- Faults/Warnings – There shall be a series of indications to indicate fault/warning conditions. These indications shall not be under the control of the mode of operation and shall indicate whenever the fault/warning is present. These indications shall include:
  - AC Power Off – Indicates whenever the primary AC power source is off. This indicates that the interlocking is operating on the alternate AC power source. This indication shall be omitted at locations with a single source of AC power.
  - DC Power Off – Indicates whenever one or more of the DC power supplies is not producing DC power. At locations with standby power supplies, this indication shall monitor both the on-line and standby power supplies.
  - DC Ground – Indicates whenever one or more ground detectors indicates a positive or negative ground fault greater than 50% of the drop away current of any vital relay used in the system. This shall monitor all of the DC power supplies in the associated relay house.
  - Link Fail – Indicates whenever serial communications between redundant processors (if applicable), and/or remote signal locations is lost. There shall be a separate indication for each link used.
  - Blown Fuse – Indicates whenever one or more of the indicating fuses or breakers are in the blown or tripped position.

- Switch Heat – Indicates whenever switch heat is “on”, regardless of the source of switch heat activation.
- Redundant Processor Statuses – There shall be a series of indications to indicate the health status of redundant processors (if applicable) and the VTP (Vital Transfer Panel). These indications shall not be under the control of the mode of operation and shall indicate whenever a status change is present. These indications shall include:
  - Health Status (Main) – Indicates whenever the “Main” or “A Unit” has experienced a failure and is not in control or not able to take control.
  - Health Status (Standby) – Indicates whenever the “Standby” or “B Unit” has experienced a failure and is not in control or not able to take control.
  - VTP Status – Indicates whenever the VTP selector switch is not in the “auto” position.
- Highway-Rail Grade Crossing indications:
  - Gate Down – Indicates whenever the crossing gates are in the horizontal position.
  - Crossing Active – Indicates whenever the XR is de-energized.
  - Crossing Alarm – Indicates whenever the crossing gates have been in the horizontal position for greater than 3 minutes.
  - Gate Alarm – Indicates whenever the XR is energized and the crossing gate(s) are not in the vertical position.

## **8.21 LIGHTNING AND TRANSIENT PROTECTION**

Track circuits shall be protected from lightning. Grounding electrode rods shall be provided and installed in the signal relay house/case. Connections between arresters, other signal equipment, and grounding electrodes shall be protected, except that all connections to grounding electrodes shall be by exothermic welding. All protection provided shall be per AREMA C&S Manual, Section 11 – Circuit Protection.

All electronic and solid-state devices shall have effective internal and separate external surge protection. High-voltage lightning arresters shall be applied to commercial power connections.

## **8.22 WIRE AND CABLE**

Station-to-station and signal relay house-to-field equipment signal wires in the signaled areas shall not be combined in the same cable or conduit with signal power or communication circuits. In general, conduit located in an underground duct bank shall be provided.

Station-to-station and signal house-to-field equipment signal conductors shall be #14 AWG or larger conductors. Multi-conductor cables shall have an outer jacket of extruded, black, low density, high-molecular weight polyethylene.

House/case wiring shall be #16 AWG or larger (TEFZEL).

Wire, cable, and the installation of both shall comply with the applicable requirements of the AREMA C&S Manual, Section 10 – Wire and Cable. A minimum of 10%, but not less than two spare conductors, shall be required in each cable.

### **8.23 LOCATION OF SIGNAL EQUIPMENT**

Signal system equipment shall be located in signal relay houses.

All track mounted signal equipment, including switch machines and impedance bonds shall clear the rolling stock clearance envelope by a minimum of six inches.

All signal equipment mounted on the right-of-way (ROW), including signals and signal relay houses shall clear the rolling stock clearance envelope by a minimum of two feet.

Doors of signal relay houses shall be restrained from opening to a position clear the rolling stock clearance envelope by a minimum of four feet.

Signal relay houses/cases shall be located in such a way as to not obstruct a train operators' or motorists' (in the case of highway-rail grade crossing warning equipment) view of the governing signal.

All signal relay houses shall be located to allow easy access for maintenance.

**END OF SECTION**

**TABLE OF CONTENTS**  
**SECTION 9 – TRACTION ELECTRIFICATION SYSTEM**

SECTION 9 - TRACTION ELECTRIFICATION SYSTEM..... 3

9.1 GENERAL ..... 3

9.1.1 The Traction Electrification System ..... 3

9.1.2 The Traction Power Supply System ..... 3

9.1.3 The Traction Power Distribution System (TPDS) ..... 4

9.1.4 Traction Power Return System (TPRS)..... 4

9.1.5 Projectwide Design Criteria ..... 5

9.2 FUNCTIONAL REQUIREMENTS ..... 6

9.2.1 Traction Power ..... 6

9.2.2 Power Distribution ..... 6

9.2.3 OCS Sectioning ..... 7

9.2.4 Remote Operations ..... 8

9.3 TES DESIGN REQUIREMENTS..... 8

9.3.1 Traction Power Supply System ..... 9

9.3.2 Traction Power Feeders and Return Cables ..... 14

9.3.3 Overhead Contact System (OCS) ..... 14

9.3.4 OCS Route Design ..... 21

9.3.5 OCS Wiring Arrangements at Overlaps, Turnouts and Phase Breaks ..... 21

9.3.6 Clearance Between Bridges or Buildings and OCS ..... 21

9.3.7 Bridges and Buildings Over the Track ..... 22

9.3.8 Contact Wire Dimensioning ..... 22

9.3.9 Foundations ..... 25

9.3.10 Poles and Portals ..... 25

9.3.11 Clearance of Poles and Foundations from Track ..... 25

9.3.12 OCS Support Requirements ..... 26

9.3.13 Types of OCS Supports ..... 27

9.3.14 Contact Wire Registrations ..... 28

9.3.15 Insulation ..... 28

9.3.16 OCS Project Documentation ..... 29

9.4 GROUNDING ..... 31

9.4.1 Traction Power Return System ..... 31

9.4.2 Traction Power System Grounding ..... 32

9.4.3 OCS Poles ..... 32

9.4.4 OCS Surge Arresters ..... 33

9.4.5 Un-Energized Components ..... 33

9.4.6 Grounding of Metallic OCS Poles and Structures ..... 33

9.4.7 Grounding of Gantries and Gantry Equipment ..... 33

9.4.8 Grounding for Steel Over Rail Bridges ..... 33

9.4.9 Grounding for Concrete Over Rail Bridge ..... 34

9.4.10 Utilities Attached to Bridges ..... 34

9.4.11 Grounding at Passenger Stations ..... 34

9.4.12 Personnel Ground Grids ..... 35

9.4.13 Personnel Grounding Platforms ..... 35

9.5	STANDARDS AND CODES.....	35
9.6	PRODUCT REQUIREMENTS.....	36
9.6.1	Traction Power Supply System .....	36
9.6.2	Overhead Contact System (OCS) .....	41
9.7	OCS DESIGN PARAMETERS.....	45

**List of Tables**

9-1	Contact Wire Height.....	15
9-2	Maximum Wire Gradient versus Line Speed .....	16
9-3	Design Parameters .....	30

**List of Figures**

9.1	Track Minimum Overhead Contact System Bridge Clearances – Commuter Rail Tracks
9.2	Track Minimum Overhead Contact System Bridge Clearances – AAR Plate H Tracks

## **SECTION 9 - TRACTION ELECTRIFICATION SYSTEM**

### **9.1 GENERAL**

Commuter rail corridors shall be electrified at 25kV (nominal), 60 Hz, single phase alternating current, unless otherwise approved by RTD. RTD-owned traction power substations shall receive primary supply from electric power utility company ("Utility") feeders or taps and supply 25kV electrical power to the commuter trains' pantographs via an overhead contact system. Return current from the trains shall reach the substation via the wheels and the traction power return system.

Unless defined within this document, traction electrification system terms are defined in American Railway Engineering and Maintenance-of-Way Association Manual for Railway Engineering (the "AREMA Manual"), Chapter 33.

#### **9.1.1 THE TRACTION ELECTRIFICATION SYSTEM**

The Traction Electrification System (TES) shall be comprised of three major electrical systems- Traction Power System (TPS), the Traction Power Distribution System (TPDS), and the corridor-wide Traction Power Return System (TPRS).

The design of the 25kV traction electrification system depends on the type of traction power distribution system actually used. The variations possible for the 25kV power distribution system shall include direct feed system or "1x25kV system", and autotransformer system or "2x25kV system".

These design criteria address both systems but assumes that the autotransformer system will be used for the major part of the route, with extremities and yard facilities supplied by direct feed systems.

For the purposes of this design criteria section, track running rails, impedance bonds and rail bonds are considered part of the TPRS, while covered under the signaling system and trackwork design criteria sections.

#### **9.1.2 THE TRACTION POWER SUPPLY SYSTEM**

The Traction Power Supply System shall include Traction Power Substations (TPSS), Autotransformer/Paralleling Stations (APS), and Switching Stations (SWS), and their connections to the Traction Power Distribution System (TPDS) and the Traction Power Return System (TPRS).

The traction power substations shall receive primary power from Utility feeders or taps at transmission levels (115kV or 230kV) and shall include the equipment necessary to step-down the levels to the traction system distribution voltage of 25kV, and the necessary ancillaries and protective systems. Traction power shall be supplied to the traction power distribution system by underground cables or aerial conductors terminated on trackside disconnect switches. Current shall return to substations via permanently connected cables from the running rails.

The autotransformer/paralleling stations shall have switchgear to parallel the Overhead Contact System (OCS) and feeders of multiple tracks, autotransformers (if used), sectionalizing switchgear if the station is located at interlockings, the necessary ancillaries, and protective systems.

The switching stations shall separate the traction power supplies of different phases by phase breaks in the OCS. Switching stations shall have provisions for extending the 25kV supply from one side to the other in the event that supply on one side is not available, such as occurring from a substation failure. The switching station shall have equipment to parallel the OCS of two tracks, autotransformers (if used), and the necessary ancillary and protective systems.

### **9.1.3 THE TRACTION POWER DISTRIBUTION SYSTEM (TPDS)**

The TPDS shall include the OCS and the Autotransformer Feeder System (AFS)

#### **9.1.3.1 THE OVERHEAD CONTACT SYSTEM (OCS)**

The OCS shall consist of an arrangement of steel poles, cantilever assemblies and conductors installed over the rail tracks that deliver the 25kV single phase power supplied by the Traction Power Supply System to the pantographs of the trains.

#### **9.1.3.2 THE AUTOTRANSFORMER FEEDER SYSTEM (AFS)**

The AFS shall comprise bare aerial conductors installed on the OCS poles to supply power to the autotransformers at paralleling stations.

#### **9.1.3.3 STATIC WIRE**

Although part of Traction Power Return System (TPRS), static wires shall be considered part of the TPDS for the purpose of designing structures and assemblies.

### **9.1.4 TRACTION POWER RETURN SYSTEM (TPRS)**

The TPRS shall comprise the track running rails, the rail bonds, the impedance bonds, and the static wires. There shall be no direct connection between OCS poles and track rails except in the areas without track circuits.

Static wires, one for each track, shall be provided from end-to-end to connect all OCS poles, except those installed on passenger station platforms. Only one static wire is required in areas where center poles are used. Static wire shall be electrically connected to the OCS poles by a flexible bond of compatible material. Static wires of the two tracks shall be electrically paralleled at intervals determined by the Grounding and Bonding Study.



Impedance bonds shall be installed at insulated rail joints to allow traction current to flow while blocking signaling currents. Track rails shall be periodically grounded by connection to the static wires at selected impedance bond locations (also known as A-points). Return cables shall connect the running rails to the TPSS return bus at substations and autotransformer/paralleling stations.

Where yard and shop tracks are isolated from mainline tracks, impedance bonds shall be provided at the rail joints for passage of traction return currents.

## **9.1.5 PROJECTWIDE DESIGN CRITERIA**

Design criteria for the development of the TES includes data and criteria from other sections of the design criteria document, such as the following:

### **9.1.5.1 DESIGN CRITERIA – SECTION 4. TRACKWORK**

- Relevant track data including construction and maintenance tolerances, vertical curve data, horizontal curve data, track switch data, maximum track gradients.
- Ballasted-track cross sections, double-track cross sections, retained-track cross sections.
- Structure clearance data. Clearance charts for curvatures in ½” steps of superelevation.

### **9.1.5.2 DESIGN CRITERIA – SECTION 5. STATIONS**

- Side and/or center platform plans
- Side and/or center platform cross-sections
- Details of typical footbridges

### **9.1.5.3 DESIGN CRITERIA – SECTION 6. BRIDGES AND STRUCTURES**

- Catenary Pole Foundations

### **9.1.5.4 DESIGN CRITERIA – SECTION 12. SYSTEMWIDE ELECTRICAL**

- Grounding on passenger platforms
- Grounding of fences

### **9.1.5.5 DESIGN CRITERIA – SECTION 13. COMMUTER RAIL VEHICLE**

- Vehicle dimensional data: Dynamic clearance envelope, spring failure body sway, operational normal body sway, point of sway rotation, lateral shift, wheel wear, etc.

- Pantograph data: Pantograph collector overall width, maximum operating height, minimum operating height range, maximum lockdown height on vehicle, pantograph sway allowance dimension, uplift pressure
- Minimum pantograph spacing in a multiple-car train

#### **9.1.5.6 DESIGN CRITERIA – SECTION 14.7. RIGHT-OF-WAY FENCING AND BARRIERS**

- OCS security fencing criteria along the right of way
- Safety barriers on overpasses above and beside the OCS

## **9.2 FUNCTIONAL REQUIREMENTS**

### **9.2.1 TRACTION POWER**

The TES shall be designed to maintain the voltage at the pantographs and the OCS conductor temperatures within limits specified in AREMA Manual or by the conductor manufacturer. The number, location, and rating of the paralleling stations shall be determined by a computerized traction power load flow analysis which shall also determine the territorial limits of the direct feed (25kV) system and, if selected, autotransformer feeder (2x25kV) system.

The TPS shall supply 25kV power to the OCS and to the Autotransformer Feeder System (AFS) via disconnect switches installed at trackside gantries with separate feeds for inbound and outbound tracks.

The TPS shall be designed for full redundancy, such that the loss of any one major item of equipment or feeder will not result in degradation of train schedules in any corridor. There shall be at a minimum, two traction power substations (TPSS), each supplied by different Utility substations such that a complete loss of a TPSS or Utility substation shall not preclude train operations at the specified reduced level of performance in any corridor.

For a 2x25kV system, APS shall each have at least one autotransformer and Switching Station at least two, one for each side of the phase break.

The TES shall be designed for a minimum functional life expectancy of forty (40) years.

### **9.2.2 POWER DISTRIBUTION**

The OCS shall be designed to ensure spark-free current collection by multiple-unit train consists with each train having multiple pantographs in use at any one time. Train consists considered in designs shall include both initial maximum train length and any future maximum train length specified by RTD for the route.

There shall be no high-voltage interconnection between the pantographs.

The design of phase breaks shall permit operation of randomly marshaled train consists with various pantograph separations.

AFS conductors shall be located adjacent and parallel to the OCS to optimize mitigation of their electromagnetic fields and reduce inductive interference in communications lines. Electrical clearance suitable for 50 kV shall be provided between the OCS and feeder.

### **9.2.3 OCS SECTIONING**

The system sectioning shall be designed to allow isolation and de-energization of parts of the TPDS to permit planned maintenance, to isolate faulted sections, and to permit flexible operation during system emergencies.

Where they are installed, OCS conductors and each autotransformer feeder circuit shall form part of a single circuit, and shall be sectionalized together by 2-pole circuit breakers and 2-pole disconnect switches.

Schematic Sectioning Diagrams shall show diagrammatically the relative location of all tracks, interlockings, fixed signals, passenger stations, substations, and switching and paralleling stations. For each track with OCS, a single line shall be shown with its phase breaks and sectioning points. Unwired turnouts shall also be shown and identified as such.

Normal position of the circuit breakers and disconnect switches, open or closed, shall be shown. The normal method of operation of each motorized or hand-operated disconnect switch shall be indicated. All circuit breakers and disconnect switches shall be identified for operating purposes by a serial number unique within the RTD LRT and the CR systems.

#### **9.2.3.1 MAINLINE**

OCS sectioning on the mainline shall utilize insulated overlaps suitable for 25kV.

#### **9.2.3.2 CROSSOVERS, TURNOUTS AND YARDS**

Bridging section insulators shall be used for:

- Crossovers and turnouts that are not used during normal revenue service
- Main lines when the maximum operating speed is limited to 30 mph
- In yard areas

#### **9.2.3.3 PHASE BREAKS**

A design shall be produced that integrates OCS, vehicle and track details to permit commuter rail vehicles to routinely operate through each phase break without impacting train service. Phase breaks are required at substations, switching stations and locations where adjacent sections of the traction power distribution system are supplied by different electrical phases.

Phase breaks shall not be located:

- where trains require high current draw or regeneration capabilities
- in braking or stationary zones on the approach side of signals at interlockings
- on sharp curves and steep gradients

With consideration given to minimum and maximum pantograph spacing, it is preferred that the electrical separation at a phase break be provided by either:

- Long phase break consisting of multiple insulated overlapping spans
- Short phase breaks with grounded center, and with inbuilt vacuum circuit breakers to extinguish arcs caused by current drawn by each commuter rail vehicle

Train operators shall be instructed to reduce power demand before traversing phase breaks. Details of the operating procedures shall be determined during detailed design in coordination with RTD.

#### **9.2.3.4 INTERLOCKED SWITCHING**

Yards and shops shall be provided with interlocked arrangements of disconnect switches to protect or warn maintenance staff from approaching or touching ungrounded wiring above rail vehicles. Such design shall be site specific and support the safety procedures, equipment and features developed and approved for such operations.

Typically, interlocked switching equipment may include safety mechanisms preventing access to the OCS unless it has been de-energized and providing audible and visible warning before being energized.

#### **9.2.4 REMOTE OPERATIONS**

Substations, switching and paralleling stations, circuit breakers, and motor-operated disconnect switches, shall be designed for remote operation from the Commuter Rail Operations Control Center. Local operation of individual equipment shall be possible via control switches.

### **9.3 TES DESIGN REQUIREMENTS**

For reasons of practical support dimensioning and strength rating, aerial feeder wires, static wires, and pole-mounted disconnect switches shall be considered to be part of the OCS design, specification, and construction.

Impedance bonds and rail bonds shall be considered part of signaling systems and trackwork design and specifications, respectively.

## **9.3.1 TRACTION POWER SUPPLY SYSTEM**

### **9.3.1.1 LOCATION OF SUBSTATIONS (TPSS), AUTOTRANSFORMER/PARALLELING STATIONS (APS), AND SWITCHING STATIONS (SWS)**

TPSSs shall be located close to a Utility transmission substation or transmission line, to minimize the required length of the transmission line interconnections. The number and location of substations, switching stations, and autotransformer/paralleling stations shall be confirmed by the Traction Power Systems Studies and after site surveys determine the site suitability. Sites shall have good vehicular access and availability of real estate.

### **9.3.1.2 PRIMARY POWER SUPPLY**

Primary electrical power supply shall be obtained from the Utility at either 115kV or 230kV, 60 Hz, via two separate circuits for redundancy. Each primary feeder shall be either by overhead connections or underground cables, as agreed upon with the Utility. Each feeder shall utilize a different phase pair unless otherwise agreed by the Utility.

Service details and AC protection scheme shall be coordinated with the Utility.

### **9.3.1.3 TRACTION POWER SYSTEM DESIGN STUDIES**

The TPSS design shall be based on a computer-aided traction power load flow simulation. This study shall simulate peak-hour operation of the trains along each commuter rail corridor under normal and contingency conditions.

Contingency conditions shall include outage of one major item of equipment, such as a transformer or feeder cable, or of an incoming electrical feed, at a substation or outage of one paralleling station at a time or outage of a section of track. Trains consisting of the ultimate consist size shall be simulated to operate on the corridor at the ultimate corridor headways, or as otherwise specified by RTD, with the cars loaded to AW3. In the event of a complete substation outage, the remaining substation(s) shall provide power to all corridors to allow for restricted train operations. The acceptable level of service reduction shall be coordinated with and approved by RTD.

The input data shall include track alignment including interlockings, track gradients, track speed limits, passenger station locations and station dwell times, as well as the electrical and mechanical characteristics of the trains.

The input data shall represent electrically the Utility interconnections, the TPS, autotransformer/paralleling stations, and the OCS and traction return conductors.

The study shall determine voltage at train pantographs, power demand at the substation (both primary and secondary side) and at autotransformers, bus currents at TPSSs, APS, and SWS; equipment ratings, including sizes of feeder cables, autotransformer feeders; and OCS conductor sizes and temperature rises.

The study shall confirm that for the final selected equipment ratings and conductor sizes, the voltage at the pantograph, conductor temperature and rail potential rise remain within the specified design parameters under normal and contingency conditions.

Additionally, the following system studies shall also be performed:

- Utility Impact Study – performed by, or in coordination with, the Utility to determine the impact of single phase traction loads on the utility grid and any necessary corrective measures
- Short Circuit and Protective Relay Study – to determine the requirement and settings of protective relays
- Insulation Coordination Study - to determine the minimum acceptable insulation levels for the equipment, buses, and the surge arresters ratings
- EMI Study - to determine the impact of the single phase AC traction loads on the trackside signaling and communication installations and any necessary corrective measures
- Grounding and Bonding Study - to determine the requirements for grounding and bonding of the system, overhead structures, and trackside installations

#### **9.3.1.4 RESULTS OF DESIGN STUDIES**

The output data of the load flow analysis shall provide train operational data such as speed, distance traveled, voltage profile, current in OCS conductors, power demand and energy consumption for each station-to-station run. For the TPSS, the results shall include average power and power factor on the primary and secondary sides, energy consumption, primary current, and current for each feeder and OCS breaker.

#### **9.3.1.5 OCS AND FEEDER CONDUCTOR SELECTION**

Minimum sizes for the OCS and feeder wires and cables shall be determined based on the results of the load-flow analysis. The final selection of the messenger wire, contact wire and feeder wire sizes may be marginally larger/stronger than the electrical system design studies determine, and shall be made with consideration of possible mechanical, economic and maintenance impacts.

The selected wire sizes shall be confirmed to be suitable by the OCS mechanical dynamic simulation studies detailed in 9.3.3.3.

### **9.3.1.6 SUBSTATION EQUIPMENT RATINGS**

The continuous rating of the TPS equipment such as the traction transformer, circuit breakers and cables shall be based on the traction power load flow simulation. Transformers and other equipment shall have overload rating per Chapter 33 of the AREMA Manual. Equipment shall be capable of sustaining such an overload twice a day, once in morning peak and once in the evening peak periods.

### **9.3.1.7 SUBSTATION EQUIPMENT**

Each half of a TPSS shall be capable of meeting the power requirements of the entire corridor during contingency operations. Each half shall have a primary supply with HV switchgear, one traction power transformer, one lineup of 25kV switchgear with a normally-open tie circuit breaker, and one station supply transformer.

In the event the maintenance shop is supplied directly from a substation or a switching station, a dedicated circuit breaker with protective relays shall be provided to prevent tripping of the mainline power in the event of fault in the yard and/or shop.

All traction power and distribution system equipment shall be designed taking into account the effects of the harmonic content of the traction loads, fluctuating pattern of the traction currents, and frequent system faults. The traction power substation(s) shall, at a minimum, meet the harmonic requirements of IEEE 519 at the point of common coupling with the Utility.

### **9.3.1.8 SUBSTATION EQUIPMENT LAYOUT AND LOCATION**

High voltage (115kV and 230kV) buses and switchgear, traction transformers, auxiliary power transformers, and harmonic filters (if provided), shall be installed outdoors in a switchyard, wherever not disallowed by site constraints. Location of 25kV switchgear, indoor or outdoor, shall be determined by relative cost and site constraints. Where located indoors, equipment shall be suitable for installation inside buildings with appropriate enclosures or safety barriers. 25kV switchgear shall be metal clad of arc resistant construction per IEEE Std. C37.20.07 with vacuum interrupters. Where located outdoors, 25kV breakers shall be vacuum types, dead tank construction, pole or pedestal mounted. High voltage circuit breakers shall be of the SF-6 type, preferably of dead-tank construction, pedestal mounted.

Equipment layouts for TPSS shall accommodate the equipment necessary for the interconnecting voltage. AT TPSS locations where it is determined that the utility will raise the interconnection voltage in the future, the layout shall identify the additional TPSS space that would be required on site or on an adjacent site.

If 25 kV breakers are located outdoors, control equipment, Remote Terminal Unit (RTU), batteries, and battery chargers shall be installed in a prefabricated building. 25kV disconnect switches shall be installed on track-side gantries.

#### **9.3.1.9 TRANSFER TRIP CABLES**

Transfer trip circuits, if required, shall use a pair of fibers on the communication cables.

#### **9.3.1.10 SUBSTATION SITE ACCESS, GRADING AND DRAINAGE**

A 15-foot (minimum) wide access road shall be provided to each substation, switching station, and paralleling stations from adjacent roadways, leading to a public roadway. The access road shall be surfaced with gravel or asphalt and shall not exceed 7% grade. The surfacing material shall be as recommended by a Geotechnical Engineer or as required by local jurisdictions.

A minimum clearance of 10 feet shall be provided, where practicable, around the perimeter of each substation to permit access for RTD and maintenance vehicles and equipment. Clearance width may be reduced at one side of the substation with approval from RTD. A 96-inch (minimum) high chain link fence or non-scalable wall shall be provided around the perimeter of the substation with a vehicular gate at the access drive.

The fenced area shall be generally flat with finished grade sloping away by a minimum of 2% from the building. Crushed stone or gravel (1.5 inch minimum) shall be spread in the switchyard and four feet outside the fence to minimize step and touch potentials.

Adequate drainage and infrastructure for handling storm water shall be provided in compliance with local and state requirements. Ductbanks within the substation shall slope downward into a manhole, which shall be the lowest point, to prevent leakage of water in the cable vault of the substation building. Manholes shall be provided with French drains.

Oil filled transformers and autotransformers shall have sumps or other means to collect oil and prevent it from contaminating soils or reaching drains or surface run offs per IEEE Standard 980.



### **9.3.1.11 LIGHTNING AND SURGE PROTECTION**

Traction power substations, switching stations, and autotransformer/paralleling stations shall have adequate protection against lightning by shield wires or lightning masts per IEEE Standard 998. Additionally, surge arresters shall be provided, at a minimum, on the transformers, disconnect switches and cable terminations. Arrester ratings shall be selected from the results of the insulation coordination study.

### **9.3.1.12 EMERGENCY SHUTDOWN**

Emergency shutdown devices shall be provided for quick de-energization of energized equipment for personnel safety at maintenance facilities and, where required by the local fire department, for firemen's use while responding to an emergency.

Traction substations and autotransformer/paralleling stations shall be provided with emergency pushbuttons inside control buildings and outside at one or two conspicuous locations to de-energize the entire site.

Location of the pushbutton and circuits to be de-energized shall be determined during detail design in consultation with RTD.

### **9.3.1.13 MAINTENANCE FACILITY – POWER SUPPLY**

Maintenance facilities shall be powered from one or more feeder breakers at a substation or switching station with an alternate emergency feed, interlocked to prevent simultaneous supply from more than one source.

### **9.3.1.14 INSULATORS**

Solid core porcelain or composite insulators consisting of a Fiberglass Reinforced Epoxy (FRE) core with weather-resistant sheds to applicable ANSI standards shall be used. Disc insulator assemblies shall be used in tension only. Creepage lengths shall be determined during detail design on the basis of environmental conditions.

The insulators shall have resistance against deterioration from exposure to sunlight and airborne chemical pollution, and in particular mist deposits from highway de-icing chemicals. The insulators shall be a light gray, sky tone in color and their life expectancy shall be compatible with that of the rest of the equipment.

### **9.3.1.15 PROTECTIVE RELAY SYSTEMS**

Protective systems for the OCS and feeders shall be designed to detect and isolate faults on any section, and coordinated to prevent cascading trips. Relays shall be coordinated to open circuit breakers to de-energize the minimum possible OCS length to isolate the fault. Protective relays shall be of the microprocessor type. Protective relays for the transformers and autotransformers shall provide protection against internal and external

faults, overloads and short circuits, gassing and sudden pressure in the track, and low oil level.

## **9.3.2 TRACTION POWER FEEDERS AND RETURN CABLES**

### **9.3.2.1 25KV FEEDERS**

25kV power from the TPS shall be delivered to the 25kV disconnect switches installed on trackside gantries or on OCS structures by underground cables or aerial conductors; and from the 25kV disconnect switches to the OCS and to the AFS, by bare overhead feeders.

Overhead bare feeder wires shall be copper or aluminum alloy conductors and sized based on the traction power studies.

### **9.3.2.2 RETURN CABLES**

Return cables installed in ducts shall connect the running rails to the transformer or autotransformer neutral via impedance bonds.

Cable size(s) shall be based on traction power studies and the selected type of raceway.

## **9.3.3 OVERHEAD CONTACT SYSTEM (OCS)**

Refer to Table 9-3 for a summary of design values to be applied.

### **9.3.3.1 OCS STYLES**

The OCS shall be applied from the following styles according to application:

For mainlines, mainline crossovers, and yard lead tracks to mainlines – Auto-tensioned Simple Catenary style (ATSC)

For Yard tracks, inside shop, and shop approach tracks - Fixed Termination Simple Catenary style (FTSC) or Fixed Terminated Single Contact Wire style (FTSCW)

Where a long storage yard track is to function as a test track – Auto-tensioned Simple Catenary style (ATSC)

#### **9.3.3.1.1 AUTO-TENSIONED SIMPLE CATENARY STYLE (ATSC)**

ATSC shall consist of a messenger wire supporting a contact wire by the means of hangers. Each messenger wire/contact wire pair shall be arranged into Tension Lengths which overlap at each end with neighboring tension length to provide a continuous, smooth contact path for the vehicle pantograph.

The ATSC wires shall be tensioned by means of suspended weights, called balance weights assemblies, which shall be installed on the anchor poles located at the ends of each tension length. As the wires contract and expand with temperature variation, the balance weight assemblies shall be designed to maintain a constant wire tension throughout the specified temperature range.

Suitable mid-point anchor or fixed end anchor arrangements shall be installed in each tension length to prevent accumulation of along track movement in the tension length.

Along-track movement of the wires due to temperature change shall be facilitated by all support and registration assemblies for ATSC style wiring.

The contact wire profile shall be designed for no ice cover, and the wire temperature within the designed operating temperature range of the balance weight anchor assemblies.

The contact and messenger wires shall be offset or staggered at registration points to provide for even wear of pantograph collector carbons.

This style of OCS wiring shall be designed to provide spark free current collection up to the maximum design train operating speed plus an allowance of 10% for over speed.

On tracks designed to operate with train speed limits of 50 miles per hour or higher, ATSC wiring shall feature a scheme to limit the effects of pantograph uplift variation within each span. Such a feature could be either a contact wire pre-sag factor applied to the wire profile, or a stitch wire messenger wire support arrangement, but not both concurrently.

#### **9.3.3.1.2 FIXED TERMINATED SIMPLE CATENARY STYLE (FTSC)**

FTSC wiring shall consist of a messenger wire supporting a contact wire by the means of hangers. The contact wire shall be without sag at the normal temperature of 60°F. The catenary conductors shall be tensioned to anchor poles located at the ends of each tension length. Conductor tensions will vary with change of temperature causing the messenger wire sag to change resulting in the contact wire sagging also. These changes together with ice loading of the conductors will also cause the contact wire to sag or hog in span. In order to limit these height variations, span lengths shall be limited to about 75% of maximum spans allowed for ATSC system. The selected maximum span length for FTSC shall be determined by analysis.

### 9.3.3.1.3 FIXED TERMINATED SINGLE CONTACT WIRE STYLE (FTSWC)

FTSWC shall be used in the maintenance shop. In this fixed-terminated system, the conductor tension will vary as temperature changes. This arrangement utilizes a single contact wire supported by pole or building mounted assemblies.

### 9.3.3.2 ENVIRONMENTAL CONDITIONS

In addition to ambient conditions given in Section 1 of these Design Criteria, the following conditions shall apply to the Traction Power Distribution System:

Conductor temperatures:

- Normal 60° F
- Minimum -25°F
- Maximum 125°F for contact wire and messenger wire under all Operating Conditions
- Maximum 160°F for electrical connections and all other wires.

Conductor ice loads:

- Operating Conditions

½ inch ice on the messenger wire

¼ inch ice on the contact wire

- Non-Operating Conditions

½ inch ice on the messenger, feeder and static wires

½ inch ice on the contact wires

Wind:

- For train Operating Conditions – 55 mph wind
- Under Non-Operating Conditions – 90 mph to 120 mph as required by local codes

The RTD operating region traverses into a Special Wind Zone as declared in NESC. The designers shall familiarize themselves with each wind zone declared by local governments having jurisdiction over each segment of route.

Where RTD routes are adjacent to roads, chemicals such as magnesium chloride and salt may be applied to deter ice. In such localities, a polluting spray environment may settle on and adhere to the TPDS equipment. Material selection and insulator creepage path lengths shall be selected appropriately. The region in which RTD operates is frequented by various animal and bird species identified for protection under federal codes. Applicable codes and related guidelines shall be considered when determining requirements in the design, and in installation and maintenance practices.

### **9.3.3.3 OVERHEAD CONTACT SYSTEM DESIGN STUDIES**

The design parameters and values for the OCS shall be based on engineering studies. Basic design, as expressed below, is to provide a set of detailed parameters for application in site specific design of the OCS for the project.

#### **9.3.3.3.1 STUDY CONDITIONS**

Two named conditions exist to generally categorize combinations of environment for application to the various study calculations and any subsequent detailed design. Multiple combinations may exist for each named condition.

Operating Conditions describe one or more combinations of ambient temperature, wind and the presence of ice under which the OCS shall be designed to permit the normal operation of trains.

Non-Operating Conditions describe one or more combinations of ambient temperature, wind and the presence of ice, and with no trains operating, under which the OCS, AFS and Static wires, poles and all associated equipment shall remain within their safe working tensions and loads. A typical application for Non-Operating Condition values is for determination of the minimum mechanical strength of OCS equipment and wiring.

#### **9.3.3.3.2 CONDUCTOR SIZES AND TYPES**

Contact wire, messenger wire, auto-transformer feeder wire and static wire type determined by the Traction Power System Design Study, and shall be selected to provide a practical and economic configuration of the OCS and AFS suitable for the environmental conditions, the electrical requirements, normal and emergency operations and ease of maintenance.

#### **9.3.3.3.3 CONDUCTOR TENSIONS**

Conductor tensions for each style of OCS shall be determined to meet requirements of minimum strength and factors of safety suitable for the Non-Operation Conditions, and NESC.

The OCS, AFS and Static Wires are to be considered as NESC Grade C construction for these purposes.

Maximum conductor tensions shall comply with NESC Rules 261H and referenced Rules 250 and 251. Selection of conductor tensions shall include consideration of the effect of Aeolian vibrations.

Maximum and minimum wire tension calculations shall be made for the expected range of equivalent span lengths within the Commuter Rail System.

Normal wire tension shall be at 60°F for each wire type for calculation purposes.

Tensions for normal and worst case conditions shall be documented in tabular form in the project drawings.

#### **9.3.3.3.4 MAXIMUM TENSION LENGTH**

The maximum tension length shall be determined based on:

- Along-track movement of in-running cantilevers
- Stagger change
- Balance weight travel
- Tension variation
- Manufacturing limits on conductor length
- Number of cantilevers in one tension length

The results of this study shall be given in basic design charts included in the project drawings, providing the maximum distance from mid-point or fixed termination to the last in-running cantilever and to the balance weight anchor pole.

Normally, the tension length shall not exceed one mile.

#### **9.3.3.3.5 SPAN LENGTH AND MID SPAN OFFSET**

The OCS design study shall include calculations that take into account all factors that contribute to horizontal and vertical displacement of the contact wire with respect to the pantograph.

This study is required for each OCS style for each normal and maximum contact wire height as shall be applied to the project.

The study shall include calculations for the following:

- Maximum structure spacing as a function of track curvature
- Conductor blow-off
- Permissible midspan static offset for contact wire spans over tangent tracks
- Permissible midspan static offset for contact wire spans over curved tracks
- Conductor along-track movement with temperature variation, and resulting stagger variation
- Pantograph security analyses for selected contact wire heights

The results of each study shall be given in basic design charts and graphs included in the project drawings.

#### **9.3.3.3.6 ATSC DYNAMIC PERFORMANCE STUDY**

An OCS/pantograph dynamic study to verify the suitability and stability of the specific combination of wires types, tensions, span lengths, hanger arrangements and pantograph dynamic properties to be used for ATSC style equipment.

Any report arising from such a study shall be submitted to RTD for review.

#### **9.3.3.3.7 CATENARY HANGERS**

Hanger spacing schemes shall be prepared for:

- Standard spans
- Overlap spans
- Anchor spans
- Spans with section insulators

Where appropriate ATSC spans shall be designed to account of contact wire presag or messenger wire stitch features.

Results shall be provided in tabular form in the project drawings.

#### **9.3.3.3.8 MINIMUM STRUCTURAL LOADS ON LIVE FITTINGS**

A minimum mechanical load criteria shall be determined for assemblies energized at 25kV or higher, to mitigate the effects of charging sparks being generated by loose joints. The criteria shall consider the effects of permanent loads and reverse direction wind loads.

#### **9.3.3.3.9 CONTACT WIRE STAGGERS**

Maximum stagger calculations shall be prepared using 50% of all allowances made for pantograph security calculations. Maximum stagger shall be determined by subtracting the 50% allowance total from the half width of the pantograph carbons.

Maximum stagger values shall be calculated for curved track and for tangent track for both normal contact wire height, and for maximum contact wires height.

#### **9.3.3.3.10 PANTOGRAPH CLEARANCE ENVELOPE**

A pantograph clearance envelope shall be developed for application on all tracks including super elevation, for the worst case track conditions and full vehicle roll plus a 3-inch mechanical running clearance.

No live 25kV equipment, except OCS steady arms attached to the contact wire, shall intrude into the pantograph clearance envelope.

No grounded equipment or 25kV equipment of another circuit shall intrude within Passing Clearance distance of the pantograph clearance envelope.

#### **9.3.3.3.11 CONDUCTOR CLEARANCES**

Minimum clearance dimensions shall be determined between each type of conductor or live fitting and adjacent equipment.

Clearances shall be developed in accordance with NESC, and consider the following:

- Relative differences in sag at mid span where one conductor is vertically above the other.
- Sufficient clearance for circuit of one track to be alive while maintenance is being performed on an adjacent circuit.
- Position of static wire to provide shielding of wiring below.



### **9.3.4 OCS ROUTE DESIGN**

A route design shall be prepared to show at a low level of detail, the arrangement of each tension length of OCS to be built or altered.

The route design shall take into consideration fixed locations for phase breaks, insulated overlaps, station crossovers, low clearance buildings and bridges, and any infrastructure features preventing the placement of wiring terminations.

Live conductors shall not be installed above passenger platforms or buildings.

To improve operational options following wiring damage incidents, the OCS wires of individual mainline tracks should be routed to service only one track of that route. Tension lengths servicing crossover tracks or yard leads should be independent of mainline wiring.

The results of the OCS route design shall be documented on a Master Overlap Chart. Refer to 9.3.16.2.1.

### **9.3.5 OCS WIRING ARRANGEMENTS AT OVERLAPS, TURNOUTS AND PHASE BREAKS**

For ATSC and FTSC, the OCS shall consist of a number of tension lengths with overlapping ends where the two catenaries are parallel and share a common span, called an 'overlap' or 'overlap span'.

Individual tension lengths of catenary shall be terminated at each end by balance weights or by fixed terminations, as necessary. A 'full tension length' has a balance weight assembly (BWA) at each end of the tension length and a midpoint anchor assembly (MP) midway between the two tensioning devices. A 'half tension length' has a fixed termination assembly (FT) at one end and a BWA at the other.

For auto tensioned style wiring, if the track has an average continuous gradient exceeding 2%, the wiring shall be arranged into 'half tension lengths' with the BWA located on the lower end.

The contact wire heights at overlaps, turnout and phase breaks shall be designed considering the mechanical properties of the OCS and pantographs. The design shall enable a smooth transition between adjacent contact wires without hard spots, by equalizing the contact wire heights over approximately 10 to 15 feet of track.

The two catenaries at overlaps and turnout shall be configured using pairs of poles each with one cantilever carrying one catenary and spaced 10 feet apart.

### **9.3.6 CLEARANCE BETWEEN BRIDGES OR BUILDINGS AND OCS**

Where a bridge or building structure exists or is to be built over a track that is to be wired, normal minimum clearance requirements shall be determined from Figures 9.1 or 9.2 based on the maximum rail vehicle type authorized to travel on that track, and on the permission or otherwise of the structure owner, for the OCS, AT Feeder wires or Static Wire to be attached to the bridge or building.

Should the structure designer require smaller clearances than shown these diagrams, then the OCS designer shall prepare a detailed design for the OCS, feeder wires and static wire in collaboration with the structure designer.

Should the OCS designer require OCS, AT Feeders or static wires to be located outside the clearance outline described by these diagrams, or within electrical clearance of the outline, then the OCS designer shall prepare a detailed design for the OCS, feeder wires and static wire in collaboration with the structure designer.

### **9.3.7 BRIDGES AND BUILDINGS OVER THE TRACK**

A clearance study, showing plan and profile of OCS and feeders, shall be made for each overhead bridge and structure. The study shall document the minimum clearances between OCS conductors and the structure under worst conditions. Such studies shall consider clearance requirements due to adjacent grade crossings, public pedestrian crossings, and other features requiring high contact wire heights.

### **9.3.8 CONTACT WIRE DIMENSIONING**

#### **9.3.8.1 CONTACT WIRE HEIGHT**

Limits on contact wire height are affected by a very wide variety of values for track tolerances, weather, vehicle size and local conditions at along each route.

Table 9-1 below provides minimum contact wire height values for input into OCS designs based on safe clearance of energized ice covered wires. Minimum heights shown do not include the vertical effects of track superelevation.

These values are to be utilized by an OCS designer for development of site specific design height for contact wire for installation and for coordination with other design elements such as bridges and grade crossings.

**TABLE 9-1  
CONTACT WIRE HEIGHT**

Condition	Minimum Permissible As built Contact Wire Height anywhere in span, with ½" Ice, above designed rail level.
Exclusive use ROW, RTD Commuter Rail vehicles only, ballasted track	17'-2" ***
Exclusive use ROW, over Amtrak Code D vehicles and RTD Commuter Rail vehicles only, ballasted track.	20'-9"***
Tracks shared with freight railroad	23'-7"*** ++
Under bridges or buildings, RTD Commuter Rail vehicles only	16'-3"***
Under bridges or buildings, over Amtrak Code D vehicles and RTD Commuter Rail vehicles only	20'-8"***
Under bridges or buildings, tracks shared with freight railroad	22'-8"***
Station Platforms, RTD Commuter Rail vehicles only	16'-0"*
Crossing at-grade with a public road	21'-7"***
Public Pedestrian Crossing at-grade	19'-7"***
Maintenance Building	22' - 0" ++
Storage tracks	21'-7"***

\* Includes provision for restricted track construction and maintenance tolerances totaling up to 1.5 inches

\*\* Includes provision for restricted track construction and maintenance tolerances plus allowances for track surface limit and cross level deviation effects totaling 5 inches

\*\*\* Includes provision for future track level raising maintenance tolerance plus allowances for track surface limit and cross level deviation totaling 15.4 inches.

++ Reduced value may be permitted on a location specific basis. RTD approval is required for any deviation in the minimum contact wire height shown based on a documented Safety Case.

Under no circumstances shall the as-built contact wire height exceed 25 feet 7 inches relative to the design track level. This value results in a maximum pantograph operating height of at least 25 feet 11.5 inches above actual rail level, and is derived from assumed track level construction and maintenance tolerances of -2.5 inches and vehicle dynamic bounce downward of 2 inches

Only authorized persons shall be permitted in locations where contact wire is less than 19 feet 7 inches with or without ice cover.

For open route mainlines the preferred design height for contact wire is in the range 21 feet 0 inches to 23 feet 10 inches.

### 9.3.8.2 CONTACT WIRE GRADIENT

The pantograph shall track smoothly under the contact wire at all times. Where the contact wire height needs to be changed, the change shall not cause bouncing and arcing of the pantograph.

Table 9-2 provides recommendations from the AREMA Manual for Railway Engineering for the maximum wire gradient versus train speed ranges. Contact wire gradient values are to be applied relative to the track plane.

**TABLE 9-2  
MAXIMUM WIRE GRADIENT VERSUS LINE SPEED**

Speed Range (mph)	Maximum Gradient (%)
1-15	2.3
15-30	1.3
30-45	0.8
45-55	0.6
55-65	0.5
65-79	0.4

### 9.3.8.3 CHANGE OF CONTACT WIRE GRADIENT

The maximum change of contact wire gradient shall be equal to one-half the maximum gradient, from one span to the next.

### 9.3.8.4 CONTACT WIRE STAGGER

The contact wire shall be staggered except in the maintenance shop where no stagger is needed.

The largest acceptable stagger shall be selected at each contact wire registration, with the proviso that the maximum midspan offset for the specific span is not exceeded. Additionally maximum stagger values shall be in accordance with 9.3.3.3.9.

The angle of contact wire deviation on a single steady arm shall not exceed 7 degrees.

On tracks designed to operate with trains speed limits of 50 miles per hour or higher, span lengths and stagger values shall be selected to provide a Stagger Sweep Rate of between 0.24% and 0.80% of span length.

### **9.3.9 FOUNDATIONS**

The design of foundations for supporting structures and guy anchors shall be based on the structure loading calculations and soil data. The supporting structure foundations shall be designed to accept bolted base poles. Refer also to the requirements of Section 6, Bridges and Structures.

The size and placement of the OCS foundation anchor bolts shall be in accordance with RTD's previously installed OCS foundation designs. Deviation from the existing designs will require prior approval from RTD.

### **9.3.10 POLES AND PORTALS**

The OCS along mainline route and in the yards shall preferably be supported and registered by means of poles with cantilever assemblies, and where poles are not appropriate, by use of portal structures. In the shop, the OCS shall be attached to the building structure.

All poles shall be designed as free standing except for those anchoring OCS, static wires or feeder wires. All poles shall have provision for securely connecting grounding or bonding conductors near their base plate.

Pole and portal column base plates shall be designed and drilled to prevent a high strength type of pole being inadvertently erected onto a foundation designed for a weaker pole or column.

Structures shall be designed so that the normal operating across-track live load deflection of any structure shall not exceed 2 inches at contact wire height, i.e. one inch in either direction laterally.

OCS poles shall be designed and with a size range selected to minimize the spare quantities required to be held in maintenance stock.

OCS portals shall, if practical, use portal columns of the same steel sections as OCS poles.

### **9.3.11 CLEARANCE OF POLES AND FOUNDATIONS FROM TRACK**

Poles shall be horizontally clear of superelevated track centerline as required by Design Criteria Section 4. OCS poles and columns shall be considered non structural objects for clearance purposes.

Designed pole face horizontal offset dimensions shall include additional allowances for foundation bolt construction tolerances, across track live load pole deflection, pole rake and encroachment of assemblies attached to the pole. Tolerances and allowances shall be considered up to contact wire level.

Typically for 14 inch wide poles constructed between tracks, 20 inches of gap will be required between the minimum trackway clearance lines. Reference Section 4.2.5 Clearances.

OCS foundations shall be designed to be horizontally and vertically clear of minimum trackway clearances by the applicable foundation construction tolerances.

Reduced clearance values may be permitted on a location specific basis. Written RTD approval is required for any deviation from the minimum clearances.

### **9.3.12 OCS SUPPORT REQUIREMENTS**

#### **9.3.12.1 MAINLINE**

For mainlines, a principle of independent registration shall be applied whereby a single failure of OCS wiring on one mainline track shall not prevent a parallel mainline from being operated. This generally requires that each OCS wire be supported from cantilever assemblies only, and that pulloff assemblies or span wires service one track only.

Auto tensioned OCS shall be supported on hinged cantilevers in turn supported by poles or by portal structures with grounded drop pipes between each track.

Headspan construction shall not be employed without the express site-specific approval of RTD.

#### **9.3.12.2 YARD**

The FTSC shall be supported on cantilevers mounted on galvanized steel tubular or wide-flange poles installed clear of access paths, between tracks where feasible.

Where poles are not feasible, galvanized portal structures shall be installed to carry cantilever frames on grounded drop pipes.

Headspan construction shall not be employed without the express site-specific approval of RTD.

#### **9.3.12.3 MAINTENANCE SHOP**

The FTSCW shall be supported from and anchored to the shop structure.

#### **9.3.12.4 SUPPORT SPACING**

Spacing for the OCS supports shall be as large as possible consistent with the required system height, ice-loading criteria and maximum permissible midspan offset values.

For mainline wiring, where adjacent wire span lengths differ, the larger span length shall not exceed 150% of the length of either adjacent spans, except with written site-specific approval of RTD.

#### **9.3.13 TYPES OF OCS SUPPORTS**

##### **9.3.13.1 CANTILEVER SUPPORTS**

Cantilevers mounted on poles or portals shall be designed for a range of loads, various cantilever reaches, and for a range of system heights. The permissible range of loads, heights and reaches shall be shown on the relevant assembly drawings.

##### **9.3.13.2 CROSS SPAN WIRES**

Cross-span wires may only be used between grounded drop-pipes and portal columns, where the catenaries are in the same electrical section.

Span wire insulation shall be installed between tracks supplied from the same electrical section.

##### **9.3.13.3 PULLEY SUPPORTS**

Pulleys may be used to indirectly support an auto-tensioned messenger wire by including of an intermediate supporting bridle wire assembly support from the pulley suspension. Due to the effects of abrasion and work hardening, copper wire shall not be run over a pulley.

##### **9.3.13.4 SUPPORTS UNDER BRIDGES AND BUILDINGS**

Where tracks pass under bridges and buildings, preferably OCS and ATF under bridge support assemblies shall be mounted on poles erected under the bridge or building. Special support assemblies mounted on short poles shall be used where there is insufficient clearance to accommodate an open route cantilever-type assembly. The supports shall be designed to restrict the uplift of the contact wire when subjected to pantograph pressure. They shall be capable of providing vertical and across-track adjustment of wiring position.

Support assemblies shall permit the full range of along track movement of auto tensioned contact wire and messenger wire.

When a pole is impractical, under bridge supports may be attached to the soffit of the bridge or building by drop pipe assemblies, on a site-specific basis approved by RTD and with written approval of the bridge owner.

Grounded flash plates shall be installed above each wired track under each bridge or building. Refer to 9.4.9.

AT Feeder support assemblies shall be arranged to provide maintenance and operational clearances to structures, vehicles and adjacent wiring.

#### **9.3.13.5 SUPPORT CLEARANCES**

Sufficient electrical and mechanical clearances shall be maintained between adjacent cantilevers and between the cantilever frames and adjacent conductors of the auto-tensioned catenaries at all temperatures.

#### **9.3.14 CONTACT WIRE REGISTRATIONS**

The designer shall develop contact wire registration sub-assemblies to suit the required loading range and dynamic performance requirements of each OCS style.

Direct push steady arms or assemblies that push the contact wire shall not be applied to in-running ATSC style OCS.

Steady arm shapes and dimensions shall be designed to clear the pantograph over the full range of dynamic movement and track superelevation. The application of light weight high strength materials to sub-assemblies shall be considered.

For registrations where the permanent radial load is less than the reverse direction wind load, wind stay sub-assemblies shall be considered for application to steady arms.

Application rules and dimensions shall be developed for setting the heel height of steady arms that consider the style of OCS and loads being applied to the contact wire.

For design purposes of the various sub assemblies, the designer shall develop an assembly type grouping scheme based on a common parameter such as radial load.

#### **9.3.15 INSULATION**

All OCS support and registration equipment, span wire and termination assemblies shall be single insulated, except where additional insulation is required at stations and certain overbridge attachments.

Where span wires are utilized, span wire insulation shall be installed between all tracks even if supplied from the same electrical section.

Where OCS or feeder wires are adjacent to a passenger platform, OCS and ATF support assemblies shall have their high voltage insulators placed with live components horizontally off the platform. Additionally, where the static wire is required to be insulated from the pole, assemblies shall have an additional level of insulation installed between the assemblies and the poles. Such insulation shall be 5kV rated. The metallic equipment between the two levels of insulation shall be grounded to the static wire.



## **9.3.16 OCS PROJECT DOCUMENTATION**

### **9.3.16.1 BASIC DESIGN DRAWINGS**

Basic design drawings are general across the project and not specific to an individual site. They comprise of technical sheet drawings and a group of standard drawings.

#### **9.3.16.1.1 TECHNICAL SHEET DRAWINGS**

Based on OCS basic design studies, technical sheet drawings shall be prepared giving design parameters, conductor characteristics, loading tables, tension charts, clearance envelopes, OCS acceptance criteria, application charts and other data.

#### **9.3.16.1.2 GENERAL ARRANGEMENT DRAWINGS**

General arrangement drawings shall be used to show major groups of assemblies of multiple structures and spans. Installation rules and principal dimensions shall be given.

General arrangement drawings for OCS overlaps shall be prepared for the detail design of overlaps. Drawings shall include both insulated and uninsulated overlaps, for tangent and curved tracks and to include feeding and switching arrangements and minimum clearances.

General arrangement drawings for OCS turnouts and crossovers shall be prepared for track special work locations where trains change tracks at crossovers and where they leave or enter the mainline.

General arrangement drawings shall be prepared for phase breaks to suit all pantograph configurations to be utilized by RTD.

#### **9.3.16.1.3 ASSEMBLY DRAWINGS**

OCS assembly drawings shall be prepared for every required assembly. More than one similar assembly may be defined on a single assembly drawing. Individual assembly references shall be nominated for every discrete set and discrete count of components. It is acceptable for items such as pipes and wires that may vary in length in any assembly to be included showing quantity 'as-required' in any OCS assembly, without affecting the assembly reference number.

A Bill of Materials table shall appear on each assembly drawing that identifies parts by descriptive name and part number.

### **9.3.16.2 SITE-SPECIFIC DESIGN DRAWINGS**

For reasons of site safety, electrical connections and circuit identifications shall only be shown on sectioning drawings.

#### **9.3.16.2.1 OCS MASTER OVERLAP CHART**

A Master Overlap Chart shall be drawn to express the route design of the physical wires relative to each other and related design features.

The proposed location of insulated overlaps shall be based on the requirements of the sectionalizing diagram. Uninsulated overlaps, balance weight terminations, fixed terminations and OCS midpoint anchors shall be shown overlaying the tracks.

#### **9.3.16.2.2 WIRING LAYOUT DRAWINGS**

Site-specific OCS wiring layout drawings shall be prepared showing the layout of the OCS poles and other supports, with the civil track plans as background. Each pole/support shall be assigned an OCS structure number unique within the RTD Commuter Rail and Light Rail systems.

The line of the OCS conductors shall overlay the pole/support layout, and the staggers at each pole/support, and the string line for each span on curved track, shall be given. OCS conductor heights above top-of-rail at each support shall be included.

The line of the autotransformer feeder wire and its mounting height shall also be shown on the OCS wiring layouts.

The OCS wiring layouts shall identify the OCS and feeder assemblies by reference number required at each OCS support location, unless specified on a separate drawing. OCS and feeder wire assemblies to be installed 'in span' shall be referenced on the wiring layout plans.

#### **9.3.16.2.3 GROUND AND BONDING LAYOUT DRAWINGS**

Site-specific Grounding and Bonding layout drawings shall be prepared showing the layout of the static wires, OCS poles and other supports, with a two rail representation of track plans as background.

All grounding connections to each static wire and impedance bonds, and bonding connections to all metallic items shall be shown.

#### **9.3.16.2.4 MATERIALS ALLOCATIONS**

Each assembly defined in the basic design drawings shall have a unique assembly reference number assigned.

Using the assembly reference numbers given in the basic design drawings, each pole support shall be allocated the OCS and feeder assemblies that altogether define the materials required to be installed at that particular support stationing. These allocations of assemblies shall occur on either the wiring layout plans, or if produced, structure specific cross section drawings.

### **9.4 GROUNDING**

This Section specifies requirements for the following:

- Traction Power Return System (TPRS)
- Traction power substation (TPSS), switching station (SWS), and autotransformer/paralleling station (AT/PS) grounding systems
- Grounding and bonding requirements for the Overhead Contact System (OCS)
- Grounding and bonding for structures, such as TPSS, SWS, APS, fences, bridges, bridge barriers, and passenger stations.

#### **9.4.1 TRACTION POWER RETURN SYSTEM**

The Traction Power Return System consists of track rails, impedance bonds, drain bonds, static wires, and ground. The system shall be designed to provide a low impedance path for the return currents to the substation under normal and fault conditions and to limit rail-to-ground voltages to safe value.

Rail bonds shall be provided across rail joints, at crossovers, turnouts, and expansion joints.

Track rails shall be connected in parallel with each other at impedance bond locations.

Adjacent tracks shall be connected in parallel using crossbonds and connect to the static wires. The design shall be coordinated with the signal designer for location of impedance bonds and crossbonds to be paralleled, so that broken-rail protection is not compromised.

Crossbonds shall be provided to parallel all rails at all traction power substations, autotransformer/paralleling stations and switching stations, and connect to the facility ground grid and neutral of autotransformers (for AT system). Coordinate the interface between traction return cables and the impedance bonds with the signaling design.

Return current ground buses shall be connected to rails through impedance bonds and to the substation ground grid.

Impedance or drain bonds shall be provided at all passenger stations for connection of all track rails to the platform grounding system to equalize potentials from trains. Refer to 9.4.11.

#### **9.4.2 TRACTION POWER SYSTEM GROUNDING**

Step and touch potentials of rails, equipment, structures and trackside facilities shall be within IEEE Standard 80 limits under fault conditions.

At each TPSS, PS, and SWS provide a ground grid to maintain safe step and touch potentials, in compliance with IEEE Standard 80 for the expected maximum short circuit level. Connect all metallic objects within the site, including the security fence, to the ground grid. Extend the grid a minimum of 4 feet outside of the fence, including gate swings. Determine soil resistivities and grid resistance in compliance with IEEE Standard 81.

Below ground connections shall comply with the requirements in IEEE Standard 837.

Ground conductors shall be stranded copper and grid conductor size shall be a minimum of 4/0 AWG. Ground rods shall be copper clad steel with a minimum diameter of 3/4 inches.

Connect surge arrester ground leads directly to the nearest ground electrode, such as ground rod or ground grid, with a ground resistance than 5 ohms or less.

Grounding of Traction Transformer and Autotransformer (for AT System) Bushings:

- Ground the neutral bushing of traction power transformers and autotransformers directly to the ground grid with a 4/0 AWG (minimum) stranded copper conductor riser near the bushings.
- Additionally, ground the neutral bushings to the return current ground bus.

Provide grounding and bonding and test provisions for all TPS and associated equipment in TPSS, APS, and SWS or where adjacent to the tracks or other properties to ensure the proper working of the railroad and the safety of the public, passengers, and personnel.

#### **9.4.3 OCS POLES**

Pole grounding resistance shall be 25 Ohms or less.

#### **9.4.4 OCS SURGE ARRESTERS**

Surge arresters installed on the OCS shall be grounded by an independent ground cable directly attached to a grounding device such as ground rod(s) or ground mat with a ground resistance of 5 Ohms or less. Pole grounds may be connected to surge arrester grounding devices.

The surge arrester type installed on the OCS and AFS shall be coordinated with those determined for the Traction Power System.

#### **9.4.5 UN-ENERGIZED COMPONENTS**

All OCS metallic fittings and equipment not intentionally energized shall be effectively grounded. There shall be no electrically floating wire or component.

#### **9.4.6 GROUNDING OF METALLIC OCS POLES AND STRUCTURES**

Electrically connect all OCS poles, portals, structures, and supports attached to bridges and tunnels directly to the static wire except as required in 9.4.11.

All connections shall be firm and solid and shall be achieved by means of a flexible stranded copper bonding jumper equivalent in size to the static wire. Any contact point between the static wire and the OCS pole/structure susceptible to movement shall be considered a not-acceptable connection for grounding purposes.

Connect the OCS poles/structures to impedance bonds where possible, ground grids, and to the along-track counterpoise conductor.

All grounding connections shall be by 4/0 AWG, minimum, stranded copper wire. Below ground connections shall be exothermically welded.

#### **9.4.7 GROUNDING OF GANTRIES AND GANTRY EQUIPMENT**

All gantry structures associated with substations, autotransformer/paralleling stations and switching stations shall be connected to the facility ground grid by two independent conductors connected between each outer support column of the gantry and the station ground grid.

Bare stranded 4/0 AWG copper grounding conductor shall be looped along the gantry members to provide a ground bus for equipment installed on the gantry. The loop grounding conductor shall be connected, at their extremities, to the two grounding conductors connected to the gantry support columns.

#### **9.4.8 GROUNDING FOR STEEL OVER RAIL BRIDGES**

Grounding at the overhead bridges shall provide path for passage of traction short circuit currents to the static wire and prevent the short circuit currents from entering the bridge steelwork.

Ground steel bridges with a grounding loop of 4/0 AWG, minimum, stranded copper conductor on all four sides, exothermically welded.

Connect the grounding loop to static wires at a minimum of two locations.

Bond steel support beams and all metallic equipment on the bridge, bridge protective barriers, fences, signs, traffic rails, communication devices, handholes, pull boxes, and poles to the grounding loop.

In locations where the overhead contact wire system is connected to the bridge by drop tubes or other devices, bond the connecting member to the grounding loop.

#### **9.4.9 GROUNDING FOR CONCRETE OVER RAIL BRIDGE**

Grounding at the overhead bridges shall provide path for passage of traction short circuit currents to the static wire and prevent the short circuit currents from entering the bridge reinforcing steel.

Provide a grounding loop of 4/0 AWG, minimum, stranded copper over all four sides of the bridge.

Install 1/4-inch minimum thickness, copper or stainless steel, metallic flash plates equal to pantograph width, on the bridge soffit to prevent damage due to arcing between the pantograph and the bridge concrete. Flash plates shall be insulated to 5kV from the bridge structure. Flash plates may be omitted where pantograph and live wires are 6 feet from the soffit.

Interconnect adjacent flash plate sections over each track with a bare 4/0 AWG, minimum, stranded copper conductor to form an electrically continuous grid for the full length of the bridge.

Bond steel support beams and all metallic equipment on the bridge, including flash plates, bridge protective barriers, fences, signs, traffic rails, communication devices, handholes, pull boxes, and poles to the grounding loop.

#### **9.4.10 UTILITIES ATTACHED TO BRIDGES**

Utilities attached to the bridges shall be insulated, grounded and bonded, as required to prevent the short circuit currents from entering utility pipes or conduits. Details shall be determined by the Grounding and Bonding Study during the detailed design phase.

#### **9.4.11 GROUNDING AT PASSENGER STATIONS**

The static wire shall not be connected electrically to the OCS poles or supports located on the station platforms or station structures. Static wires shall be installed on 5 kV insulators at these support points.

Insulation and grounding connections required for OCS and ATF support assemblies mounted on poles on platforms are described in Paragraph 9.3.15.

All metallic structures and miscellaneous items installed on passenger platforms shall be isolated from the static wire and connected to the platform grounding system as required for Systems Grounding on Platforms shown in Section 12, System-Wide Electrical Design.

All below ground connections shall be exothermically welded.

#### **9.4.12 PERSONNEL GROUND GRIDS**

Personnel ground grids 6 feet long by 4 feet wide shall be installed at all disconnect switch locations. The grid shall be installed on the operator's side of the switch, 6 inches below finished grade, and shall be connected to the switch support structure by a flexible 4/0 AWG copper conductor or braid. The grid shall be exothermically welded to two different conductors of the ground grid and to the switch support.

#### **9.4.13 PERSONNEL GROUNDING PLATFORMS**

Grounding platforms 6 feet long and 4 feet wide shall be installed where the installation of a buried personnel grounding grid is not feasible. Platforms shall be constructed of galvanized steel members sized to safely support operating personnel. Hand rails and access steps shall be provided for elevated platforms where appropriate.

Platforms, hand rails and steps shall be bonded and connected to the switch support structure and to the main ground grid by a 4/0 AWG bare copper conductor exothermic welded to two different sections of the platform.

### **9.5 STANDARDS AND CODES**

All design work and material selection shall conform to or exceed the requirements of the latest editions of standards and codes issued by the following organizations:

- Association of American Railroads (AAR)
- American Railway Engineering and Maintenance-of-Way Association (AREMA) Manual For Railway Engineering
- American National Standards Institute (ANSI)
- American Society for Testing & Materials (ASTM)
- Institute of Electrical & Electronics Engineers (IEEE)
- National Electrical Manufacturers Association (NEMA)
- Insulated Cable Engineers Association (ICEA)
- American Society of Civil Engineers (ASCE)
- American Society of Mechanical Engineers (ASME)
- Underwriters Laboratories (UL)
- National Fire Protection Association (NFPA)
- National Electrical Testing Association (NETA)
- National Electrical Code (NEC), where applicable

- National Electrical Safety Code (NESC)
- Applicable state, local, and county codes and regulations
- Applicable federal and state statutes

## **9.6 PRODUCT REQUIREMENTS**

### **9.6.1 TRACTION POWER SUPPLY SYSTEM**

#### **9.6.1.1 EQUIPMENT DESCRIPTION**

The traction power supply system shall consist of equipment between the interface points with the Utility and connection to the feeder and OCS disconnect switches, autotransformer/paralleling stations, and return current circuits. The systems shall include all the necessary equipment and ancillaries, such as:

- High voltage buses, cables, and conductors
- High voltage disconnect switches and switchgear
- Traction transformers (and autotransformers for 2x25kV systems)
- 25kV switchgear assemblies, busbars, and associated protective relays
- Auxiliary power supply transformers with associated AC and DC control power gear including battery and battery chargers
- Harmonic filters, if required
- Cable ductbanks, conduits and raceways within the substation and paralleling stations
- Return cables and connections to impedance bonds
- Equipment foundations
- Grounding system
- HVAC system for buildings
- Surge arresters
- Local annunciation, monitoring and control systems
- Utility metering equipment
- Supervisory Control and Data Acquisition (SCADA) equipment
- Safety equipment e.g., portable fire extinguishers, eye wash and other mandated requirements
- Spare parts for normal maintenance for three years
- Circuit breaker test cabinet, special tools for maintenance
- Comprehensive Operating and Maintenance (O&M) manuals and training of personnel



High voltage equipment, transformers, harmonic filters (if provided) and disconnect switches shall be installed outdoor in switchyards. 25kV switchgear shall be installed indoor or outdoor based on relative cost. Auxiliary supply and control gear shall be installed in a building. Prefabricated and pre-wired assemblies shall be utilized where economically feasible.

#### **9.6.1.2 INCOMING AC FEEDERS**

The incoming primary supply shall be by overhead lines (preferred) or underground cables as agreed with the Utility terminating on gantries or other support structures. Cable ductbanks, conduits, raceways and manholes inside the substation property line shall be designed per applicable codes. Interconnection designs shall be fully coordinated, and in compliance, with the Utility requirements and interfaced with the Utility overhead or underground facilities. The incoming feeder ratings shall permit the substations to supply the required load cycles and withstand the expected short circuit levels without exceeding the allowable equipment temperatures.

#### **9.6.1.3 HIGH VOLTAGE CIRCUIT BREAKERS AND DISCONNECT SWITCHES**

High voltage (115kV and 230kV) circuit breakers and disconnect switches shall be outdoor 2-pole type. The breakers shall be dead tank SF6 type with spring charged or permanent magnet actuators. Disconnect switches shall be motor operated with remote and local operation capabilities and rated for no-load operation.

#### **9.6.1.4 TRACTION TRANSFORMER**

Transformers shall be oil filled natural cooled (ONAN) rated, with appropriate overload capability, per paragraph 9.3.1.6, conforming to ANSI C57.12 shall be used. Maximum temperature rise for 100% full load shall not exceed 55°C. Off-load tap changers shall be provided.

The transformers shall be capable of withstanding fluctuating traction load, repeated short circuits (typically as many as 300 per year), and harmonic currents associated with traction loads.

#### **9.6.1.5 25KV FEEDER CABLES**

Cables for use on 25kV system shall be of 46kV class, 250kV BIL, suitable for use in continuous and emergency operation. The cables shall be single conductor, stranded copper of the size determined during detail design, EPR insulated, shielded, rated for 90°C in normal operation, 130°C in emergency operation and 250°C in short circuit condition. The cables shall have an overall black jacket of high molecular polyethylene to ASTM D1248 suitable for outdoor and indoor application.

#### **9.6.1.6 25KV SWITCHGEAR**

25kV switchgear shall be single-pole if 1x25kV system is used or two-pole if 2x25kV system is used. The switchgear shall be outdoor or indoor depending upon the relative cost.

Indoor switchgear, if used, shall be metal-clad dead-front conforming to ANSI C37.20.2 IEEE Standard for Metal Clad and Station Type Cubicle Switchgear. Adequate working space, per NEC shall be provided for maintenance from the front and the rear of the switchgear. The switchgear shall be trip-free, horizontal drawout type with arc resistant construction to IEEE Std. C37.20 with proven track record in traction duty. The switchgear shall be rated at 200kV BIL to ground (250kV across open contacts).

Outdoor switchgear, if used, shall be dead tank type, rated at 250kV BIL and installed on free standing steel structures with horizontal and vertical clearances per NESC.

Busbars and bus connections shall be designed to withstand, without damage to the bus or enclosure, the thermal and mechanical stresses occurring during the specified weather and load cycle and the rated short circuit currents.

Busbars shall be made of rigid high electrical conductivity copper. Indoor busbars shall be adequately insulated and braced with high-strength insulators. Bus connections shall be bolted and furnished with silver-plated surfaces. Each joint shall have conductivity at least equal to that of the busbar.

#### **9.6.1.7 25KV DISCONNECT SWITCHES**

25kV disconnect switches shall be installed on track-side structures. The disconnect switches shall be motor-operated with remote operation capability, 250kV BIL, 125 V DC operated, capable of operation under icing conditions. Disconnect switches shall be fitted with arc horns or momentary charge/discharge devices to prevent long term damage to the contact surfaces. Disconnect switches on 2x25kV system shall be 2-pole.

#### **9.6.1.8 POTENTIAL TRANSFORMERS (PT)**

Potential Transformers (PT) shall be suitable for traction duty. PT units which are directly connected to the catenary shall be ferroresonance resistant and comply with EN 50152-3-3. All PT units shall have high resistance primary windings.

### **9.6.1.9 LOCAL CONTROL AND ANNUNCIATION PROGRAMMABLE LOGIC CONTROLLER (PLC)**

The substations, paralleling stations and switching stations shall be unattended and normally controlled from the control center via SCADA. However, local control switches shall be provided for all equipment for operation in the event of failure of SCADA or the communication link. Use of PLC units and intelligent electronic devices (IED), suitable for service inside Utility substations, is allowed for all functions. Devices and subsystems performing interlocking functions shall be hard wired to provide Safety Integrity Levels (SIL) appropriate for the hazard. Protective relays shall trip the circuit breakers independent of the PLC.

The PLC system, if used, shall be full featured, integrated, modular, using non-proprietary off-the-shelf software. The modules shall be capable of being inserted at the site, with no factory re-wiring required. It shall include a relay interface system. All functional requirements specified shall be met or be exceeded by the PLC system. PLC, associated network and interfaces shall be rated to Utility standards for substation environments.

The substations shall be equipped with an internal annunciation system. The annunciator shall be of modular design, programmable, and may be integrated with the PLC. The annunciator shall consist of touch screens, indicating light emitting diode (LED) lamps, audible alarm, test, silence, acknowledge and reset switches, as well as other associated equipment. Switches and controls may be implemented in software.

An electrical alarm "points list" shall be developed listing electrical alarms to be annunciated. These alarms shall be annunciated remotely and locally.

At a minimum, the PLC system shall consist of the following components:

- Electronic terminators, capable of handling 130 V dc, to replace the normal auxiliary and interposing relays for the AC switchgear cubicles, high voltage circuit breakers, disconnect switches, etc.
- Transfer trip module, if transfer trip is provided
- Master PLC with dual CPUs , one working as hot standby, designed and programmed to integrate and control all inter-panel connections and to provide substation monitoring and data logging that is easily downloadable
- Man/machine interface (operator panel) capable of providing substation status annunciation and local/remote control of substation operations (e.g. opening and closing of circuit breakers)

The PLC system and equipment shall be designed to operate in an electric utility environment. All electrical interfaces, including relaying, voice, and data shall meet ANSI/IEEE surge withstand requirements. The system shall be immune to Radio Frequency Interference and shall be designed to meet the requirements of ANSI/IEEE C37.90.2 and ANSI/IEEE 281. The presence

of transients on the communication interfaces shall not cause mis-operation or blocking of any of critical communications. The system shall be failsafe. Interface with SCADA system shall not require an RTU.

#### **9.6.1.10 CONTROL POWER**

Control power supply shall consist of 120V AC (and 240/480V AC if required for HVAC) and 125V DC for breaker and other critical controls. Redundant battery chargers shall be provided. AC and DC distribution panel boards shall be NEC compliant. The AC panel board shall supply the substation lighting, HVAC, convenience receptacles and battery charger. The DC panel board shall supply circuit breaker and other control power and annunciation. External outlets shall be provided for providing auxiliary power from external sources if required.

#### **9.6.1.11 BUSBARS AND BUS CONNECTORS**

Busbars and bus connections shall be designed to withstand, without damage to the bus or enclosure, the thermal and mechanical stresses occurring during the specified load cycle and the rated short circuit currents.

Busbars shall be made of rigid high electrical conductivity copper and shall be adequately insulated and braced with high strength insulators. Bus connections shall be bolted and furnished with silver-plated surfaces. Each joint shall have conductivity at least equal to that of the busbar.

#### **9.6.1.12 EQUIPMENT LAYOUT**

Substation (TPS, SWS, and APS) layouts shall allow working on one half of the substation while the other is energized and feeding the OCS. Adequate clearance shall be provided between the bays to achieve this. High voltage areas shall not be placed near entrance gates.

Relative spacing and positioning of each item of equipment shall permit maintenance, removal and replacement of any unit without the necessity of moving other units. The arrangements of the equipment in the building shall permit doors to be opened, panels to be removed, and switchgear to be withdrawn without interference to other units. Ceiling heights and structural openings shall permit entry and removal of the largest components installed in the housing. Minimum working clearances shall be provided per the NEC. Two exit doors with panic hardware, one from each end of the switchgear, shall be provided.

Circulating area, either inside or outside the site, shall permit turn around of tractor trailers.

#### **9.6.1.13 RETURN CABLES**

Medium voltage feeder cables, 2kV class, shall be low smoke, flame retardant, ozone resistant, non-shielded, Ethylene Propylene (EP) rubber insulated and provided with a heavy-duty Chlorosulfonated Polyethylene

(CP) jacket. The cables shall be suitable for installation in an underground conduit or duct, for use in wet and dry locations. The maximum operating conductor temperature shall be 90°C for normal operation, 130°C for hot spot, and 250°C for short circuits. The cable construction shall comply with ASTM D2802 and ANSI/ICEA Std. S-93-639.

#### **9.6.1.14 AUXILIARY POWER SUPPLY AT INTERLOCKINGS**

Auxiliary power supply for operation of disconnect switches at interlockings shall be obtained from the OCS via step-down transformers. Backup power to signal houses may be provided from an auxiliary power supply distribution panel powered from the step-down transformers. The transformers shall be ferroresonance resistant. Power supply for train stations, other facilities, and primary power to signal houses shall not be obtained from the 25kV system.

#### **9.6.1.15 OPERATIONS FACILITY ELECTRIFICATION**

See Section 11 of the Design Criteria.

### **9.6.2 OVERHEAD CONTACT SYSTEM (OCS)**

The OCS consists of all equipment between and excluding traction power disconnect switches (mounted on OCS trackside switching/feeder gantries) and the vehicle pantograph. The OCS equipment shall include foundations, poles, portals, gantries, cantilevers, under bridge arms, shop building supports, system conductors, feeders, hangers, jumpers, terminations, tensioning devices, sectioning equipment and all other necessary equipment.

The OCS shall be designed to be environmentally acceptable. Within the economic, electrical, mechanical and structural design constraints, the OCS structures and associated equipment shall be as lightweight as possible and shall use visually unobtrusive fittings.

Refer to Table 9.3 for a summary of design values and factors of safety to be applied to OCS equipment.

#### **9.6.2.1 FOUNDATIONS**

Each foundation shall be designed to suit the bearing strength and conditions of the ground into which it is to be built.

Foundation location, lateral offset and foundation top level shall not cause the foundation to encroach on required horizontal and vertical clearances from rail vehicles and track. Refer to 9.3.9 and 9.3.11.

All exposed steelwork shall be galvanized.

### **9.6.2.2 POLES, PORTALS, AND GANTRIES**

All poles, portal columns, and gantry columns shall be steel of solid cross-section to discourage unauthorized climbing. All poles, portal columns, and gantry columns shall be hot-dip galvanized after fabrication.

### **9.6.2.3 CANTILEVERS ASSEMBLIES**

Cantilever Assemblies shall be easy to install and field adjust to account for the effects of future track settlement or movement. All steel or cast iron components shall be galvanized.

### **9.6.2.4 CONDUCTORS AND IN-SPAN ITEMS**

Contact wire shall be solid, grooved, copper conductor. The messenger wire shall be stranded, hard-drawn copper conductor.

All conductor connections, attachments, hangers and clamps shall be corrosion resistant and compatible with conductor material. They shall be suitable for high levels of wiring vibration, and designed for ease of replacement and maintenance.

Continuity and equalizing jumpers shall be flexible copper conductors. The spacing of the jumpers shall be determined based on the local current demands. A minimum of two equalizing jumpers per half tension length shall be installed.

### **9.6.2.5 TERMINATIONS AND MIDPOINT ANCHORS**

Strain-type termination assemblies shall be light weight. Wire wrap, straight line, cone or wedge type designs are acceptable.

Turnbuckles shall be included as appropriate and shall have adequate adjustability. All turnbuckles shall include locking devices. Where yoke plates are utilized, these shall be positioned horizontally outside the pantograph security envelope irrespective of height.

A mid-point anchor arrangement shall utilize a span-guy of sufficient strength to withstand full line tension of both messenger and contact wires.

Auto tensioned, mid-point anchor arrangement shall include contact wire restraint sub assemblies if:

Pulleys at the balance weight anchor location are provided to share messenger wire and contact wire tensions, or

The messenger wire and contact wire have independent balance weight anchor assemblies.

#### **9.6.2.6 TENSIONING DEVICES**

The auto-tensioned system conductors shall be tensioned using cast iron or steel balance weights. The tensioning devices shall accommodate conductor expansion and contraction due to temperature and long term wire creep, while maintaining wire tension within the designed range. They shall be provided with broken wire restraint arrangements.

Balance weights shall be positioned in the pole web to be as unobtrusive as possible. The poles with balance weights shall be fitted with guides that will prevent the balance weights from binding or jamming. The guide shall prevent the weights from falling away from the anchor pole should a wire break.

All operating wires shall be of flexible stainless steel wire.

Where yoke plates are utilized, these shall be positioned horizontally outside the pantograph security envelope irrespective of height.

Balance weight anchor assemblies shall not be installed in areas frequented by passengers or pedestrians.

Pneumatic or hydraulic tensioning devices shall not be used.

#### **9.6.2.7 SECTIONING EQUIPMENT**

High-speed section insulators may be used in crossovers, yard leads and in yards. All section insulators shall be of an overlapping runner style, and be fitted with arc horns designed to protect tensioned components. Messenger wire shall be sufficiently higher than the contact wire to mitigate arc damage, and increase dynamic stability.

#### **9.6.2.8 SURGE ARRESTERS**

Over-voltage protection for the OCS and equipment shall be provided by surge arresters. The arresters shall be rated to withstand the maximum operating voltage and anticipated voltages induced from any paralleling high-voltage transmission lines onto the system conductors, and shall be explosion proof. The arresters shall be spaced to satisfactorily discharge the energy from lightning strikes to the ground.

All transformers, cable terminations and cable-to-overhead transitions shall be protected by surge arresters in addition to the substation and autotransformer/paralleling station gantries. Additional arresters shall be provided on the OCS at spacings determined during detailed design. The installation of arresters shall prevent grounding of the energized circuit during catastrophic failure of the arrester.

### **9.6.2.9 PROTECTIVE SCREENING**

When the OCS and/or feeder wire is constructed below a bridge, building, or structure, screening and fencing shall be erected to physically separate the catenary wires from human reach. The overpass screening and/or fencing shall be constructed to protect rail vehicles and wiring from vandals dropping objects from above.

Horizontal screens shall have a smooth upper surface sheet, and be shaped to allow falling objects to slide towards trackside. Horizontal screens shall be designed to support the weight of a trespasser. Vertical screen shall be designed and placed to discourage trespassers gaining hand hold or foot holds. The design of the overpass screening and/or fencing shall be compatible with the local architecture and landscaping.

At a minimum, all fencing passing over the tracks and within 25 feet parallel to the track shall be grounded. Fence grounding resistance shall be less than 25 ohms to ground or as determined during grounding design study. Grounding requirements of parallel fences over 15 feet from the tracks shall be determined during grounding design study. Grounding shall be consistent with Section 12.8 of the Design Criteria.

In cases where any energized OCS component has less than 10 feet separation from pedestrian access, a solid barrier or panel shall be placed alongside or over the OCS between the energized component and pedestrian access to deter access to the energized component, and to prevent vandalism.

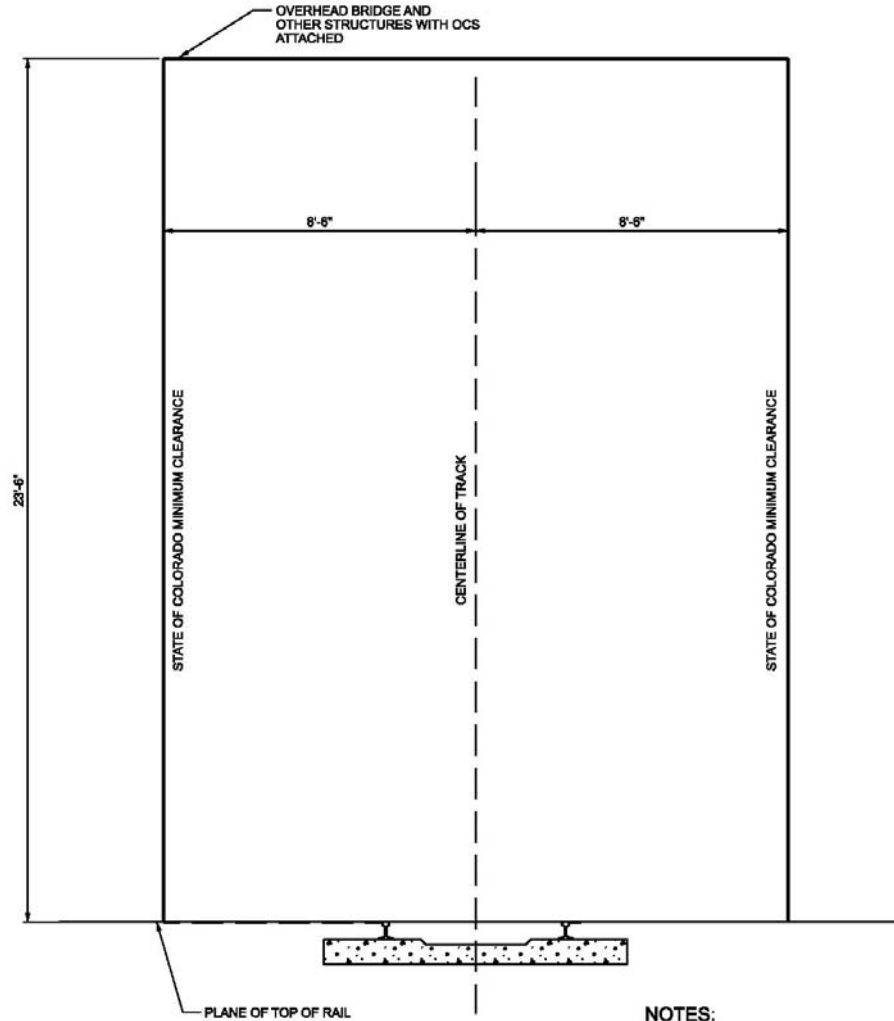


## 9.7 OCS DESIGN PARAMETERS

**TABLE 9-3  
DESIGN PARAMETER SUMMARY**

<b>Climatic Conditions</b>	
Ambient Conditions	See Section 1 for common parameters
Environmental Conditions	See Paragraph 9.3.3.2
NESC Grade of Construction	Grade C
<b>OCS Conductor Sizes and Material</b>	
Messenger Wire:	Hard Drawn Copper Size and class shall be based on systems simulation
Contact Wire:	Solid Grooved Hard Drawn Copper Size shall be based on systems simulation
<b>Minimum Factors of Safety - Conductors and Wires</b>	
- Under Operating Conditions	2.0
- Under Non-operating Conditions	1.6; determined in accordance with NESC Rule 261H and other referenced rules.
Contact Wire Wear for Mechanical Design	30%
<b>Minimum Factors of Safety – Strain Insulators</b>	
- Under Operating Conditions	4.0
- Under Non-operating Conditions	3.2
<b>Minimum Factors of Safety – Hardware</b>	
- Under Operating Conditions	2.5
- Under Non-operating Conditions	2.0
<b>Minimum Electrical Clearances</b>	
Static Clearance:	12 in
Passing Clearance:	10 in
<b>Pantograph</b>	
- Dynamic uplift allowance	3 in
- Minimum Pantograph Security:	3 in

SEE SECTION 4 TRACK GEOMETRY AND TRACKWORK FOR CLEARANCES  
 THIS DIAGRAM IS NOT TO BE USED TO DETERMINE POLE AND FOUNDATION CLEARANCES  
 FOR APPLICATION TO TRACKS AUTHORIZED FOR COMMUTER RAIL VEHICLES ONLY



**NOTES:**  
 1. TOTAL TRACK VERTICAL CONSTRUCTION AND MAINTENANCE TOLERANCES NOT TO EXCEED 5".

F:\CAADD\Systeme\Microstation\Fastracks Global Masters\JO DESIGN CRITERIA FIGURES.dgn

1:24:20 PM

2/11/2009

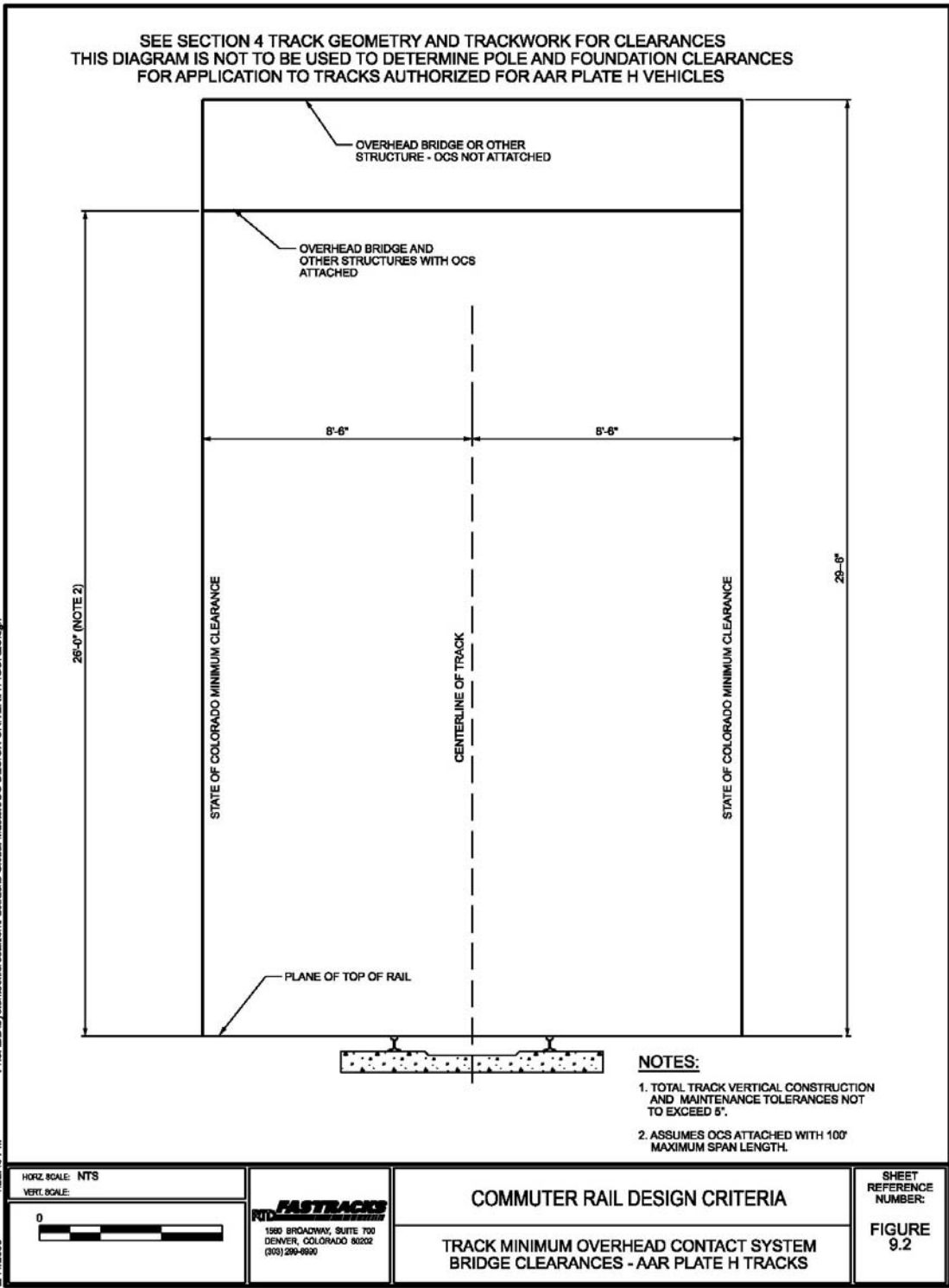
HORIZ. SCALE: NTS  
 VERT. SCALE:



**FASTRACKS**  
 1550 BROADWAY, SUITE 700  
 DENVER, COLORADO 80202  
 (303) 290-0900

**COMMUTER RAIL DESIGN CRITERIA**  
 TRACK MINIMUM OVERHEAD CONTACT SYSTEM  
 BRIDGE CLEARANCES - COMMUTER RAIL TRACKS

SHEET  
 REFERENCE  
 NUMBER:  
**FIGURE  
 9.1**



**TABLE OF CONTENTS**

**SECTION 10 – CORROSION CONTROL**

10.1 GENERAL ..... 2

    10.1.1 SCOPE ..... 2

    10.1.2 SYSTEM INTERFACES ..... 2

    10.1.3 REQUIREMENTS ..... 2

10.2 STANDARDS AND CODES ..... 2

10.3 SOIL AND WATER CORROSION CONTROL ..... 3

    10.3.1 BACKFILL MATERIAL ..... 3

    10.3.2 RTD-OWNED PIPING ..... 3

    10.3.3 UTILITY PIPING OWNED BY OTHERS ..... 4

    10.3.4 CATHODIC PROTECTION DESIGN ..... 4

    10.3.5 BURIED PIPING AND CONCRETE STRUCTURES ..... 5

10.4 ATMOSPHERIC CORROSION PROTECTION ..... 7

    10.4.1 METALLIC MATERIALS (GENERAL) ..... 8

    10.4.2 STEEL AND FERROUS ALLOYS ..... 8

    10.4.3 COPPER ALLOYS ..... 8

    10.4.4 ZINC ALLOYS ..... 8

    10.4.5 ALUMINUM ALLOYS ..... 8

    10.4.6 COATING SYSTEMS ..... 9

10.5 QUALITY CONTROL TESTING ..... 9

    10.5.1 CATHODIC PROTECTION ..... 9

    10.5.2 COATINGS ..... 9

List of Tables

Table 10-1 – Acceptable Cement Types ..... 5

## **SECTION 10 - CORROSION CONTROL**

### **10.1 GENERAL**

#### **10.1.1 SCOPE**

These Design Criteria provide the design basis for the corrosion control measures to be incorporated into all design stages for commuter rail projects. Specific requirements for soil and water, and atmospheric corrosion control systems are defined herein.

#### **10.1.2 SYSTEM INTERFACES**

Corrosion control requirements shall be coordinated with all other engineering disciplines to prevent the deterioration and/or premature failures of metallic and concrete structures.

#### **10.1.3 REQUIREMENTS**

All designs shall conform to structure life objectives for buried structures, and ensure the function, preservation, and appearance of structures exposed to the atmosphere. Corrosion control provisions shall be required for all new facilities regardless of location, owner, or material of construction when corrosion failure of such facilities may affect safety and/or continuity of rail operations.

### **10.2 STANDARDS AND CODES**

The latest editions of the following organizations' standards, codes, and guidelines shall be used for the design of corrosion control systems:

- NACE International (formerly The National Association of Corrosion Engineers)
- RP0169 – Control of External Corrosion on Underground or Submerged Metallic Piping Systems
- American Society for Testing and Materials (ASTM)
- ASTM D512 – Standard Test Methods for Chloride Ion In Water
- ASTM D516 – Standard Test Method for Sulfate Ion in Water
- ASTM G51 – Standard Test Method for Measuring pH of Soil for Use in Corrosion Testing
- American Railway Engineering and Maintenance-of-Way Association (AREMA)
- Federal Highway Administration (FHWA)
- Publication FHWA-NHI-00-044 – Corrosion/Degradation of Soil Reinforcements for Mechanically Stabilized Earth Walls and Reinforced Soil Slopes

### **10.3 SOIL AND WATER CORROSION CONTROL**

This Section provides criteria for the design of systems and measures to prevent corrosion of transit system fixed facilities due to contact with soil and groundwater. Designs shall be based on achieving a minimum 50-year design life for buried structures, with the exception of a 100-year design life for the stations, through consideration of the factors given below.

Structures to be protected include the following:

- New underground metallic utilities
- New underground concrete structures
- New atmospherically exposed metallic components of transit fixed facilities

All pressure and non-pressure piping and conduit shall be non-metallic, unless metallic materials are required for specific engineering purposes, utility owners' standards, or RTD Design Criteria.

#### **10.3.1 BACKFILL MATERIAL**

If non-native fill is to be used for backfilling concrete or ferrous structures, then it shall meet the following criteria:

pH 6 to 8 (ASTM G-51)

Maximum chloride ion concentration of 250 ppm (ASTM D-512)

Maximum sulfate ion concentration of 200 ppm (ASTM D-516)

Test reports shall be submitted for all imported backfill. Fill material, which does not meet one or any of the preceding criteria, shall be allowed only after review and approval by RTD.

#### **10.3.2 RTD-OWNED PIPING**

All new, buried, metallic pressurized piping owned by RTD shall be cathodically protected. Designs shall include the following:

Application of a protective coating to the external surfaces of the piping to be protected.

Electrical insulation from interconnecting piping and other structures, and segregation into discrete electrically insulated sections depending on the total length and/or configuration of the piping.

Electrical continuity through installation of insulated copper wires across all mechanical joints other than intended insulating fittings.

Permanent test facilities shall be installed at all insulating fittings, anode beds, casing interfaces, and at intervals not to exceed 200 feet.

Installation of sacrificial anodes.

### **10.3.3 UTILITY PIPING OWNED BY OTHERS**

Installation of corrosion control measures for facilities owned by others, but designed as part of the transit project, shall be coordinated through RTD and the utility owner. Piping systems whose failure will not affect safety and/or continuity of rail operations are not subject to the corrosion control requirements for RTD-owned piping. Corrosion control measures shall conform to the existing standards and specifications of the Owner.

### **10.3.4 CATHODIC PROTECTION DESIGN**

All cathodic protection (CP) designs shall be performed by a NACE International certified Cathodic Protection Specialist. Designs shall be in accordance with NACE Standard RP0169. All CP designs shall make use of sacrificial galvanic anodes, coating systems, electrical isolation, electrical continuity, and appropriate test facilities.

#### **10.4.3.1 Coatings**

Buried metallic piping structures requiring coating shall be provided with coal tar mastic, coal tar epoxy, polyurethane, petrolatum, or tape coating systems with high electrical resistance. The corrosion control design shall specify surface preparation, application procedure, primer, number of coats, and minimum dry film thickness for each coating system.

#### **10.4.3.2 Electrical Insulation of Piping**

Corrosion and CP designs shall establish the need for electrical isolation between dissimilar metallic components and to isolate CP systems from contact with adjacent metallic structures. Insulating fittings, casing spacers, non-metallic inserts, and plastic pipe saddles shall be considered.

#### **10.4.3.3 Electrical Continuity of Piping**

Electrical continuity bonds shall be used to provide a low resistance path for CP current on piping systems with mechanical and slip-on pipe joints. Welded, threaded, and soldered joints do not require bonding. Continuity bonds shall be made with insulated copper wires exothermically welded to the piping.

#### **10.4.3.4 Test Facilities**

Types and locations of test facilities shall be specified in the corrosion control designs. Test facilities shall be designated according to the type of installation as described in these Criteria. They shall include structure wires, reference electrodes, and anode lead wires as required to accurately evaluate the performance of the corrosion control system.

### **10.3.5 BURIED PIPING AND CONCRETE STRUCTURES**

The following paragraphs establish the protective measures to be considered for utilities and buried structures.

#### **10.5.3.1 Pressure Piping**

All new and relocated buried ductile iron, copper, and steel pressure piping within RTD right-of-way (ROW) shall be cathodically protected as described in Section 10.3.2.

#### **10.5.3.2 Gravity Flow Piping (Non-Pressurized)**

Corrugated steel piping shall be internally and externally coated with a sacrificial metallic coating and a protective organic coating. Cast or ductile iron piping shall be designed and fabricated to include the following provisions:

- An internal mortar lining with a bituminous coating on ductile iron pipe only (not required for cast iron soil pipe).
- A bonded protective coating on the external surfaces in contact with soils.
- A bituminous mastic coating on the external surfaces of pipe 6 inches on each side of a concrete/soil interface.
- Reinforced concrete non-pressure piping shall include the following provisions:
  - Water/cement ratios meeting the minimum provisions of the American Water Works Association (AWWA).
  - Maximum 250-ppm chloride concentration in the total concrete mix (mixing water, cement, admixture, and aggregates).
  - Use Type I cement, except as noted in Table 10-1:



**TABLE 10-1 - ACCEPTABLE CEMENT TYPE BASED ON SULFATE CONCENTRATIONS OF SOIL AND GROUNDWATER**

Acceptable Cement Type	Percent Water Soluble Sulfate (as SO <sub>4</sub> ) In Soil Samples (ppm)	Sulfate (as SO <sub>4</sub> ) in Groundwater (ppm)
Type I	0 to 0.10	0 to 150
Type II	0.10 to 0.20	150 to 1,000
Type V	Over 0.20	Over 1,000

**10.5.3.3 Casing Pipe**

Pipeline casings, if required below the tracks, shall be installed bare. Casing wall thickness shall conform to AREMA requirements for non-coated, non-cathodically protected casing pipes.

**10.5.3.4 Electrical Conduits**

Buried metallic conduits shall be galvanized steel with polyvinyl chloride (PVC) or other coating acceptable for direct burial, including couplings and fittings. The PVC coating is not required when conduits are installed in concrete.

**10.5.3.5 Buried Concrete/Reinforced Concrete Structures**

The design of cast-in-place concrete structures shall be based on the following provisions:

- Use Type I cement, except as noted in Table 10-1. Use of a concrete mix with a cement type not specifically listed in Table 10-1 must be reviewed and Approved by RTD.
- Water/cement ratio and air entrainment admixture in accordance with specifications presented in the structural criteria to establish a dense, low permeability concrete.
- Maximum chloride concentration of 250 ppm in the total mix (mixing water, aggregate, cement, and admixtures).
- Concrete cover over reinforcing steel shall comply with American Concrete Institute (ACI) codes and provide a minimum of 2 inches of cover on the soil side of reinforcement when pouring within a form and a minimum of 3 inches of cover when pouring directly against soil.

- The need for additional measures, as a result of localized special conditions, shall be determined on an individual basis. Additional measures may include application of protective coating to concrete, reinforcing steel, or both. Precast standardized facilities, such as vaults and manholes, must be reviewed on an individual basis to determine alternative criteria when they cannot be practically modified to meet some or all of the provisions specified herein. Precast segmented concrete ring construction shall meet the requirements of this Section or be reviewed on an individual basis to determine alternative criteria when they cannot be practically modified to meet some or all of the provisions specified.

#### **10.5.3.6 Support Pilings**

The following is applicable only to support piling systems, which are to provide permanent support. Pilings used for temporary support do not require corrosion control provisions. Designs based on the use of metallic supports exposed to the environment, such as H or soldier piles, shall include the use of a barrier coating. The need for special measures, such as cathodic protection, shall be determined on an individual basis, based on type of structure, analysis of soil borings for corrosive characteristics, and the degree of anticipated structural deterioration caused by corrosion.

#### **10.5.3.7 Reinforced Concrete Retaining Walls**

Cast-in-place concrete retaining walls shall be in accordance with the requirements in Section 10.3.5.5. Modular-type retaining walls with restraining devices or reinforcing strips placed beneath the tracks shall meet the requirements in Section 10.3.5.5, and FHWA Publication No. FHWA-NHI-00-044. Designers must provide for soil corrosion control for modular retaining walls with structural support component beneath the Commuter Rail tracks. Modular-type retaining walls that do not place critical structural components beneath the tracks shall also meet the requirements in Section 10.3.5.5, and FHWA Publication No. FHWA-NHI-00-044.

### **10.4 ATMOSPHERIC CORROSION PROTECTION**

Methods for controlling atmospheric corrosion shall include, but not necessarily be limited to the following:

Materials selection – Acceptable materials shall have proven performance records for the service application.

Protective coatings – Barrier or sacrificial coatings shall be used on steel.

Design – Recess moisture traps and dissimilar metal couples shall be avoided.

Sealants – Accumulation of moisture in crevices shall be prevented by the use of sealants.

All wayside electrical equipment such as signals and communications equipment, electrical motors, control panels, switchgear, etc. shall be enclosed in temperature controlled environments or otherwise incorporate design techniques to prevent moisture condensation and corrosion of integral parts.

#### **10.4.1 METALLIC MATERIALS (GENERAL)**

Structures that may be affected by atmospheric corrosion shall be identified, including, but not necessarily limited to:

- Exposed metallic surfaces on mainline structures

- Exposed metallic surfaces at passenger stations

- Catenary installations and related metallic hardware

- Right-of-way and enclosure fences

- Electrical, mechanical, signal, and communication devices and equipment, and signal and traction power substation housings

- Vehicles

#### **10.4.2 STEEL AND FERROUS ALLOYS**

Carbon steel and cast iron exposed to the atmosphere shall have a coating applied to all external surfaces. Rail and rail fasteners do not require coatings except when used for the purpose of dielectric insulation. High strength low alloy steels shall be protected in a manner similar to carbon steels except where used as weathering steel exposed to outside environments. Coating of metallic contacting surfaces, crevice sealing, and surface drainage shall be addressed in the designs. Staining of adjacent structures shall be considered.

#### **10.4.3 COPPER ALLOYS**

Copper and its alloys can be used where exposed to the weather without additional protection. Bimetallic couples shall be avoided.

#### **10.4.4 ZINC ALLOYS**

Zinc alloys can be used without additional protection. Bimetallic couples shall be avoided.

#### **10.4.5 ALUMINUM ALLOYS**

Use an anodized finish to provide the best weather resistant surface. Bimetallic couples shall be avoided.

#### **10.4.6 COATING SYSTEMS**

Coatings shall have established performance records for the intended service and be compatible with the base metal to which they are applied. Coatings shall be able to demonstrate satisfactory gloss retention, color retention, and resistance to chalking over their minimum life expectancies. Coatings shall have minimum life expectancies, defined as the time prior to major maintenance or reapplication, of 15 to 20 years.

### **10.5 QUALITY CONTROL TESTING**

#### **10.5.1 CATHODIC PROTECTION**

Cathodic protection testing includes verification of electrical continuity, electrical isolation, anode output current, correct test wire configurations, and determining compliance with cathodic protection criteria in accordance with NACE International Standards. The following paragraphs establish the guidelines for developing the quality control test procedures for verification of property cathodic protection levels:

All structures that are required to have cathodic protection shall be tested in accordance with NACE International RP0169.

A test plan shall be submitted by the testing agency to be approved by RTD.

Specific reporting requirements for the cathodic protection testing shall be incorporated into the project documents.

Selection criteria for the test entities to perform the quality control testing shall be incorporated into the project documents. The criteria shall include the qualifications of the agency, personnel requirements, and equipment requirements. A minimum of 5 years of experience performing this work is required.

#### **10.5.2 COATINGS**

The quality control measures required for the verification of proper application and handling vary depending on the coating type. The following guidelines establish general procedures for the quality control testing:

- Coatings shall be tested in accordance with the manufacturer's recommendations and in accordance with NACE International Recommended Practices.
- A quality control plan shall be implemented for surface preparation, application, and testing of all coated surfaces.

- All shop coated surfaces shall be tested, witnessed, and accepted at the coating facility.
- Selection criteria for the test entities to perform the quality control testing shall be incorporated into the project documents. The criteria shall include the qualifications of the agency, personnel, and equipment requirements.

**END OF SECTION**

**TABLE OF CONTENTS**  
**SECTION 11 - OPERATIONS FACILITY**

11.1	GENERAL .....	2
11.2	MAINTENANCE GUIDELINES.....	2
11.3	MAINTENANCE FACILITY AREAS AND FUNCTIONS.....	2
11.4	YARD LAYOUT .....	4
11.5	DESIGN REQUIREMENTS.....	5

## **SECTION 11 - OPERATIONS FACILITY**

### **11.1 GENERAL**

This section outlines the functional requirements and criteria for the planning and design of facilities for the inspection, maintenance, repair and storage of the Regional Transportation District (RTD) commuter rail system. These criteria are to be used in the development of a more in-depth study to determine design parameters for a specific facility. The criteria for this section have been prepared to interface with three different types of equipment: Electric Multiple Units (EMUs), Diesel Multiple Units (DMUs) and Diesel Locomotive-Hauled. However, it is understood that the resultant RTD maintenance facility may serve a combination of all three types. The Centralized Commuter Rail Operations Facility will be sited and designed based on RTD's proposed commuter rail (CR) route structure, the exact type(s) of CR vehicle(s) and equipment to be used within the system, space availability, operational and future route expansion requirements. The maintenance facility may be required to satisfy the needs of a mixed-technology fleet.

The capacity requirements for maintenance and inspection will be determined by the size of the in-service fleet, the characteristics of the fleet and the amount of time allocated for maintenance and inspection by the train schedules.

This guideline does not establish a certain, specific approach to maintenance, but rather is a general overview of the basic requirements of the facility. Facility requirements by fleet type will be offered in a separate report that will detail specific characteristics and maintenance needs.

### **11.2 MAINTENANCE GUIDELINES**

Regardless of fleet type and make-up, all will require a certain level of maintenance structured along the following guidelines:

- Daily Service and Inspection (FRA compliant)
- Programmed Life Cycle Maintenance
- Running Repair and Corrective Maintenance
- Heavy Repair (component change outs, main engines, generators, some structural, etc.)
- Mid-Life Overhaul (overhaul of all major systems and replacement/upgrade of cosmetic features, may be outsourced)

### **11.3 MAINTENANCE FACILITY AREAS AND FUNCTIONS**

RTD's CR Operations Facility shall house (but not be limited to) the following areas and functions:

- Rail Transportation Administration
- Rail Maintenance Administration
- Rail Operations Planning
- Rail Maintenance Engineering
- Control Center

- Rail Training Administration
- CR Vehicle Body Shop
- CR Vehicle Paint Shop
- Hazardous Fluid Storage and Disposal
- Traction Electrification System (TES) Service and Inspection
- CR Vehicle Service and Inspection (including FRA Class 1 Brake Test)
- Diesel Locomotive or DMU Engine Refueling (fuel storage shall be located away from the main building)
- Passenger Car Service and Inspection (including FRA Class 1 Brake Test)
- Wheel Truing and Inspection
- Wheel & Axle Presses
- CR Vehicle Truck Maintenance & Repair
- Electronic Component Repair
- Signal Relay Inspection & Calibration
- Pneumatic/Hydraulic Component Repair
- Air Brake Repair
- Parts Cleaning Room
- Lubrication Area
- Covered storage of CR Maintenance-of-Way (MOW) Materials
- CR Vehicle Re-railing
- Facilities Maintenance
- CR Parts Storage
- CR Operator Report Area
- CR Vehicle Air Conditioning and Current Collector Unit Repair
- Rail-bound Equipment Storage
- CR Vehicle Interior and Exterior Cleaning (including a wash bay)
- Shop Work Areas
- Sewage Disposal
- Sanding
- Restrooms and Locker/Shower Rooms
- Conference Rooms and Lunch Room

Some maintenance functions may be done by outside contract offsite. The following list of these items is subject to change prior to design work commencing:

- Major heavy component repairs, rebuilds and overhauls
- Pressing of wheels, bearings and brake disc hubs on/off axles
- Diesel engine and alternator major repairs and rebuilds
- Radio and certain electronic repairs
- Major metal component fabrication



The shop layout shall follow certain design guidelines as closely as funds and site configuration permit. These guidelines relate to the relative location of work spaces to each other within the shop, areas of the spaces for the type of activity or function, utilities requirements, etc. The shop layout shall be designed to separate work functions so that cars may be inspected, serviced and returned to revenue operation as quickly as possible.

Additionally, coordination with local agencies and jurisdictions is required to determine and approve fire protection safety, security and environmental measures that will be implemented as part of the planning, design and construction of the facility.

Isolated traction power shall be provided for the shop and yard storage tracks.

#### **11.4 YARD LAYOUT**

The yard layout (footprint) shall be based upon storage and movement needs for forecasted design year ridership levels. Enough level, tangent track shall be included in the yard layout to accommodate the anticipated number of CR vehicles. Direct access to and from the RTD mainline to the storage tracks is required, preferably operating two lead tracks from the mainline to the storage yard to permit the simultaneous receiving and dispatching of trains. Convenient access from freight mainlines shall also be provided for the delivery of cars and other heavy components. The storage yard shall be adjacent to the shop. The many diverse yard functions, plus the critical time requirements directly proceeding, during and after peak hour operations, necessitate a yard configuration that provides maximum train movement flexibility.

Track construction within the yard shall comply with "Design Criteria Chapter 4 - Trackwork."

Access for truck delivery, including semi-trucks and trailers shall be provided. Service roads shall be provided around the shop, between selected CR vehicle tracks, and to outdoor storage areas within the yard.

The yard shall be adequately lighted for 24-hour operation. Operations facility security shall be achieved by fencing the periphery of the yard, by lighting and by observation from the administration and operations areas of the building.

The overall storage yard layout footprint shall have adequate drainage such that normal operations are not interrupted.

Landscaping shall be minimal. The amount and type shall be consistent with the local zoning ordinance for the site.

## 11.5 DESIGN REQUIREMENTS

Design requirements for the building and yard shall comply with all federal, state, and local laws, regulations, rules, requirements, and shall uphold the preservation of natural resources (environmental) as well as all laws, ordinances, rules, regulations and lawful orders of any public entity bearing on the performance of the work. Architectural treatments (interior and exterior) should be decided as part of the coordination efforts between RTD and the consultant. Listed below (but not limited to) are the principal applicable codes (latest version is to be used):

- International Building Code
- International Mechanical Code
- National Electric Code
- National Electric Safety Code
- International Plumbing Code
- National Fire Protection Association (NFPA)
- American National Standard Code for Elevators
- American Society of heating, Refrigeration and Air-Conditioning Engineers, Inc. (ASHRAE)
- Occupation Safety and Health Administration (OSHA)
- Illuminating Engineering Society of North America
- American National Standards Institute, Inc.
- American Railway Engineering and Maintenance-of-Way Association (AREMA)
- Americans with Disabilities Act, including U.S. Department of Transportation, Final Rule - Transportation for Individuals with Disabilities
- County and City Zoning and Building Regulations
- Federal Railroad Administration – Office of Safety Assurance and Compliance guidelines for inspection
- ASCE Chapter 7 “Minimum Design Loads for Buildings and Other Structures”, American Society of Civil Engineers (latest version)

The facility shall be designed to meet applicable federal, state and local codes for accommodating access for the mobility impaired in effect at the time of facility design.

In planning and designing the facility, RTD's maintenance procedures shall be reviewed and Operations personnel shall be consulted to ensure that the new facility provides an efficient work environment.

**END OF SECTION**

**THIS PAGE LEFT INTENTIONALLY BLANK**

## TABLE OF CONTENTS

### SECTION 12 – SYSTEM-WIDE ELECTRICAL DESIGN

12.1	GENERAL .....	2
12.2	CONDUIT, DUCTBANKS, AND RACEWAYS.....	2
12.2.1	Codes and Standards.....	2
12.2.2	Conduit, Ductbank, and Raceway Products.....	2
12.2.3	Functional Requirements .....	3
12.2.4	High Voltage Ductbanks.....	3
12.2.5	Utility and Street Lighting Raceways.....	4
12.2.6	Systemwide Ductbanks .....	4
12.3	SYSTEMWIDE RACEWAYS.....	5
12.3.1	Conduit.....	5
12.3.2	Station Platforms .....	5
12.3.3	Pedestrian Bridges .....	5
12.3.4	Maintenance Facilities .....	6
12.3.5	Parking Structures .....	6
12.3.6	Park-n-Ride Lots .....	6
12.3.7	Cable Tray.....	6
12.3.8	Cable Trough.....	7
12.4	MANHOLES, HANDHOLES AND PULLBOXES.....	7
12.5	SYSTEMS GROUNDING.....	8
12.5.1	Platforms .....	8
12.5.2	Fences.....	8
12.5.3	Metallic Objects within ROW .....	8

#### List of Tables

Table 12-1 - Minimum Illumination Levels .....	7
Table 12-2 - Grounding Requirements for Typical ROW Structures* .....	8

## **SECTION 12 - SYSTEM-WIDE ELECTRICAL DESIGN**

### **12.1 GENERAL**

This section establishes the design criteria for various electrical facilities including passenger stations, park-n-ride stations, systems buildings, and ductbanks. The entire infrastructure needed to support the signal systems, communications systems, traction electrification, corrosion control, lighting, grounding, etc. shall be designed and installed with the civil portion of the project. Coordination and interfacing with the other systems designers, civil design, architectural, mechanical, utility, structural, and trackwork shall be maintained to ensure uniform approach to all installations.

### **12.2 CONDUIT, DUCTBANKS, AND RACEWAYS**

This section describes the design criteria necessary to provide raceway and ductbank systems for all power wiring and system cables on RTD's Commuter Rail and facilities. The system wide electrical raceway and ductbank system includes conduits, ductbanks, cable trays and cable trough installations and related manhole, handhole and pullboxes. The following sections apply to all conduit, ductbanks, and raceways for traction power, signals, communications, and corrosion control.

#### **12.2.1 CODES AND STANDARDS**

All conduits, ductbanks, and raceways designs shall conform to the latest edition of the following codes where applicable:

- National Electrical Code (NFPA-70)
- National Electrical Safety Code (ANSI/IEEE C.2)
- Electrical Codes or Amendments of the local Authority having jurisdiction
- American National Standards Institute (ANSI)
- National Electrical Manufacturers Association (NEMA)
- Institute of Electrical and Electronics Engineers (IEEE)
- National Fire Protection Association (NFPA 10 and 130)
- The Occupational Safety and Health Act (OSHA)

#### **12.2.2 CONDUIT, DUCTBANK, AND RACEWAY PRODUCTS**

All conduit, ductbank, and raceway products used shall in all cases be listed and labeled by a nationally recognized electrical safety testing organization.

Raceways shall be galvanized rigid steel conduit (GRSC), PVC Schedule 40 conduit, PVC Schedule 80 conduit, PVC Schedule 40 Multi-celled conduit, Multi-Celled Micro-duct conduit, PVC coated galvanized rigid steel conduit (PVC/GRSC), rigid non-metallic fiberglass reinforced epoxy conduit, electrical metallic tubing (EMT), liquid-tight flexible metal conduit or flexible metal conduit.

Cable trays shall be aluminum, fiberglass-reinforced plastic, welded or swaged steel hot-dipped galvanized after fabrication, ladder type with formed rungs and channel type side rails with inward or outward turned flanges. Special design circumstances may require physical protection of the cables, and solid or ventilated cable trays and covers may be used.

Cable trough and cover shall be a dielectric material, High Density Polymer Concrete, pre-fabricated, nonmetallic, rated for exterior below grade use, resistant to sunlight exposure and suitable for use in wet locations. Individual cable trough sections shall interlock together to make a continuous cable trough without gaps. Covers shall sit inside the trough, be flush with the finished grade, be designed to withstand excessive loading and not shatter and be secured with stainless steel vandal proof hardware. The weight of each cover shall not exceed the allowable handling weight as per OSHA requirements.

### **12.2.3 FUNCTIONAL REQUIREMENTS**

All power wire and systems cables shall be protected by conduit, cable tray, or cable trough per this section, except for low voltage signal or communication wiring protected from physical damage within traction electrification facilities, signal or communication buildings and rooms, bungalows, or cases. Installations shall comply with the NEC and all county and city codes.

Spare raceway capacity shall be provided in the mainline signal and communication (SC) ductbank, TE, HV, and lateral ductbanks or conduit runs including station platforms. Spare capacity shall be defined as the remaining useable capacity within a raceway in conjunction with NEC requirements. Spare cable tray or cable trough capacity shall be provided in all installations for future equipment. RTD may determine that the spare capacity is not necessary at various locations; due to the expense that would be incurred and this requirement may be reduced in capacity or eliminated.

Manholes and Handholes shall be provided in mainline SC ductbanks, where required. Handholes shall be provided in lateral ductbanks and conduit runs at junction points as required for wire and cable pulling. On commuter rail bridges, in tunnels and shafts, pull boxes shall be provided with the raceways.

Ductbanks shall be located precisely on all plan view design drawings. Ductbanks shall be sloped where possible to drain to manholes or handholes, be located to avoid interference with new or existing utilities, and be located at a minimum depth of 36 inches below finished grade. Conduits shall be limited to a maximum of 270° of bend between manholes, handholds, junction boxes, or termination points.

### **12.2.4 HIGH VOLTAGE DUCTBANKS**

High voltage (greater than 600V) and traction electrification ductbanks shall be GRSC, PVC/GRSC, or PVC schedule 40 conduits encased with 2500 psi red concrete, and the conduits separated from other systems per the NEC requirement.

If required because of electromagnetic interference (EMI), high voltage AC conductors shall be installed in galvanized rigid steel conduit or other means shall be taken to mitigate the effects of the EMI.

## 12.2.5 UTILITY AND STREET LIGHTING RACEWAYS

Utility raceway and ductbank installations shall meet the construction and material of the local utility if installed under an RTD contract.

For all street lighting systems not maintained by RTD, but installed under an RTD contract, the raceways shall meet the construction and material requirements of the local authority having jurisdiction.

## 12.2.6 SYSTEMWIDE DUCTBANKS

Mainline Ductbanks shall be PVC Schedule 40 conduit, Multi-celled PVC Schedule 40 conduit, or Multi-celled Micro-duct conduit, embedded in Controlled Density Fill (CDF) concrete. Use GRSC, PVC Multi-celled Schedule 40, or PVC Schedule 40 elbows with a radius greater than 6 foot as required per the Contract Specifications. Signal/Communication Lateral Ductbanks shall be PVC Schedule 40 conduit encased in 1500 psi concrete using GRSC or PVC Schedule 40 elbows with a radius greater than 6 foot as required per the Contract Specifications. Traction electrification (TE) ductbanks initiating from facilities to the first manhole outside of the alignment shall be PVC Schedule 40 conduit encased in 2500 psi steel re-enforced red concrete using GRSC or PVC Schedule 40 elbows with a radius greater than 6 foot. TE Ductbanks initiating from the first manhole outside of the alignment to all subsequent manhole and feeder poles within the alignment shall be PVC Schedule 40 conduit encased in 2500 psi non-steel re-enforced red concrete using GRSC or PVC Schedule 40 elbows with a radius greater than 6 foot. Ductbanks with reinforced steel rebar shall be used for special utility and roadway crossings. The exact ductbank dimensions vary with the number and size of conduits. Plastic spacers shall be provided between conduits to allow for concrete-encasement around the conduits. The minimum spacing between conduits is 1.5 inches for signal/communication conduits and 3 inches for traction electrification and power conduits unless otherwise required by the NEC. The overall concrete-encasement around the outside conduits shall be a minimum of 3 inches on all sides.

Ductbanks shall be located longitudinally along the length of the trackway and between the mainline tracks. Generally, the ductbank is located below the end of the track ties at a depth of 36 inches so that conflict with OCS and signal foundations is avoided and the ductbank runs in a straight line between conduit transitions into manholes. If required, due to special circumstances, ductbanks located other than between the mainline tracks will be determined solely at the discretion of RTD. Ductbanks are to be set on a prepared and compacted bed.

When it is necessary, lateral ductbank crossings below the track are permitted as long as the ductbank meets the minimum depth requirements.

Where obstacles such as underground utilities or foundations are encountered the ductbank shall be gradually offset around or under them and must meet the concrete-encasement and conduit bending requirements.

## **12.3 SYSTEMWIDE RACEWAYS**

### **12.3.1 CONDUIT**

The final signal/communication raceway connections (normally the last 10 feet of the conduit installed) to signal equipment or into houses and cases may be direct buried and shall be schedule 80 PVC conduit.

On bridges, exposed raceways for signal, communication, traction electrification, and lighting shall be galvanized rigid steel conduit or rigid non-metallic fiberglass reinforced epoxy conduit. If raceways are concealed as an integral part of an emergency pedestrian walkway schedule 40 PVC conduit may be used, except for transitions at the end of the bridge, which shall be PVC/GRSC conduit direct buried or ductbank with GRSC conduit. Transitions at the end of bridges and bridge expansion joints require expansion couplings.

### **12.3.2 STATION PLATFORMS**

For station platforms, raceways shall be schedule 40 PVC conduit embedded in fill and located at a minimum depth of 18 inches below the finished grade of the platform slab. All conduit stub-ups through the platform slab or foundations shall be PVC/GRSC conduit. Platform handholes shall be located along the platform, generally towards each end and in the middle of the platform to provide junction points for the communication cables and power wiring. Handholes and covers shall be pre-cast high density polymer concrete type with split covers if used for communication cables and power wiring and the box sections shall be divided. For all mainline platform conduit penetrations into the handholes that run the length of the platform, they shall enter the side of the handhole and be provided with bell ends. All lateral conduit penetrations into handholes shall enter the bottom of the handhole and be provided with bell ends.

Communication conduits shall be provided to all planned and future communication equipment on the station platforms. Spare conduits shall be provided to all mainline conduit runs along the length of the platform, and to all shelters including future shelters. All exposed conduits shall be painted to match the structure which to it is attached.

### **12.3.3 PEDESTRIAN BRIDGES**

For pedestrian bridges, raceways for signal, communication, traction electrification, and lighting conduits shall be GRSC conduits, PVC/GRSC conduits, or rigid non-metallic fiberglass reinforced epoxy conduit if exposed or concealed.



#### **12.3.4 MAINTENANCE FACILITIES**

For maintenance facilities, interior installations of raceways shall be EMT, GRSC, or flexible metal conduits at dry locations not subject to damage; GRSC at dry locations subject to damage; and PVC/GRSC or liquid tight flexible metal conduits at wet or damp locations. All exterior installations of raceways shall be GRSC, PVC/GRSC, or liquid tight flexible metal conduits. All raceway installations under-slabs or in-slabs of structures shall be GRSC, PVC/GRSC or PVC conduit, and all conduit stub-ups through the building slab or foundations shall be PVC/GRSC.

For the yard and site areas of maintenance facilities, ductbanks with manholes and handholes shall be provided. All street or yard lighting system raceways within the track areas of the maintenance facility shall be schedule 80 PVC conduit, and direct buried 36 inches minimum below grade. For parking lot lighting and street lighting systems, outside the track areas, the raceways shall be schedule 40 PVC conduit, and direct buried 30 inches minimum below grade.

System raceways shall be provided to all planned and future system equipment at the maintenance facility. Provide spare capacity in all system raceways for future equipment. Spare capacity shall be defined as the remaining useable capacity within a raceway in conjunction with NEC requirements

For communication, signal, or traction electrification facilities rooms within the maintenance building, cable trays may be used. Spare cable tray capacity shall be provided for future equipment.

#### **12.3.5 PARKING STRUCTURES**

The raceways requirements for parking structures shall be the same as for maintenance facilities.

#### **12.3.6 PARK-N-RIDE LOTS**

For park-n-ride lot lighting and street lighting systems that are maintained by RTD, raceways shall be schedule 40 PVC conduit, and direct buried 30 inches minimum below grade. Raceways buried less than 30 inches below grade shall be concrete encased.

Communication conduits and pullboxes shall be provided to all planned and future communication equipment at the park-n-ride lots. Pull box requirements shall be the same as listed for station platforms.

#### **12.3.7 CABLE TRAY**

The use of cable trays is restricted to use within systems buildings. Cable trays and supports shall be designed to provide adequate strength to support the weight of the tray, cables, and future cables and meet the local seismic requirements. The use of fiberglass cable tray shall generally be limited to DC cables.

### **12.3.8 CABLE TROUGH**

The use of cable trough is restricted to trackways and its use shall be determined solely at the discretion and approval of RTD. If required, due to special circumstances, cast-in-place type cable troughs may be located on commuter rail bridges. Covers for cast-in-place cable troughs shall be pre-fabricated high density polymer concrete and be secured with stainless steel vandal proof hardware. The capacity of the approved cable trough shall be 200% of the feeding conduit system.

Cable trough may be used for signal, signal power and communication cables only. The cable trough shall have integral dividers to maintain separation between signal, signal power and communication cables. Cables shall only enter or exit the cable trough through cable trough handholes or pullboxes that are an integral part of the cable trough system.

The cable trough shall be located longitudinally along the length of the trackway and shall not be located between mainline tracks. Cable troughs shall not be located directly above longitudinal runs of track drains or other utilities. Where obstacles, such as OCS and signal foundations, or utility manholes are encountered, the cable trough shall be gradually offset around the structure. Cable trough shall be placed in a level trench, with the lids flush with finished grade.

Cable troughs shall not be used in station platform areas, road and pedestrian crossings, high rail accesses and any areas accessible to pedestrians.

### **12.4 MANHOLES, HANDHOLES AND PULLBOXES**

Manholes and handholes shall be of the pre-cast concrete type or pre-cast polymer type, complete with cable supports, pulling irons, and a ground rod, and all metallic parts shall be internally grounded. Manholes or handholes installed in streets shall be equipped with a cast iron cover and grade ring suitable for H-20 street loading and which can be adjusted for final grade. In other locations, manhole covers shall be torsion assisted hot-dipped galvanized steel diamond plate suitable for H-20 street loading and handhole covers shall be hot-dipped galvanized steel diamond plate or polymer suitable for H-20 street loading.

Pullboxes shall be welded hot-dipped galvanized steel boxes or cast-in-place boxes with hot-dipped galvanized steel diamond plate covers, for use on commuter rail bridges, in tunnels and in shafts. All manholes, handholes and pull boxes shall be identified with welded raised lettering, except platform handholes, which shall be cast integral with the cover. The lettering shall indicate the contents of the item.

Manholes, handholes, and pull boxes shall be located such that the raceways do not exceed 270 degrees between wire and cable pull points.

## **12.5 SYSTEMS GROUNDING**

### **12.5.1 PLATFORMS**

Grounding for passenger stations shall consist of a ground system under each facility composed of a buried exothermically welded grid or counterpoise wire-and-rod system. All metal components of transit facilities and within 15 feet of centerline of track including shelters, fences, poles, guardrails, handrails, swing gates, pedestrian barriers, and bollards that are susceptible to contact by patrons and/or operating and maintenance personnel shall be electrically grounded to the ground grid. Lighting and low-voltage power distribution systems shall be grounded per National Electrical Code. At strategic points along the platform, determined by the Architects, provide copper ground plates bonded to the platform ground grid. Install the ground plates flush with the platform surface. The ground system of each platform shall be connected to the running rails via impedance or drain bonds to maintain the rails and platform at equal potential. Static wire, OCS poles and supports shall be grounded as required for grounding at passenger stations in SECTION 09 TRACTION ELECTRIFICATION SYSTEM DESIGN,

### **12.5.2 FENCES**

Conductive fencing within 15 feet of the centerline of the near rail shall be grounded. Distance between ground connections for long fences shall be determined by a Grounding Study during detail design phase. Where gates interrupt the fence, the fence shall be grounded at each side of the gate and a flexible ground strap used to bond the gate to the fence. Fences shall also be grounded at or near the location where a supply line crosses them, and additionally, at distances not exceeding 150 ft on either side.

### **12.5.3 METALLIC OBJECTS WITHIN ROW**

Metallic objects within 15 feet of the centerline of energized track, including OCS poles, signal cabinets, bungalows or buildings, and guardrails on bridges, shall be grounded. Ground electrode or electrodes shall be installed to obtain ground resistance of 25 ohms or less. Protective barriers and guard rails on bridges shall be grounded via connection to the static wire. Refer to SECTION 9.4 of TRACTION ELECTRIFICATION SYSTEM DESIGN for additional grounding requirements.

**TABLE 12-2 - GROUNDING REQUIREMENTS FOR TYPICAL ROW STRUCTURES\***

<b>Structure</b>	<b>Requirement</b>
Fences	$\leq 25\Omega$
Signal Houses	$\leq 15\Omega$
Comm Houses	$\leq 25\Omega$
Metallic Buildings	$\leq 25\Omega$
Bridge Guardrails	$\leq 25\Omega$
OCS Poles	$\leq 25\Omega$
Lightning Arrestors	$\leq 5\Omega$

\*This table does not include all structures that will require grounding

**END OF SECTION**

**THIS PAGE LEFT INTENTIONALLY BLANK**

**TABLE OF CONTENTS**  
**SECTION 13 – COMMUTER RAIL VEHICLES**

<b>13.1</b>	<b>GENERAL</b> .....	<b>4</b>
13.1.1	Definitions.....	4
13.1.2	General Description.....	5
13.1.3	Train Consist.....	5
13.1.4	Code Compliance and Compatibility with Railroad Requirements.....	5
13.1.5	Elderly and Disabled Accessibility.....	6
13.1.6	Winter and Airborne Debris.....	6
13.1.7	Environmental Conditions.....	6
13.1.8	Operating Environment.....	6
13.1.9	Train Crew Size.....	6
13.1.10	Fare Collection Methods.....	6
<b>13.2</b>	<b>GENERAL VEHICLE REQUIREMENTS</b> .....	<b>6</b>
13.2.1	Dimensions.....	7
13.2.2	Car Weight and Passenger Loading.....	9
13.2.3	Clearances.....	9
13.2.4	Performance.....	14
13.2.5	Adhesion Management.....	16
13.2.6	No-Motion Detection.....	16
13.2.7	Overspeed Protection.....	16
13.2.8	Positive Train Control.....	16
13.2.9	Duty Cycle Rating.....	17
13.2.10	Electromagnetic Emissions.....	17
13.2.11	Noise.....	19
13.2.12	Shock and Vibration.....	19
13.2.13	Ride Quality.....	20
13.2.14	Reliability.....	20
13.2.15	Maintainability.....	20
<b>13.3</b>	<b>CARBODY</b> .....	<b>20</b>
13.3.1	Car Structure.....	20
13.3.2	Exterior Equipment.....	21
13.3.3	Passenger Doors.....	21
13.3.4	Floor Height.....	22
13.3.5	Floor Covering.....	22
13.3.6	Seating Arrangement.....	22
13.3.7	Seats.....	23
13.3.8	Wheelchair Accommodations.....	23
13.3.9	Lighting.....	24
13.3.10	Windows and Glazing.....	24
13.3.11	Operator’s Cab.....	24
13.3.12	Equipment Lockers.....	25
13.3.13	Special Requirements.....	26
<b>13.4</b>	<b>COUPLER</b> .....	<b>26</b>
<b>13.5</b>	<b>TRUCKS AND WHEELS</b> .....	<b>27</b>
13.5.1	Trucks.....	27

13.5.2	Wheels, Axles, Bearings.....	27
<b>13.6</b>	<b>FRICTION BRAKES .....</b>	<b>28</b>
<b>13.7</b>	<b>ELECTRICAL.....</b>	<b>29</b>
13.7.1	Voltages.....	29
13.7.2	Auxiliary Power Supply.....	29
13.7.3	Low Voltage Power Supply (LVPS).....	29
13.7.4	Transients.....	30
13.7.5	Battery and Battery Charger.....	30
13.7.6	Shop Power.....	30
13.7.7	Communications Equipment.....	30
<b>13.8</b>	<b>HEATING, VENTILATION AND AIR CONDITIONING (HVAC).....</b>	<b>31</b>
<b>13.9</b>	<b>SYSTEM SAFETY REQUIREMENTS .....</b>	<b>31</b>
13.9.1	Flammability and Smoke Emissions.....	31
13.9.2	Emergency Equipment.....	31
13.9.3	Exterior Safety Decals.....	32
13.9.4	Emergency Signage.....	32
<b>13.10</b>	<b>ELECTRIC MULTIPLE UNITS.....</b>	<b>32</b>
13.10.1	Dimensions.....	33
13.10.2	Car Weight and Passenger Loading.....	35
13.10.3	Clearances.....	35
13.10.4	Catenary Voltage.....	36
13.10.5	Performance.....	36
13.10.6	Noise.....	38
13.10.7	Elderly and ADA Accessibility.....	39
13.10.8	Restrooms.....	39
13.10.9	Auxiliary Power Supply.....	39
13.10.10	Propulsion/Dynamic Brakes.....	39
<b>13.11</b>	<b>DIESEL MULTIPLE UNITS.....</b>	<b>44</b>
13.11.1	Dimensions.....	44
13.11.2	Car Weight and Passenger Loading.....	45
13.11.3	Performance.....	45
13.11.4	Noise.....	47
13.11.5	Passenger Doors.....	47
13.11.6	Elderly and ADA Accessibility.....	48
13.11.7	Restrooms.....	48
13.11.8	Auxiliary Power Supply.....	48
13.11.9	Propulsion/Dynamic Brakes.....	49

## LIST OF FIGURES

Figure 13-1	Vehicle Static Clearance Limits from Amtrak 1355 Revision E.....	11
Figure 13-2	Vehicle Dynamic Clearance Limits from Amtrak 1355 Revision E.....	12
Figure 13-3	Vehicle Undercar Curve Clearance Limits from Amtrak 1355 Revision E.....	13
Figure 13-4	Preliminary General Arrangement of Typical EMU Married Pair.....	32

Figure 13-5 Preliminary General Arrangement of Typical EMU Vehicle .....	33
Figure 13-6 Preliminary General Arrangement of Typical DMU.....	44

### List of Tables

Table 13-1 Basic Carbody Dimensions .....	7
Table 13-2 Basic Truck Dimensions .....	8
Table 13-3 Wheel Dimensions .....	8
Table 13-4 Car Weight Abbreviations .....	9
Table 13-5 Design Speeds.....	14
Table 13-6 Maximum Mode Change Dead Times .....	15
Table 13-7 Interior Noise Limits .....	19
Table 13-8 Vibration Limits .....	19
Table 13-9 Pantograph Dimensions.....	34
Table 13-10 EMU Wheel Dimensions .....	34
Table 13-11 EMU Limiting Track Characteristics.....	35
Table 13-12 EMU Car Weight and Passenger Loading .....	35
Table 13-13 EMU Catenary Voltage Requirements.....	36
Table 13-14 EMU Acceleration Requirements.....	37
Table 13-15 EMU Exterior Wayside Noise Limits .....	38
Table 13-16 DMU Car Weight and Passenger Loading.....	45
Table 13-17 DMU Acceleration Requirements.....	45
Table 13-18 DMU Exterior Wayside Noise Levels.....	47



## SECTION 13 - COMMUTER RAIL VEHICLES

### 13.1 GENERAL

Section 13 describes the characteristics of new Federal Railroad Administration compliant RTD Commuter Rail EMU and DMU vehicles which will operate compliant EMUs and DMUs on new and refurbished track. EMUs would receive power from a nominally 25,000-volt alternating current (25 KVAC) overhead Traction Power System (TPS). Vehicles will be procured in married-pair and/or single-car configurations

Sections 13.1 through 13.9 define general railcar design criteria, and are applicable to EMU, and DMU vehicles. Sections 13.10 through 13.12 add specific detail applicable to each individual vehicle type. Other Sections outside 13 define non-vehicle Commuter Rail system elements.

The design criteria generally describe the expected vehicle solution with limiting or average parameters, appropriate for baseline system-interface work. A separate design specification shall refine the vehicle description and add technical detail. Potential vehicle contractors may propose alternative design values, with the final design subject to approval by RTD.

#### 13.1.1 Definitions

- EMU: Electric Multiple Unit. An EMU is an electrically-powered, self-propelled passenger railcar that can respond to local or remote throttle and brake commands. In RTD implementations, power would be received from an overhead contact system. EMUs will be combined with other EMUs to form a train consist.
- DMU: Diesel Multiple Unit. A DMU is a diesel-powered, self-propelled passenger railcar that can respond to local or remote throttle and brake commands. DMUs will be combined with other DMUs to form a train consist.
- Train Consist: A combination of one or more railcars coupled together and operated by one train crew. The smallest revenue service train consist would be two vehicles.
- Married Pair: Two carbodies semi-permanently coupled together to form one autonomous unit. The two EMU carbodies can typically reduce net weight by sharing propulsion equipment such as the pantograph and main transformer. One half of a married pair cannot operate without a compatible other half.
- Single Car: A single carbody that is an autonomous unit. DMUs are typically built as single cars as diesel propulsion equipment and fuel are difficult to share between vehicles. EMU singles typically weigh more than half of an EMU married pair, but can operate as a one-car consist or be combined with married pairs to form consists closely matched to ridership requirements.
- Car or Vehicle: One carbody. Could be a single car or one-half of a married pair.

### 13.1.2 General Vehicle Description

All vehicles shall be non-articulated, four-axle, high-floor commuter railcars. At a minimum, there shall be four passenger doorways, two per side, directly across from one another. All cars shall be equipped with end doors that allow passengers to travel between adjacent cars. EMUs and DMUs shall have two or more powered axles. One end of each EMU and DMU shall have a fully equipped operator's cab. The vehicles shall be capable of multiple unit (MU) operation in consists of up to eight fully functional cars.

The intended service life of all car types shall be 30 years.

### 13.1.3 Train Consist

The train consist is defined as the coupled set of commuter cars. Revenue train consists are planned to vary between two and five cars at initial service levels, though designs shall accommodate future expansion to eight car consists and emergency operations of one eight-car train pulling one dead eight-car train. EMU train consists may be composed of EMU married pairs and/or singles DMU train consists will be composed solely of DMU cars.

The minimum train consist shall be two vehicles. Larger train consists can be formed by coupling married pairs and singles (depending on technology and proposed vehicle configurations) together in combination. Cars shall be oriented to always provide an operator's cab at each train end. This will allow the operator to always be at the leading end of the train.

Due to operational considerations, the placement of EMU singles must be closely monitored to keep pantographs at least one carbody away from any adjacent pantograph. Pantograph spacing affects overhead contact wire dynamic uplift and harmonic oscillation, power collection fault rate, and design considerations of TPS phase breaks.

For yard movements and train make-up activities, powered married pairs and single cars shall each be able to move independently without being coupled to another vehicle. This may require singles to perform reverse operations. Provided safe operating practices are followed, the vehicle design shall permit reverse operations.

### 13.1.4 Code Compliance and Compatibility with Railroad Requirements

The train consist shall be fully compliant with the FRA rules as documented in the Code of Federal Regulations (CFR), in particular Title 49, Part 238, Passenger Equipment Safety Standards (49 CFR 238). Vehicles shall also comply with applicable standards and recommended practices as issued by the American Public Transportation Association (APTA), Association of American Railroads (AAR), and Americans with Disabilities Act (ADA).

The train consist shall be fully compatible with all aspects of the RTD commuter rail system, including the maintenance facilities, clearances, ADA accessibility and operating requirements of the railroad.

### **13.1.5 Elderly and Disabled Accessibility**

Passengers cars shall be accessible to the mobility impaired and shall comply with the ADA requirements as published in 49 CFR 38. A minimum of two ADA-compliant wheelchair locations shall be provided in each car near the doorways at the non-cab end of the car.

### **13.1.6 Winter and Airborne Debris**

All vehicle systems shall be designed to function under conditions of snow, ice and freezing rainstorms, including airborne debris such as leaves, tree or plant seeds, grass cuttings, etc., that may be encountered in the Denver area.

### **13.1.7 Environmental Conditions**

Normal operation of the vehicles in the Denver area environment shall not in any way impair the performance or useful life. Typical environmental characteristics in the Denver area are listed in Section 1.5 of this design criteria.

### **13.1.8 Operating Environment**

The train consist shall be capable of running on all FRA track classes as outlined in Section 4. The train consist shall be operationally compatible with the UPRR, BNSF, and all short line regional railroads and their freight service operation within the Denver area.

### **13.1.9 Train Crew Size**

The train crew is planned to be one operator and one conductor, regardless of consist size. The operator will be stationed in the leading cab while the conductor walks the consist, operating doors and assisting passengers during boarding and alighting.

Fare inspectors may be assigned to the train, but are not considered part of the train crew.

### **13.1.10 Fare Collection Methods**

No on-vehicle fare collection system is required. Wayside vending machines will sell or validate tickets while on-board fare inspectors may perform spot checks of passengers. The vehicles do not require any special provisions for fare collection.

## **13.2 GENERAL VEHICLE REQUIREMENTS**

This section lists the general vehicle requirements for carbody dimensions and weight, track standards, performance, and general operating parameters. Any deviation from these values will require RTD approval.

## 13.2.1 Dimensions

### 13.2.1.1 Carbody Dimensions

Basic carbody dimensions are:

**Table 13-1  
Basic Carbody Dimensions**

Dimension	Value
Nominal overall length over the coupler pulling faces	85 feet, 0 inches
Maximum carbody exterior width over side sheets	10 feet, 6 inches
Maximum carbody exterior width over side door thresholds	10 feet, 0 inches, +/- ¼ inch
Nominal coupler height above rail	34-½ inches
Minimum clearance above top-of-rail for all carbody elements (except wheels) under all conditions	2-¾ inches
Floor height above top-of-rail, AW0, new wheels	See Section 5
Maximum height of roof-mounted equipment	14 feet, 8 inches
Nominal height of side high ceiling (above baggage rack) above floor	7 feet, 5 inches
Nominal height of central high ceiling above floor	7 feet, 3 inches
Minimum height of low ceiling above floor	6 feet, 9 inches
Minimum side door clear opening, width	50 inches
Minimum side door clear opening, height	6 feet, 6 inches
Minimum end door clear opening, height	6 feet, 4-¾ inches
Minimum aisle width, clear (except ADA affected areas)	20-¾ inches
Minimum aisle width, clear (in ADA affected areas)	32 inches
Nominal interior width (at armrest height)	10 feet, 0 inches
Maximum height of bottom of window glass, above floor	34 inches
Minimum height of window opening	24 inches
Minimum seat pitch	32-½ inches
Minimum hip-to-knee space between non-facing seats	30 inches
Design value for spring failure body sway	4 degrees
Design value for normal operational body sway	2.5 degrees
Design value for truck and carbody roll center	22 inches above TOR
Design value for lateral truck suspension shift	2 inches

### 13.2.1.2 Truck Dimensions

Basic truck dimensions are:

**Table 13-2  
Basic Truck Dimensions**

Dimension	Value
Nominal truck center spacing	59 feet, 6 inches
Nominal axle center spacing	8 feet, 6 inches

### 13.2.1.3 Wheel Dimensions

Wheels shall use a narrow-flange profile with a 1:40 tread taper. Other profiles may be proposed, subject to approval by RTD.

**Table 13-3  
Wheel Dimensions**

Dimension	Value
Nominal wheel diameter	36 inches
Maximum wheel wear (on diameter)	3 inches
Wheel gauge, back to back	53- <sup>3</sup> / <sub>8</sub> inches
Minimum worn flange width	7/8 inch

### 13.2.1.4 Track Characteristics

The vehicles shall operate over the track characteristics in Section 4.

### 13.2.2 Car Weight and Passenger Loading

Five levels of car weights are referenced within these design documents. For design calculations, passengers are assumed to weigh 165 pounds per person.

**Table 13-4  
Car Weight Abbreviations**

Abbreviation	Definition
AW0	Empty vehicle operating weight
AW1	Fully seated passenger load and one operator, plus AW0
AW2	Standees at four passengers per square meter of suitable standing space plus AW1 (Structural mean fatigue load, Propulsion performance load)
AW3	Standees at six passengers per square meter of suitable standing space plus AW1 (Braking performance load)
AW4	Standees at eight passengers per square meter of suitable standing space plus AW1 (Structural design load, not contemplated for revenue operation)

Passenger loading should average at least 90 seated passengers per vehicle. Suitable standing space shall be defined as all areas of the aisles where it is possible for passengers to stand.

The carbuilder is encouraged to minimize weight. For design purposes, a maximum allowable AW0 is stated for each specific vehicle type. Weights for AW1 through AW4 are provided for reference purposes only. The carbuilder shall calculate actual weights for the final design. When performing analyses that require weight, the carbuilder shall use whichever value is more conservative – their internal estimates or the reference weights listed in Sections 13.10.2 for EMUs and 13.11.2 for DMUs.

Each car type shall have a maximum end-to-end imbalance not to exceed 5%. The lateral weight imbalance shall not exceed 40,000 inch-pounds.

### 13.2.3 Clearances

#### 13.2.3.1 Track Clearance Envelope

The cars shall comply with Amtrak 1355, Revision E, both static and dynamic clearance diagrams, as provided in Figures 13-1 through 13-3. Additionally, the cars shall conform to the clearance requirements of the UPRR and BNSF railroads for the territory in which the cars are planned for operation.

Amtrak 1355 E defines a dynamic clearance envelope for the carbody under the full range of suspension motions but on level, tangent track. A complete dynamic clearance envelope calculation must also consider lateral wheel/rail motion, cross level variation, superelevation, and horizontal and vertical curvature.

### 13.2.3.2 **Station Clearance Envelope**

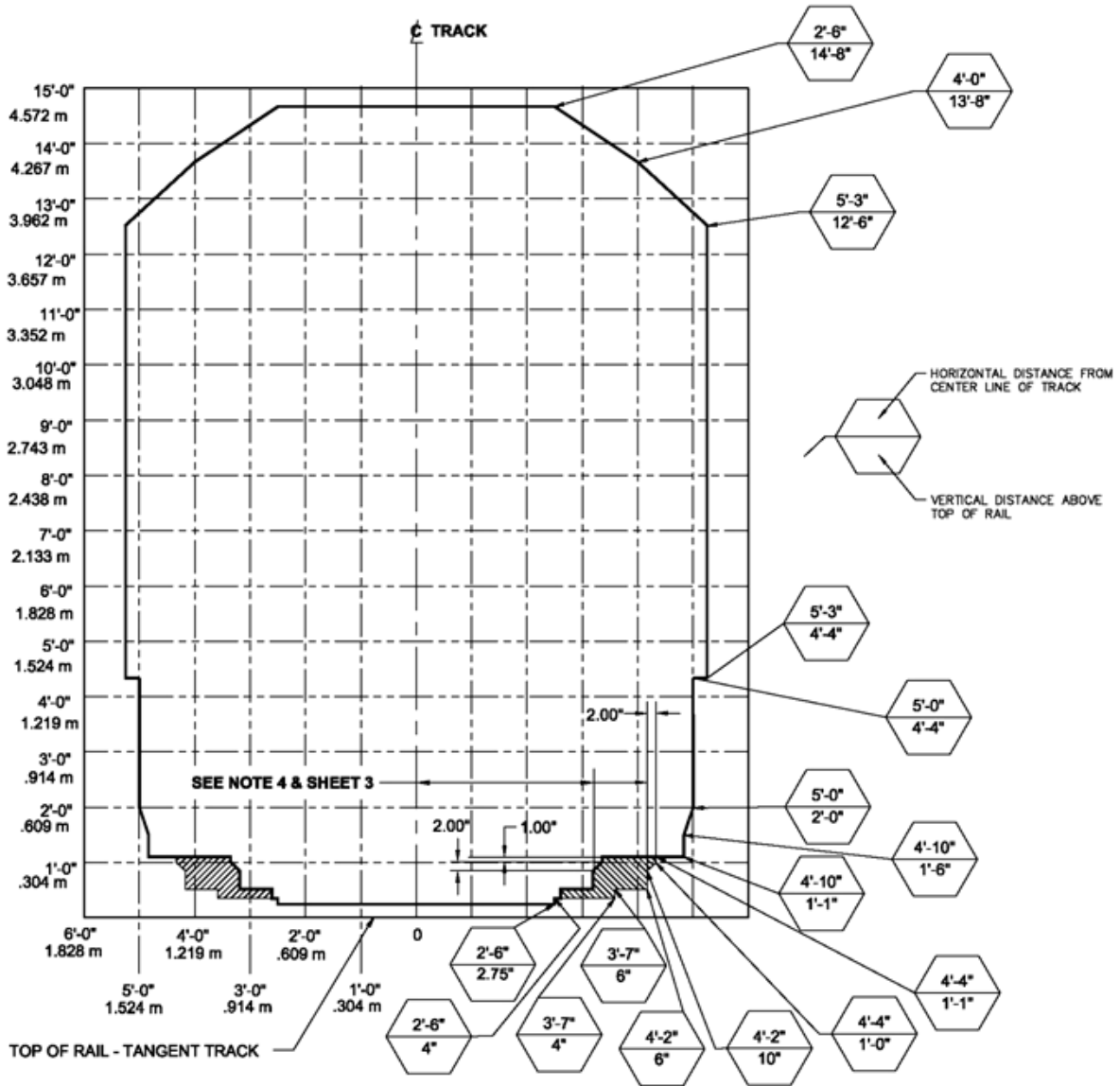
The car shall comply with station clearances defined in Section 5 of this design criteria.

### 13.2.3.3 **Undercar Clearance**

Vertical undercar clearance is defined from top-of-rail (TOR), with the maximum suspension deflection and carbody roll, minimum vertical curve radius and fully worn wheels. The minimum clearance above TOR for all carbody and truck elements, except wheels, under all conditions shall be 2-3/4 inches.

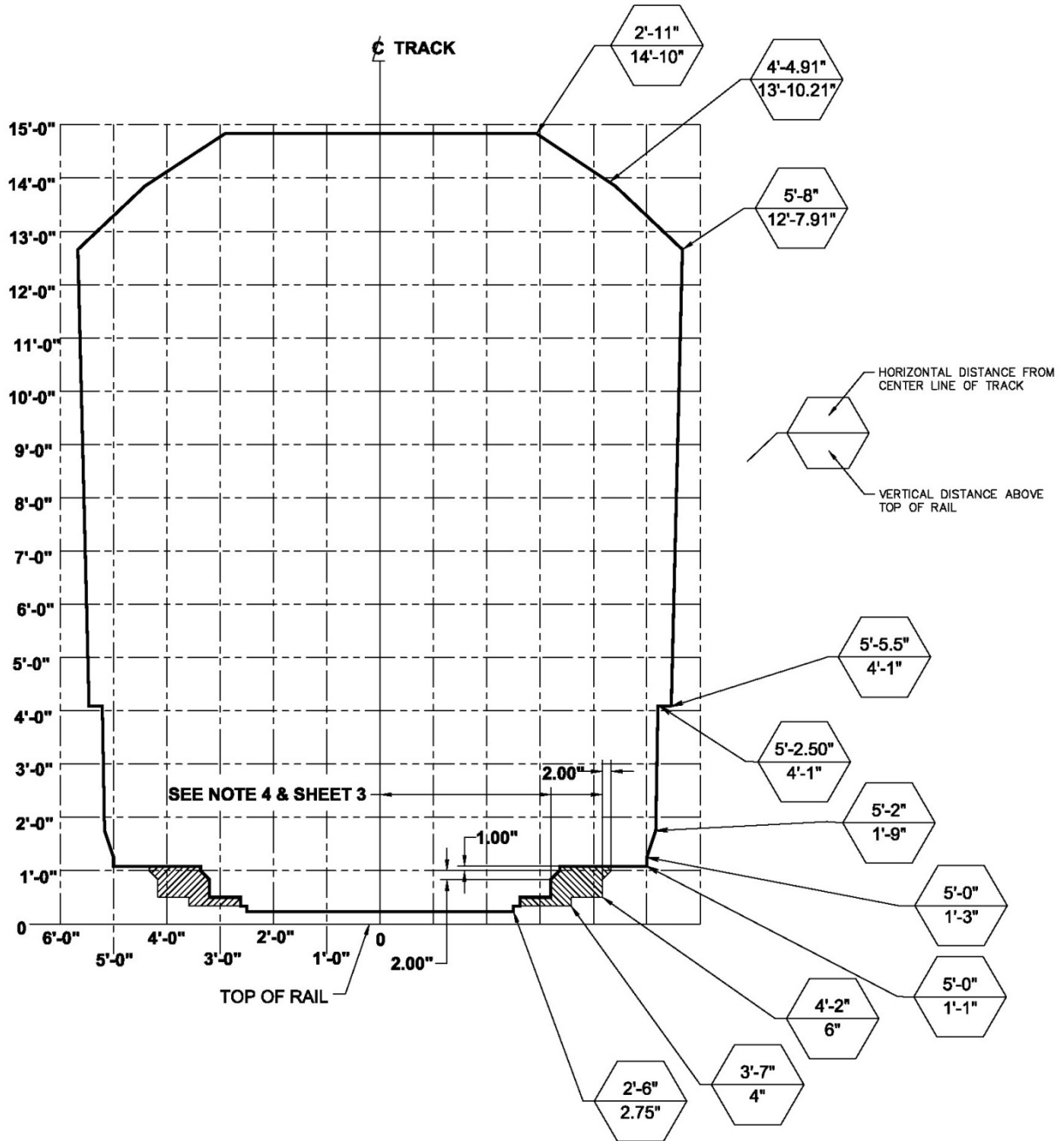
A clearance of at least 1-1/2 inches, exclusive of positive stops, shall be provided between truck parts and carbody parts under the most unfavorable conditions of truck curvature, wheel wear, lateral and vertical motion and roll, and broken and/or deflated springs.

**Figure 13-1  
Vehicle Static Clearance Limits from Amtrak 1355 Revision E**

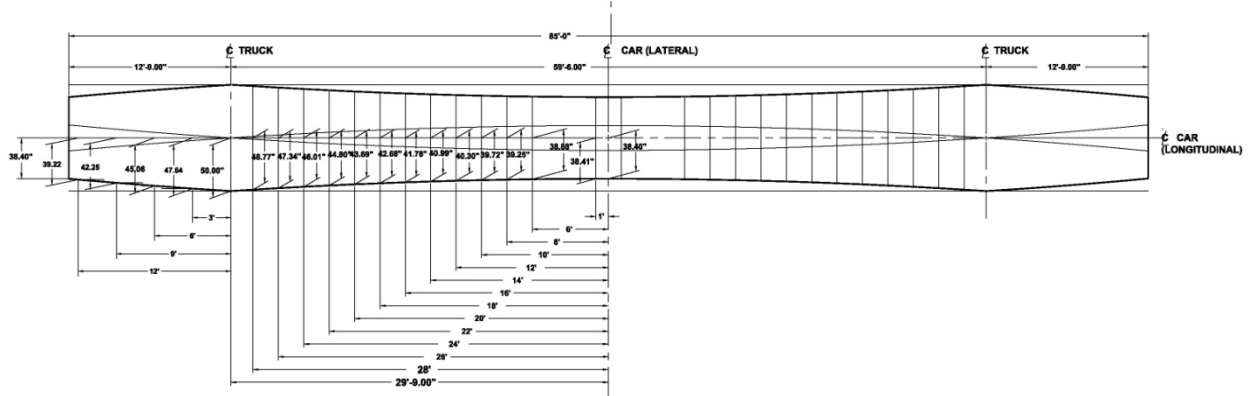




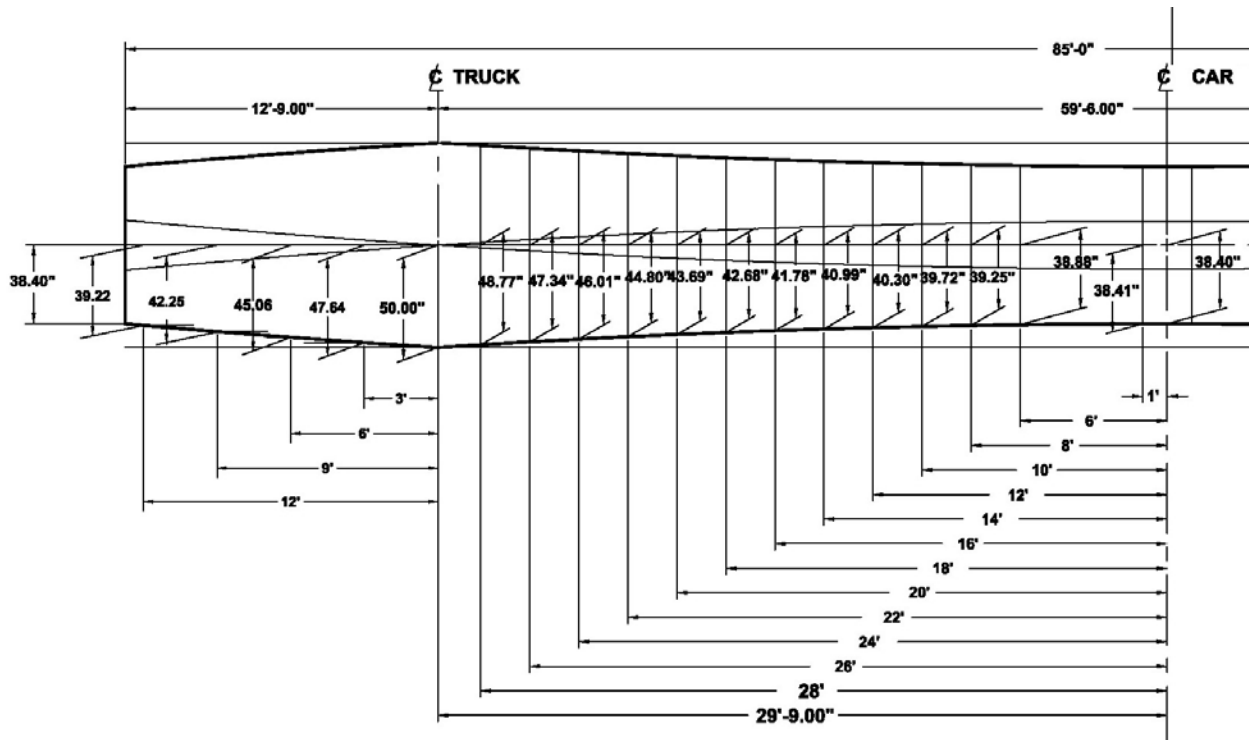
**Figure 13-2**  
**Vehicle Dynamic Clearance Limits from Amtrak 1355 Revision E**



**Figure 13-3**  
**Vehicle Undercar Curve Clearance Limits from Amtrak 1355 Revision E**



Detail magnified for clarity



#### 13.2.4 Performance

This section defines the acceleration, braking, and route travel performance expected of the train consists. Performance limits are applicable to all proposed train consist arrangements of EMUs and DMUs from two cars to eight cars in length.

##### 13.2.4.1 General

Cars shall be designed for the following speeds:

**Table 13-5  
Design Speeds**

Condition	Speed
Maximum revenue operating speed	79 mph (worn wheels)
Design speed	90 mph (new wheels)

##### 13.2.4.2 Route Performance

Simulations shall be performed of AW1-loaded consists, sized from two to eight cars, traveling the intended alignment, based on the latest grade, curvature, and speed limit data available from RTD. Intermediate station dwells shall be modeled at 35 seconds. Simulation results shall be submitted to RTD for review and approval. If route travel times do not meet RTD's operational planning and expectations, RTD may request increased trainset performance levels.

The consists shall have a maximum end-of-route turn time of 7 minutes. The turn time shall allow the operator to disable and leave one cab, walk to the other end of the consist, set up that cab, perform an FRA-compliant Class II brake test (49 CFR 238), and be ready to depart the station.

##### 13.2.4.3 Service Brake Requirement

The service brake requirements for EMUs and DMUs are defined in Sections 13.10 and 13.11.

##### 13.2.4.4 Emergency Brake Requirements

The emergency brake requirements for EMUs and DMUs are defined in Sections 13.10 and 13.11.

These rates shall be met under all weather conditions and with all wheel diameters from new to fully worn wheels on level, tangent track. Emergency braking shall not be jerk-limited and shall be irretrievable down to at least the no-motion detection speed. For emergency brake calculations, the consist may not benefit from train resistance forces.

The emergency brake control system shall be designed in a fail-safe manner. It may blend friction and dynamic braking, with friction braking providing the fail-safe default. The specified emergency braking rate shall be achieved in blended and friction-only applications.

**13.2.4.5 Minimum Safe Brake Rate**

The service and emergency braking system shall be designed and built so that it produces a minimum full service and emergency braking rate of no less than 1.0 mphps on level, tangent track under any single-component failure condition.

**13.2.4.6 Jerk Limits**

Changes in propulsion and braking effort shall develop smoothly.

Changes in tractive effort shall be jerk limited. The jerk limit rate shall be software-adjustable between 1.0 mphpsps and 3.0 mphpsps, and shall initially be set to 1.5 mphpsps, +/- 10%. The loss of tractive effort due to unexpected loss of traction power shall not be jerk limited.

Changes in service braking effort shall be jerk limited. The jerk limit rate shall be 3.0 mphpsps, +/- 10%.

Emergency brake applications shall not be jerk limited.

**13.2.4.7 Spring Applied Parking Brake**

A spring applied parking brake system shall be capable of holding a train consist loaded to AW3 + 10% on a 5% grade indefinitely under all allowable wheel and brake conditions. The parking brake system shall apply in a fail-safe manner and be remote controlled from the active cab.

**13.2.4.8 Mode Change Response Times**

Mode change dead times shall not exceed the following:

**Table 13-6  
Maximum Mode Change Dead Times**

Mode Change	Maximum Response Time
Power to Brake	600 ms
Power to Coast	600 ms
Coast to Brake	300 ms

Mode change dead times from coast to power and brake to power shall be kept as short as possible.

Mode change dead time shall be measured from the time that the applicable control signal changes state until the vehicle acceleration or deceleration reaches 90% of the old commanded value for transitions from Power to Coast or Brake to Coast or 10% of the new commanded value for transitions from Coast to Brake, Power to Brake, Coast to Power, or Brake to Power from a stop.

### **13.2.5 Adhesion Management**

A system shall be provided to detect and correct wheel spin and slide on each car whether random or synchronous on an individual truck basis, both in acceleration and braking.

Efficiency shall be at least 90% in acceleration and in braking for adhesion levels above 5%. Sanders may be used to control adhesion.

### **13.2.6 No-Motion Detection**

A system to detect zero speed shall be provided to be used in conjunction with the door control system for the purpose of preventing the opening of train doors while the train is in motion. The system shall detect vehicle speed down to at least 2.0 mph.

### **13.2.7 Overspeed Protection**

Vehicles shall be prevented from exceeding a maximum track speed. The speedometer in the active cab shall give visual and audible warning to the operator if the overspeed limit is reached. If the operator does not reduce speed within a fixed amount of time, consist tractive effort shall be cut and a penalty brake automatically applied. The overspeed limit shall be software selectable and initially set at 83 mph. Overspeed setting shall be limited by hardware or software keys/passwords.

### **13.2.8 Positive Train Control**

Each married pair and/or single vehicle shall be fitted with a Positive Train Control (PTC) system fully compliant with the Rail Safety Improvement Act of 2008. The PTC system inclusive of Automatic Train Control (ATC) and Cab Signal will likely include, at minimum, a control electronic enclosure, an onboard display unit in each cab, and propulsion and brake system interfaces. Space shall be allocated for the control enclosure in an onboard electrical locker assuming a 19-inch rack-mounted unit at least 12-inches tall. The display unit shall be located in the cab, preferably adjacent to the windshield, but not obstructing the operator's normal forward view. Interfaces with the propulsion and brake system shall be defined in the design specification, but functionally should, at minimum, allow the cab signal system to cut out tractive effort and apply a penalty brake.

### 13.2.9 Duty Cycle Rating

The car shall be capable of continuous operation on the alignment without exceeding the continuous rating of any equipment, under the following conditions:

- A constant AW2 load;
- A dwell time of 35 seconds at each intermediate station;
- Acceleration and braking at maximum service rate;
- Operation to maximum posted track speeds; and
- A seven minute layover at each end of the line.

In addition, one eight-car train with an AW3 load shall be capable of pushing or pulling another train of equal length with an AW3 load from the point of failure to the next station, where passengers would be unloaded. Rescue would continue with both trains at AW0 to the end of the line, at reduced performance if need be, without damage or reduction in equipment life. The point of failure shall be considered to be at the farthest location on any line such that the worst load is imposed on the equipment. The train will be dispatched to the nearest end of the line.

The thermal duty cycle of the friction brake system shall allow an AW3 consist between two and eight cars to operate indefinitely over the route using only the friction brake system, without wheel temperatures exceeding 600°F for new wheels and 800°F for worn wheels, and/or without disc temperatures exceeding 900°F, and without the need to restrict operating speed. This requirement shall be reviewed by the friction brake system supplier; temperature limits may be lowered but not increased.

### 13.2.10 Electromagnetic Emissions

The vehicles shall be designed and constructed so that it does not cause objectionable electrical interference with its own equipment or with any wayside equipment.

Electromagnetic emissions shall meet FCC and ANSI (C63.12.1987) requirements and guidelines.

Vehicles shall be tested to demonstrate compliance with the emission limits defined below, using UMTA-MA-06-0153-85-8. The intent is to ensure these emissions do not adversely affect track signals.

These limits apply to all possible train lengths from two to eight cars in length. The emission limits apply to stationary and moving trains.

#### 13.2.10.1 Radiated Emissions Limits

The radiated emission limits per train shall not exceed the following values, measured 100 feet from the track centerline. Emission limits are stated as dB microvolts per meter per Megahertz (dB $\mu$ V/m/MHz) versus log frequency. The "/MHz" refers to the fact that the broadband signal must be analyzed over 1 MHz bandwidths. The term dB $\mu$ V/m refers to electric field signal strength. Magnetic fields are typically limited to the same values, with the term dB $\mu$ A/m. Only the electric field values are stated here.

- At 14 kHz, the lower limit, a level of 120 dB $\mu$ V/m/MHz.
- A straight line from 120 dB $\mu$ V/m/MHz at 14 kHz to 75 dB $\mu$ V/m/MHz at 200 MHz.
- A straight line from 75 dB $\mu$ V/m/MHz at 200 MHz to 90 dB $\mu$ V/m/MHz at 1,000 MHz.
- 90 dB $\mu$ V/m/MHz from 1,000 MHz to 6,000 MHz.

#### 13.2.10.2 Conductive Emissions Limits

The conducted emissions shall not exceed the following limits when measured per UMTA-MA-06-0153-85-6 suggested test method:

- 0.9 amp from 90 Hz to 205 Hz
- 0.3 amp from 206 Hz to 355 Hz
- 0.038 amp from 356 Hz to 20 kHz

#### 13.2.10.3 Inductive Emission Limits

The induced emissions shall not exceed the following limits per car when measured per UMTA-MA-06-0153-85-8 suggested test method.

- 100 millivolts from 0 to 500 Hz
- 20 millivolts from 501 Hz to 20 kHz

#### 13.2.10.4 Cab Signal Interference (CSI)

The vehicle must not produce emissions which adversely affect the on board cab signal receiver system. In general, the CSI shall be 12 dB below the receiver sensitivity level. The CSI shall not exceed any of the following limits when measured at the output of the track receiver coils in terms of equivalent rail amps:

- 300 milliamps from 90 Hz to 105 Hz
- 150 milliamps from 240 Hz to 260 Hz
- The Train Control susceptibility level as measured per laboratory test (statically at a signal hut).

### 13.2.11 Noise

#### 13.2.11.1 Interior, Passenger Area

Interior noise in the passenger area shall not exceed the following:

**Table 13-7  
Interior Noise Limits**

Vehicle State	Maximum Noise Level	Notes
Vehicle stationary	70 dBA	Windows and doors closed, all auxiliaries operating simultaneously under normal operating conditions, no passengers.
Vehicle moving	75 dBA	Car operating on any line at any speed except in tunnels

#### 13.2.11.2 Interior, Cab

The noise level exposure in the cab during normal operation shall not exceed 75 dBA for twelve (12) hours exposure per day. The absolute upper noise level limit, including operation of air horns, bell, or air brake exhaust, shall be 115 dBA per 49 CFR 229.121.

### 13.2.12 Shock and Vibration

All vehicle equipment shall be designed to operate without damage or degradation of performance when subjected to vibration and shocks encountered during normal service at all speeds up to 10% above maximum running speed. Carbody-mounted components and equipment shall be designed and tested to withstand continuous vibrations in accordance with IEC 61373, 1999, "Railway Application, Rolling Stock Equipment, Shock and Vibration Tests."

Vibrations anywhere on the vehicle floor, walls, ceiling panels and seat frames shall not exceed the following:

**Table 13-8  
Vibration Limits**

Frequency Range	Limiting Parameter	Maximum Value
Below 1.4 Hz	Maximum deflection (peak to peak)	0.1 in
1.4 Hz to 14 Hz	Peak acceleration	0.01 g
Above 14 Hz	Peak velocity	0.45 in/sec



#### 13.2.12.1 Carbody-mounted Components

- Vibrations up to 0.4 g peak to peak, at frequencies up to 100 Hz.
- Impact loads of 4 g lateral, 4 g vertical, and 8 g longitudinal.

#### 13.2.12.2 Truck-frame-mounted Components

- Vibrations up to 4 g peak to peak at frequencies up to 100 Hz.
- Impact loads up to 20 g each applied individually on any major axis.

#### 13.2.12.3 Truck-axle-mounted Components

- Vibrations up to 10 g peak to peak at frequencies up to 100 Hz.
- Impact loads up to 50 g each applied individually on any major axis.

#### 13.2.13 Ride Quality

The RMS acceleration values shall not exceed the "four hour, reduced comfort level (vertical)" and "2.5 hour, reduced comfort level (horizontal)" boundaries derived from ISO 2631-1:1997(E) over the range of 1 Hz to 80 Hz, for all load conditions AW0 to AW3, and track classes 1 to 4.

#### 13.2.14 Reliability

The vehicle shall be designed to maximize Mean Time Between Failures (MTBF).

#### 13.2.15 Maintainability

The vehicle will be designed to minimize Mean Time To Repair (MTTR).

### 13.3 CARBODY

#### 13.3.1 Car Structure

The vehicles shall be designed and manufactured to be in compliance with 49 CFR 238 requirements applicable to Tier I Passenger Equipment and with all applicable APTA and AAR standards and recommended practices.

The carbody shall meet the latest 49 CFR 238 and APTA SS-C&S-034, "Standard for the Design and Construction of Passenger Railroad Rolling Stock," Section TS 5.1.1.1 applied longitudinally on the centerline of draft to the coupler or drawbar anchor of a carbody loaded to AW0.

Carbody cab end areas shall be designed for controlled crushing of the structure in the case of a head-on collision.

The vehicle body shall consist of the roof, the side frames, the underframe, and the end frames. The underframe shall consist of two end underframes, two side sills, body bolsters, and floor beams. Intermediate body sills may be used in the underframe, if necessary.

RTD will consider cab ends constructed with fiberglass reinforced plastic panels to provide stylized end contours, provided the design meets all structural requirements in this section and applicable FRA regulations.

### 13.3.2 Exterior Equipment

A horn shall be provided at the cab-end of each vehicle, with controls located on the cab console. Horns shall comply with 49 CFR 229.129 and be located on the vehicle roof. They shall be tilted and be provided with a shield or deflector to prevent accumulation or packing of debris in the cone.

The cab-end of each car shall have headlights and auxiliary lights complying with APTA and 49 CFR 229.125 requirements. The auxiliary lights shall wag (alternatively flash) when the horn is sounded.

A snow plow or a snow-plow type pilot shall be provided under the cab-end of each vehicle. The lower two inches of the pilot shall be easily replaceable with fasteners. The minimum height of the pilot above top-of-rail, as measured statically on level, tangent track at any weight between AW0 and AW3 and any state of wheel wear, shall be 6 inches.

The pilot shall resist a longitudinal load of up to 20,000 lbs without permanent deformation. The pilot support structure shall be designed to yield at a maximum of one half the yield load of the associated undercar structure.

Cars shall be equipped with red end-of-car marker lights, lighted car number signs, and passenger destination signs. One three-light indicator shall be located on each side of each car to signal brake and door status.

Each car shall be equipped with safety appliances fully compliant with 49 CFR 231.

### 13.3.3 Passenger Doors

Each passenger vehicle shall have four high level door openings, two on each side, directly across from each other. Doorways shall be located just inboard of the trucks.

Clear width of all doorways shall be at least 50 inches. Doorway height, measured from the vehicle floor level to the bottom of the door header, shall be a minimum of 78 inches.

Doors shall be of the sliding pocket or plug type and cover the entire height of the door opening. Two-panel designs shall be used. Panels shall not protrude more than 3 inches from the vehicle side during any portion of the opening or closing cycle. All door equipment shall be interchangeable.

Doors and doorways shall be designed and constructed in accordance with 49 CFR 238.235 and APTA RP-C&S-012-99, "Recommended Practice for Passenger Door Systems for New and Rebuilt Passenger Cars", unless otherwise specified in this section. Doors shall also serve and be marked as an

additional emergency exit in accordance with APTA SS-PS-002-98, latest Rev., "Standard for Emergency Signage for Egress/Access for Passenger Rail Equipment.

The doors shall be microprocessor controlled and use an electric operating mechanism. The controller shall respond to external commands, monitor door positions and status, and provide diagnostic and status information to portable test units (PTUs). Basic door operating parameters shall be adjustable via the PTU.

The door control system shall be designed in accordance with the safety requirements. Trainline door control signals shall allow the conductor to open and close all consist doors from any door control station. Each car shall be equipped with at least two door control stations, one on the vehicle left and one on the vehicle right. The conductor shall have a clear view along the length of the consist from each door control station. Door control stations shall have appropriate key locks and interlocks to prevent unauthorized use while maintaining door emergency exit functionality.

All door control units shall be linked together with a serial data connection such that the status of all doors may be monitored at a single location in the vehicle.

Vehicle end doors shall be single panel, manually operated, hinged-inward units. Each door shall be designed and built in compliance with vehicle endwall standards. Cab end doors shall be latched with at least three rotary "dog" latches and one passenger-operable latch. The conductor shall be able to lock the door closed to prevent unauthorized use when the door is in the leading or trailing position of the consist. The door should be equipped with an emergency window, but not necessarily an emergency latch.

#### **13.3.4 Floor Height**

The vehicle floor shall be nominally level, without interior steps or ramps to change elevation, and shall provide level boarding with platform description in Section 5.

Floor height shall be adjustable through the vehicle suspension and maintain high-level boarding compatibility through the expected range of vehicle loading and wear.

#### **13.3.5 Floor Covering**

The floor covering under the seat areas and in the aisles shall be smooth grade rubber sheeting

#### **13.3.6 Seating Arrangement**

Passenger seats shall be arranged in rows of transverse seat pairs, with seats to the left of carbody centerline and seats to the right. The majority of seating should accommodate two passengers (2x2 seating), though limited use of three-position seats (3x2 seating) will be considered if required to meet the target car

seating capacity. Seats should face the nearest exit, with the majority of seats in a front-to-back orientation. Some longitudinal and flip-up seats may be used near interruptions in car interior and wheelchair accommodations.

Seating arrangement should coordinate with vehicle side window spacing.

### 13.3.7 **Seats**

Standard passenger seats shall be a pair of seats, attached to the vehicle interior sidewall and through a single pedestal foot to the floor structure. Arm rests shall be provided on the exterior edges but not between seats. The aisle armrest should be foldable to assist seat egress. Seat backs should be tall and supportive with head rests, but do not need to recline. Hand holds shall be provided near the seat headrests along the aisle.

Longitudinal and flip-up seats should be significantly similar to the standard passenger seats, but adapted to local design constraints.

Seats shall be a proven design used in rail transit applications. They shall conform to APTA SS-C&S-016-99, "Standard for Seating in Commuter Rail Cars," including structural testing for seat strength and structural attachment.

Seats shall have modular, replaceable, cloth covered seat cushions, back rests, and head rests. No footrests or tray tables shall be provided.

### 13.3.8 **Wheelchair Accommodations**

Each vehicle shall have at least two priority wheelchair parking spaces, located adjacent to the non-cab end side entry doors. Such locations shall provide adequate floor space and structural attachments for mobility device restraint. The passenger seats closest to these locations shall have adequate access to allow a passenger to transfer between a wheelchair and the seat, and shall accommodate companion seating.

### 13.3.9 Lighting

Interior lighting shall be provided predominantly by two rows of overhead fluorescent lights, recessed and integrated into the interior finish. High-frequency inverter ballasts shall power the fluorescent fixtures. Passenger area light levels shall comply with APTA RP-E-012-99, "Recommended Practice for Normal Lighting Design." Lighting shall be supported by the vehicle low voltage power supply (LVPS) to minimize flickering and interruption due to temporary loss of traction power supply. Except for interior passenger lighting, headlights, roof lamps, and cab ceiling lights, all lights shall be LED based.

The interior lights shall also comply with 49 CFR 238.115 and APTA SS-E-013-99, "Standard for Emergency Lighting System Design." Emergency lights may be a subset of the normal interior lights or independent installations. The fluorescent fixture adjacent to each doorway, as well as other specified light fixtures, will be powered directly from the battery to provide emergency lighting during LVPS failure.

#### 13.3.9.1 Low-Location Exit Path Marking

The vehicle shall be equipped with a low-level exit path marking per APTA SS-PS-004-99, latest Rev., "Standard for Low-Location Exit Path Marking," to illuminate the emergency exit path. A passive or active solution may be presented to RTD for approval.

### 13.3.10 Windows and Glazing

All exterior windows in the car shall be certified as meeting the requirements of 49 CFR 223 and 49 CFR 238.221. The certifications shall indicate that all end-facing windows meet the requirements of Type I testing, and that all side-facing windows meet the requirements of Type II testing. Glass or polycarbonate may be used.

A minimum of four side-facing emergency exit windows shall be provided meeting the requirements of 49 CFR 238.113. It is strongly preferred that at least four emergency exit windows be provided per vehicle side rather than the FRA-minimum of four per vehicle. Each emergency exit window shall provide an unobstructed opening of at least 26 inches horizontally and 24 inches vertically.

### 13.3.11 Operator's Cab

The operator's cab shall provide control devices for operating the train in an ergonomic, climate-controlled environment. The operator's cab shall provide mechanical door locks and electronic key switches to prevent unauthorized access and use.

The operator's cab shall be located at one end of each vehicle to allow maximum flexibility in consist sizing and make-up. The cab shall be located on the right side of the carbody with its own walls and access door. The cab shall have one forward facing fixed window and one side-facing, opening window.

The cab shall provide a desk-like console for the throttle and brake controls. The operator's seat shall swivel to assist access. It shall have vertical and longitudinal adjustments to accommodate operator's ranging between 5th and 95th percentile US males and females, as defined by Military Standard MIL-STD-1472, latest revision. It shall also provide vertical suspension and damping. Seat adjustments shall be electronic or manual. The seat shall comply with APTA and FRA strength requirements.

An observer's cab shall be provided in the forward left corner of each vehicle, also with its own walls and two windows. Observer controls shall be less than the operator, but shall, at minimum, include a speed indicator, a horn actuation switch, and an emergency brake application handle.

The operator's and observer's side-facing windows shall meet the requirements of 49 CFR 238.113 for emergency exit windows and shall provide an unobstructed opening of at least 26 inches horizontally and 24 inches vertically. These windows shall not be assumed accessible to passengers and shall not count toward the emergency exit window criteria stated in Section 13.3.10.

An outside mirror shall be provided near the operator's and observer's cab side windows to allow rearward sight down the side of the consist. Mirrors shall be electronically heated, independently adjustable, and comply with the vehicle clearance specifications.

The operator's and observer's cab shall be arranged to allow passenger access to the vehicle end door when the cabs are not occupied. Cab doors may be arranged to prevent passengers from being in the space between cabs while the cabs are occupied.

#### **13.3.12 Equipment Lockers**

Limited equipment lockers are anticipated to be located within the passenger area of the vehicle. Lockers should be located to minimize the impact on passenger movement and seating arrangement. Adequate mechanical protection shall be provided to prevent unauthorized access and to protect passengers and employees from potentially dangerous electronic equipment.

Lockers shall be located and arranged to allow ample access by maintenance personnel. Equipment voltages shall be adequately labeled in compliance with APTA standards.

### 13.3.13 Special Requirements

#### 13.3.13.1 Bicycle Stowage

At least four bicycle stowage locations shall be provided in each vehicle. These locations may use the same floor space as the wheelchair parking locations, with priority given to wheelchairs in cases of conflict. Stowage locations shall provide positive restraint of the bicycle, compliant with the carbody impact, shock, and vibration criteria.

#### 13.3.13.2 Luggage Stowage

Cars shall be equipped with luggage bins located above the passenger seats.

### 13.4 COUPLER

The coupler system shall be service proven and meet the requirements of 49 CFR 229.61, 229.141, 238.203, 238.205, and 238.207, as well as all applicable APTA and AAR Standards and Recommended Practices. Standard car-to-car connections are preferred to use an automatic coupler system that will make all mechanical, pneumatic, and electrical trainline connections when mated. Intermediate mechanical connections within a married pair may use a semi-permanent drawbar. Intermediate electrical and pneumatic connections shall use connectors that allow the two halves of a married pair to be separated in a shop environment.

The coupler connections shall permit operation of up to eight cars in a train under normal conditions through electric and pneumatic train-lines. Coupler controls shall be located in each operator's cab and outside the vehicle near each automatic coupler.

Coupler electrical connections shall transmit trainline control signals, as defined by the Contractor. Minimum trainline controls shall include propulsion commands, car-to-car communications, and door controls. The coupler electrical connections shall also transmit auxiliary power to supply on-board utilities like lighting and HVAC. Trainlined auxiliary power shall be sufficient to allow one shop power feed to support a train consist in layover mode.

The coupler and draft gear shall have the strength needed to allow, under emergency conditions, a train of eight cars with an AW3 passenger load to push or pull an inoperable train of up to eight cars with an AW3 passenger load, without damage to the coupler or its anchorage.

Each coupler shall have a carrier that maintains nominal coupler height while allowing vertical dynamic motion. Each coupler shall have an automatic horizontal centering device that aligns an unloaded coupler to carbody centerline. The coupler carrier and centering device shall be adjustable to allow maintenance personnel to correct for wheel, truck, suspension, and carbody wear. The coupler location shall be maintained within 1-1/2 inches vertically and 1-1/2 inches horizontally of its nominal position on level, tangent track under all static conditions from AW0 to AW3. Coupler adjustment shall not be required more frequently than 92-day intervals.

Coupler gathering range shall be a minimum of 3-3/4 inches of misalignment between opposing coupler centerlines. The coupler gathering range shall be sufficient for two cars to automatically couple on tangent track when each coupler is maintained within the above stated tolerance. Likewise, two cars shall be able to couple on a 12.5 degree horizontal curve.

Each car shall be equipped with one coupler adapter to allow the commuter rail vehicles to be connected to a conventional AAR type-E, F, or H coupler. The removable adapter shall have a maximum weight of 65 pounds and be normally stored on the F-end pilot. It shall be able to withstand 100,000 pounds in buff or draft without permanent deformation. The operator shall be able to manually install or remove the adapter alone and without tools. The adapter is anticipated to be used only during emergency or rescue situations.

## **13.5 TRUCKS AND WHEELS**

### **13.5.1 Trucks**

Each car shall be equipped with two, two-axle trucks. The trucks shall be built as four-wheel, outside frame, fully flexible, bolster supported, roller journal bearing trucks. Truck weight shall be kept to a minimum consistent with the strength, performance, and maintenance accessibility requirements of these Design Criteria. The suspension shall be designed to support safe, comfortable and stable riding at all speeds as described in the performance section above.

The design of the primary suspension shall be such that the resonant frequency is less than 5 Hz. Primary and secondary suspensions shall be designed to be compatible with vehicle weight, track characteristics, ride quality requirements, and level boarding requirements.

Power car trucks shall be specifically designed to accommodate the specified propulsion equipment, with a strong history of commuter rail service.

### **13.5.2 Wheels, Axles, Bearings**

Wheels shall be wrought steel, E-40 design, Class B, 1:40 tread taper, with a narrow flange. The carbuilder shall develop a wheel profile that supports the vehicles operating characteristics to optimize the ride quality. The recommend profile must meet the parameters of the UPRR and the BNSF.

Axles shall comply with AAR Specification M-101 grade "F".

Journal bearings shall be greased, lubricated roller bearings or equivalent with plug access hole to facilitate wheel truing.



## 13.6 FRICTION BRAKES

The friction brake system shall function in coordination with the propulsion system. The system shall provide independent brake pressure control on each truck. The brake system shall comply with 49 CFR 238.231. In this section, dynamic brake shall mean a wear-free electric or hydrodynamic brake.

The friction brake system shall perform the following basic functions:

- Capable of stopping the train with a service application from its maximum authorized operating speed within the track signal spacing
- Supplement dynamic braking and provide service braking under all vehicle loadings, when the dynamic brake is not available.
- Provide emergency braking
- Incorporate a parking brake system.

The friction brake system shall have the following configuration:

- Each axle shall have a load-weight-compensated friction brake to provide the braking effort needed to have an evenly distributed adhesion coefficient for all trucks in a train.
- Each truck shall be controlled independently by its own brake control unit for the purpose of redundancy.
- Each electronic control unit shall be resiliently mounted on the carbody adjacent to its respective truck. The units shall be mounted in a protected location to prevent damage from dirt, dust, wheel splash and unusual heating conditions.

The friction brake system is assumed to be pneumatically actuated. Brake pipes shall allow air connections through all vehicles in the consist for the purpose of brake control pressure and for system charging. Air supply can be from one or multiple sources within the consist. At a minimum, each car shall supply clean, dry, cool, oil-free air to its local brake system and, optionally, to the entire consist. The air supply system and reservoirs shall be sized to support the local married pair or car and one additional married pair or car of equal size, but with an inoperable air supply system. The air supply system shall be modular and interchangeable between like vehicles. The system shall be service proven or built of service-proven components.

The air supply unit may couple a 480VAC, 3-phase, 60-Hz electric motor with an air compressor and filter/dryer. Alternatively, an air supply unit may be coupled to a diesel engine, either at the auxiliary power generator or the main propulsion engines.

A sanding system may be provided that deposits sand immediately in front of the leading wheels of the motor trucks. Sand hoppers, if provided, shall be located near the vehicle outer corners and easily accessible for filling.

## 13.7 ELECTRICAL

All electrical systems shall conform to basic AAR, NEMA, IEEE and NEC standards. Rotating electrical components shall follow IEEE Standard 11-1980 for rail and road vehicles.

### 13.7.1 Voltages

The auxiliary train power voltage shall be 480VAC. As a goal, no more than a total of 75KVA may be drawn from the car's auxiliary power, under conditions of the heaviest demand of heating, air conditioning or combination HVAC and all auxiliary loads.

The auxiliary train power voltage shall be used to run the motors of the air-conditioning compressors, condenser and evaporator fans. It shall also furnish energy for floor and overhead heat.

The auxiliary train power voltage shall be reduced, by means of transformers on each car, to 120VAC for lighting, convenience outlets, air conditioning and heating controls, etc.

A battery charging rectifier system fed from the 480VAC and a 72VDC battery shall provide for low voltage power.

### 13.7.2 Auxiliary Power Supply

The auxiliary power system (APS) shall comply with IEC 1287 and IEC 60574 and provide the following voltages:

- 480V +/- 5%, 60 +/- 2%Hz, Three Phase
- 120V +/- 5%, 60 +/- 2%Hz, Single Phase
- 72V +25% -30%, Direct Current, for train line interfaces/controls

All auxiliary motors shall be of a brushless design.

### 13.7.3 Low Voltage Power Supply (LVPS)

The low-voltage system shall supply the marker, emergency and vestibule lights, headlights, cab signal/ATC, communicating signal, PA, radio and intercom communication, wheel slide protection, door operators, etc. The LVPS shall be powered from the 480VAC supply. It shall be possible to start the LVPS upon establishment of the 480VAC in the absence of battery voltage (dead battery start.)

Alternative options with one battery and dc/dc converter to provide power for specific applications may be proposed.

All low voltage loads shall function normally whenever the low voltage supply is +25% -30% of the nominal battery voltage.

A back-up power system in accordance with 49 CFR 238.115 shall also be provided.

#### **13.7.4 Transients**

All equipment capable of generating electrical transients shall include suppression devices.

#### **13.7.5 Battery and Battery Charger**

LVPS support batteries shall be nickel cadmium units using a proven non-combustible transparent or translucent case which complies with NFPA 130 and NFPA 70. The load cycles shall be based on an ambient temperature of 14°F (-10°C). Batteries shall be rated for the indicated operating environment over a normal service life of not less than 10 years.

Other battery types may be proposed as an alternative. If lead acid batteries are proposed, an under-voltage protection scheme shall be presented. Nickel cadmium batteries will provide back-up low voltage power in the event of LVPS failure.

#### **13.7.6 Shop Power**

A weatherproof external auxiliary supply receptacle shall be provided on each side of the vehicle at a convenient location to permit an external 480VAC, 60 Hz, 3-phase supply to be connected to the auxiliary system. The receptacle shall include interlock contacts to control switchgear on the vehicle and in the external power supply, and shall be accessible from the side of the vehicle from TOR level and from high platform level.

The shop power supply shall be sized for approximately 75kVA per vehicle.

#### **13.7.7 Communications Equipment**

The car communication equipment will be comprised of on board train radios, public address (PA), the automatic announcement system (AAS) and passenger emergency intercom (PEI). It shall function with a passenger information system, which includes exterior destination signs and automatic announcement system. Closed Circuit Television (CCTV) equipment shall also be provided for car interior surveillance.

Radios shall be commercial units functionally compatible with the existing RTD radio system and those of local railroads. The radios shall be integrated into the cab console.

The public address system shall allow one-way communication between the operator and passengers via the interior and/or exterior speakers.

A passenger emergency intercom system shall allow two-way communications between individual passengers and the operator. Each vehicle shall have two intercom stations. A passenger will hail the operator by pressing a button on the station, which sounds a tone in the cab. The operator establishes, and controls, the communication link.

The Automatic Announcement System (AAS) will control all prerecorded audible announcements. The audio messages will be stored in digital form, and played over the PA system. All functions of the AAS will be train line.

The PA and AAS shall be configured as two independent systems. Each system shall have a dedicated amplifier.

Destination or route designations will be displayed on the end and side signs. CCTV cameras shall be supplied in all cars and shall record to a removable media.

### **13.8 HEATING, VENTILATION AND AIR CONDITIONING (HVAC)**

Each car shall include two separate, unitized, roof-mounted HVAC units that shall be capable of maintaining a temperature nominally between 68°F and 75°F (20-24°C) and relative humidity not to exceed a nominal 55% under all ambient conditions. Each HVAC unit will function independently of the other, including logic and thermostat controls. Floor perimeter heat may be used to supplement overhead heat.

Each HVAC unit shall have a layover heating and cooling mode supported by 480VAC, 3-phase, 60 Hz wayside power, capable of maintaining vehicle conditions during no-passenger, extended layovers.

### **13.9 SYSTEM SAFETY REQUIREMENTS**

#### **13.9.1 Flammability and Smoke Emissions**

All materials used in the construction of the car shall meet the requirements of NFPA 130, Sections 4.1, 5.2, 5.4 and 5.6, and 49 CFR 238.103 and 49 CFR 238 Appendix B.

The floor structural assembly shall meet a 30 minute minimum endurance rating in accordance with ASTM E119. The ceiling structural assembly shall meet a 15 minute minimum endurance rating in accordance with ASTM E 119.

#### **13.9.2 Emergency Equipment**

Each car shall have emergency equipment and a first aid kit in compliance with 49 CFR 239.101 and RTD emergency preparedness policy.

### 13.9.3 Exterior Safety Decals

Each car shall be equipped with exterior safety decals to assist emergency personnel during rescue operations, in compliance with 49 CFR 238.114 and APTA SS-PS-002-98 latest Rev., “Standard for Emergency Signage for Egress/Access of Passenger Rail Equipment.” At minimum, all emergency exits, both doors and windows, shall be marked.

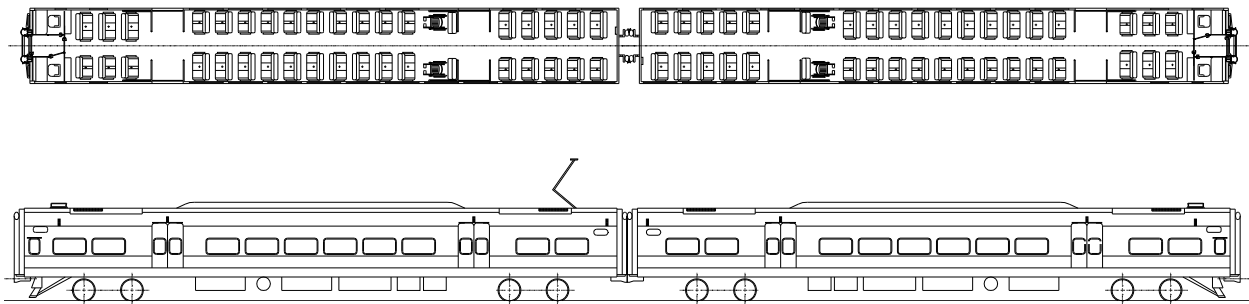
### 13.9.4 Emergency Signage

The car interior shall be equipped with high performance photo-luminescence signage indicating locations of emergency exits and breakout equipment, in compliance with APTA SS-PS-002-98 latest Rev., “Standard for Emergency Signage for Egress/Access of Passenger Rail Equipment.”

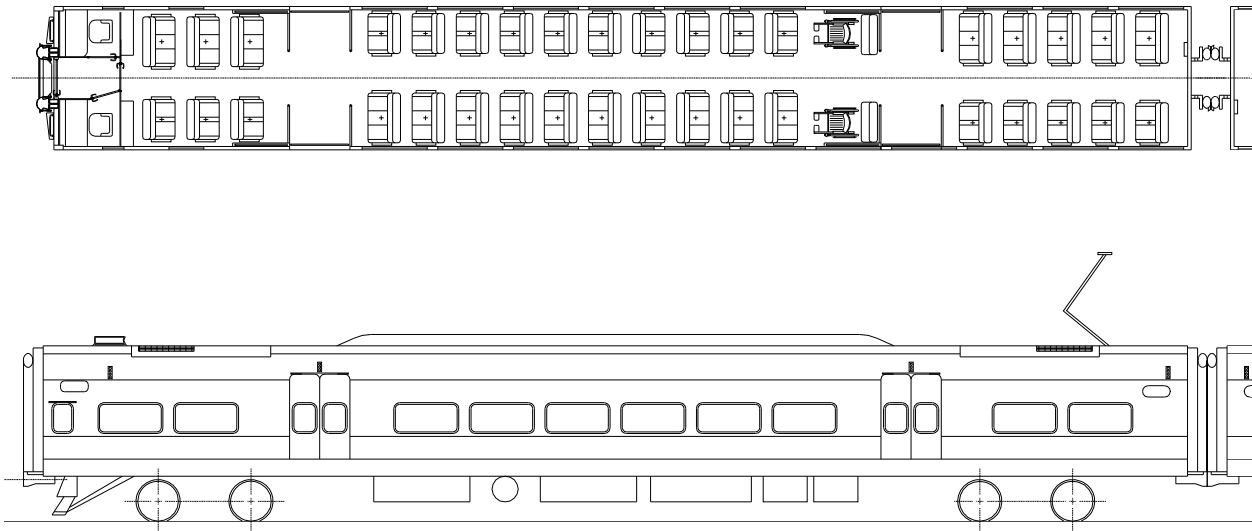
## 13.10 ELECTRIC MULTIPLE UNITS

This section lists the specific vehicle requirements applicable to EMUs in RTD commuter rail service. Sections 13.1 through 13.9 are also applicable to EMUs as they describe general vehicle parameters. Any deviation from these values requires RTD approval. Preliminary EMU general arrangement drawings are provided in Figures 13-4 and 13-5. As stated in 13.1.2, a married pair is assumed composed of an A-car and a B-car. The single car is referred to as a C-car.

**Figure 13-4**  
**Preliminary General Arrangement of Typical EMU Married Pair**



**Figure 13-5  
Preliminary General Arrangement of Typical EMU Vehicle**



### 13.10.1 Dimensions

EMUs shall comply with the general dimensions stated in Section 13.2.1 with the following exceptions.

#### 13.10.1.1 Pantograph Dimensions

This section defines pantograph dimensions. Section 9 defines the overhead contact system, with which the pantograph must interface. Alternate values will be accepted if shown to coordinate with the OCS design.

Pantographs shall be located on the roof, vertically over the truck center pin.

**Table 13-9  
Pantograph Dimensions**

Dimension	Value
Maximum pantograph lock-down height	14 feet, 8 inches
Minimum pantograph working height	15 feet, 3 inches
Maximum pantograph working height	26 feet
Maximum pantograph extended height	26 feet, 5 inches
Minimum pantograph collector head length	6 feet, 3 inches
Maximum pantograph collector head length	6 feet, 6-¾ inches
Minimum pantograph collector head height	6 inches
Maximum pantograph collector head height	9.9 inches
Minimum pantograph collector carbon strip length	47 inches
Maximum pantograph collector carbon strip radius	33 feet
Minimum pantograph collector head angle	140 degrees
Maximum carbon strip wear	1 inch
Maximum lateral displacement of collector head relative to frame	1-½ inches
Nominal pantograph static force	20 pounds
Pantograph static force adjustment range	16 to 23 pounds

**13.10.1.2 Wheel Dimensions**

EMUs shall be allowed the following wheel dimension exception:

**Table 13-10  
EMU Wheel Dimensions**

Dimension	Value
Minimum new wheel diameter	36 inches

### 13.10.1.3 Track Characteristics

The EMU vehicles shall operate over these limiting track characteristics:

**Table 13-11  
EMU Limiting Track Characteristics**

Dimension	Value
Minimum design cant deficiency per 49 CFR 213.57(d)	4 inches
Maximum gradient	4%

### 13.10.2 Car Weight and Passenger Loading

The following weights are applicable to EMU vehicles:

**Table 13-12  
EMU Car Weight and Passenger Loading**

Weight Condition	lbs
AW0 (rejection)	147,500
AW1	161,000
AW2	176,200
AW3	183,750

### 13.10.3 Clearances

#### 13.10.3.1 Pantograph Clearance Envelope

The pantograph clearance envelope shall be calculated based on a failed-spring carbody roll angle of 4.0 degrees relative to top-of-rail, a pantograph horizontal sway allowance of 1-1/2 inches each side of carbody centerline, and the other factors listed above including vehicle horizontal shift, vehicle bounce, pantograph uplift, track and track gauge tolerances, and electrical static and dynamic clearances.



#### 13.10.4 Catenary Voltage

The EMU shall be compatible with an overhead contact system (OCS) operating at a nominal 25 kVAC, 60 Hz, single phase. No other nominal system voltages or frequencies need be considered. The vehicle should be designed for:

**Table 13-13  
EMU Catenary Voltage Requirements**

<b>Nominal Voltage</b>	<b>Frequency</b>	<b>Emergency Minimum Voltage</b>	<b>Minimum Voltage, Normal Operation</b>	<b>Maximum Voltage, Normal Operation</b>	<b>Maximum Voltage During Regeneration</b>
25,000 VAC	60 Hz	17,500 VAC	20,000 VAC	27,500 VAC	28,500 VAC

The vehicles shall maintain specified propulsion performance for all voltages between 20.0 kVAC and 27.5 kVAC. Per AREMA Chapter 33, Section 3.4, the vehicles shall be capable of working at voltages as low as 17.5 kVAC, albeit with degraded performance.

Regenerative braking power shall be controlled by on-car equipment with software-selectable parameters. Regeneration current shall taper linearly when the voltage at the pantograph reaches 28.0 kVAC and stop completely at 28.5 kVAC. Regenerative braking is defined in Section 13.10.10.6.

#### 13.10.5 Performance

This section defines the acceleration and braking performance expected of the EMUs. Tractive effort must meet stated performance levels for OCS voltages ranging between 20.0 kVAC and 27.5 kVAC. Braking performance must be maintained for all OCS voltages down to 0 VAC.

### 13.10.5.1 Acceleration

The acceleration performance specified below shall be met for an AW2-loaded married pair on dry, level, tangent track, from a standing start with the master controller in the coast position and brakes released. The acceleration rate shall be constant to a minimum of 30 mph, and then may decrease inversely proportional to speed. At weights other than AW2, acceleration may vary proportionately with vehicle weight.

**Table 13-14  
EMU Acceleration Requirements**

Speed (mph)	Instantaneous Acceleration Rate (mphps)	Time to Reach Speed from Stop (seconds)
0	2.5	0.0
30	2.5	14.0
50	1.4	25.0
79	0.4	65.0

### 13.10.5.2 Service Brake Requirement

EMUs shall be equipped with a friction brake system and a dynamic brake system incorporating the propulsion system components. The service brake rate shall be maintained whether achieved through friction braking or a blend of friction and dynamic brake.

The braking system shall produce an average full service braking rate of 2.5 mphps for all vehicle weights up to AW3, for all speeds up to 50 mph, under all weather conditions and with all wheel diameters from new to fully worn wheels, on level, tangent track. The net braking rate may decrease linearly from 2.5 mphps at 50 mph to 2.15 mphps at 80 mph. The instantaneous brake rate shall not vary from the average rate by more than +/- 10%.

Dynamic braking shall blend regeneration to support auxiliary loads, regeneration to supply the OCS, and rheostatic braking. The dynamic brake controller shall seamlessly blend these modes to support friction braking throughout the range of expected vehicle speeds. Section 13.10.10.6 more fully describes dynamic braking.

### 13.10.5.3 Emergency Brake Requirement

The emergency braking system shall produce an average braking rate of 3.0 mphps, after initial buildup, for all vehicle weights up to AW3, for speeds up to 50 mph. Buildup time to this minimum rate shall not exceed two seconds. Above 50 mph, the average emergency brake rate shall be as determined by the characteristics of the friction material, but in not case less than 2.15 mphps at 80 mph. The instantaneous brake rate shall not vary from the average rate by more than +/- 20%.

As stated in Section 13.2.4.4, emergency braking may blend friction and dynamic braking as long as friction braking is the fail-safe, default mode and can achieve the specified performance levels.

### 13.10.6 Noise

#### 13.10.6.1 Exterior, Wayside Noise

Exterior noise, 5 feet above the ground, shall not exceed the following:

**Table 13-15  
EMU Exterior Wayside Noise Limits**

Vehicle State	Maximum Noise Level	Notes
Vehicle stationary	65 dBA	Windows and doors closed, all auxiliaries operating simultaneously under normal operating conditions, measured 50 feet from track centerline.
Vehicle stationary	75 dBA	On a station platform with no canopy or vertical obstruction, with all doors and windows open, and all auxiliary systems including the air compressor and HVAC system in operation, measured 8 feet from track centerline.
Vehicle moving	85 dBA	Car operating in open country on any line at any speed and in any mode (power, coast, or brake), measured 50 feet from track centerline.
Vehicle moving	75 dBA	Car operating in open country on any line at any speed between 0 and 30 mph in any mode (power, coast, or brake), measured 50 feet from track centerline.
Vehicle moving	78 dBA	On a station platform, car accelerating or decelerating between 0 and 15 mph, measured 8 feet from track centerline.

### 13.10.7 **Elderly and ADA Accessibility**

EMUs will serve high-level stations only. Vehicle floor and suspension design shall comply with ADA level boarding requirements. If accessibility ramps are required to comply with the car-to-station horizontal or vertical gap requirements, ramps must obey width and slope requirements of the ADA. Access ramps may be manually deployed and stored on the vehicles.

### 13.10.8 **Restrooms**

Restrooms shall not be provided on EMU vehicles.

### 13.10.9 **Auxiliary Power Supply**

APS power for each car shall be supplied from a local 480VAC, 3-phase, 60 Hz inverter which shall be energized by the DC intermediate link power. One auxiliary power supply shall be supplied per married pair, and one per single EMU. Alternate APS architectures may be proposed.

### 13.10.10 **Propulsion/Dynamic Brakes**

#### 13.10.10.1 **General**

Traction shall be inhibited unless all doors in the train consist are safely closed and the friction brake system is sufficiently charged and operational.

#### 13.10.10.2 **Vehicle Traction Power**

The pantograph shall be coupled to a main transformer and rectifier that will receive 25 kVAC traction power and produce DC intermediate link power. This link voltage shall be proposed by the carbuilder and approved by RTD. The intermediate link shall power the traction inverters and auxiliary inverter. The traction inverters shall provide a variable voltage, variable frequency (VVVF) output to drive the traction motors. Each VVVF shall drive two traction motors in one truck.

The rectifier shall be a four quadrant converter capable of compensating for normal overhead line voltage variations, capable of drawing a unity power factor load, and capable of controlled return of regenerated braking energy to the main transformer and the overhead line within receptivity limits.

Pantographs and the high-voltage traction power collection system shall be designed and isolated in such a manner that traction power current cannot flow between any two pantographs through an on-car circuit path.

A high-voltage bus may be provided between cars to supply traction power from a car with a working pantograph to a car with a disabled pantograph.

The concessionaire shall submit a design report verifying pantograph isolation in all operating modes, whether or not a high-voltage bus is provided.

Alternative pantograph isolation and high-voltage bussing schemes will be accepted if shown to provide system safety and to coordinate with the OCS design.

#### 13.10.10.3 Inverter

Power semi-conductor devices, their drivers and associated assemblies shall be grouped in readily removable phase modules that are designated as line replaceable units.

The Contractor shall have responsibility for the complete sizing, coordination and integration of the inverter system with the diesel generator, controls, input filtering, loads, load management, fault condition control and annunciation and fault protection.

Inverter unit cooling shall be accomplished by passive means or forced air-cooling. No external air shall pass over energized surfaces.

#### 13.10.10.4 Traction Motors

Each vehicle shall have four identical traction motors, one per axle. Traction motors shall be 3-phase AC units with characteristics as necessary to achieve the vehicle performance requirements of this document. Motors shall be force ventilated by a carbody mounted blower, self ventilated by an internal fan, or totally enclosed fan cooled (TEFC). The motor enclosure and ventilation system shall be designed for potential undercar environmental conditions and water spray. Traction motors shall be of a service-proven design with a strong history of commuter rail service.

The motor shall be designed in accordance with IEEE Std 11-2000, "Standard for Rotating Electric Machinery for Rail and Road Vehicles," and IEC Std 60349-2, "Electric Traction-Rotating Electrical Machines for Rail and Road Vehicles-Part 2: Electronic Converter-Fed Alternating Current Motors." The motor shall have a safe speed that meets the requirements of Section 9 of IEEE Std 11-2000 and Section 6.3 of IEC 60349-2. In the event of discrepancies between these two standards, the requirements of IEEE Std 11-2000 shall govern unless advised by RTD.

Each traction motor shall be resiliently mounted to the truck frame and connected to the axle through a parallel-drive reduction assembly. Gear units shall be purpose-built and designed for the load parameters of the traction motors, including torsional shock loading. An oil lubrication system shall be provided that insures adequate lubrication flow under all conditions of rotation, speed, load, temperature and weather, in both forward and reverse operation.

Traction motor enclosure, assembly, and mounting shall work together to maximize service life while minimizing service failures, periodic maintenance, and repair time. Motors shall be designed with a minimum of 5-year lubrication cycle, with the preferred frequency to correspond with motor rebuild. Motor unit bearings shall be designed for a minimum L-10 life of 750,000 miles of service. Traction motor mounting and wiring shall allow a two-person work team to disconnect mechanical and electrical connections between traction motors (two on a common truck) and the vehicle in less than 5 minutes using standard hand tools. Complete truck removal may require additional time and tasks.

Traction motors and motor windings shall be sized to meet both propulsion and dynamic brake system requirements. The traction motors shall comply with the wayside noise requirements of 13.10.6.1, specifically audible noise resulting from high frequency current switching patterns when operating from the propulsion inverter.

The motors and motor controllers shall allow all performance characteristics to be met with wheel diameter differences up to at least two percent of the nominal wheel diameter between axles on a truck.

Motor insulation shall be Class H insulation system or better. Propulsion motor temperature rise for the normal duty cycle shall be limited to the allowable temperature rise for one class less than the actual insulation class provided. In case the abnormal duty cycle represents the worst-case condition, the traction motor abnormal duty rating may be based on the temperature rise allowed for its actual insulation class.

#### 13.10.10.5 **Gear Drive**

Each powered axle shall be driven by a service-proven parallel-drive gear unit designed and manufactured for bidirectional service. Gear units shall have a minimum oil level check interval of 30,000 miles and a minimum oil addition interval of 60,000 miles. They shall be designed and applied to require inspection and adjustment no more frequently than once in every 375,000 miles. Bearings shall be designed for a minimum L-10 life of 750,000 miles of service.

#### 13.10.10.6 **Dynamic Brake System**

The vehicle shall have a dynamic brake system incorporating the propulsion system traction motors. The dynamic brake system shall automatically blend with the pneumatic brakes to provide a braking effort corresponding to the level of brake pipe reduction. The dynamic brakes will not need to be applied through independent operator command.

The automatic brake blending shall maximize use of dynamic brake and minimize use of pneumatic tread brake to produce the required service braking rates. The dynamic braking effort may vary with vehicle speed, but should provide measurable braking force down to at least 5 mph. The dynamic brakes should work regardless of the presence or absence of primary power.

It shall be possible to cut out the dynamic brakes by means of a sealed switch.

The dynamic brake system shall be capable of regenerating traction power to support on-board auxiliary loads and feed the OCS during braking. Priority shall be given to auxiliary loads. The dynamic brake system shall also have a rheostatic means of dissipating braking energy. The brake system shall blend regenerative and rheostatic feeds based on auxiliary and OCS receptiveness and maximum OCS system current and voltage limitations.

The dynamic brake system shall have the capability to return regenerated power equivalent to at least 80 percent of the car's instantaneous electric braking power measured at the gear unit quill for any speed from 80 mph to the electric brake fade speed.

If a phase break is anticipated, the propulsion system shall switch from motoring to a low level of regenerative braking to support auxiliaries and maintain DC-link capacitor charge. Auxiliary support shall be provided without interruption regardless of the operating mode of the propulsion equipment at the moment the break is encountered, up to and including operation at full accelerating tractive effort. The level of braking effort produced shall be selected to avoid problems getting through breaks at low speeds. After traveling through the phase break, the propulsion system shall automatically return to motoring. Transitions in and out of motoring shall be as smooth as possible to avoid jerking.

It shall be possible to disable auxiliary support and DC-link support individually through software parameters, which shall be adjustable and non-volatile.

Rheostatic braking shall supplement regenerative braking when the auxiliary loads and line are not sufficiently receptive to accept all the electrical braking energy being developed. Blending of regenerative and rheostatic braking shall be smooth and transparent to the operation and performance of the vehicle. Rheostatic braking shall limit the DC-link voltage to a level that is safe for all connected equipment.

Brake resistors shall be assembled in frames of convenient size for natural ventilation. Forced ventilation shall not be permitted. All resistor frames, heat shields, and hardware shall be made of stainless steel. The resistors shall have sufficient capacity to provide power dissipation during operation at full service rheostatic-only braking over the specified profile and passenger loadings up to, and including AW3, assuming no regeneration to the auxiliaries.

The resistors shall be isolated from their frames, and the frames from the carbody, with high-temperature insulators. Resistor mounting shall be designed to allow for expansion and contraction from heat cycling without damage to, or fatiguing of, the resistors or the mounting. Maximum operating temperature of any brake resistor shall not exceed 1,100 oF (593 oC).

The brake resistor assembly and associated cabling shall be low inductance, designed to minimize EMI generation and the coupling of EMI into track circuits.

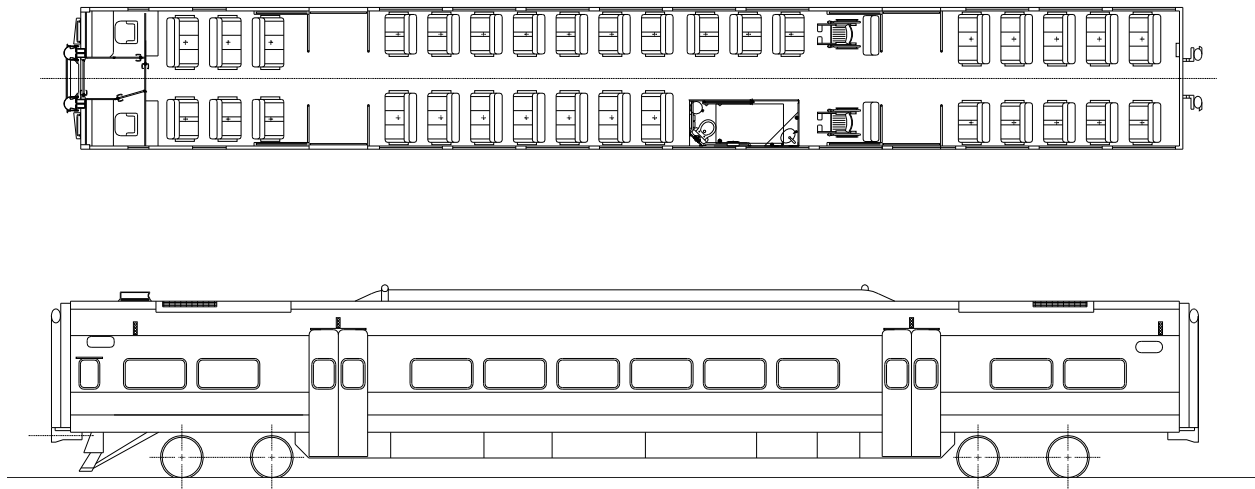
Brake resistors may be roof mounted. If roof mounted, the resistors shall be mounted within an auxiliary roof structure. All parts of the auxiliary roof, including roof walkway, screens and other guards shall have sufficient strength to withstand, without permanent deformation, concentrated loads of 250 pounds spaced 30 inches apart, such as might be applied by maintenance personnel working on the roof. Heat shields, as required, shall be provided for the resistors in order to avoid damage to, or reduction in service life of, adjacent components.



## 13.11 DIESEL MULTIPLE UNITS

This section lists the specific vehicle requirements applicable to DMUs in RTD commuter rail service. Sections 13.1 through 13.9 are also applicable to DMUs as they describe general vehicle parameters. Any deviation from these values requires RTD approval. A preliminary DMU general arrangement drawing is provided in Figure 13-6.

**Figure 13-6**  
**Preliminary General Arrangement of Typical DMU**



### 13.11.1 Dimensions

DMUs shall comply with the general dimensions stated in Section 13.2.1 with the following exceptions.

#### 13.11.1.1 Track Characteristics

The DMU vehicles shall operate over the track characteristics in Section 4

### 13.11.2 Car Weight and Passenger Loading

The following weights are applicable to DMU vehicles:

**Table 13-16  
DMU Car Weight and Passenger Loading**

<b>Weight Condition</b>	<b>Lbs</b>
AW0 (rejection)	160,500
AW1	174,000
AW2	189,200
AW3	196,750

### 13.11.3 Performance

This section defines the acceleration and braking performance expected of the DMUs.

#### 13.11.3.1 Acceleration

The acceleration performance specified below shall be met for an AW2-loaded two-car consist on dry, level, tangent track, from a standing start with the master controller in the coast position and brakes released. At weights other than AW2, acceleration may vary proportionately with vehicle weight.

**Table 13-17  
DMU Acceleration Requirements**

<b>Speed (mph)</b>	<b>Instantaneous Acceleration Rate (mphps)</b>	<b>Time to Reach Speed from Stop (seconds)</b>
0	1.60	0.0
10	1.60	11.0
30	0.70	31.0
50	0.35	75.0
79	0.12	240.0

### 13.11.3.2 Service Brake Requirement

The DMUs shall be equipped with a friction brake system and a dynamic brake system incorporating the propulsion system components. The service brake rate shall be maintained whether achieved through friction braking or a blend of friction and dynamic brake.

The braking system shall produce an average full service braking rate of 2.0 mphps for all vehicle weights up to AW3, for all speeds up to 50 mph, under all weather conditions and with all wheel diameters from new to fully worn wheels, on level, tangent track. The net braking rate may decrease linearly from 2.5 mphps at 50 mph to 2.1 mphps at 80 mph. The instantaneous brake rate shall not vary from the average rate by more than +/- 10%.

### 13.11.3.3 Emergency Brake Requirement

The emergency braking system shall produce an average braking rate of 3.0 mphps, after initial buildup, for all vehicle weights up to AW3, for speeds up to 50 mph. Buildup time to this minimum rate shall not exceed two seconds. Above 50 mph, the average emergency brake rate shall be as determined by the characteristics of the friction material, but in not case less than 2.1 mphps at 80 mph. The instantaneous brake rate shall not vary from the average rate by more than +/- 20%.

As stated in Section 13.2.4.4, emergency braking may blend friction and dynamic braking as long as friction braking is the fail-safe, default mode and can achieve the specified performance levels.

### 13.11.4 Noise

#### 13.11.4.1 Exterior, Wayside Noise

Exterior noise, 5 feet above the ground, shall not exceed the following:

**Table 13-18  
DMU Exterior Wayside Noise Levels**

Vehicle State	Maximum Noise Level	Notes
Vehicle stationary	68 dBA	Windows and doors closed, all auxiliaries operating simultaneously under normal operating conditions, measured 50 feet from track centerline.
Vehicle stationary	75 dBA	On a station platform with no canopy or vertical obstruction, with all doors and windows open, and all auxiliary systems including the air compressor and HVAC system in operation, measured 8 feet from track centerline.
Vehicle moving	85 dBA	Car operating in open country on any line at any speed and in any mode (power, coast, or brake), measured 50 feet from track centerline.
Vehicle moving	78 dBA	Car operating in open country on any line at any speed between 0 and 30 mph in any mode (power, coast, or brake), measured 50 feet from track centerline.
Vehicle moving	78 dBA	On a station platform, car accelerating or decelerating between 0 and 15 mph, measured 8 feet from track centerline.

#### 13.11.5 Passenger Doors

DMU side entry passenger doors shall accommodate both high-level and low-level boarding. High-level boarding shall be similar to the EMU, with an entry threshold height of 51 inches above TOR. Low-level boarding shall provide a stair tread no more than 18 inches above TOR.

Stepwells shall be located at the four side entry locations. Each stepwell shall have three steps with non-skid surfaces; clear width shall be a minimum of 42 inches but no more than the clear door panel opening. The tread depth shall be a minimum of 10 inches. All step edges shall have a permanent band of color(s) running the full width of the step, which contrasts from the step tread and riser or adjacent floor by 70%.

Manual trap doors shall be fitted over the stepwells to accommodate both high- and low-level boarding. The trap door panels may be split, but shall have a coil spring and hinge arrangement which will allow the trap door to open (lift) 15° to 20° when the trap door latch is pushed to release the trap door. The spring shall also assist in lifting the trap door to the open, latched position.

The stepwell must be fully enclosed to carbody exterior conditions when not in use. This may be accomplished with a sliding pocket or plug type door panel that covers the entire height of the step well. These lower door panels may be integral to the upper door panels, or may be independent units. Lower door panel construction, actuation, and controls must be significantly similar to the upper door panels.

#### **13.11.6 Elderly and ADA Accessibility**

DMUs shall provide ADA-compliant access at both high-level and low-level stations.

For high-level boarding, vehicle floor and suspension design shall comply with ADA level boarding requirements. If accessibility ramps are required to comply with the car-to-station horizontal or vertical gap requirements, ramps must obey width and slope requirements of the ADA. Access ramps may be manually deployed and stored on the vehicles.

For low-level boarding, each car shall be equipped with an on-board lift capable of raising or lowering an individual between the TOR height and the vehicle floor height. The lift shall provide a flat surface large enough to accommodate a standard wheelchair. Minimum lift capacity shall be 350 lbs. The lift shall store in the vehicle, clear of the doorway, when not in use.

#### **13.11.7 Restrooms**

Restrooms shall not be provided on DMU vehicles.

#### **13.11.8 Auxiliary Power Supply**

A rotating field, 480VAC, 3-phase, 60-Hz generator powered by a matching diesel engine may be proposed by the Contractor. This auxiliary power unit shall be operational independent of all other diesel engines and power generating equipment. It shall be possible to start the diesel generator if starter battery power is available.

A stand-alone diesel generator may share starting batteries and a fuel tank with the main propulsion diesel engines on the same vehicle. The generator diesel engine shall comply with 40 CFR 89 Tier 4 emissions levels.

Alternatively, a static inverter may be proposed, supplied by the main propulsion engines through the intermediate DC link power. The static inverter shall be suitable to provide full output power at a constant 60 Hz over the whole range of the traction power intermediate link voltages. If used with an electric traction motor configuration, regenerated brake energy shall be used to operate the auxiliary inverter in dynamic braking.

### 13.11.9 Propulsion/Dynamic Brakes

#### 13.11.9.1 General

Traction shall be inhibited unless all doors in the train consist are safely closed and the friction brake system is sufficiently charged and operational.

The DMU shall be equipped with either a diesel electric or diesel hydraulic drive system.

The smallest revenue service DMU consist shall be two vehicles. Between those two vehicles, the consist shall have a minimum of two independent propulsion systems. In the event that one propulsion system fails, the consist shall be able to complete its run at reduced performance.

#### 13.11.9.2 Diesel Engine for Traction Power

All traction power diesel engines shall be identical and fully interchangeable with one another. The diesel engine shall deliver sufficient power to meet the performance requirements of these design criteria.

The diesel engines shall have the following basic design features:

- Water cooled
- Turbo-charged
- Electronic fuel injection
- Self protection
- Low temperature starting capability
- EPA certified

Diesel engines shall be of a service-proven design. The diesel engines shall not require a major overhaul (engine disassembly) within fewer than 18,000 service hours, when operating the vehicle according to the planned duty cycle. Oil change shall not be necessary more often than every 1,000 service hours or 45 days.

The diesel engine shall be mounted on a structural sub frame for modular removal from the vehicle. The engine shall be resiliently mounted to the sub frame and the sub frame resiliently mounted to the vehicle. The mounting system shall meet the shock and vibration criteria stated in Section 13.2.12 while minimizing noise and vibration transmitted into the passenger areas.

The engine shall be packaged to allow easy access to all elements scheduled for service less than or equal to every 180 days. Here, easy access shall be defined as not requiring the removal of any belts, fluid-containing elements, or exhaust system components not directly related to the scheduled maintenance task. Engine compartment access shall be provided through removable access panels on either side of the vehicle and from below. Test ports shall allow service personnel to collect samples of engine oil and coolant while kneeling beside the vehicle. All polluting components such as oil, grease, and coolant shall be done from the outside of the vehicle passenger area. At a minimum, the following items shall be easily serviced through side access doors:

- All fuel, engine oil, and transmission oil filter elements;
- Engine oil level dip stick and oil fill port;
- Engine start panel;
- Water and lubricating oil pumps;
- All visual indicators, gauges, protective devices and test connection points for engine coolant, lubricating oil, fuel oil and combustion air

#### 13.11.9.2.1 **Starter Battery**

A 24VDC battery system shall be provided for diesel engine starting. Batteries may be nickel cadmium or lead acid. The start batteries may be charged by the LVPS, but shall not draw from the LVPS support batteries so that engine starting does not compromise emergency lighting and other LVPS functions.

The start batteries shall have the capacity to start one auxiliary power generator (if applicable) and two diesel propulsion engines sequentially. Engine start batteries shall be capable of supplying engine starting current, as defined by the engine supplier, over the full range of environmental conditions defined in Section 1 of these design criteria. Batteries shall be sized to allow a diesel propulsion engines to be cranked for 10 seconds, rested for 20 seconds, cranked for 10 seconds, rested for 20 seconds, and cranked for 10 seconds without being recharged during this time.

#### 13.11.9.2.2 **Engine Cooling**

Each engine shall have its own cooling unit. If diesel hydraulic propulsion is proposed, the cooling unit shall handle engine and transmission/retarder cooling.

The cooling unit shall consist of the radiators, expansion tank, temperature sensors, controllable valves and fans to regulate the cooling air volume. The cooling controls shall keep the engine temperature in the specified optimum operating range under all operating conditions.

The cooling media shall consist of a mixture of water and corrosion inhibitor/antifreeze. Filling and draining valves shall be easily accessible.

Coolant shall flow in stainless steel, copper, or brass piping. No flexible hoses shall be used except for direct connection to the engine and radiator to allow stress free expansions. Swivel-threaded, hydraulic-type hose assemblies shall be used for such applications.

The radiators shall be of service proven design, made of either copper or aluminum. Connections shall be provided with couplings to facilitate removal and replacement.

The cooling unit shall be designed to work in the environmental conditions as described in Section 1 of these design criteria and allow for a minimum of 25% blocking of the cooling surface due to pollution.

#### **13.11.9.2.3 Preheating**

A preheat unit shall heat the cooling water to the temperature needed to start the engine safely, as specified by the engine supplier. The preheat unit can be powered either electrically by the shop power or by diesel fuel from the onboard tank. If a diesel burner is used, the unit shall be fully functional with the available onboard power.

The engine supplier shall determine if the charge air needs to be pre-heated to avoid excessive exhaust emissions during the engine start at the lowest temperature specified in Section 1 of these design criteria. The engine supplier shall state the lowest temperature, at which it is possible to start the engine without preheating in case of an emergency.



#### 13.11.9.2.4 **Charge Air Cooling**

An air-to-air charge air cooler shall be used, dimensioned according to the diesel engine requirements and the environment conditions as described in Section 1 of these design criteria. The cooling surface shall be sized for a minimum of a 25% contamination.

The cooler and the turbo charger connections shall be equipped with service proven flexible connections, which shall provide vibration isolation through the range of the charge air pressure.

#### 13.11.9.2.5 **Engine Exhaust System**

The exhaust pipes and silencers shall be constructed of stainless steel. The exhaust piping system shall allow for heat expansion. All connections shall allow an easy exchange of the exhaust system parts.

Approved non-asbestos high temperature insulation shall be applied where required to minimize thermal radiation to heat-sensitive equipment or where the exhaust tubes may present a safety hazard to passengers, service personnel or equipment.

The exhaust gases shall be released to the environment in a suitable location on the roof. Exhaust gases shall not interfere with any fresh air intake under all vehicle-operating conditions.

An exhaust after treatment device is expected to be installed as part of the diesel engine emissions compliance. The Contractor is encouraged to combine the silencer with the after treatment device, as current product technology allows.

#### 13.11.9.2.6 **Fuel System**

The fuel system shall comply with 49 CFR 238.223 and 49 CFR 229.93/95. Fuel tank venting shall be in accordance with 49 CFR 229.95.

The fuel system shall consist of a fuel tank, common to all engines on one car, two fuel filler pipes (one on each side of the vehicle), equipped with RTD approved fuel level switches for the automatic fuel pump shut-off valve, two analogue fuel level gauges (one per side) adjacent to the filler pipe, fuel filters and interconnecting piping.

The fuel tank capacity shall be sufficient to ensure continuous operation on the line specified in the general section for one day refueling.

#### 13.11.9.2.7 **Engine Control System**

Engine operation shall be controlled by an electronic control. The control unit shall have a connector for a portable test unit (PTU) to permit static testing, access to diagnostics and monitoring of the traction system during vehicle operations. All major operating parameters, such as engine temperature and rpm as well as fault conditions, shall be reported to the vehicle diagnostic and monitoring system.

#### 13.11.9.2.8 **Fire Protection System**

Temperature sensors near the engine shall detect excessive heat levels. If the trip level is reached, an automatic fire suppression system shall be discharged. Upon fire detection, all engines on the affected vehicle shall be immediately shut down and the fuel supply stopped at the fuel tank. A trainlined fire alarm shall be displayed in the active cab.

#### 13.11.9.2.9 **Emission Control**

Emission from the diesel engines shall comply with the 40 CFR 89 Tier 4 levels.

### 13.11.9.3 **Diesel Electric Drive**

If a diesel electric drive is proposed, the traction power diesel engine shall be coupled to a matching generator, providing AC power which will be rectified to form a DC intermediate link. The intermediate link shall power the traction inverters and auxiliary inverter. The traction inverters shall provide a variable voltage, variable frequency (VVVF) output to drive the traction motors. Each VVVF shall drive two traction motors in one truck.

#### 13.11.9.3.1 **Generator**

The generator unit shall consist of the excitation circuit, output rectifier, protection circuits and the corresponding controls. The excitation shall be provided by the vehicle battery, at 72VDC or 24VDC nominal and shall be functional over the full battery voltage range (+ 25% -30%).

The generator controls shall be part of the vehicle controls to allow an optimum control of the power generation, as needed by the traction and auxiliary inverters. Any fault conditions or irregularities shall be reported to the vehicle controls and diagnostic system.

#### 13.11.9.3.2 **Inverter**

DMU inverters shall comply with Section 13.10.10.3.

#### 13.11.9.3.3 **Traction Motors**

DMU traction motors shall comply with Section 13.10.10.4 and the wayside noise requirements of 13.11.4.1.

#### 13.11.9.3.4 **Gear Drive**

DMU gear drive for electric traction motors shall comply with Section 13.10.10.5.

#### 13.11.9.3.5 **Dynamic Brake System**

DMU electric dynamic brakes shall comply with Section 13.10.10.6. Regenerative power shall be blended between auxiliary loads and rheostatic braking.

#### 13.11.9.4 **Diesel Hydraulic Drive**

If a diesel hydraulic drive is proposed, the traction power diesel engine shall be coupled to a hydraulic torque converter/transmission, which in turn, is coupled to the drive axle(s) by a cardan shaft and final drive gear unit. Each transmission shall drive one or more axles on one truck.

##### 13.11.9.4.1 **Hydraulic Torque Converter/Transmission**

If proposed each transmission shall be designed and manufactured for bidirectional service. It shall have a strong service record in the commuter rail environment, with similar speed and torque loading as projected for RTD service.

Each torque converter/transmission assembly shall be resiliently mounted to the underframe of the vehicle. Safety straps, tabs or hangers shall be provided, as required, to prevent dropping the transmission unit below the vehicle clearance line in the event of mount failure. The combination of mounts and safety straps shall allow the transmission to remain operational when exposed to the service vibration levels defined above, and to remain attached to the vehicle during the impact loading defined above.

The torque converter/transmission assembly shall have openings with removable plugs located with easy access for filling and draining. Plugs shall be suitably located and be of a type that will not be damaged by obstacles on the track, in order to prevent the resultant loss of lubricant. Plugs shall be secured by lock wires, lock tabs or other approved means to prevent loosening in service.

Oil change shall not have to take place more often than every 155,000 mi (250,000 km) or 5,000 operating hours. The filler plug opening shall be arranged to provide an indication of oil

level and also to prevent overfilling. Transmission operating fluid shall be available in North America from more than one supplier.

A major overhaul shall take place only after at the minimum of 750,000 mi (1,207,008 km) or 18,000 operating hours.

The transmission shall have an electronic control that senses all important operating conditions and prevents the transmission from operating outside of its design values. The control unit shall have a fault memory, which stores all abnormal operating conditions and keeps track of service condition of the transmission. It shall be possible to view and download the fault memory using a PTU.

The transmission electronic controls shall signal the level of fault to the central railcar controls and, if possible, shift the transmission into a safe state so that the vehicle can be towed to the end-of-line and to a maintenance facility.

#### **13.11.9.4.2 Final Drive Gear Units**

Each final drive gear unit shall be designed and manufactured for bidirectional service. Gears shall be designed and applied to require inspection and adjustment no more frequently than once in every 500,000 miles (804,672 km) and have a life of at least 1,000,000 mi (1,609,340 km).

Gear units shall be oil lubricated and provided with sufficient baffles, dams, and passages to ensure an adequate flow of lubricant to bearings and gears under all conditions of speed, load, temperature, and weather, including continuous operation in either direction at maximum speed. Gear units shall be designed to prevent infiltration of moisture into the lubricant from any and all sources. The gear unit shall not require replenishment of oil at a rate in excess of one liter for every 100,000 mi (160,934 km).

#### **13.11.9.4.3 Cardan Shafts**

If proposed the cardan (drive) shafts shall have a double universal joint, splined arrangement, and shall be torsionally resilient to cushion torsional shocks between the truck and the transmission. The damping characteristics and power rating selected shall meet the transmission manufacturer's recommendations. The cardan shaft shall be designed for the worst-case track curvature and route-specific speed/curvature profile.

The drive shaft safety hangers shall be provided and shall meet the requirements of 49 CFR 229.99.

#### 13.11.9.4.4 **Control Electronics**

All logic units controlling traction and/or braking functions shall be based on service-proven microprocessors and associated peripherals and I/O, as required to meet all of the specified functions and performance criteria. The control units shall provide self-diagnostic routines, fault monitoring of internal and external devices, and user programmable operating characteristics.

#### 13.11.9.4.5 **Dynamic Brake System**

The vehicle shall have a dynamic brake system. If proposed a hydrodynamic retarder integral to the transmission shall be provided. The dynamic brake system shall automatically blend with the pneumatic brakes to provide a braking effort corresponding to the level of brake pipe reduction. The dynamic brakes will not need to be applied through independent operator command.

The automatic brake blending shall maximize use of dynamic brake and minimize use of pneumatic tread brake to produce the required service braking rates. The dynamic braking effort may vary with vehicle speed, but shall provide measurable braking force down to at least 10 mph.

It shall be possible to cut out the dynamic brakes by means of a sealed switch.

If proposed the transmission retarder shall convert vehicle kinetic energy into heat by means of fluid shear within the transmission operating fluid. This heat shall be rejected to the transmission cooling system and ultimately to an air-to-water or air-to-oil heat exchanger. The retarder should be rated for steady state operations of at least 60% of the maximum tractive effort rating of the drive train. The transmission cooling system shall be designed with enough fluid volume to handle single vehicle stopping efforts well in excess of the rated, steady-state retarder output.

The transmission cooler, if not the same as the engine radiator, shall follow the same design criteria as stated above.

**END OF SECTION**

**THIS PAGE LEFT INTENTIONALLY BLANK**

**TABLE OF CONTENTS**  
**SECTION 14 – SYSTEM SAFETY AND SYSTEM SECURITY**

14.1.0 GENERAL .....2

14.2.0 APPLICABLE STANDARDS .....3

14.3.0 DEFINITION OF SAFETY CONDITIONS .....4

14.3.1 Unacceptable Conditions .....4

14.3.2 Acceptable Conditions .....6

14.4.0 HAZARD IDENTIFICATION, ANALYSIS, AND RESOLUTION .....7

14.5.0 PRELIMINARY HAZARD ANALYSIS (PHA).....7

14.6.0 SAFETY CERTIFICATION.....8

14.7.0 RIGHT-OF-WAY FENCING AND BARRIERS .....10

14.8.0 EMERGENCY ACCESS/EGRESS, STATION DESIGN, AND WALKWAYS.....13

14.9.0 GRADE CROSSINGS.....14

14.10.0 VIDEO SURVEILLANCE .....15

14.11.0 EMERGENCY TELEPHONES .....18

14.12.0 CRIME PREVENTION THROUGH ENVIRONMENTAL DESIGN .....19

14.13.0 THREAT AND VULNERABILITY ANALYSIS AND RESOLUTION.....20

14.13.1 Severity Categories .....20

14.13.2 Transit Risk Assessment Levels .....20

14.13.3 Probability Categories .....21

14.14.0 PARK-N-RIDES, PARKING STRUCTURES, AND ENCLOSED UNDERGROUND OR BELOW GRADE TRANSIT FACILITIES.....24

14.14.1 Surface park-n-Rides .....24

14.14.2 Parking Structures.....24

14.14.3 Underground and Below Grade Transit Facilities.....25

14.15.0 PUBLICLY ACCESSIBLE RECEPTACLES .....26

14.16.0 CONFIGURATION MANAGEMENT .....26

## SECTION 14 – SYSTEM SAFETY AND SYSTEM SECURITY

### **14.1.0 GENERAL**

The CRT design shall address system elements according to the requirements of the applicable standards listed. Should any standard or requirement conflict, the most stringent standard shall apply. Any deviation from RTD's design criteria must be approved by RTD's Executive Safety and Security Committee except where the design criteria is utilized as a reference document in the Eagle/P3 RFP/contract.

Standards, specifications, regulations, design handbooks, safety design checklists and other sources of design guidance will be reviewed for pertinent safety design requirements applicable to the system. The design shall establish criteria derived from all applicable information. Some general system safety design requirements are:

- Identified hazards shall be eliminated or associated risk shall be reduced through design, including material selection or substitution. When potentially hazardous materials must be used, such materials selected shall pose the least risk throughout the life cycle of the system.
- Hazardous substances, components and operations shall be isolated from other activities, areas, personnel and incompatible materials.
- Equipment shall be located so that access during operations, servicing, maintenance, repair or adjustment minimizes personnel exposure to hazards (e.g. hazardous chemicals, high voltage, electromagnetic radiation, cutting edges or sharp points).
- Risk resulting from excessive environmental conditions (e.g. temperature, pressure, noise, toxicity, acceleration and vibration) shall be minimized.
- Risk resulting from human error in system operation and support shall be minimized as part of the design effort.
- In the case of risk from hazards that cannot be eliminated, alternatives that will minimize such risk shall be considered. (e.g. interlocks, redundancy, fail safe design, system protection, fire suppression and other protective measures, such as clothing, equipment, devices and procedures.)
- Power sources, controls and critical components of redundant subsystems shall be protected by physical separation or shielding, or by other suitable methods mutually agreeable to the design and RTD.
- When alternate design approaches cannot eliminate the hazard, safety and warning devices and warning and cautionary notes shall be provided in assembly, operations, maintenance and repair instructions, and distinctive markings shall be provided on hazardous components, equipment and facilities to ensure personnel and equipment protection. These shall be standardized in accordance with commonly accepted commercial practice or, if none exists, normal procedures. Where no such common practice exists, the design shall propose the method or methods to be used to RTD for review and approval. The design shall provide all warnings, cautions and distinctive markings proposed to RTD for review and comment.

The severity of personnel injury or damage to equipment as a result of a mishap shall be minimized.

Software controlled or monitored functions shall ensure minimal initiation of hazardous events or



mishaps.

Design criteria shall not include inadequate or overly restrictive requirements regarding safety. Where there is appropriate supporting information, recommend new safety criteria as required.

**14.2.0 APPLICABLE STANDARDS**

The design shall be in accordance with the following standards. Should the standards requirements conflict, the most stringent requirement shall apply.

**TABLE 14-A – STANDARDS**

Document	Title	Required (R) Guidance (G)
49 CFR 659	State Safety Oversight of Fixed Rail Guideways	R
CCR 723-14	Standards for Rail Fixed Guideway Systems	R
49 CFR 200-244	Federal Railroad Administration	R
National Fire Protection Association (NFPA) 130	Standard for Fixed Guideway Transit Systems	R
NFPA 101	Life Safety Code	R
Latest Revision	Americans with Disabilities Act	R
	Uniform Fire Code	R
	Local jurisdiction fire and building codes	R
Latest Revision	RTD's System Safety and System Security Program Plan	R
Latest Revision	RTD Safety Certification Program	R
Latest Revision	RTD's CR Design Criteria Manual	See Note 1
MIL-STD-882D	Military Standard 882D	G
NFPA 70	National Electric Safety Code	R
U.S. Department of Transportation (DOT), FTA, latest revision	Transit Threat Level Response Recommendation	G

Document	Title	Required (R) Guidance (G)
U.S. Department of Transportation (DOT), FTA, November 2002	Handbook for Transit Safety and Security Certification	R
U.S. Department of Transportation (DOT), FRA	FRA "Collision Hazard Analysis Guide: Commuter and Intercity Passenger Rail Service", October 2007	R
U.S. Department of Transportation (DOT), January 2000	Hazard Analysis Guidelines for Transit Projects	R
29CFR1910	Federal Occupational Safety and Health Standards (General Industry)	R
29CFR1926	Federal Occupational Safety and Health Standards (Construction Industry)	R
Transit Cooperative Research Program (TCRP) Report 17	Integration of Light Rail transit into City Streets	G
MIL-STD-1472D	Human Engineering Design Criteria for Military Systems, Equipment and Facilities	G
U.S. Department of Transportation (DOT), November 2004	Transit Security Design Considerations	R
<b>APTA SS-SIS-RP-001-08, latest revision</b>	Recommended Practice for Trash/Recycling Container Placement to Mitigate the Effects of an Explosive Event	R
<b>APTA SS-SIS-RP-002-08, latest revision</b>	Recommended Practice for CCTV Camera Coverage and Field of View Criteria for Passenger Facilities	R
Note 1: The design criteria is a requirement except where the design criteria is utilized as a reference document in the Eagle/P3 RFP/contract.		

### **14.3.0 DEFINITION OF SAFETY CONDITIONS**

#### **14.3.1 Unacceptable Conditions**

The following safety critical conditions are considered unacceptable. Positive action and implementation verification is required to reduce the risk to an

acceptable level.

- Single component failure, common mode failure, human error or design features, which could cause a mishap of catastrophic or critical severity.
- Dual independent component failures, dual human errors or a combination of a component failure and a human error involving safety critical command and control functions, which could cause a mishap of catastrophic or critical severity.
- Generation of hazardous ionizing/non-ionizing radiation or energy when no provisions have been made to protect personnel or sensitive subsystems from damage or adverse effects.
- Packaging or handling procedures and characteristics which could cause a mishap for which no controls have been provided to protect personnel or sensitive equipment.
- Hazard level categories that are specified as unacceptable.

Unacceptable hazardous conditions will be identified according to the hazard resolution matrix. Hazard classification at this level is a formal process for determining which hazards are acceptable, acceptable with review by management staff, undesirable or unacceptable. Hazard severity is a subjective measure of the worst credible mishap resulting from personnel error, environmental conditions, design inadequacies and/or procedural efficiencies for system, subsystem or component failure or malfunction. Hazard probability is defined as the probability that a specific hazard will occur during the planned life expectancy of the system element, subsystem or component. The categories of hazard severity, hazard probability and their definitions follow:

#### Hazard Severity Definition

- Catastrophic – Death or system loss
- Critical – Severe injury, severe occupational illness or major system damage
- Marginal – Minor injury, minor occupational illness or minor system damage
- Negligible – Less than minor injury, occupational illness or system damage

#### Hazard Probability Definition

- Frequent – Likely to occur frequently; continuously experienced
- Probable – Will occur several times in the life of an item; will occur frequently in fleet/inventory
- Occasional – Likely to occur sometime in the life of an item; will occur several times in fleet inventory
- Remote – Unlikely but possible to occur in the life of an item; unlikely but can be expected to occur in fleet/inventory
- Improbable – So unlikely, it can be assumed occurrence may not be experienced; unlikely to occur, but possible in fleet

The following table (of the RTD System Safety and System Security Program Plan) demonstrates the relationship between severity and probability to define an unacceptable hazardous condition.

**TABLE 14-B – HAZARD RESOLUTION MATRIX**

	Catastrophic (I)	Critical (II)	Marginal (III)	Negligible (IV)
Frequent (A)	Unacceptable	Unacceptable	Unacceptable	Acceptable/W R
Probable (B)	Unacceptable	Unacceptable	Undesirable	Acceptable/W R
Occasional (C)	Unacceptable	Undesirable	Undesirable	Acceptable
Remote (D)	Undesirable	Undesirable	Acceptable/W R	Acceptable
Improbable (E)	Acceptable/W R	Acceptable/W R	Acceptable/W R	Acceptable

Acceptable/WR means acceptable with management review.

### 14.3.2 Acceptable Conditions

The following approaches are considered acceptable for correcting unacceptable conditions and will require no further analysis once controlling actions are implemented and verified.

- For non-safety critical command and control functions; a system design that requires two or more independent human errors, or that requires two or more independent failures, or a combination of independent failure and human error.
- For safety critical command and control functions; a system design that requires at least three independent failures, or three human errors or a combination of three independent failures and human errors.
- System designs which positively prevent errors in assembly, installation or connections which could result in a mishap.
- System designs, which positively prevent damage propagation from one component to another or prevent sufficient energy propagation to cause a mishap.
- System design limitations on operation, interaction or sequencing that preclude occurrence of a mishap.
- System designs that provide an approved safety factor or fixed design allowance which limit, to an acceptable level, possibilities of structural failure or release of energy sufficient to cause a mishap.
- System designs that control energy build-up which could potentially cause a mishap (fuses, relief valves, electrical explosion proofing, etc.).

- System designs in which component failure can be temporarily tolerated because of residual strength or alternate operating paths so that operations can continue with a reduced but acceptable safety margin.
- System designs that positively alert the controlling personnel to a hazardous situation for which the capability for operator reaction has been provided.
- System designs which limit/control the use of hazardous materials.

#### **14.4.0 HAZARD IDENTIFICATION, ANALYSIS, AND RESOLUTION**

The Design Engineer shall develop and implement a Hazard Identification, Analysis, and Resolution process in accordance with the minimum criteria outlined in this section and 49 CFR 659. The purpose of hazard analysis and resolution during the design and engineering phase of the project is several fold: to minimize or eliminate potential hazards; support early hazard identification; integrate safe operating procedures into system design and service; and provide for constant and continuous safety evaluation and assessment.

The Design Engineer shall use the information established in the following documents:

- 49 CFR 659 using the APTA Guideline's Hazard Resolution Matrix (American Public Transportation Association, Manual for the Development of Rail Transit System Safety Program Plans, Checklist Number 7);
- Military Standard 882D (MIL-STD-882D); and
- Hazard Analysis Guidelines for Transit Projects, January 2000, U.S. Department of Transportation.

Subsequent to performing the initial hazard analysis, the Design Engineer shall recommend resolution or mitigation factors to reduce the classification of identified hazards and reclassify identified hazards considering the recommended resolution.

In applying resolution to identified hazards, the Design Engineer shall utilize the following system safety precedence:

- design for minimum risk;
- incorporate safety devices;
- provide warning devices; and
- Develop procedures and training.

#### **14.5.0 PRELIMINARY HAZARD ANALYSIS (PHA)**

The Design Engineer shall conduct a PHA process for the project design. PHA work shall begin upon project initiation and continue throughout the project. The Design Engineer shall provide PHA progress reports according to a mutually agreeable schedule. The Design Engineer shall provide a draft and final PHA report on the preliminary engineering. Subsequent to the preliminary engineering, the Design Engineer shall conduct a draft and final PHA report on the final design.

The PHA document itself is a living document, which must be revised and updated as the system design and development progresses. It becomes the input document and information

for all other hazard analyses performed on the system.

### **Collision Hazard Analysis (CHA)**

The Designer Engineer shall develop a Collision Hazard Analysis (CHA) in accordance with the FRA "Collision Hazard Analysis Guide: Commuter and Intercity Passenger Rail Service", October 2007. Collision Hazard Analysis (CHA) work shall begin upon project initiation and continue throughout the project. The Designer shall provide a draft and final CHA report. The CHA document itself is a living document, which shall be reviewed at each project phase, revised and updated as necessary, as the system design and development progresses.

### **14.6.0 SAFETY AND SECURITY CERTIFICATION**

The Design Engineer shall prepare and submit a draft and final Safety and Security Certification Plan (SSCP) in accordance with FTA Handbook for Transit Safety and Security Certification. The Design Engineer shall develop a preliminary list of safety and security certifiable items and associated design requirements based on the preliminary engineering. The safety and security certification process shall apply to all elements of the system. Separate programs shall be developed, for light rail, for commuter rail and for BRT, as appropriate.

The Design Engineer shall identify those system elements and design standards to comply with the major steps in the safety and security certification process. These steps are implemented beginning with system design and continue through the start of revenue operation.

- Define and identify those safety-critical system elements to be certified.
- Define and identify those security-related elements to be certified.
- Define and develop a Certifiable Items List (CIL).
- Identify safety and security requirements for each certifiable item.
- Verify and document design compliance with the safety and security requirements.

The Design Engineer shall define and identify certifiable items relating to the elements listed in the following table.

#### Safety Certifiable Elements (minimum)

##### 1. Systems Elements

Rail Vehicles

Traction Power (TES-TPSS, TPDS, TPFS, OCS, catenary)

Overhead Contact System (OCS)

Train Signals

Communications - Central Control System (CCS)

Comm- Supervisory Control & Data Acquisition (SCADA)

Ticket Vending Machines (TVM)

Maintenance Vehicles

Signaling - Train Control

- Track
- Fire Protection & Suppression Systems
- Auxiliary Vehicles
- Grade Crossing Fixtures & Traffic Control System
- Emergency Response Equipment
- Intrusion Detection System
- Signage
- Tunnel Ventilation Control System (if req.)

## 2. Facility Elements

- Tunnel
- Structures
- Track
- Each Station
- Each at grade crossing
- Each at grade crossing within each station
- Yard and Shops
- Garages/Parking Lots
- Each Park-n-Ride
- Control or Dispatch Center
- Maintenance Facility
- Art in Transit

## 3. Security Elements

- Video Surveillance (CCTV)
- Parking Structure design
- Park-n-Ride design
- Incorporation of Crime Prevention Through Environmental Design (CPTED) applied to entire design
- Station design
- Emergency Telephones (and Radio)
- Lighting – Stations, patron areas, park-n-Rides
- Security of stairwells and elevators
- Access Control
- Portal Protection

Each certifiable item shall have an associated checklist or verification form consisting of a minimum of two major sections with the following minimum requirements.

#### Section 1 -- Design Requirements and Design Verification

The Design Engineer shall Identify and define each certifiable item, design requirement(s), requirement source, applicability, and provide name and signature of person and Design Engineer responsible for identifying element and defining requirements. The Design Engineer shall separately verify design requirements and provide name and signature of person and Design Engineer responsible for concurrence for design review. For each certifiable item, the Design shall define a basis from which to judge compliance with safety requirements.

The Design Engineer shall verify that design complies with identified requirements and supporting documentation, and shall provide name and signature of person responsible and Design Engineer responsible for design verification.

#### Section 2 -- Construction Verification

The Design Engineer shall supply a signature section on the form or checklist for future verification that construction complies with design through inspection, testing and the provision of documentation to serve as evidence that construction complies with design.

### **14.7.0 RIGHT-OF-WAY FENCING AND BARRIERS**

Right-of-Way (ROW) fencing and/or barriers shall be provided along the entire CR alignment. The fencing and barriers shall be designed to address the following:

- act as a safety barrier to prevent vehicles, trucks, and other highway/roadway users from accidentally entering the CRT envelope;
- shall be of sufficient height to prevent trespass;
- shall be designed to prevent debris and roadway snow removal activity (snow plows throwing slush, ice and other debris) from entering rail envelope and transit station areas; and
- shall incorporate safety considerations on elevated sections with respect to fall protection and providing adequate space for maintenance-of-way workers.

There may be areas where different fencing or barriers may be more appropriate and aesthetic. In these areas, the fencing and/or barrier design shall be determined on a case by case basis and the design shall be accepted by the RTD System Safety Project Manager. The following table describes ROW conditions and the corresponding fencing and barrier requirements. The design shall conform to the requirements contained in the table. For any situation not specifically defined in the table, the fencing and/or barrier design shall be determined on a case by case basis and the design shall be approved by the RTD System Safety Project Manager. These requirements shall be applied regardless of the horizontal or vertical distance from the rail ROW to the adjacent property use. This includes, but is not limited to horizontal and vertical distances between the automobile traffic lane and the rail ROW where state or federal regulations may not require barrier or fence protection. Where different types of fencing/barriers connect, e.g. at-grade to elevated transition points, or at-grade to retaining wall transition points, the design shall accommodate a seamless transition accommodating the integrity of the



fence/barrier. For example, a section of ROW may have a three foot jersey barrier with a six foot fence (total height nine feet) that meets up to a three foot MSE wall with a three foot fence (total height six feet). The fencing shall be designed so it tapers from the higher requirement to the lower requirement and meets the performance requirement of this section. No gaps between transitions are allowed. For example, if the fencing/barrier terminates at a bridge monument, the fencing shall be attached to the monument.

**TABLE 14-C – ROW FENCING AND BARRIERS**

ROW	Description		Barrier Height and Type	Fence Height and Type	Total Height	
Semi-Exclusive & Exclusive ROW	Highway 55mph automobile speed	ROW at Grade	34", Type 7, concrete	5' (2" mesh) (1)	7-10"	
		ROW below Grade	34", Type 7, concrete	5' (1" mesh) (1)	7-10"	
		Station Platform (48" above T.O.R.)	5' concrete	6' (3/8" mesh) (1)	11'	
	Roadway 35-45 mph automobile speed	ROW at Grade	34", Type 7, concrete	3' (2" mesh)	5'-10"	
		ROW below grade	34", Type 7, concrete	6' (1" mesh) (1)	8'-10"	
		Station Platform (48" above T.O.R.)	5' concrete	6' (3/8" mesh) (1)	11'	
		Roadway and Sidewalk	34", Type 7, concrete	5' (1" mesh) (1)	7-10"	
	Bridges	Highway/ Roadway over CR	34", Type 7, concrete	5' (3/8" mesh) (1)	7-10"	
	Shared ROW	Automobile speeds less than 35mph	Residential street running 25 - 35 mph	18" ballast curb/wall	4' (2" mesh) (1)	5' 6"
			street running < 25mph	6" curb	N/A	6"
Bike Path (at grade)		N/A	4' to 6'	4' to 6'		
		Bike Path (elevated)	NA	4'-6" (with rub rail @ 42")	4'-6"	

(1) Note: Exact fence height, type and mesh size shall be determined by site-specific hazard analysis taking into account all factors including protection of the overhead catenary system and patron safety relating to snow plows & snow removal operations. Final design shall be approved by the RTD System Safety Project Manager.

#### **14.8.0 EMERGENCY ACCESS/EGRESS, STATION DESIGN, AND WALKWAYS**

The design shall include emergency access and egress points along the alignment per NFPA 130 requirements. The design shall identify emergency access and egress locations and shall provide a list or matrix of the necessary elements to be provided at each exit, such as lighting, signage, lock hardware, intrusion detection, and other elements as required by NFPA 130 and local jurisdictions. The design shall incorporate a preliminary emergency evacuation plan and diagrams for the corridor, including each station, identifying primary and secondary evacuation routes and points of safety. Each station with vertical circulation shall include designated areas of rescue assistance including signage and an emergency telephone.

CR station design shall meet the “Means of Egress” requirements for stations as identified in NFPA 130. The Design Engineer shall provide a draft and final Means of Egress Report for all stations documenting that station design meets or exceeds all criteria listed in NFPA 130. The report shall include all calculations, supporting documentation, engineering drawings and other information necessary to demonstrate compliance with NFPA 130. For calculation of occupant load, the Design Engineer shall use projected ridership figures or maximum trainload capacities if accurate projections are not available. Each station shall have a minimum of two main access/egress points remotely located from one another. There shall be sufficient exit lanes to evacuate the station occupant load, as defined in NFPA 130, from the station platform in 4 minutes or less. The maximum travel distance to an exit from any point on the platform shall not exceed 300 feet. Stations shall also be designed to permit evacuation from the most remote point on the platform to a point of safety in 6 minutes or less.

The design shall incorporate walkways as follows. An emergency/maintenance walkway shall be provided along structures. The walkway shall be above TOR at the track edge and shall be located at a horizontal distance from track centerline as determined by regulations plus appropriate Other Wayside Factors, and Running Clearance. The walkway shall have a minimum width of 30 inches. A walkway shall be provided adjacent to one side of every track. Walkways in underground CRT structures, bridges and flyovers regardless of length, shall consist of a solid type material that provides a smooth continuous walking surface (concrete, etc.). Walkways shall have a slip-resistant design and shall be constructed of noncombustible materials.

Along the trackway, walkways shall be provided in addition to the clearance envelope requirements per Section 4.2, it is required that space be provided for emergency/maintenance walkways adjacent to the trackway. The walkway envelope shall extend at least 2 feet-6 inches from the edge of the clearance envelope and shall extend to 6 feet-6 inches above the walkway. A walkway shall be provided adjacent to one side of every track. In certain instances, with prior approval from the RTD System Safety Project Manager, the walkway may be between two tracks to serve both. In either case the walkway shall permit unobstructed passage from which passengers can be evacuated. Crosswalks shall have a uniform walking surface at top of rail. Walkway continuity shall be maintained at special track sections (e.g., crossovers, pocket tracks, other special track sections). For walkway clearance calculations only, traction power

poles shall not be considered a permanent obstruction. This requirement is not applicable to paved track sections in street ROW. Walkways shall be placed to allow passengers to evacuate a train at any point along the trainway so that they can proceed to the nearest station or other point of safety per NFPA 130 requirements.

#### **14.9.0 GRADE CROSSINGS**

The CR design shall incorporate approaches that minimize hazards and risks to CR, pedestrians, bicyclists and motor vehicle operators. The primary method to minimize grade crossing hazards is to eliminate at grade crossings or minimize the number of at grade CR crossings. Pedestrian only and bicycle only at grade crossings are generally prohibited and will require a case by case evaluation and written RTD approval. The exceptions to this criteria are pedestrian and bicycle crossings at stations with paved track.

Where planning and design does not allow for the elimination of an at grade crossing, the following system safety precedence shall be applied: design for minimum risk, incorporate safety devices, and provide warning devices. A combination of active grade crossing warning devices and passive warning devices is preferred to solely using passive warning devices. Active warning devices include: gates, bells, flashing lights, and grade crossing indicators for train operators. Passive warning devices include signage and pavement markings.

Design of each at grade crossing shall be subject to the circumstances of that crossing and its relation to the transit corridor. In considering appropriate control and warning devices, consideration shall be given to the following: type of alignment (exclusive, semi-exclusive, or shared ROW); configuration and geometry of crossing (angled or mid-block crossing; operating speed of all users; line of sight of all users; pedestrian activity; school zone; and extreme surges (pedestrians and vehicles).

To enhance pedestrian and bicycle safety at crossings, consideration shall be given to the use of channeling. The purpose of channeling is to create a physical barrier that prevents or discourages persons from taking shortcuts or from crossing the track way in a risky or unauthorized manner. Effective channeling may be developed through the use of fencing, landscaping, bollard and chain, railing, sidewalks or other methods. In all cases, a channeling method that enhances sight lines to an approaching train shall be selected.

Additional elements that may improve pedestrian and bicycle safety at crossings include: swing gates, pedestrian barriers, and automatic pedestrian gates. The purpose of a swing gate is to slow persons who are hurriedly approaching the track way. Swing gate operation depends upon the judgment of the individual. It is not electrically interconnected into approaching train or vehicular traffic signal systems. Swing gates may be appropriate where:

- There is a high likelihood that persons will hurriedly cross the track way, or sight lines and distance are restricted, and
- Channeling or other barriers reasonably prevent persons from bypassing the swing gates, and
- Acceptable provisions for opening the gates by disabled persons can be provided.

Swing gates shall open away from the tracks. Pedestrians shall pull the gate to open it and enter the track way. Gates shall also permit quick exit from the track way, automatically close after use, and be light and easy to operate by all persons.

Pedestrian barriers are also intended to slow persons who are hurriedly approaching the track way. Major advantages of barriers are that there are no operating parts to maintain, and that disabled persons are less impeded. Pedestrian barriers may be appropriate where:

- There is a high likelihood that persons will hurriedly cross the track way, or sight lines and distance are restricted, and
- Channeling or other barriers reasonably prevent persons from bypassing the barriers, and
- Adequate space is available to accommodate installation.

Barrier positioning shall accommodate use by disabled persons and be positioned so persons are turned to face the nearest on-coming train prior to crossing the track way.

Automatic pedestrian gates prevent or discourage a pedestrian or bicyclist from crossing the track way when a train is approaching. Automatic pedestrian gates are electrically interconnected into and activated by the train signal system. Automatic pedestrian gates may be considered in situations where the use of swing gates and barriers may not be effective due to train speeds and severely limited sight distance.

All gated grade crossings shall have video surveillance per the requirements of Section 14.10.0 Video Surveillance. Each gated grade crossing shall have two cameras.

The Design Engineer shall prepare diagrams for swing gates and pedestrian bedstead barriers.

#### **14.10.0 VIDEO SURVEILLANCE**

The design shall incorporate video surveillance into the project. The video surveillance system shall be capable of dual streaming live video feeds. Technicians at the Command Center will receive pictures at a full 30 frames per second. A second stream will store video images at 15 frames per second at 2 CIF. The video surveillance system shall be capable of transmitting video to RTD's Security Command Center via a fiber optic transmission backbone or other suitable transmission network, such as Cat 5 or higher cable for IP transmission. Understanding that technology changes rapidly, most current industry standards will be utilized in design and construction. RTD, through the Security Systems Administrator, must approve any proposed deviations in technology from the listed standards for the video surveillance system.

The design shall include all system elements including communication houses, transmission infrastructure, analog or digital color cameras, IP switches, encoders, decoders and network video recorders. The design shall incorporate video surveillance covering station platforms, emergency telephones, elevator waiting areas, stairwell entries, parking structures, pedestrian tunnels and pedestrian bridges. The minimum number of cameras to provide coverage of these transit elements is as follows.

**TABLE 14D – MINIMUM CAMERA COVERAGE**

Single level at grade station platform of 300 feet or less \*

Platform type	Fixed color camera	Pan-Tilt-Zoom color camera
Center platform	4	2
Side/ center platform	6	2
Side/Side platform	4	4
Triple platform (side with two centers)	10	3

\*For stations with vertical circulation, the minimum number of cameras is as stated above plus: one fixed color camera per elevator waiting area per floor, one fixed color camera per stairwell entry per floor, and one fixed color camera per each emergency telephone. Elevators shall have a minimum of one fixed color camera inside each elevator cab.

\*For stations greater than 300 feet in length additional cameras will be required. The exact number will be dependent on the station design.

**TABLE 14E – PARKING STRUCTURE CAMERAS**

Vehicle spaces	Vehicle entrance	Vehicle exit	Elevator waiting area*	Stairwell entrance area*	Emergency telephone*
1 camera per 35 vehicle spaces	1 camera per vehicle entrance <u>lane</u>	1 camera per vehicle exit <u>lane</u>	1 camera per waiting area per floor	1 camera per entrance area per floor	1 camera per emergency telephone

\*Subject to approval by the RTD Security Systems Administrator, if the design accommodates a cluster of the elevator waiting area, stairwell entrance, and emergency telephone, a single camera may be used if the video coverage of all three elements is satisfactory. Elevators shall have a minimum of one fixed color camera inside each elevator cab.

\*\*All parking structure cameras are color, pan-tilt-zoom.

**TABLE 14F – PEDESTRIAN TUNNEL CAMERAS**

Pedestrian Tunnel\*

(all cameras are color, pan-tilt-zoom, 4 cameras minimum per tunnel)

1 camera focused on each portal entrance/exit (2 cameras)	1 camera inside each tunnel portal entrance/exit focused inside the tunnel (2 cameras)
---	--

\*For tunnels in excess of 150 feet, additional cameras will be required. If a tunnel has a bend or turn, additional cameras will be required. The RTD Security Systems Administrator will determine the number of additional cameras necessary for coverage.

**TABLE 14G – PEDESTRIAN BRIDGE CAMERAS**

Pedestrian Bridge

(all cameras are color, pan-tilt-zoom, 2 cameras minimum per bridge)

1 camera inside each bridge portal entrance/exit focused inside the tunnel

\*For bridges in excess of 150 feet, additional cameras will be required. If a bridge has a bend or turn, additional cameras will be required. The RTD Security Systems Administrator will determine the number of additional cameras necessary for coverage.

Surface park-n-Rides will typically not have video surveillance installed for opening day. However, a minimum network of two, two-inch conduits with pull cords shall be provided as follows for future video installation; one for power and one for communications. As light poles are installed and trenching is done to supply power to these poles, these conduits, shall be installed at each light pole for security. These conduits are of sufficient size to hold any wiring that might be needed for camera installation. Poles in a common area, such as on an island, shall be wired in series (daisy chained). From each common area, the pole closest to the security room shall have a conduit run directly into the security room where the conduits shall stub up. The diameter of the conduit used for this run shall be sufficient to support all poles in that daisy chain. The conduit layout shall be designed to ensure that all poles, either directly or via daisy chain, stub up into the security room.

**TABLE 14H – SURFACE PARK-N-RIDE CAMERAS**

Surface park-n-ride

Vehicle spaces	Vehicle entrance	Vehicle exit	Pan-tilt-zoom color camera*
1 fixed color camera per 25 vehicle spaces	1 pan-tilt-zoom color camera per vehicle <u>entrance lane</u>	1 pan-tilt-zoom color camera per vehicle exit <u>lane</u>	Minimum of 1 camera, than 1 camera per 250 spaces

\*In addition to the network of fixed cameras, each park-n-Ride shall have a minimum of one pan-tilt-zoom color camera, then 1 additional camera per 250 vehicle spaces.

All camera locations will be presented to RTD's Security Systems Administrator for review and acceptance. In design, all cameras must be labeled for their identified function (detect, monitor, identify, or recognize) as described in the APTA criteria for video systems.

Installed components and software must be compatible with the existing RTD video surveillance system.

The system shall record images consistent with RTD's existing system at 15 full frames per second per camera at 2 CIF, and shall provide recorded archive storage of 30 days at 15 full frames per second per camera at 2 CIF. Video will be stored utilizing MPEG, JPEG or H.264 compression.

**14.11.0 EMERGENCY TELEPHONES**

The design shall incorporate emergency telephones into the project. The emergency telephones shall be consistent with existing RTD units and meet performance requirements of RTD's existing emergency telephone network. The design shall incorporate emergency telephones covering station platforms, elevator waiting areas, stairwell entries, parking structures, park-n-Rides, pedestrian tunnels and pedestrian bridges. Emergency telephones shall be placed as follows.

**TABLE 14I – EMERGENCY TELEPHONES AT STATIONS**

Single level at grade station platform*	
Platform type	Emergency telephones
Center platform	1
Side/ center platform	1
Side/Side platform	2
Triple platform (side with two centers)	2

\* For stations with vertical circulation, one emergency telephone shall be placed at each elevator waiting area on each level, and one emergency telephone shall be placed at each area of rescue assistance.

**TABLE 14J - EMERGENCY TELEPHONES AT PARKING STRUCTURES**

Parking Structure	
Elevator waiting area*	Stairwell entrance area*
1 emergency telephone per waiting area per floor	1 emergency telephone per stairwell entrance area per floor (if two stairwells, then 2 ET's per floor, etc.)

Subject to approval by the RTD Security Systems Administrator, if the design accommodates the elevator waiting area and stairwell entrance being adjacent to one another, a single emergency telephone may be used for that location.



For surface park-n-Rides, a minimum of one emergency telephone shall be placed in the design, and then one additional emergency telephone per each 300 spaces.

If pedestrian overpasses or underpasses are incorporated into design, a minimum of one emergency telephone shall be provided for each overpass/underpass. If the overpass or bridge is isolated from other transit elements, additional emergency telephones may be necessary.

The emergency telephone when activated shall connect to the RTD Security Command Center or the Command Center of an operations partner contractor, whichever is most appropriate.

Installed Emergency Telephones shall be constructed pursuant to a minimum NEMA 3R rating (see below) and be Underwriter Laboratory and FCC approved and ADA compliant. The phones shall draw power from the phone line and require no additional power line attachments. The phones shall be capable of off-site live monitoring of emergency conversations. The emergency phones shall be part of a networked management system that is operated by a PC, XP Windows compatible or newer. The software management system will:

- Establish an automatic connection with each phone on a prearranged schedule. Phones will be tested at least one time in every twenty-four hours. The connection shall be initiated either by the PC or the telephone.
- Print an exception report at designated intervals highlighting use and malfunctions.
- Archive and maintain all reporting both of normal functioning and malfunctions.
- Log and archive all call activity at each phone.
- Identify all call activity by date and time, type of activity, and location of data within memory.
- Establish Automatic Maintenance Monitoring which reports stuck buttons, power interruption, microprocessor testing, call interrupt, handset integrity and functioning, handset off hook notification and phone line current.

NEMA 3R – Enclosures constructed for either indoor or outdoor use to provide a degree of protection to personnel against incidental contact with the enclosed equipment; to provide a degree of protection against falling dirt, rain, sleet, snow, and that will be undamaged by the external formation of ice on the enclosure. Phones will operate in a temperature range of -40°C to +60°C.

All emergency telephone locations will be presented to RTD's Security Systems Administrator for review and acceptance.

#### **14.12.0 CRIME PREVENTION THROUGH ENVIRONMENTAL DESIGN**

The design shall incorporate Crime Prevention Through Environmental Design (CPTED) strategies to the entire design. The purpose of CPTED is to minimize potential threats and vulnerabilities to the transit system, facilities and patrons and maximize safety and security through engineering and design. Good CPTED strategies include: maximizing visibility of people, parking areas, patron flow areas and building/structure areas; providing adequate lighting minimizing shadows; graffiti guards; Mylar shatter guard protection for glass windows; landscape plantings that maximize visibility; gateway treatments; decorative fencing; perimeter control; fencing; minimizing park-n-ride and parking structure access points; elimination of

structural hiding places; open lines of sight; visible stairwells and elevators meaning the exterior walls are constructed of transparent material; and painting with light.

Examples of CPTED strategy include:

- Adequate lighting of all areas appropriate for their use including perimeter lighting in park-n-Rides so the edge of the park-n-Ride is illuminated the same as the rest of the park-n-Ride (refer to station design criteria for lighting levels).
- When using shrubs, use species with a maximum height or spread that will minimize visibility obstructions. The preliminary design shall be approved by RTD prior to final design and implementation.
- When using trees, use deciduous trees with branches no lower than six feet from ground surface.

The design shall incorporate CPTED strategies into the Threat and Vulnerability Analysis and Resolution process described in the following section, 14.13.0 Threat and Vulnerability Analysis and Resolution.

**14.13.0 THREAT AND VULNERABILITY ANALYSIS AND RESOLUTION**

The design shall incorporate a Threat and Vulnerability Analysis and Resolution process in accordance with the minimum criteria outlined in this section. A risk assessment is a comprehensive study of a system to identify those components most vulnerable to disruption or destruction and to assess the likely impact that such disruption or destruction would have on passengers, employees, and the RTD system. Threat and vulnerability analysis (TVA) work shall begin upon project initiation and continue throughout the project. The design shall incorporate TVA progress reports according to a mutually agreeable schedule. The design shall include a draft and final TVA report on the preliminary engineering. The TVA document itself is a living document, which must be revised and updated as the system design and development progresses. It becomes the input document and information for all other TVA performed on the system.

The process shall assign values to design elements based on their criticality to the transit system operations. The four level risk classification system listed below will be used to assess risk levels.

14.13.1 Severity Categories

See Section 14.3.1, Hazard Severity Definitions.

14.13.2 Transit Risk Assessment Levels

**TABLE 14J - TRANSIT RISK ASSESSMENT LEVELS**

Category	Characteristic
1	Loss of life, loss of critical information, loss of critical assets, significant impairment of mission, loss of system
2	Severe injury to employee or other individual, loss of information and physical equipment resulting from undetected

or unacceptable mission delays, unacceptable system and operations unauthorized access, disruption

- 3 Minor injury not requiring hospitalization, undetected or delay in the detection of unauthorized entry resulting in limited access to assets or sensitive materials, no mission impairment, minor system and operations disruption
- 4 Less than minor injury, undetected or delay in the detection of unauthorized entry system or operations disruption

14.13.3 Probability Categories

**TABLE 14K – PROBABILITY CATEGORIES**

Category	Level	Specific Event
A	Certain	Possibility of Repeated Incidents
B	Highly Probable	Possibility of Isolated Incidents
C	Moderately Probable	Possibility of Occurring Sometime
D	Improbable	Practically Impossible

The design shall incorporate a risk and vulnerability assessment to determine any potential hazards or high-risk areas. The table below is an example of the type of assessment to determine risk and vulnerability.

**TABLE 14L - ASSESSMENT OF RISK & VULNERABILITY (RAIL)**

Public Transportation Assets	Criticality People	Criticality System
Transit Centers & Stations	High	Potentially High <sup>2</sup>
Rail		
Track/Track Structure/Signals	Low	Potentially High <sup>2</sup>
Cars	High <sup>1</sup>	
Maintenance Yards	Low	Medium
Switching Stations	Low	Medium
Electric Power		
Source for System	Medium	High
Substations	Low	Medium
Command Control	Low <sup>3</sup>	High

Center		
Revenue Collection Center	Low <sup>3</sup>	Medium
Bridges	Medium	Medium <sup>2</sup>
Tunnels	Medium	Medium <sup>2</sup>
Fans	Low	Medium
Vents	Low	Medium
Emergency Hatches	Low	Medium

**TABLE 14M - ASSESSMENT OF RISK & VULNERABILITY (BUS)**

Public Transportation Assets	Criticality People	Criticality System
Bus Terminals	High <sup>1</sup>	Potentially High <sup>2</sup>
Bus Vehicles	High <sup>1</sup>	Low
Bus Stops/Shelters	Medium	Low
Maintenance Garages	Low <sup>3</sup>	Medium
Fuel Storage Facility	Low	High
Command Control Center	Low <sup>3</sup>	High
Revenue Collection Center	Low <sup>3</sup>	Medium

<sup>1</sup>Depends on what time of day incident occurs. Greater impact would be experienced during rush hour than non-rush hours

<sup>2</sup>Depends on location in the system where an incident occurs. An incident at a crossover or main junction would have greater impact than one at an outlying station or track segment. Also depend on the alternatives available, such as redundancies, rerouting capabilities, and other factors.

<sup>3</sup>Affects employees only

The design process shall identify any threats that have been located. These identified threats could include,

- Criminal Activity
- Terrorism

- Natural disasters
- Emergency Response

Identified risks and hazards shall be resolved to acceptable levels. The matrix below provides a source for mitigating hazards based on frequency of occurrence and severity. The matrix condenses risk resolution into a table and prioritizes the risks that are evaluated.

**TABLE 14N – SEVERITY OF LOSS**

Assessed Rating	Probability of Loss	1 Catastro- phic	2 Very Serious	3 Moder- ately Serious	4 Not Serious
A	Certain				
B	Highly Probable				
C	Moderately Probable				
D	Improbable				
		1A. 1B. 1C. 2A.		Unacceptable: Implement Countermeasures to Reduce	
		2D. 2C. 2D. 3B.		Acceptable with Management Review	
		3D. 4A. 4B. 4C.		Acceptable	

The design shall present several options to the RTD in order to decrease the hazards located in the assessment. These options shall be based on the system security precedence:

- Design the system to eliminate the risk
- Design the system to control the risk
- Add safety or security devices to control the risk
- Add warning devices to control the risk, and
- Institute special procedures or training to control the risk.

## **14.14.0 PARK-N-RIDES, PARKING STRUCTURES, AND ENCLOSED UNDERGROUND OR BELOW GRADE TRANSIT FACILITIES**

### **14.14.1 Surface park-n-Rides**

In addition to the items already listed in this chapter, design for surface park-n-Rides shall consider safety and security of patrons and the protection of property. Park-n-Ride design shall incorporate good visibility throughout the park-n-Ride, and good visibility from surrounding streets into the park-n-Ride for patrols by law enforcement and security personnel.

The use of landscaping shall consider maximizing visibility and eliminating hiding places and shadows. Shrubs shall not impede visibility in height and trees shall bear no branches below 6 feet from ground surface. Evergreen trees shall only be used on a limited basis and shall be placed in such a manner that hiding spaces and visual obstructions are not created. Landscape placement shall be subject to approval by the RTD Security Systems Administrator.

Adequate and appropriate lighting is the single most effective deterrent for minimizing crime at park-n-Rides. Lighting shall be provided in accordance with the criteria provided in the stations chapter. The design shall address perimeter lighting by including placement of light poles around the perimeter of the park-n-Ride.

The control and design of park-n-Ride entrances and exits is important to maintaining security of park-n-Rides. Entrances and exits shall be limited to as few as practically possible to control access and egress from the park-n-Ride site and minimize the number of entrance and exit cameras. To compliment the effective use of video surveillance, traffic calming features (i.e. speed bumps) shall be considered at entrances and exits on a case-by-case basis to slow the vehicles as they enter and exit to allow adequate time for automobile license plates to be captured by video surveillance. Where speed bumps are used for these purposes, they shall include two speed bumps separated by one and one half standard vehicle lengths.

### **14.14.2 Parking Structures**

In addition to the items already listed in this chapter, design for parking structures shall consider safety and security of patrons and the protection of property. Parking structure design shall incorporate good visibility throughout the structure, and good visibility from surrounding streets into the structure for patrols by law enforcement and security personnel. Walls inside the structure shall be limited to increase visibility and minimize hiding places throughout the structure. Openings in interior walls between levels or ramps shall be protected by mesh or chain link fencing. Openings in exterior walls at the ground level and at below grade level shall be protected by mesh, chain link fence or other treatment to prevent pedestrians from entering or exiting the structure through these openings.

The control and design of parking structure entrances and exits is important to maintaining security of the structures. Entrances and exits shall be limited to as

few as practically possible to control access and egress from the structure and minimize the number of entrance and exit cameras.

Stairwell and elevator design shall maximize the interior visibility of the stairwell, elevator and elevator shaft. Materials of wall construction for these elements shall be transparent such as glass and allow visibility from at least three sides.

Each parking structure shall include a security room/office for security or law enforcement personnel.

Parking structures shall have minimum lighting levels of 5 foot candles measured at the pavement.

### **14.14.3 Underground and Below Grade Transit Facilities**

Enclosed, underground and below grade transit facilities present unique security design challenges. Design of these facilities shall maximize patron safety and security by the inclusion of counterterrorism measures. Each enclosed, underground or below grade facility shall be covered by video surveillance including: its perimeter; portals, entrances and exits; its interior; and fare vending areas. Patron station areas in these facilities shall be designed as paid fare zones. Thus, patron circulation design shall consider the availability to purchase fare media prior to entering the paid fare zones.

Where facilities serve more than one mode of transportation, the design shall incorporate a means to physically separate modal areas using automatic doors. Each modal area shall also have a separate ventilation system. This design shall allow one modal area to operate in the event of a major incident occurring in an adjacent modal area and prevent cross contamination.

Facility access control is an important aspect of design and shall be designed as follows. All access points (entrances and exits) to the facility and all interior doors shall be controlled by proximity reader access control. The proximity reader access control system shall be a Lenel system as currently installed at RTD facilities and shall be networked into the existing system. All access points or portals capable of accommodating a motor vehicle shall be equipped with automatic portal protection that will prevent unauthorized vehicles from entering the facility. The portal protection shall have a K-12 rating, shall include a guard shack, and shall be located at a minimum distance of 150 feet from the facility entry portal. Portals for train access shall include intrusion detection capable of distinguishing between an authorized train and any other unauthorized vehicle or person attempting to gain access through the train portal. Intrusion detection alarm notification shall be sent to rail central control and RTD Security Command Center. The facility design shall incorporate a means to establish a vehicle checkpoint at a minimum distance of 150 feet from each facility vehicle entry portal.

The design shall protect the facility from progressive collapse. In the event of an internal explosion, the design shall prevent progressive collapse due to the loss of one primary column. Column design shall consider sizing, reinforcement or protection so that the threat charge will not cause the column to be critically

damaged.

Loading docks and shipping/receiving areas are prohibited in underground and below grade facilities. All deliveries shall be accommodated for at the exterior of the facility above grade.

Each enclosed, underground or below grade facility shall include a security room/office for security or law enforcement personnel.

#### **14.15.0 PUBLICLY ACCESSIBLE RECEPTACLES**

Publicly accessible receptacles are any receptacle with a void space that the public can access. Examples include but are not limited to trash receptacles, bike lockers, and newsracks. Placement of publicly accessible receptacles shall be subject to threat and vulnerability analysis and shall not be placed within 250 feet of a station, station area or patron gathering area for outside locations. An exception is the use of an explosion resistant trash receptacle or other receptacle meeting the requirements of the Department of Homeland Security. For enclosed areas, underground, or below grade transit stations, facilities, structures and tunnels, placement of publicly accessible receptacles is strictly prohibited. In parking structures, placement of publicly accessible receptacles is strictly prohibited.

#### **14.16.0 CONFIGURATION MANAGEMENT**

Any change or deviation to this design criteria must be approved by RTD's Executive Safety and Security Committee.