

## **RACK MOUNT CHASSIS SYSTEM**

THE 17" STANDARD RACK MOUNT CHASSIS SYSTEM COVERS A RANGE OF ASSEMBLIES WITH PANELS OF 1 3/4" TO 15 3/4" IN HEIGHT.

DEPTHS ARE PROVIDED IN 8", 14" AND 20" VERSIONS.

ASSEMBLIES ARE ALSO AVAILABLE IN PANEL HEIGHTS OF 17 1/2", 19 1/4" AND 21" WITH A STANDARD MAXIMUM DEPTH CONFIGURATION OF 26". CUSTOM DEPTHS AVAILABLE UPON REQUEST.

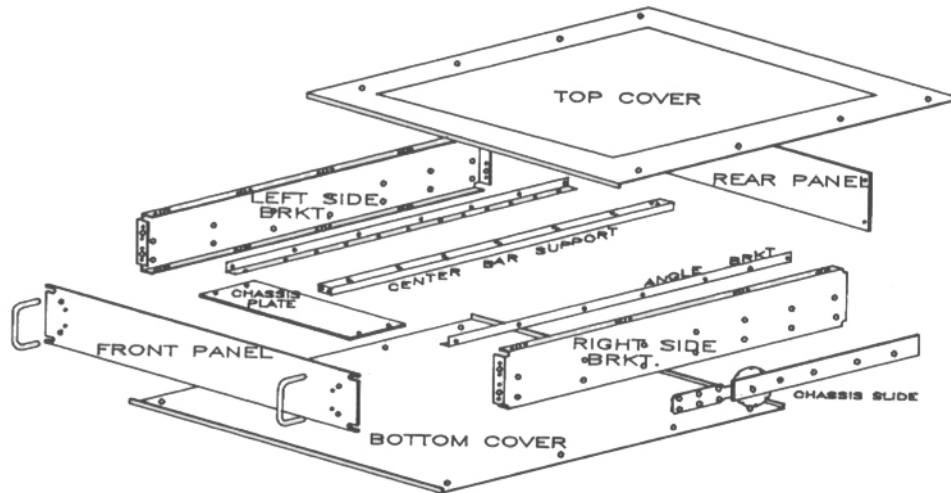

The 17" Standard Chassis is configured for Standardized 19" Racks

The complete chassis assembly includes, 1ea. front panel, 1ea. rear panel, 2ea. side brackets and 2ea. covers.

All fastening hardware and 2ea. front panel mounted handles complete the assembly.

Each Chassis System is provided unassembled. Assembled systems are available upon request.

### **COMPONENTS**

CHASSIS COMPONENTS ARE AVAILABLE ON AN INDIVIDUAL BASIS.

### **ACCESSORIES**

Chassis Accessories include Angle Brackets, Chassis Plates, Support Bars and Side mounted Chassis Slides.

FOR SALES SERVICE, ORDER ENTRY AND ENGINEERING  
1- 877- 800- RACK

**SPECIFICATIONS**  
**RACK MOUNT CHASSIS SYSTEM**  
**CHASSIS SYSTEM CONFORMS TO EIA-310d**

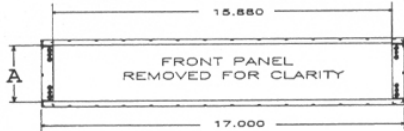

**OPEN HEIGHT**

	1U	2U	3U	4U	5U	6U	7U	8U	9U
A	1.00	2.63	4.38	6.13	7.88	9.63	11.38	13.13	14.88

**OPEN DEPTH**

	8" DEPTH	14" DEPTH	20" DEPTH	26" DEPTH
B	7.97	13.97	19.97	25.97

**OPEN HEIGHTS WITH CHASSIS PLATE INSTALLATION**

	A1	A2	A3	A4
1U	N/A	N/A	N/A	N/A
2U	1.720	.845	N/A	N/A
3U	3.220	2.345	1.470	N/A
4U	4.970	4.095	3.220	N/A
5U	6.720	5.845	4.970	4.095☆
6U	8.470	7.595	6.720	5.845☆
7U	10.220	9.345	8.470	7.595☆
8U	11.970	11.095	10.220	9.345☆
9U	13.720	12.845	11.970	11.095☆

☆APPLICATIONS FOR CHASSIS DEPTH OF 26" AVAILABLE UPON REQUEST

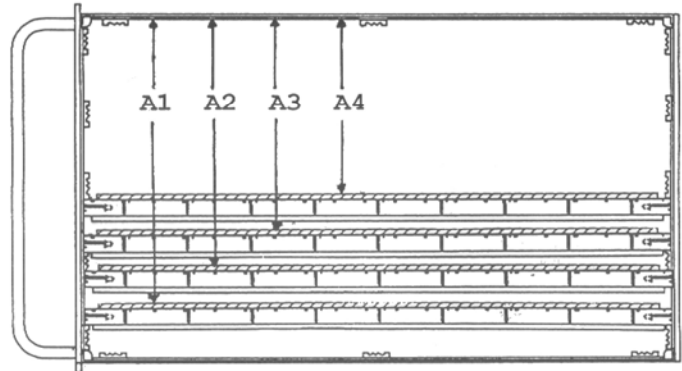

**OPEN DEPTHS WITH CHASSIS PLATE INSTALLATION**

	8" DEPTH	14" DEPTH	20" DEPTH	26" DEPTH
B	7.970	13.970	19.970	25.970

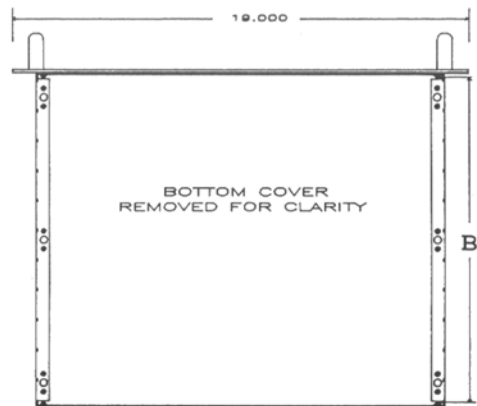

# SPECIFICATIONS

MATERIAL: ALUMINUM SHEET .125 THICK  
ALLOY:6061-T6 PER QQA 250/11 & ASTM B209

## CHASSIS PANELS

### FRONT ◆

RACK HEIGHT (IN)	FRONT PANEL SKU	LLLNL STK# 5975-	FRONT PANEL CHASSIS PLATE MTG. SKU
1U 1.750	FP1	57982	FP1M ☆
2U 3.500	FP2	53352	FP2M ☆
3U 5.250	FP3	53353	FP3M ☆
4U 7.000	FP4	53354	FP4M ☆
5U 8.750	FP5	53355	FP5M ☆
6U 10.50	FP6	53356	FP6M ☆
7U 12.25	FP7	53357	FP7M ☆
8U 14.00	FP8	53358	FP8M ☆
9U 15.75	FP9	53359	FP9M ☆

STANDARD FINISH: CHEMICAL FILM PER MIL-C-5541E  
TYPE 1 CLASS 3 (GOLD)



◆ CUSTOM APPLICATIONS AVAILABLE UPON REQUEST

☆ FRONT PANELS WITH CENTER SUPPORT BAR MOUNTING FEATURES FOR UTILIZATION OF CHASSIS PLATES

# SPECIFICATIONS

MATERIAL: ALUMINUM SHEET .125 THICK  
ALLOY:6061-T6 PER QQA 250/11 & ASTM B209

## CHASSIS PANELS

### REAR ◆

RACK HEIGHT (IN)	REAR PANEL SKU	LLNL STK# 5975-	REAR PANEL CHASSIS PLATE MTG. SKU
1U 1.375	RP1	57983	RP1M ☆
2U 3.000	RP2	53360	RP2M ☆
3U 4.750	RP3	53361	RP3M ☆
4U 6.500	RP4	53362	RP4M ☆
5U 8.250	RP5	53363	RP5M ☆
6U 10.00	RP6	53364	RP6M ☆
7U 11.75	RP7	53365	RP7M ☆
8U 13.50	RP8	53366	RP8M ☆
9U 15.25	RP9	53367	RP9M ☆

STANDARD FINISH: NONE



◆ CUSTOM APPLICATIONS AVAILABLE UPON REQUEST

☆ REAR PANELS INCLUDES CENTER SUPPORT BAR MOUNTING FEATURES FOR UTILIZATION OF CHASSIS PLATES

**CHASSIS SIDE  
BRACKETS** ◆

ACTUAL HEIGHT (IN)	8" DEPTH		14" DEPTH	
	SIDE BRKT. SKU	LLNL STK# 5975-	SIDE BRKT. SKU	LLNL STK# 5975-
1U 1.375	SB18	57984	SB114	57985
2U 3.000	SB28	53368	SB214	53376
3U 4.750	SB38	53369	SB314	53378
4U 6.500	SB48	53370	SB414	53380
5U 8.250	SB58	53371	SB514	53382
6U 10.00	SB68	▲	SB614	53384
7U 11.75	SB78	▲	SB714	▲
8U 13.50	SB88	▲	SB814	▲
9U 15.25	SB98	▲	SB914	▲

▲ **UNSPECIFIED**

◆ CUSTOM APPLICATIONS AVAILABLE  
UPON REQUEST

**SPECIFICATIONS  
8" DEPTH**

MATERIAL: ALUMINUM SHEET .063 THICK  
ALLOY: 5052-H32 PER QQA 250/8 & ASTM B209

STANDARD FINISH: CHEMICAL FILM PER  
MIL-C-5541E  
TYPE 1 CLASS 3 (GOLD)

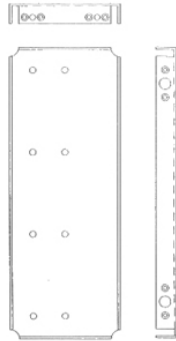

**SPECIFICATIONS  
14" DEPTH**

MATERIAL: ALUMINUM SHEET .063 THICK  
ALLOY: 5052-H32 PER QQA 250/8 & ASTM B209

STANDARD FINISH: CHEMICAL FILM PER  
MIL-C-5541E  
TYPE 1 CLASS 3 (GOLD)

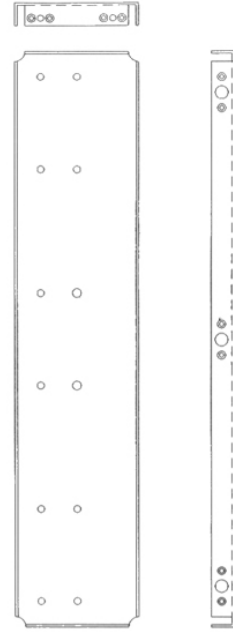

**CHASSIS SIDE  
BRACKETS** ◆

	20" DEPTH		26" DEPTH	
ACTUAL HEIGHT (IN)	SIDE BRKT. SKU	LLNL STK# 5975-	SIDE BRKT. SKU	LLNL STK# 5975-
1U 1.375	SB120	▲	SB126	▲
2U 3.000	SB220	▲	SB226	▲
3U 4.750	SB320	53386	SB326	▲
4U 6.500	SB420	53388	SB426	▲
5U 8.250	SB520	53390	SB526	▲
6U 10.00	SB620	53392	SB626	▲
7U 11.75	SB720	62965	SB726	▲
8U 13.50	SB820	▲	SB826	▲
9U 15.25	SB920	▲	SB926	▲

▲ UNSPECIFIED

◆ CUSTOM APPLICATIONS AVAILABLE  
UPON REQUEST

**SPECIFICATIONS  
20" DEPTH**

MATERIAL: ALUMINUM SHEET .063 THICK  
ALLOY: 5052-H32 PER QQA 250/8 & ASTM B209

STANDARD FINISH: CHEMICAL FILM PER  
MIL-C-5541E  
TYPE 1 CLASS 3 (GOLD)

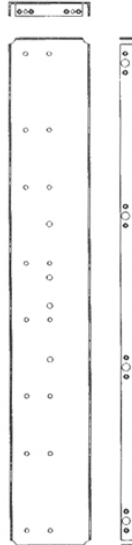

**SPECIFICATIONS  
26" DEPTH**

MATERIAL: ALUMINUM SHEET .063 THICK  
ALLOY: 5052-H32 PER QQA 250/8 & ASTM B209

STANDARD FINISH: CHEMICAL FILM PER  
MIL-C-5541E  
TYPE 1 CLASS 3 (GOLD)

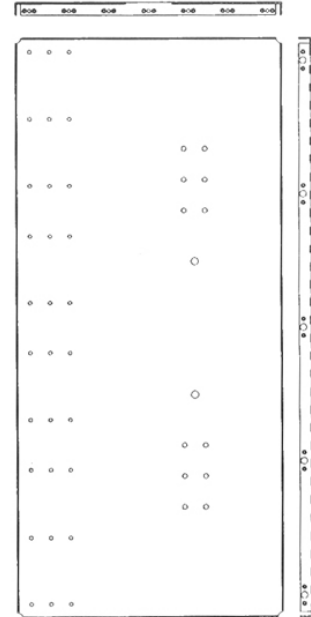

**CHASSIS  
COVERS** ◆

**SPECIFICATIONS**  
**8", 14", 20", 26"**  
**DEPTH**

MATERIAL: ALUMINUM SHEET .063 THICK  
ALLOY: 5052-H32 PER QQA 250/8 & ASTM B209

STANDARD FINISH: CHEMICAL FILM PER MIL-C-5541E  
TYPE I CLASS 3 (GOLD)

	17" WIDTH					
ACTUAL DEPTH (IN)	COVER SOLID SKU	LLNL STK# 5975-	COVER PERF. SKU	LLNL STK# 5975-	COVER PERF P. GRID SKU	LLNL STK# 5975-
1D 7.94	CS18	53411	CP18	53412	CG18	▲
2D 13.94	CS214	53413	CP214	53414	CG214	64878
3D 19.94	CS320	53415	CP320	53416	CG320	64879
4D 25.94	CS426	▲	CP426	▲	CG426	▲

▲ **UNSPECIFIED**

◆ CUSTOM APPLICATIONS AVAILABLE UPON REQUEST

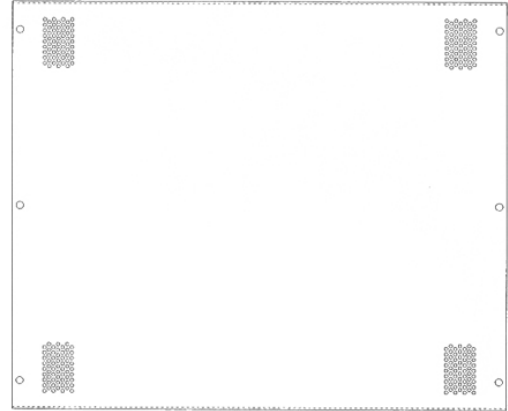

## CHASSIS SYSTEM ORDERING

Ordering the Chassis System of your choice is Simple.

Just pick up the phone and call 1- 877- 800- RACK

or

Fax your order to 925-371-0221

or

Contact us via Email at [www.RonNunes.com](http://www.RonNunes.com)

To order, specify SKUS' as shown in the examples below;

Example: To order a 7U high chassis, 14" deep,  
with 2 each solid covers and 14" chassis slides;

1	2	3	4	5	6	7
CHASSIS ASSEMBLY SKU	CHASSIS PLATE MOUNTING ANGLE BRACKETS SKU	CHASSIS PLATE CENTER SUPPORT BAR SKU	CHASSIS PLATE HALF WIDTH SKU	CHASSIS PLATE FULL WIDTH W/O CTR.SPPT. BAR SKU	CHASSIS PLATE FULL WIDTH WITH CTR.SPPT. BAR SKU	CHASSIS SLIDES SKU
C7141						S14

Example: To order a 7U high chassis, 14" deep, with 2 each solid covers, chassis plate mounting angle brackets, center bar support, 13 1/2" long full width chassis plate and 14" chassis slides;

1	2	3	4	5	6	7
CHASSIS ASSEMBLY SKU	CHASSIS PLATE MOUNTING ANGLE BRACKETS SKU	CHASSIS PLATE CENTER SUPPORT BAR SKU	CHASSIS PLATE HALF WIDTH SKU	CHASSIS PLATE FULL WIDTH W/O CTR. SPPT. BAR SKU	CHASSIS PLATE FULL WIDTH WITH CTR. SPPT. BAR SKU	CHASSIS SLIDES SKU
C7141	AB2	CB2			FCP4M	S14



## CHASSIS ASSEMBLIES

### 8" DEPTH

RACK HEIGHT (IN)	2 EACH SOLID COVERS SKU	2 EACH PERFORATED COVERS SKU	1 EACH SOLID COVER 1 EACH PERF CVR. SKU	1 EACH SOLID CVR. 1 EACH PERF PARTIAL GRID CVR. SKU	1 EACH PERF CVR. 1 EACH PERF PARTIAL GRID CVR. SKU	2 EACH PERFORATED PARTIAL GRID CVR SKU
1U 1.750	C181 ☆	C182 ☆	C183 ☆	C184 ☆	C185 ☆	C186 ☆
2U 3.500	C281	C282	C283	C284	C285	C286
3U 5.250	C381	C382	C383	C384	C385	C386
4U 7.000	C481	C482	C483	C484	C485	C486
5U 8.750	C581	C582	C583	C584	C585	C586
6U 10.500	C681	C682	C683	C684	C685	C686
7U 12.250	C781	C782	C783	C784	C785	C786
8U 14.000	C881	C882	C883	C884	C885	C886
9U 15.750	C981	C982	C983	C984	C985	C986

CUSTOM APPLICATIONS AVAILABLE UPON REQUEST

☆ SLIDE APPLICATIONS AVAILABLE UPON REQUEST

# 14" DEPTH

RACK HEIGHT (IN)	2 EACH SOLID COVERS SKU	2 EACH PERFORATED COVERS SKU	1 EACH SOLID COVER 1 EACH PERF CVR. SKU	1 EACH SOLID CVR. 1 EACH PERF PARTIAL GRID CVR. SKU	1 EACH PERF CVR. 1 EACH PERF PARTIAL GRID CVR. SKU	2 EACH PERFORATED PARTIAL GRID CVR SKU
1U 1.750	C1141★	C1142★	C1143★	C1144★	C1145★	C1146★
2U 3.500	C2141	C2142	C2143	C2144	C2145	C2146
3U 5.250	C3141	C3142	C3143	C3144	C3145	C3146
4U 7.000	C4141	C4142	C4143	C4144	C4145	C4146
5U 8.750	C5141	C5142	C5143	C5144	C5145	C5146
6U 10.500	C6141	C6142	C6143	C6144	C6145	C6146
7U 12.250	C7141	C7142	C7143	C7144	C7145	C7146
8U 14.000	C8141	C8142	C8143	C8144	C8145	C8146
9U 15.750	C9141	C9142	C9143	C9144	C9145	C9146

CUSTOM APPLICATIONS AVAILABLE UPON REQUEST

★ SLIDE APPLICATIONS AVAILABLE UPON REQUEST

## 20" DEPTH

RACK HEIGHT (IN)	2 EACH SOLID COVERS SKU	2 EACH PERFORATED COVERS SKU	1 EACH SOLID COVER 1 EACH PERF CVR. SKU	1 EACH SOLID CVR. 1 EACH PERF PARTIAL GRID CVR. SKU	1 EACH PERF CVR. 1 EACH PERF PARTIAL GRID CVR. SKU	2 EACH PERFORATED PARTIAL GRID CVR. SKU
1U 1.750	C1201★	C1202★	C1203★	C1204★	C1205★	C1206★
2U 3.500	C2201	C2202	C2203	C2204	C2205	C2206
3U 5.250	C3201	C3202	C3203	C3204	C3205	C3206
4U 7.000	C4201	C4202	C4203	C4204	C4205	C4206
5U 8.750	C5201	C5202	C5203	C5204	C5205	C5206
6U 10.500	C6201	C6202	C6203	C6204	C6205	C6206
7U 12.250	C7201	C7202	C7203	C7204	C7205	C7206
8U 14.000	C8201	C8202	C8203	C8204	C8205	C8206
9U 15.750	C9201	C9202	C9203	C9204	C9205	C9206

CUSTOM APPLICATIONS AVAILABLE UPON REQUEST

★ SLIDE APPLICATIONS AVAILABLE. UPON REQUEST

## 26" DEPTH

RACK HEIGHT (IN)	2 EACH SOLID COVERS SKU	2 EACH PERFORATED COVERS SKU	1 EACH SOLID COVER 1 EACH PERF CVR. SKU	1 EACH SOLID CVR. 1 EACH PERF PARTIAL GRID CVR. SKU	1 EACH PERF CVR. 1 EACH PERF PARTIAL GRID CVR. SKU	2 EACH PERFORATED PARTIAL GRID CVR SKU
1U 1.750	C1261 ☆	C1262 ☆	C1263 ☆	C1264 ☆	C1265 ☆	C1266 ☆
2U 3.500	C2261	C2262	C2263	C2264	C2265	C2266
3U 5.250	C3261	C3262	C3263	C3264	C3265	C3266
4U 7.000	C4261	C4262	C4263	C4264	C4265	C4266
5U 8.750	C5261	C5262	C5263	C5264	C5265	C5266
6U 10.500	C6261	C6262	C6263	C6264	C6265	C6266
7U 12.250	C7261	C7262	C7263	C7264	C7265	C7266
8U 14.000	C8261	C8262	C8263	C8264	C8265	C8266
9U 15.750	C9261	C9262	C9263	C9264	C9265	C9266

## ACCESSORIES

### CHASSIS PLATE MOUNTING ANGLE BRACKETS

ACTUAL LENGTH (IN)	ANGLE BRACKET SKU	LLNL STK# 5975-	CHASSIS DEPTH (MINIMUM)
1D 7.500	AB1 ☆	53403	8"
2D 13.500	AB2 ☆	53404	14"
3D 19.500	AB3 ☆	53405	20"
4D 25.500	AB4 ☆	UNSPECIFIED	26"

**CUSTOM APPLICATIONS AVAILABLE UPON REQUEST**

☆ 1 EACH CENTER SUPPORT BAR & 1 EACH ANGLE BRACKET REQUIRED WHEN UTILIZING HALF WIDTH CHASSIS PLATES.

HARDWARE PACKAGES ARE SUPPLIED WITH CHASSIS PLATE ANGLE BRACKETS TO INCLUDE ALL FASTENERS REQUIRED FOR SIDE BRACKET MOUNTING.

## SPECIFICATIONS

**MATERIAL: ALUMINUM SHEET .063 THICK  
ALLOY: 5052-H32 PER QQA 250/8 & ASTM B209**

**STANDARD FINISH: CHEMICAL FILM PER MIL-C-5541E  
TYPE 1 CLASS 3 (GOLD)**

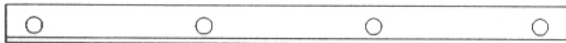
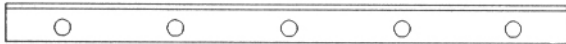

## ACCESSORIES

### CHASSIS PLATE CENTER SUPPORT BAR

ACTUAL LENGTH (IN)	CENTER BAR SKU	LLNL STK# 5975-	CHASSIS DEPTH (MINIMUM)
1D 8.000	CB1 ☆	53407	8"
2D 14.000	CB2 ☆	53408	14"
3D 20.000	CB3 ☆	53409	20"
4D 26.000	CB4 ☆	UNSPECIFIED	26"

**CUSTOM APPLICATIONS AVAILABLE UPON REQUEST**

☆ 1 EACH CENTER SUPPORT BAR & 1 EACH ANGLE BRACKET REQUIRED WHEN UTILIZING HALF WIDTH CHASSIS PLATES.

HARDWARE PACKAGES ARE SUPPLIED WITH CENTER SUPPORT BAR TO INCLUDE ALL FASTENERS REQUIRED FOR CHASSIS PLATE MOUNTING.

## SPECIFICATIONS

**MATERIAL: EXTRUDED ALUMINUM RECTANGLE  
.375X.750**

**ALLOY: 6061-T6 PER QQ-A-200/10 & ASTM B-221**

**STANDARD FINISH: CHEMICAL FILM PER MIL-C-5541E  
TYPE 1 CLASS 3 (GOLD)**

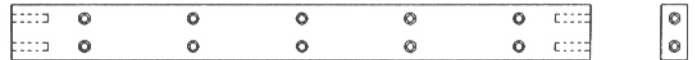

# ACCESSORIES

## CHASSIS PLATES HALF WIDTH

### 8.250" WIDTH

ACTUAL LENGTH (IN)	HALF WIDTH CHASSIS PLT. SKU	ULLNL STK# 5975-	CHASSIS DEPTH (MINIMUM)
1.500	HCP1 ☆	53419	8"
3.000	HCP2 ☆	53420	8"
4.500	HCP3 ☆	53421	8"
6.000	HCP4 ☆	53422	8"
7.500	HCP5 ☆	53423	8"
9.000	HCP6 ☆	53424	14"
10.500	HCP7 ☆	53425	14"
12.000	HCP8 ☆	53426	14"
13.500	HCP9 ☆	53427	14"
19.500	HCP10 ☆	53431	20"

 CUSTOM APPLICATIONS AVAILABLE UPON REQUEST

☆ 1 EACH CENTER BAR SUPPORT & 1 EACH ANGLE BRACKET REQUIRED WHEN UTILIZING HALF WIDTH CHASSIS PLATES

# SPECIFICATIONS

MATERIAL: ALUMINUM SHEET.125 THICK  
ALLOY: 5052-H32 PER QQA 250/8 & ASTM B209

STANDARD FINISH: NONE

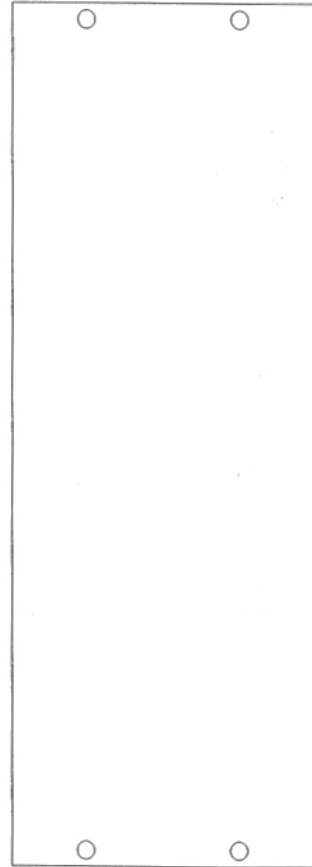

## ACCESSORIES

### CHASSIS PLATES FULL WIDTH WITHOUT CENTER SUPPORT BAR MOUNTING FEATURES

16.560" WIDTH			
ACTUAL LENGTH (IN)	CHASSIS PLATE SKU	LLLNL STK# 5975-	CHASSIS DEPTH (MINIMUM)
4.500	FCP1 $\Delta$	53433	8"
7.500	FCP2 $\Delta$	53435	8"
10.500	FCP3 $\Delta$	53437	14"
13.500	FCP4 $\Delta$	53439	14"
16.500	FCP5 $\Delta$	53441	20"
19.500	FCP6 $\Delta$	53443	20"

### CHASSIS PLATES FULL WIDTH WITH CENTER SUPPORT BAR MOUNTING FEATURES

16.560" WIDTH			
ACTUAL LENGTH (IN)	CHASSIS PLATE SKU	LLLNL STK# 5975-	CHASSIS DEPTH (MINIMUM)
4.500	FCP1M $\star$	53432	8"
7.500	FCP2M $\star$	53434	8"
10.500	FCP3M $\star$	53436	14"
13.500	FCP4M $\star$	53438	14"
16.500	FCP5M $\star$	53440	20"
19.500	FCP6M $\star$	53442	20"

## SPECIFICATIONS

**MATERIAL: ALUMINUM SHEET.125 THICK  
ALLOY: 5052-H32 PER QQA 250/8 & ASTM B209  
STANDARD FINISH: NONE**

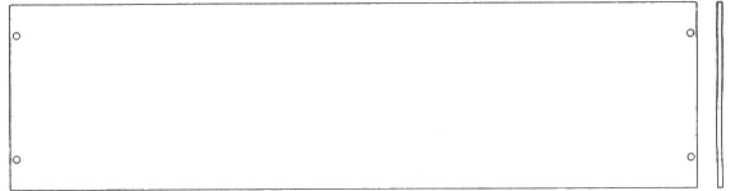

### **CUSTOM APPLICATIONS AVAILABLE UPON REQUEST**

$\Delta$  2 EACH ANGLE BRACKETS REQUIRED WHEN UTILIZING FULL WIDTH CHASSIS PLATES.



$\star$  2 EACH ANGLE BRACKETS & 1 EACH CENTER SUPPORT BAR REQUIRED WHEN UTILIZING FULL WIDTH CHASSIS PLATES WITH CENTER SUPPORT BAR MOUNTING FEATURES.

HARDWARE PACKAGES ARE SUPPLIED WITH FULL WIDTH CHASSIS PLATES TO INCLUDE ALL FASTENERS REQUIRED FOR ANGLE BRACKET MOUNTING.

## CHASSIS SLIDES

## FEATURES

### CHASSIS SLIDES

SLIDE LENGTH (IN)	SLIDE SKU
12.000	S12 ☆
14.000	S14 ☆
16.000	S16 ☆
18.000	S18 ☆
20.000	S20 ☆
22.000	S22 ☆
24.000	S24 ☆

SOLID BEARING SLIDES PROVIDE HIGH RESISTANCE TO SHOCK AND VIBRATION, AND ARE WELL SUITED FOR **MOBILE APPLICATIONS**.

CHASSIS SLIDES ARE TRI-SECTIONAL IN CONSTRUCTION AND ALLOW FULL EXTENSION. THIS DESIGN WILL FIT ANY **STANDARDIZED** RACK OR ENCLOSURE.

STANDARD FEATURES INCLUDE **AUTOMATIC LOCK-OUT** AND PUSHBUTTON LOCK RELEASE THAT PERMITS INSTANT CHASSIS REMOVAL FROM THE RACK.

THE PIVOT-LOCK DETENT SECTION PROVIDES SEVEN POSITIONS OF ROTATION FOR **CONVENIENT ACCESS**.

**SLIM-LINE DESIGN** PERMITS INSTALLATION OF STANDARD 17" CHASSIS IN STANDARD 19" RACKS.

**QUICK AND EASY INSTALLATION** IS ASSURED BY THE EASY TO READ ASSEMBLY INSTRUCTIONS THAT ACCOMPANY EACH SHIPMENT.

STANDARD HARDWARE PACKAGES INCLUDE **ALL FASTENERS** NECESSARY FOR CHASSIS SLIDE MOUNTING.

CONFORMANCE TO RIGID DIMENSIONAL REQUIREMENTS PROVIDES **SMOOTH AND RELIABLE SLIDE ACTION** WITH EACH USE.

 **CUSTOM APPLICATIONS AVAILABLE UPON REQUEST**

☆ CHASSIS SLIDES ARE FURNISHED IN PAIRS. 1 EACH RH & 1 EACH LH.

HARDWARE PACKAGES ARE SUPPLIED WITH SLIDE PAIRS TO INCLUDE ALL FASTENERS REQUIRED FOR SIDE BRACKET MOUNTING.



# SPECIFICATIONS

## CHASSIS SLIDES

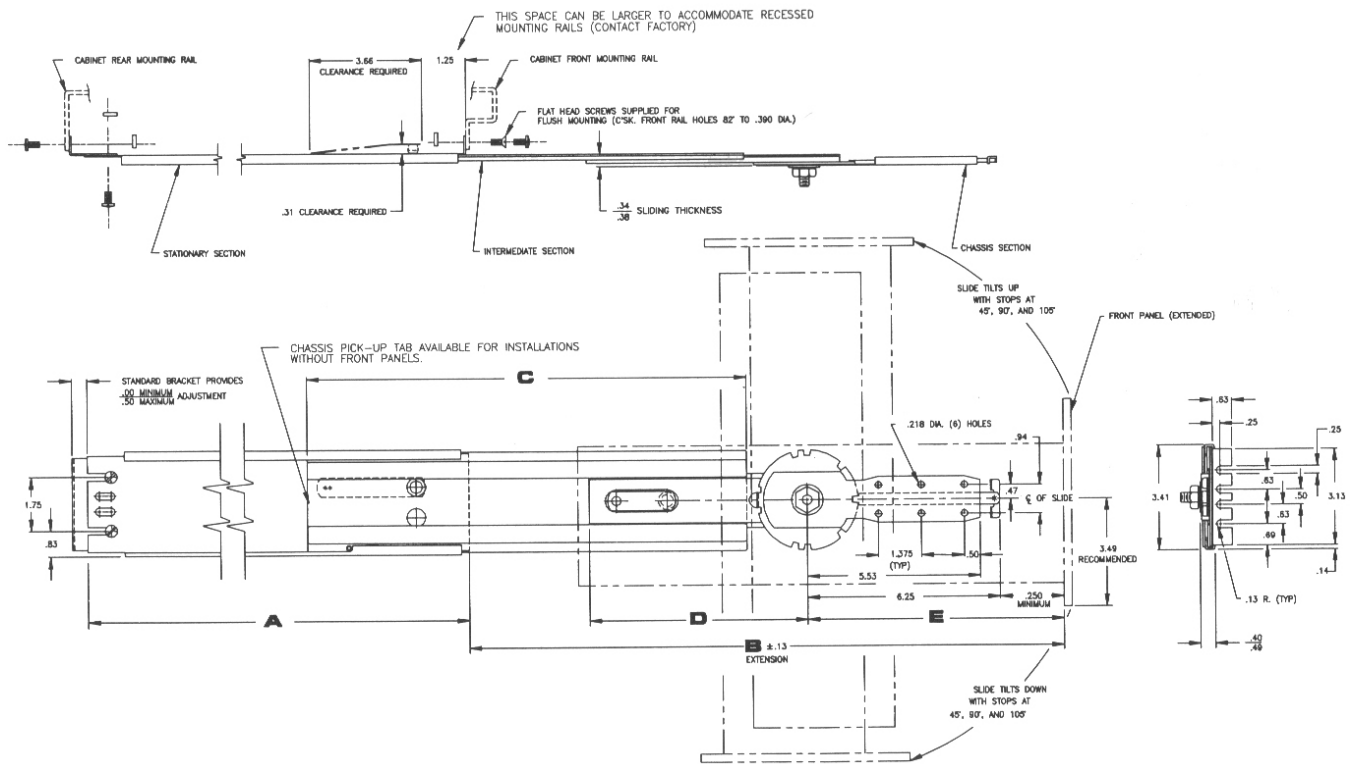

SLIDE SKU	A	B (MIN)	B (MAX)	C	D	E (MIN)	E (MAX)	LOAD CAPACITY
S12	12.00	14.56	14.56	11.00	5.50	6.50	6.50	175 LBS.
S14	14.00	16.25	16.75	13.00	7.00	6.50	7.00	175 LBS.
S16	16.00	19.00	19.63	15.00	8.88	6.50	7.13	175 LBS.
S18	18.00	21.00	23.63	17.00	8.88	6.50	9.13	175 LBS.
S20	20.00	23.00	27.63	19.00	8.88	6.50	11.13	175 LBS.
S22	22.00	26.25	31.63	21.00	9.75	6.88	12.25	175 LBS.
S24	24.00	28.25	34.63	23.00	9.75	7.88	14.25	175 LBS.

All dimensions in inches unless stated otherwise

**ACCESSORIES**   
CHASSIS HANDLES  
FRONT PANEL MOUNTING

RACK HEIGHT (IN)	HANDLE SKU	LLNL STK# 5975-
1U 1.750	★	★
2U 3.500	H250 Δ	49699
3U 5.250	H425 Δ	49700
4U 7.000	H600 Δ	49701
5U 8.750	H775 Δ	49702
6U 10.500	H950 Δ	49703
7U 12.250	H600 Δ	49701
8U 14.000	H775 Δ	49702
9U 15.750	H950 Δ	49703

 CUSTOM APPLICATIONS AVAILABLE UPON REQUEST

★ CHASSIS HANDLES ARE AVAILABLE ON 1U/1.750" HEIGHT FRONT PANELS UPON REQUEST.

Δ CHASSIS HANDLES ARE STANDARD WITH CHASSIS ASSEMBLIES.

CHASSIS HANDLES ARE AVAILABLE AS PAIRS ( 2 EA.).

HARDWARE PACKAGES ARE SUPPLIED WITH CHASSIS HANDLES TO INCLUDE ALL FASTENERS REQUIRED FOR FRONT PANEL MOUNTING.

**SPECIFICATIONS**  
CHASSIS HANDLES  
FRONT PANEL MOUNTING

MATERIAL: ALUMINUM EXTRUDED OVAL .28 X .62  
 ALLOY:6061-T5 PER QQA 250/8 & ASTM B221

STANDARD FINISH: ANODIZE PER MIL-A-8625E  
 CLASS 2 TYPE 2 (BLACK)

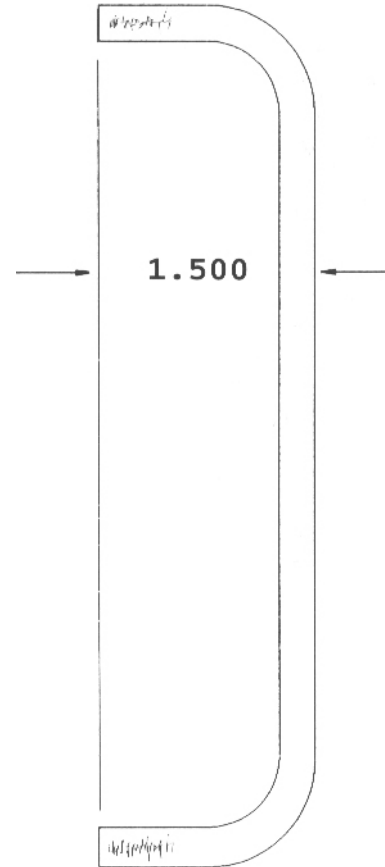

# ACCESSORIES

## BLANK FRONT PANELS

RACK HEIGHT (IN)	BLANK FRONT PANEL	LLLNL STK# 5975-	BLK. PAINTED FRONT	LLLNL STK# 5975-
1U 1.750	BFP1	62831	BFP1P ☆	49433
2U 3.500	BFP2	62832	BFP2P ☆	49434
3U 5.250	BFP3	62833	BFP3P ☆	49435
4U 7.000	BFP4	62834	BFP4P ☆	49436
5U 8.750	BFP5	62835	BFP5P ☆	49437
6U 10.500	BFP6	62836	BFP6P ☆	49438
7U 12.250	BFP7	62837	BFP7P ☆	49439
8U 14.000	BFP8	UNSPECIFIED	BFP8P ☆	49440
9U 15.750	BFP9	UNSPECIFIED	BFP9P ☆	49441
10U 17.500	BFP10	UNSPECIFIED	BFP10P ☆ ☆☆☆	49442
11U 19.250	BFP11	UNSPECIFIED	BFP11P ☆	49443
12U 21.000	BFP12	UNSPECIFIED	BFP12P ☆	49444

 CUSTOM APPLICATIONS AVAILABLE UPON REQUEST

 PAINTED FLAT GREY PER LLLNL SPECIFICATION LED 67-9092

# SPECIFICATIONS

MATERIAL: ALUMINUM SHEET .125 THICK  
ALLOY:6061-T6 PER QQA 250/11 & ASTM B209

STANDARD UNPAINTED FINISH: CHEMICAL FILM  
PER MIL-C-5541E  
TYPE CLASS (GOLD)



Ordering the Chassis System of your choice is Simple.

Just pick up the phone and call 1- 877- 800- **RACK**

or

Fax your order to **925-371-0221**

or

Contact us via Email at [www.RonNunes.com](http://www.RonNunes.com)

To order, specify SKUS' as shown in the examples below;

**Example: To order a 7U high Chassis, 14" deep, with 2 each Solid Covers and 14" Chassis Slides;**

1	2	3	4	5	6	7
CHASSIS ASSEMBLY SKU	CHASSIS PLATE MOUNTING ANGLE BRACKETS SKU	CHASSIS PLATE CENTER SUPPORT BAR SKU	CHASSIS PLATE HALF WIDTH SKU	CHASSIS PLATE FULL WIDTH W/0 CTR. SUPT. BAR SKU	CHASSIS PLATE FULL WIDTH WITH CTR. SUPT. BAR SKU	CHASSIS SLIDES SKU
C7141						S14

**Example: To order a 7U high Chassis, 14" deep, with 2 each Solid Covers, Chassis Plate Mounting Angle Brackets, Center Bar Support, 13 1/2" long Full Width Chassis Plate and 14" Chassis Slides;**

1	2	3	4	5	6	7
CHASSIS ASSEMBLY SKU	CHASSIS PLATE MOUNTING ANGLE BRACKETS SKU	CHASSIS PLATE CENTER SUPPORT BAR SKU	CHASSIS PLATE HALF WIDTH SKU	CHASSIS PLATE FULL WIDTH W/0 CTR. SPPT. BAR SKU	CHASSIS PLATE FULL WIDTH WITH CTR. SPPT. BAR SKU	CHASSIS SLIDES SKU
C7141	AB2	CB2			FCP4M	S14