

REMstar® | plus with C-Flex™
CPAP System

User Manual

NOTE: The C-Flex mark is used under license.

















Table of Contents

Symbol Key	2
Intended Use & Contraindications	3
Specifications	4
Warnings	5
Cautions	6
Unpacking the System	6
System Features	7
First Time Setup	8
○ Installing the Filter	9
○ Device Settings	10
○ Assembling the Circuit	15
Accessories	16
○ Adding a Humidifier	16
○ Adding Oxygen to the System	16
○ Using DC Power with the System	16
Routine Use	17
○ Connecting the Circuit.....	17
○ Adjusting the Circuit	17
○ Ramp Button	18
○ Turning the System Off	18
○ Helpful Hints	18
Routine Maintenance	19
○ Cleaning the Filter	19
○ Cleaning the System	19
○ Reordering	20
○ Service	20
Traveling with the System	20
Troubleshooting	21
EMC Requirements	23
Warranty	26

Symbols









Display Screen

 Attention is needed	 Humidifier is ON or humidifier setting	 Hours of use
 Patient disconnect alert enabled or setting	 Ramp start pressure setting	 Number of nights with more than 4 hours usage
 Button Lights are ON or setting	 Ramp pressure is being delivered	 Low Elevation
 C-Flex setting	 Centimeters of water (displayed with pressure readings or settings)	 Medium Elevation
 Blower Time Meter		 High Elevation

Control Buttons

 Pressure Start / Stop	 Ramp Start	 Humidifier On / Off
---	--	--

Device

 Attention, Consult Accompanying Documents	 Type BF Applied Part	 European CE Declaration of Conformity
 DC Power	 Class II (Double Insulated)	 Notified Body Approval for Standards Compliance
 AC Power	IPX0 Ordinary Equipment Rating	 Canadian/US Certification

REMstar Plus with C-Flex CPAP systems are the subject of the following U.S. patents: #5239995 and #6105575.

Other patents pending.

REMstar, Whisper Swivel and Encore are registered trademarks of Respirationics, Inc.

©Respirationics, Inc. 2003

Intended Use

The Respironics REMstar Plus with C-Flex system is a CPAP (Continuous Positive Airway Pressure) device designed for the treatment of adult Obstructive Sleep Apnea (OSA) only.

The REMstar Plus with C-Flex is to be used only on the instruction of a licensed health care professional. Your home care provider will make the correct pressure settings according to your health care professional's prescription.

Several accessories are available to make your OSA treatment with the REMstar Plus with C-Flex CPAP system as convenient and comfortable as possible. To ensure that you receive the safe, effective therapy prescribed for you, use only Respironics accessories.

IMPORTANT! *Read and understand the entire user manual before operating this system. If you have any questions concerning the use of this system, contact your home care provider or health care professional.*

Contraindications

Studies have shown that the following pre-existing conditions may contraindicate the use of positive airway pressure therapy for some patients:

- Bullous Lung Disease
- Bypassed Upper Airway
- Pneumothorax
- Pathologically Low Blood Pressure
- Pneumocephalus has been reported in a patient using nasal Continuous Positive Airway Pressure. Caution should be used when prescribing CPAP for susceptible patients such as those with: cerebral spinal fluid leaks, abnormalities of the cribriform plate, prior history of head trauma, and/or pneumocephalus. (Chest 1989; 96:1425-1426)
- The use of positive airway pressure therapy may be temporarily contraindicated if you exhibit signs of a sinus or middle ear infection.

Contact your health care professional if you have any questions concerning your therapy.

Specifications

Device Size	Dimensions: 9 1/2" x 6 7/8" x 4 1/2" (24 x 17 x 12 cm) Weight: <4.0 lbs. (<1.8 kg)								
Product Use, Transport, and Storage	<table><thead><tr><th>Operation</th><th>Transport & Storage</th></tr></thead><tbody><tr><td>Temperature: 41 to 95° F (5 to 35° C)</td><td>-4 to 140° F (-20 to 60° C)</td></tr><tr><td>Humidity: 15 to 95% Non-condensing</td><td>15 to 95% Non-condensing</td></tr><tr><td>Atmospheric Pressure: 76.7 to 102 kPascals</td><td>N/A</td></tr></tbody></table>	Operation	Transport & Storage	Temperature: 41 to 95° F (5 to 35° C)	-4 to 140° F (-20 to 60° C)	Humidity: 15 to 95% Non-condensing	15 to 95% Non-condensing	Atmospheric Pressure: 76.7 to 102 kPascals	N/A
Operation	Transport & Storage								
Temperature: 41 to 95° F (5 to 35° C)	-4 to 140° F (-20 to 60° C)								
Humidity: 15 to 95% Non-condensing	15 to 95% Non-condensing								
Atmospheric Pressure: 76.7 to 102 kPascals	N/A								
Standards Compliance	This device is designed to conform to the following standards: IEC 60601-1 General Requirements for Safety of Medical Electrical Equipment IEC/EN 60601-1-2:2001 (2nd Edition) Immunity for Medical Electrical Equipment EN ISO 17510-1 Sleep Apnea Breathing Therapy Devices								
Mode of Operation	Continuous								
AC Power Consumption	100 - 240 VAC, 50/60 Hz, 1.0 A max.								
DC Power Consumption	12 VDC, 3.0 A max.								
Type of Protection Against Electric Shock	Class II Equipment								
Degree of Protection Against Electric Shock	Type BF Applied Part								
Degree of Protection Against Ingress of Water	IPX0 - Ordinary Equipment								
Pressure Range	4 to 20 cm H ₂ O (in 1 cm H ₂ O increments)								
Pressure Stability	4 to 20 cm H ₂ O (±1.0 cm H ₂ O) Measured in accordance with EN ISO 17510 @ 6.6, 13.2, & 20 cm H ₂ O @ 500 ml with BPM set to 10, 15, & 20 BPM performed at 23° C (±2° C), 50% RH (±5%), and an atmospheric pressure of 101.54 kPascals.								
Sound Pressure Level	<30 dB(A) Measured in accordance with EN ISO 17510 @ 10 cm H ₂ O at the patient circuit. This measurement applies to the CPAP device with or without the optional REMstar Heated Humidifier.								
Maximum Flow	35 LPM Measured in accordance with EN ISO 17510 @ 6.6, 13.2, & 20 cm H ₂ O @ 500 ml with BPM set to 10, 15, & 20 BPM performed at 23° C (±2° C), 50% RH (±5%), and an atmospheric pressure of 101.54 kPascals.								
Pressure Display Accy.	±(0.15 + 4% of actual reading)								

Warnings & Cautions

CAUTION!

- U.S. federal law restricts this device to sale by or on the order of a physician.

WARNING!

Indicates the possibility for injury to the user or the operator.

- The instructions in this manual are not intended to supersede established medical protocols.
- This device is intended for adult use only.
- This device is not intended for life support.
- CPAP devices have the potential to allow rebreathing of exhaled air. To reduce this potential, observe the following:
 - Use Respironics circuit accessories.
 - Do not wear the mask and headgear for more than a few minutes while the device is not operating.
 - Do not block or try to seal the vent holes in the exhalation port.

As with most CPAP devices: At low CPAP pressures, some exhaled gas (CO₂) may remain in the mask and be rebreathed.

- Do not use this device if the room temperature is warmer than 95° F (35° C). If this device is used at room temperatures warmer than 95° F (35° C), the temperature of the airflow may exceed 106° F (41° C). This could cause irritation to your airway.
- This equipment is not suitable for use in the presence of a flammable anaesthetic mixture in combination with oxygen or air, or in the presence of nitrous oxide.
- If you notice any unexplained changes in the performance of the REMstar Plus with C-Flex, if it is making unusual or harsh sounds, if it has been dropped or mishandled, if the enclosure is broken, or if water has entered the enclosure, disconnect the power cord and discontinue use. Contact your home care provider.
- To avoid electrical shock, disconnect the power cord before cleaning. **DO NOT** immerse the device in any fluids.
- Contact your health care professional if symptoms of sleep apnea recur.
- Using the REMstar Plus with C-Flex at an incorrect elevation setting could result in airflow pressures higher than the prescribed setting. Always verify the elevation setting when traveling or relocating.

Warnings & Cautions/Unpacking the System

CAUTION!

Indicates the possibility of damage to the device.

- *Tobacco smoke may cause tar build-up within the REMstar Plus with C-Flex that may result in the REMstar Plus with C-Flex malfunctioning.*
- *The use of accessories other than those specified, with the exception of cables sold by the manufacturer of the equipment or system as replacement parts for internal components, may result in increased emissions or decreased immunity of the equipment or system.*

Additional warnings and cautions are located throughout this manual as they apply.

After unpacking the system, make sure you have everything shown here:

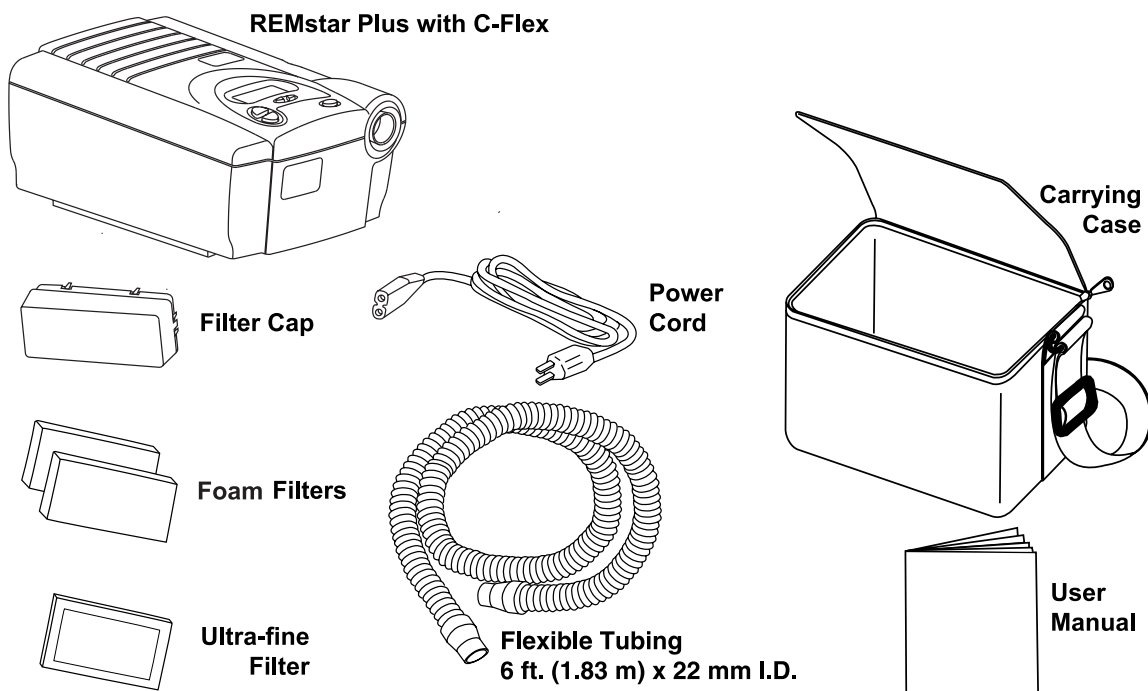

IMPORTANT!

If any of the above parts are missing, contact your home care provider.

System Features

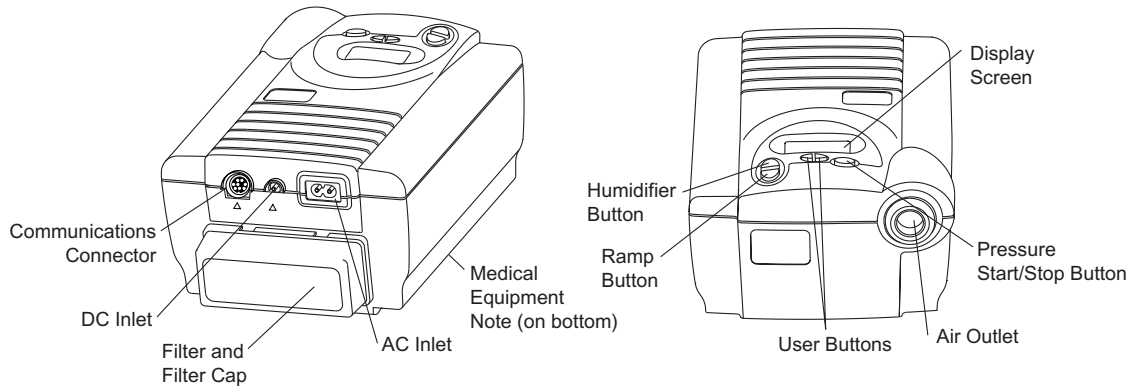

AC Inlet Connect/disconnect the AC power cord here.

Air Outlet Connect the flexible tubing here.

Communications

Connector For clinical use with the Encore® Pro Data Management Software or an IEC 950 approved device. Connect the communications cable here.

DC Inlet Connect the optional DC power cord here.

Display Screen All system settings, total operating time, and therapy hours will appear here. Displays the pressure and elevation settings.

Filter Cap & Filters The foam filter screens out normal household dust and pollens. The optional, ultra-fine filter is also included for more complete filtration of very fine particles. The filter cap is designed to reduce the noise from the REMstar Plus with C-Flex.

Humidifier Button This button turns the REMstar heated humidifier on/off and allows the heat setting to be adjusted. The humidifier is an optional accessory that may be purchased separately.

Medical Product Note For ease at airport security stations, there is a note on the bottom of the REMstar Plus with C-Flex stating that it is medical equipment. It may help if you also take this manual with you when you travel.

Pressure Start / Stop

Button This button starts/stops the airflow.

Ramp Button This button starts the ramp cycle or accesses the REMstar Plus with C-Flex settings.

User Buttons These buttons can be used to change some of the system settings.

First Time Setup

WARNING!

Do not use the REMstar Plus with C-Flex system until an appropriate professional adjusts the settings! To order any accessories not included with this system, contact your home care provider.

Note to home care provider: Before beginning setup, be sure that you have available the REMstar Plus with C-Flex Home Care Provider Setup Instructions. Setup instructions are not provided in this manual.

WARNING!

DO NOT connect any equipment to the REMstar Plus with C-Flex unless recommended by Respironics or your health care provider.

CAUTION!

If the REMstar Plus with C-Flex has been exposed to either very hot or very cold temperatures, allow it to adjust to room temperature (approximately 2 hours) before beginning setup.

First Time Setup (cont.)

Installing the Filter

1. Install the filters and filter cap.

CAUTION!

The foam filter must be in place at all times when the REMstar Plus with C-Flex is operating. The white ultra-fine filter is optional and can be used in addition to the foam filter. The ultra-fine filter is recommended for people who are sensitive to tobacco smoke or other small particles.

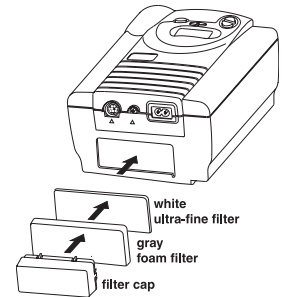

- a. Place one of the foam filters over the ultra-fine filter. If you are not using the ultra-fine filter, simply place the foam filter into the filter area on the back of the REMstar Plus with C-Flex. An extra filter is included for your convenience.
- b. Attach the filter cap. Position the cap so that the small opening on the cap is facing down. Insert the cap's tabs into the filter area opening.

Power Cord

2. Connect the power cord. Plug the socket end of the power cord into the AC inlet on the back of the REMstar Plus with C-Flex. Plug the pronged end of the power cord into an electrical outlet.

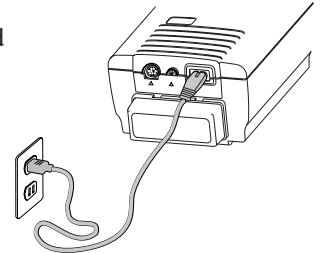

IMPORTANT!

To remove AC power, disconnect the power cord from the electrical outlet.

WARNING!

Inspect the power cord often for any signs of damage. Replace a damaged cord immediately.

WARNING!

The REMstar Plus with C-Flex is activated and ready for use when the power cord is connected. The pressure start/stop button turns the blower on/off.

3. Place the REMstar Plus with C-Flex on a firm, flat surface.

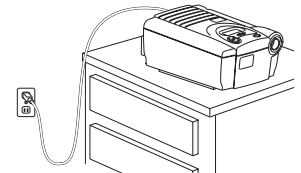

CAUTION!

Make sure the REMstar Plus with C-Flex is away from any heating or cooling equipment (e.g., forced air vents, radiators, air conditioners). Also make sure that bedding, curtains, or other items are not blocking the filter or vents of the device. Air must flow freely around the device for the system to work properly.

First Time Setup (cont.)

Device Settings

Once the power cord is plugged in, REMstar Plus with C-Flex's system version number, the total hours of use, and then the total therapy hours will appear.

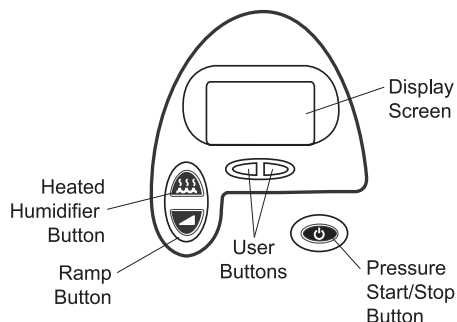

Display Screen: All device settings will appear here.

Pressure Start/Stop Button: Use this button to start/stop the airflow. DO NOT start the airflow until the circuit tubing is connected.

Heated Humidifier Button: Use this button when the optional REMstar Heated Humidifier has been prescribed. This button will control the optional heated humidifier's output. Follow the instructions included with the humidifier.

Ramp Button: When the airflow is turned on, use this button to start the ramp cycle (which lowers the airflow pressure and then gradually increases it). This will allow you to fall asleep more comfortably. When the airflow is turned off, use this button to access the patient menu. *Note: The ramp feature is not prescribed for all users.*

User Buttons: These buttons can be used when entering various menus to change some of the REMstar Plus with C-Flex settings.

IMPORTANT!

In the Setup Menu, the humidifier and ramp buttons operate as up and down keys to change the settings, the left/right user buttons are used to go to the previous/next question or setting, and the start/stop button will allow you to exit the Settings Menu.

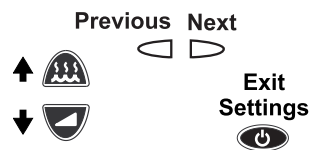

First Time Setup (cont.)

Device Settings

4. Verify/Change the REMstar Plus with C-Flex settings. To start the setup menu, press and hold the ramp button until the device beeps (The airflow must be turned off.)

IMPORTANT! *Pressing the ramp button (when the airflow is turned on) will lower the airflow pressure, if prescribed, and then will gradually increase it.*

WARNING! *DO NOT use the REMstar Plus with C-Flex if the display is erratic. Contact your home care provider for further instructions.*

IMPORTANT! *If at any time you wish to exit the setup menu, press the pressure on/off button and the display will go back to the main screen.*

Therapy Hours

- a. The number of nights the REMstar Plus with C-Flex was used for therapy for more than 4 hours will appear. This screen is only for reference. Your home care provider may periodically ask you for this information.

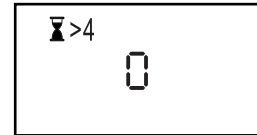

Press the right user button to access the next setting.

First Time Setup (cont.)

Turning the Alert Tone On or Off

- b. The patient disconnect alert setting will appear. This setting has two functions. When a large, continuous air leak (such as mask removal) has been detected in the circuit, this setting enables/disables the audible alert (a beeping sound) and the Auto-off feature. The latter allows the REMstar Plus with C-Flex to automatically turn the airflow OFF. You have the option of turning the alert tone on or off.

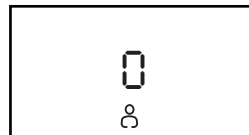

1 = on **0 = off**

To change the setting, press the ramp or humidifier button until the correct setting appears.

Press the right user button to access the next setting.

Setting the Button Lights

- c. The button lights setting will appear. This setting allows you to have the lights behind the buttons turned on or off while the airflow is turned on. (The lights will always be on when the airflow is off.)

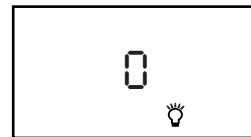

1 = on **0 = off**

To change the setting, press the ramp or humidifier button until the correct setting appears.

Press the right user button to access the next setting.

First Time Setup (cont.)

Setting the C-Flex Level

- d. The C-Flex level setting displays the C-Flex level set by your home care provider. *Note: This setting will only appear if C-Flex was prescribed for you.*



This setting allows you to adjust the level of air pressure relief that you feel when you exhale during therapy.

Your home care provider will have already set a C-Flex level. If this is not comfortable for you, you can increase or decrease the setting. The setting of “1” provides a small amount of pressure relief. To increase the pressure relief, change the setting to “2” or “3.”

To change the setting, press the ramp or humidifier button.

Press the right user button to access the next setting.

Setting the Elevation

- e. The elevation symbol and setting will appear.
- 1 = less than 2,500 ft. (<762 m)
 - 2 = 2,500 to 5,000 ft. (762 m to 1524 m)
 - 3 = 5,001 to 7,500 ft. (1525 m to 2286 m)

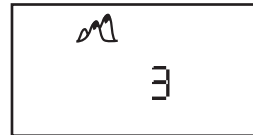

*over 7,500 ft. = The airflow pressure may not be accurate. Contact your home care provider to have your pressure setting adjusted.

To change the elevation setting, press the ramp or humidifier buttons.

Press the right user button to access the next setting.

WARNING!

Using the REMstar Plus with C-Flex at an incorrect elevation setting could result in airflow pressures higher than the prescribed setting. Always verify the elevation setting when traveling or relocating.

First Time Setup (cont.)

Setting the Minimum Ramp Pressure

- f. The ramp starting pressure will appear.
Note: This setting will only appear if ramp was prescribed for you.

The ramp feature will reduce the pressure and then gradually increase (ramp) the pressure to the prescription pressure setting so that you can fall asleep more comfortably.

Your home care provider will have already set a ramp starting pressure. If you feel the ramp starting pressure is set too low or too high, you can change the setting.

(Range: 4 cm H₂O - Prescription Pressure)

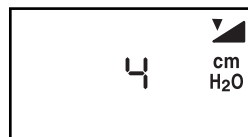

To change the setting, press the ramp or humidifier button. (You can hold the button down to make the setting change faster.)

Exit the Settings

The settings are complete. Press the left user button to access the previous setting, or press the pressure start/stop button to exit the settings menu. Or, if you want to return to step a, press the right user button.

First Time Setup (cont.)

Assembling the Circuit

5. Assemble the circuit. To use the system, you will need the following accessories in order to assemble the recommended circuit.
 - *Respironics Nasal Mask with integrated exhalation port*
(or *Respironics mask with separate exhalation port such as the Whisper Swivel® II*)
 - *Respironics 6 ft. (1.83 m) Flexible Tubing*
 - *Respironics Headgear (for the mask)*

WARNING!

If multiple persons are going to use the REMstar Plus with C-Flex (e.g., rental devices), a low-resistance, main flow bacteria filter should be installed in-line between the REMstar Plus with C-Flex and the circuit tubing. Pressures must be verified by your home care provider when alternate or optional accessories are in place.

- a. Connect the flexible tubing to the air outlet on the front of the REMstar Plus with C-Flex.

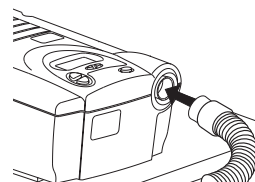

- b. *If you are using a mask with a built-in exhalation port*, connect the mask's connector to the flexible tubing.

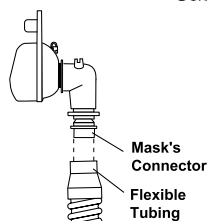

If you are using a mask with a separate exhalation port, connect the flexible tubing to the exhalation port. Position the exhalation port so that the vented air is blowing away from your face. Connect the mask's connector to the exhalation port.

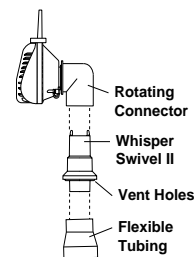

WARNING!

Do not block or otherwise try to seal the air openings (vent holes) on the exhalation port. Explanation of the warning: The REMstar Plus with C-Flex is intended to be used with masks and circuits that have an exhalation port designed to exhaust CO₂ from the circuit. When the REMstar Plus with C-Flex is turned on and functioning properly, new air from the REMstar Plus with C-Flex flushes the exhaled air out through the exhalation port. When the REMstar Plus with C-Flex is turned off, enough fresh air will not be provided through the mask, and exhaled air may be rebreathed. Rebreathing of exhaled air for longer than several minutes can, in some circumstances, lead to suffocation. This warning applies to most CPAP devices.

WARNING!

If you are using a full face mask (i.e., a mask covering both your mouth and your nose), the mask must be equipped with a safety (entrainment) valve.

Accessories

Contact your home care provider for additional information on the accessories available for the REMstar Plus with C-Flex system. When using optional accessories, always follow the instructions enclosed with the accessories.

Adding a Humidifier

The REMstar Heated Humidifier and REMstar Integrated Humidifier are available from your home care provider. The humidifiers may reduce nasal dryness and irritation by adding moisture (and heat if applicable) to the airflow.

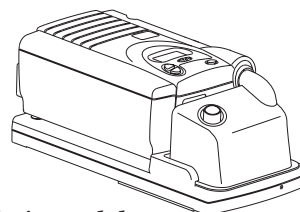

WARNING!

Always place the humidifier at the same level or lower than the REMstar Plus with C-Flex device and the mask so that any excess condensation in the tubing drains back into the water chamber. The humidifier must be level for proper operation.

Adding Oxygen

Oxygen may be added at the mask connection. Please note the warnings listed below when using oxygen with the REMstar Plus with C-Flex.

WARNING!

The oxygen supply must comply with the local regulations for medical oxygen.

WARNING!

A Respironics Pressure Valve (part number 302418) must be placed in-line with the patient circuit.

WARNING!

Turn the REMstar Plus with C-Flex on before turning the oxygen on. Turn the oxygen off before turning the REMstar Plus with C-Flex off.
Explanation of Warning: When the REMstar Plus with C-Flex is turned off, but the oxygen flow is still turned on, oxygen may accumulate within the REMstar Plus with C-Flex enclosure and create a fire risk. Turning the oxygen off before turning the REMstar Plus with C-Flex off will prevent oxygen accumulation in the REMstar Plus with C-Flex and will reduce the risk of fire. This warning applies to most CPAP devices.

WARNING!

Oxygen accelerates fires. Keep the REMstar Plus with C-Flex and the oxygen container away from heat, open flames, any oily substance, or other sources of ignition. DO NOT smoke in the area near the REMstar Plus with C-Flex or the oxygen container.

Using DC Power

You can also use the REMstar Plus with C-Flex in a stationary recreational vehicle, boat, or motor home with a 12 volt DC power source. Do not operate the REMstar Plus with C-Flex while the vehicle is in motion. Contact your home care provider for additional information.

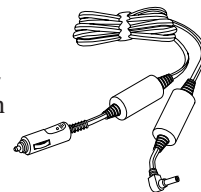

CAUTION!

Use only the Respironics DC power system available from your home care provider. Use of any other system may cause damage to the REMstar Plus with C-Flex or your vehicle.

Routine Use

Connecting the Circuit

1. Connect the circuit.

IMPORTANT!

Before each use, examine the flexible tubing for any damage or debris. If necessary, clean the tubing to remove the debris. Replace any damaged tubing.

- a. Connect the mask to the headgear, following the instructions included with the headgear.
- b. Put on the mask and headgear, and breathe normally through your nose. The airflow should automatically start when you begin breathing through the circuit. If the airflow does not start within four breaths, press the pressure start/stop button on the top of the REMstar Plus with C-Flex. When operating the system with some mask types or some circuit configurations, the airflow may NOT automatically start.

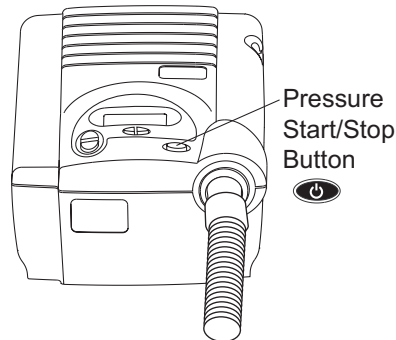

Adjusting the Circuit

2. Adjust the circuit. Lie down on your bed, and adjust the flexible tubing so it is free to move if you turn in your sleep. Adjust the mask and headgear until you have a comfortable fit and there are no airflow leaks into your eyes.

Using the Ramp Button

Pressing the ramp button will reduce the air pressure when you are trying to fall asleep. The air pressure will gradually increase until your prescription pressure is reached. If your physician prescribed ramp for you, pressing the button will reduce the pressure and then gradually increase (ramp) the pressure to the therapeutic pressure setting so that you can fall asleep more comfortably. *Note: The ramp feature is not prescribed for all users.*

3. Press the Ramp button on the top of the REMstar Plus with C-Flex. You can use the Ramp button as often as you wish during the night.

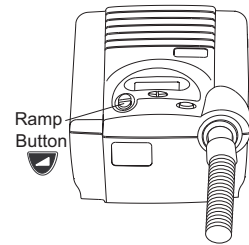

Turning the System OFF

4. Remove the mask and headgear. Press the pressure start/stop button on the top of the REMstar Plus with C-Flex to start the airflow.

Or, if the patient disconnect alert setting has been turned on, the airflow will automatically turn off. When you remove the mask, the airflow will decrease to a low pressure. After approximately 45 seconds the alert tone will sound. Then the airflow will automatically turn off (in less than 2 minutes after you remove the mask).

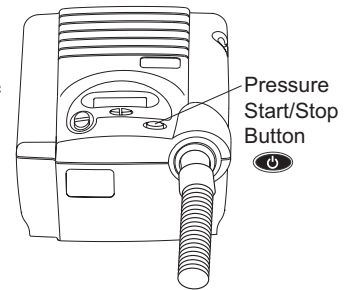

IMPORTANT!



The humidifier button is active only when a REMstar Heated Humidifier is connected or when the REMstar Plus with C-Flex is in the Setup Menu. Refer to the REMstar Heated Humidifier's instructions for additional information.

Helpful Hints

- If the alert tone sounds, press any button on the REMstar Plus with C-Flex to silence the alert tone. Refer to the "Troubleshooting" section of the manual for further instructions.
- Make sure that bedding, curtains, or other items are not blocking the filter or vents of the REMstar Plus with C-Flex. Air must flow freely around the REMstar Plus with C-Flex for the system to work properly.
- If the airflow from the REMstar Plus with C-Flex feels cold, reposition the circuit tubing so that it runs under your bed covers to reduce heat loss while you sleep.

Routine Maintenance

Cleaning the Filter

The gray foam filter should be cleaned at least once every two weeks under normal usage and replaced with a new one every six months. The white ultra-fine filter is disposable and should be replaced after 30 nights of use or sooner if it appears dirty. DO NOT clean the ultra-fine filter.

CAUTION!

Operating the REMstar Plus with C-Flex with a dirty filter may keep the system from working properly and may cause damage to the device.

1. Remove the filter cap by gently pressing on its sides.
2. Change the filter.
 - a. Remove the foam filter by gently pulling around the edges of the filter. Rinse the filter in a steady stream of running water. Squeeze out the water and repeat. Air dry the filter on a rack for 8 to 12 hours or in a clothes dryer for 15 to 20 minutes. If you are using the white ultra-fine filter and it appears dirty, discard the filter and replace it with a new one.
 - b. Place the white ultra-fine filter under the clean foam filter. Insert the filter(s) into the filter area on the back of the REMstar Plus with C-Flex. Replace the filter cap.

CAUTION!

Never install a wet filter into the REMstar Plus with C-Flex. We recommend that you clean the filter in the morning and alternate using the two filters provided with the system to ensure enough drying time for the cleaned filter.

Cleaning the System

Clean the mask and tubing daily.

WARNING!

To avoid electrical shock, unplug the REMstar Plus with C-Flex before cleaning. Do not immerse the REMstar Plus with C-Flex in any fluids.

1. Disconnect the flexible tubing from the REMstar Plus with C-Flex. Gently wash the flexible tubing in a solution of warm water and a mild detergent. Rinse the tubing thoroughly and air dry.
2. Wipe the outside of the REMstar Plus with C-Flex with a cloth slightly dampened with water and a mild detergent. Let the REMstar Plus with C-Flex dry before plugging in the power cord.
3. Inspect the REMstar Plus with C-Flex and all circuit parts for any damage after cleaning. Replace any damaged parts.
4. For details on cleaning your mask and accessories, refer to the cleaning instructions packaged with the accessories.

Reordering/Service/Traveling with the System

Reordering

Contact your home care provider to order accessories or replacement filters.

Service

The REMstar Plus with C-Flex system does not require routine servicing.

When necessary, dispose of the REMstar Plus with C-Flex and accessories in accordance with local regulations.

WARNING!

If you notice any unexplained changes in the performance of the REMstar Plus with C-Flex, if it is making unusual or harsh sounds, if it has been dropped or mishandled, if the enclosure is broken, or if water has entered the enclosure, discontinue use. Contact your home care provider.

WARNING!

If the REMstar Plus with C-Flex malfunctions, contact your home care provider immediately. Never attempt to open the REMstar Plus with C-Flex's enclosure. Repairs and adjustments must be performed by Respironics authorized service personnel only. Unauthorized service could cause injury, invalidate the warranty, or result in costly damage.

Traveling with the System

When you are traveling, the carrying case is for carry-on luggage *only*. The carrying case will not protect the system if it is stored as checked baggage.

Security Stations

For convenience at security stations, there is a note on the bottom of the REMstar Plus with C-Flex stating that it is medical equipment. It may be helpful to bring this manual along with you to help security personnel understand the REMstar Plus with C-Flex.

Checking the Power Cord

If you are traveling to a country with a line voltage different than the one you are currently using, a different power cord or an international plug adapter may be required to make your power cord compatible with the power outlets of the country to which you are traveling. Contact your home care provider for additional information.

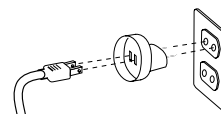

Troubleshooting

The table below lists common problems you may have with the REMstar Plus with C-Flex system and possible solutions to those problems. If none of the corrective actions solve the problem, contact your home care provider.

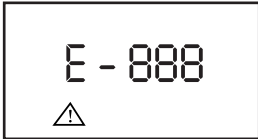
Problem	Solution(s)
<p>The “Attention” symbol is flashing on the display screen and the alert tone is sounding.</p> 	<p>Press any button on the REMstar Plus with C-Flex to silence the alert tone and stop the flashing. The system has detected a large leak in the circuit or you have taken the mask off without turning the airflow off. Check the circuit connections for leaks.</p>
<p>The “Attention” symbol and an error code (E-???) are flashing on the display screen, the alert tone is sounding, and the buttons are flashing.</p> 	<p>Press any button on the REMstar Plus with C-Flex to silence the alert tone. Discontinue use. Disconnect the power cord from the AC wall outlet. Contact your home care provider or Respironics for directions on having the REMstar Plus with C-Flex serviced. Please have the device’s serial number and the error code ready when you call.</p>
<p>The pressure being delivered feels different.</p>	<p>Check the elevation setting to be sure it is set to your elevation. Change the elevation setting if necessary. If the elevation setting is correct, contact your home care provider or Respironics for directions on having the REMstar Plus with C-Flex serviced. Please have the device’s serial number ready when you call.</p>
<p>The airflow from the REMstar Plus with C-Flex seems warm.</p>	<p>Replace or clean the filter. Make sure the REMstar Plus with C-Flex is away from bedding or curtains that could block the flow of air around the REMstar Plus with C-Flex. Make sure the REMstar Plus with C-Flex is away from heating equipment (e.g., forced air vents, radiators).</p>
<p>The noise level of the REMstar Plus with C-Flex has changed to include unusual or harsh sounds during operation.</p>	<p>Contact your home care provider or Respironics for directions on having the REMstar Plus with C-Flex serviced. Please have the device’s serial number ready when you call.</p>

Troubleshooting (cont.)

Problem (cont.)

Solution(s) (cont.)

The REMstar Plus with C-Flex will not turn on.

Make sure that the REMstar Plus with C-Flex is plugged into a working outlet. If you are using DC power accessories with a battery, the battery may need to be recharged or replaced or the DC Cord's fuse may need to be replaced. Contact your home care provider or Respironics for directions on having the REMstar Plus with C-Flex serviced. Please have the device's serial number ready when you call.

Pressing the ramp button does not reduce the air pressure.

Contact your home care provider. Ramp may not have been prescribed for you.

The REMstar Plus with C-Flex has been dropped into water or fluids have gotten into the enclosure.

Discontinue use. Disconnect the power cord from the AC wall outlet. Contact your home care provider or Respironics for directions on having the REMstar Plus with C-Flex serviced. Please have the device's serial number ready when you call.

EMC Requirements

Guidance and manufacturer's declaration - electromagnetic emissions		
The REMstar Plus with C-Flex is intended for use in the electromagnetic environment specified below. The user of the REMstar Plus with C-Flex should ensure that it is used in such an environment.		
Emissions Test	Compliance	Electromagnetic environment - guidance
RF emissions CISPR 11	Group 1, Class B	The REMstar Plus with C-Flex uses RF energy only for its internal function. Therefore its RF emissions are very low and are not likely to cause any interference in nearby electronic equipment. The REMstar Plus with C-Flex is suitable for use in all establishments including domestic establishments and those directly connected to the public low-voltage power supply network that supplies buildings used for domestic purposes.
RF emissions CISPR 11	Group 1, Class B	
Harmonic emissions IEC 61000-3-2	Class A	
Voltage fluctuations/flicker emissions IEC 61000-3-3	Class D	

Guidance and manufacturer's declaration - electromagnetic immunity			
The REMstar Plus with C-Flex is intended for use in the electromagnetic environment specified below. The user of the REMstar Plus with C-Flex should make sure that it is used in such an environment.			
Immunity test	IEC 60601 test level	Compliance level	Electromagnetic environment - guidance
Electrostatic discharge (ESD) IEC 61000-4-2	±6 kV contact ±8 kV air	±6 kV contact ±8 kV air	Floor should be wood, concrete or ceramic tile. If floors are covered with synthetic material, the relative humidity should be at least 30%.
Electrical fast transient/burst IEC 61000-4-4	±2 kV for power supply lines ±1 kV for input/output lines	±2 kV for power supply lines ±1 kV for input/output lines	
Surge IEC 61000-4-5	±1 kV differential mode ±2 kV common mode	±1 kV differential mode ±2 kV common mode	Mains power quality should be that of a typical home or hospital.

EMC Requirements (cont.)

Immunity test (cont.)	IEC 60601 test level (cont.)	Compliance level (cont.)	Electromagnetic environment - guidance (cont.)
Voltage dips, short interruptions and voltage variations on power supply input lines IEC 61000-4-11	<5 % U_T (>95% dip in U_T) for 0.5 cycle 40% U_T (60% dip in U_T) for 5 cycles 70% U_T (30% dip in U_T) for 25 cycles <5% U_T (>95% dip in U_T) for 5 s	<5% U_T (>95 % dip in U_T) for 0.5 cycle 40% U_T (60% dip in U_T) for 5 cycles 70% U_T (30% dip in U_T) for 25 cycles <5% U_T (>95% dip in U_T) for 5 s	Mains power quality should be that of a typical commercial or hospital environment. If the user of the REMstar Plus with C-Flex requires continued operation during power mains interruptions, it is recommended that the REMstar Plus with C-Flex be powered from an uninterruptible power supply or from a battery.
Power frequency (50/60 Hz) magnetic field IEC 61000-4-8	3 A/m	0.3 A/m	If the pressure deviates more than is indicated in the device specification, it may be necessary to position the REMstar Plus with C-Flex further from sources of power frequency magnetic fields. The power frequency magnetic field should be measured in the intended installation location to ensure that it is sufficiently low.
NOTE: U_T is the AC mains voltage prior to application of the test level.			

EMC Requirements (cont.)

Guidance and manufacturer's declaration - electromagnetic immunity			
<p>The REMstar Plus with C-Flex is intended for use in the electromagnetic environment specified below. The user of the REMstar Plus with C-Flex should make sure it is used in such an environment.</p>			
Immunity test	IEC 60601 test level	Compliance level	Electromagnetic environment - guidance
<p>Conducted RF IEC 61000-4-6</p> <p>Radiated RF IEC 61000-4-3</p>	<p>3 Vrms 150 kHz to 80 MHz</p> <p>3 V/m 80 MHz to 2.5 GHz</p>	<p>3 Vrms</p> <p>3 V/m</p>	<p>Portable and mobile RF communications equipment should be used no closer to any part of the REMstar Plus with C-Flex, including cables, than the recommended separation distance calculated from the equation applicable to the frequency of the transmitter.</p> <p>Recommended separation distance $d = 1.2\sqrt{P}$</p> <p>$d = 1.2\sqrt{P}$ 80 MHz to 800 MHz $d = 2.3\sqrt{P}$ 800 MHz to 2.5 GHz</p> <p>where P is the maximum output power rating of the transmitter in watts (W) according to the transmitter manufacturer and d is the recommended separation distance in meters (m).</p> <p>Field strengths from fixed RF transmitters, as determined by an electromagnetic site survey,^a should be less than the compliance level in each frequency range.^b</p> <p>Interference may occur in the vicinity of equipment marked with the following symbol:</p> <div style="text-align: right;">  </div>
<p>NOTE 1 At 80 MHz and 800 MHz, the higher frequency range applies.</p>			
<p>NOTE 2 These guidelines may not apply in all situations. Electromagnetic propagation is affected by absorption and reflection from structures, objects and people.</p>			
<p>^a Field strengths from fixed transmitters, such as base stations for radio (cellular/cordless) telephones and land mobile radios, amateur radio, AM and FM radio broadcast and TV broadcast cannot be predicted theoretically with accuracy. To assess the electromagnetic environment due to fixed RF transmitters, an electromagnetic site survey should be considered. If the measured field strength in the location in which the REMstar Plus with C-Flex is used exceeds the applicable RF compliance level above, the REMstar Plus with C-Flex should be observed to verify normal operation. If abnormal performance is observed, additional measures may be necessary, such as re-orienting or relocating the REMstar Plus with C-Flex.</p>			
<p>^b Over the frequency range 150 kHz to 80 MHz, the field strengths should be less than 3 V/m.</p>			

Limited Warranty

Respironics, Inc.[®] warrants that the REMstar[®] Plus with C-Flex[™] CPAP device shall be free from defects of workmanship and materials and will perform in accordance with the product specifications for a period of two (2) years from the date of sale by Respironics, Inc. to the dealer. If the product fails to perform in accordance with the product specifications, Respironics, Inc. will repair or replace, at its option, the defective material or part. Respironics, Inc. will pay customary freight charges from Respironics, Inc. to the dealer location only. This warranty does not cover damage caused by accident, misuse, abuse, alteration and other defects not related to material or workmanship.

RESPIRONICS, INC. DISCLAIMS ALL LIABILITY FOR ECONOMIC LOSS, LOSS OF PROFITS, OVERHEAD OR CONSEQUENTIAL DAMAGES WHICH MAY BE CLAIMED TO ARISE FROM ANY SALE OR USE OF THIS PRODUCT. SOME STATES DO NOT ALLOW THE EXCLUSION OR LIMITATION OF INCIDENTAL OR CONSEQUENTIAL DAMAGES, SO THE ABOVE LIMITATION OR EXCLUSION MAY NOT APPLY TO YOU.

THIS WARRANTY IS GIVEN IN LIEU OF ALL OTHER EXPRESS WARRANTIES. IN ADDITION, ANY IMPLIED WARRANTIES, INCLUDING ANY WARRANTY OF MERCHANTABILITY OR FITNESS FOR THE PARTICULAR PURPOSE ARE LIMITED TO TWO YEARS. SOME STATES DO NOT ALLOW LIMITATIONS ON HOW LONG AN IMPLIED WARRANTY LASTS, SO THE ABOVE LIMITATION MAY NOT APPLY TO YOU. THIS WARRANTY GIVES YOU SPECIFIC LEGAL RIGHTS, AND YOU MAY ALSO HAVE OTHER RIGHTS WHICH VARY FROM STATE TO STATE.

To exercise your rights under this warranty, contact your local, authorized Respironics, Inc. dealer or Respironics, Inc. at 1001 Murry Ridge Lane, Murrysville, Pennsylvania 15668, USA, 1-800-345-6443 (USA and Canada only) or 1-724-387-4000.

IMPORTANT!

Fill in the information below when you receive the REMstar Plus with C-Flex CPAP system.

Serial No.: _____

(Located on the bottom of the device)

System Prescribed for: _____

Date of Purchase or Rental: _____

Pressure Setting: _____ cm H₂O

Mask Type: _____

Mask Size: _____

If you have any questions concerning the system, contact:

• Home Care Company: _____

Telephone Number: _____

• Health Care Professional: _____

Telephone Number: _____

• Respironics, Inc.

1001 Murry Ridge Lane

Murrysville, Pennsylvania

15668-8550 USA

Customer Service

Telephone Number: 1-800-345-6443 (USA or Canada) or 1-724-387-4000

**[P E O P L E
P R O D U C T S
P R O G R A M S]**



RESPIRONICS®
1001 Murry Ridge Lane
Murrysville, Pennsylvania
15668-8550 USA

RESPIRONICS®
Deutschland
Gewerbestrasse 17
82211 Herrsching Germany

