



2016 Owner's Manual for Maintenance and Safety

**Read this manual carefully.
It contains important safety information.**

⚠ WARNING

Read, understand, and follow all of the instructions and safety precautions in this manual and on all product labels.

Failure to follow the safety precautions could result in serious injury or death.



The following are trademarks of POLARIS Industries Inc.:

POLARIS®

GEM®

Global Electric Motorcars®

e6®

Road America® is a trademark of Brickell Financial Services Motor Club, Inc.

Global Electric Motorcars® is a division of POLARIS.

Copyright 2015 POLARIS Industries Inc. All information contained within this publication is based on the latest product information at the time of publication. Due to constant improvements in the design and quality of production components, some minor discrepancies may result between the actual vehicle and the information presented in this publication. Depictions and/or procedures in this publication are intended for reference use only. No liability can be accepted for omissions or inaccuracies. Any reprinting or reuse of the depictions and/or procedures contained within, whether whole or in part, is expressly prohibited.

Printed in U.S.A.

2016 GEM Owner's Manual

P/N 9926577

TABLE OF CONTENTS

- Introduction 6**
- Safety 12**
- Features and Controls 32**
- Operation 88**
- Maintenance 98**
- Specifications 134**
- Warranty 138**
- Maintenance Log 150**
- Index 153**

WELCOME

Thank you for purchasing a GEM by POLARIS, and welcome to our world-wide POLARIS family of recreational and utility vehicle owners. We believe POLARIS sets a standard of excellence for all recreational and utility vehicles manufactured in the world today. With our many years of experience in design and manufacturing, we proudly bring you only the finest of vehicles.

- Snowmobiles
- All-terrain vehicles (ATVs)
- Low emission vehicles (LEVs)
- *RANGER*® utility vehicles
- BRUTUS® work vehicles
- SLINGSHOT® three wheel motorcycles
- *RZR*® sport vehicles
- GEM® electric vehicles
- VICTORY® motorcycles
- INDIAN® motorcycles
- POLARIS POWER® generators
- POLARIS DEFENSE® combat vehicles

WELCOME

For safe and enjoyable operation of your vehicle, be sure to follow the instructions and recommendations in this owner's manual. Your manual contains instructions for minor maintenance, but information about major repairs is outlined in the GEM Service Manual and should be performed only by an authorized GEM dealer technician.

If questions arise after reading the manual, please contact GEM customer service. Be prepared to provide your Vehicle Identification Number (VIN) and date of purchase.

Your authorized GEM dealer knows your vehicle best and is interested in your total satisfaction. Your GEM dealership can provide for all of your service needs during, and after, the warranty period.

GEM Customer Service

Phone: 855-RIDEGEM (855-743-3436)

Web: www.gemcar.com

INTRODUCTION

This vehicle complies with the U.S. Department of Transportation National Highway Traffic Safety Administration (NHTSA) low-speed vehicle regulations and can be operated on many streets posted with low speed limits. Please familiarize yourself with all laws and regulations concerning the operation of the vehicle in your area.

This manual applies to the following GEM vehicles:

- GEM e2 (two-passenger)
- GEM e4 (four-passenger)
- GEM eL XD (two-passenger extra duty long-bed)
- GEM e6® (six-passenger)

Safety Signal Words and Symbols

The following signal words and symbols appear throughout this manual and on your vehicle. Your safety is involved when these words and symbols are used. Become familiar with their meanings before reading the manual.



The safety alert symbol indicates a potential personal injury hazard.

WARNING

A **WARNING** indicates a hazardous situation which, if not avoided, may result in death or serious injury.

CAUTION

A **CAUTION** indicates a hazardous situation which, if not avoided, may result in minor or moderate injury.

NOTICE

A **NOTICE** indicates a situation that may result in property damage.



The Prohibition Safety Sign indicates an action **NOT** to take in order to avoid a hazard.



The Mandatory Action Sign indicates an action that **NEEDS** to be taken to avoid a hazard.

INTRODUCTION

⚠ WARNING

Failure to follow the warnings contained in this manual can result in severe injury or death.

Special precautions must be followed when owning and operating a battery-powered vehicle. This vehicle is not a toy and can be hazardous to operate. This vehicle handles differently than other vehicles. A collision or rollover can occur quickly, even during routine maneuvers, if you fail to take proper precautions.

- Read this owner's manual. Understand all safety warnings, precautions and operating procedures before operating the vehicle. Keep this manual with the vehicle.
- This vehicle is an **ADULT VEHICLE ONLY**. **NEVER** operate this vehicle if you are under age 16 and **NEVER** operate without a valid driver's license.
- Never permit a guest to operate this vehicle unless the guest has read this manual and all product labels.
- Operate this vehicle only on public or private roads where speed limits are appropriate for low speed vehicles. Be familiar with motor vehicle laws in your area of operation. Do not operate this vehicle in situations where it could become an obstacle or an annoyance for faster-moving traffic.

INTRODUCTION

Manufacturer's Label (Vehicle Information Label)

Record your vehicle's identification numbers and key numbers in the spaces provided on page 11.

The Vehicle Identification Number (VIN) is stamped on a tag affixed to the left dash at the base of the windshield. The VIN is also printed on the manufacturer's label, which is located on the left rear section of the interior roof panel. See page 10.

The VIN indicates the model year, model type and serial number of your vehicle. The manufacturer's label also contains the Gross Vehicle Weight Rating (GVWR) and Gross Axle Weight Rating (GAWR) information for your vehicle. *Never exceed the GVWR or the GAWR.* See page 22.

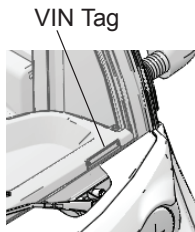

Replacement Keys

To order an extra or replacement key for the ignition or for accessory locks, please contact GEM customer service. See page 5. Be prepared to provide your key number and VIN.

INTRODUCTION

Manufacturer's Label (Vehicle Information Label)

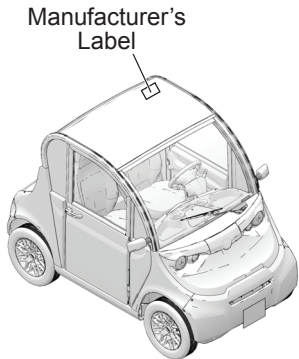

Tire / Wheel Information
GAWR Information

Date of
Manufacture

MFG BY: POLARIS INDUSTRIES INC.
2100 HIGHWAY 155
MEDINA, WA 98340 USA

GEM

VIN: 52CGZAGA00001603 DATE MFD: 10/04/2012

GVWR/PWBV: 906 KG (1777 LB) TYPE: LSV/VBV

GAWR/PWB	TIRE	RIMS	COLD INFLATION PRESSURE
FRONT 582 KG (1306 LB)	185/70R12	T12X4J	222 KPA (32 PSI) SINGLE
REAR 597 KG (1317 LB)	185/70R12	T12X4J	222 KPA (32 PSI) SINGLE

THIS VEHICLE CONFORMS TO ALL APPLICABLE FEDERAL MOTOR VEHICLE SAFETY STANDARDS IN EFFECT ON THE DATE OF MANUFACTURE SHOWN ABOVE
THIS VEHICLE CONFORMS TO ALL APPLICABLE STANDARDS PRESCRIBED UNDER THE CANADIAN MOTOR VEHICLE SAFETY REGULATIONS IN EFFECT ON THE DATE OF MANUFACTURE / CE VEHICULE EST CONFORME A TOUTES LES NORMES QUI S'Y APPLIQUENT EN VERTU DU REGLEMENT SUR LA SECURITE DES VEHICULES AUTOMOBILES DU CANADA EN VIGUEUR A LA DATE DE SA FABRICATION



USA Label

GEM

POLARIS INDUSTRIES INC.

e4*2002/24*0000
5ASAAAA000A000000

DATE OF MFR MM/DD/YYYY GVWR 000/ KG (0000 LB)

GAWR	TIRES	RIMS	COLD
FRONT 000 KG (0000 LB)	000/00R0	000/00R0	000 KPA (00 PSI)
REAR 000 KG (0000 LB)	000/00R0	000/00R0	000 KPA (00 PSI)

VIN: 5ASAAAA000A000000 TYPE: LSV SINGLE

Patents: U.S. 8,000,000

EU Label

GVWR
Information

VIN

INTRODUCTION

Manufacturer's Label (Vehicle Information Label)

Vehicle Identification Number (VIN):

--	--	--	--	--	--	--	--	--	--	--	--	--	--	--	--	--	--

Vehicle Model Number: _____

Motor Serial Number (on case of motor): _____

Ignition Key Number (stamped on key): _____

Accessory Lock Key # (stamped on key): _____

Accessory TrunkBack Lock Key # (if equipped): _____

Date Purchased: _____

SAFETY

Safety Labels and Locations

Warning labels have been placed on the vehicle for your protection. Read and follow the instructions of the labels on the vehicle carefully. If any of the labels depicted in this manual differ from the labels on your vehicle, always read and follow the instructions of the labels *on the vehicle*.

If any label becomes illegible or comes off, contact your authorized GEM dealer to purchase a replacement. Replacement *safety* labels are provided at no charge. The part number is printed on the label.



Safety Labels and Locations

General Warning (7178180)

WARNING

- Read your owner's manual before operating this vehicle.
- Do not operate this vehicle under the influence of alcohol, drugs or medication.
- This vehicle is not intended to be driven at speeds exceeding 25 MPH (40 km/h).
- Although most states prohibit this vehicle from operating on streets having posted speed limits of more than 35 MPH (56 km/h), state and local rules may vary. Check with your local law enforcement (city and state officials) for variations in your area.
- Never exceed the passenger and cargo limits of this vehicle.
- Do not start or operate vehicle until all occupants are seated with seat belts fastened.
- Avoid sharp turns on inclines and at high speeds (may cause rollover).
- Reduce speed on wet and slippery surfaces and in turns.
- Do not leave children unattended in vehicle.
- Set handbrake before leaving the vehicle.
- Remove key when leaving vehicle unattended.
- Stop vehicle before reversing direction.
- Be aware of small children and objects behind you before reversing direction.

ALWAYS DRIVE SAFELY. FAILURE TO FOLLOW THESE WARNINGS COULD RESULT IN SERIOUS OR FATAL INJURY.

SAFETY

Safety Labels and Locations

Seat Belt Warning (7180898)

One seat belt warning is located on the headliner above the front passenger seat. Second and third row seat belt warning labels are located on the seat belt drop-down bars for the row ahead.

WARNING

TO AVOID PERSONAL INJURY OR DEATH: Always fasten your seat belt.

Solar Panel Do Not Stack Warning (7181565)

This label is located at the rear center of the solar panel (if equipped).

WARNING

DO NOT STACK.

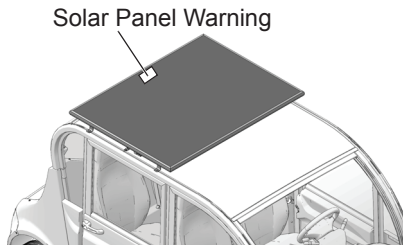

Safety Labels and Locations

Passenger/Rear Cargo Warning (7183756)

This label is centrally located under the center high mount stop lamp (if equipped). This label is also located on the S-Bed and TrunkBack.

WARNING

Never carry passengers on rear platform. Passengers can be thrown off. This can cause serious injury or death.

WARNING

STANDARD CARGO LIMIT 15 kg / 33 lbs.

S-BED/TRUNK-BACK CARGO LIMIT 150 kg / 330 lbs.

Distribute weight evenly. Ensure loads are properly secured. Total weight of passengers, accessories and cargo must not exceed gross vehicle weight rating in owner's manual.

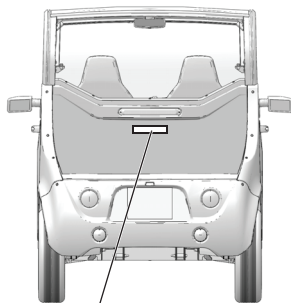

Passenger/Cargo
Warning

SAFETY

Safety Labels and Locations

Cargo Limit Warning (7184570)

The eL XD cargo limit warning label is located at the rear of the cab. See page 96 for towing procedures.

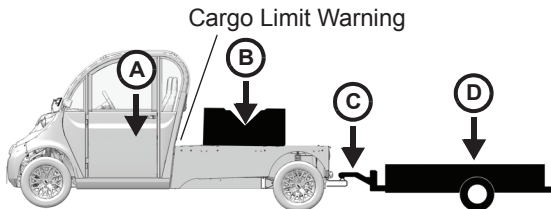

WARNING

Capacities	GEM eL XD
A: Occupant Capacity	300 lbs. (136 kg)
B: Cargo Capacity (includes cargo, bed load and optional equipment)	1150 lbs. (522 kg)**
C: Maximum Trailer Tongue Weight	150 lbs. (68 kg)
D: Maximum Gross Trailer Weight	1100 lbs. (499 kg)
A + B = Vehicle Rated Capacity	1450 lbs. (658 kg)
A + B + D = Must not exceed stated Vehicle Combination Rated Capacity	1450 lbs. (658 kg)
Vehicle Dry Weight	1585 lbs. (719 kg)
A + B + Vehicle Dry Weight = Maximum Gross Vehicle Weight	3000 lbs. (1361 kg)
A + B + D + Vehicle Dry Weight = Must not exceed stated Maximum Gross Vehicle Combination Weight	3000 lbs. (1361 kg)
**Cargo capacity is directly affected by the vehicle's features, options and accessories and will be unique to each specific configuration.	

Operator Safety

⚠ WARNING

Serious injury or death can result if you do not follow these instructions and procedures, which are outlined in further detail within your owner's manual.

- Read this manual and all labels carefully. Follow the operating procedures described.
- Never allow anyone under age 16 to operate this vehicle and never allow anyone without a valid driver's license to operate this vehicle.
- Never permit a guest to operate this vehicle unless the guest has read this manual and all product labels.
- Always make sure the seat belts are secured for operator and all passengers before operating.
- Never exceed the maximum occupant capacity of your vehicle:

GEM e2	2 occupants
GEM e4	4 occupants
GEM eL XD	2 occupants
GEM e6®	6 occupants

SAFETY

Operator Safety

- Never exceed the gross vehicle weight rating (GVWR) of your vehicle.
- The cab frame is not designed or intended to provide rollover protection. Avoid situations that could result in a rollover.
- Always be sure there are no obstacles or people behind your vehicle when operating in reverse. When it's safe to proceed in reverse, move slowly. Avoid turning at sharp angles in reverse.
- Always use the proper size and type of tires and always maintain proper tire pressure as specified in this manual and on safety labels.
- Never modify this vehicle through improper installation or use of accessories.

Operator Safety

- Always set the park brake and remove the key when leaving the vehicle unattended.
- The voltage in the battery pack is sufficient to cause death by electrocution. With the exception of battery inspections and refilling the water in flooded type batteries, never attempt to perform service on the electric drive system, including the battery pack, unless you are properly trained to work on electrical systems. Your authorized GEM dealer can provide battery-related service.

SAFETY

Operator Safety

- Do not carry a passenger until you have at least two hours of driving experience with this vehicle.
- Always keep arms and legs inside the cab frame while the vehicle is in motion.
- Always keep both hands on the steering wheel and both feet on the floorboards of the vehicle during operation.
- Never consume alcohol or drugs before or while operating this vehicle.
- Never operate at excessive speeds. Always travel at a speed proper for the traffic, visibility and operating conditions, and your experience.
- Never attempt jumps, doughnuts or other stunts.
- Always inspect your vehicle each time you use it to make sure it's in safe operating condition. Always follow the inspection and maintenance procedures and schedules described in this manual.

Operator Safety

- Never operate on excessively rough, slippery or loose terrain.
- Always follow proper procedures for turning. Practice turning at slow speeds before attempting to turn at faster speeds. Never turn at excessive speeds.
- Always have this vehicle inspected by an authorized service dealer if it has been involved in an accident.
- Always be alert for obstacles when operating this vehicle. Never attempt to operate over obstacles.
- Always be careful of skidding or sliding. On slippery surfaces such as ice, travel slowly and exercise caution to reduce the chance of skidding or sliding out of control.
- Never operate this vehicle on steep hills.

SAFETY

Operator Safety

Gross Vehicle Weight Rating (GVWR)

WARNING! Exceeding the gross vehicle weight rating of your vehicle can reduce stability and handling and could cause loss of control. NEVER exceed the GVWR of your vehicle.

The maximum *payload capacity* of your vehicle is the maximum weight you may add to your vehicle *without exceeding the GVWR*. This capacity is determined by calculating the difference between your vehicle's GVWR and wet weight.

Refer to the specification section of this manual or the Manufacturer's Label on the vehicle for model-specific information.

Operator Safety

Gross Vehicle Weight Rating (GVWR)

When determining the weight you will be adding to your vehicle, and to ensure you do not exceed the maximum payload capacity, include the following:

- operator body weight
- passenger body weight
- weight of all occupants' apparel and items in or on apparel
- weight of any options or accessories *and their contents*
- weight of any additional cargo on the vehicle

SAFETY

Operator Safety

Equipment Modifications

Never install any equipment or make vehicle modifications to increase the speed or power of the vehicle. Any modifications to the original equipment of the vehicle create a substantial safety hazard and increase the risk of bodily injury. The warranty on your vehicle is terminated if any equipment has been added to the vehicle, or if any modifications have been made to the vehicle, that increase its speed or power.

The addition of certain accessories, including (but not limited to) mowers, blades, tires, sprayers, or large racks, may change the handling characteristics of the vehicle. Use only GEM-approved accessories, and familiarize yourself with their function and effect on the vehicle.

Operator Safety

⚠ WARNING

Failure to operate this vehicle properly can result in a collision, loss of control, accident or overturn, which may result in serious injury or death. Heed all safety warnings outlined in this section of the owner's manual. See the OPERATION section of the owner's manual for proper operating procedures.

Age Restrictions

This vehicle is an **ADULT VEHICLE ONLY**. NEVER operate this vehicle if you are under age 16 and NEVER operate without a valid driver's license.



Seat Belts

Riding in this vehicle without wearing the seat belt increases the risk of serious injury in the event of an accident or sudden stop. Occupants *must* wear seat belts at all times. Always make sure the seat belts are secured for operator and all passengers before operating. See page 76.

SAFETY

Operator Safety

Operating Without Instruction

Operating this vehicle without proper instruction increases the risk of an accident. The operator must understand how to operate the vehicle properly in different situations and on different types of terrain. All operators must read and understand the Owner's Manual and all warning and instruction labels before operating the vehicle.

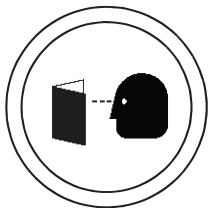

Ventilation When Charging Batteries

Failure to provide adequate ventilation while charging batteries can result in an explosion. Volatile hydrogen gas is emitted during charging and may accumulate in pockets at the ceiling.

- Always ensure a minimum of 5 air changes per hour in the charging area.
- Always remove any storage covers from the vehicle and open any cab doors (if equipped) before charging.

SAFETY

Operator Safety

Failure to Inspect Before Operating

Failure to inspect and verify that the vehicle is in safe operating condition before operating increases the risk of an accident. Always inspect the vehicle before each use to make sure it's in safe operating condition. Always follow all inspection and maintenance procedures and schedules described in the owner's manual.

Using Alcohol or Drugs

Operating the vehicle after consuming alcohol or drugs could adversely affect operator judgment, reaction time, balance and perception. Never drink alcohol or use drugs or medications before or while operating this vehicle.



SAFETY

Operator Safety

Operating a Damaged Vehicle

Operating a damaged vehicle can result in an accident. After any overturn or accident, have qualified service dealer inspect the entire machine for possible damage, including (but not limited to) brakes, accelerator, steering system and electrical system.

Operating at Excessive Speeds

Operating this vehicle at excessive speeds increases the operator's risk of losing control. Always operate at a speed that's appropriate for the traffic, the visibility and operating conditions, your skills and your passengers' skills.

Exhibition Driving

Exhibition driving increases the risk of an accident or overturn. Never attempt wheelies, jumps, doughnuts or other stunts. Avoid exhibition driving.

Operator Safety

Turning Improperly

Turning improperly could cause loss of traction, loss of control, accident or overturn. Always follow proper procedures for turning. Never turn abruptly or at sharp angles. Never turn at high speeds. Practice turning at slow speeds before attempting to turn at faster speeds.

Vehicle Rollover

Vehicle rollover could cause serious injury or death. The cab frame is not designed or intended to provide rollover protection. Always make sure the seat belts are secured for operator and all passengers before operating. Avoid situations that could result in a rollover. Avoid sharp turns and abrupt steering maneuvers.

Carrying Cargo

Carrying loads on the roof could damage the roof and affect vehicle handling, which could result in an accident or overturn. Never carry loads on the roof of the vehicle.

Never exceed the stated load capacity for this vehicle. Cargo should be properly distributed and securely attached.

Reduce speed and follow the instructions on cargo warning labels for hauling cargo. Allow a greater distance for braking.

SAFETY

Operator Safety

Improper Tire Maintenance

Operating this vehicle with improper tires or with improper or uneven tire pressure could cause loss of control or accident. Always use the size and type of tires specified for your vehicle. Always maintain proper tire pressure as described in the owner's manual and on safety labels.

Unauthorized Use of the Vehicle

Leaving the keys in the vehicle can lead to unauthorized use of the vehicle, which could result in an accident or overturn. Always remove the key when the vehicle is not in use.

Hot Drive Systems

The motor and controller are very hot during and after use of the vehicle. Hot components can cause burns and fire. Do not touch hot drive system components. Always keep combustible materials away from the drive system.

Operator Safety

Precautions During Maintenance

WARNING! The voltage in the battery pack is sufficient to cause death by electrocution. With the exception of battery inspections and refilling the water in flooded type batteries, never attempt to perform service on the electric drive system, including the battery pack, unless you are properly trained to work on electrical systems. Your authorized GEM dealer can provide battery-related service.

WARNING! Do not work in or near the battery compartment or on any other electrical component of the vehicle while charging the batteries.

WARNING! Before servicing the vehicle's electrical system, always disconnect the main power connector first, then disconnect any electrical accessory connections, then disconnect the negative cable from the 12-volt battery (if equipped), then disconnect the

negative terminal from the main battery pack. See page 53.

Always follow all safety instructions in the maintenance portion of this owner's manual, as well as the following:

- Make sure the vehicle is properly immobilized before beginning any maintenance.
- Always block the chassis securely before working under the vehicle.
- Turn the key off and remove it from the vehicle.
- Insulate any tools used within the battery area to prevent sparks or battery explosion caused by shorting the battery terminals or wiring. Remove the batteries, or cover the exposed terminals with an insulating material.

**FOR MORE INFORMATION ABOUT SAFETY
PLEASE CONTACT GEM CUSTOMER SERVICE.**

See page 5.

FEATURES AND CONTROLS

Console

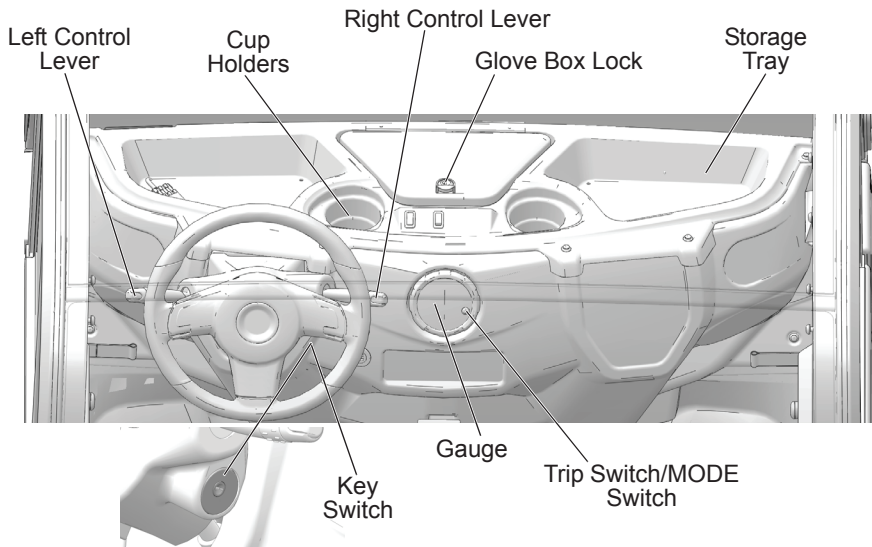

FEATURES AND CONTROLS

Console

Electrical Components

Electrical wiring, circuit boards and components are located under and behind the upper and lower console.

NOTICE: Liquids can damage electrical components and the circuit board. Handle liquids with care. Do not spray water directly into the upper or lower console.

Steering Wheel Adjuster

If equipped, the steering wheel can be tilted upward or downward for rider preference.

Pull and hold the adjustment lever upward while moving the steering wheel upward or downward. Release the lever when the steering wheel is at the desired position.

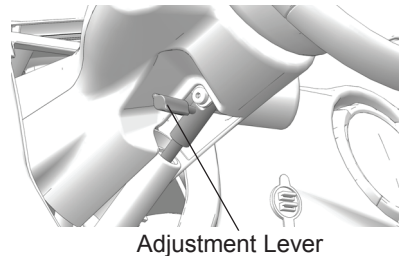
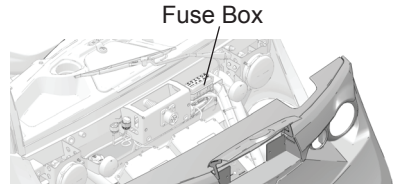

FEATURES AND CONTROLS

Console

Key Switch

When the key is turned to the ON position (clockwise), the display will light up and all electrical accessories can be used.

Leaving the key in the ON position will discharge the batteries. Always turn the key to the OFF position when not operating. Remove the key from the ignition to prevent unauthorized use.

When the key is turned to the OFF position, the vehicle will not accelerate.

NOTE: The steering column automatically locks when the ignition key is removed.

The key can be removed from the switch when it is in the OFF position.

WARNING! Never turn the key to the OFF position while the vehicle is in motion. This could lead to loss of speed control and loss of vehicle control, which could result in serious injury or death.



FEATURES AND CONTROLS

Console

Zero Speed Detection Feature

To prevent the vehicle from rolling away while stopped, the electric motor will resist vehicle motion if the accelerator pedal is released while the key is on, and the vehicle starts moving.

Glove Box

The glove box is equipped with a lock to protect items from theft or damage. Use the accessory lock key to lock and unlock the glove box door. Turn the key 1/4 turn counter-clockwise to unlock the door.

FEATURES AND CONTROLS

Console

Left Control Lever

The left control lever contains the turn signal switch, the horn switch, the headlight on/off switch and the high/low headlight beam switch.

Turn Signal Switch

Check turn signal lamps before each ride. When driving, activate a turn signal before turning to alert others of your intentions.

Tip: The key must be in the ON position to activate the turn signals.

Move the lever downward to signal a left turn. Move the lever upward to signal a right turn. The corresponding turn signal lamps on the front and rear of the vehicle will flash. The corresponding turn indicator in the LCD display will also flash.

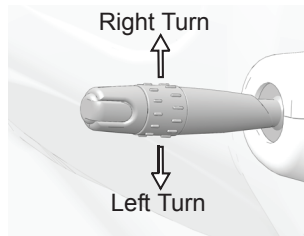

FEATURES AND CONTROLS

Console

Left Control Lever

Horn Switch

Press the tip of the left control lever inward to sound the horn.

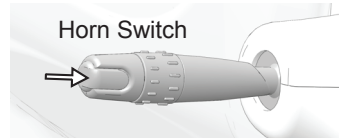

Headlight On/Off Switch

Rotate the knurled barrel forward to turn the headlight on.

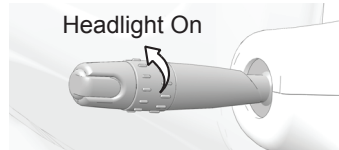

Headlight High Beam/Low Beam Switch

Pull the control lever toward the driver's seat to toggle the headlights between high beam and low beam.

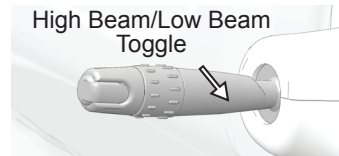

FEATURES AND CONTROLS

Console

Right Control Lever

The right control lever contains the hazard signal switch, the direction switch and the windshield wiper and washer switches (if equipped).

Hazard Signal Switch

Press the tip of the lever inward to cause all turn signal lamps to flash simultaneously. Use this feature to alert others of an emergency or other situation requiring caution, especially if your vehicle becomes disabled on or near a road. Press the switch again to cancel the hazard signals.

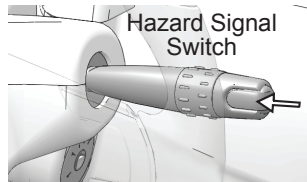

Direction Selection Switch

Use the direction switch to select forward, neutral or reverse mode of operation. Refer to the operation information on the following page.

CAUTION! Changing the direction switch position while driving could result in an automatic increase or decrease in speed without a change to accelerator pedal pressure.

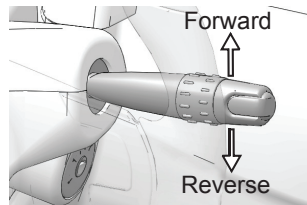

FEATURES AND CONTROLS

Console

Right Control Lever

Direction Selection Switch

NOTICE: Always bring the vehicle to a complete stop before changing the position of the direction switch.

MODE	PROCEDURE
Forward	Move the lever fully upward to operate in forward mode. The forward mode allows operation of the vehicle at speeds of 0-25 MPH (0-40 km/h).
Neutral	Move the lever to the center position to prevent the vehicle from moving if the accelerator is pressed.
Reverse	Move the lever fully downward to operate in reverse mode. A reverse warning alert will automatically sound when the key is on and reverse mode is selected. Vehicle speed is limited when operating in reverse. See page 90 for safe reverse operation procedures.

FEATURES AND CONTROLS

Console

Right Control Lever

Windshield Wiper

Rotate the knurled barrel forward to turn the windshield wipers on. Pull the control lever toward the driver's seat to activate the washer (if equipped).

If the wiper fails to work, check for a blown fuse at the fuse block. See page 106.

CAUTION! A worn or damaged wiper blade could impair operator vision and result in an accident. A worn wiper blade could also damage windshield glass. Always replace worn or damaged wiper blades promptly.

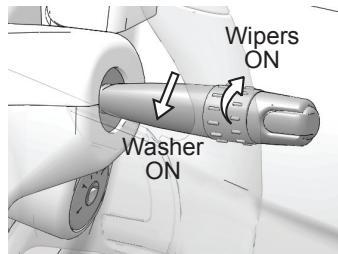

FEATURES AND CONTROLS

Digital/Analog Gauge

High water pressure may damage components. Wash the vehicle by hand or with a garden hose using mild soap. Certain products, including insect repellents and chemicals, will damage the speedometer lens and other plastic surfaces. Do not use alcohol to clean the instrument cluster. Do not allow insect sprays to contact the lens. Immediately clean off any gasoline that splashes on the instrument cluster.

Speedometer

When driving, the speedometer displays vehicle speed in either miles per hour (MPH) or kilometers per hour (km/h). See page 47.

Mode Button



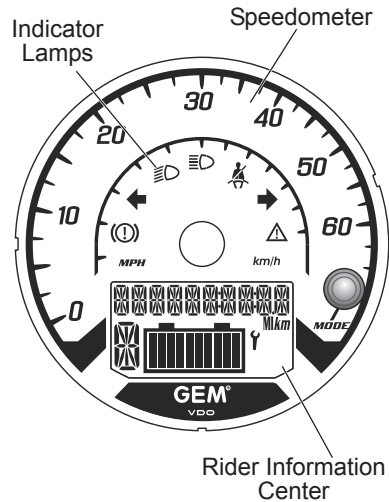



Use the MODE button to toggle through mode options. See page 47.



FEATURES AND CONTROLS

Digital/Analog Gauge

Indicator Lamps

Lamp	Indicates	Condition
	Vehicle Speed	When standard mode is selected, speed displays in miles per hour.
		When metric mode is selected, speed displays in kilometers per hour.
	Brake Indicator	This lamp illuminates when the park brake is engaged or when a brake system failure has occurred. See page 43.
	Direction Indicators	A direction indicator flashes when a turn signal is active.
	Low Beam	This lamp illuminates when the headlamp switch is set to low beam.
	High Beam	This lamp illuminates when the headlamp switch is set to high beam.
	Seat Belt	When the key is turned on, the seat belt indicator lamp will illuminate if the driver's seat belt is not fastened. The lamp is a reminder to the operator to ensure all riders are wearing seat belts before operating.

FEATURES AND CONTROLS

Digital/Analog Gauge Indicator Lamps



Brake Indicator

The brake indicator illuminates when the park brake is engaged or when a brake system failure has occurred. If the brake warning illuminates, check the following items before operating the vehicle.

Brake System Item	Solution
Park brake	Release the park brake.
Brake fluid level	If low, add brake fluid. See page 100.
Brake system	Check hoses for cracks, scuffs and worn spots. If you discover signs of wear or damage, do not operate the vehicle. Your authorized GEM dealer can provide service.

WARNING! Worn or damaged brake hoses can cause brake failure. Always have worn or damaged brake hoses replaced promptly.

FEATURES AND CONTROLS

Digital/Analog Gauge

Rider Information Center

The rider information center is located in the instrument cluster. The information center is set to display standard units of measurement and a 12-hour clock at the factory. To change to metric and/or a 24-hour clock, see page 47.

Information Display

This area will display clock, odometer, trip meter, state of charge (SOC), range meter, efficiency rate (EFF) or any existing fault codes or warning messages. See page 47.

Miles/Kilometers Indicator

The miles or kilometers indicator illuminates to indicate the mode of measurement selected.

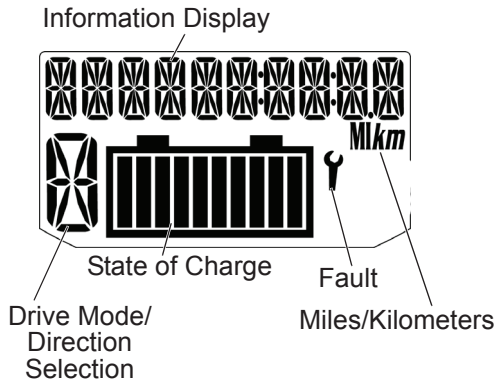

FEATURES AND CONTROLS

Digital/Analog Gauge Rider Information Center Fault Indicator

When both the chassis fault lamp and the fault indicator (wrench symbol) illuminate, use the mode button to toggle through fault codes or warning messages in the display. Your authorized dealer can provide code details and diagnosis.

Drive Mode/Direction Selection Indicator

This indicator displays the selected forward drive mode or neutral or reverse.

F = Forward

N = Neutral

R = Reverse (flashing)

FEATURES AND CONTROLS

Digital/Analog Gauge

Rider Information Center

State of Charge

This indicator illuminates when the key is turned on. It also illuminates 8-10 seconds after the charging cord is connected, turning off when the batteries are 100% charged. To verify a full charge or to check the state of charge, turn the key on. As charge is depleted, illuminated bars begin to turn off from right to left. Remaining bars indicate remaining battery charge.

State of Charge Indicator	
Bars	% Of Charge
1	Less Than 10
2	10-20
3	20-30
4	30-40
5	40-50
6	50-60
7	60-70
8	70-80
9	80-90
10	90-100

FEATURES AND CONTROLS

Digital/Analog Gauge Rider Information Center Information Display Mode

This area will display clock, odometer, trip meter, state of charge (SOC), range meter, efficiency rate (EFF) or any existing fault codes or warning messages.

The display can be changed to show either standard or metric units of measurement for each of the following settings.

Tip: To exit the set-up mode, turn the key off. Wait 5 seconds, then turn the key on. The gauge displays the mode that was displayed prior to setting the units.

	Standard Display	Metric Display
Distance	Miles	Kilometers
Temperature	Fahrenheit	Celsius
Time	12-Hour Clock	24-Hour Clock

FEATURES AND CONTROLS

Digital/Analog Gauge

Rider Information Center

Information Display Mode

1. Turn the key to the OFF position.
2. Press and *hold* the MODE button while turning the key to the ON position.
3. When the display flashes the distance setting, tap the MODE button to advance to the desired setting.
4. Press and *hold* the MODE button to save the setting and advance to the next display option.
5. Repeat the procedure to change remaining display settings.

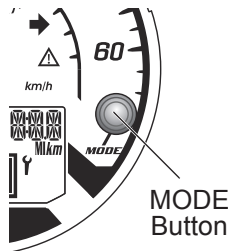

FEATURES AND CONTROLS

Digital/Analog Gauge Rider Information Center Information Display Mode Clock Resetting

Tip: The clock must be reset any time the batteries have been disconnected or fully discharged.

1. Turn the key to the ON position. Use the MODE button to toggle to the clock display.
2. Press and *hold* the MODE button until the hour segment flashes. Release the button.
3. With the segment flashing, tap the MODE button to advance to the desired setting.
4. Press and *hold* the MODE button until the next segment flashes. Release the button.
5. Repeat steps 3-4 twice to set the 10-minute and 1-minute segments. After completing the 1-minute segment, step 4 will save the new settings and exit the clock mode.
6. Turn the key to the OFF position.

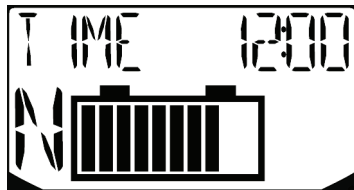

FEATURES AND CONTROLS

Digital/Analog Gauge

Rider Information Center

Information Display Mode

Odometer

The odometer displays the distance traveled by the vehicle since manufacture.

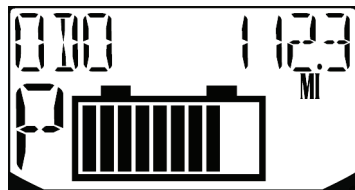

Trip Meter

The trip meter displays distance traveled since the last reset of the trip meter. To reset, toggle to the trip meter display. Press and hold the MODE button until the meter resets to zero.

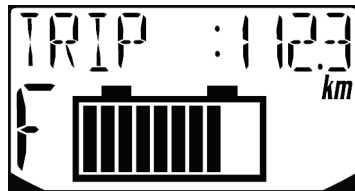

FEATURES AND CONTROLS

Digital/Analog Gauge Rider Information Center Information Display Mode Battery State of Charge

This mode displays the remaining system voltage level in percentage format.

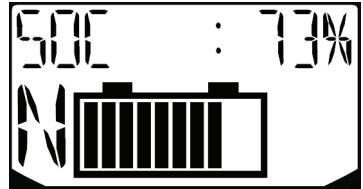

Range Meter

The range meter displays the approximate distance the vehicle could travel on the remaining battery voltage level.

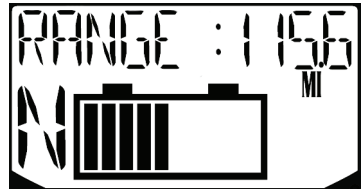

FEATURES AND CONTROLS

Digital/Analog Gauge

Rider Information Center

Information Display Mode

Efficiency Rate (EFF)

This mode displays the rate at which electrical power (Wh) is consumed per mile or per kilometer. A higher number indicates less desirable efficiency. A lower number indicates better efficiency.

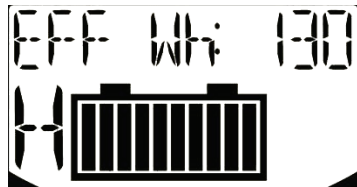

FEATURES AND CONTROLS

Main Power Connector

When the main power connector is unplugged, the battery pack is disconnected from all electrical components, with the exception of the contactor. After servicing the vehicle, the main power connector should be the last connection to be made.

Disconnecting Power

1. Position the vehicle on a dry, firm, level surface.
2. Set the park brake.
3. Turn the key off.
4. Remove the hood. See page 84.

NOTICE: Damage to electrical connections and components will occur if they are unplugged before the main power connector is disconnected.

WARNING! Before servicing the vehicle's electrical system, always disconnect the main power connector first, then disconnect any electrical accessory connections, then disconnect the negative cable from the 12-volt battery (if equipped), then disconnect the negative terminal from the main battery pack.

FEATURES AND CONTROLS

Main Power Connector

5. Locate the main power connector at the lower left front of the vehicle, below the horn assembly. Unplug the main power connector.
6. Locate and disconnect electrical accessory connectors (such as a heater or a heated windshield).

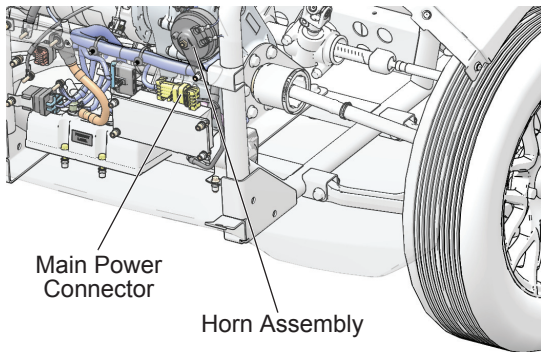

FEATURES AND CONTROLS

Main Power Connector

7. If equipped, disconnect the negative cable from the auxiliary 12-volt battery.

WARNING! Insulate any tools used within the battery area to prevent sparks or battery explosion caused by shorting the battery terminals or wiring. Remove the batteries, or cover the exposed terminals with an insulating material.

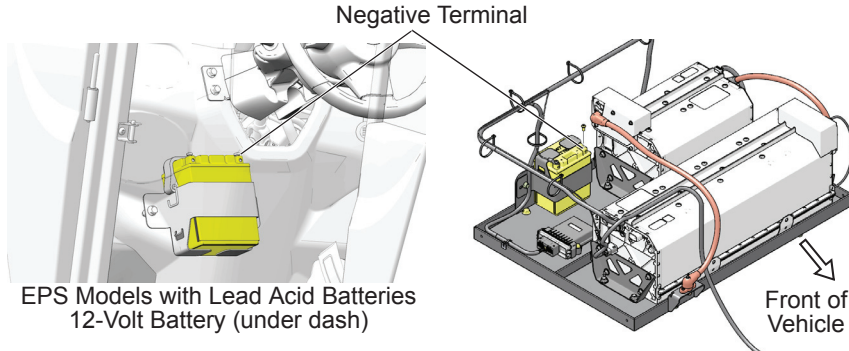

(continued on next page)

FEATURES AND CONTROLS

Main Power Connector

8. Disconnect the main **NEGATIVE** cable from the traction batteries. Isolate the cable end to ensure the circuit cannot be completed during service.

Reconnecting Power

1. Reconnect the negative cable to the traction batteries. Torque the nut to 8 lb-ft (10.8 Nm).
2. Reconnect the negative cable to the auxiliary 12-volt battery (if equipped). Torque the screw to 5.5 lb-ft (7.5 Nm).
3. Reconnect electrical accessory connectors (if equipped).
4. Reconnect the main power connector.
5. Reinstall the hood.

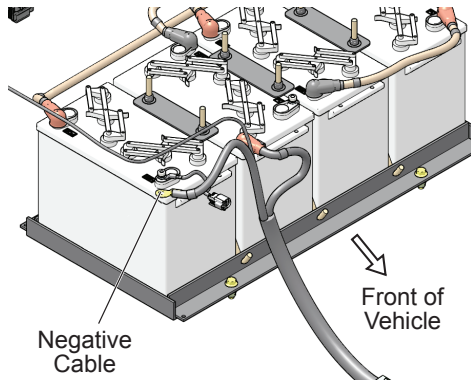

FEATURES AND CONTROLS

Brake Pedal

The brake pedal is located on the floor to the left of the accelerator pedal. Push the brake pedal toward the floor to slow or stop the vehicle. Apply the brakes before turning the key on.

WARNING! Constant brake use (riding the brakes) can cause brakes to overheat and fail, which could lead to an accident resulting in serious injury or death. Do not drive with your foot resting or riding on the brake pedal.

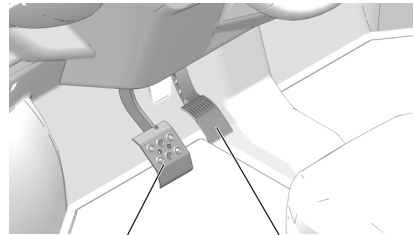

Brake Pedal

Accelerator Pedal

FEATURES AND CONTROLS

Accelerator Pedal

The accelerator pedal is located on the floor to the right of the brake pedal. To begin moving or to increase vehicle speed, gradually push the accelerator pedal toward the floor. Holding the accelerator pedal down continuously will accelerate the vehicle to the maximum speed.

The accelerator pedal will function only if the key is on.

To slow the vehicle, release the accelerator pedal and apply the brake. The electric motor provides additional braking force when the brake pedal is applied.

FEATURES AND CONTROLS

Park Brake Lever

WARNING! A rolling vehicle can cause serious injury. Always set the park brake when leaving the vehicle unattended. Remove the key from the ignition to prevent unauthorized use.

If the key is turned off without setting the park brake, an alert will sound. Set the park brake to end the alert.

When the park brake is set and the brake indicator is illuminated, the vehicle will not move.

Always apply the brakes before setting or releasing the park brake. To set the park brake, pull the park brake lever slightly upward and toward the center of the vehicle. To release the park brake, press and hold the park brake release and move the lever to the disengaged position.

NOTICE: Be sure the park brake is fully disengaged before driving. Failure to do so can lead to overheating of the rear brakes.

NOTE: The park brake is adjustable and should be checked periodically as outlined in the Periodic Maintenance Chart beginning on page 98. Your authorized dealer can assist.

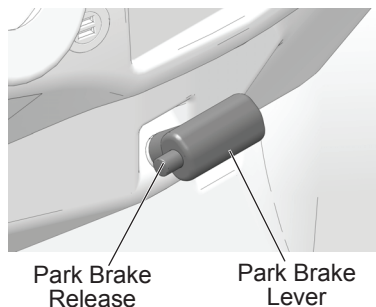

FEATURES AND CONTROLS

Batteries

Battery Pack

Your vehicle is equipped with a battery pack. This battery pack supplies the power needed to operate the vehicle.

These batteries perform best when recharged fully and often. *Recharge the batteries daily, or after each use of the vehicle.*

NOTICE: Each vehicle is programmed at the factory for a particular battery type. Switching battery types should be done only by an authorized service technician. Your authorized GEM dealer can provide battery-related service.

To access the battery pack, remove any rear accessory rack installed on the vehicle. See page 82. Release the battery pack access cover fasteners and remove the cover.

FEATURES AND CONTROLS

Batteries

Battery Performance Tips

- New batteries will not perform to their fullest capacity until they have been discharged and recharged 20 to 30 times.
- Batteries should be fully charged before the first use.
- Recharge the batteries daily, or after each use of the vehicle.
- Always maintain a full charge on the batteries. For best battery life, avoid discharging the batteries more than 80%.
- Batteries should be at room temperature when recharging. Do not charge batteries at temperatures of 110°F (43°C) or higher.
- Range may be affected by road conditions, terrain, temperature and driving habits.

FEATURES AND CONTROLS

Batteries

On-Board Charger

The on-board battery charger is located under the hood.

The state of charge of the batteries displays in the rider information center and a “C” displays when the vehicle is charging.

When the vehicle will not be used for 10 or more days, connect the charger. The state of charge of the batteries will be monitored, and charging will automatically be initialized when the state of charge drops below 97% or when 28 days have passed since the last charge completed.

This works best for maintenance free sealed Absorbent Glass Mat (AGM) batteries. Water filled lead acid batteries will require some attention to maintain proper fluid levels. See page 124.

IMPORTANT: Avoid temperature extremes when choosing a storage area.

FEATURES AND CONTROLS

Batteries

On-Board Charger

If the combined voltage of all batteries reaches 36 volts or less, a safety feature in the on-board charger will not allow the charger to activate. If this occurs, use the alternate charging method. See page 68.

Battery Charging

WARNING! Using a non-recommended extension cord could result in fire, heat damage or charger failure, which could result in serious injury or death. Always use the recommended type of cord to charge the batteries.

Tip: Do not use a ground fault interrupt (GFI) type cord on a GFCI-protected outlet.

WARNING! Charging from a circuit of lesser capacity and/or using a cord from the outlet to the vehicle that is not sufficient in wire gauge could create a fire hazard.

WARNING! Failure to provide adequate ventilation while charging batteries can result in an explosion. Hydrogen gas is emitted during charging and will rise and accumulate at the ceiling. Always ensure a minimum of five (5) air changes per hour in the charging area. Never charge the batteries in an area subject to a flame or spark, including areas containing gas or propane water heaters and furnaces. Do not smoke in the charging area.

FEATURES AND CONTROLS

Batteries

Battery Charging

Your vehicle is equipped with either a standard charge receptacle or a fast charge receptacle. The battery charge receptacle is located at the rear of the hood, just below the windshield.

Standard Charge Receptacle

The following information applies to use of the standard charge receptacle. See page 67 for information that applies to the use of the fast charge receptacle.

When charging the vehicle, always use a standard 3-wire grounded extension cord of one of the following types:

- 12-gauge wire with 3-wire grounded, 50 feet (15.25 m) or shorter.
- 14-gauge wire with 3-wire grounded, 25 feet (7.6 m) or shorter.

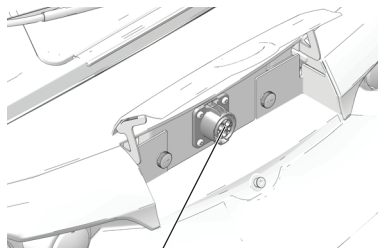

Charge Receptacle

FEATURES AND CONTROLS

Batteries

Battery Charging

Always follow these precautions when charging:

- Position the vehicle on a level surface. Make sure the charging area is well ventilated.
- Make sure the key is off.
- Always use the recommended extension cord type.
- Inspect the extension cord for cracks, loose connections and frayed wiring. Never use a damaged extension cord.
- Always connect the charging cord to the vehicle's charge receptacle first, then plug the cord into a wall receptacle.

(continued on next page)

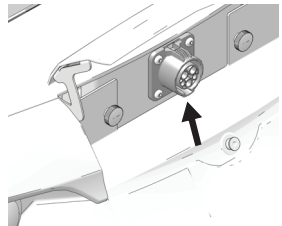

1. Plug into vehicle



2. Plug into outlet

FEATURES AND CONTROLS

Batteries

Battery Charging

Tip: Always use a 110-volt AC, 15 amp breaker outlet. A GFI (Ground Fault Interrupt) receptacle is recommended. See your authorized GEM dealer if you do not have a GFI receptacle at your regular recharge site.

- Make sure the charger uses a dedicated circuit to prevent overloading. If charging multiple vehicles, each vehicle should use a dedicated circuit.
- When disconnecting the charger, always disconnect the extension cord from the wall receptacle first, then disconnect the cord from the vehicle.

FEATURES AND CONTROLS

Batteries

Battery Charging

Fast Charge Receptacle

The following information applies to use of the fast charge receptacle. See page 64 for information that applies to the use of the standard charge receptacle.

1. Always use SAE J1772 approved charge stations and connectors.
2. To begin charging, align and insert the charge station connector into the receptacle until it latches.
3. The lights on the charge station will indicate charging when the connection is made.
4. To remove the connector after the charge cycle is complete, press the release button and pull the connector out.

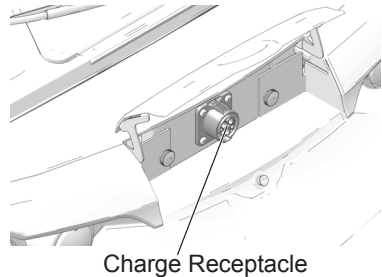

FEATURES AND CONTROLS

Batteries

Alternate Battery Charging Method

If the combined voltage of all batteries reaches 36 volts or less, a safety feature in the on-board charger will not allow the charger to activate. Use the alternate charging method to add a small charge to each battery separately. The on-board charger will then activate properly to recharge all batteries to a full charge.

Use a 12-volt battery charger to charge 12-volt batteries. Charge each battery individually.

Use a 12-volt charger to charge 6-volt batteries. Charge in four groups, each consisting of two sequentially wired batteries.

Tip: It is not necessary to remove or disconnect battery post connections during the alternate charging method.

FEATURES AND CONTROLS

Batteries

Alternate Battery Charging Method

1. Set the battery charger to the medium amp setting (10 to 30 amps).
2. Charge each battery for 10-20 minutes.
3. Move quickly from battery to battery, as this is only a residual charge and it will dissipate in a short period of time.
4. After charging the last battery, remove the off-board charger leads and plug the vehicle in.
5. If the on-board charger does not recognize the residual charge and activate, repeat the alternate charging method.

FEATURES AND CONTROLS

Batteries

Battery Handling Precautions

WARNING! Do not work in or near the battery compartment or on any other electrical component of the vehicle while charging the batteries.

WARNING! Before servicing the vehicle's electrical system, always disconnect the main power connector first, then disconnect any electrical accessory connections, then disconnect the negative cable from the 12-volt battery (if equipped), then disconnect the negative terminal from the main battery pack. See page 53. This will disable the vehicle by disconnecting the battery pack from the motor. It does not disable the battery pack. HIGH VOLTAGE will be present at the battery terminals and contactor. HIGH BATTERY VOLTAGE IS ALWAYS PRESENT. DO NOT TOUCH THE BATTERY TERMINALS.

- Always make sure that all 12-volt electrical accessories are grounded directly to the negative (-) post on the terminal board. Never use the chassis or body as a ground connection. See page 72.
- Make sure vent caps are installed properly and securely during vehicle operation and battery charging.

(continued on next page)

FEATURES AND CONTROLS

Batteries

Battery Handling Precautions

- Never connect a 12-volt accessory directly to the batteries. Always connect any powered accessory to the 12-volt terminal board. See page 72.
- Never connect jumper cables to any of the batteries of this vehicle.
- Always wear safety glasses or approved eye protection when servicing the vehicle. Wear a full-face shield and gloves when working with or around batteries and electrical connectors.
- Use only insulated tools when working in the battery compartment.
- Always keep battery terminals and connections clean and free of corrosion at all times. See pages 120 and 126.

FEATURES AND CONTROLS

Batteries

12-Volt Terminal Board Connections

Remove the upper dash to access the 12-volt terminal board. See page 104.

Always make sure that all 12-volt electrical accessories are grounded directly to the negative (-) post on the terminal board. Never use the chassis or body as a ground connection.

Use the positive (+) terminal only for accessories that require constant power (when the ignition key is off).

Use the accessory (ACC) terminal for accessories that require power only when the ignition key is on.

NOTICE: To avoid draining the battery system, always install an accessory exactly as stated in the provided installation instructions.

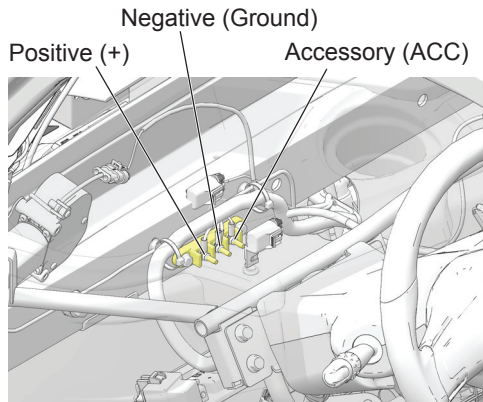

FEATURES AND CONTROLS

USB Port

NOTICE: Do not plug in devices requiring power exceeding 25 watts. Damage to the vehicle electrical system may occur or an accessory fuse may blow.

The fuse for the USB port is located under the hood in the fuse block. Always use fuses with the same type and rating.

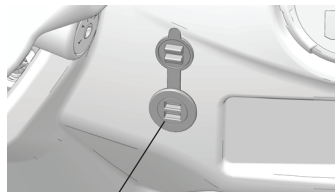

USB Port

Dome Light

Turn the dome lights on or off by pressing the switch located on the dash between cup holders.

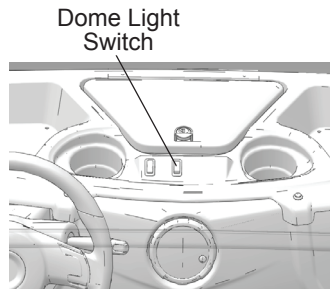

Dome Light
Switch

FEATURES AND CONTROLS

Doors

Accessory doors are available for most models. Options include soft doors, hard doors with crank windows and locks, half doors and quarter doors.

WARNING! Doors do not offer structural protection in the event of an accident and do not change the open body characteristics of the vehicle. The doors provide protection from the weather only. Always use seat belts. Failure to use the seat belts puts the driver and passengers at greater risk of serious injury or death in the event of an accident.

FEATURES AND CONTROLS

Seat Adjustment

Seats can be adjusted forward or rearward. The seat adjustment lever is directly under the front of the seat.

1. Move the adjustment lever to the left and slide the seat to the desired position.
2. Release the lever.
3. Make sure the seat latches securely in position. Test the latch by attempting to slide the seat forward and rearward while seated.

FEATURES AND CONTROLS

Seat Belts

WARNING

Failure to properly use seat belts and child restraints can result in serious injury or death. Always follow all legal requirements for seat belt and child restraint use in on-road vehicles.

- Always make sure the seat belts are secured for operator and all passengers before operating.
- Pregnant women should wear the lap part of the belt across the thighs and as snug across the hips as possible. Keep the belt low so that it does not come across the abdomen.
- The operator and all passengers are subject to the same legal requirements for seat belt use as occupants in other on-road vehicles. Always make sure children are properly restrained. Children ages 12 and under *should* ride in a rear seat. Infants *must always* be restrained in a rear seat. Use the type of restraint that is correct for your child. When using child safety seats, always follow the manufacturer's instructions for proper installation and use in a vehicle containing only a shoulder/lap belt restraint system. Visit www.seatcheck.org or call 1-866-SEATCHECK for more information about child restraints.

FEATURES AND CONTROLS

Seat Belts

Proper Seat Belt Use

This vehicle is equipped with three-point lap and diagonal seat belts for all occupants. Always make sure the seat belts are secured for operator and all passengers before operating.

When the key is turned on, the seat belt indicator lamp will illuminate if the driver's seat belt is not fastened.

To wear the seat belt properly, follow this procedure:

1. Pull the seat belt latch downward and across your chest toward the buckle at the inner edge of the seat.
2. Slide the buckle up the webbing as far as needed for the belt to reach across your hips. The belt should fit snugly across your hips and diagonally across your chest. Make sure the belt is not twisted.

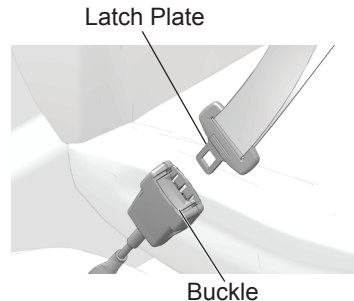

FEATURES AND CONTROLS

Seat Belts

Proper Seat Belt Use

3. Push the latch plate into the buckle until it clicks.
4. Release the strap, it will self tighten.
5. To remove slack in the lap belt portion of the belt, pull upward on the shoulder belt. To loosen the lap belt if it is too tight, tilt the buckle and pull the lap belt slightly longer.
6. To release the seat belt, press the square red button in the buckle's center. If necessary, slide the buckle down the webbing to allow it to retract fully.

FEATURES AND CONTROLS

Seat Belts

Seat Belt Safety Tips

- In a rear seat, you may have trouble tightening the lap/shoulder belt on the child restraint because the buckle or latch plate is too close to the belt path opening on the restraint. Disconnect the latch plate from the buckle and twist the short buckle-end belt several times to shorten it. Insert the latch plate into the buckle with the release button facing outward.
- If the belt still cannot be tightened when using a child safety seat, or if pulling and pushing on the restraint loosens the belt, disconnect the latch plate from the buckle, turn the buckle around and insert the latch plate into the buckle again. If you still cannot make the child restraint secure, try a different seating position.

FEATURES AND CONTROLS

Seat Belts

Seat Belt Inspection

Inspect all seat belts for proper operation before each use of the vehicle.

1. Push the latch plate into the buckle until it clicks. The latch plate must slide smoothly into the buckle. A click indicates that it's securely latched.
2. Push the red release latch in the middle of the buckle to make sure it releases freely.
3. Pull each seat belt completely out and inspect the full length for any damage, including cuts, wear, fraying or stiffness. If any damage is found, or if the seat belt does not operate properly, have the seat belt system checked and/or replaced by an authorized service dealer.
4. To clean dirt or debris from the seat belts, sponge the straps with mild soap and water. Do not use bleach, dye or household detergents.

FEATURES AND CONTROLS

Stereo System (Option)

The optional stereo system is mounted in the dash and features speakers, FM radio, MP3 capabilities and Bluetooth functionality. Refer to your stereo system's user manual for detailed operating instructions.

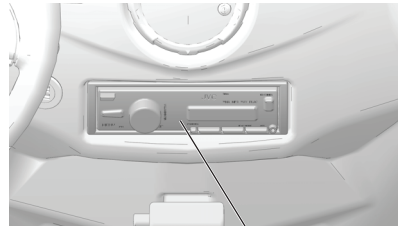

Stereo

Solar Panel (Option)

The optional solar panel is mounted on top of the vehicle. Refer to your solar panel user manual for details.

WARNING! Do not stack items on the solar panel. Never exceed the GVWR or GAWR.

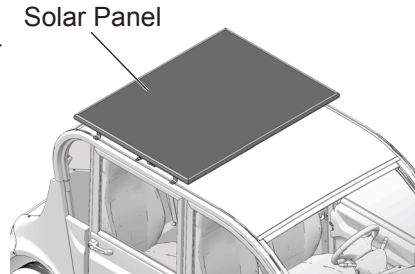

FEATURES AND CONTROLS

Rear Accessory Backs (Option)

Rear accessory back options are available. These accessory backs are interchangeable.

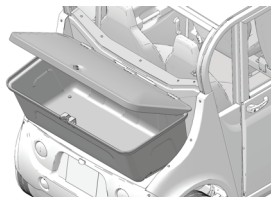

TrunkBack™

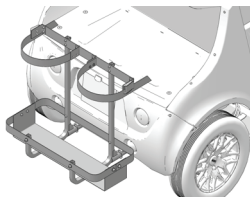

LinksBack™

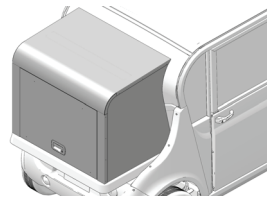

Short Bed with Cargo Carrier

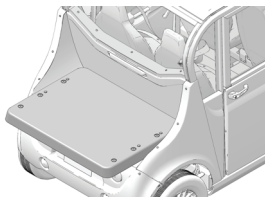

Short Bed

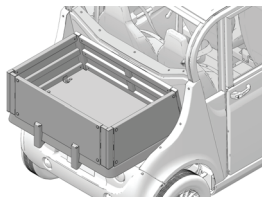

Short Bed with Solid Sides

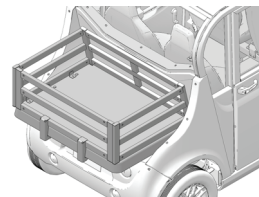

Short Bed with StakeBack™

FEATURES AND CONTROLS

Rear Accessory Backs (Option)

WARNING! Never carry a passenger on a rear accessory back. Do not overload an accessory back. Overloading the vehicle can reduce stability and handling and could cause loss of control. *Never exceed the GVWR or the GAWR of the vehicle.* See page 22.

NOTICE: Use only GEM-approved rear accessories. Others may cause damage to the locking system or vehicle, and will void warranty.

1. Remove the contents of the installed rear accessory back.
2. Remove the attachment bolts.
3. Firmly grasp the installed back and remove it from the vehicle.

Grab Handle Package (Standard)

Grab handles can be added at each seat position to assist riders in entering and exiting the vehicle. Interior grab handles are not intended to retain passengers in the vehicle. Always make sure the seat belts are secured for operator and all passengers before operating.

FEATURES AND CONTROLS

Hood

Remove the hood to access the fuse box, windshield washer fluid tank (if equipped), main power connector and electrical accessory connectors.

1. Remove the two hood screws located under the charge port door.
2. Keeping the hood parallel with the ground, pull the hood forward to release it from the grommets. Carefully lift the hood away from the vehicle.

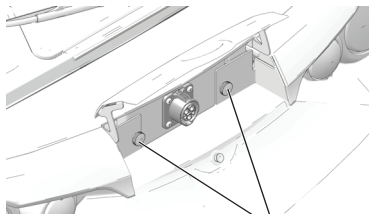

Step 1

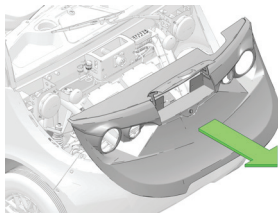

Step 2

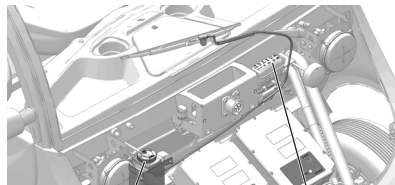

Washer Fluid Tank

Fuse Box

FEATURES AND CONTROLS

Hitches

A rear hitch (if installed) is for light-duty off-road use. Hitch use is not approved for on-road operation.

WARNING! *Never exceed the GVWR or the GAWR of the vehicle. See page 22.*

Chrome Bumpers/Rugged Bumpers (Option)

Front bumpers are for appearance only and will protect the body panels only from minor dents and scratches. They will not provide protection to the vehicle in front-end collisions.

NOTICE: Never use your GEM vehicle for pushing. Damage to the vehicle may result.

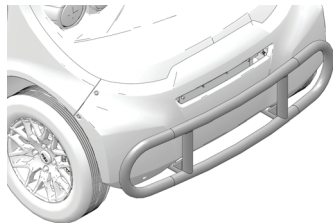

Heater/Fan or Fan Only (Options)

The heater unit can be used to provide heat inside the vehicle. The switch is located on the console. Move the switch to the HEAT position. Move the switch to the FAN position to operate air flow without heat.

FEATURES AND CONTROLS

Heated Windshield (Option)

The heated windshield has heating elements within the glass to assist in defogging the windshield.

Press the heated windshield switch on the console to turn on the heating elements. A light on the switch illuminates when the elements are heating.

Press the switch again to turn off the heating elements. If the heating elements are not turned off, they will automatically turn off after five minutes of operation.

Adjustable Tilt Steering Column (Option)

1. Move and hold the tilt lever forward or rearward to release the latch.
2. Adjust the steering column to the desired position.
3. Release the lever to the center position to lock the steering column.

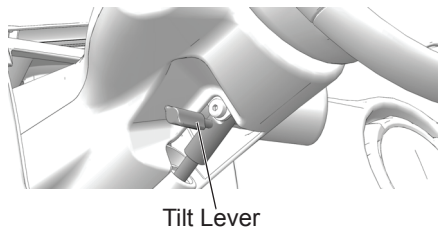

FEATURES AND CONTROLS

Windshield Washer (Option)

Rotate the knurled barrel forward to turn the windshield wipers on.

Pull the control lever toward the driver's seat to activate the washer.

Check the washer reservoir fluid level frequently. When the level is low, remove the cap and add windshield antifreeze (not radiator antifreeze) rated for -25°F (-31°C). Operate the system for a few seconds to flush out any residual water.

WARNING! Commercial windshield washer solvents are flammable. Keep sparks, flames and cigarettes away. Handle with caution.

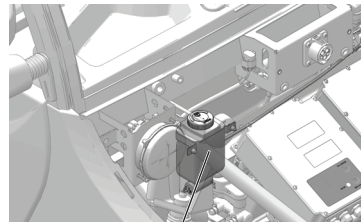
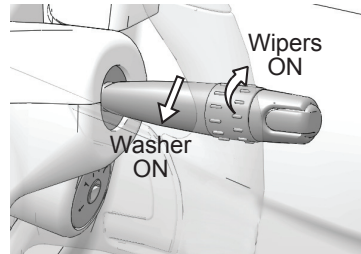

Washer Reservoir

OPERATION

⚠ WARNING

Failure to operate the vehicle properly can result in a collision, loss of control, accident or overturn, which may result in serious injury or death. Read and understand all safety warnings outlined in the safety section of this owner's manual.

Pre-Ride Inspection

Failure to inspect and verify that the vehicle is in safe operating condition before operating increases the risk of an accident. Always inspect the vehicle before each use to make sure it's in safe operating condition.

Item	Remarks	Page
Accelerator	Ensure proper operation	58
Brake system/pedal travel	Ensure proper operation	100
Brake fluid	Ensure proper level	100
Indicator lights/switches	Ensure operation	-
Headlamp	Check operation	113
Brake light/tail lamp	Check operation	-

Pre-Ride Inspection

Item	Remarks	Page
Turn signals	Ensure operation of all signal lamps	36
Mirrors	Adjust mirrors for proper side and rear view	-
Horn	Ensure operation	37
Seat belts	Check length of belt for damage, check latches for proper operation	80
Steering	Ensure free operation	103
Tires	Check tire condition and pressure	108-109
Latches (doors/seats/ accessory back)	Ensure all latches are secure	-
Batteries	Ensure full charges, proper water levels, clean terminals	120-127
Battery cables	Inspect for proper cable routing, secure connections	120
Wheels/fasteners	Inspect, ensure fastener tightness	109

OPERATION

Driving Procedure

1. Disconnect the charging cable.
2. Sit in the driver's seat and fasten the seat belt. Make sure passengers are seated with seat belts secured.
3. Adjust mirrors as needed.
4. Turn the key clockwise to the ON position.
5. Apply the brakes.
6. Release the park brake.
7. Move the direction switch to the desired position. See page 38.
8. Check your surroundings and determine your path of travel.
9. Keeping both hands on the steering wheel, release the brake pedal and gradually push the accelerator toward the floor to begin driving.
10. Drive slowly. Practice maneuvering and using the accelerator and brakes on level surfaces.

Driving Procedure

11. Before turning, activate a turn signal to alert others of your intentions. See page 36.
12. Do not carry a passenger until you have at least two hours of driving experience with this vehicle. Allow a passenger to ride only in a designated passenger seat with seat belt secured.
13. To stop the vehicle, release the accelerator pedal completely and brake to a complete stop.

NOTICE: Always bring the vehicle to a complete stop before changing the position of the direction switch.

14. Set the park brake.

WARNING! A rolling vehicle can cause serious injury or death. Always set the park brake when leaving the vehicle unattended.

15. Turn the key off.
16. Recharge the batteries daily, or after each use of the vehicle.

OPERATION

Driving in Reverse

Follow these precautions when operating in reverse:

1. Always check for obstacles or people behind the vehicle. Always inspect left and right fields of vision before backing.
2. Avoid backing downhill.
3. Back slowly.
4. Apply the brakes *lightly* for stopping.
5. Avoid turning at sharp angles.
6. Never accelerate suddenly.

Driving On Slippery Surfaces

⚠ WARNING

Skidding or sliding can cause loss of control or overturn (if tires regain traction unexpectedly). When operating on slippery surfaces, reduce speed and use extra caution to reduce the chance of skidding or sliding out of control. Do not operate on excessively slippery surfaces.

Whenever driving on slippery surfaces such as wet or icy pavement or loose gravel, follow these precautions:

1. Do not operate on excessively slippery surfaces.
2. Slow down before driving onto a slippery surface.
3. Avoid quick, sharp turns, which can cause skids.
4. Correct a skid by turning the steering wheel in the direction of the skid. *Never apply the brakes during a skid.*

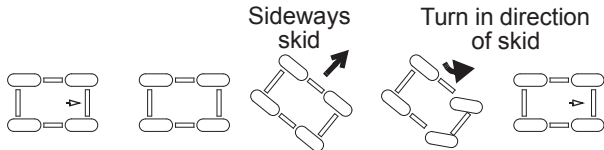

OPERATION

Parking the Vehicle

1. Apply the brakes. Stop the vehicle on a level surface.
2. When parking inside a garage or other structure, be sure that the structure is well ventilated and that the vehicle is not close to any source of flame or sparks, including any appliance with pilot lights.
3. Move the direction switch to the neutral position.
4. Set the park brake.
5. Turn the key off. Remove the key from the ignition to prevent unauthorized use.

Parking on an Incline

Avoid parking on an incline if possible. If it's unavoidable, follow these precautions:

- If parking in an open area, block the wheels on the downhill side of the vehicle after turning the key off.
- If parking parallel to a curb, stop the vehicle close to the curb. If the vehicle is facing downhill, turn the steering wheel toward the curb. The forward part of the front tire should be turned into the curb. If the vehicle is facing uphill, turn the steering wheel away from the curb. The rear part of the front tire should be turned into the curb.
- Set the park brake.

OPERATION

Towing Loads (eL XD)

Your vehicle has been designed to carry or tow specific capacities. Always read and understand the load distribution warnings listed on the warning labels. See page 16.

The total load (operator, passenger, accessories, cargo and weight on hitch) must not exceed the maximum weight capacity of the vehicle.

Always follow these precautions when towing:

1. Never load more than 150 lbs. (68 kg) tongue weight on the towing bracket.
2. Slow down when towing. Towing a trailer increases braking distance.
3. Do not tow more than the recommended weight for the vehicle.
4. Attach a trailer to the trailer hitch bracket only. Do not attach a trailer to any other location on the vehicle.

Transporting the Vehicle

NOTICE: Towing your GEM vehicle could result in severe damage to the vehicle. Vehicle failures resulting from dolly towing will void warranty.

When transporting the GEM vehicle on a trailer, always use a trailer with an approved load rating greater than the GEM vehicle's curb weight plus any installed accessories or cargo. Refer to the specifications section beginning on page 134.

Always tie the frame of the GEM vehicle to the transporting unit securely with suitable straps. Always secure the straps to the front sub-frame and the rear frame of the GEM vehicle. Never place tie straps across any plastic body or floor panel components.

Transport the vehicle in a closed trailer if possible. Use the following guidelines when transporting the vehicle on an open trailer.

1. Always transport the GEM vehicle facing forward on the trailer.
2. Set the park brake. Remove the key to prevent loss.
3. Secure the seats, hood and any items that could be damaged or dislodged by strong winds. Secure or remove cargo. If equipped with hard doors, put all windows down.
4. Never allow passengers on a trailer or in a trailered vehicle.
5. Reduce speed and drive with caution.

MAINTENANCE

Periodic Maintenance Chart

WARNING! Always wear safety glasses or approved eye protection when servicing the vehicle. Wear a full-face shield and gloves when working with or around batteries and electrical connectors. Always use insulated tools when working with or near batteries. Failure to follow these instructions could result in serious injury or death.

NOTICE: Damage to electrical connections and components will occur if they are unplugged before the main power connector is disconnected.

WARNING! Before servicing the vehicle's electrical system, always disconnect the main power connector first, then disconnect any electrical accessory connections, then disconnect the negative cable from the 12-volt battery (if equipped), then disconnect the negative terminal from the main battery pack. See page 53.

Careful periodic maintenance will help keep your vehicle in the safest, most reliable condition. Inspect, clean, lubricate, adjust and replace parts as necessary. When inspection reveals the need for replacement parts, genuine GEM parts are available from your authorized GEM dealer.

Record maintenance and service in the Maintenance Log beginning on page 150.

Tip: Service and adjustments are important for proper vehicle operation. If you're not familiar with safe service and adjustment procedures, your authorized dealer can perform these operations.

MAINTENANCE

Periodic Maintenance Chart

Monthly Maintenance	See Page
Check battery fluid level (on flooded batteries)	124
Wash tops and terminals of batteries and allow to dry (flooded)	126
Check cables and terminal connections	120, 121
Check for worn insulation or frayed wires	121
Check battery hold-down bar to ensure batteries are tightly secured	121
Check tires for correct air pressure and wear	108
Check brake fluid reservoir for proper brake fluid level.	100
Check brake lines for leaks.	--
Check seat belts for proper operation	80
Check headlights, horn, turn signals, windshield wiper and brake lights for proper operation.	--
Check steering wheel freeplay	103

MAINTENANCE

Brakes

Brake Fluid

Inspect the brake system routinely. Inspect the brake fluid level before each operation. If the level drops between fluid checks, add brake fluid as needed. Your authorized dealer can provide service.

WARNING! After opening a bottle of brake fluid, always discard any unused portion. Never store or use a partial bottle. Brake fluid is hygroscopic, meaning it rapidly absorbs moisture from the air. The moisture causes the boiling temperature of the brake fluid to drop, which can lead to early brake fade and the possibility of accident or severe injury.

Change the brake fluid every two years and any time the fluid becomes contaminated, the fluid level is below the minimum, or if the type and brand of the fluid in the reservoir are unknown. Always use DOT4 brake fluid.

Brakes

Brake Fluid

1. Position the vehicle on a level surface.
2. Open the hood. The brake fluid reservoir is located on the driver's side of the vehicle, above and to the rear of the front tire.
3. View the brake fluid level in the reservoir. The level should be between the upper (MAX) and lower (MIN) level lines.
4. If the fluid level is lower than the upper level line, add brake fluid to the upper (MAX) line.
5. Apply the brake forcefully for a few seconds and check for fluid leakage around the fittings.

NOTICE: Brake fluid may cause damage to painted and finished surfaces. Use caution when refilling the brake fluid reservoir.

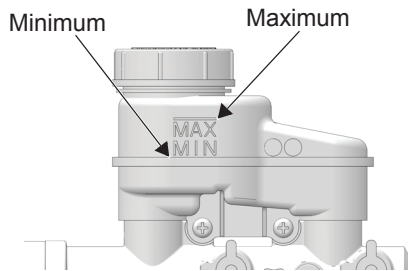

MAINTENANCE

Brakes

Brake Inspection

1. Check the brake system for fluid leaks.
2. Check the brake pedal for excessive travel or a spongy feel.
3. Check the friction pads for wear, damage and looseness.
4. Inspect the brake disc spline and pad wear surface for excessive wear.
5. Change pads when worn to 0.030" (0.762 mm).

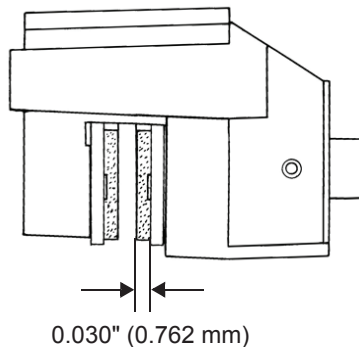

Steering Wheel Inspection

Check the steering wheel for specified freeplay and smooth operation.

1. Position the vehicle on a level surface.
2. Lightly turn the steering wheel left and right. There should be 0.8-1.0 inch (20-25 mm) of freeplay at the outer rim of the steering wheel.
3. If there is excessive freeplay or strange noises, or the steering feels rough or “catchy,” have the steering system inspected by an authorized service dealer.

MAINTENANCE

Upper Dash Removal/Installation

Some maintenance procedures require removal of the upper dash to access components.

1. Remove the eight (8) plastic push rivets securing the dash to the frame. Two of the rivets are located inside the glove box.

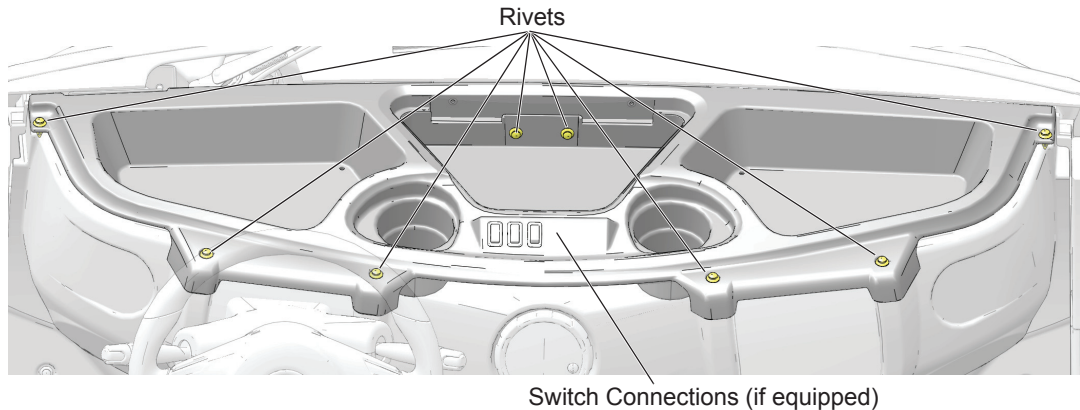

Upper Dash Removal/Installation

2. Slight raise the dash and unplug any switch connections located between the cup holders.
3. Carefully remove the dash from the vehicle.
4. Reverse this procedure to reinstall the dash.

MAINTENANCE

Fuses and Relays

WARNING! Before servicing the vehicle's electrical system, always disconnect the main power connector first, then disconnect any electrical accessory connections, then disconnect the negative cable from the 12-volt battery (if equipped), then disconnect the negative terminal from the main battery pack. See page 53.

If you experience electrical failures not related to the batteries, a fuse may need replacement. Locate and correct any short circuits that may have caused the blown fuse, then replace the fuse. If you suspect a relay or diode needs replacement, your authorized GEM dealer can assist.

Open the hood to access the fuse box. See the label attached to the fuse box cover for the function and amp rating of each fuse. The spare and heater coil fuses are used for accessories.

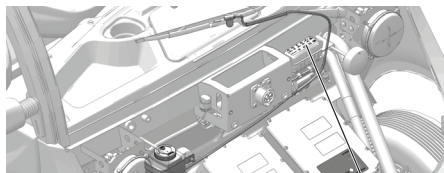

Fuse Box Label

Fuse Box

MOTOR CONTROL RELAY	DISPLAY RELAY	CHASSIS RELAY	VCM RELAY	DC/DC RELAY	
BACKUP RELAY (OPT)	HORN 10A	DRIVE 5A	CHASSIS 30A	VCM 20A	CONSTANT 5A
	INT. LIGHT 5A	WIPER 15A	ACC 15A	DISPLAY 10A	LIGHTS 15A

MAINTENANCE

Fuse and Relay Recommendations

Standard 12V Fuses		
Application	Size	Location
Drive; Constant; Internal Lighting	5 amp	12V Fuse Center
Horn; Display	10 amp	12V Fuse Center
Wiper; ACC; Lights	15 amp	12V Fuse Center
VCM	20 amp	12V Fuse Center
Chassis	30 amp	12V Fuse Center
Optional 12V Fuses		
Application	Size	Location
Lithium-ion	5 amp	Lithium-ion Harness
Beacon Light	7.5 amp	Beacon Harness
Security Light	7.5 amp	Security Light Harness
Stereo	10 amp	Stereo Harness
EPS	30 amp	EPS Harness

Standard 48V Fuses		
Application	Size	Location
Motor Controller/ BMC	5 amp	48V Fuse Center
DC-DC; Charger	30 amp	48V Fuse Center
Optional 48V Fuses		
Application	Size	Location
Lithium-ion	5 amp	Lithium-ion Harness
Heater Heating Element	30 amp	Heater Harness
Defrost	30 amp	Defrost Harness

NOTICE: 12V fuses must not be used in 48V applications. 48V fuses must not be used in 12V applications. Always install fuses with the recommended amperage to avoid damage to the electrical system.

MAINTENANCE

Tires

WARNING

Operating your vehicle with worn tires, improperly inflated tires, non-standard tires or improperly installed tires will affect vehicle handling and could cause an accident resulting in serious injury or death. Always follow all tire maintenance procedures as outlined in this manual and on the labels on the vehicle. Always use original equipment size and type when replacing tires.

Tire Pressure

WARNING! Improper tire pressure can cause loss of control resulting in severe injury or death.

Proper tire pressure is essential to the safe and comfortable operation of your vehicle. Check tire pressure daily, or before each use of the vehicle. For recommended tire pressures, see the manufacturer's label on your vehicle or the specifications section beginning on page 134.

NOTICE: After inspecting or adjusting the tire pressure, always reinstall the valve stem cap (if equipped). This will prevent moisture and dirt from entering the valve stem, which could cause damage.

MAINTENANCE

Tires

Tire Tread Depth

Any accelerated wear of tires may be an indicator of improper alignment or poor driving habits. Your authorized GEM dealer can assist.

Always replace tires when tread depth is worn to 1/8" (3 mm) or less.

Wheel Nut Torque

Inspect the following items occasionally for tightness, and if they've been loosened for maintenance service. Do not lubricate the stud or the lug nut.

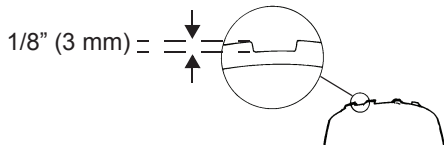

14-inch Cast Aluminum
63 lb-ft (85.4 Nm)



13-inch Steel
40 lb-ft (54.2 Nm)

MAINTENANCE

Tires

Wheel Removal

WARNING! A falling vehicle can cause serious injury or death. Never place any part of your body under an elevated vehicle. If you need access to the bottom of the vehicle, use automotive jack stands to support the vehicle on a firm, level surface. Your authorized GEM dealer can assist.

1. Position the vehicle on a dry, firm, level surface.
2. Set the park brake.
3. Turn the key off.

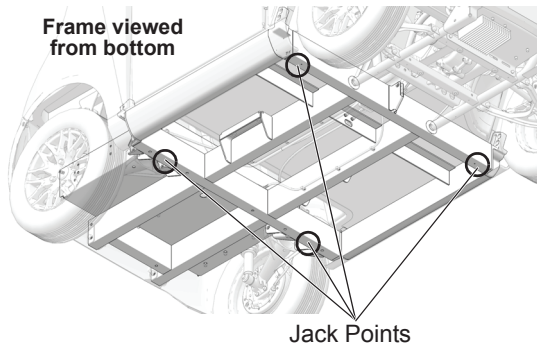

Tires

Wheel Removal

4. Block both the front and rear of the tire that is located diagonally opposite the jacking position. For example, if the right front tire is being changed, block the left rear wheel.
5. Use a small floor style jack or low profile scissors jack only. Jack the vehicle only from the side of the vehicle, on the main frame rail, at the point where the tub or floor panel support and the main frame rail are welded. Alternative locations include the rear frame rail and the center of the front cross member.

NOTICE: Jacking at any location other than the recommended jacking points may cause significant damage to the vehicle frame and body.

6. Remove the wheel nuts.
7. Remove the wheel.

MAINTENANCE

Tires

Wheel Installation

WARNING! Improperly installed wheels can adversely affect tire wear and vehicle handling, which can result in serious injury or death. Always ensure that all nuts are torqued to specification. Do not service axle nuts that have a cotter pin installed. Your authorized dealer can provide service.

1. Set the park brake.
2. Place the wheel in the correct position on the wheel hub. Be sure the valve stem is toward the outside and rotation arrows on the tire point toward forward rotation.
3. Attach the wheel nuts and finger tighten.
4. Carefully lower the vehicle to the ground.
5. Torque the wheel nuts to specification. See page 109.

Lights

Poor lighting can result in reduced visibility when driving. Clean lights frequently and replace burned out lamps promptly. Always make sure lights are adjusted properly for best visibility. When servicing a halogen lamp, don't touch the lamp with bare fingers. Oil from your skin leaves a residue, causing a hot spot that will shorten the life of the lamp.

Headlight Replacement

If a headlight fails to work properly, an expired lamp may need replacement. Apply dielectric grease to the socket before installing the new lamp.

Front/Rear Turn Signal and Brake Light Replacement

If an LED light fails to work properly, the entire assembly must be replaced. Your authorized dealer can provide service.

MAINTENANCE

Lights

Headlight Beam Adjustment

1. Place the vehicle on a level surface with the headlight approximately 25 ft. (7.6 m) from a wall.
2. Measure the distance from the floor to the center of the headlight and make a mark on the wall at the same height.

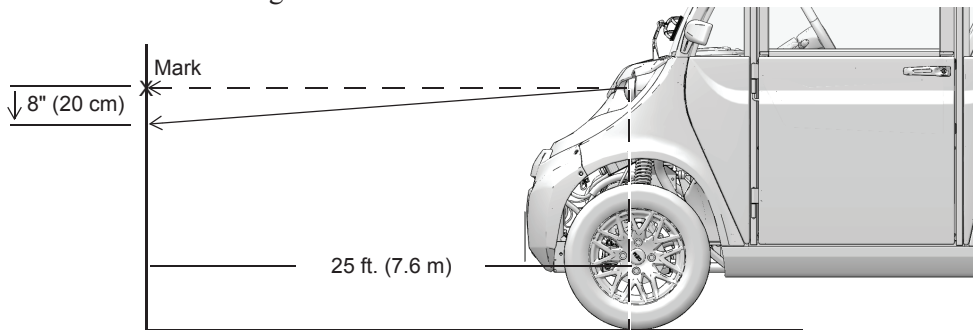

Lights

Headlight Beam Adjustment

3. Apply the brakes. Turn the key on. Turn the headlights to high beam.

Tip: Include the weight of a rider on the seat while performing the following step.

4. Observe the headlight aim. The most intense part of the headlight beam should be aimed 8" (20 cm) below the mark placed on the wall.
5. If a headlight needs adjustment, access the adjustment screw under the hood or through the wheel well.
6. Loosen the headlight adjustment screw, adjust the headlight, and tighten the screw.
7. Repeat steps 4-6 until the lamp is properly adjusted.

MAINTENANCE

Batteries

WARNING

The voltage in the battery pack is sufficient to cause death by electrocution. With the exception of battery inspections and refilling the water in flooded type batteries, never attempt to perform service on the electric drive system, including the battery pack, unless you are properly trained to work on electrical systems. Your authorized GEM dealer can provide battery-related service.

WARNING

Battery posts, terminals and related components contain lead and lead compounds, chemicals known to cause cancer and reproductive harm. Always wash your hands after touching or handling the batteries.

WARNING

Charging a damaged battery can result in serious injury. Never attempt to charge a frozen or bulging battery. Discard the battery appropriately and install a new battery.

Batteries

WARNING

Improperly connecting or disconnecting battery cables can result in an explosion and cause serious injury or death.

WARNING

Battery electrolyte is poisonous. It contains sulfuric acid. Serious burns can result from contact with skin, eyes or clothing.

Antidote:

External: Flush with water.

Internal: Drink large quantities of water or milk. Follow with milk of magnesia, beaten egg, or vegetable oil. Call physician immediately.

Eyes: Flush with water for 15 minutes and get prompt medical attention.

Batteries produce explosive gases. Keep sparks, flame, cigarettes, etc. away. Ventilate when charging or using in an enclosed space. Always shield eyes when working near batteries. **KEEP OUT OF REACH OF CHILDREN.**

MAINTENANCE

Batteries

Traction Battery Configurations

NOTICE: Before accessing the batteries, make sure any wire or metal items (including seat belt latches) remain clear of the battery compartment to avoid causing a short circuit to the electrical system.

Several battery pack configurations exist for GEM vehicles.

- Four 12-volt lead acid batteries
- Eight 6-volt lead acid batteries
- Single module lithium ion battery pack
- Dual module lithium ion battery pack

See page 119 for battery locations and access instructions.

Batteries

Traction Battery Locations

To access the battery pack, remove any rear accessory back installed on the vehicle. See page 82. Release the battery pack access cover fasteners and remove the cover.

All Battery Configurations	
Model	Location
GEM e2	Under rear compartment
GEM e4	Under rear compartment
GEM e6®	Under rear compartment
GEM eL XD	Under rear bed compartment

MAINTENANCE

Batteries

Battery Inspections/Maintenance

WARNING! Do not work in or near the battery compartment or on any other electrical component of the vehicle while charging the batteries. Before servicing the vehicle's electrical system, always disconnect the main power connector first, then disconnect any electrical accessory connections, then disconnect the negative cable from the 12-volt battery (if equipped), then disconnect the negative terminal from the main battery pack. See page 53. This will disable the vehicle by disconnecting the battery pack from the motor. It does not disable the battery pack. HIGH VOLTAGE will be present at the battery terminals. HIGH BATTERY VOLTAGE IS ALWAYS PRESENT. DO NOT TOUCH THE BATTERY TERMINALS.

Check Battery Connections

WARNING! Improper handling of high voltage wiring, batteries or control systems could result in serious injury or death by electric shock. Only qualified technicians should repair or access high voltage wiring, battery packs and associated systems.

Inspect and clean battery terminal connections monthly. Carefully remove corrosion with a stiff wire brush. Coat battery terminals with dielectric grease or petroleum jelly. Using an insulated wrench, torque bolts to 8 lb-ft (10.8 Nm).

Batteries

Battery Inspections/Maintenance

Check Battery Cables and Wiring

Check the battery compartment for any signs of worn insulation, frayed cables or damaged cable ends. If found, see your authorized GEM dealer or other qualified service person for service before operating.

WARNING! If battery cable ends are damaged or corroded, they should be replaced or cleaned as necessary. Failure to do so may cause them to overheat during operation, possibly leading to fire, which may result in serious injury or death.

Check Battery Hold-Down Bars

Battery hold-down bars should be snug to keep batteries from moving while the vehicle is in motion, but not so tight as to crack or buckle the battery case. Torque fasteners to 9.5 lb-ft (13 Nm).

MAINTENANCE

Batteries

Battery Inspections/Maintenance

Battery Replacement

Battery and electrical system service must be performed only by an authorized service facility. When battery replacement is necessary, your authorized GEM dealer can provide this service.

NOTICE: Always install batteries of the exact type and make originally supplied with the vehicle to prevent damage to the vehicle's electrical system.

WARNING! Handling batteries and electrical components improperly can result in serious injury or death. Do not attempt to remove batteries or battery cables. It is essential, when replacing the cables on the batteries, that the positive cable is attached to the positive post (+) and the negative cable is attached to the negative post (-). Battery posts are identified on the battery case as positive (+) and negative (-). Your authorized GEM dealer can provide battery-related service.

Batteries

Battery Inspections/Maintenance

Battery Care During Storage

When the vehicle will not be used for a period of 10 days or longer, check battery water levels (flooded type batteries) and perform one of the battery storage procedures listed in the chart below.

Battery Storage Options	
Storage Period	Charging Procedure
Less than 10 days	Fully charge the batteries, park the vehicle and turn the ignition key off. The battery will lose some of its charge during this period.
10 days to 24 weeks	Leave the charger connected. See page 62.
Indefinitely or Unknown	Disconnect the charger and arrange for monthly charging.

MAINTENANCE

Batteries

Battery Inspections/Maintenance

Flooded Battery Fluid Check

On flooded batteries, check the fluid level often. *Add only distilled water.* Tap water contains minerals that are harmful to a battery.

Accessory watering systems are available for 12-volt and 6-volt flooded batteries. See your authorized GEM dealer for more information.

NOTICE: Never charge batteries if plates are exposed above the water level.

Unless the plates are exposed before charging, distilled water should be added to a battery *after* charging. If the plates are exposed, add just enough water to cover the plates. Fully charge the batteries, then recheck the fluid level.

Maintain the fluid level between the battery plates and the bottom of the fill well. Do not overfill.

WARNING! The fluid in an overfilled battery may boil over and cause electrolyte to spill.

(continued on next page)

Batteries

Battery Inspections/Maintenance

Flooded Battery Fluid Check

Inspect the fluid level of each battery.

1. Remove one of the fill well caps.

Tip: The battery plates should be visible when looking into the fill well. Use a flashlight if necessary.

2. View the fluid level.

Tip: If the level is below the plates, add just enough distilled water to cover the plates. Fully charge the batteries, then recheck the fluid level.

3. Maintain the fluid level between the battery plates and the bottom of the fill well. Add distilled water as needed. Do not overfill. Reinstall the fill well cap securely.

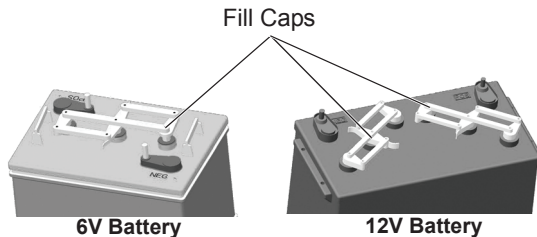

MAINTENANCE

Batteries

Battery Inspections/Maintenance

Flooded Battery Cleaning

NOTICE: Do not allow cleaning solution or tap water to enter the batteries. Before cleaning, make sure all battery fill well caps are installed securely.

1. Remove corrosion with a stiff wire brush.
2. Wash the terminals and tops of the batteries with a solution of one tablespoon baking soda and one cup water. Rinse well with tap water and dry off with clean shop towels.
3. Make sure battery terminals are tight. Use an insulated wrench to tighten as needed.
4. Allow battery terminals to dry, then coat the terminals with dielectric grease or petroleum jelly, or spray them with battery anti-corrosion spray.

Batteries

Battery Inspections/Maintenance

Flooded Battery Disposal

Lead-acid batteries can be recycled. Return whole scrap batteries to a distributor, manufacturer or lead smelter for recycling. For neutralized spills, place residue in acid-resistant containers with absorbent material, sand or earth and dispose of in accordance with local, state and federal regulations for acid and lead compounds. Contact local and/or state environmental officials regarding disposal information. You can also contact GEM Customer Service for information. See page 5.

MAINTENANCE

Cleaning and Storage

Cleaning Windshields, Windows and Solar Panels

We recommend using *GEM Windshield Cleaner and Protectant* to remove normal dust and dirt. A liquid household glass cleaner can also be used. To remove oil, grease or road tar, use isopropyl alcohol, then wash these surfaces with water. Dry gently with a soft cloth or chamois.

NOTICE: Be very careful when cleaning acrylic surfaces as they can be scratched or damaged. Do not use a cleaner with an abrasive, a combination cleaner and wax or any solvent that contains ethyl or methyl alcohol. Do not use products containing ammonia, soaps, or abrasives. Never use gasoline or cleaning solvent. These products scratch or destroy acrylic surfaces.

Cleaning and Storage

Cleaning Seats

GEM Foaming All Surface Cleaner can be used to clean the seats. Rubbing seats with warm water and a clean, damp cloth will also remove dirt. Substances such as tar, asphalt and other soils will stain if not removed quickly. Use a clean cloth and solvent type vinyl cleaner, then wash the area thoroughly with a damp cloth and mild liquid detergent. Rinse with cool water.

Cleaning the Interior

Use mild liquid detergent and warm water to clean the interior. Remove detergent or deposits with a clean, damp cloth.

NOTICE: Do not spray the interior of your vehicle. Liquids can damage electrical components and the circuit board. Handle liquids with care. Do not spray water directly into the upper or lower console.

MAINTENANCE

Cleaning and Storage

Cleaning the Exterior

The best way to preserve your vehicle's finish is to wash the vehicle regularly. Use *GEM Fiberglass Plastic and Rubber Restorer* or mild liquid detergents. Do not use strong soaps or chemical detergents. Rinse promptly. Dry the finish with a soft, clean chamois or towel to avoid surface scratches and water spotting.

Tip: To prevent spotting, avoid washing the vehicle in direct sunlight.

Protection From the Elements

Prolonged exposure to sunlight may deteriorate the exterior and interior finish. Park the vehicle in a garage or similar structure, or cover the vehicle with a GEM vehicle cover.

Cleaning and Storage

Storage Tips

Clean the Exterior

Make any necessary repairs and clean the vehicle as recommended.

Inspect and Lubricate

Inspect all cables and lubricate all areas of the vehicle as recommended in the Periodic Maintenance Chart beginning on page 98.

Check Fluid Levels

Inspect the fluid levels. Add or change fluids as recommended. Change brake fluid every two years and any time the fluid looks dark or contaminated.

MAINTENANCE

Cleaning and Storage

Storing the Vehicle

Any time the vehicle will be parked for more than 10 days, follow the recommended storage procedures:

1. Make any necessary repairs and clean the vehicle. See page 128.
2. Clean the batteries. See pages 120 and 126.
3. Prepare the batteries for storage. See page 123.

NOTICE: Batteries can be permanently damaged (and the warranty voided) if allowed to remain 30 days or more with low charge. Fully charge batteries before storing. In hot climates, battery self-discharge will increase. In cold climates, batteries could freeze if not properly charged.

4. Store the vehicle out of the sun in a cool, dry place.
5. Be sure the storage area is well ventilated.
6. Turn the key off.
7. Verify that tire pressure is at specification.
8. Block the wheels to prevent rolling.

Cleaning and Storage

Storing the Vehicle

WARNING! Do not cover the vehicle while the charger is connected. Dangerous levels of hydrogen gas could accumulate.

9. If the vehicle is not connected to the charger, disconnect the main power connector first, then disconnect any electrical accessory connections, then disconnect the negative cable from the 12-volt battery (if equipped), then disconnect the negative terminal from the main battery pack. See page 53. Cover the vehicle with a genuine GEM vehicle cover. Do not use plastic or coated materials. They do not allow enough ventilation to prevent condensation, and may promote corrosion and oxidation.

Removal from Storage

1. Inspect all battery connections. Verify that batteries are fully charged.
2. Verify that tire pressure is at specification.
3. Perform the pre-ride inspection. See page 88.
4. Inspect and verify the tightness of the bolts, nuts and other fasteners.

SPECIFICATIONS

	GEM e2	GEM e4
Dimensions		
Dry Weight	1200 lbs. (544 kg)	1350 lbs. (612 kg)
Length	103 in. (262 cm)	135 in. (343 cm)
Width	55.5 in. (141 cm)	55.5 in. (141 cm)
Height	73.1 in. (186 cm)	73.1 in. (186 cm)
Wheelbase	69 in. (175 cm)	101 in. (257 cm)
Turning Circle/Radius	150 in. (381 cm)	207 in. (526 cm)
Load Capacity		
Payload Capacity (occupants, cargo, options)	800 lbs. (363 kg)	1150 lbs. (521.6 kg)
Gross Vehicle Weight Rating (GVWR) (page 22)	2000 lbs. (907 kg)	2500 lbs. (1134 kg)
Gross Axle Weight Rating (GAWR), Front and Rear	1280 lbs. (581 kg)	1600 lbs. (726 kg)
Seating	2	4

SPECIFICATIONS

	GEM e2	GEM e4
Performance		
Motor	5 kW (optional 6.5 kW) AC electric	
Motor peak	13.3 kW (optional 18.5 kW)	
Controller	Sevcon 450A AC Controller	
Maximum speed	25 MPH (40 km/h)	
Range	Varies with conditions	
Drive System	17.05:1 Single speed	
On-board charger	Standard 1 kW, 120/240V input (optional 3 kW or 6 kW, SAE J1772)	
Brake System		
Brakes	4-Wheel hydraulic brakes, disc front, drum rear	
Park Brake	Dash-mounted lever-activated mechanical park brake	
Front suspension	MacPherson Strut	
Rear suspension	Independent w/coil over shock	
Tires	Street rated 13-inch Steel 4.5-inch ET11 155/80R13 (Optional 14-inch Aluminum 4.5-inch ET11 165/70R14)	
Tire pressure	35 psi (241 kPa)	

SPECIFICATIONS

	GEM eL XD	GEM e6[®]
Dimensions		
Dry Weight	1585 lbs. (720 kg)	1696 lbs. (769 kg)
Length	145.5 in. (370 cm)	167 in. (424 cm)
Width	55.5 in. (141 cm)	55.5 in. (141 cm)
Height	73.1 in. (186 cm)	73.1 in. (186 cm)
Wheelbase	114 in. (289.6 cm)	133.5 in. (339 cm)
Turning Circle/Radius	233 in. (592 cm)	264 in. (671 cm)
Load Capacity		
Payload Capacity (occupants, cargo, options)	1415 lbs. (642 kg)	1304 lbs. (591 kg)
Gross Vehicle Weight Rating (GVWR) (page 22)	3000 lbs. (1360.8 kg)	3000 lbs. (1360.8 kg)
Gross Axle Weight Rating (GAWR), Front and Rear	1920 lbs. (871 kg)	1920 lbs. (871 kg)
Seating	2	6

SPECIFICATIONS

	GEM eL XD	GEM e6[®]
Performance		
Motor	6.5 kW AC electric	
Motor peak	18.5 kW	
Controller	Sevcon 450A AC Controller	
Maximum speed	25 MPH (40 km/h)	
Range	Varies with conditions	
Drive System	17.05:1 Single speed	
On-board charger	Standard 1 kW, 120/240V input (optional 3 kW or 6 kW, SAE J1772)	
Brake System		
Brakes	4-Wheel hydraulic brakes, disc front, drum rear	
Park Brake	Console-mounted lever-activated mechanical park brake	
Front suspension	MacPherson Strut	
Rear suspension	Independent w/coil over shock	
Tires	Street rated 13-inch Steel 4.5-inch ET11 155/80R13 (Optional 14-inch Aluminum 4.5-inch ET11 165/70R14)	
Tire pressure	35 psi (241 kPa)	

WARRANTY

LIMITED WARRANTY

POLARIS Industries Inc., 2100 Highway 55, Medina, MN 55340, gives a TWO-YEAR/8,000-MILE (12,900 km), whichever comes first, LIMITED WARRANTY on all components (except batteries) of your GEM vehicle against defects in material or workmanship. Mileage is unlimited for the first 6 months of the vehicle warranty. Any time after month 6, the vehicle warranty expires at 8,000 miles (12,900 km) or at the end of the two-year period, whichever comes first. This warranty covers the parts and labor charges for repair or replacement of defective parts and begins on the date of purchase by the original retail purchaser. This warranty is transferable to another consumer during the warranty period through a GEM dealer, but any such transfer will not extend the original term of either warranty. The duration of this warranty and/or the battery warranty may vary by international region based upon local laws and regulations.

WARRANTY

LEAD ACID BATTERY PACK LIMITED WARRANTY

Battery coverage in this Limited Warranty begins on the date of purchase by the original retail purchaser and continues for twenty-four months or 8,000 miles (12,900 km), whichever comes first. Mileage is unlimited for the first 6 months of the battery warranty. Any time after month 6, the battery warranty expires at 8,000 miles (12,900 km) or at the end of the two-year period, whichever comes first. During this time period, Polaris warrants your vehicle's batteries against defects in materials or workmanship. After the first six months in service, a defective battery will be replaced on a manufacturer/customer shared basis provided that the warranty limit of 8,000 miles (12,900 km) has not yet occurred. Review the table below for guidelines.

TERM FOR VEHICLES WITH LESS THAN 8,000 MILES (12,900 km)	WARRANTY COVERAGE FOR LEAD ACID BATTERIES DEEMED DEFECTIVE BY GEM
Purchase Date - 6th Month of Service	100% of the cost of an approved GEM battery at a GEM dealer
7th - 12th Month of Service	75% of the cost of an approved GEM battery at a GEM dealer
13th - 18th Month of Service	50% of the cost of an approved GEM battery at a GEM dealer
19th - 24th Month of Service	25% of the cost of an approved GEM battery at a GEM dealer

WARRANTY

LI-ION BATTERY PACK LIMITED WARRANTY

POLARIS Industries Inc. gives a FIVE-YEAR/30,000-MILE (48,300 km) LIMITED parts and labor warranty on the battery pack against defects in material or workmanship on your GEM vehicle. The FIVE-YEAR/30,000-MILE (48,300 km) term begins on the purchase date, is fully transferable and has no deductible. The term ends 5 years after purchase, or after 30,000 miles (48,300 km), whichever occurs first.

All batteries experience some reduction in capacity/range over time. A capacity/range reduction of 30% or less during the battery warranty period does not constitute a defect. Any capacity/range reduction-based claim must be confirmed by an authorized dealer and approved by Polaris to be eligible for coverage. In addition to the WARRANTY COVERAGE EXCLUSIONS listed below, the battery warranty also excludes failure, damage or capacity loss to the batteries caused by neglect, lack of charging or not following the recommended maintenance schedule outlined in the Owner's Manual.

WARRANTY

REGISTRATION

At the time of sale, the Warranty Registration Form must be completed by your dealer and submitted to Polaris within three days. Upon receipt of this registration, Polaris will record the registration for warranty. No verification of registration will be sent to the purchaser as the copy of the Warranty Registration Form will be the warranty entitlement. If you have not signed the original registration and received the customer copy, please contact your dealer immediately. **NO WARRANTY COVERAGE WILL BE ALLOWED UNLESS YOUR VEHICLE IS REGISTERED WITH Polaris.** Initial dealer preparation and set-up of your vehicle is very important in ensuring trouble-free operation. Purchasing a vehicle in the crate or without proper dealer set-up will void your warranty coverage.

WARRANTY

WARRANTY COVERAGE AND EXCLUSIONS FOR LIMITED WARRANTY AND BATTERY PACK WARRANTY

LIMITATIONS OF WARRANTIES AND REMEDIES

This Polaris limited warranty excludes any failures that are not caused by a defect in material or workmanship. **THIS WARRANTY DOES NOT COVER CLAIMS OF DEFECTIVE DESIGN.** This warranty also does not cover acts of God, accidental damage, normal wear and tear, abuse or improper handling. This warranty also does not cover any vehicle, component, or part that has been altered structurally, modified, neglected, improperly maintained or used for racing, competition or purposes other than for which it was designed, or for any damages which occur during trailer transit or as a result of unauthorized service or the use of unauthorized parts.

This warranty excludes damages or failures resulting from: improper lubrication; corrosion, surface imperfections caused by external stress, heat, cold or contamination; operator error or abuse; improper component alignment, tension, adjustment or altitude compensation; snow, water, dirt or other foreign substance contamination; improper maintenance; modified components; use of aftermarket or unapproved components, accessories or attachments; unauthorized repairs; or repairs made after the warranty period expires or by an unauthorized repair center.

LIMITATIONS OF WARRANTIES AND REMEDIES

This warranty excludes damages or failures caused by abuse, accident, fire, explosion, or any other cause other than a defect in materials or workmanship and provides no coverage for consumable components, general wear items, or any parts exposed to friction surfaces, stresses, environmental conditions and/or contamination for which they were not designed or not intended, including but not limited to the following items:

- Wheels and tires
- Suspension components
- Brake components
- Seat components
- Clutches and components
- Steering components
- Batteries
- Bushings/Bearings
- Finished and unfinished surfaces
- Upholstery
- Lubricants
- Sealants
- Hydraulic components and fluids
- Circuit breakers/Fuses
- Electronic components
- Light bulbs/Sealed beam lamps

WARRANTY

LIMITATIONS OF WARRANTIES AND REMEDIES

The battery coverage included in this warranty provides no coverage for:

- Batteries that fail due to lack of battery maintenance, over-charging, under-charging, abuse or neglect
- Batteries that fail due to fire, wreckage, explosion, or freezing
- Broken batteries
- Batteries damaged by defective chargers
- Batteries to which an additive is added
- Batteries which have been improperly stored and allowed to discharge
- Any battery pack with a mixture of code dates or with other manufacturer's products
- Any battery improperly installed or with loose or corroded hardware

This warranty provides no coverage for personal loss or expense, including mileage, transportation costs, hotels, meals, shipping or handling fees, product pick-up or delivery, replacement rentals, loss of product use, loss of profits, or loss of vacation or personal time.

WARRANTY

LIMITATIONS OF WARRANTIES AND REMEDIES

The exclusive remedy for breach of this warranty shall be, at Polaris's sole option, repair or replacement of any defective materials, components or products. THE REMEDIES SET FORTH IN THIS WARRANTY ARE THE ONLY REMEDIES AVAILABLE TO ANY PERSON FOR BREACH OF THIS WARRANTY. POLARIS SHALL HAVE NO LIABILITY TO ANY PERSON FOR INCIDENTAL, CONSEQUENTIAL OR SPECIAL DAMAGES OF ANY DESCRIPTION, WHETHER ARISING OUT OF EXPRESS OR IMPLIED WARRANTY OR ANY OTHER CONTRACT, NEGLIGENCE, OTHER TORT OR OTHERWISE. THIS EXCLUSION OF CONSEQUENTIAL, INCIDENTAL, AND SPECIAL DAMAGES IS INDEPENDENT FROM AND SHALL SURVIVE ANY FINDING THAT THE EXCLUSIVE REMEDY FAILED OF ITS ESSENTIAL PURPOSE.

THE IMPLIED WARRANTY OF FITNESS FOR A PARTICULAR PURPOSE IS EXCLUDED FROM THIS LIMITED WARRANTY. ALL OTHER IMPLIED WARRANTIES (INCLUDING BUT NOT LIMITED TO THE IMPLIED WARRANTY OF MERCHANTABILITY) ARE LIMITED IN DURATION TO THE ABOVE TWO-YEAR/8,000-MILE (12,900 km) OR FIVE-YEAR/30,000-MILE (48,300 km) WARRANTY PERIOD. POLARIS DISCLAIMS ALL EXPRESS WARRANTIES NOT INCLUDED IN THIS WARRANTY STATEMENT. SOME STATES DO NOT PERMIT THE EXCLUSION OR LIMITATION OF INCIDENTAL OR CONSEQUENTIAL DAMAGES OR ALLOW LIMITATIONS ON THE DURATION OF IMPLIED WARRANTIES, SO THE ABOVE LIMITATIONS OR EXCLUSIONS MAY NOT APPLY TO YOU IF INCONSISTENT WITH CONTROLLING STATE LAW.

WARRANTY

HOW TO OBTAIN WARRANTY SERVICE

If your vehicle requires warranty service, you must take it to a GEM Servicing Dealer. When requesting warranty service you must present your copy of the Warranty Registration Form to the dealer. (THE COST OF TRANSPORTATION TO AND FROM THE DEALER MAY BE YOUR RESPONSIBILITY). POLARIS suggests that you use your original selling dealer; however, you may use any GEM Servicing Dealer to perform warranty service.

In the country where your product was purchased:

Warranty or Service Bulletin repairs must be done by an authorized GEM dealer. If you move or are traveling within the country where your product was purchased, Warranty and Service Bulletin repairs may be requested from any authorized GEM dealer that sells the same line as your product.

Outside the country where your product was purchased:

If you are traveling temporarily outside the country where your product was purchased, you should take your product to an authorized GEM dealer. You must show the dealer photo identification from the country of the selling dealer's authorized location as proof of residence. Upon residence verification, the servicing dealer will be authorized to perform the warranty repair.

HOW TO OBTAIN WARRANTY SERVICE

If you move:

If you move to another country, be sure to contact GEM Customer Assistance and the customs department of the destination country before you move. Product importation rules vary considerably from country to country. You may be required to present documentation of your move to GEM in order to continue your warranty coverage. You may also be required to obtain documentation from GEM in order to register your product in your new country. You should warranty register your product at a local GEM dealer in your new country immediately after you move to continue your warranty coverage and to ensure that you receive information and notices regarding your vehicle.

If you purchase from a private party:

If you purchase a GEM vehicle from a private party, to be kept and used outside of the country in which the product was originally purchased, all warranty coverage will be denied. You must nonetheless register your product under your name and address with a local GEM dealer in your country to ensure that you receive safety information and notices regarding your product.

WARRANTY

Exported Products

EXCEPT WHERE SPECIFICALLY REQUIRED BY LAW, THERE IS NO WARRANTY OR SERVICE BULLETIN COVERAGE ON THIS PRODUCT IF IT IS SOLD OUTSIDE THE COUNTRY OF THE SELLING DEALER'S AUTHORIZED LOCATION. This policy does not apply to products that have received authorization for export from POLARIS. Dealers may not give authorization for export. You should consult an authorized dealer to determine this product's warranty or service coverage if you have any questions. This policy does not apply to products registered to government officials or military personnel on assignment outside the country of the selling dealer's authorized location. This policy does not apply to Safety Bulletins.

Notice

If your product is registered outside of the country where it was purchased and you have not followed the procedure set above, your product will no longer be eligible for warranty or service bulletin coverage of any kind, other than safety bulletins. Products registered to government officials or military personnel on assignment outside of the country where the product was purchased will continue to be covered by the Limited Warranty.

Please work with your dealer to resolve any warranty issues. Should your dealer require any additional assistance, they will contact the appropriate person at POLARIS.

This warranty gives you specific legal rights, and you may also have other rights which vary from state to state or in different countries. If any of the above terms are void because of federal, state, local law, all other warranty terms will remain in effect.

WARRANTY

GEM Customer Service

Phone: 855-RIDEGEM (855-743-3436)

Web: www.gemcar.com

Roadside Assistance

Emergency Roadside Assistance is available to you 24 hours a day, 365 days a year, throughout the United States and Canada during the term of the manufacturer's warranty. This service is available through ROAD AMERICA*. It includes towing for up to 50 miles from your vehicle's location and other benefits. Some limitations and exclusions apply. Please call 866-360-4216 to get more information or to request assistance. When calling, please refer to the last 8 digits of your VIN when ROAD AMERICA asks for your contract number.

*All of the emergency roadside assistance services are provided by Brickell Financial Services-Motor Club, Inc. d/b/a Road America Motor Club, administrative offices at 7300 Corporate Center Drive, Suite 601, Miami, Florida 33126. (For Mississippi and Wisconsin customers, services are provided by Brickell Financial Services-Motor Club, Inc. For California customers, services are provided by Road America Motor Club, Inc. d/b/a Road America Motor Club.)

MAINTENANCE LOG

Use the following chart to record periodic maintenance.

DATE	MILES (KM) OR HOURS	TECHNICIAN	SERVICE PERFORMED / COMMENTS

MAINTENANCE LOG

DATE	MILES (KM) OR HOURS	TECHNICIAN	SERVICE PERFORMED / COMMENTS

MAINTENANCE LOG

DATE	MILES (KM) OR HOURS	TECHNICIAN	SERVICE PERFORMED / COMMENTS

INDEX

0-9

- 12-Volt Accessory Installation . . . 72
- 12-Volt Terminal Board 72

A

- Accelerator Pedal 58
- Accessory Backs 82-83

B

- Batteries** 60-72, 116-127
 - Battery Pack 60
 - Charging 63-67
 - Charging, Alternate Method 68-69
 - Cleaning (Flooded) 126
 - Configurations 118
 - Disposal (Flooded) 127
 - Fluid Check (Flooded) . . . 124-125
 - Handling Precautions 70-71
 - Inspections 120-127
 - Locations 119
 - Main Power Connector 53-56
 - Monthly Maintenance . . . 120-127
 - On-Board Charger 62-63
 - Performance Tips 61
 - Replacement 122
 - Storage 123

B

- Brake Lever, Park 59
- Brake Pedal 57
- Brakes** 100-102
 - Brake Fluid 100-101
 - Brake Inspection 102
- Bumpers, Optional 85

C

- Charge Receptacle 64, 67
- Cleaning**
 - Exterior 130
 - Interior 129
 - Seats 129
 - Solar Panel 128
 - Windshield and Windows . . . 128
- Cleaning and Storage 128-133
- Clock Resetting (MFD) 49
- Console 32-40
- Contact Us 5, 149
- Control Lever, Left 36-37
- Control Lever, Right 38-40
- Customer Service 5, 149

D

- Dash Removal/Installation . . 104-105
- Direction Selection Switch 38-39
- Display Units, Standard/Metric . . 47
- Dome Light 73
- Doors 74
- Driving in Reverse 92
- Driving on Slippery Surfaces 93
- Driving Procedure 90-91

E

- Electrical Components 33
- Equipment Modifications 24

F

- Fan/Heater 85
- Fluid Levels During Storage 131
- Fluid, Brake 100-101
- Fuse/Relay Recommendations . . . 107
- Fuses and Relays 106

INDEX

G

- Gauge, Digital/Analog 41-52
- Glove Box 35
- Grab Handle Package 83
- Gross Vehicle Weight Rating . . . 22-23
- GVWR 22-23

H

- Hazard Signal Switch 38
- Headlight Beam Adjustment 114-115
- Headlight High/Low Switch 37
- Headlight On/Off Switch 37
- Headlight Replacement 113
- Heater/Fan 85
- Hitches 85
- Hood 84
- Horn Switch 37

I

- Indicator Lamps 42-43

K

- Key Switch 34

L

- Lights 113-115
 - Dome Light 73
 - Front Turn Signal 113
 - Headlight Adjustment 114
 - Headlight Beam Adjustment . 115
 - Headlight Replacement 113

M

- Main Power Connector 53-56
- Maintenance Precautions 31
- Maintenance, Periodic 98-99
- Manufacturer's Label 9-11
- Metric Display 47
- Mode Button 41
- Modifications 24

O

- On-Board Charger 62-63
- Operator Safety 17-31

P

- Park Brake Lever 59
- Parking on an Incline 95
- Parking the Vehicle 94
- Periodic Maintenance Chart . . . 98-99
- Pre-Ride Inspection 88-89

R

- Rear Accessory Backs 82-83
- Removing Vehicle from Storage . 133
- Resetting the Clock (MFD) 49
- Reverse Operation 92
- Rider Information Center 44-52

S

- Safety Labels 12-16
- Safety Symbols 7
- Seat Adjustment 75
- Seat Belt Inspection 80
- Seat Belt Safety Tips 79
- Seat Belt, Proper Use 77-78
- Seat Belts 76-80

INDEX

S

Signal Words	7
Solar Panel	81
Speedometer	41
Steering Column, Adjustable Tilt	86
Steering Wheel Adjuster	33
Steering Wheel Inspection	103
Stereo System	81
Storage	128-133
Storage Tips	131
Storage, Removal	133
Storing the Vehicle	132-133

Switches

Direction Selection Switch	38-39
Hazard Signal Switch	38
Headlight High/Low Switch	37
Headlight On/Off Switch	37
Horn Switch	37
Key Switch	34
Mode Button	41
Turn Signal Switch	36

T

Tires	108-112
Tire Pressure	108
Tread Depth	109
Wheel Installation	112
Wheel Nut Torque	109
Wheel Removal	110-111
Towing Loads (eL XD)	96
Traction Battery Configurations	118
Traction Battery Locations	119
Transporting the Vehicle	97
Turn Signal Light Replacement	
Front	113
Turn Signal Switch	36

U

USB Port	73
----------	----

V

Vehicle Information Label	9-11
---------------------------	------

W

Warning Symbols	7
Weight Capacity	22-23
Wheel Installation	112
Wheel Nut Torque	109
Wheel Removal	110-111
Windshield Washer	87
Windshield Wiper	40

Z

Zero Speed Detection Feature	35
------------------------------	----



For your nearest GEM dealer,
call 855-RIDEGEM (855-743-3436)
or visit www.gemcar.com
Polaris Industries Inc.
2100 Highway 55
Medina, MN 55340

Part No. 9925677 Rev 01
Printed in USA

