

HermanMiller
Overlay™



Transforming the open floorplan



Overlay

Designed by Ayse Birsal and Bibi Seck

Designed to transform an open floorplan, Overlay is a system of sub-architectural, movable walls intended to help you define your space. Use Overlay to create freestanding rooms, give shape to large open spaces, or simply divide one area from another. Because Overlay is flexible, and can take mere hours to relocate, your office could function as one space today and by tomorrow,

serve a totally different purpose—all without calling the contractor. Designed by Birsal + Seck, Overlay creates visual clarity in open-plan offices, helping people understand where their best work will happen and giving organizations the agility to evolve on the fly.



A small application of Overlay, like a single boundary functioning as a Workshop, can be relocated by two people in about two hours.

Ready for Anything

Designed with adaptable simplicity in mind, Overlay has a select number of parts that you can use to define your space. Use a single boundary to work as a room divider. A three-sided workspace can become a designated area for impromptu meetings or collaborative work. Or, use four Overlay walls to create an enclosed meeting space—complete with a door—that can offer a higher level of visual and acoustical privacy. The addition of a media display, tackable surfaces, Exclave boards, and other tools also allow Overlay to support whatever the day might bring.

Affordable Flexibility

As organizations race to attract talent, rapidly scale, or quickly change course, they don't always have the time, or money, to reconfigure their offices. With just two people and in about two hours, a small application of Overlay can be relocated with minimal disruption to the ecosystem of the office. It comes without the cost of prefabricated walls or burden of traditional construction, so you can avoid the hassle and clean-up period that comes with a renovation while still catering to the needs of the organization's space and people.



Add a sliding glass door to Overlay, and you can offer a higher level of visual and acoustical privacy in the office.



Overlay is customizable so you can match it to the personality of your office and make both the interior and exterior sides of the walls as quiet or as loud as you'd like.

Unique, Customizable Spaces

Designed to live in the “less-is-more” sweet spot, Overlay’s elegant and quiet aesthetic can be turned up or dialed down to reflect the character of your organization. Overlay can be outfitted in a variety of ways with colors, textiles, laminates, glass, markerboards, or your own custom material. The interior and exterior sides of an Overlay wall can share the same look, or, feature a clean façade and a creative back so that the structure can reflect the design of the office on the outside and also reveal the messy vibrancy of the work happening on the inside.

About Ayse Birsal and Bibi Seck

Partners “in life and in work,” Ayse Birsal and Bibi Seck’s resume boasts the likes of Amazon, GE, Herman Miller, Staples, and Toyota, and includes social design work to bring the economic value of design to Senegal and other parts of Africa. Despite the diversity of their portfolio, Birsal points out that, “the end user is always at the center of our thinking.” The pair uses their proprietary creative process, Deconstruction:Reconstruction, or DE:RE, to co-design with their clients to “break preconceptions, shift the point of view, and solve to create new value within existing constraints.”



Ayse Birsal and Bibi Seck



Here, Overlay works as a semi-enclosed meeting space that allows people to see in and out of the space with just enough visual privacy to concentrate on the task at hand.

Options

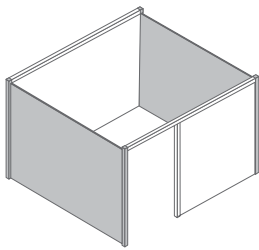

Performance Wall

This workhorse wall holds and distributes power and data and can mount a digital display. It always needs to be fully cladged with a solid material.

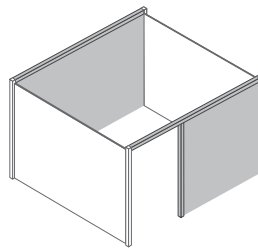

Spanner Zone

Configure this zone to be as open or closed off to the office as you need. Outfit it in solid cladding, porous materials, or your own custom solution.

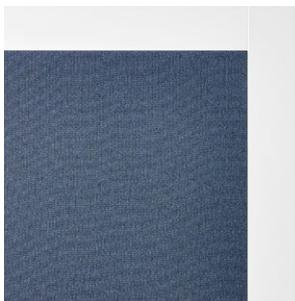

Fabric
Performance Wall
Spanner Zone

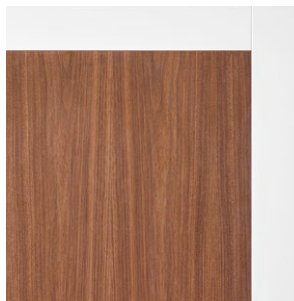

Laminate
Performance Wall
Spanner Zone



Markerboard
Performance Wall
Spanner Zone

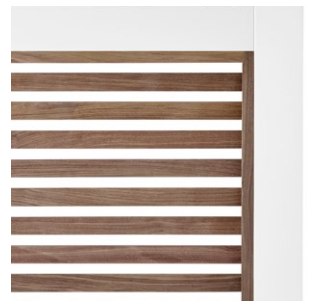

Wood Slats
Spanner Zone

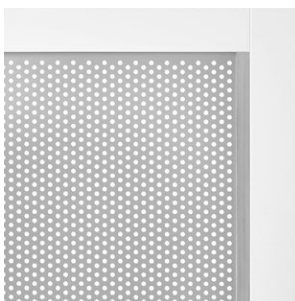

Perforated Metal
Spanner Zone

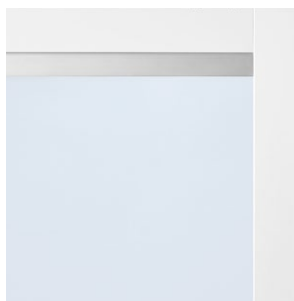

Glass
Spanner Zone



Curtain Track
Spanner Zone

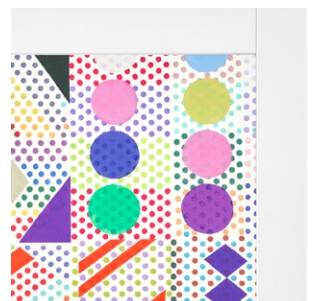

Custom Solution
Spanner Zone

Dimensions

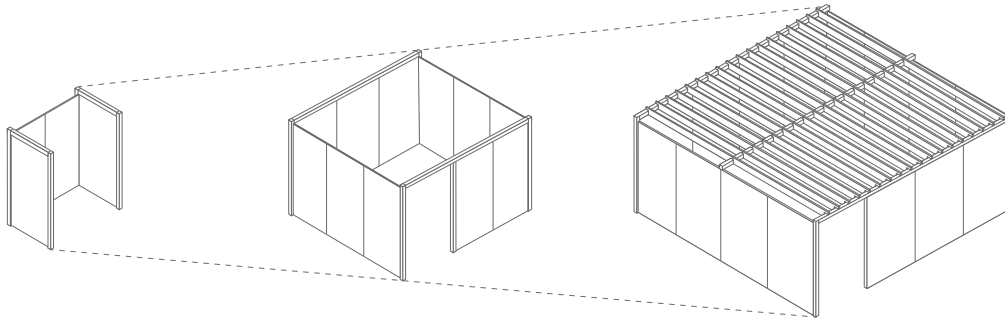

Size: from 6' x 4' to 16' x 16' in 12" increments
Height without Trellis: 7' 6"
Height with Trellis: 7' 10"

Details



Trellis



Linear Light

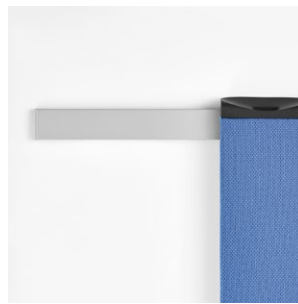

Lite Rail



Monitor Mount

For more information, please visit hermanmiller.com or call 888 443 4357.

HermanMiller and  are among the registered trademarks of Herman Miller, Inc.
Overlay is among the trademarks of Herman Miller, Inc.

Printed in USA. Please recycle.
© 2018 Herman Miller, Inc., Zeeland, Michigan
All rights reserved.