

Operation Manual

Desktop Video

Blackmagicdesign 



Mac OS X™

Windows™

Linux™

October 2011

2 Welcome



Welcome to Desktop Video!

We hope you share our dream for the television industry to become a truly creative industry by allowing anyone to have access to the highest quality video.

Previously high end television and post production required investment in millions of dollars of hardware, however with Blackmagic video hardware, even 10 bit uncompressed is now easily affordable. We hope you get years of use from your new UltraStudio, DeckLink, Multibridge or Intensity and have fun working with some of the world's hottest television and design software!

This instruction manual should contain all the information you'll need on installing your Blackmagic video hardware. If you're installing a PCI Express card, it's always a good idea to ask a technical assistant for help if you have not installed hardware cards into computers before. As Blackmagic video hardware uses uncompressed video and the data rates are quite high, you'll need fast disk storage and a high-end computer.

We think it should take you approximately 10 minutes to complete installation. Before you install Blackmagic video hardware, please check our website at www.blackmagic-design.com and click the support page to download the latest updates to this manual and Desktop Video driver software. Lastly, please register your Blackmagic video hardware when downloading software updates. We would love to keep you updated on new software updates and new features. Perhaps you can even send us your latest show reel of work completed on your Blackmagic video hardware and any suggestions for improvements to the software. We are constantly working on new features and improvements, so we would love to hear from you!

A handwritten signature in black ink that reads "Grant Petty".

Grant Petty
CEO Blackmagic Design

04 Getting Started

Introducing Desktop Video	04
Your Computer's System Requirements	04
How to Install your Blackmagic Video Hardware	05
Installing a Blackmagic PCIe card	05
Before connecting USB 3.0 hardware to your computer	06
Connecting to your Windows USB 3.0 computer	06
Connecting to your Mac computer with Thunderbolt™	06
Install the Blackmagic Design Software	07
Installing Desktop Video Drivers on Mac OS X	07
Installing Desktop Video Drivers on Windows 7	08
Installing Desktop Video Drivers on Linux	09
Using Blackmagic System Preferences	11

18 Capturing and Playing back Video

Video Playback test using Blackmagic Media Express	18
Video Capture test using Blackmagic Media Express	18

19 Using your Favorite Editing Software

Adobe After Effects CS5 and CS5.5	19
Adobe Photoshop CS5 and CS5.5	20
Adobe Premiere Pro CS5 and CS5.5	21
Apple Final Cut Pro 7	24
Apple Final Cut Pro X	26
Avid Media Composer 6	28

32 Blackmagic Media Express

What is Media Express?	32
Capturing Video and Audio files	34
Playing back Video and Audio files	40
Browsing Media	41
Editing Video and Audio files to Tape	45

46 Blackmagic Disk Speed Test

49 Help

50 Developer Information

Blackmagic 2K Format	51
----------------------	----

54 Connection Reference Guide

67 Warranty Information



4 Getting Started



Introducing Desktop Video

Blackmagic Design's Desktop Video software includes drivers, plug-ins and applications for your UltraStudio, DeckLink, Multibridge or Intensity. You can use Desktop Video software by itself or else work directly within video software from companies including Adobe, Apple and Avid.

This manual takes you through the computer system requirements, how to install your video hardware and software, and how to use it with software from Blackmagic Design, Adobe, Apple and Avid. Connection diagrams and reference information for developers can be found at the back of the manual.

Your Computer's System Requirements

UltraStudio, DeckLink, Multibridge and Intensity are all designed to work with the highest quality uncompressed video. This high quality is exciting but also very demanding for your computer and disk storage. We recommend the following minimum computer system configurations.

All platforms require a minimum of 4 GB of RAM for SD, HD and 2K video. PCIe x1 lane cards should work in any slot. PCIe x4 lane cards require a x4 lane or faster PCI Express slot.

Mac OS X

Desktop Video software runs on the latest Snow Leopard and Lion versions of Mac OS X.

An Intel-based Mac Pro computer is required if your Blackmagic video hardware connects to the computer via a PCI Express slot.

An Intel-based Mac computer with a Thunderbolt™ port and cable are required if your Blackmagic video hardware connects to the computer via Thunderbolt.

Windows

Desktop Video runs exclusively on 64-bit versions of Windows 7 with the latest service pack installed.

A USB 3.0 port using a Renesas chipset is required if your Blackmagic video hardware connects to the computer via USB 3.0.

Linux

Desktop Video runs on 32-bit and 64-bit x86 computers running Linux 2.6.23 or higher. Please refer to the release notes for the latest list of supported Linux distributions, package formats and software dependencies.

5 Getting Started

How to Install your Blackmagic video hardware

This section guides you through how to install your Blackmagic video hardware in to your computer.

Installing a card with a fiber optic module can be a little fiddly so we also include some tips on how to do it easily.

If your Blackmagic video hardware connects via USB 3.0, then skip past the "Installing a Blackmagic PCIe card" instructions and go straight to the USB 3.0 section. Blackmagic's USB 3.0 video products require something called "isochronous USB 3.0 support" which is only available on Windows so you won't find instructions for Mac or Linux.

If your Blackmagic video hardware connects via Thunderbolt™, then skip past the "Installing a Blackmagic PCIe card" instructions and go straight to the Thunderbolt section. As Thunderbolt is only found on the latest Apple Mac computers, Blackmagic Design's Thunderbolt™ products are only available on Mac OS X.

Installing a Blackmagic PCIe card

Please review the Adding PCI Express Cards section in your computer user manual for information on how to safely install PCI Express cards, including your DeckLink, Multibrige or Intensity card.

- Step 1.** Remove the power plug from the back of your computer and ensure that you are statically discharged by using an anti-static strap.
- Step 2.** Remove the side cover or chassis cover of your computer to gain access to the PCIe slots.
- Step 3.** Remove your Blackmagic PCIe card from the protective static bag making sure you don't touch the gold connectors on the base of the card. These precautions should be taken when handling any PCI card. If you have a DeckLink Optical Fiber card, the fiber optic module needs to be temporarily removed to allow the card to be manoeuvred into its slot.
- Step 4.** The product box or website should tell you if your Blackmagic PCIe card requires a x1, x4 or x8 lane PCIe slot. Locate a slot in your computer which is this speed or faster.
- Step 5.** Remove the metal port access cover from the desired PCIe slot.
- Step 6.** Insert your Blackmagic PCIe card and ensure that it clicks firmly into place.
- Step 7.** If your Blackmagic PCIe card includes an HDMI bracket, insert the bracket in to a spare PCIe slot. If your computer doesn't have a spare PCIe slot but does have a single-width graphics card, you should be able to insert the HDMI bracket into the spare port usually reserved for a double-width graphics card.
- Step 8.** Secure the card and HDMI bracket with the screws, bracket or clamp.

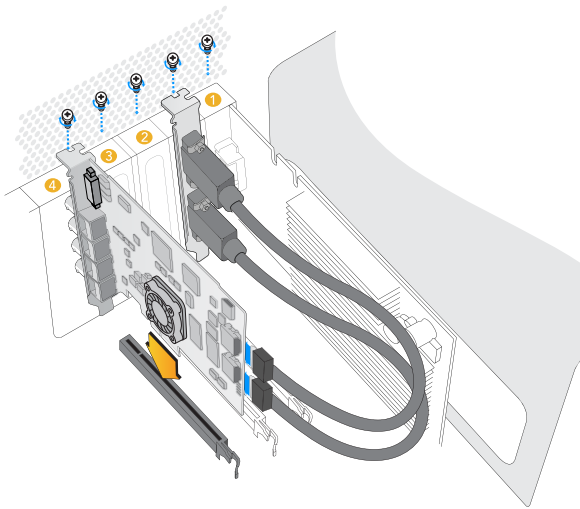

Install any model of Blackmagic PCIe card in a spare slot as shown in the above picture. Some cards include an HDMI bracket, which installs in any spare port, and connects to the rear of the card with the supplied HDMI cables.

6 Getting Started

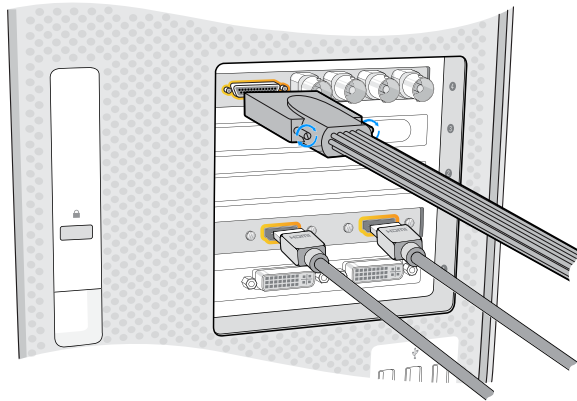

Connect the breakout cable if one is supplied with your model of Blackmagic card. Some card models also include a HDMI bracket as pictured above.

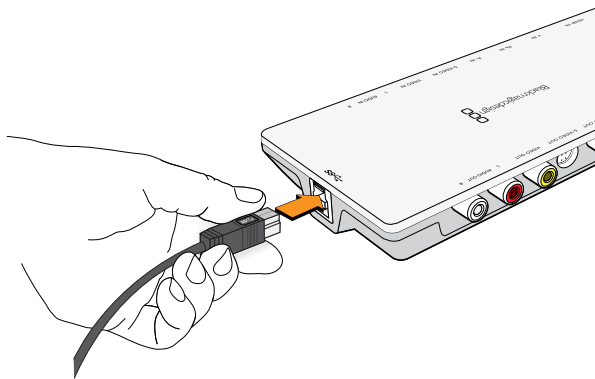

USB 3.0 and Thunderbolt™ products connect to your computer with a single USB 3.0 or Thunderbolt cable.

Step 9. If you have installed an HDMI bracket, loop the included HDMI cables around any other installed cards and plug them into the rear of the DeckLink card.

Step 10. If you have a DeckLink Optical Fiber card, reinsert the fiber optic module into the card.

Step 11. Replace the cover of your computer and connect the breakout cable if one is supplied with your model of Blackmagic card.

Step 12. Reconnect the power and start up the computer.

Before connecting Blackmagic Design USB 3.0 hardware to your computer

It is very important you have installed the latest USB 3.0 software drivers and firmware for your computer before installing your Blackmagic Design hardware. Please visit the computer vendor's website.

Connecting Blackmagic video hardware to your Windows USB 3.0 computer

Step 1. If your Blackmagic video hardware includes an external power supply, connect it to the unit and switch on the power.

Step 2. Connect a SuperSpeed USB 3.0 cable between the unit and a dedicated USB 3.0 port on your computer.

Step 3. If Desktop Video software has previously been installed and offers to update the internal software, click Update and follow any onscreen instructions.

Step 4. Connect the breakout cable if one is supplied with your model of Blackmagic video hardware. The connectors plug in to almost any kind of broadcast and professional video equipment.

Connecting Blackmagic video hardware to your Mac computer with Thunderbolt™

Step 1. If your Blackmagic video hardware includes an external power supply, connect it to the unit and switch on the power.

Step 2. Connect a Thunderbolt cable between the unit and a Thunderbolt port on your computer, or to a Thunderbolt disk array which is attached to your computer.

Step 3. If Desktop Video software has previously been installed and offers to update the internal software, click Update and follow any onscreen instructions.

Step 4. Connect the breakout cable if one is supplied with your model of Blackmagic video hardware. The connectors plug in to almost any kind of broadcast and professional video equipment.

7 Getting Started



Follow install prompts.

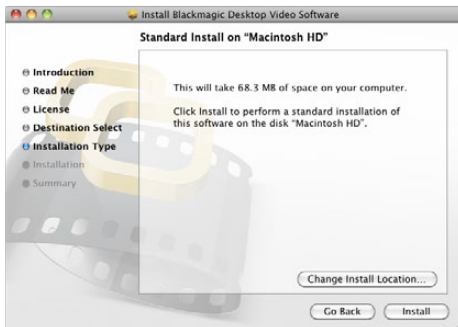

Select Destination.

Install the Blackmagic Design Software

After installing your hardware, the next step is to install the Blackmagic Design Desktop Video software. Please jump to the installation instructions for Mac OS X, Windows and Linux in this section.

Installing Blackmagic Desktop Video Drivers on Mac OS X

Before installing any software you will need administrator privileges.

Step 1. Ensure you have the very latest driver. Visit www.blackmagic-design.com/support

Step 2. Open the "Desktop Video Installer" folder from the disc or downloaded disk image and launch the "Desktop Video Installer" installer.

Step 3. Click Continue, Agree and Install buttons and the software will be installed on your system.

Step 4. Now restart your computer to enable the new software drivers.

Plugins and Applications that are installed

The Desktop Video software installs the following components:

- Blackmagic Desktop Video drivers
- Blackmagic Design system preference
- Blackmagic Design LiveKey
- Blackmagic Media Express
- Blackmagic Multibridge Utility
- Blackmagic QuickTime™ codecs
- Blackmagic Disk Speed Test
- Adobe® Premiere Pro, After Effects, Photoshop presets and plug-ins
- Apple Final Cut Pro™ 7 Easy Setups, presets and enablers
- Avid Media Composer 6 plug-ins

Automatic Updates

After your Mac has restarted, the software will check the Blackmagic video hardware to see what internal software the hardware contains. If the internal software version does not match the driver version, Desktop Video will offer to update the internal software. This is automatic and all you need to do is click OK to start the update. After the internal software has updated, restart your Mac to complete the process.

8 Getting Started

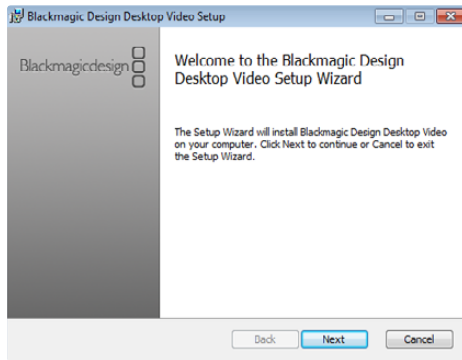

Desktop Video Setup Wizard

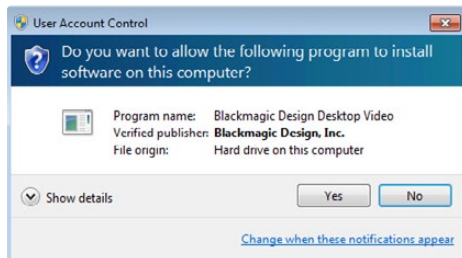

Click "Yes".

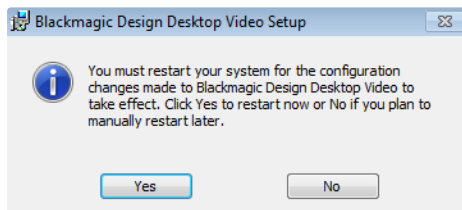

Restart your PC!

Installing Blackmagic Desktop Video Drivers on Windows 7

- Step 1.** Ensure you have the very latest driver. Visit www.blackmagic-design.com/support
- Step 2.** Open the "Desktop Video" folder and launch the "Desktop Video" installer.
- Step 3.** The drivers will now be installed on your system. An alert will appear: "Do you want to allow the following program to install software on this computer?" Click Yes to continue.
- Step 4.** You will see a dialog bubble saying "found new hardware" and the hardware wizard will appear. Select "install automatically" and the system will find the required Desktop Video drivers. You will then receive another dialog bubble saying "your new hardware is ready for use."
- Step 5.** Now restart your computer to enable the new software drivers.

Plugins and applications that are installed

The Desktop Video software installer installs the following components:

- Blackmagic Desktop Video drivers
- Blackmagic Design Control Panel
- Blackmagic Design LiveKey
- Blackmagic Media Express
- Blackmagic Multibridge Utility
- Blackmagic AVI and QuickTime™ codecs
- Blackmagic Disk Speed Test
- Adobe® Premiere Pro, After Effects, Photoshop presets and plug-ins
- Avid Media Composer 6 plug-ins

Automatic updates

After your computer has restarted, the software will check the Blackmagic video hardware to see what internal software the hardware contains. If the internal software version does not match the driver version, Desktop Video will offer to update the internal software. This is automatic and all you need to do is click OK to start the update. After the internal software has updated, restart your computer to complete the process.

9 Getting Started

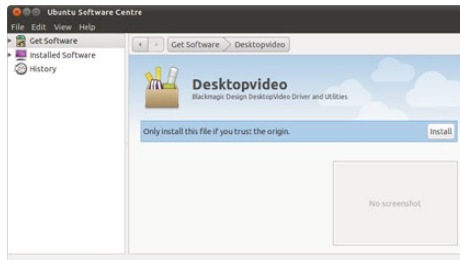

Desktop Video software ready to be installed from the Ubuntu Software Center

Installing Blackmagic Desktop Video Drivers on Linux

- Step 1.** Download the latest Desktop Video software for Linux from www.blackmagic-design.com/ support
- Step 2.** Open the "Desktop Video" folder and locate and open the "Desktop Video" package for your Linux distribution. Refer to the ReadMe file for the latest list of Linux distributions for which can be installed from a graphical user interface.
- Step 3.** Click the "Install" button and wait for the progress bar to complete.
- Step 4.** If there are messages about missing dependencies, ensure they are installed first and then rerun the Desktop Video installer.
- Step 5.** When finished, the installer will return to the same screen.
- Step 6.** Restart the computer to enable the drivers or type the following command:

```
# modprobe blackmagic
```

If you cannot find a native Desktop Video package for your Linux distribution, or if you prefer to install from a command line, refer to the ReadMe file for detailed installation instructions.

If you encounter any errors during the installation, refer to the ReadMe file for help.

Plugins and Applications that are installed

Desktop Video software installs the following components:

- Blackmagic Desktop Video drivers
- Blackmagic Design Control Panel
- Blackmagic Media Express
- Blackmagic AVI codecs

Updates

After your computer has restarted, the drivers will check the Blackmagic video hardware to see what internal software the hardware contains. If the internal software version does not match the driver version, Desktop Video will prompt you to update. Type the following command in terminal to find out the card ID of any cards that need updating:

```
# BlackmagicFirmwareUpdater status
```

A message similar to the following will appear:

```
/dev/blackmagic/card0 [DeckLink HD Extreme 3] UPDATED  
/dev/blackmagic/card1 [DeckLink HD Extreme 3] NEEDS_UPDATE
```

Note the ID of the card that needs to be updated and then update the firmware by typing:

```
# BlackmagicFirmwareUpdater update <card_id> (1 in this case)
```

Using Blackmagic System Preferences

Blackmagic system preferences provide a central location so you don't need to configure the same settings in each video application that you use, for example down conversion.

- On Mac OS X, open the System Preferences and look in the "Other" category to locate the Blackmagic Design icon. Click the Blackmagic Design icon to gain access to the settings.
- On Windows 7, open the system Control Panel and click on "Hardware and Sound" to reveal the Blackmagic Design Control Panel. Click the Blackmagic Design Control Panel to gain access to the settings.
- On Linux, go to "Applications" and then "Sound and Video" to locate the Blackmagic Control Panel. Double-click on the Blackmagic Control Panel to gain access to the settings. All features can be controlled by your own software using the Blackmagic SDK.

Different Blackmagic video hardware models have different features. Only those system preferences supported by your hardware model will be active and available to change.

The following section takes you through the Blackmagic system preferences you might see when using Blackmagic video hardware.

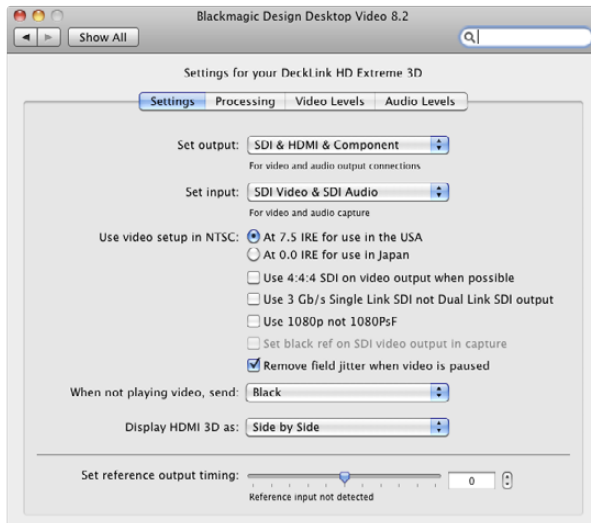

Blackmagic Design system preferences in Mac OS X

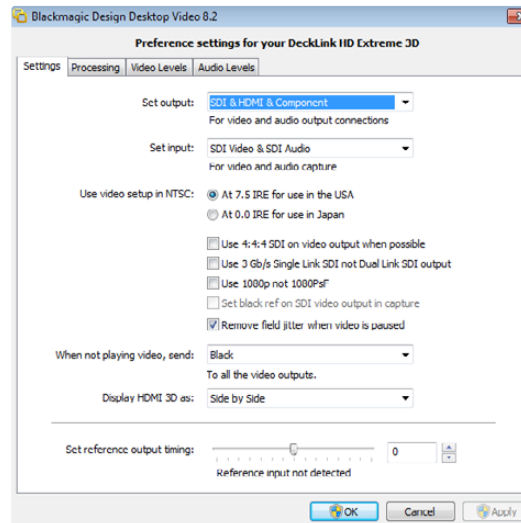

Blackmagic Design Control Panel in Windows 7

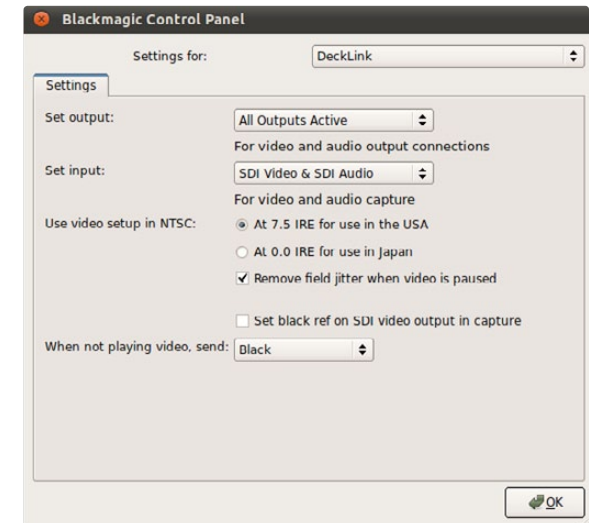

Blackmagic Design Control Panel in Ubuntu Linux

12 Getting Started

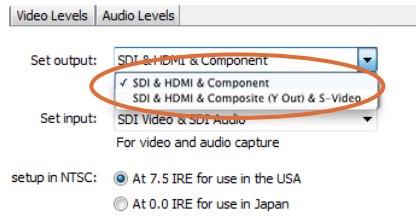

Video and Audio output connections.

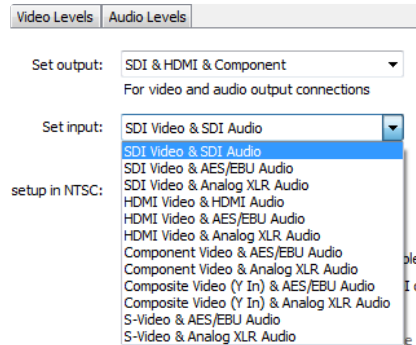

Video and Audio input connections.

Video and Audio Output connections

All of the video and audio outputs of Blackmagic video hardware are active all of the time. On some models you can choose between component analog video, S-Video or composite analog video.

The SDI, Optical Fiber SDI, HDMI and component analog video outputs support HD and SD video. S-Video and composite analog video do not support high definition video. S-video may require the use of an inexpensive S-video adapter cable.

Switchable Audio Output

Some models have switchable audio outputs. You can choose to output:

- 4 analog and 2 AES/EBU audio channels, or
- 2 analog and 6 AES/EBU audio channels

Video and Audio Input connections

Your Blackmagic video hardware may support some or all of the following combinations:

- SDI Video & SDI Audio
- SDI Video & AES/EBU Audio
- SDI Video & Analog XLR Audio
- Optical SDI Video & Optical SDI Audio
- HDMI Video & HDMI Audio
- HDMI Video & AES/EBU Audio
- HDMI Video & Analog XLR Audio
- Component Video & AES/EBU Audio
- Component Video & Analog XLR Audio
- Composite & AES/EBU Audio
- Composite & Analog XLR Audio
- S-Video & AES/EBU Audio
- S-Video & Analog XLR Audio

13 Getting Started

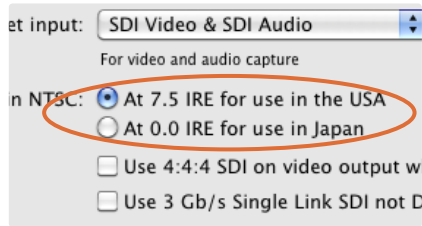

NTSC Setup.

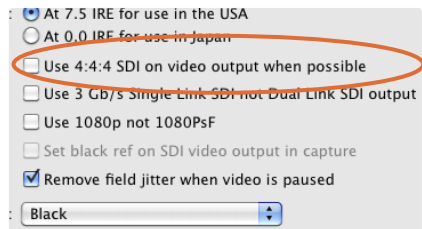

Output 4:4:4 color mode

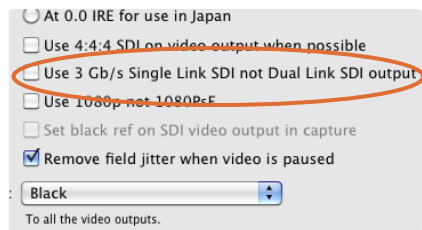

Single Link/Dual Link switch

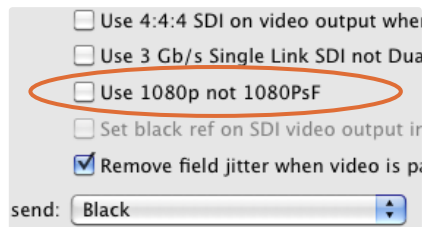

Progressive HD1080 video playback switch

NTSC setup

The NTSC composite video used in the USA, and some other countries, uses 7.5 IRE setup. If you're working in Japan and countries that don't use this setup, leave this set to 0 IRE setup. PAL and high definition standards do not use this setup.

Output 4:4:4 color mode

While most users work with 4:2:2 video, you will need to Select 4:4:4 on video output if you wish to play out 4:4:4 video, otherwise the video will show weird pink and green colors. 1080p50/60 video will always be output as 4:2:2.

When 4:4:4 video output is enabled, the following features are not available:

- simultaneous HD and down converted SD video output
- down converted analog video output.

Single Link/Dual Link switch

When working with high bandwidth video formats such as 1080p60 or any 4:4:4 format, choose between dual-link HD-SDI and single-link 3 Gb/s SDI.

Progressive HD1080 video playback switch

Choose between 1080PsF and 1080p on playback.

14 Getting Started

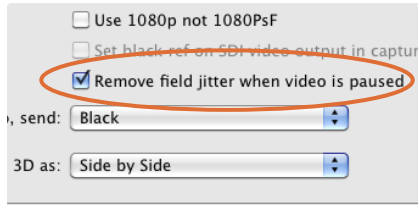

Video Output Behavior.

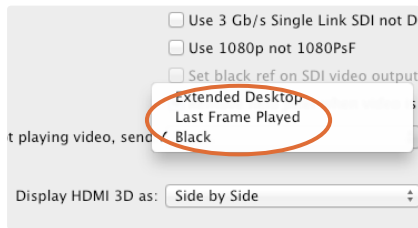

Frame output switch

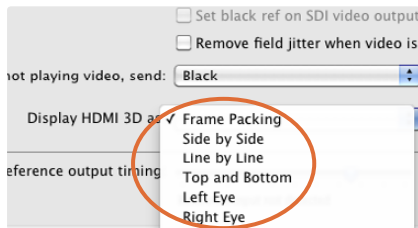

HDMI 3D monitoring formats

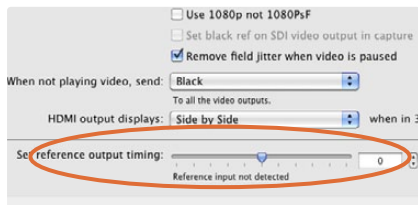

Genlock timing adjustment.

Remove Field Jitter

When interlaced video is paused on old CRT monitors, eliminate field flicker by only displaying a single field. We do not recommend using this option with modern flat screens.

Frame output switch

If you have switched out of a video application and video is no longer being played, this setting determines whether your Blackmagic video hardware will output black or the last played frame of video or an extended desktop.

If you are adjusting LUTs on some Blackmagic models, set this option to Last Played Frame so you can observe the effect of any adjustment to LUTs.

The extended desktop feature is supported on some Blackmagic models. Enabling or disabling the feature requires a restart of the computer. It's important that you set the extended desktop to the same standard as your video capture and playback, or you will get slower switching between capture and playback modes, as the monitors need to re-lock.

HDMI monitoring formats in 3D mode

When monitoring 3D stereoscopic video, select a format which is supported by your HDMI display: Frame Packing, Side by Side, Line by Line, Top and Bottom, Left Eye or Right Eye.

Reference Output Timing

A reference signal may also be known as genlock, black burst, house sync or tri-sync. If you have reference connected but your picture is rolling, adjust the "Set reference output timing" until the picture locks and is no longer rolling on the Blackmagic video output.

15 Getting Started

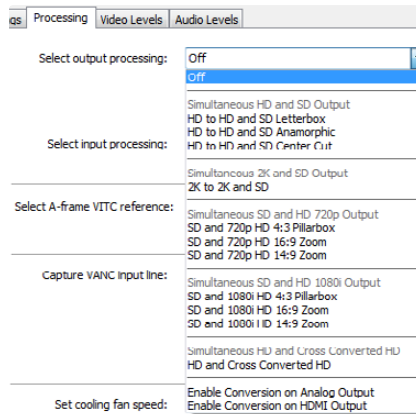

HDTV Up/Down Converter output processing.

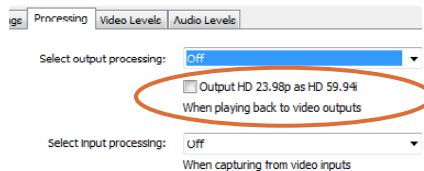

Output HD 23.98PsF at HD 59.94i

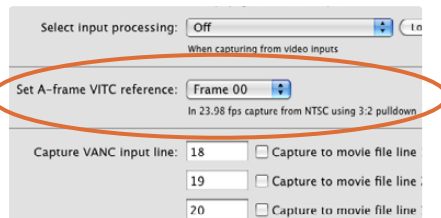

Set the A-Frame VITC Reference when performing 3:2 pulldown.

Up/Down/Cross Conversion

The Desktop Video drivers can be used to downconvert high definition to NTSC or PAL video in real time during capture or playback. They also provide upconversion on capture. Select the desired option from the output or input processing menus.

Some Blackmagic video hardware models support simultaneous down conversion on output such as HD & SD or 2K & SD. Simultaneous down conversion introduces a 2 frame delay on the SD-SDI output. To ensure accuracy, adjust the playback/timecode offset options when performing an insert or assemble edit to tape with Final Cut Pro, Premiere Pro or Blackmagic Media Express.

Analog video outputs are also down converted so you can always see video on an S-Video or composite analog monitor. Component analog video can be switched between HD or SD output. Choose to Enable Conversion on Analog Output, if you wish to view component analog standard definition video output, when simultaneous down conversion is enabled.

Output HD 23.98PsF at HD 59.94i (Windows only)

23.98 fps is a common film frame rate but support for this frame rate in SDI and analog monitors is rare. Enabling this option will apply 3:2 pulldown processing so that HD 23.98 PsF video is output as HD 59.94i. Almost all HD monitors support HD 59.94i.

VITC Reader A Frame - Reverse 3:2 Pulldown

This option decodes the VITC and uses it to correctly locate the A-frame when performing reverse 3:2 pulldown while capturing video at 23.98fps. Carefully set the correct A-frame VITC reference to match the timecode on tape. Selecting the wrong A-frame will generate incorrect presentation of fields and frames.

16 Getting Started

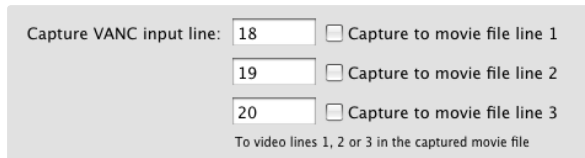

VANC preferences.

Preserving Blanking Data or VANC

This feature lets you use up to 3 video lines at the top of a captured movie file to store any 3 lines from vertical blanking. This allows 3 line timecode, VITC (vertical interval test signals) subtitle info or any other VANC data to be preserved during capture. These lines are then inserted back into the video blanking when the file is played back.

To preserve VANC data, select the VANC and 3:2 Pulldown tab and tick the On check box for video line 1, 2 or 3 depending on how many blanking lines you want to capture.

Video file line 1 needs to be enabled for lines 2 and 3 to work.

Because these lines can be passed to the application, a developer could write software to read the VANC data and use it for various purposes, e.g. 3-line timecode and audio chasing, or other uses.

An example of VANC data is 3-line timecode, which uses lines 18, 19, and 20 in NTSC or lines 19, 20 and 21 in PAL. 3-line timecode, as used in AATON™ equipped telecine suites, featuring audio timecode and keycode information along with the normal timecode numbers.

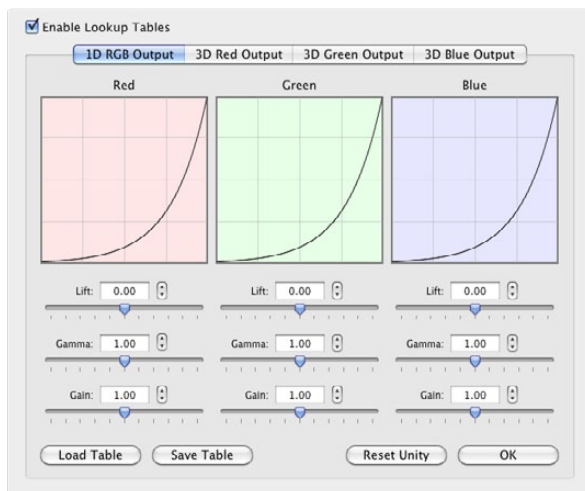

Enable Lookup Tables.

How to use Lookup Tables in Multibridge

Multibridge Eclipse and Multibridge Pro can use either 1D or 3D LUTs during playback.

Under the Settings tab, set the Frame output switch to "Last Played Frame" and then restart the computer.

Open your preferred video software application, play some video, open the Blackmagic system preferences and click on the Processing tab. The last played frame of video will remain on your broadcast monitor. Ensure that output processing is set to "Off" and then click on the corresponding Lookup Table button.

After selecting the Enable Lookup Tables checkbox, the lookup table interface can be adjusted using a method similar to the Curves feature in Adobe Photoshop™.

Changes are saved to the Blackmagic system preferences by clicking the OK button. Lookup tables can be reset to original values by clicking the Reset Unity button. Lookup table processing can be disabled by deselecting the Enable Lookup Tables checkbox. Lookup tables can be imported and exported using the Load Table and Save Table buttons.

17 Getting Started

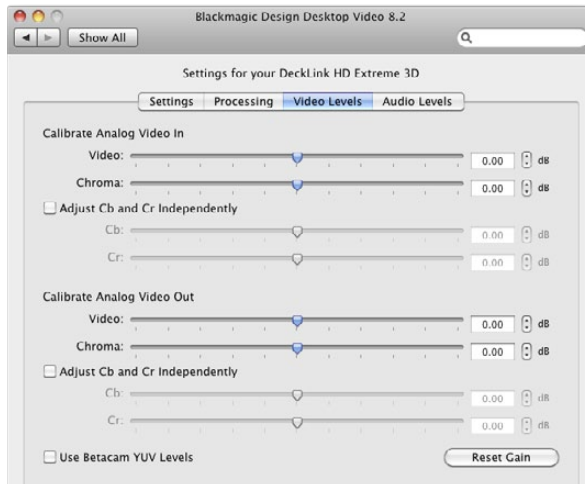

Video levels

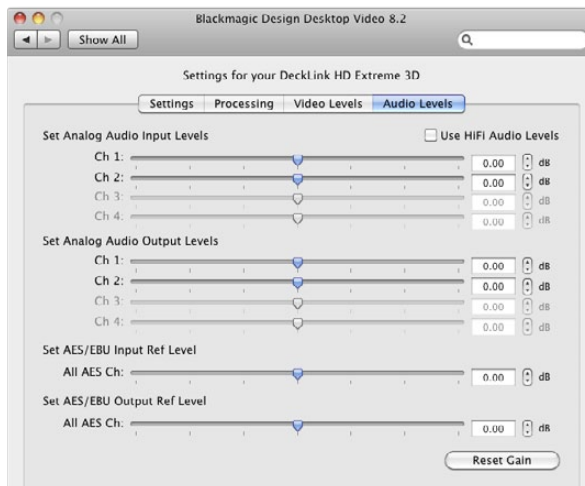

Audio levels

Video Levels

The video processing amplifier (Video Proc Amp) is used to adjust analog video and chroma levels and ideally should always be used in conjunction with a waveform monitor. The option to Calibrate Analog Video In is only available if the Set Input option in the Settings tab is set to analog video input.

By default, Blackmagic products use SMPTE component analog levels as almost all analog video monitors and modern video equipment use SMPTE levels. Enable the checkbox "Use Betacam YUV Levels" if working with Sony Betacam SP decks. If in doubt, try a test capture and you should see a very noticeable brightness shift if you choose the wrong levels.

Audio Levels

The audio processing amplifier (Audio Proc Amp) is used to raise or lower audio signals. Analog audio channels can be adjusted independently from each other. AES/EBU audio channels are raised or lowered together.

Professional analog audio levels and XLR audio connectors are standard on UltraStudio, DeckLink and Multibrige models. If you need to connect to consumer audio equipment with analog RCA inputs, enable the option to Use HiFi Audio Levels and use an inexpensive XLR to RCA adapter for each audio connection. Intensity models always have this option enabled as they exclusively use HiFi audio levels and RCA connections for analog audio.

18 Capturing and Playing back Video

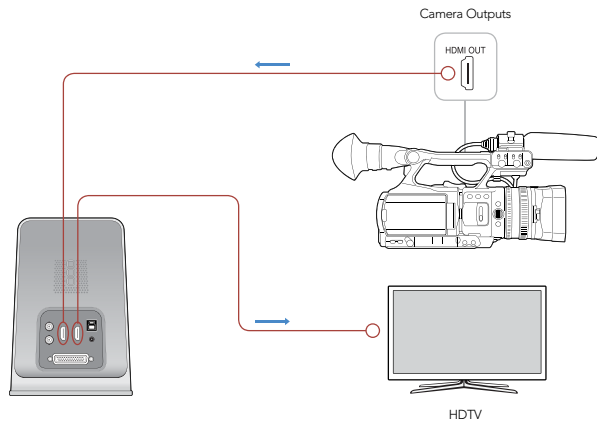

Connect a video monitor and source to your Blackmagic video hardware

It's a good idea to run a quick test to ensure you can capture and play back video before you need to use your Blackmagic video hardware for anything important:

- Connect a video monitor or TV to the video output of your Blackmagic video hardware. An HDMI TV is very convenient for this test as both video and audio can be monitored without needing external audio connections.
- Connect a video source to the video input of your Blackmagic video hardware, especially a camera or deck. DVD players shouldn't be used for this test as they typically have copy protection on their HDMI and analog outputs so you won't be able to capture from them even if you're using home-made DVD's.
- Use the Blackmagic system preferences to set your video and audio connections for input and output. See the previous "Using Blackmagic System Preferences" section for details.
- Locate Blackmagic Media Express and open it:
 - on Mac OS X, look in the Applications folder.
 - on Windows 7, go to the Start menu and choose Programs>Blackmagic Design>Media Express.
 - on Linux, go to Applications and look in the Sound and Video folder.

Video Playback test using Blackmagic Media Express

Import a test clip in to Media Express. If you see a message that the selected video format is not compatible with the current project, click "Don't save" to discard the current project and create a new project for the test clip.

Double-click the test clip and you should see the video on the monitor connected to the output of your Blackmagic video hardware. Audio output can also be monitored.

Video Capture test using Blackmagic Media Express

- Go to Media Express>Preferences on Mac OS X or Edit>Preferences on Windows or Linux.
- Select a project format which matches your video source and choose a capture file format.
- Set the storage location for your captured video and audio and choose whether to stop capture or playback if dropped frames are detected. Choose a compressed capture file format so you can capture to any disk.
- Close the Preferences and click on the Log and Capture tab. You should immediately see your video source in the video preview pane of Media Express.
- Click Capture to perform the capture test. Click Capture again to finish the test. Double-click on the captured clip in the Media List to play it back on screen and on the outputs of your Blackmagic video hardware.

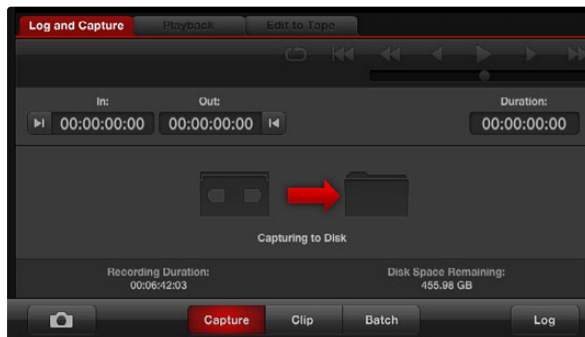

Click the "Capture" button to commence recording

19 Using your Favourite Editing Software

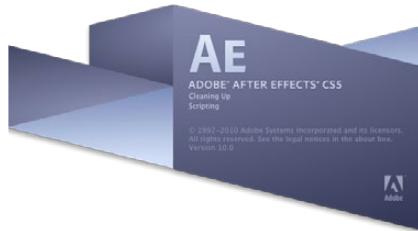

Launching After Effects

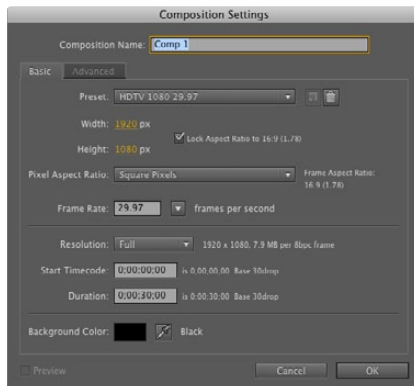

"Composition Settings" options



"Video Preview" preferences

Adobe After Effects CS5 and CS5.5

How to use Blackmagic as a preview output frame buffer

To allow your Adobe After Effects composition to be displayed in real-time through your Blackmagic video hardware, go to Preferences > Video Preview. Select Blackmagic Video Output and the appropriate Output Mode. This lets you view your Adobe After Effects compositions in the correct video colorspace on your broadcast monitor as you work. You will always see the correct color and interlace when working, and you don't have to wait until your composition is rendered to see what it looks like when output as video.

Rendering

When you have completed your composition, you will need to render to a pixel format supported by your Blackmagic video hardware. You can render to a DPX image sequence or any of the following supported codecs:

QuickTime codecs on Mac OS X

- Blackmagic RGB 10 bit (uncompressed)
- Apple Photo - JPEG (compressed)
- Apple Uncompressed YUV 10 bit 4:2:2
- Apple DV - NTSC (compressed)
- Apple Uncompressed YUV 8 bit 4:2:2
- Apple DV - PAL (compressed)

Other codecs including ProRes and DVCPRO HD will be available if Final Cut Pro 7 is installed on the same computer.

AVI codecs on Windows

- Blackmagic 10 bit 4:4:4 (uncompressed)
- Blackmagic SD 8 bit 4:2:2 (uncompressed)
- Blackmagic 10 bit 4:2:2 (uncompressed)
- Blackmagic 8 bit MJPEG (compressed)
- Blackmagic HD 8 bit 4:2:2 (uncompressed)

Other codecs including DVCPRO HD and DVCPRO50 will be available if Premiere Pro CS5.5 is installed on the same computer.

QuickTime codecs on Windows

- Blackmagic RGB 10 bit (uncompressed)
- Apple Photo-JPEG (compressed)
- Blackmagic 10 bit (uncompressed)
- Apple DV - NTSC (compressed)
- Blackmagic 8 bit (uncompressed)
- Apple DV - PAL (compressed)

20 Using your Favourite Editing Software

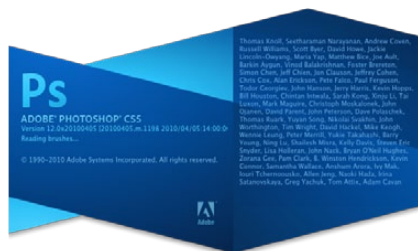

Launching Adobe Photoshop

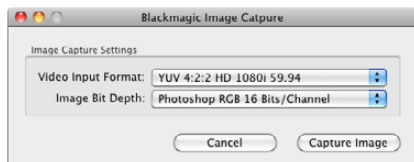

Image Capture

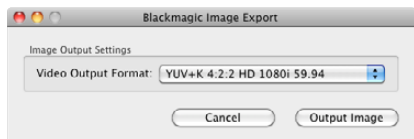

Image Export

Adobe Photoshop CS5 and CS5.5

How to grab and output video frames

Import an image into Photoshop

Step 1. From Photoshop select File > Import > Blackmagic Image Capture

Step 2. Select the "Video Input Format" and the "Image Bit Depth" and then click Capture Image

Export an image from Photoshop

Step 1. Select File > Export > Blackmagic Image Export

Step 2. Select Video Output Format and then click Output Image

Once you have set the options in the "Import" or "Export" windows, each subsequent Import and Export will not display the window, so you can grab and output frames much faster. However if you would like to change your import or export formats, hold the Option [Mac] or Ctrl [Win] key, when selecting import or export.

21 Using your Favourite Editing Software



Adobe Premiere Pro

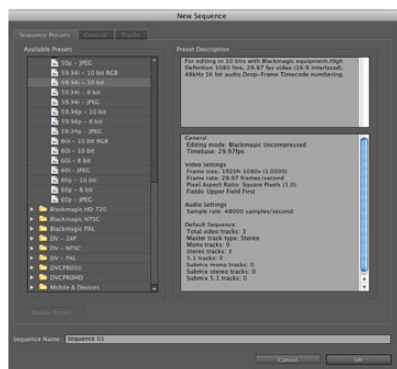

New Sequence

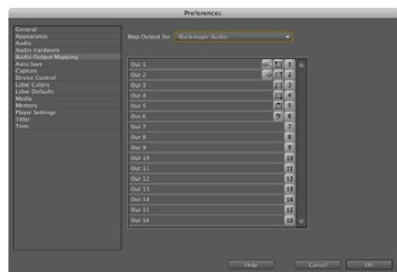

Audio Output Mapping

Adobe Premiere Pro CS5 and CS5.5

Setting up a Blackmagic Design project

- Step 1.** Launch Premiere Pro.
- Step 2.** Create a New Project and click on the Scratch Disks tab.
- Step 3.** Set the desired Location and Name for your project at the bottom of this window.
- Step 4.** Set the locations for your captured video, captured audio, video previews and audio previews.
- Step 5.** Click on the General tab and review the Video Rendering and Playback settings. If your graphics card is supported by Premiere Pro's Mercury Playback Engine, the Renderer option will be available and you should switch it to "Mercury Playback Engine GPU Acceleration".
- Step 6.** Set the Capture Format to Blackmagic Capture and click on the Settings [Mac] or Properties [Win] button to reveal the Blackmagic Capture Settings for your project. The Video Standard can be set to NTSC, PAL, HD720, HD1080 or 2K. The Video Format can be uncompressed or compressed. Now click OK.
- Step 7.** The New Sequence window will appear. Select the desired Blackmagic preset, give the sequence a name and then click OK.

Audio

Blackmagic audio hardware is automatically chosen when a new project is created and the capture format is set to Blackmagic Capture. Go to Preferences > Audio Hardware and verify that the Default Device is set to Blackmagic Audio.

You may also wish to visit Preferences > Audio Output Mapping to select the mix of the multi-channel audio. Set Map Output for to Blackmagic Audio.

22 Using your Favourite Editing Software

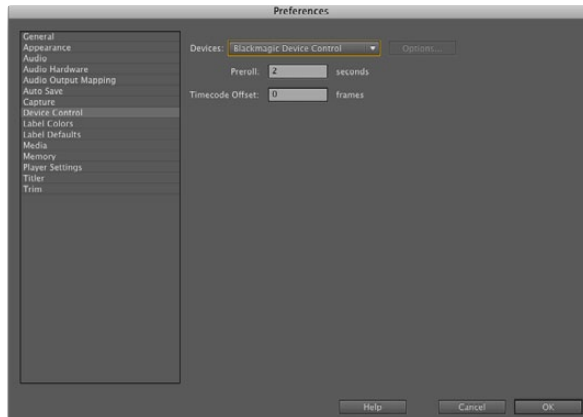

Device Control

Device Control

UltraStudio, DeckLink and Multibrige include RS-422 device control for controlling decks. Blackmagic Device Control is automatically chosen when a new project is created and the capture format is set to Blackmagic Capture. The choice of device control can also be configured through Preferences > Device Control.

The Options button is disabled as the settings are automatically detected and configured when you choose Blackmagic Device Control.

Player Settings

The default player should be switched from Adobe Player to Blackmagic Playback. The choice of player settings can be configured through Preferences > Player Settings.

Playback

As a quick test to make sure everything is connected correctly, use the Premiere Pro test media (Bars and Tone or Universal Counter Leader). Drag your test media from within the Premiere Pro project and drop it on to the timeline. You should now see the image on both your computer desktop and the output of your Blackmagic video hardware. If you can't see any video on your Blackmagic output, check the connections again and ensure you have the correct output settings configured in the Blackmagic Design system preference. SDI, HDMI and analog outputs are always active.

Capture

To capture choose: File > Capture [F5]

To immediately capture, or to capture from a non-controllable device, click the red record button [G].

If you wish to log the clip using RS-422 deck control with UltraStudio, DeckLink or Multibrige, enter the desired In and Out points using either the Set In and Set Out buttons, or manually by typing the timecode and clicking Log Clip. The empty clip will now appear in the Project window. Repeat this until you have logged all of the clips you wish to batch capture.

To change the capture format, click on the Settings tab and then the Edit button. Ensure the Capture Format is set to Blackmagic Capture, click on the Settings [Mac] or Properties [Win] button and then change the Blackmagic Capture Settings as desired.

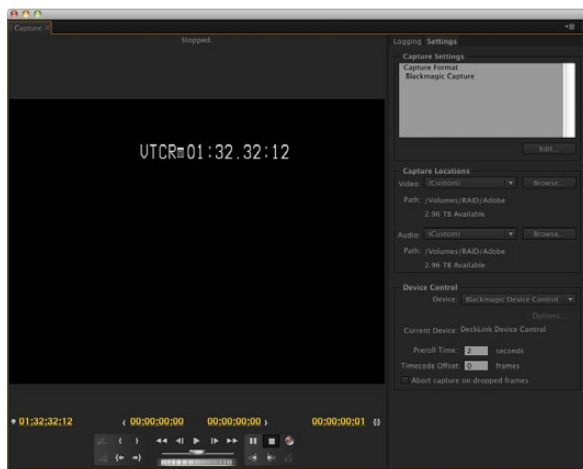

Capture

23 Using your Favourite Editing Software

Batch Capture

If you wish to batch capture using RS-422 deck control, select the clips you wish to capture by drag-selecting or shift-clicking each clip. Then choose: File > Batch Capture [F6]. To set handles on the clips, enable the option to Capture with handles and type the number of additional frames you require at the start and end of each clip.

Export to Tape

To export to tape via RS-422 deck control, select the sequence you require and then choose File > Export > Tape

Insert editing requires unbroken timecode over the full length of the project which is to be laid to tape.

In assemble mode the tape needs only to be "blacked" until a point just beyond the start time of the project. As assemble editing erases the tape ahead of the record heads, it should not be used where other projects already exist on the tape after the out point of your edit.

When editing to tape, the software waits at the first frame of your project for the deck to drop into record at the predetermined timecode. Should you find that either the first frame of your program is repeated or lost, during the edit to tape procedure, you will need to adjust the playback offset to bring the deck and computer in sync. You should only need to do this once with any combination of deck and computer and the correct setting will be retained.

Now, simply enter the desired in point and offsets if required, and click OK [Mac] or Export [Win].

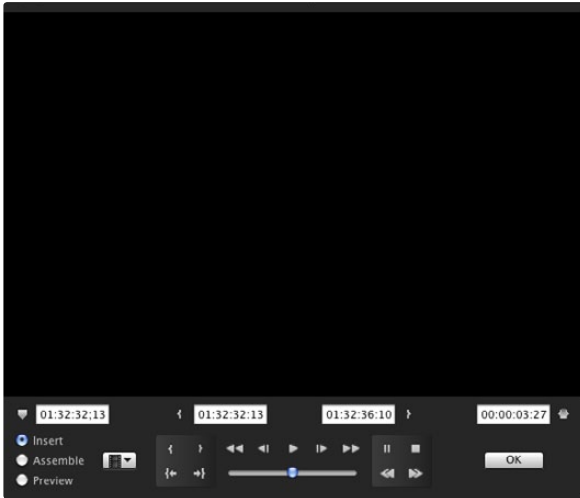

Export to Tape

24 Using your Favourite Editing Software



Final Cut Pro

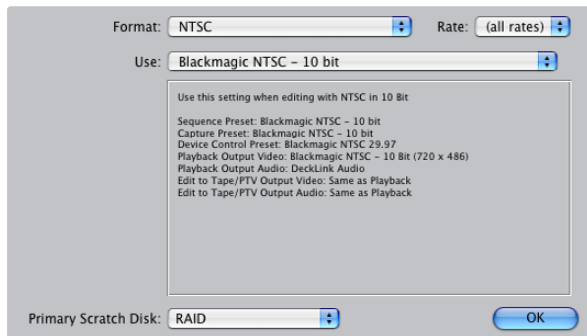

Select a Blackmagic Easy Setup

Apple Final Cut Pro 7

“Easy Setups” for Final Cut Pro 7 are automatically installed if Final Cut Pro is installed before the Desktop Video software. Blackmagic video hardware is fully compatible with Apple’s RT Extreme™ real time effects.

Setting up

- Step 1.** Launch Final Cut Pro 7 and the Easy Setup window will appear.
- Step 2.** Click on the popup menu and select the desired Blackmagic Easy Setup. For each video format (NTSC, PAL, HDTV and 2K) you will find a range of Blackmagic compressed and uncompressed file formats you can choose.
- Step 3.** Click on the popup menu named Primary Scratch Disk and select your disk array from the popup menu.
- Step 4.** Click OK and the Final Cut Pro interface will appear.

Playback

As a quick test to make sure everything is connected correctly, use the Blackmagic test media (bars and tone) which can be found on the installer CD or disk image. Find a test clip which matches the format of your project, e.g. NTSC 8 bit, and copy it to your disk array. Import this clip into your Final Cut Pro project and drop it into the timeline. You should now see the image on both your computer desktop and your Blackmagic output.

If you can’t see any video on your Blackmagic output, check the connections again and ensure you have the correct output settings configured within Final Cut Pro by going to the View > Video Devices. In the same menu, make sure “External Video” is set to “All Frames”.

Capture from Non-Controllable devices

Many video sources including all kinds of modern cameras and disk recorders, as well as old cameras and VHS tape players, do not have any device control. For this reason, after selecting a Blackmagic Easy Setup, Final Cut Pro will sometimes warn that device control has been set to “non-controllable device”. This is as expected. Click OK and then create a project with these settings.

To capture video from a non-controllable device, choose File > Log & Capture. (Command + 8). Press play on your video source and then press the Now button in the Log and Capture window. Final Cut Pro will show you a preview of the video you are capturing. Press the ‘esc’ key at the top left of your keyboard to stop capturing.

25 Using your Favourite Editing Software

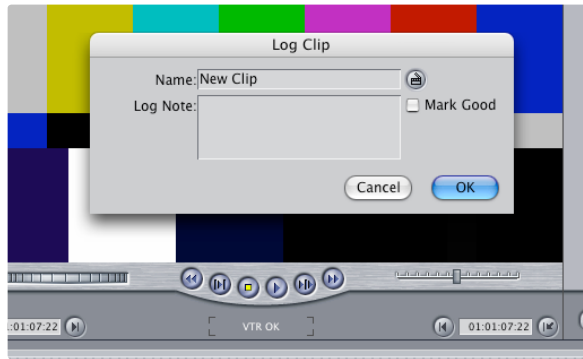

Naming a clip in the Log and Capture window

Capture from controllable devices with UltraStudio, DeckLink and Multibrige

To capture with RS-422 deck control, choose File > Log & Capture. (Command + 8)

Your video deck will respond in the same way as a clip in the timeline, via the "<spacebar>", "j", "k" and "l" keys.

To immediately capture, click the Capture Now button.

To log the clip, enter the desired "in" and "out" points using either the "i" and "o" keys on your keyboard, or manually by typing in the timecode and clicking Log Clip. The clip will appear in your browser with a diagonal red line indicating that it's "offline". Repeat this until you have logged all of the clips you wish to capture in a batch.

Batch Capture with UltraStudio, DeckLink and Multibrige

Select the clips you wish to capture by drag selecting or shift-click. Select File > Batch Capture or click on the Batch button in the "Logging" tab of the "Log & Capture" window. (Control + C)

Enable the "Add Handles" box if you wish to capture additional frames ("handles") before and after the "In" and "Out" points of a clip.

Recording to Tape with UltraStudio, DeckLink and Multibrige

Once you have captured your clips, edited them and applied any effects, you will want to record the completed project to tape.

One easy method is to select File > Print to Video (Control + M).

If you want to perform precise insert and assemble edits onto a timecode striped tape, select File > Edit to Tape.



Batch Capture

26 Using your Favourite Editing Software



Final Cut Pro

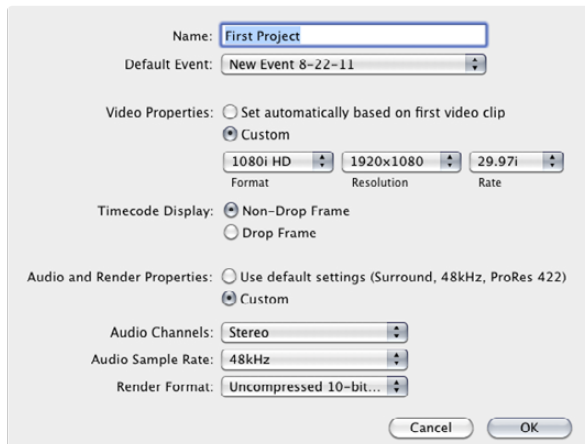

Step 8. Set the Audio and Render Properties to Custom.

Apple Final Cut Pro X

If you want to use Final Cut Pro X to play back video on an external video monitor or TV, you can use the Extended Desktop feature of Desktop Video as your second display.

Setting up

- Step 1.** Final Cut Pro X supports a maximum of 2 monitors so make sure your Mac is only using one monitor.
- Step 2.** Open the System Preferences and click on Blackmagic Design. Set the preferences to show, "When not playing video, send Extended Desktop" and then restart your Mac.
- Step 3.** Open the System Preferences and click on Displays. A "Television" window should appear on your broadcast video monitor or TV.
- Step 4.** Set the Resolution and Refresh Rate to match the video format of your clips. For example, use 720 x 576 and 25 Hz for PAL video, or 1920 x 1080 and 29 Hz for HD1080i59.94 video.
- Step 5.** Launch Final Cut Pro X and create a new project.
- Step 6.** Type a name and choose a location for the new project.
- Step 7.** Set the Video Properties to Custom and then set the format, resolution and frame rate to match the video format of your clips.
- Step 8.** Set the Audio and Render Properties to Custom. Set the audio channels to Stereo or else you can choose Surround for 6 audio channels. Set the audio sample rate to the television rate of 48kHz. Set the render format to the same format as your video clips. Final Cut Pro X defaults to using ProRes but you can switch this to Uncompressed 10-bit 4:2:2 to avoid compression. Click OK to complete the creation of your new project.
- Step 9.** Go to the Window menu and choose Show Viewer on Second Display.

27 Using your Favourite Editing Software

Playback

- Step 1.** Import some clips in to your new project.
- Step 2.** You can now use the Final Cut Pro X timeline on your computer monitor and view the video preview on the monitor or TV connected to the output of your Blackmagic Design video hardware.

Capturing Video and Audio

You can use Blackmagic Media Express to capture video and audio with your Blackmagic Design video hardware. Once you have captured the clips, you can import them in to Final Cut Pro X for editing.

When capturing clips with Media Express, make sure you choose one of the video formats which is also supported by Final Cut Pro X, i.e.: Apple ProRes 4444, Apple ProRes 422 (HQ), Apple ProRes 422 or Uncompressed 10-bit 4:2:2.

Editing to Tape

Once you have completed a project in Final Cut Pro X, you can render the project to a movie file and then use Blackmagic Media Express to master the movie to tape with your Blackmagic Design video hardware.

- Step 1.** Select your clips from the timeline in Final Cut Pro X.
- Step 2.** Go to the Share menu and choose Export Movie.
- Step 3.** In the Export Movie window, leave Export on "Current Settings" and also set Include to "Video and Audio". Click "Next".
- Step 4.** Open Media Express and import the clip that was exported from Final Cut Pro X.
- Step 5.** Refer to the Blackmagic Media Express section of this manual for "Editing video and audio files to tape".

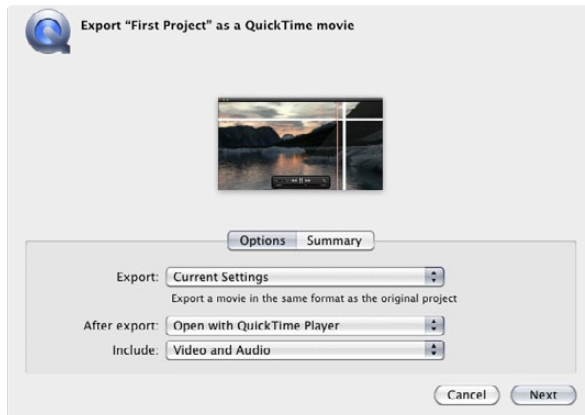

Step 2. Go to the Share menu and choose Export Movie.

28 Using your Favourite Editing Software

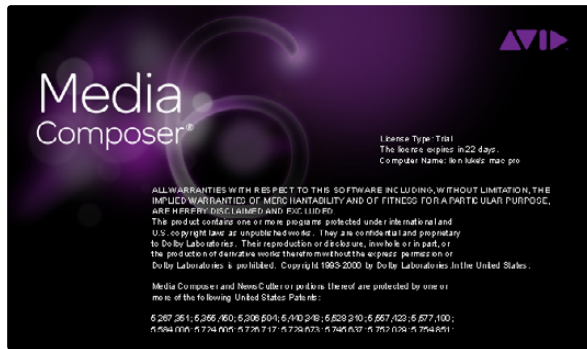

Media Composer

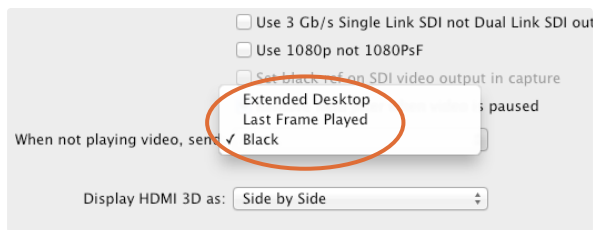

If using a single computer monitor with Media Composer, open the Blackmagic Design system preferences and choose to send Black when not playing video.

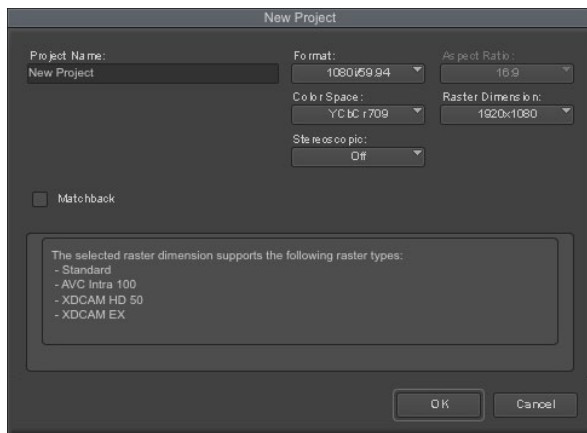

Step 5. Type a project name and set the project options.

Avid Media Composer 6

Avid Media Composer 6 captures and plays back standard definition and high definition video and audio with Blackmagic video hardware, and also supports RS-422 deck control. Blackmagic plug-ins for Media Composer are automatically installed if Media Composer is installed before the Desktop Video software.

You can use the Blackmagic Design system preferences to select your video and audio connections including SDI, analog and HDMI, as well as other settings such as up, down and cross conversion, reference clocking and HD progressive frame type. If only using a single computer monitor with Media Composer, disable the Extended Desktop feature by setting "When not playing video, send" to "Black" and then restart the computer. This will avoid the software interface extending on to your video monitor.

Setting up

- Step 1.** Launch Media Composer and the Select Project dialog box will appear.
- Step 2.** Choose your preferred User Profile if you have previously created one.
- Step 3.** Select the folder in which you want to create the project: Private, Shared or External.
- Step 4.** Click the New Project button.
- Step 5.** Type a project name and set the project options including Format, Color Space and Stereoscopic. Click OK. Once the project has been created, the frame rate and raster cannot be changed. The color space and stereoscopic settings can be changed later in the Format tab of the project.
- Step 6.** Double-click the project name in the Select Project dialog box. The Media Composer interface will appear along with the project window for your new project. You have completed setting up your project.

Playback

As a quick test to make sure everything is connected correctly, go to the Media Composer Editing Guide and follow the section entitled "Importing Color Bars and Other Test Patterns". Double-click the imported file to play it in a pop-up monitor. You should now see the image on both your computer monitor and your Blackmagic output.

If you can't see any video on your Blackmagic output, check the connections again and ensure you have the correct output settings configured within the Blackmagic Design system preferences by choosing Tools > Hardware Setup from within Media Composer.

29 Using your Favourite Editing Software

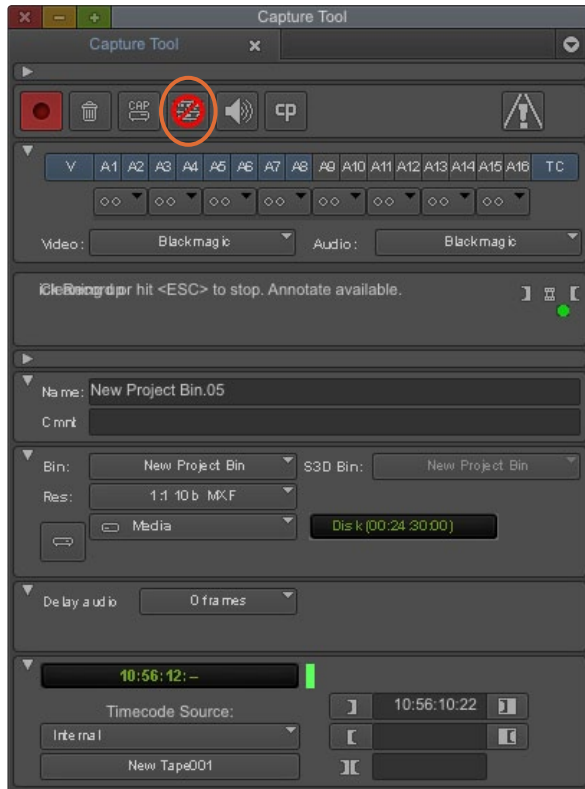

Step 2. Set up the Capture Tool to capture video without deck control by clicking the Toggle Source button.

Capture from Non-Controllable devices

Many video sources including all kinds of modern cameras and disk recorders, as well as old cameras and VHS tape players, do not have any device control. To capture video without deck control:

- Step 1.** Choose Tools > Capture to open the Capture Tool.
- Step 2.** Click the Toggle Source button so that the button's icon of a deck shows a red circle-slash symbol. This symbol indicates that deck control has been disabled.
- Step 3.** Set the Video and Audio input menus to "Blackmagic".
- Step 4.** Select the video source track (V) and the audio source tracks (A1, A2, ...) you wish to capture.
- Step 5.** Use the Bin menu to select a Target Bin from the list of open bins.
- Step 6.** From the Res (resolution) menu, choose which compressed or uncompressed codec you wish to use for your captured clips. For maximum quality uncompressed video, choose "1:1" for 8-bit video capture or "1:1 10b" for 10-bit video capture.
- Step 7.** Select the disk storage for your captured video and audio. Use the Single/Dual Drive Mode button to determine if video and audio will be stored together on a single drive or video on one drive and audio on another drive. Select the target drive(s) for your captured media from the Target Drives menu(s).
- Step 8.** Click the "Tape Name?" button at the bottom of the window to open the Select Tape dialog box. Select the desired tape, or add a new one, and then click OK.
- Step 9.** Ensure your video and audio source is ready or playing and then click the Capture button or press the F4 key. The Capture button will flash red while recording. Click the Capture button again or press the Escape button on your keyboard to end the capture.

30 Using your Favourite Editing Software

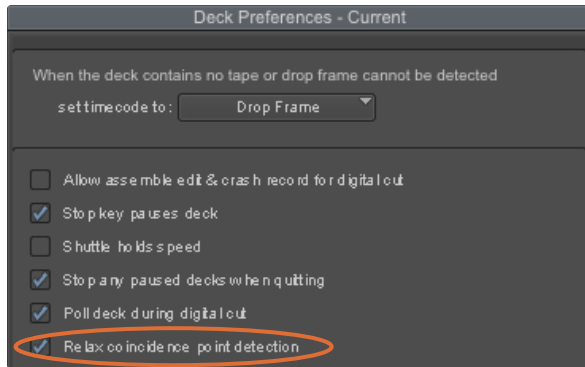

Step 6. In the Deck Preferences, enable the option to "Relax coincidence point detection".

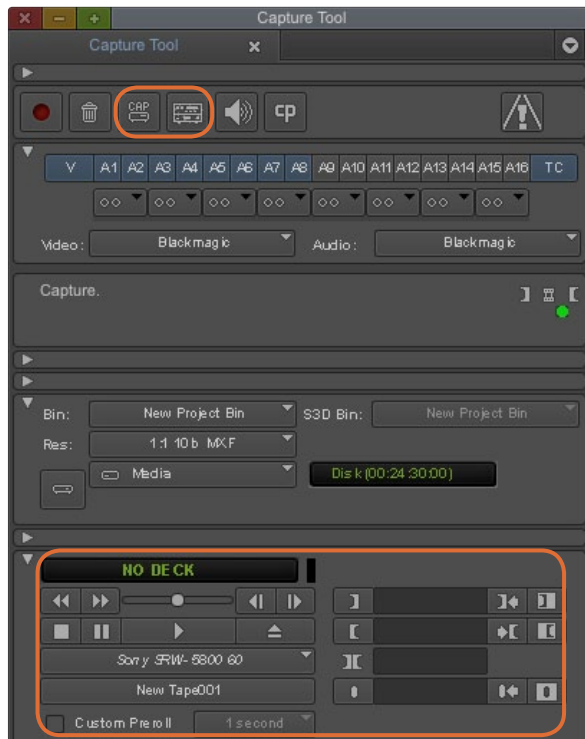

Set the CAP and Toggle Source buttons to use deck control. Use the Deck Controller Window to cue the tape and start playing.

Capture from Controllable devices with UltraStudio, DeckLink and Multibrige

If you have a deck which connects via RS-422, you will need to configure the deck settings before performing a capture with deck control:

- Step 1.** From your project window, click the Settings tab and double-click on Deck Configuration.
- Step 2.** In the Deck Configuration dialog box, click Add Channel and then set the Channel Type to Direct and the Port to RS-422 Deck Control. Click OK and choose "No" when asked, "Do you want to autoconfigure the channel now?"
- Step 3.** Click Add Deck and then select your brand and model of deck from the Device menus and also set the desired preroll. Click OK and then Apply.
- Step 4.** Under the Settings tab, double-click on Deck Preferences.
- Step 5.** If you plan to make assemble edits to tape, enable the option to "Allow assemble edit & crash record for digital cut". If this option is left unchecked, you will only be able to perform insert edits.
- Step 6.** Enable the option to "Relax coincidence point detection" and set other settings as needed. Click OK. You have completed setting up the RS-422 connection to your deck.

To test the RS-422 connection, ensure an RS-422 serial cable is connected between your Blackmagic video hardware and the deck. The Remote/Local switch must be set to Remote on the deck so you can use the transport controls in Media Composer. Open the Capture Tool and use the standard j, k, l shortcut keys to shuttle backwards, pause and shuttle forwards on the deck. If a deck name appears in italics in the Deck Selection menu, or "NO DECK" is displayed, click the menu and select Check Decks one or more times, until the deck is listed without italics, to reestablish deck control.

To capture with deck control on-the-fly:

- Step 1.** Choose Tools > Capture to open the Capture Tool.
- Step 2.** The Capture/Log Mode button should show the CAP icon. If this button displays a LOG icon, click the button to switch to capture mode and the CAP icon should appear.
- Step 3.** The Toggle Source button should show the icon of a deck. If a red circle-slash symbol is present, click the button to enable deck control and make the red symbol disappear.
- Step 4.** Configure video and audio input, video and audio source tracks, target bin, res, target drive and tape name the same way as in "Capture from non-controllable devices".
- Step 5.** Use the Deck Controller Window in the Capture Tool to cue the tape and start playing.
- Step 6.** Click the Capture button or press the F4 key. The Capture button will flash red while recording. Click the Capture button again or press the Escape button on your keyboard to end the capture.

31 Using your Favourite Editing Software

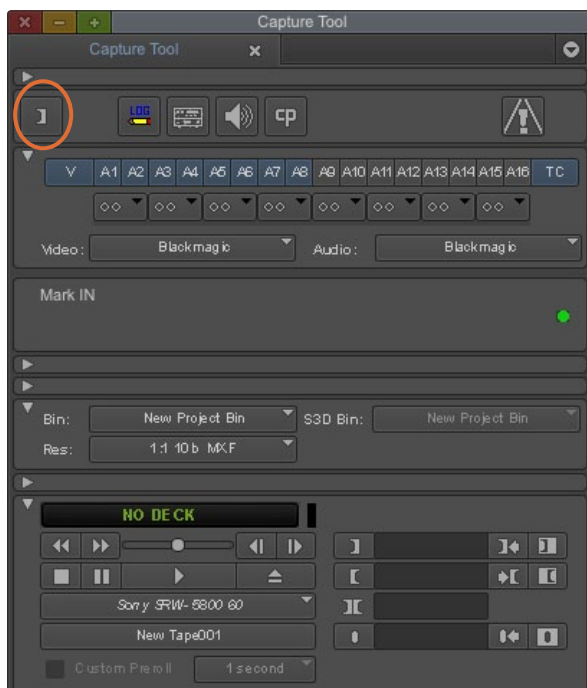

Step 5. Click on the Mark IN/OUT button or use the "i" and "o" keys on the keyboard to mark in and out points.

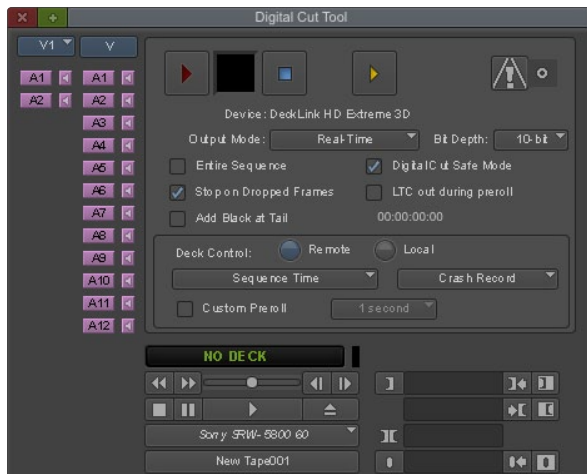

The Digital Cut Tool is used for recording to tape.

Batch Capture with UltraStudio, DeckLink and Multibrige

To log clips for batch capture:

- Step 1.** Choose Tools > Capture to open the Capture Tool.
- Step 2.** Click on the Capture/Log Mode button so it displays the LOG icon.
- Step 3.** Configure video and audio input, video and audio source tracks, target bin, res, target drive and tape name the same way as in "Capture from non-controllable devices".
- Step 4.** Use the Deck Controller Window, or use the standard j, k, l shortcut keys, to shuttle backwards, pause and shuttle forwards on the deck and locate the video you want to capture.
- Step 5.** Click the Mark IN/OUT button, to the left of the LOG button. The icon will alternate between IN and OUT so you only have to click the one button to mark all your in and out points. This can be more convenient than using the separate Mark IN and Mark OUT buttons in the Deck Controller Window. Alternatively use the "i" and "o" keys on the keyboard to mark in and out points.
- Step 6.** When you have finished logging in and out points, open the logging bin, select the clips you want to capture.
- Step 7.** Choose Clip > Batch Capture, select the desired options in the resulting dialog box and click OK.

Recording to Tape with UltraStudio, DeckLink and Multibrige

Once you have captured your clips, dragged them in to the timeline, edited them and applied and rendered any effects, you will want to record the completed project to tape.

- Step 1.** Double-click on a sequence, in your project bin, to open it into the Timeline window.
- Step 2.** Choose Output > Digital Cut to open the Digital Cut Tool.
- Step 3.** Set Output Mode to Real-Time, Bit Depth to 10-bit, and Deck Control to Remote.
- Step 4.** From the Edit Menu, choose to Insert Edit or Assemble Edit for precise edits onto a timecode striped tape. Alternatively choose Crash Record for an easy way to record. If Insert Edit is the only option, go to the Settings tab in your project, double-click on Deck Preferences and enable "Allow assemble edit & crash record for digital cut".
- Step 5.** If a deck name appears in italics in the Deck Selection menu, or "NO DECK" is displayed, click the menu and select Check Decks one or more times, until the deck is listed without italics, to reestablish deck control.
- Step 6.** Press the Play Digital Cut button (red triangle icon) to record your sequence to tape.

32 Blackmagic Media Express



What is Media Express?

Blackmagic Media Express software is included with every UltraStudio, DeckLink, Multibrige and Intensity. Depending on your hardware model and platform, Media Express 3 lets you batch capture and play back 2D and dual stream stereoscopic 3D in DPX, ProRes, uncompressed YUV and RGB, DVCPRO 50, DVCPRO HD and MJPEG files.

Media Express 3 also supports CMX EDL import, frame accurate deck control via RS-422, and will even insert and assemble to tape! Media Express is fast, accurate, easy to use and works on Mac OS X, Windows and Linux. You can even grab still frames directly from your deck and save them as perfect digital quality still images. That's a complete solution for capture and playback!

Blackmagic Media Express 3 is a great tool when you don't need the complexity of NLE software but simply want to capture, play back and output clips to tape, especially when working with video compositing software.

The User Interface

Media Express can easily be scaled for different sizes of monitors or even small notebook screens. When you open Media Express, you'll notice the log and capture, playback and edit to tape views are color-coded so you will know at a glance which mode is being used.

Media List

The left "media list" always displays the scratch, any bins you have created and also any media you have imported, captured or logged for capture. Media can be displayed in Timecode List view or Thumbnail view and you can even filter media by favorites. The Search field makes it easy to find media by name or by attributes captured in the media metadata. The project name and format are shown in the bottom-left corner of the Media Express window.

The top-right pane always displays the video preview. Timecode is displayed at the top of the video preview pane and NO REMOTE will be indicated if no RS-422 device control is connected.

33 Blackmagic Media Express

Log and Capture

Click on the red Log and Capture tab. The video preview pane shows the source video from your camera or deck. Here you can enter metadata for the clips you will capture including name, description, reel number, favorite and more. You can capture with or without device control, log clips with in and out points, and batch capture. Double-clicking a captured clip in the media list will automatically switch Media Express to Playback view.

Playback

In the green Playback view, the video preview pane shows the video of the clip being played. Click the favorites button to add to your favorites in the media list.

Edit to Tape

After clicking the blue Edit to Tape tab, select clips from the media list to be mastered to tape using RS-422 device control. Set the In/Out points for your edit and choose between Assemble or Insert edit. You can even preview before mastering to tape. The video preview pane shows the clips being sent to tape.

34 Blackmagic Media Express

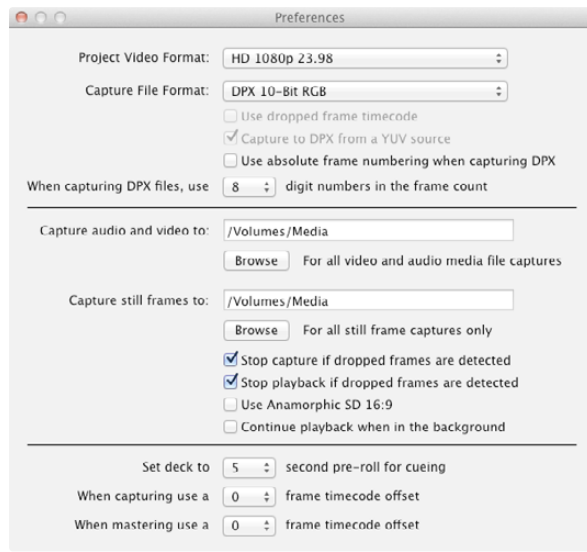

Capturing Video and Audio files

Setting up a Project

Before capturing any clips in Media Express, you will need to select the settings for your project. Go to Media Express>Preferences on Mac OS X or Edit>Preferences on Windows or Linux.

The project formats listed will vary depending upon whether your Blackmagic video hardware supports features including 1080p and 2K video or even stereoscopic 3D video.

Select from a range of professional compressed and uncompressed capture file formats or even a DPX image sequence.

Set the storage location for your captured video and audio and choose whether to stop capture or playback if dropped frames are detected.

Standard definition projects are set to the 4:3 aspect ratio unless you enable the Anamorphic SD 16:9 checkbox.

Usually video applications stop playing video if you send them to the background. If you want Media Express to keep playing video through your Blackmagic video hardware, even if you open another application in the foreground, enable the checkbox to "Continue playback when in the background".

The final options relate to tape decks with RS-422 deck control.

Your tape deck requires a pre-roll of a few seconds before performing an edit so the tape speed is stable by the time it is used for an edit.

Timecode offsets can also be set to calibrate the timecode to the video.

35 Blackmagic Media Express

The screenshot displays the Blackmagic Media Express interface with several key components annotated:

- Media List:** Located on the left side, it shows a hierarchy of clip bins including "Scratch" (6 Clips), "Todays rushes" (12 Clips), "VFX plates" (14 Clips), and "New shots from location 2" (5 Clips). Each clip is represented by a thumbnail and its duration.
- Timecode List, Thumbnail and Favorites view:** This area is shared with the Media List and provides a detailed view of selected clips.
- Search Field:** A search bar at the top right of the Media List.
- VTR / deck timecode:** A digital timecode display at the top of the video preview window, showing 00:00:07:07.
- Video Preview:** The main window on the right showing a video clip of a fighter jet in flight. A "ZOIC" logo is visible in the bottom right corner of the preview.
- Project name, video format and frame rate:** Located at the bottom left, it displays "Project Untitled HD 1920x1080p 23 98fps".
- Clip Bins:** The left side of the interface is organized into these hierarchical bins.
- Mark In / Mark Out:** A timecode field in the center of the playback controls, showing "In: 00:00:00:00" and "Out: 00:00:00:00".
- Grab Still Frame:** A camera icon button located below the Mark In/Out field.
- Logging Information:** A section below the Mark In/Out field containing fields for Name, Description, Reel, Scene, Take, and Angle.
- Capture options:** Buttons for "Capture", "Clip", and "Batch" located below the logging information.
- Transport Controls:** A row of playback controls including stop, play, and fast forward buttons.
- Audio channel enable/disable:** A row of 16 buttons labeled 1 through 16, used to enable or disable individual audio channels.
- Audio Meters:** A set of 16 vertical level meters corresponding to the audio channels.
- Remote indicator:** A "VTR OK" indicator at the top right of the playback controls.

36 Blackmagic Media Express

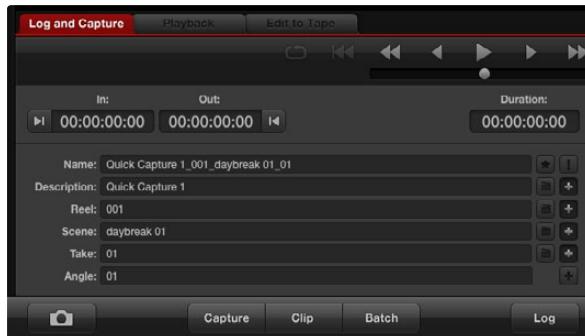

Enter a description for your video



Set the desired number of audio channels to be captured

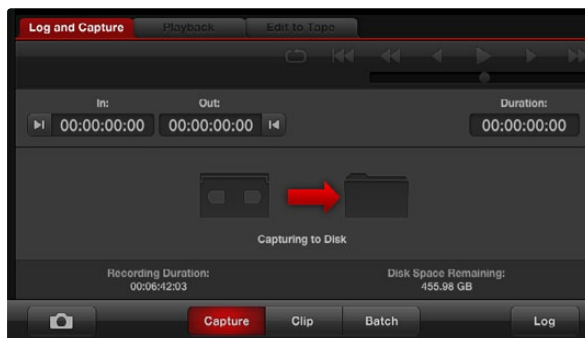

Click the "Capture" button to commence recording

Capture

Capturing video is easy and all you need to do is connect a video source, set the Media Express preferences and press the Capture button.

Start by connecting your video source to an input of your Blackmagic video hardware and check that the Blackmagic system preferences are set to the same video input, e.g. SDI, HDMI or analog.

Open Media Express and set its preferences to the desired project video format and capture file format. The project video format must be set correctly otherwise you will not see your video in the preview pane.

Click the red Log and Capture tab and enter a description for your video into the Description field of the logging information area.

Click the "+" button next to the Description to add it to the automatic Name field. Click the "+" button next to any of the other fields that you wish to add to the Name field.

You can increment the value in each of these fields by clicking on the corresponding clapper board icon. Alternatively you can type directly in to any field to customize its name and number.

The text in the automatic Name field will be applied to the clip(s) which are about to be captured.

Click the "star" icon next to the Name field if you want to log the clip as a favorite.

Click the "!" icon next to the Name field if you wish a clip name confirmation prompt to appear before every capture. This will provide you with the chance to change the clip name.

Set the desired number of audio channels to be captured and then click the "Capture" button to start recording.

To end capture, click the "Capture" button again to automatically keep the clip. Alternatively press the "Esc" key if you want to be prompted to delete or save the clip.

The captured clips will be added to the Media List.

Logging clips

Ensure an RS-422 serial cable is connected between your Blackmagic video hardware and the deck. The Remote/Local switch must be set to Remote on the deck so you can use the transport controls in Media Express. Use the standard j, k, l shortcut keys to shuttle backwards, pause and shuttle forwards on the deck.

Click the Mark In button to mark the In point, or use the shortcut key **i**.

Click the Mark Out button to mark the Out point, or use the shortcut key **o**.

Click the Log Clip button to log the clip, or use the shortcut key **p**. The entry should now appear in the Media List with a red X in its icon to indicate the media is offline.

37 Blackmagic Media Express

Batch Capture

After logging a clip, you can click the Clip button if you just want to capture a single clip.

If you want to capture multiple clips, continue logging all the clips that you wish to batch capture.

When logging is completed, select the logged clips in the Media List and:

- click the Batch button, or
- right-click on the selection and select 'Batch Capture', or
- go to the File menu and choose Batch Capture.

Media Express will cue the tape and precisely capture the clip from the In to the Out timecode points, including any handles specified in the Media Express preferences.

DPX Capture

If you want to capture a DPX image sequence rather than a movie file, open the Media Express preferences and set the Capture File Format to DPX 10-Bit RGB. You will need a fast disk array to cope with the uncompressed, 10-bit RGB format.

- Create a DPX project by setting the capture file format to DPX.
- Capture.

When the capture has been completed, a single thumbnail will appear in the Media List representing the entire frame sequence. The sequence of DPX frames will be stored in its own folder in your disk storage. Audio will be stored in a .wav file in the same folder.

By default, DPX captures are assumed to be from YUV sources. If you need to capture from an RGB source, disable the "Capture to DPX from a YUV source" option otherwise your DPX files will show weird pink and green colors.

If you want the DPX frame numbers to be based on the timecode of the captured video, rather than just starting from zero, enable the option to "Use absolute frame numbering when capturing DPX".

If you aren't performing long DPX captures, you may wish to reduce the number of zeroes in the frame numbers by changing the option, "When capturing DPX files, use (2-8) digit numbers in the frame count.

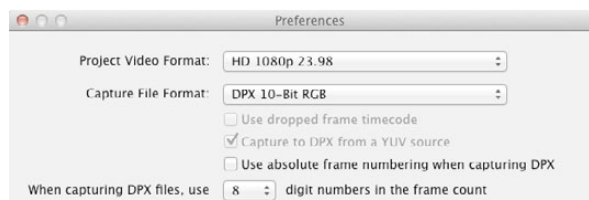

DPX capture preferences

38 Blackmagic Media Express

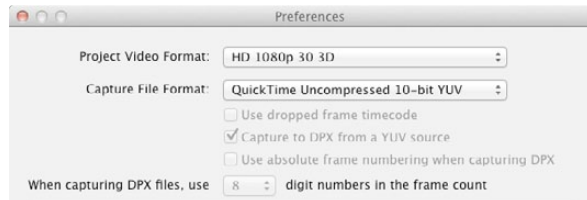

Select a project video format with "3D" in its name to capture dual-stream stereoscopic 3D video clips

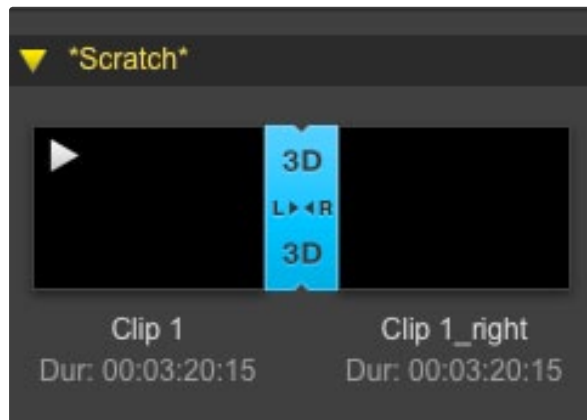

In Thumbnail view, the left and right eye clips are connected by a 3D indicator and presented as a single, large icon.

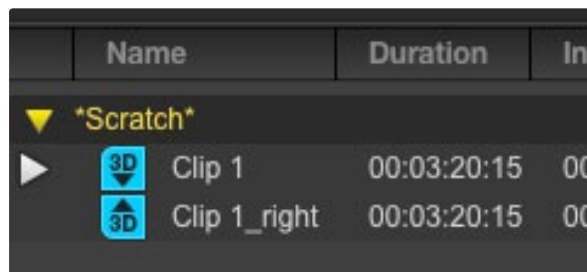

In Timecode List view, the left and right eye clips are listed on two lines and linked together by a 3D indicator.

3D Capture

When Media Express is used with a Blackmagic video hardware model which supports dual-stream 3D, you can create left and right eye 3D video clips by capturing 2 streams of HD-SDI video simultaneously.

- Create a 3D project which matches the frame rate of your dual stream 3D video source.
- Ensure you have 2 discrete HD-SDI video inputs to the Blackmagic video hardware.
- Capture.

When capturing and logging dual stream 3D in Media Express, the clip name will be applied to the left eye video. The right eye video will be appended with '_right' text. For example, if you name the stereo clip "Clip 1", the left eye clip will be called "Clip 1.mov" and the right eye clip will be called "Clip 1_right.mov".

The Media List presents an eye-catching indication that the captured clip is a 3D clip:

- In Thumbnail view, the left and right eye clips are connected by a 3D indicator and presented as a single, large icon.
- In Timecode List view, the left and right eye clips are listed on two lines and linked together by a 3D indicator.

39 Blackmagic Media Express

The screenshot displays the Blackmagic Media Express interface with several key components annotated:

- Media List:** Located on the left side, it shows a hierarchy of clip bins including "Scratch" (6 Clips), "Todays rushes" (12 Clips), "VFX plates" (14 Clips), and "New shots from location 2" (5 Clips). Each clip is represented by a thumbnail and its duration.
- Timecode List, Thumbnail and Favorites view:** This view is integrated into the Media List area, showing a grid of thumbnails and their corresponding timecodes.
- Search Field:** A search bar is located at the top right of the Media List area.
- VTR / deck timecode:** A timecode display at the top center of the video preview window shows "00:00:07:07".
- Video Preview:** The main window on the right displays a video of a fighter jet in flight. A "ZOIC" logo is visible in the bottom right corner of the preview.
- Project name, video format and frame rate:** Located at the bottom left of the interface, it reads "Project Untitled HD 1920x1080p 23 98fps".
- Clip Bins:** The left side of the interface is organized into several clip bins, each with a yellow arrow icon and a clip count.
- Mark In / Mark Out:** A control panel below the video preview window allows for setting in and out points for clips.
- Clip Information:** A panel below the Mark In / Mark Out controls displays metadata for the selected clip, including Name, Description, Reel, Scene, Take, and Angle.
- Grab Still Frame:** A camera icon button used to capture a still frame from the video.
- Favorites Selection:** A star icon button used to mark clips as favorites.
- Transport Controls:** A set of playback controls including play, stop, and fast forward buttons.
- Audio channel enable/disable:** A row of buttons labeled V, 1, 2, 3, 4, 5, 6, 7, 8, 9, 10, 11, 12, 13, 14, 15, 16, used to enable or disable specific audio channels.
- Audio Meters:** A set of vertical meters used to monitor the audio levels of the selected channels.
- Remote indicator:** A "VTR OK" indicator at the bottom right of the video preview window.

40 Blackmagic Media Express

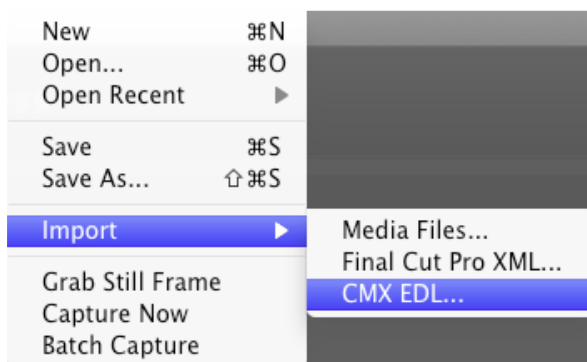
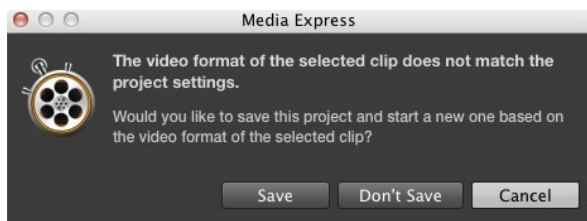

There are three ways to import clips in to Media Express

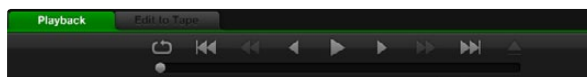

You can use the transport controls to play, stop, jump to the next or previous clip and loop playback of your clips.

Playing back Video and Audio Files

Importing clips

You can play back your video and audio files after importing media in to Media Express in any of the following ways:

- Double-click an empty area of the Media List.
- Right-click an empty area of the Media List and select Import Clip from the contextual menu.
- Go to the File menu, select Import and then Media Files.

Then select the clip(s) you wish to import from the Open Video Clip dialog box. The clips will appear in the Scratch area of the Media List. If you have created your own bins in the Media List, you can drag the clips in to the desired bin.

If you want to import media directly to a bin, right-click within the desired bin and select Import Clip from the contextual menu.

If the files being imported do not match the frame rate and size of existing clips in the Media List, you will be prompted to create a new project and to save the current project.

Another way to import media is to use an XML file which has been exported from Final Cut Pro 7. Go to the File menu, select Import and then Final Cut Pro XML. Open the desired XML and all the bins and media from the Final Cut Pro project will appear in the Media List.

Media Express also supports the import of CMX EDL files to batch capture clips using EDL files from other video software. Go to the File menu, select Import and then CMX EDL. Select the EDL and open it. The logging information will appear in the Media List. Select the logged clips and perform a batch capture to import the clips from your deck.

Playing back single and multiple clips

To play back a single clip, double-click the clip in the Media List. Alternatively select the clip in the Media List and press the space bar on your keyboard or the play button in the transport controls.

To play back multiple clips, select the clips in the Media List and then press the space bar on your keyboard or the play button in the transport controls.

Your video will play back in the video preview pane of Media Express and on all the video outputs of your Blackmagic video hardware. During playback, the audio channels being monitored can be switched on or off via the track enable/disable buttons.

41 Blackmagic Media Express

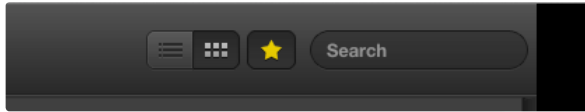

In the Media List, choose to view your clips in Timecode List view or Thumbnail view.



Click the popup info icon on a thumbnail to view its info bubble.

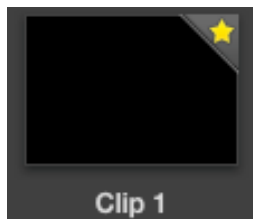

Clips marked as favorites are easily identified by the yellow star in their icon.

Browsing Media

In the Media List, you can view your clips in Thumbnail view or Timecode List view by clicking on the desired view button at the top-right of the Media List.

Thumbnail view

Thumbnails are the most intuitive way to display your clips. To get information for a clip, hover your mouse over the clip's thumbnail and then click on the popup info icon which will appear at the bottom-right of the thumbnail. Click the info bubble to hide it.

List view

You can view your clips in Timecode List view by clicking on the Timecode List button at the top-right of the Media List. Use the horizontal scroll bar at the bottom of the Media List to view all the columns of information for your clips including: in and out points, video format, audio channels, field dominance and logging information.

Creating and using bins

To create a bin for your clips, right click an empty spot in the Media List and select "Create Bin". Type in a name for the new bin.

You can move clips from the Scratch, or from one bin to another, by dragging the clip icons to the desired bin. If you want a clip to appear in more than one bin, import the same clip again by right-clicking on the bin and choosing "Import Clip".

By default, logged clips appear in the Scratch. If you want to log clips and have them appear in a new bin, right-click the new bin and choose "Select As Log Bin".

Creating and using favorites

In the Log and Capture tab, click the "star" icon next to the Name field if you want to log a clip as a favorite.

In the Playback tab, clicking the "star" icon will make the clip a favorite if it is selected in the Media List. Click the "star" icon again to deselect it as a favorite.

Clips marked as favorites will show a yellow star in their icon in Timecode List view and Thumbnail view.

42 Blackmagic Media Express

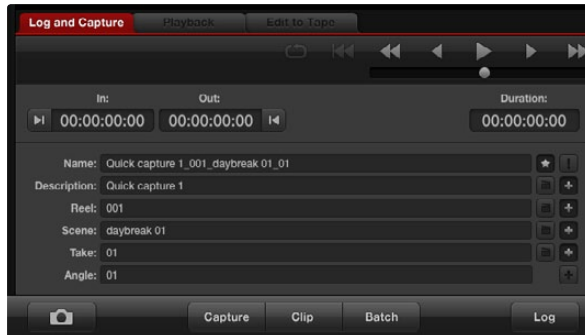

In the Log and Capture tab, click the "star" icon next to the Name field if you want to log the clip as a favorite.

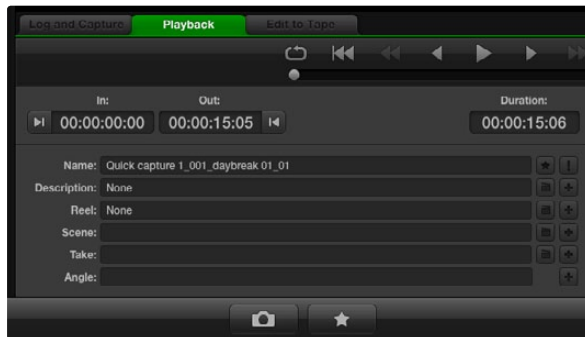

In the Playback tab, clicking the "star" icon will mark a clip as a favorite if it is selected in the Media List.

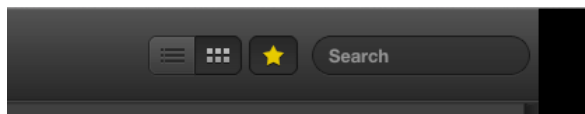

Click the Favorites button at the top of the Media List to only show your favorite clips.

Once you have marked clips as favorites, click on the gray, Favorites, star button at the top of the Media list and it will turn yellow. All clips in your Media List will be hidden except for those marked as favorites. This is similar to creating a playlist and makes it easy to only play back your favorite clips and even master them to tape.

Creating a 3D clip

To add a stereoscopic 3D clip to the Media List:

- select a 3D project video format that is the same frame rate as your 3D media
- import the 'left eye' file into the Media List
- right-click on the 'left eye' file and select 'Set Right Eye Clip' from the contextual menu. If the right eye clip was previously captured by Media Express, the right eye video will be appended with '_right' text. For example, if the left eye clip is named "Clip 1.mov", the right eye clip will be called "Clip 1_right.mov".

43 Blackmagic Media Express

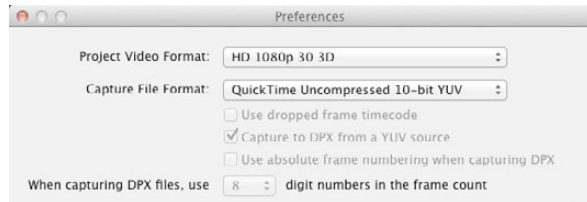

Select a 3D project video format

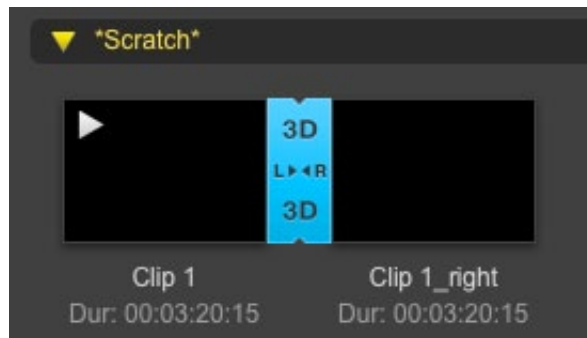

The Media List presents a highly visible indication that the imported clip is a 3D clip.

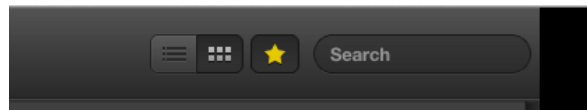

Type in the Search field to find clips.

The Media List presents a highly visible indication that the imported clip is a 3D clip. The left and right eye clips will be displayed side by side in the Video Preview window to indicate you are working with a 3D video project.

If you find the left and right eyes of a 3D stereo clip have been loaded the wrong way around:

- right-click the 3D clip in the Media List
- select 'Swap Eyes' from the contextual menu

Deleting clips and bins

To delete clips, select the unwanted clips and press the forward delete button on your keyboard. This will only delete the clips from the Media List and they will safely remain on your disk storage.

To delete bins, right-click within a bin and choose "Delete Bin". This action will delete the bin and any clips it contained. This will only delete the clips from the Media List and they will safely remain on your disk storage.

Searching the Media List

Clips can easily be found in a project by typing the name of your clips in the Search field at the top of the Media List. When used in conjunction with the favorites feature, the search will be confined to your favorite clips so you will see a shorter list of found clips.

44 Blackmagic Media Express



Mark In /
Mark Out

Record
Modes

Master to
Tape

Audio channel
enable/disable

45 Blackmagic Media Express

Editing Video and Audio Files to Tape

Mastering your clips to a deck is easy. While we usually talk about mastering or editing to "tape", it doesn't matter if your deck uses tapes or disks. To master your clips:

- Select the clips you want to send to tape.
- Click the blue Edit to Tape tab.
- Set the In point and type of edit.
- Master to tape.

Selecting clips to master

From the Media List, select the clips you wish to master to tape. If you only want to send your favorite clips to tape, click the favorite (star) icon at the top of the Media List to show your favorites and hide all other clips. Then select the favorite clips you wish to send to tape.

Insert and Assemble to tape

Click the blue Edit to Tape tab. If "No Remote" appears in the video preview pane, check that an RS-422 serial cable is connected between your Blackmagic video hardware and the deck. The Remote/Local switch needs to be set to Remote on the deck so you can use the transport controls in Media Express.

Enter the In point of the tape by entering timecode into the In point field, or by cueing the tape to the desired point via the transport control and then clicking the Mark In button, or use the shortcut key i.

If no Out point is entered, Media Express will set the duration of the edit to the total length of the clips in the Media List. If an out point is defined, Media Express will stop recording once the Out point timecode is reached, even if some clips have not been output.

The Assemble and Insert buttons are mutually exclusive and only one mode can be selected at a time. Choose to master to tape using Assemble or Insert edit. Then press the Master button.

The Preview and Master buttons are also mutually exclusive. Preview mode mimics the edit process but does not record to tape. This mode lets you check the edit point is correct. Preview edit operations should always be checked on monitors connected directly to the output of the deck. This lets you view the video already on tape and the new video.

If Record Inhibit is enabled either on the deck or on the tape, Media Express will display a dialog box, that Record Inhibit is enabled when you click the Master button. Check the deck and tape. Disable Record Inhibit before trying again.

Before mastering, the audio channels to be put to tape can be selected on or off via the track enable/disable buttons.

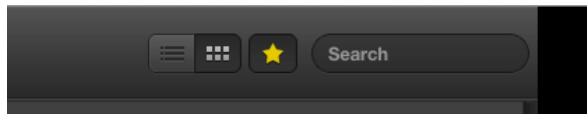

Click the favorite (star) icon at the top of the Media List to only show your favorites

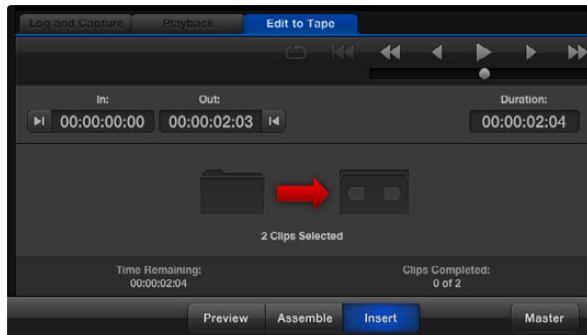

This picture shows that 2 clips have been selected to be sent to tape



Set the desired number of audio channels to be mastered

46 Blackmagic Disk Speed Test

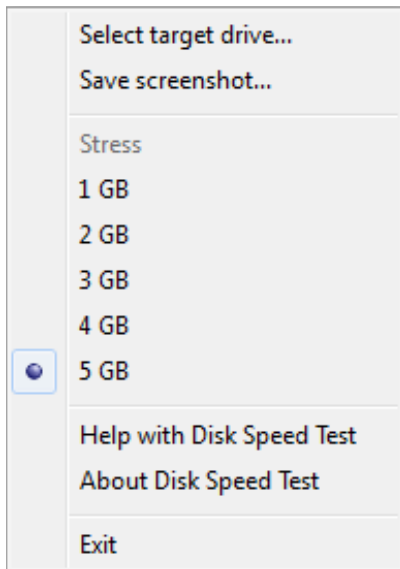

Settings menu

What is Blackmagic Design Disk Speed Test?

Blackmagic Disk Speed Test is a beautiful and fun to use application that measures the read and write performance of storage media in video frame sizes. The use of video frame sizes provides accurate measurement of how the disk storage will perform with video related applications.

If you have ever wondered whether your hard drive is suitable for playback ("read") of a particular video format, you can use Disk Speed Test to find out. With its easy to understand layout, it is now simple to understand what performance you can get out of your media drives with a single click of the Start button! Disk Speed Test will even show you how many streams of video your storage is capable of handling!

Disk Speed Test is included free with any Blackmagic Design product installation on Mac OS X and Windows and can also be downloaded from our website free of charge.

Disk Speed Test takes the guess work out of configuring your storage system for optimal performance for any job you will be doing.

Disk Speed Test settings are accessed by clicking on the Settings button, just above the Start button. On Mac OS X, the same settings are also available from the Menu Bar at the top of your computer display.

Select Target Drive...

Click Select Target Drive to choose the storage volume you wish to test. Ensure you have Read and Write permissions for the selected volume as Disk Speed Test will write a temporary file to it. This file will be automatically deleted when you quit Disk Speed Test.

Save Screenshot

After testing your disk storage, click Save Screenshot to save a screenshot of the results to a chosen location.

Stress

Lower stress settings may be chosen if you want to demonstrate the speed of disk storage quickly. The 1 GB option would be a good choice on a trade show booth to rapidly show the read and write performance of a disk array even though the results might not be quite as accurate as when the 5 GB option is selected.

Disk Speed Test limits each write operation to a maximum of 8 seconds and each read operation to a maximum of 8 seconds so you do not have to wait long to obtain results.

Disk Speed Test Help

Click Disk Speed Test Help to launch the PDF manual for Disk Speed Test.

About Disk Speed Test

About Disk Speed Test displays which version of the Disk Speed Test you are running.

47 Blackmagic Disk Speed Test

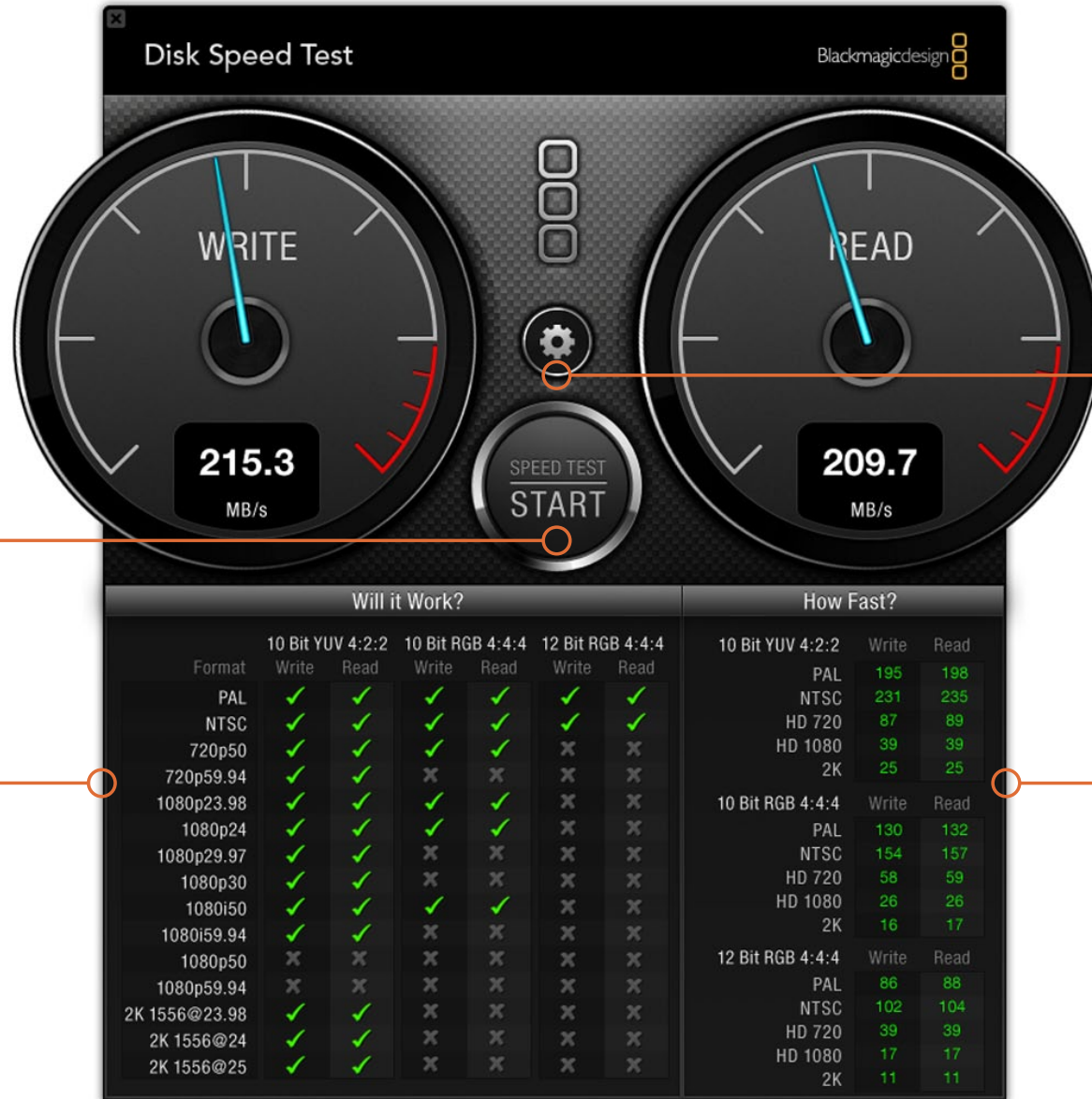

START
Click this button once to start the disk speed test. Click again to stop the test

Will it Work?
This panel shows which video formats can be supported by your disk storage

Settings
Click this button to access the settings before running a disk speed test

How Fast?
This panel shows results in frames per second (fps)

Format	10 Bit YUV 4:2:2		10 Bit RGB 4:4:4		12 Bit RGB 4:4:4	
	Write	Read	Write	Read	Write	Read
PAL	✓	✓	✓	✓	✓	✓
NTSC	✓	✓	✓	✓	✓	✓
720p50	✓	✓	✓	✓	✗	✗
720p59.94	✓	✓	✗	✗	✗	✗
1080p23.98	✓	✓	✓	✓	✗	✗
1080p24	✓	✓	✓	✓	✗	✗
1080p29.97	✓	✓	✗	✗	✗	✗
1080p30	✓	✓	✗	✗	✗	✗
1080i50	✓	✓	✓	✓	✗	✗
1080i59.94	✓	✓	✗	✗	✗	✗
1080p50	✗	✗	✗	✗	✗	✗
1080p59.94	✗	✗	✗	✗	✗	✗
2K 1556@23.98	✓	✓	✗	✗	✗	✗
2K 1556@24	✓	✓	✗	✗	✗	✗
2K 1556@25	✓	✓	✗	✗	✗	✗

Format	10 Bit YUV 4:2:2	
	Write	Read
PAL	195	198
NTSC	231	235
HD 720	87	89
HD 1080	39	39
2K	25	25
Format	10 Bit RGB 4:4:4	
	Write	Read
PAL	130	132
NTSC	154	157
HD 720	58	59
HD 1080	26	26
2K	16	17
Format	12 Bit RGB 4:4:4	
	Write	Read
PAL	86	88
NTSC	102	104
HD 720	39	39
HD 1080	17	17
2K	11	11

48 Blackmagic Disk Speed Test

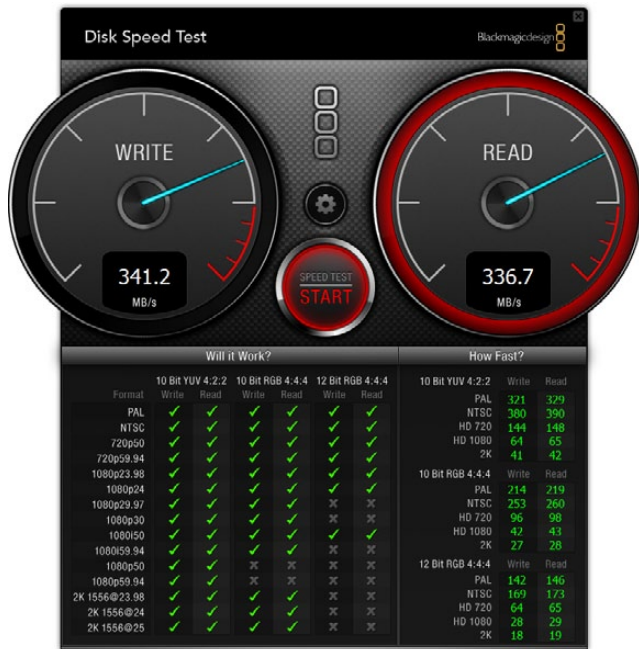

Disk Speed Test interface during a test

Start

Once you have chosen the desired settings, click the Start button to commence the disk speed test. Disk Speed Test will write a temporary file to the selected target drive. When the file has finished writing, or when 8 seconds has elapsed, Disk Speed Test will stop writing and start reading back the temporary file from the drive.

Disk Speed Test will continue writing and reading the nominated size of stress file until you stop the test by clicking the Start button again.

Will it Work?

The "Will it Work?" panel can help to identify video formats where the Read performance might be significantly different to the Write performance. These differences might mean that you can capture a video format but not play it back in real time or else you can play back a video format but not capture it in real time.

The "Will it Work?" panel shows common video formats and instantly displays a check mark or cross to show if the disk performance will be adequate for the desired video format. We suggest you allow Disk Speed Test to perform several test cycles to help reveal any video formats for which the disk storage performance might be marginal. If you observe a check mark and a cross switching between each other for a video format, this would indicate that the disk storage cannot reliably support the video format.

The "How Fast?" results panel shows the frame rates your drive can achieve in frames per second and should be read in conjunction with the "Will it Work?" panel. If the "Will it Work?" panel shows a green check mark for 2K 1556@25fps in 10 Bit YUV 4:2:2, but the "How Fast?" panel shows that a maximum of 25fps will be supported, the disk storage performance is too marginal to be reliable.

How Fast?

After each Read or Write test, the results will be displayed in the "How Fast?" panel. The "How Fast?" results panel also enables you to see how many streams of video can be supported by your disk storage. If the result for "HD 1080" is 70, you can run up to 70 frames of HD 1080 video per second.

This storage speed is capable of supporting the following video formats:

- 2 simultaneous streams of 1080i50 video at 25 fps per stream
- 1 stream of 1080p50 video at 50 fps per stream
- 1 stream of 1080p59.94 video at 59.94 fps per stream

Products Resellers Support Company Events Press Community

Blackmagicdesign

Support Center

UltraStudio Pro for Windows

Change your product >

Downloads

UltraStudio Pro Manual
13 April 2011
Language: English, Size: 6.22 MB
Download >

Desktop Video 8.0.1 for Windows
Date Added: 13 May 2011
Size: 103.61 MB
Download > View archived drivers >

Online Resources

Support Notes
Search our library for UltraStudio support notes.
View >

Still having trouble?
If you can't find the answer to your question in our support material, please contact us via telephone or email.

For technical support in the United States, please have your hardware details and software version ready then.

Telephone +1 408 954 0500 OR
Send request >

Blackmagic Design > Support > UltraStudio Pro Follow us United States | Change your location

All items on this website are copyright Blackmagic Design Pty. Ltd. 2011, all rights reserved. All trademarks are property of their respective owners. MSRP excludes sales taxes/duties and shipping costs.

Getting Help

The fastest way to obtain help is to go to the Blackmagic Design online support pages and check the latest support material available for your Blackmagic Design video hardware.

Blackmagic Design online support pages

The latest manual, software and support notes can be found at the Blackmagic Support Center at www.blackmagic-design.com/support.

Contacting Blackmagic Design support

If you can't find the help you need in our support material, please use the "Send request" button, on the support page for your hardware model, to email a support request. Alternatively call your nearest Blackmagic Design support office at www.blackmagic-design.com/company.

Checking the version currently installed

To check which version of Desktop Video software is installed on your computer, open the Blackmagic Design Desktop Video system preferences. The version number appears prominently in the title bar.

- On Mac OS X, open the System Preferences and look in the "Other" category to locate the Blackmagic Design icon. Click the Blackmagic Design icon to reveal the version number.
- On Windows 7, open the system Control Panel and click on "Hardware and Sound" to reveal the Blackmagic Design Control Panel. Click the Blackmagic Design Control Panel to reveal the version number.
- On Linux, go to "Applications" and then "Sound and Video" to locate the Blackmagic Control Panel. Open the control panel to reveal the version number.

How to get the latest updates

After checking the version of Desktop Video installed on your computer, please visit the Blackmagic Support Center at www.blackmagic-design.com/support to check for the latest updates. While it is usually a good idea to run the latest updates, it is a wise practice to avoid updating any software if you are in the middle of an important project.



Developing custom software using Blackmagic Design hardware

The DeckLink SDK is available to developers who wish to programmatically control Blackmagic video hardware with their own custom software. The DeckLink SDK supports the UltraStudio, DeckLink, Multibridge and Intensity families of products.

The DeckLink SDK provides both low-level control of hardware and high-level interfaces to allow developers to easily perform common tasks. The DeckLink SDK supports technologies including:

- Apple QuickTime
- Microsoft DirectShow
- Apple Core Media
- DeckLink API

Downloading the free Blackmagic Design SDK

The DeckLink SDK is free and can be downloaded from

<http://www.blackmagic-design.com/support/sdks/>

Joining the Blackmagic Design developer list

The Blackmagic Developer mailing list is designed for technical questions regarding technologies used by Blackmagic Design, eg QuickTime, Core Media, DirectShow, codecs, APIs, SDKs, etc. The free mailing list is a forum where developers can discuss ideas and problems with other developers. Any subscriber may reply and the Blackmagic Design engineers may also respond when appropriate. You can subscribe to the mailing list at: <http://lists.blackmagic-design.com/mailman/listinfo/bmd-developer>

In some cases, we might request a brief outline of the software you are developing if it is not immediately obvious from your domain name that your organization develops video software. Please don't take offence as we're simply trying to keep the list free of spam and viruses as well as end-user customers asking non-development questions, employment agents or sales people trying to promote products on the list. The list is just for developers.

Contacting Blackmagic Design developer assistance

You can also contact us via developer@blackmagic-design.com if you have any developer related questions or wish to ask questions off the list.

Blackmagic 2K Format – Overview

The latest Blackmagic Design products use the new 3 Gb/s SDI video, which allows twice the data rate of traditional HD-SDI video. We thought it would be a really nice idea to add 2K film support, via this new 3 Gb/s SDI technology, so we could simplify feature film workflows. With the popularity of Blackmagic Design editing systems worldwide, now thousands of people can benefit from a feature film workflow revolution.

This information includes everything product developers need to know for building native 2K SDI equipment. Of course, all Blackmagic products can be updated, so if the television industry adopts an alternative SDI-based film standard, we can add support for that too!

Frame Structure

- Transmitted at 23.98, 24 or 25 frames per second as a Progressive Segmented Frame.
- Active video is 2048 pixels wide by 1556 lines deep.
- Total lines per frame : 1650
- Active words per line are 1535. One word consists of a 10-bit sample for each of the four data streams, i.e. a total of 40 bits. See the diagram named Blackmagic 2K Format - Data Stream Format.
- Total active lines : 1556
- Total words per line : 1875 for 23.98/24Hz and 1800 for 25Hz.
- Fields per frame : 2, 825 lines each
- Active lines located on lines 16-793 (field 1) and 841-1618 (field 2).

Transport Structure

- Based on SMPTE 372M Dual Link mapping and SMPTE 425M-B support for mapping SMPTE 372M into a single 3 Gb/s link.
- Timing reference signals, line number and line CRC insertion is the same as above.
- Optional ancillary data is inserted into both virtual interfaces.
- At present, only audio data is included: as per standard HD audio insertion (SMPTE S299M) the audio data packets are carried on data stream two and audio control packets are carried on data stream one.
- During active video, 10-bit Red, Green and Blue data is sent in the following sequence:
 - Data stream 1: Green_1, Green_2, Green_3, Green_5...Green_2047
 - Data stream 2: Blue_1, Blue_2, Green_4, Blue_5...Green_2048.
 - Data stream 3: Red_1, Blue_3, Blue_4, Red_5...Blue_2048.
 - Data stream 4: Red_2, Red_3, Red_4, Red_6...Red_2048.

The diagram, Vertical Timing Reference, shows the vertical timing details with line numbers and Field, Vertical and Horizontal bits for the Timing Reference Signal codes.

The diagram, Data Stream Format, shows the data stream formats around the optional ancillary data section of the horizontal line. Note that each active pixel takes up three samples.

52 Developer Information

Blackmagic 2K Format – Vertical Timing Reference

		FIELD 1					ACTIVE						
F	1	0	0	0	0	0	0	0	0	0	0	0	0
V	1	1	1	1	1	1	0	0	0	0	1	1	
LINE #	1650	1	2	...	14	15	16	...	792	793	...	825	

		FIELD 2					ACTIVE						
F	0	1	1	1	1	1	1	1	1	1	1	1	1
V	1	1	1	1	1	1	0	0	0	0	1	1	
LINE #	825	826	827	...	839	840	841	...	1617	1618	...	1650	

53 Developer Information

Blackmagic 2K Format – Data Stream Format

WORD# 25 PsF	WORD# 23.98/24 PsF	DATA STREAM 4	DATA STREAM 3	DATA STREAM 2	DATA STREAM 1
1795	1870	R2042	R2041	B2041	G2041
1796	1871	R2043	B2043	B2042	G2042
1797	1872	R2044	B2044	G2044	G2043
1798	1873	R2046	R2045	B2045	G2045
1799	1874	R2047	B2047	B2046	G2046
1800	1875	R2048	B2048	G2048	G2047
1	1	EAV(3FFh)	EAV(3FFh)	EAV(3FFh)	EAV(3FFh)
2	2	EAV(000h)	EAV(000h)	EAV(000h)	EAV(000h)
3	3	EAV(000h)	EAV(000h)	EAV(000h)	EAV(000h)
4	4	EAV(XYZh)	EAV(XYZh)	EAV(XYZh)	EAV(XYZh)
5	5	LN0	LN0	LN0	LN0
6	6	LN1	LN1	LN1	LN1
7	7	CRC0	CRC0	CRC0	CRC0
8	8	CRC1	CRC1	CRC1	CRC1
9	9	200	040	ANC/AUDIO DATA	ANC/AUDIO DATA
...	ANC/AUDIO DATA	ANC/AUDIO DATA
260	335	200	040	ANC/AUDIO DATA	ANC/AUDIO DATA
261	336	SAV(3FFh)	SAV(3FFh)	SAV(3FFh)	SAV(3FFh)
262	337	SAV(000h)	SAV(000h)	SAV(000h)	SAV(000h)
263	338	SAV(000h)	SAV(000h)	SAV(000h)	SAV(000h)
264	339	SAV(XYZh)	SAV(XYZh)	SAV(XYZh)	SAV(XYZh)
265	340	R2	R1	B1	G1
266	341	R3	B3	B2	G2
267	342	R4	B4	G4	G3
268	343	R6	R5	B5	G5

54 Connection Reference Guide

DeckLink Duo

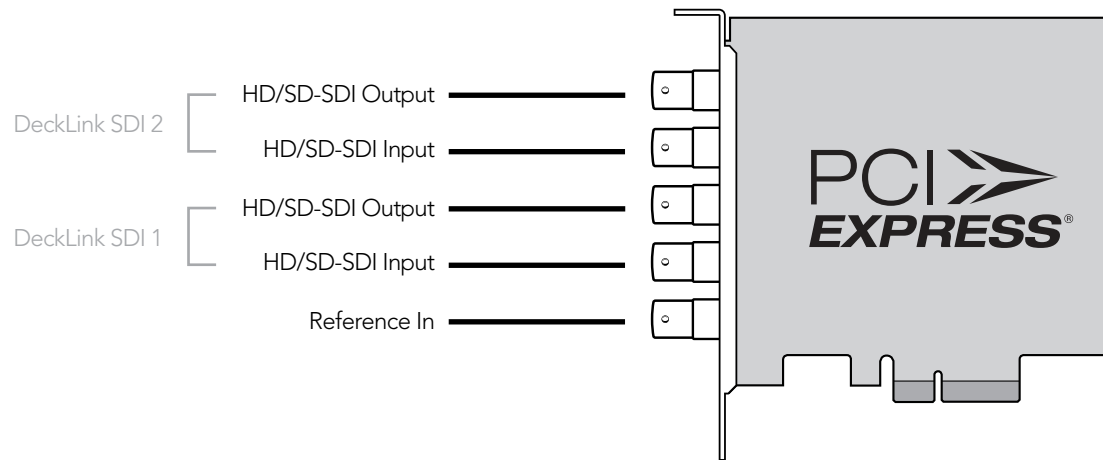

55 Connection Reference Guide

DeckLink HD Extreme 3D+

All SDI inputs and outputs support 3 Gb/s SDI and 2K.

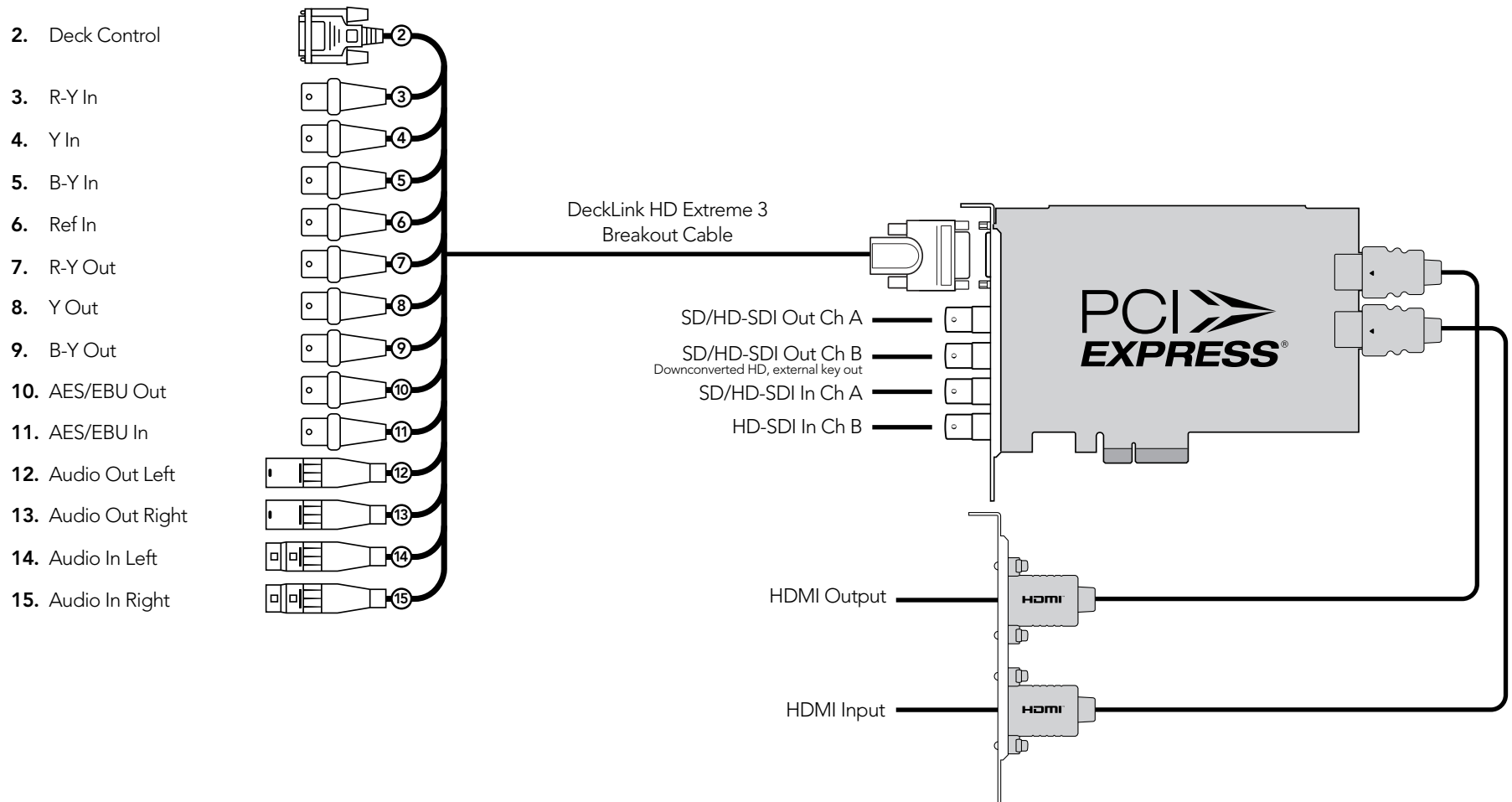

56 Connection Reference Guide

DeckLink Optical Fiber

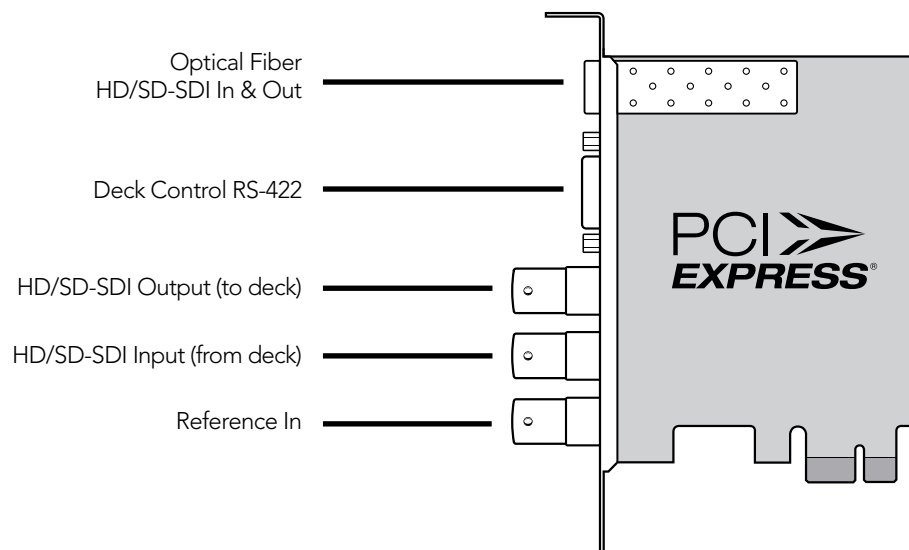

DeckLink Quad

DeckLink Quad uses DIN 1.0/2.3 rather than larger BNC type connectors.

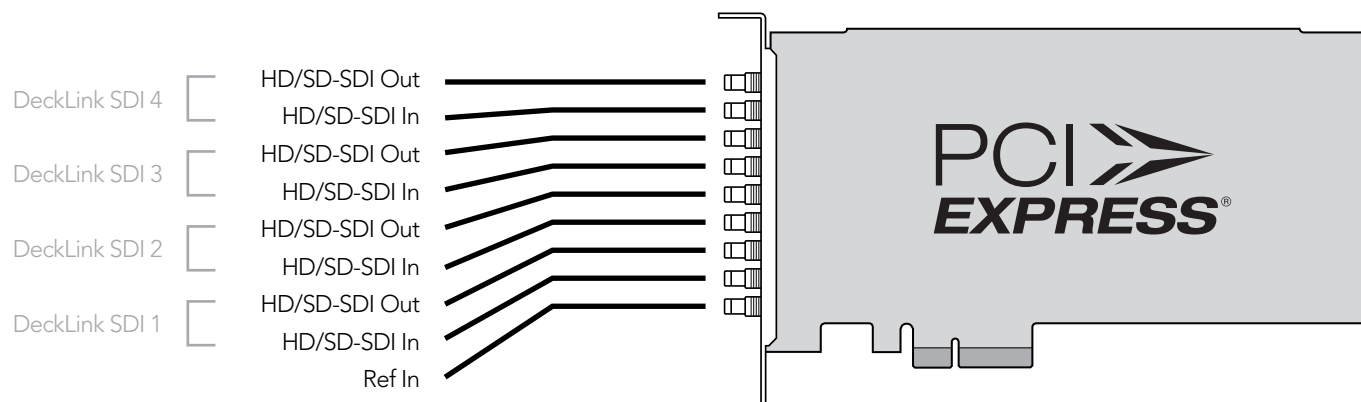

58 Connection Reference Guide

DeckLink SDI

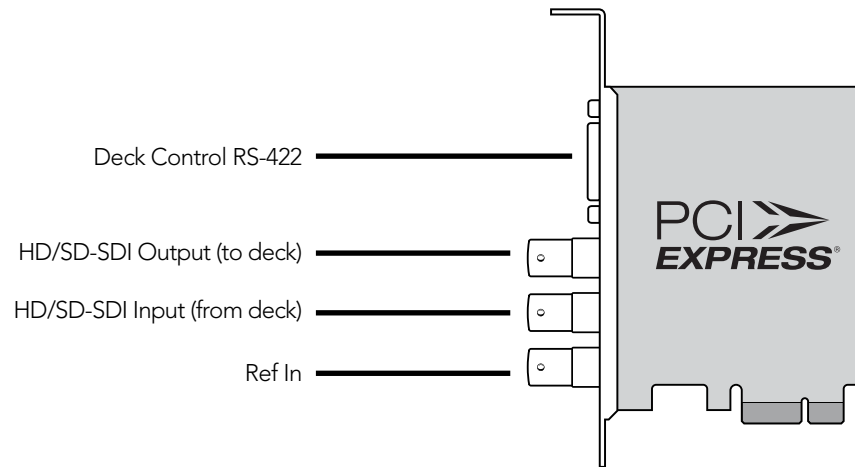

DeckLink Studio 2

- 2. RS-422 Deck Control
- 3. R-Y Out
- 4. Y Out
- 5. B-Y Out
- 6. Ref In
- 7. R-Y In
- 8. Y In
- 9. B-Y In
- 10. AES / EBU Out CH1&2
- 11. AES / EBU In CH1&2
- 12. Analog Audio Out 1
- 13. Analog Audio Out 2
- 14. Analog Audio In 1
- 15. Analog Audio In 2
- 16. Analog Audio In 3
- 17. Analog Audio In 4
- 18. Analog Audio Out 3 or AES/EBU CH3&4 Out
- 19. Analog Audio Out 4 or AES/EBU CH5&6 Out
- 20. Composite In
- 21. Composite Out
- 22. S-Video In
- 23. S-Video Out
- 24. Standard Definition SDI Out

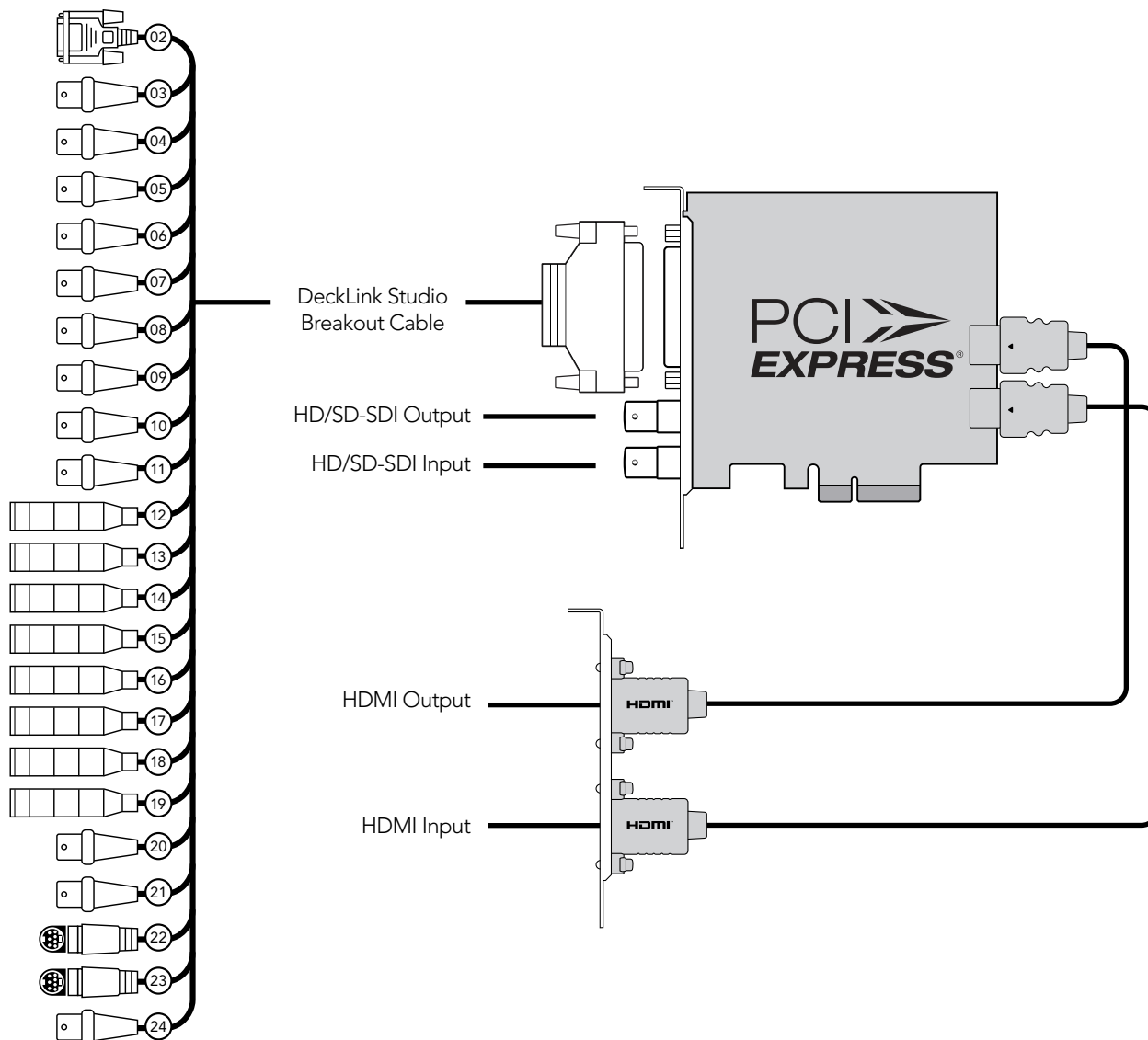

60 Connection Reference Guide

Intensity Pro

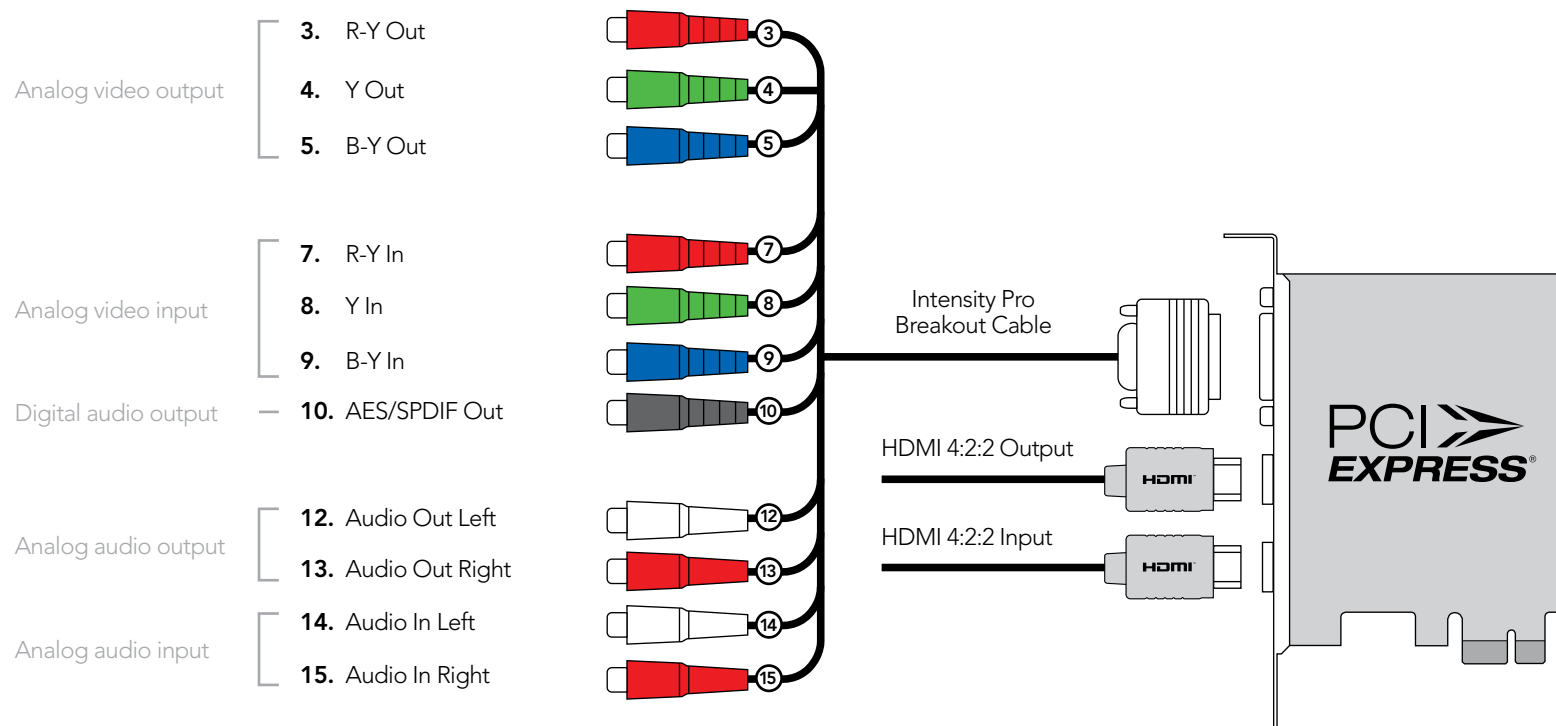

61 Connection Reference Guide

Intensity Shuttle

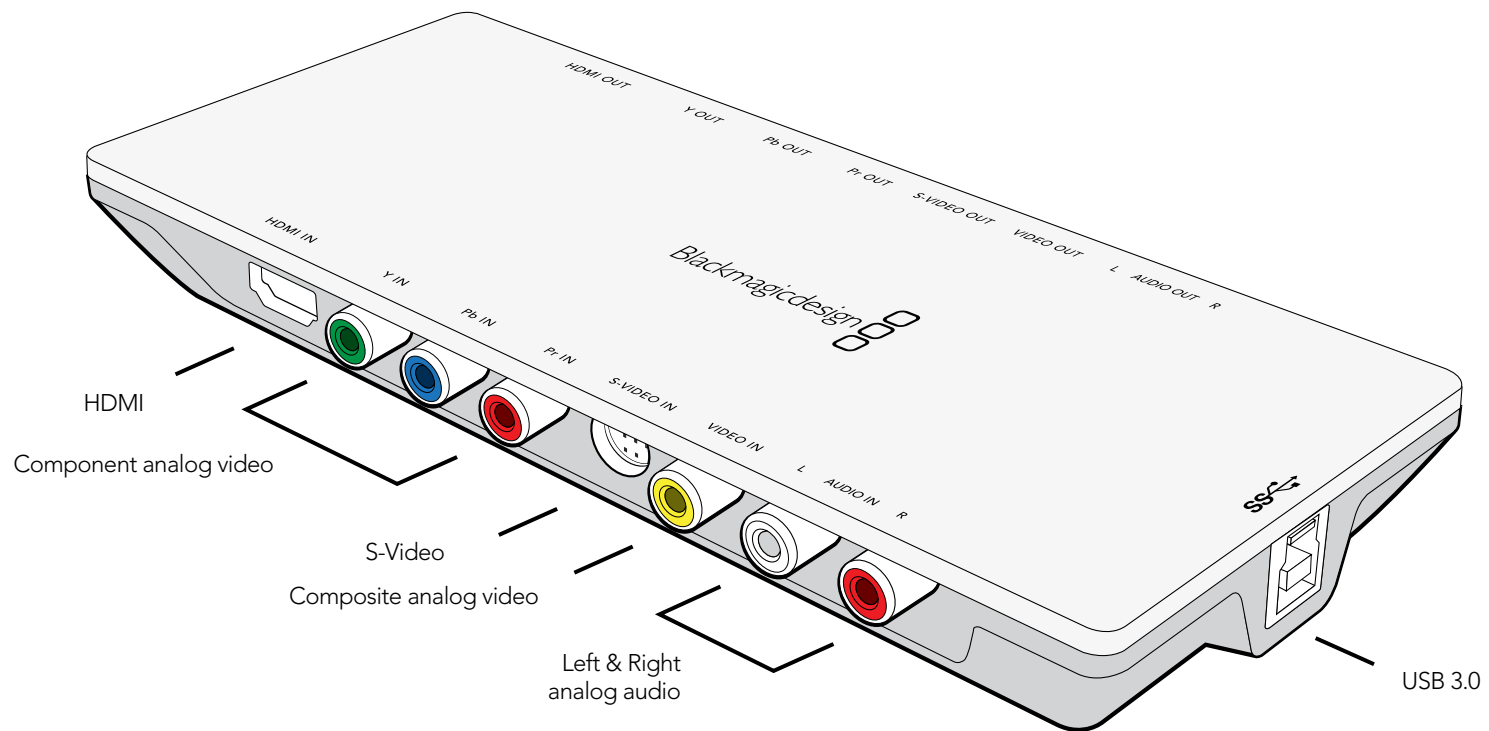

62 Connection Reference Guide

Multibrige Eclipse

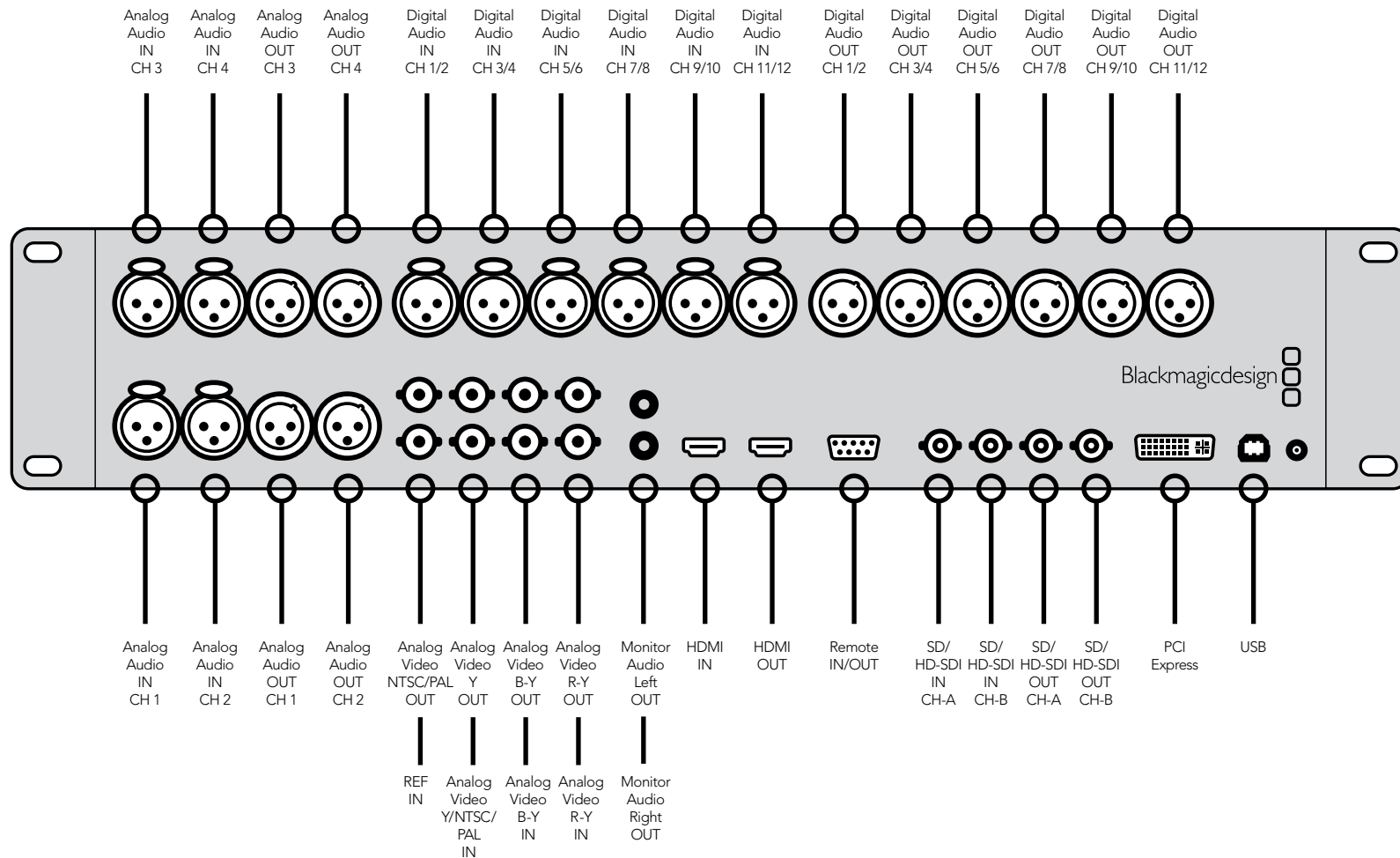

63 Connection Reference Guide

Multibrige Pro

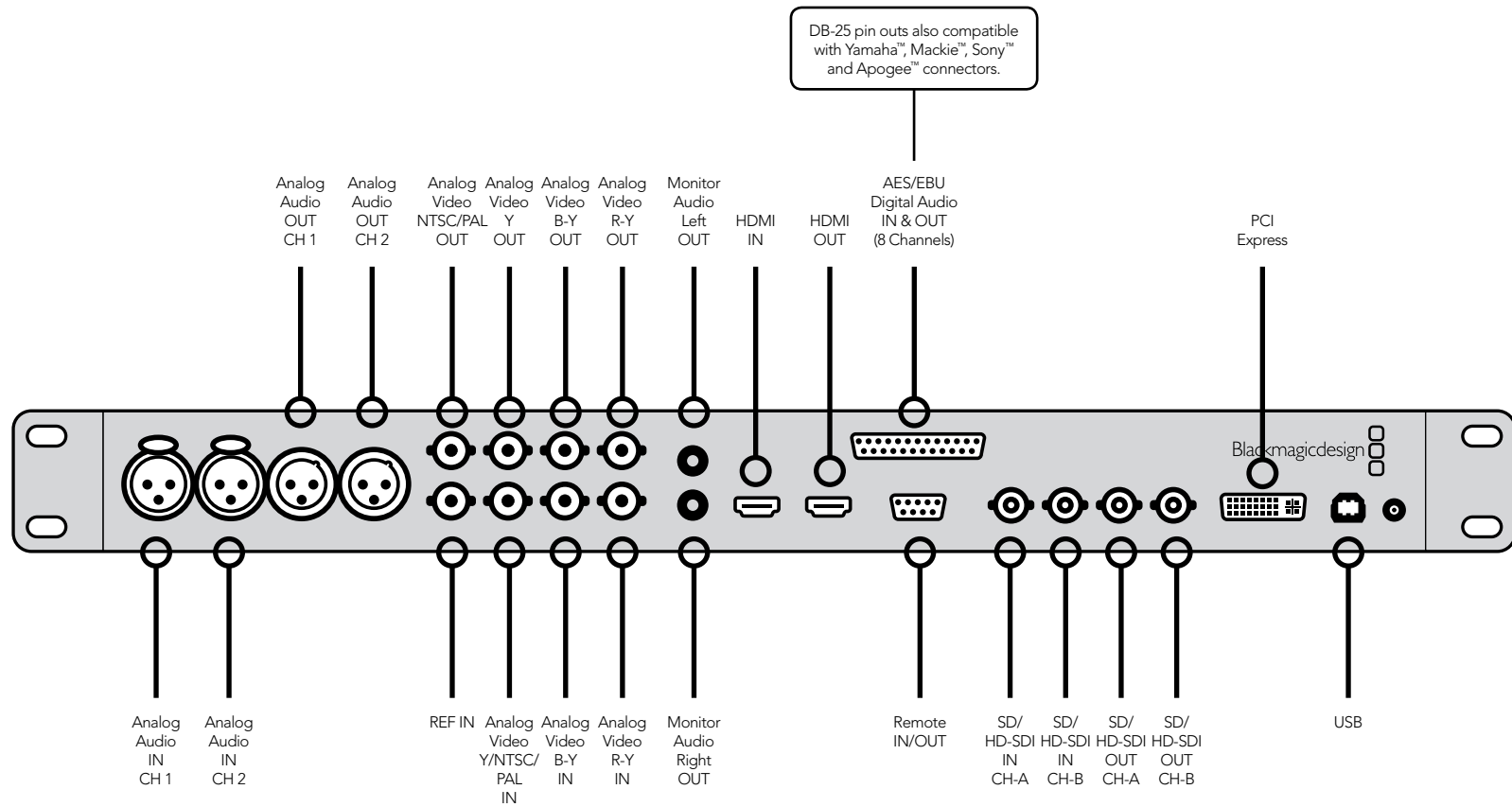

64 Connection Reference Guide

UltraStudio 3D

- 2. Deck Control
- 3. R-Y In
- 4. Y In
- 5. B-Y In
- 6. Ref In
- 7. R-Y Out
- 8. Y Out
- 9. B-Y Out
- 10. AES/EBU Out
- 11. AES/EBU In
- 12. Audio Out Left
- 13. Audio Out Right
- 14. Audio In Left
- 15. Audio In Right

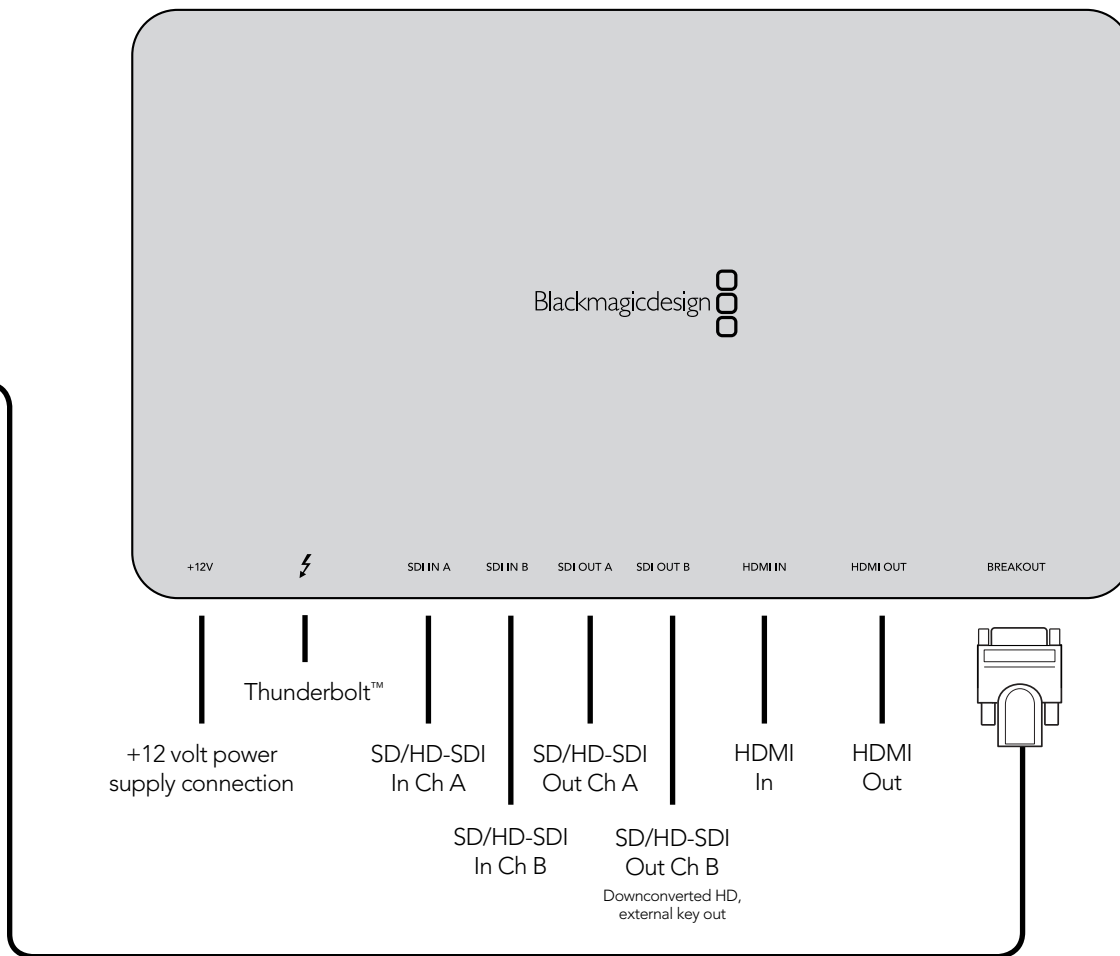
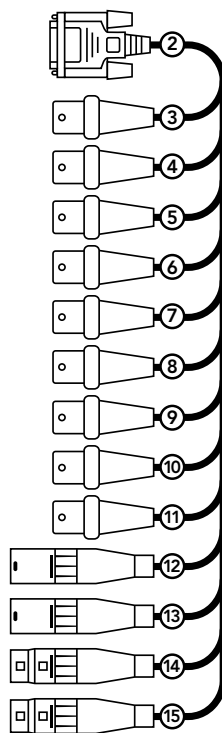

UltraStudio 3D Breakout Cable

65 Connection Reference Guide

UltraStudio Pro

- 2. RS-422 Deck Control
- 3. R-Y Out
- 4. Y Out
- 5. B-Y Out
- 6. Ref In
- 7. R-Y In
- 8. Y In
- 9. B-Y In
- 10. AES / EBU Out CH1&2
- 11. AES / EBU In CH1&2
- 12. Analog Audio Out 1
- 13. Analog Audio Out 2
- 14. Analog Audio In 1
- 15. Analog Audio In 2
- 16. Analog Audio In 3
- 17. Analog Audio In 4
- 18. Analog Audio Out 3 or AES/EBU CH3&4 Out
- 19. Analog Audio Out 4 or AES/EBU CH5&6 Out
- 20. Composite In
- 21. Composite Out
- 22. S-Video In
- 23. S-Video Out
- 24. Standard Definition SDI Out

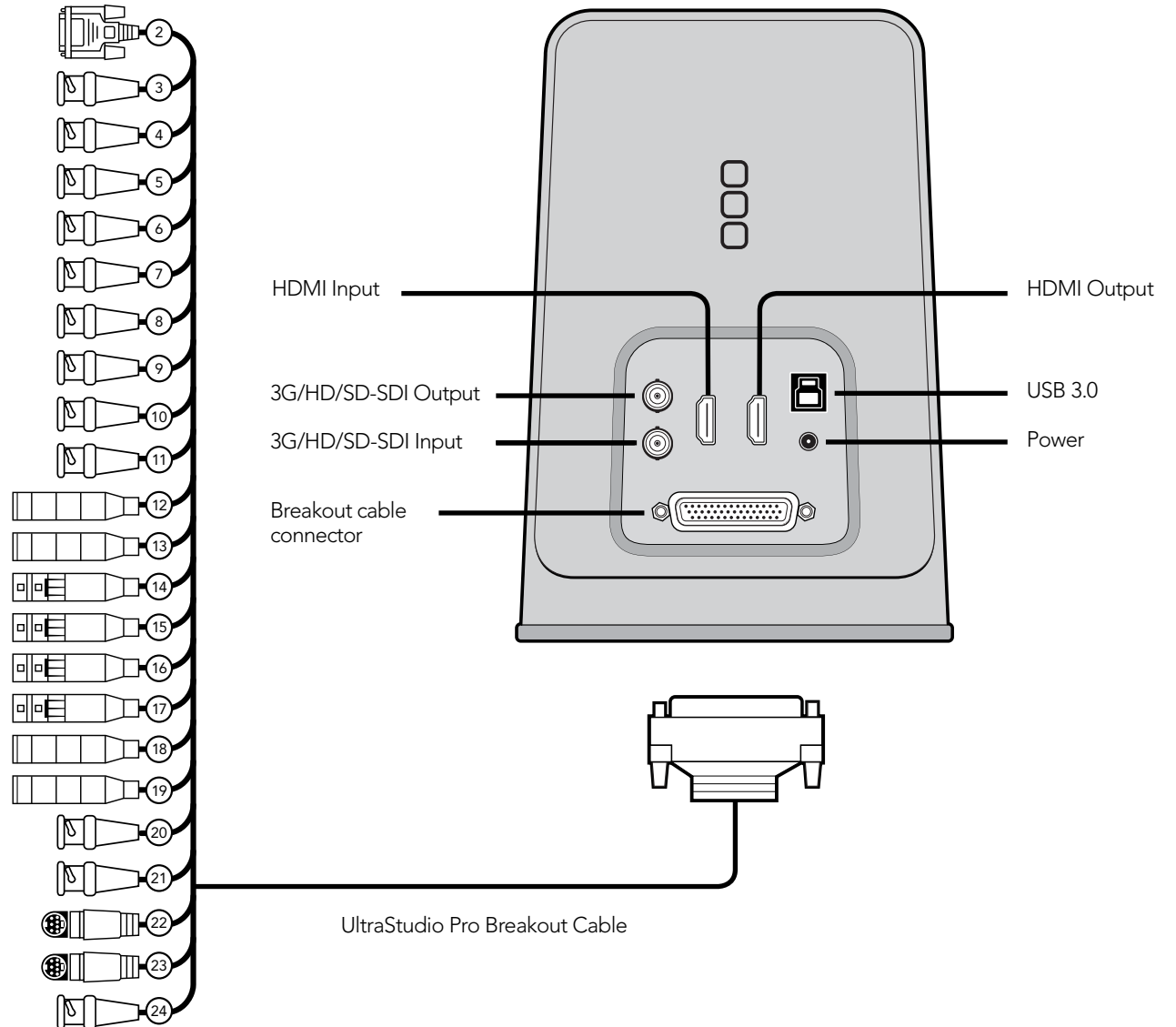

66 Connection Reference Guide

UltraStudio SDI

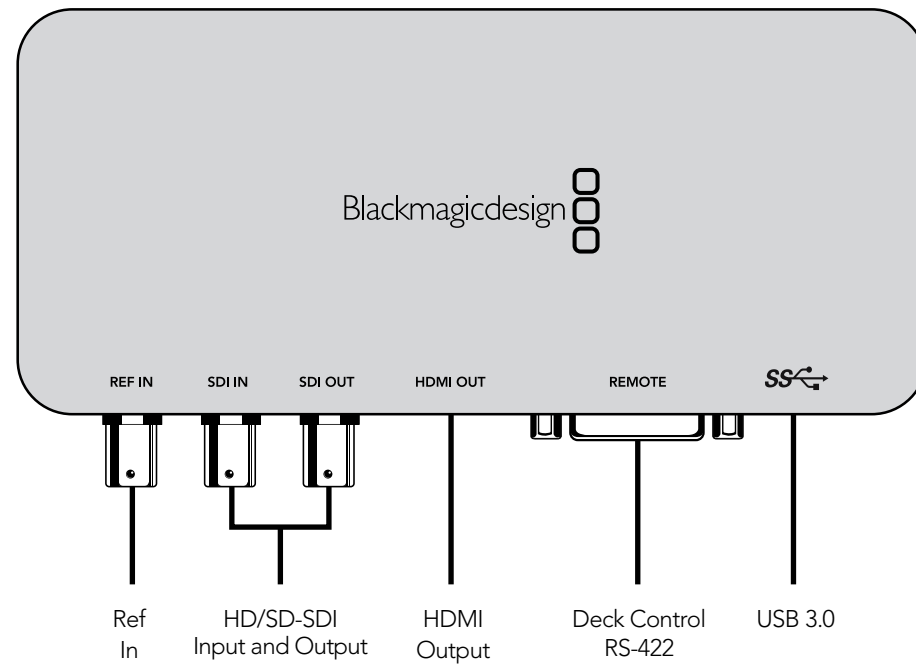

Limited Warranty

Blackmagic Design warrants that UltraStudio, DeckLink and Multibridge family products will be free from defects in materials and workmanship for a period of 36 months from the date of purchase excluding connectors, cables, cooling fans, fiber optic modules, fuses, keyboards and batteries which will be free from defects in materials and workmanship for a period of 12 months from the date of purchase. Blackmagic Design warrants that Intensity family products will be free from defects in materials and workmanship for a period of 12 months from the date of purchase. If a product proves to be defective during this warranty period, Blackmagic Design, at its option, either will repair the defective product without charge for parts and labor, or will provide a replacement in exchange for the defective product.

In order to obtain service under this warranty, you the Customer, must notify Blackmagic Design of the defect before the expiration of the warranty period and make suitable arrangements for the performance of service. The Customer shall be responsible for packaging and shipping the defective product to a designated service center nominated by Blackmagic Design, with shipping charges pre paid. Customer shall be responsible for paying all shipping charges, insurance, duties, taxes, and any other charges for products returned to us for any reason.

This warranty shall not apply to any defect, failure or damage caused by improper use or improper or inadequate maintenance and care. Blackmagic Design shall not be obligated to furnish service under this warranty: a) to repair damage resulting from attempts by personnel other than Blackmagic Design representatives to install, repair or service the product, b) to repair damage resulting from improper use or connection to incompatible equipment, c) to repair any damage or malfunction caused by the use of non Blackmagic Design parts or supplies, or d) to service a product that has been modified or integrated with other products when the effect of such a modification or integration increases the time or difficulty of servicing the product. THIS WARRANTY IS GIVEN BY BLACKMAGIC DESIGN IN LIEU OF ANY OTHER WARRANTIES, EXPRESS OR IMPLIED. BLACKMAGIC DESIGN AND ITS VENDORS DISCLAIM ANY IMPLIED WARRANTIES OF MERCHANTABILITY OR FITNESS FOR A PARTICULAR PURPOSE. BLACKMAGIC DESIGN'S RESPONSIBILITY TO REPAIR OR REPLACE DEFECTIVE PRODUCTS IS THE WHOLE AND EXCLUSIVE REMEDY PROVIDED TO THE CUSTOMER FOR ANY INDIRECT, SPECIAL, INCIDENTAL OR CONSEQUENTIAL DAMAGES IRRESPECTIVE OF WHETHER BLACKMAGIC DESIGN OR THE VENDOR HAS ADVANCE NOTICE OF THE POSSIBILITY OF SUCH DAMAGES. BLACKMAGIC DESIGN IS NOT LIABLE FOR ANY ILLEGAL USE OF EQUIPMENT BY CUSTOMER. BLACKMAGIC IS NOT LIABLE FOR ANY DAMAGES RESULTING FROM USE OF THIS PRODUCT. USER OPERATES THIS PRODUCT AT OWN RISK.

Copyright 2011 Blackmagic Design. All rights reserved. 'Blackmagic Design', 'DeckLink', 'HDLink', 'Workgroup Videohub', 'Videohub', 'DeckLink', 'Intensity' and 'Leading the creative video revolution' are registered trademarks in the US and other countries. All other company and product names may be trade marks of their respective companies with which they are associated.

Thunderbolt and the Thunderbolt logo are trademarks of Intel Corporation in the U.S. and/or other countries.