

Mining Excavator

R 996 B

Operating Weight with Backhoe Attachment:	672,000 kg / 1,481,506 lb
Operating Weight with Shovel Attachment:	676,000 kg / 1,490,325 lb
Engine Output:	2,240 kW / 3,000 hp
Bucket Capacity:	32.00 - 36.00 m ³ / 41.9 - 47.1 yd ³
Shovel Capacity:	32.00 - 36.00 m ³ / 41.9 - 47.1 yd ³



LIEBHERR

R 996 B

Operating Weight with Backhoe Attachment: 672,000 kg / 1,481,506 lb

Operating Weight with Shovel Attachment: 676,000 kg / 1,490,325 lb

Engine Output: 2,240 kW / 3,000 hp

Bucket Capacity: 32.00 - 36.00 m³ / 41.9 - 47.1 yd³

Shovel Capacity: 32.00 - 36.00 m³ / 41.9 - 47.1 yd³







New Backhoe Bucket Design

- Capacity of 36 m³ / 47.1 @ 1.8 t/m³ or 3,000 lb/yd³
- Improved shape for wear reduction
- Perfect match for trucks with 220 t payload and above
- Integrated approach on machine capabilities, material properties and truck target payloads
- Customized and site-specific wear package configuration



Performance by Design

Liebherr's R 996 B provides more productivity at lower cost per tonne mined. The mining excavator remains more than ever the reliable basis in your production. Perfectly suitable for 220 t class trucks and above, the R 996 B sets new standards to your mining operation.

High Productivity

Reach a New Level of Productivity: The R 996 B backhoe attachment has been redesigned to achieve larger bucket capacity. Even under tough conditions Liebherr's R 996 B high digging force allows easy bucket penetration and high bucket fill factors achieving high productivity.

Reliability

Slew system and undercarriage further improve the machine reliability and extend the component lifetime. The enhanced single-line lubrication system and the fuel and oil filtration system also enhance availability of the mining excavator.

Operator Cab

The R 996 B's spacious cab offers ideal working conditions and first-class comfort. The adjustable air suspension seat fits to individual needs. Best visibility over the whole working environment is provided by the enhanced position of the cab. The hanging arch hose arrangement provides direct visibility over large areas of the uppercarriage. Additionally, a camera system shows areas that can't be observed directly. The electronic machine controls assure the best operator performance throughout each shift. Furthermore, the ergonomic component access and long service intervals assist the service team to ensure more uptime.

Safety and Environment

Railings and catwalks help to easily access all relevant machine areas. The 45° access stair helps entering the machine comfortably. In case of emergency stops the stair is automatically lowered. Liebherr also provides solutions for operations close to residential areas with machine specific sound attenuation packages. The approach is based on both removal of noise at the source and passive sound attenuation resulting in low machine noise emissions.

New Easy and Safe Machine Access

- New 45° access system
- Integrated in uppercarriage structure
- Full controlled descent in case of emergency stop
- Strong design



Finite Element Analysis (FEM)

- Multibody simulations
- Fatigue calculations for longest possible lifetimes

Technical Data



Engine

2 Cummins diesel engines

Rating per
SAE J 1995 _____ 2 x 1,120 kW/2 x 1,500 hp at 1,800 rpm
Model _____ K 1800 E
Type _____ 16 cylinder V-engine,
water-cooled,
direct injection,
turbo-charged,
after-cooler

Displacement _____ 50.3 l/3,069 in³
Bore/Stroke _____ 159/159 mm/6.26/6.26 in

Air cleaner _____ dry-type air cleaner with pre-cleaner, with
automatic dust ejector, primary and safety
elements

Fuel tank _____ 13,000 l/3,440 gal

Electrical system
Voltage _____ 24 V
Batteries _____ 8 x 170 Ah/12 V
Alternator _____ 2 x 24 V/150 Amp
Engine idling _____ sensor controlled



Hydraulic System

Hydraulic pumps
for attachment and
travel drive _____ 8 variable flow axial piston pumps
Max. flow _____ 8 x 840 l/min./8 x 222 gpm
Max. hydr. pressure _____ 320 bar/4,640 psi

Hydraulic pumps
for swing drive _____ 4 reversible swash plate pumps, closed-
loop circuit
Max. flow _____ 4 x 413 l/min./4 x 109 gpm
Max. hydr. pressure _____ 350 bar/5,076 psi

Pump management _____ electronically controlled pressure and flow
management with oil flow optimisation

Hydraulic tank capacity _____ 4,600 l/1,215 gal

Hydraulic system
capacity _____ 8,200 l/2,166 gal

Hydraulic oil filter _____ 1 high pressure safety filter after each high
pressure pump + fine filtration of entire
return flow

Hydraulic oil cooler _____ 2 separate coolers, 4 temperature
controlled fans driven via hydraulic piston
motors

Electronic engine
speed sensing _____ over the entire engine RPM range
Lubrication _____ central lubrication system



Hydraulic Controls

Servo circuit _____ independant, electric over hydraulic
proportional controls of each function

Emergency control _____ via accumulator for all attachment func-
tions with stopped engine

Power distribution _____ via monoblock control valves with inte-
grated primary relief valves and flanged on
secondary valves for travel

Flow summation _____ to attachment and travel drive

Control functions
Attachment and
swing _____ proportional via joystick levers
Travel _____ proportional via foot pedals or hand levers
Bottom dump bucket _____ proportional via foot pedals

Operation with one engine possible



Electric System

Electric isolation _____ easy accessible battery isolations

Working lights _____ Xenon lights:
- 4 on working attachment
- 2 on RHS (top of the fuel tank)
- 2 on LHS (top of the hydraulic tank)
- 2 on counterweight
6 additional Xenon lights:
- 2 on the top of the cab
- 2 on the RHS (bottom part of the fuel
tank)
- 2 on the LHS (bottom part of the
hydraulic tank)

Emergency stop switches _____ at ground level, in hydraulic compartment,
in engine compartment and in operator cab

Electrical wiring _____ heavy duty execution in IP 65 standard for
operating conditions of - 50 °C to 100 °C/
- 58 °F to 212 °F



Swing Drive

Hydraulic motor _____ 4 Liebherr axial piston motors

Swing gear _____ 4 Liebherr planetary reduction gears

Swing ring _____ Liebherr, sealed triple roller swing ring,
internal teeth

Swing speed _____ 0 - 3.5 rpm

Swing-holding brake _____ hydraulically released, maintenance-free,
multi-disc brakes integrated in each swing
gear



Uppercarriage

Design _____ torsion resistant designed upper frame in
box type construction for superior strength
and durability

Attachment mounting _____ parallel longitudinal main girders in box-
section construction

Machine access _____ 45° access system with handrails on the
cab side of the uppercarriage. Full con-
trolled descent in case of emergency stop.
Additional emergency ladder fitted near the
cab



Service Flap

Design _____ hydraulically actuated service flap, easily
accessible from ground level to allow:
- fuel fast refill
- hydraulic oil refill
- engine oil quick change
- splitterbox oil quick change
- swing gearbox oil quick change
- swing ring teeth grease barrel refilling via
grease filter
- attachment/swing ring bearing grease
barrel refilling via grease filter
- windshield washer water refilling

Other coupler type on request

Technical Data



Operator's Cab

Design	resiliently mounted, sound insulated, large windows for all-around visibility, integrated falling object protection FOPS
Operator's seat	suspended, body-contoured with shock absorber, adjustable to operator's weight
Cabin windows	20.5 mm/0.8 in tinted armored glass for front window and left hand side windows, all other windows in tinted safety glass, high pressure windshieldwasher-system with 75 l/20 gal watertank, sun louvers on all windows in heavy duty design
Heating system/ Air conditioning	heavy duty, high output air conditioner and heater unit (electronic controlled)
Cabin pressurization	ventilation unit with filters
Controls	joystick levers integrated into armrest of seat
Monitoring	via LCD-Display, data memory
Rear vision system	camera installation on counterweight and left-hand side of the uppercarriage displayed over an additional LCD-display
Automatic engine shut off	in case of low engine oil pressure or low coolant level
Destroking of main pumps	in case of engine overheating or low hydraulic oil level
Safety functions	additional gauges with constant display for: engine speed, hourmeter, engine oil pressure, coolant temperature and hydraulic oil temperature
Noise level (ISO 6396)	L_{pa} (inside cab) = 78 dB(A) with oil/water fans at 100 % and AC fan at 65 %



Undercarriage

Design	3-piece undercarriage, box type structures for center piece and side frames, stress relieved
Hydraulic motor	2 axial piston motors per side frame
Travel gear	Liebherr reduction gear
Travel speed	0 – 2.2 km/h/0 – 1.4 mph
Parking brake	spring engaged, hydraulically released wet multi-disc brakes for each travel motor, maintenance-free
Track components	maintenance-free combined pad-link, heavy duty track shoes
Track rollers/ Carrier rollers	7/3
Automatic track tensioner	pressurized hydraulic cylinder with accumulator, maintenance free
Transport	undercarriage side frames are removable



Central Lubrication System

Type	Lincoln Centromatic lubrication system for the entire attachment/swing ring bearing and teeth
Grease pumps	1 Lincoln Powermaster pump for attachment/swing ring bearing lubrication (second pump with switch over function in option) 1 Lincoln Flowmaster pump for swing ring teeth lubrication
Capacity	600 l/158.5 gal bulk container for attachment/swing ring bearing, separated 80 l/21 gal container for swing ring teeth
Refill	via the service flap for both containers with grease filters



Attachment

Design	box type structure with large steel castings in all high-stress areas
Pivots	sealed with double side centering with 1 single floating pin per side, all bearings with wear resistant, steel bushings, bolts hardened and chromium-plated
Hydraulic cylinders	Liebherr design, all cylinders located in well protected areas
Hydraulic connections	pipes and hoses equipped with SAE split flange connections
Kinematics	Liebherr parallel face shovel attachment geometry

Dimensions

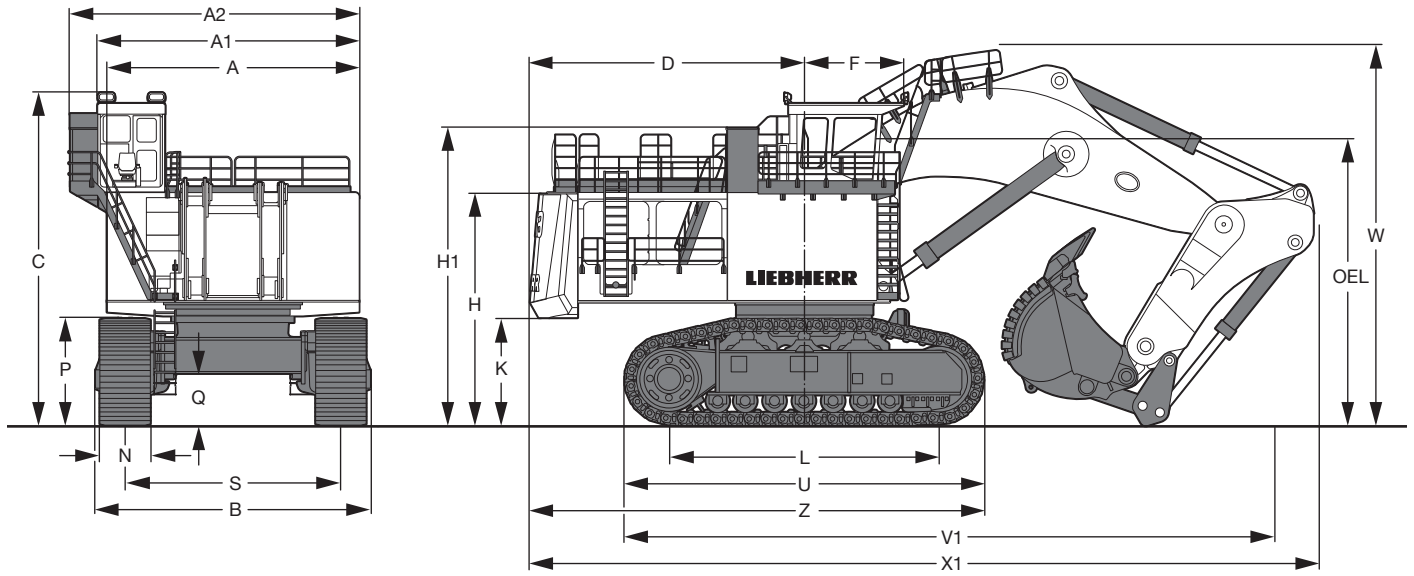

	mm/ft in
A	7,000/22'11"
A1	7,260/23' 9"
A2	8,080/26' 6"
B	7,908/25'11"
C	9,260/30' 4"
D	7,635/25'
E	7,950/26'
F	2,780/ 9' 1"
H	6,435/21' 1"
H1	8,280/27' 1"
K	3,005/ 9'10"

	mm/ft in
L	7,500/24'7"
U	10,000/32'9"
P	2,985/ 9'9"
Q	1,435/ 4'8"
S	6,000/19'8"
N	1,400/ 4'7"
W	10,600/34'9"
V	14,550/47'8"
X	22,000/72'1"
Z	12,635/41'5"
OEL	Operator's Eye Level 7,850/25'8"

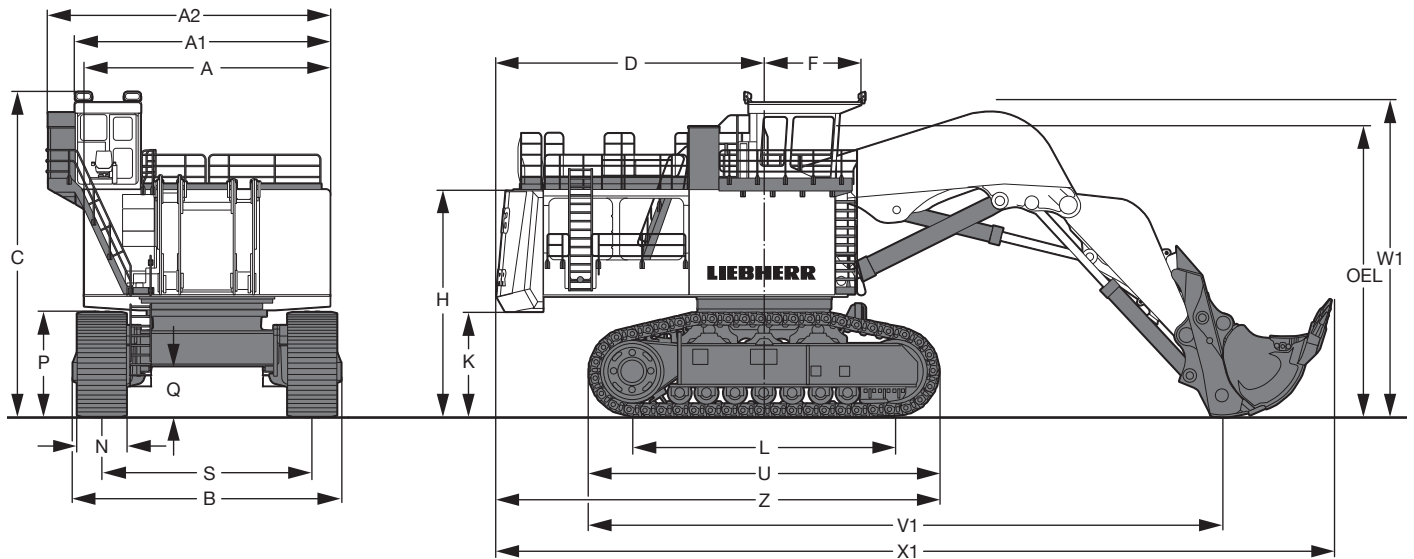

	mm/ft in
A	7,000/22'11"
A1	7,260/23' 9"
A2	8,080/26' 6"
B	7,908/25'11"
C	9,260/30' 4"
D	7,635/25'
E	7,950/26'
F	2,780/ 9' 1"
H	6,435/21' 1"
H1	8,280/27' 1"
K	3,005/ 9'10"

	mm/ft in
L	7,500/24'7"
U	10,000/32'9"
P	2,985/ 9'9"
Q	1,435/ 4'8"
S	6,000/19'8"
N	1,400/ 4'7"
W	9,050/29'8"
V	18,100/59'4"
X	23,900/78'4"
Z	12,635/41'5"
OEL	Operator's Eye Level 7,850/25'8"

Backhoe Attachment

with Gooseneck Boom 11.00 m/36'1"

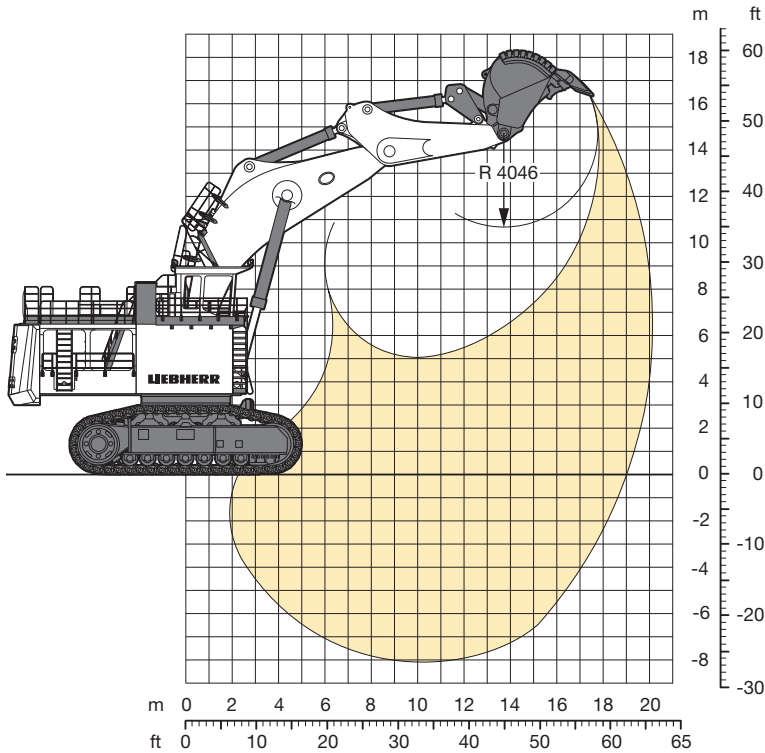

Digging Envelope

Stick length	5.00 m/16' 4"
Max. reach at ground level	19.03 m/62' 5"
Max. teeth height	16.56 m/54' 3"
Max. dump height	10.67 m/34'11"
Max. digging depth	8.11 m/26' 7"
Max. digging force (SAE)	1,500 kN/337,213 lbf
Max. breakout force (SAE)	1,670 kN/375,431 lbf

Operating Weight and Ground Pressure

The operating weight includes the basic machine with backhoe attachment and a 36.00 m³/47.1 yd³ bucket.

Pad width	mm/ft in	1,400/4'7"
Weight	kg/lb	672,000/1,481,505
Ground pressure	kg/cm ² /psi	2.87/40.82

Buckets

For materials classe according to VOB, Section C, DIN 18300		5 – 6	5 – 6	5 – 6	7 – 8
Typical operation according to VOB, Section C, DIN 18300		HD	HD	HD	XHD
Capacity ISO 7451	m ³	32.00	34.00	36.00	34.00
	yd ³	41.86	44.47	47.09	44.47
Suitable for material up to a specific weight of	t/m ³	2.0	1.9	1.8	1.8
	lb/yd ³	3,373	3,204	3,035	3,035
Cutting width	mm	4,800	4,800	4,800	4,800
	ft in	15'8"	15'8"	15'8"	15'8"
Weight	kg	39,500	40,400	40,400	44,000
	lb	87,082	89,067	89,067	97,003

HD: Heavy-duty bucket with Esco S145 teeth

XHD: Heavy-duty rock bucket with Esco S145 teeth

Shovel Attachment

with Shovel Boom 8.00 m/26'3"

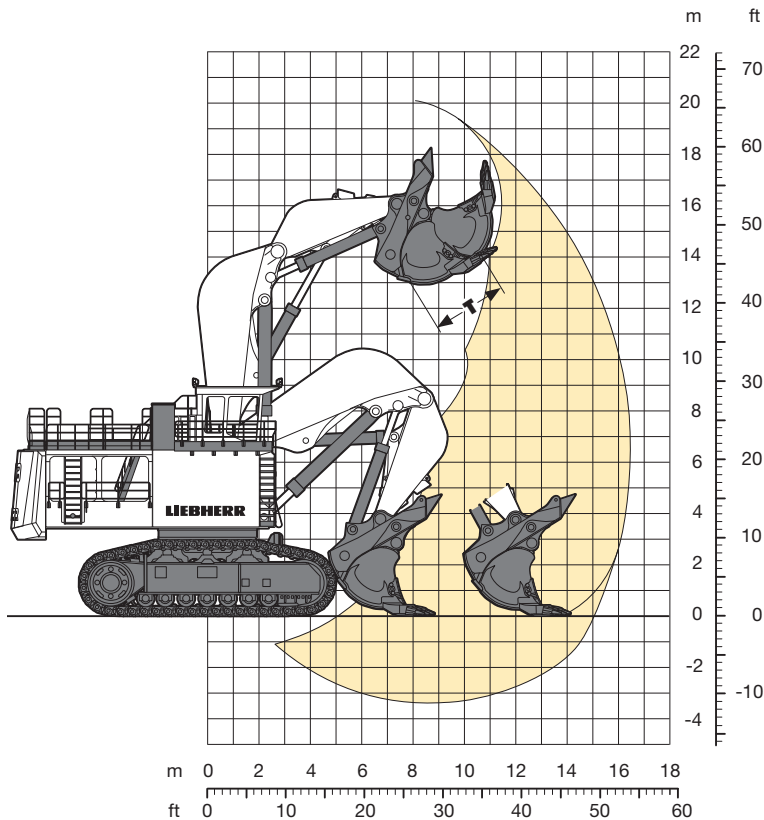

Digging Envelope

Stick length	5.00 m/16'4"
Max. reach at ground level	15.09 m/49'5"
Max. dump height	12.90 m/42'3"
Max. crowd length	5.38 m/17'7"
Bucket opening width T	2.80 m/ 9'2"
Crowd force at ground level (SAE)	2,300 kN/517,061 lbf
Max. crowd force (SAE)	2,430 kN/546,286 lbf
Max. breakout force (SAE)	1,905 kN/428,261 lbf

Operating Weight and Ground Pressure

The operating weight includes the basic machine with shovel attachment and a 34.00 m³/44.5 yd³ bucket.

Pad width	mm/ft in	1,400/4'7"
Weight	kg/lb	676,000/1,490,323
Ground pressure	kg/cm ² / psi	2.88/40.96

Bottom Dump Buckets

For materials classe according to VOB, Section C, DIN 18300		5 – 6	5 – 6	5 – 6	7 – 8
Typical operation according to VOB, Section C, DIN 18300		HD	HD	HD	XHD
Capacity ISO 7546	m ³	32.00	34.00	36.00	31.00
	yd ³	41.86	44.47	47.09	40,55
Cutting width	mm	5,500	5,500	5,500	4,800
	ft in	18'	18'	18'	15'8"
Suitable for material up to a specific weight of	t/m ³	1.9	1.8	1.65	1.9
	lb/yd ³	3,204	3,035	2,782	3,204
Weight	kg	63,900	64,600	65,000	65,000
	lb	140,875	142,418	143,300	143,300
Wear kit level		II	II	II	III

HD: Heavy-duty bucket with Esco S145 teeth

XHD: Heavy-duty rock bucket with Esco S145 teeth

Level II: For preblasted heavy rock, or deteriorated, cracked material (classification 5 to 6, according to DIN 18300)

Level III: For highly-abrasive materials such as rock with a high silica content, sandstone etc.

Component Dimensions and Weights

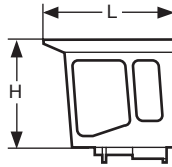

Cab

L Length	mm/ft in	3,215/10' 6"
H Height	mm/ft in	2,885/ 9' 5"
Width	mm/ft in	1,900/ 6' 2"
Weight	kg/lb	2,800/6,173

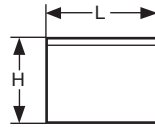

Cab Elevation with Fuel Tank

L Length	mm/ft in	4,150/13' 7"
H Height	mm/ft in	3,100/10' 2"
Width	mm/ft in	2,700/ 8'10"
Weight	kg/lb	8,000/17,637

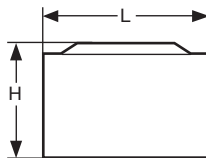

Powerpack Modules (two)

L Length	mm/ft in	5,280/17' 3"
H Height	mm/ft in	3,640/11'11"
Width	mm/ft in	2,070/ 6' 9"
Weight	kg/lb	2 x 16,500/2 x 36,376

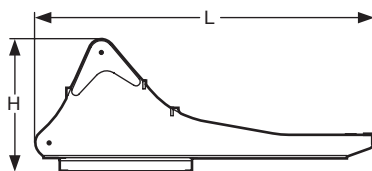

Rotation Deck (with swing ring, swing gears and control valve bracket)

L Length	mm/ft in	9,750/31'11"
H Height	mm/ft in	4,250/13'11"
Width	mm/ft in	4,270/14'
Weight	kg/lb	83,100/183,204

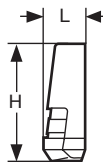

Counterweight

L Length	mm/ft in	1,320/ 4' 3"
H Height	mm/ft in	3,470/11' 4"
Width	mm/ft in	7,000/22'11"
Weight	kg/lb	58,000/127,868

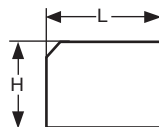

Hydraulic Oil Cooling

L Length	mm/ft in	4,210/13' 9"
H Height	mm/ft in	3,100/10' 2"
Width	mm/ft in	2,100/ 6'10"
Weight	kg/lb	8,000/17,637

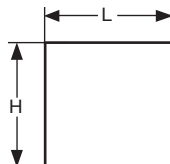

Compartment Panel (two)

L Length	mm/ft in	4,145/13' 7"
H Height	mm/ft in	3,100/10' 2"
Width	mm/ft in	950/ 3' 1"
Weight	kg/lb	2 x 1,500/2 x 3,307

Hydraulic Oil

Weight	kg/lb	8,000/17,637
--------	-------	--------------

Component Dimensions and Weights

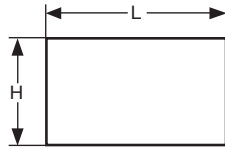

Miscellaneous

L Length	mm/ft in	4,500/14' 9"
H Height	mm/ft in	2,600/ 8' 6"
Width	mm/ft in	2,000/ 6' 6"
Weight	kg/lb	5,000/11,023

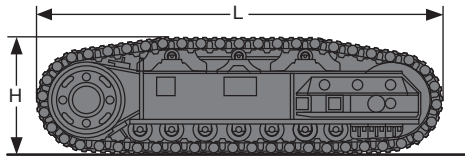

Side Frame (two)

L Length	mm/ft in	10,000/32' 9"
H Height	mm/ft in	2,985/ 9' 9"
Width over travel drive	mm/ft in	2,700/ 8'10"
Width without travel drive	mm/ft in	2,225/ 7' 3"
Weight	kg/lb	2 x 117,000/2 x 257,941

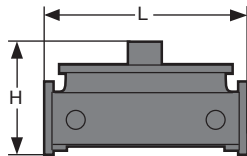

Undercarriage Central Girder

L Length	mm/ft in	4,000/13'1"
H Height	mm/ft in	2,690/ 8'9"
Width	mm/ft in	4,600/15'1"
Weight	kg/lb	42,928/94,640

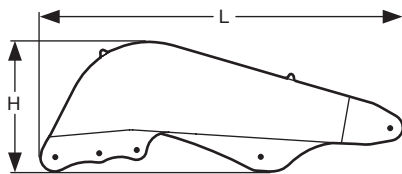

Shovel Boom

L Length	mm/ft in	8,650/28' 4"
H Height	mm/ft in	3,300/10' 9"
Width	mm/ft in	3,350/10'11"
Weight	kg/lb	51,600/113,758

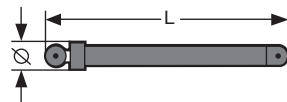

Hoist Cylinder (two)

L Length	mm/ft in	5,430/17' 9"
Ø Diameter	mm/ft in	600/ 1'11"
Weight	kg/lb	2 x 6,100/2 x 13,448

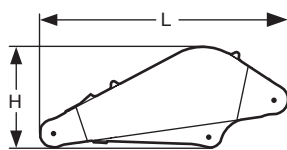

Shovel Stick

L Length	mm/ft in	5,620/18' 5"
H Height	mm/ft in	2,300/ 7' 6"
Width	mm/ft in	3,350/10'11"
Weight	kg/lb	26,200/57,761

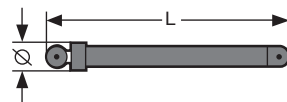

Crowd Cylinder (two)

L Length	mm/ft in	3,880/12'8"
Ø Diameter	mm/ft in	490/ 1'7"
Weight	kg/lb	2 x 3,430/2 x 7,562

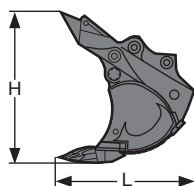

Bottom Dump Bucket

Application		HD
Capacity ISO 7451	m ³ /yd ³	34.00/44.47
L Length	mm/ft in	4,650/15'3"
H Height	mm/ft in	4,500/14'9"
Width	mm/ft in	5,000/16'4"
Weight	kg/lb	64,500/142,198

Component Dimensions and Weights

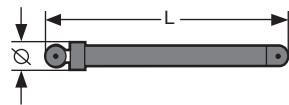

Bucket Tilt Cylinder (two)

L Length	mm/ft in	4,690/15'4"
Ø Diameter	mm/ft in	490/ 1'7"
Weight	kg/lb	2 x 3,700/2 x 8,157

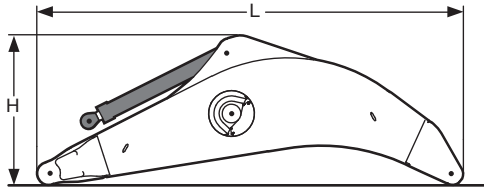

Gooseneck Boom with Stick Cylinders

L Length	mm/ft in	12,000/39' 4"
H Height	mm/ft in	4,500/14' 9"
Width	mm/ft in	2,800/ 9' 2"
Weight	kg/lb	69,500/153,221

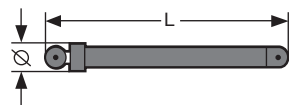

Backhoe Hoist Cylinders (two)

L Length	mm/ft in	5,430/17' 9"
Ø Diameter	mm/ft in	600/ 1'11"
Weight	kg/lb	2 x 6,060/2 x 13,360

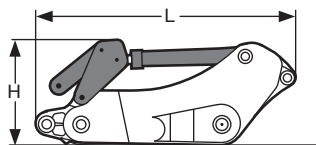

Stick with Bucket Cylinders

L Length	mm/ft in	7,500/24'7"
H Height	mm/ft in	3,300/10'9"
Width	mm/ft in	2,500/ 8'2"
Weight	kg/lb	42,000/92,594

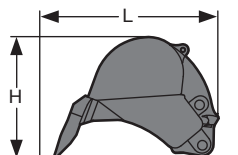

Backhoe Bucket

Application		HD
Capacity ISO 7451		36.00/47.09
L Length	mm/ft in	4,900/16'
H Height	mm/ft in	4,000/13'1"
Width	mm/ft in	4,600/15'1"
Weight	kg/lb	40,000/88,185

The Liebherr Group of Companies

Wide product range

The Liebherr Group is one of the largest construction equipment manufacturers in the world. Liebherr's high-value products and services enjoy a high reputation in many other fields, too. The wide range includes domestic appliances, aerospace and transportation systems, machine tools and maritime cranes.

Exceptional customer benefit

Every product line provides a complete range of models in many different versions. With both their technical excellence and acknowledged quality, Liebherr products offer a maximum of customer benefits in practical application.

State-of-the-art technology

To provide consistent, top quality products, Liebherr attaches great importance to each product area, its components and core technologies. Important modules and components are developed and manufactured in-house, for instance the entire drive and control technology for construction equipment.

Worldwide and independent

Hans Liebherr founded the Liebherr family company in 1949. Since that time, the enterprise has steadily grown to a group of more than 100 companies with over 32,000 employees located on all continents. The corporate headquarters of the Group is Liebherr-International AG in Bulle, Switzerland. The Liebherr family is the sole owner of the company.

www.liebherr.com



Printed in Chile RG-BK-RP LFR/SP 11003233-03.10_enGB-US

Liebherr-France SAS Mining Division

49 rue Frédéric Hartmann, CS 50038, F-68025 Colmar Cedex

☎ +33 369 4921 99, Fax +33 369 4922 79

www.liebherr.com, E-Mail: info.lfr-mining@liebherr.com