



Micro Engine Repair Manual



TABLE OF CONTENTS

GENERAL INFORMATION **Section 1**

1

DISASSEMBLY AND REPAIR **Section 2**

2

SECTION CONTENTS

1

Section 1

General Information

In The Interest Of Safety
Briggs & Stratton Numerical Identification System
Engine Identification
Fuel and Oil Recommendations
Gasoline
Lubrication
Maintenance
Check Oil
Change Oil
Air Cleaner
Breather Check Valve
Replace Spark Plug
Cooling System
Troubleshooting
Systematic Check
Check Ignition
Check Carburetion
Check Compression
Equipment Affecting Engine Operation
Hard Starting, Kickback or Will Not Start
Vibration
Power Loss

2

Section 2

Disassembly and Repair

General Information
Rewind Assembly
Inspect Starter Rope
Remove Blower Housing – Direct Drive Engine
Replace Starter Rope
Install Blower Housing – Direct Drive Engine
Remove Blower Housing – Clutch Drive Engine
Install Blower Housing – Clutch Drive Engine
Ignition Coil
Remove Coil
Install Coil
Adjust Air Gap
Flywheel
Remove Flywheel – Direct Drive Engine
Install Flywheel – Direct Drive Engine
Remove Flywheel – Clutch Drive Engine
Install Flywheel – Clutch Drive Engine
Fuel Tank
Remove Fuel Tank
Install Fuel Tank
Cylinder Head
Remove Cylinder Head
Install Cylinder Head
Muffler
Replace Muffler
Carburetor
Remove Carburetor
Install Carburetor
Idle Speed Adjustment

Section 1

General Information

Section Contents

	Page
IN THE INTEREST OF SAFETY	1
BRIGGS & STRATTON NUMERICAL IDENTIFICATION SYSTEM	4
ENGINE IDENTIFICATION	5
FUEL AND OIL RECOMMENDATIONS (Gasoline, Lubrication)	5
MAINTENANCE	6
Check Oil	6
Change Oil	7
Air Cleaner	7
Replace Spark Plug	7
Cooling System	8
TROUBLESHOOTING	8
Systematic Check	8
Check Ignition (With Engine Starter)	8
Check Ignition (Engine Running)	9
Check Carburetion	9
Check Compression	9
Equipment Affecting Engine Operation	9
Hard Starting, Kickback or Will Not Start	9
Vibration	10
Power Loss	10

The Briggs & Stratton engine is made of the finest material in a state-of-the-art manufacturing facility. Please understand that Briggs & Stratton sells engines to original equipment manufacturers. It also sells to others in the distribution chain who may sell to the ultimate consumer, an equipment manufacturer, another distributor or a dealer. As a result, Briggs & Stratton does not necessarily know the application on which the engine will be placed. For that reason, carefully read and understand the operating instructions of the equipment before you repair or operate.

You should also understand that there are equipment applications for which Briggs & Stratton does not approve the use of its engines. Briggs & Stratton engines are not to be used on vehicles with less than 4 wheels. This includes motor bikes, aircraft products and All Terrain Vehicles. Moreover, Briggs & Stratton does not approve of its engines being used in competitive events. FOR THAT REASON, BRIGGS & STRATTON ENGINES ARE NOT AUTHORIZED FOR ANY OF THESE APPLICATIONS. Failure to follow this warning could result in death, serious injury (including paralysis) or property damage.

IN THE INTEREST OF SAFETY

The safety alert symbol () is used to identify safety information about hazards that can result in personal injury.

A signal word (DANGER, WARNING or CAUTION) is used with the alert symbol to indicate the likelihood and the potential severity of injury. In addition, a hazard symbol may be used to represent the type of hazard.

 **DANGER** indicates a hazard which, if not avoided, **will result in death or serious injury.**

 **WARNING** indicates a hazard which, if not avoided, **could result in death or serious injury.**

 **CAUTION** indicates a hazard which, if not avoided, **might result in minor or moderate injury.**

CAUTION, when used **without** the alert symbol, indicates a situation that **could result in damage to the engine.**

HAZARD SYMBOLS AND MEANINGS



Fire



Explosion



Moving
Parts



Toxic Fumes



Hot
Surface



Kickback



Shock



✓ Prior to work, read and understand the section(s) of this manual that pertain to the job. Follow all safety warnings.

✓ **WEAR** suitable eye protection (safety glasses, goggles or face shield when performing repair procedures).

✓ **PREVENT ACCIDENTAL STARTING** by removing spark plug wire from spark plug when servicing engine or equipment.

✓ **PERIODICALLY** clean engine. Keep carburetor parts free of dirt, grass and other debris which can affect engine speed.

✓ **USE** fresh gasoline. Stale fuel can gum carburetor and cause leakage.

✓ **CHECK** fuel lines and fittings frequently for cracks or leaks. Replace if necessary.

WARNING:

The engine exhaust from this product contains chemicals known to the State of California to cause cancer, birth defects, or other reproductive harm.

WARNING



Gasoline and its vapors are extremely flammable and explosive.

Fire or explosion can cause severe burns or death.

WHEN ADDING FUEL

- Turn engine OFF and let engine cool at least 2 minutes before removing gas cap.
- Fill fuel tank outdoors or in well-ventilated area.
- Do not overfill fuel tank. Fill tank to approximately 1-1/2 inches below top of neck to allow for fuel expansion.
- Keep gasoline away from sparks, open flames, pilot lights, heat, and other ignition sources.
- Check fuel lines, tank, cap, and fittings frequently for cracks or leaks. Replace if necessary.

WHEN STARTING ENGINE

- Make sure spark plug, muffler, fuel cap and air cleaner are in place.
- Do not crank engine with spark plug removed.
- If fuel spills, wait until it evaporates before starting engine.
- If engine floods, set choke to OPEN/RUN position, place throttle in FAST and crank until engine starts.

WHEN OPERATING EQUIPMENT

- Do not tip engine or equipment at angle which causes gasoline to spill.
- Do not choke carburetor to stop engine.

WHEN STORING GASOLINE OR EQUIPMENT WITH FUEL IN TANK

- Store away from furnaces, stoves, water heaters or other appliances that have pilot light or other ignition source because they can ignite gasoline vapors.

 **WARNING**



Unintentional sparking can result in fire or electric shock.

Unintentional start-up can result in entanglement, traumatic amputation, or laceration.

BEFORE PERFORMING ADJUSTMENTS OR REPAIRS

- Disconnect spark plug wire and keep it away from spark plug.

WHEN TESTING FOR SPARK

- Use approved spark plug tester.
- Do not check for spark with spark plug removed.

 **WARNING**





Starting engine creates sparking.

Sparking can ignite nearby flammable gases.

Explosion and fire could result.

- If there is natural or LP gas leakage in area, do not start engine.
- Do not use pressurized starting fluids because vapors are flammable.

 **WARNING**



Engines give off carbon monoxide, an odorless, colorless, poison gas.

Breathing carbon monoxide can cause nausea, fainting or death.

- Start and run engine outdoors.
- Do not start or run engine in enclosed area, even if doors or windows are open.

 **WARNING**



Running engines produce heat. Engine parts, especially muffler, become extremely hot.

Severe thermal burns can occur on contact.

Combustible debris, such as leaves, grass, brush, etc. can catch fire.

- Allow muffler, engine cylinder and fins to cool before touching.
- Remove accumulated combustibles from muffler area and cylinder area.
- Install and maintain in working order a spark arrester before using equipment on forest-covered, grass-covered, brush-covered unimproved land. The state of California requires this (Section 4442 of the California Public Resources Code). Other states may have similar laws. Federal laws apply on federal land.

 **WARNING**



Rotating parts can contact or entangle hands, feet, hair, clothing, or accessories.

Traumatic amputation or severe laceration can result.

- Operate equipment with guards in place.
- Keep hands and feet away from rotating parts.
- Tie up long hair and remove jewelry.
- Do not wear loose-fitting clothing, dangling drawstrings or items that could become caught.

 **WARNING**



Rapid retraction of starter cord (kickback) will pull hand and arm toward engine faster than you can let go.

Broken bones, fractures, bruises or sprains could result.

- When starting engine, pull cord slowly until resistance is felt, then pull rapidly.
- Direct coupled equipment components such as, but not limited to, blades, impellers, pulleys, sprockets, etc., must be securely attached.

YOUR KEY TO THE WORLD'S FINEST ENGINES

This chart explains the unique Briggs & Stratton numerical model designation system. It is possible to determine most of the important mechanical features of the engine by merely knowing the model number. Here is how it works:

1

- A. The first one or two digits indicate the approximate CUBIC INCH DISPLACEMENT.
- B. The first digit after the displacement indicates the BASIC DESIGN SERIES, relating to cylinder construction, ignition, general configuration, etc.
- C. The second digit after the displacement indicates ORIENTATION OF CRANKSHAFT.
- D. The third digit after the displacement indicates TYPE OF BEARINGS, and whether or not the engine is equipped with REDUCTION GEAR or AUXILIARY DRIVE.
- E. The last digit indicates the TYPE OF STARTER.

BRIGGS & STRATTON MODEL NUMBERING SYSTEM

	<u>FIRST DIGIT AFTER DISPLACEMENT</u>	<u>SECOND DIGIT AFTER DISPLACEMENT</u>	<u>THIRD DIGIT AFTER DISPLACEMENT</u>	<u>FOURTH DIGIT AFTER DISPLACEMENT</u>
A	B	C	D	E
<u>CUBIC INCH DISPLACEMENT</u>	<u>BASIC DESIGN SERIES</u>	<u>CRANKSHAFT ORIENTATION</u>	<u>PTO BEARING, REDUCTION GEAR, AUXILIARY DRIVE, LUBRICATION</u>	<u>TYPE OF STARTER</u>
6	0	0 to 4 - Horizontal Shaft	0 - Plain Bearing/DU Non-Flange Mount	0 - Without Starter
8	1	5 to 9 - Vertical Shaft		1 - Rope Starter
9	2			2 - Rewind Starter
10	3	A to G - Horizontal Shaft	1 - Plain Bearing Flange Mounting	3 - Electric Starter Only
11	4	H to Z - Vertical Shaft		3 - Electric Starter Only 110 or 230 Volt Gear Drive
12	5		2 - Sleeve Bearing Flange Mounting Splash Lube	4 - Electric Starter/110 or 230 Volt Gear Drive with Alternator
13	6			
16	7		3 - Ball Bearing Flange Mounting Splash Lube	5 - Electric Starter Only
18	8			5 - Electric Starter Only 12 or 24 Volt Gear Drive
19	9		4 - Ball Bearing Flange Mounting Pressure Lubrication	6 - Alternator Only
20	A to Z			7 - Electric Starter 12 or 24 Volt Gear Drive with Alternator
21			5 - Plain Bearing Gear Reduction (6 to 1) CCW Rotation Flange Mounting	8 - Vertical Pull Starter or Side Pull Starter
22				9 - Mechanical Starter
23			6 - Plain Bearing Gear Reduction (2 to 1) CCW Rotation	A - Electric Starter 12 or 24 Volt Gear Drive with Alternator and Inverter
24				
25			7 - Plain Bearing Pressure Lubrication	
28				
29			8 - Plain Bearing Auxiliary Drive (PTO) Perpendicular to Crankshaft	
30				
31			9 - Plain Bearing Auxiliary Drive Parallel to Crankshaft	
32				
35			A - Plain Bearing Pressure Lubrication Without Oil Filter	
38				
40				
42				
43				
44				
46				
47				
52				
54				
58				

EXAMPLE - To identify Model 303447:

<u>30</u>	<u>3</u>	<u>4</u>	<u>4</u>	<u>7</u>
30 Cubic Inch	Design Series 3	Horizontal Shaft	Ball Bearing Flange Mounting Pressure Lubrication	Electric Starter 12 or 24 Volt Gear Drive with Alternator

TYPE 1234-01, The type number identifies the engines mechanical parts, color of paint, decals, governed speed, and Original Equipment Manufacturer.

CODE 01061201, The code is the manufacturing date and is read as follows:

YEAR	MONTH	DAY	ASSEMBLY LINE AND MANUFACTURING PLANT
01	06	12	01

Revised 5/03

ENGINE IDENTIFICATION

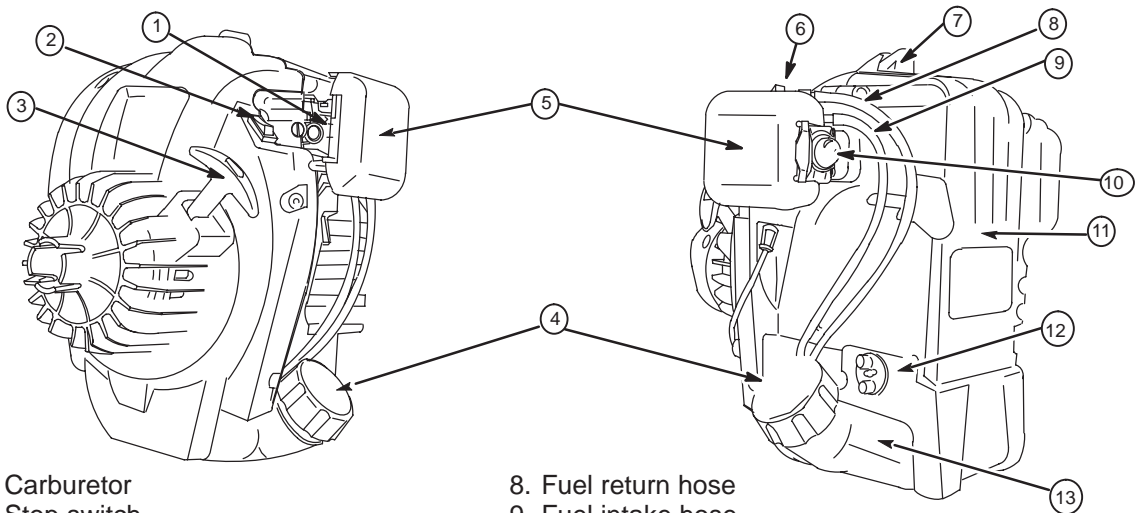

1. Carburetor
2. Stop switch
3. Rope handle
4. Fuel fill
5. Air cleaner
6. Choke lever
7. Spark plug

8. Fuel return hose
9. Fuel intake hose
10. Primer bulb
11. Engine Model Type Code
xxxxxx xxxx xxxxxxxx
12. Oil fill / dipstick
13. Fuel tank

FUEL AND OIL RECOMMENDATIONS

Gasoline

These engines are certified to operate on unleaded gasoline. Use clean, fresh, regular unleaded gasoline with a minimum of 85 octane. Do not mix oil with gasoline. Fresh fuel prevents gum from forming in fuel system or on essential carburetor parts. Purchase fuel in quantity that can be used within 30 days to assure fuel freshness. We recommend the use of Briggs & Stratton Gasoline Additive. (See your Authorized Briggs & Stratton Service Dealer for Part No. 5041 or the single-use pouch.)

In countries other than U.S.A., leaded gasoline may be used if it is commercially available and unleaded is unavailable.

NOTE: Some fuels, called oxygenated or reformulated gasolines, are gasoline blended with alcohols or ethers. Excessive amounts of these blends can damage the fuel system or cause performance problems. Do not use gasoline containing Methanol. If any undesirable operating symptoms occur, use gasoline with a lower percentage of alcohol or ether.

Lubrication

Oil has four purposes. It cools, cleans, seals and lubricates. During normal operation, small particles of metal from the cylinder walls, pistons, bearings and combustion deposits will gradually contaminate the oil. Dust particles from the air also contaminate the oil forming an abrasive mixture which can cause wear to all of the internal moving parts of the engine, if the oil is not changed regularly. Fresh oil also assists in cooling. Old oil gradually becomes thick and loses its cooling ability as well as its lubricating qualities.

Oil Recommendations



Use a high quality detergent oil classified "For Service SF, SG, SH, SJ" or higher. Briggs & Stratton strongly recommends the use of synthetic oil such as Briggs & Stratton (#100030C) or equivalent. If synthetic oil is not available, Briggs & Stratton non-synthetic 30 weight oil is an acceptable substitute. No special additives should be used with recommended oils.

Do not mix oil with gasoline.

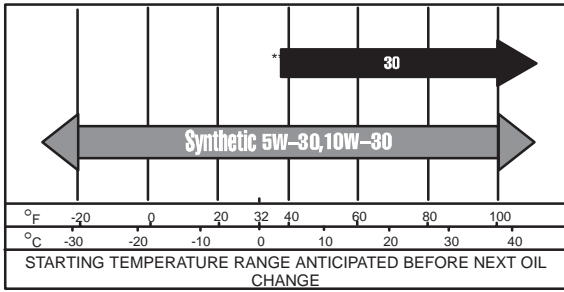
SAE VISCOSITY GRADES



- * Air cooled engines run hotter than automotive engines. Use of non-synthetic multi-viscosity oils (10W-30, etc.) in ambient temperatures above 40° F (4° C) will result in high oil consumption. If multi-viscosity oil is used, check oil level more frequently to prevent engine damage due to lack of lubrication.
- ** SAE 30 oil, if used below 40° F (4° C), will result in hard starting and possible engine damage due to inadequate lubrication.

Note: Synthetic oil meeting ILSAC GF-2, API certification mark and API service symbol (shown at left) with “SJ/CF ENERGY CONSERVING” or higher, is an acceptable oil at all temperatures. **Use of synthetic oil does not alter required oil change intervals.**

MAINTENANCE

WARNING



If you perform any maintenance on the engine, first disconnect the spark plug wire from the spark plug to prevent unintentional sparking. Unintentional sparking can result in fire or electric shock. Unintentional start-up can result in entanglement, traumatic amputation or laceration. Use only correct tools.

Maintenance Schedule

	Daily	10 Hours or Every Season	25 Hours or Every Season	50 Hours or Every Season
Check oil level	✓			
Change oil			✓*	
Service air filter		✓**		
Replace spark plug				✓

* **Change oil after first 4 hours of use**, then every 8 hours or every season. Change oil every 4 hours when operating the engine under heavy load or in high temperatures.

** Clean more often under dusty conditions or when airborne debris is present. Replace air cleaner parts, if very dirty.

Check Oil

1. Place the warm engine with the dipstick facing up. If necessary use a support (2) to level the engine, Fig. 1.

NOTE: The engine **MUST** be level to obtain an accurate oil level measurement.

2. Unscrew the dipstick (1) and wipe it with a rag.
3. Replace the dipstick, thread the dipstick in completely.
4. Unscrew the dipstick to check the oil.

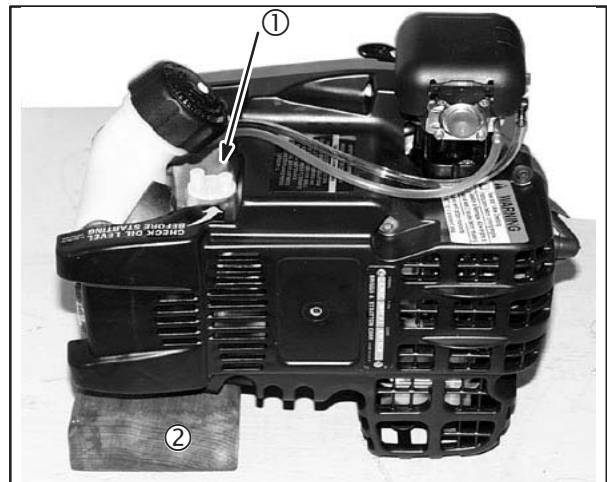

Fig. 1

BE SURE OIL LEVEL IS PROPERLY MAINTAINED. Always fill to dipstick FULL mark (1), Fig. 2.

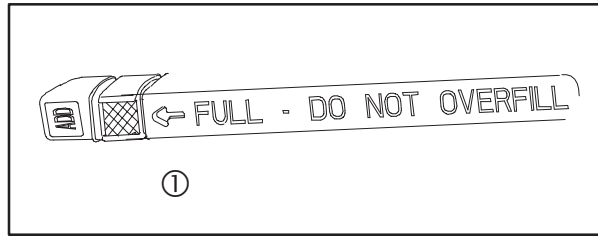

Fig. 2

Change Oil

1. Remove dipstick.
2. Invert the engine to drain oil while the engine is warm.
3. Fill engine with 3.0 oz. (88 ml.) of new oil.
4. Replace dipstick.

Air Cleaner

A properly serviced air cleaner protects internal parts of the engine from dust particles in the air. If air cleaner maintenance instructions are not carefully followed, dirt and dust that should be collected in the foam filter will be drawn into the engine.

1. Push cover tab to release air cleaner cover (1), Fig. 3.
2. Remove filter (2).
3. Wash filter in liquid detergent and water.
4. Squeeze it dry in a clean cloth.
5. Saturate foam air filter in clean engine oil, then squeeze out excess oil in clean cloth.
6. Install air filter.

NOTE: Make sure filter is on outside of locating bosses and flush with filter base.

7. Refer to Breather Check Valve, below.
8. Install air cleaner cover.

DO NOT use compressed air or solvents to clean filter. Compressed air can damage filter; solvents will dissolve filter.

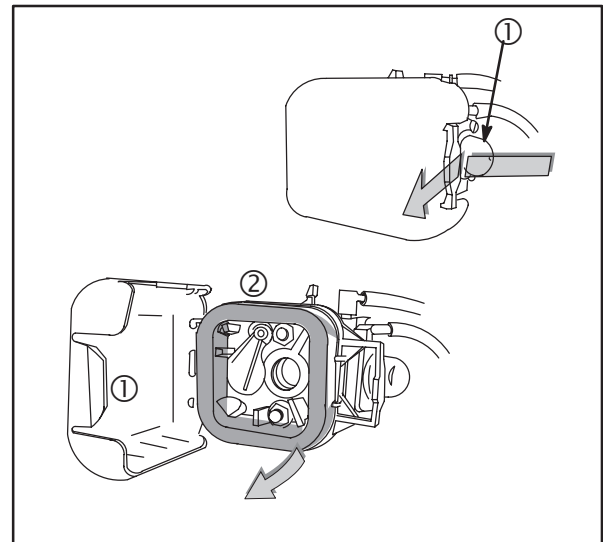

Fig. 3

Breather Check Valve

With the air cleaner removed inspect the breather check valve (1), Fig. 4. Remove any obstructions from the check valve. The check valve should be flexible and remain closed as shown.

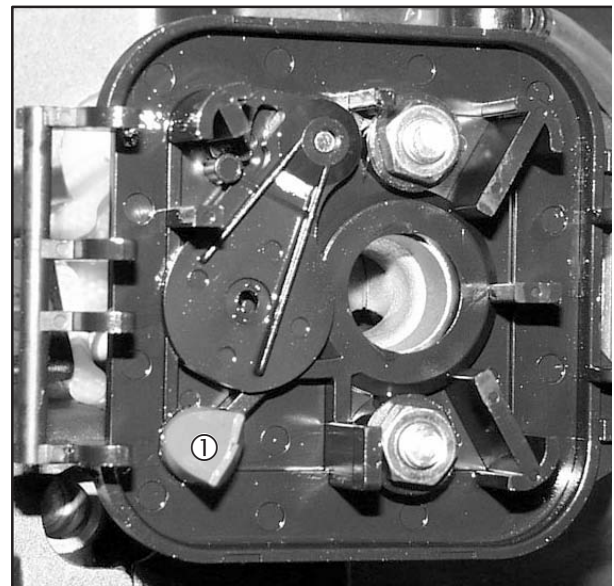
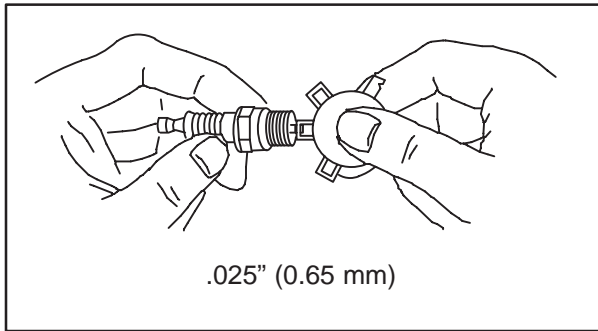

Fig. 4

Replace Spark Plug

Replace spark plug yearly or if electrodes show signs of wear, or the porcelain is cracked. Set spark plug gap at .025 inch (.65 mm). Torque spark plug to 20 Nm (180 in. lbs.).

Briggs & Stratton recommends spark plug number 696876 for the Micro Engine.



Cooling System

Grass particles, chaff or dirt can clog the air cooling system. Continued operation with a clogged cooling system can cause severe overheating and possible engine damage. This should be a regular maintenance operation, performed yearly. Clean more often if necessary.

TROUBLESHOOTING

Most complaints concerning engine operation can be classified as one or a combination of the following:

1. Will not start
2. Hard Starting
3. Lack of power
4. Runs Rough
5. Vibration
6. Overheating
7. High Oil Consumption

NOTE: What appears to be an engine malfunction may be a fault of the powered equipment rather than the engine. If equipment is suspect, see Equipment Affecting Engine Operation.

Systematic Check

If the engine is hard starting or will not start and the cause of malfunction is not readily apparent, perform a systematic check in the following order:

1. Ignition
2. Carburetion
3. Compression

This check-up, performed in a systematic manner, can usually be done in a matter of minutes. It is the

quickest and surest method of determining the cause of failure.

Check Ignition (With Engine Starter)

With stop switch in ON/RUN position and spark plug installed, attach a #19368 ignition tester to the spark plug lead and ground the other end of the tester as shown in Fig. 5. Operate the starter a minimum of six times in rapid succession. If a strong, steady spark is observed at the tester gap, you may assume the ignition system is functioning satisfactorily.

NOTE: If spark initially appears at tester, but stops on subsequent pulls and the stop switch is in the ON/RUN position, check for a defective equipment stop switch or shorted wires.

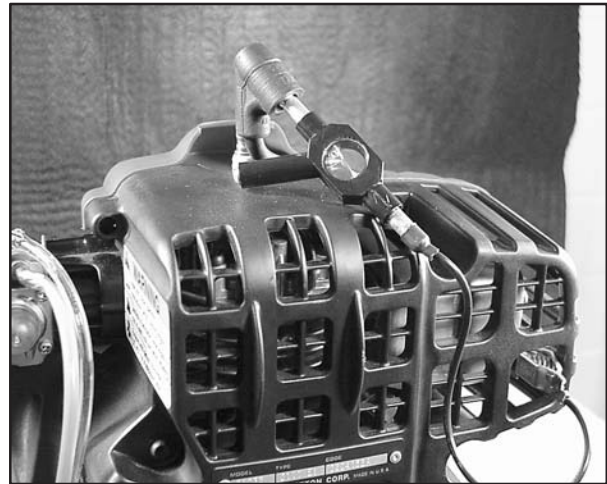

Fig. 5

NOTE: Engines equipped with Magnetron® ignition system will still display spark at tester with a partially or fully sheared flywheel key. A partially sheared flywheel key will affect ignition timing and engine performance.

 WARNING

ON MAGNETRON® EQUIPPED ENGINES, SPARK CAN STILL OCCUR WITH A SHEARED FLYWHEEL KEY. A SEVERE SHOCK OR KICKBACK HAZARD MAY EXIST.

If spark does not occur look for :

1. Shorted stop switch
2. Shorted ground wire
3. Incorrect armature air gap
4. Armature failure

Check Ignition (Engine Running)

If engine runs but misses during operation, a quick check to determine if ignition is or is not at fault can be made by installing Tool #19368 tester between the spark plug lead and spark plug, Fig. 6. A spark miss will be readily apparent when the engine is running. If spark is good but engine misses, try a new spark plug.



Fig. 6

Check Carburetion

Before checking carburetion, be sure the fuel tank has an ample supply of fresh, clean gasoline.

Make sure throttle and choke controls are properly adjusted.

If engine cranks but will not start, remove and inspect the spark plug.

If plug is wet, look for:

1. Over choking
2. Water in fuel
3. Float needle valve stuck open
4. Plugged air cleaner
5. Fouled spark plug

If plug is dry, look for:

1. Leaking carburetor mounting gaskets

2. Gummy or dirty carburetor, fuel filter, fuel lines or fuel tank
3. Float needle valve stuck shut
4. Inoperative fuel pump

A simple check to determine if the fuel is getting to the combustion chamber through the carburetor is to remove the spark plug and pour a small quantity of gasoline (1 teaspoon or 10 ml.) through the spark plug hole. Replace the plug. If the engine fires a few times and then stops, look for the same conditions as for a dry plug.

Check Compression

Connect spark plug wire to long terminal of tester, Tool #19368 and ground tester to engine with alligator clip.

To check compression, use a compression tester. Remove the spark plug and install the tester. Crank the engine using the rewind starter. Continue cranking until meter reading stabilizes. The meter reading should be approximately 50 to 60 P.S.I. (3.5-4 bar) If compression is below 40 P.S.I. (2.8 bar), look for:

1. Loose cylinder head bolts
2. Blown head gasket
3. Burned valves, valve seats
4. Insufficient tappet clearance
5. Warped cylinder head
6. Warped valve stems
7. Worn bore and/or rings
8. Broken connecting rod

Equipment Affecting Engine Operation

Frequently, what appears to be a problem with engine operation, such as hard starting, vibration, etc., can be caused by the equipment being powered rather than the engine itself. Since many varied types of equipment are powered by Briggs & Stratton engines, it is not possible to list all of the various conditions that may exist. Listed are the most common effects of equipment problems, and what to look for as the most common cause.

Hard Starting, Kickback, or Will Not Start

1. Loose blade – blade must be tight to shaft or adaptor. Check for partially sheared flywheel key, or damaged blade and hub.
2. Starting under load – see that the unit is not engaged when engine is started; if the unit is engaged, that it does not have a heavy parasitic load.

3. Check choke or speed control assembly for proper adjustment.
4. Check interlock system (if equipped) for shorted wires, loose or corroded connections, or defective modules or switches.

Vibration

1. Cutter blade bent or out of balance – remove and balance.

2. Worn blade coupling – replace if coupling allows blade to shift.
3. Mounting bolts loose – tighten.
4. Check for partially sheared flywheel key.

Power Loss

Bind or drag in unit – if possible, disengage engine and operate unit manually to check for any binding action.

Section 2

Disassembly and Repair

Section Contents

	Page
GENERAL INFORMATION	12
REWIND ASSEMBLY	12
Inspect Starter Rope	12
Remove Blower Housing – Direct Drive Engine	12
Replace Starter Rope	13
Install Blower Housing – Direct Drive Engine	13
Remove Blower Housing – Clutch Drive Engine	14
Install Blower Housing – Clutch Drive Engine	14
IGNITION COIL	16
Remove Coil	16
Install Coil	16
Adjust Air Gap	16
FLYWHEEL	17
Remove Flywheel – Direct Drive Engine	17
Install Flywheel – Direct Drive Engine	17
Remove Flywheel – Clutch Drive Engine	17
Install Flywheel – Clutch Drive Engine	18
FUEL TANK	18
Remove Fuel Tank	18
Install Fuel Tank	18
CYLINDER HEAD	19
Remove Cylinder Head	19
Install Cylinder Head	19
MUFFLER	19
Replace Muffler	19
CARBURETOR	20
Remove Carburetor	20
Install Carburetor	20
Idle Speed Adjustment	21

GENERAL INFORMATION

The extent of service to the Micro Engine is limited to the replacement of the major external components of the engine. The Section Contents lists the serviceable components in the required sequence of disassembly. For example, to replace the ignition coil it would be necessary to remove the blower housing. Therefore the rewind removal procedure is listed first. With the blower housing removed the ignition coil, flywheel and fuel tank are accessible. To replace the muffler the blower housing and cylinder shield must be removed.

2

NOTE: When removing screws from the engine, the screw threads will loosen aluminum particles which can get into the engine:

Clean thoroughly whenever removing screws from the engine.

Do not use impact tools to remove or install screws.

Use lubricant liberally whenever removing screws.

NOTE: There is no provision to bore or hone the engine block. If the piston bore is worn or damaged, replace the engine.

REWIND ASSEMBLY

Inspect Starter Rope

1. Pull starter rope out and hold.
2. Inspect starter rope. Replace the rope if any strands are frayed or broken.

To service the blower housing/rewind assembly the engine must be removed from the piece of equipment.

The starter rewind pulley and spring are not serviceable. If pulley is damaged or spring is broken the blower housing/rewind assembly must be replaced.

Remove Blower Housing – Direct Drive Engine

Remove screws with the T-25 bit from Briggs & Stratton Tool #19442 Torquex Star Bit Set.

1. Remove 2 screws (1) from blower housing Fig. 1.
2. Remove 4 screws (2) from cylinder shield side, Fig. 2.
3. Remove blower housing.

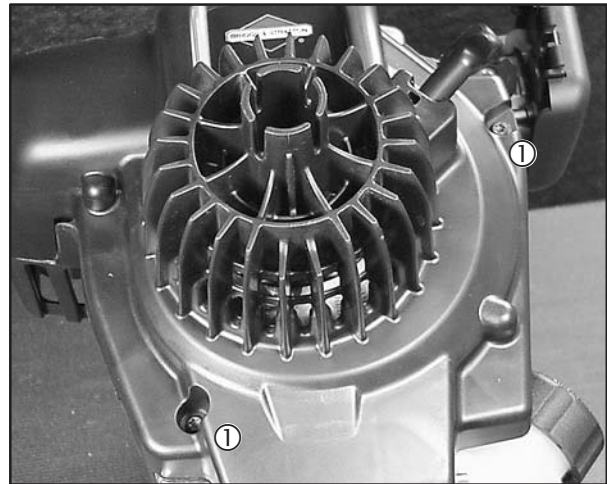

Fig. 1

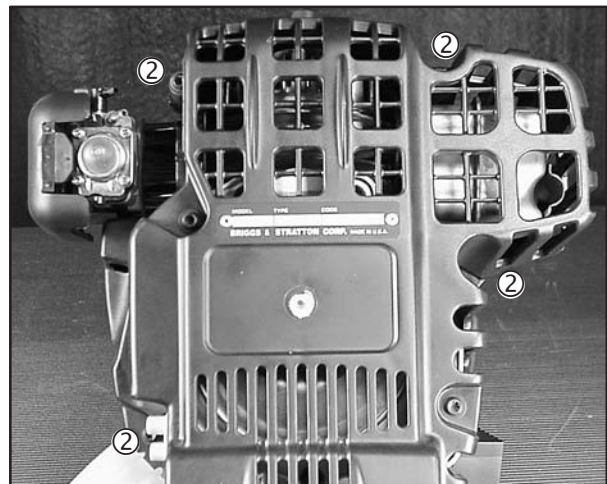

Fig. 2

Replace Starter Rope

1. Pull rope out part way and tie a temporary knot.
2. Remove rope from rope handle and untie knot, Fig. 3.
3. Remove starter handle.

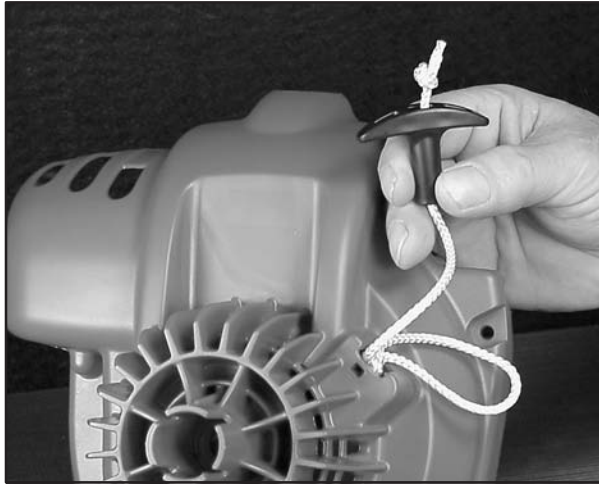

Fig. 3

4. Pull rope out as far as it will go and untie temporary knot.
5. While holding rewind pulley, grasp knot in pulley with a pair of needle nose pliers and pull rope out of pulley.
6. Slowly release spring tension on pulley until pulley stops turning.

NOTE: Replacement rope has handle attached.

7. Rotate pulley **CLOCKWISE**, **SEVEN (7)** complete turns.
8. Then rotate pulley counterclockwise until rope hole in pulley is in line with starter housing eyelet. Hold pulley in this position.
9. Insert rope through eyelet in housing and then through hole in pulley (1), Fig. 4.
10. Tie a figure eight knot in end of rope (2), as shown.

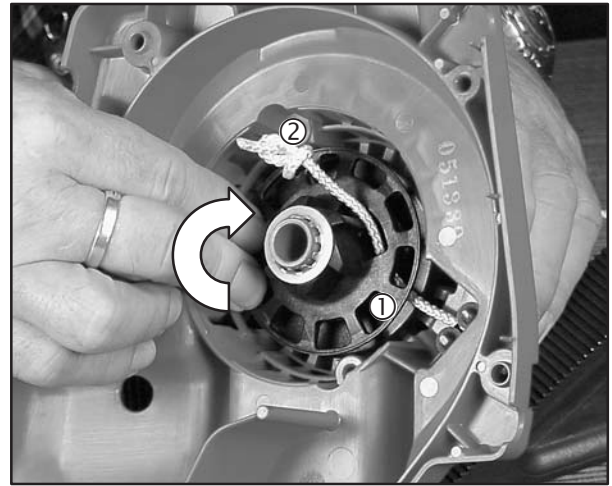

Fig. 4

11. Pull rope until knot is seated in pulley.
12. Then let rope rewind into starter.
13. Operate starter to check for smooth operation.

Install Blower Housing – Direct Drive Engine

Assemble blower housing to engine.

NOTE: Be sure stop switch is installed in its notch in blower housing.

1. Install 4 screws (2) from cylinder shield side, Fig. 5.

Torque screws to 25 in. lbs. (3 Nm).

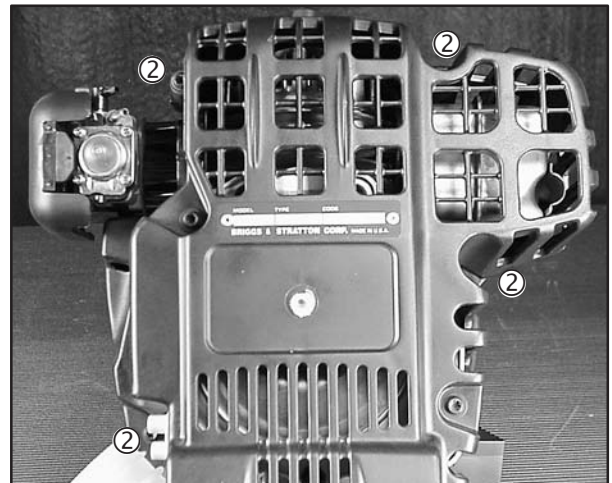

Fig. 5

2. Install 2 screws in blower housing, Fig. 6.

Torque screws to 40 in. lbs. (5 Nm).

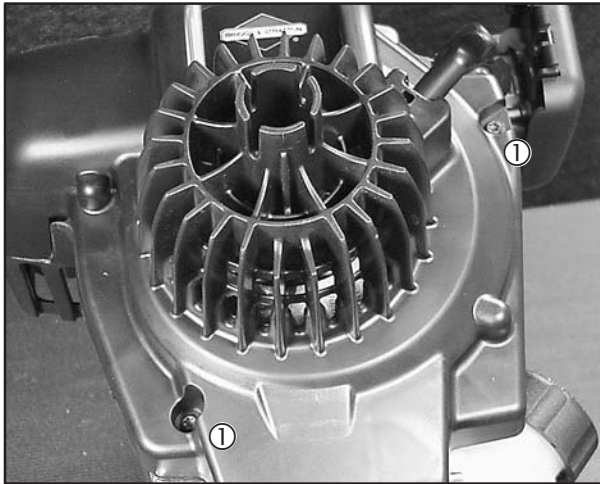

Fig. 6

Remove Blower Housing – Clutch Drive Engine

Before the blower housing can be removed it is necessary to remove the clutch assembly.

1. Remove 6 screws (1) and clutch housing cover, Fig. 7.

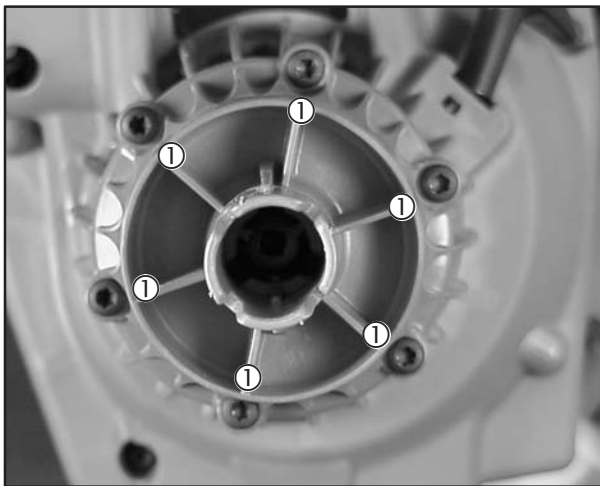

Fig. 7

2. Remove clutch drum (1) using T 15 bit from Briggs & Stratton Tool #19442 Torqux Star Bit Set, Fig. 8.

NOTE: Clutch drum mounting screw remains captive in clutch drum.

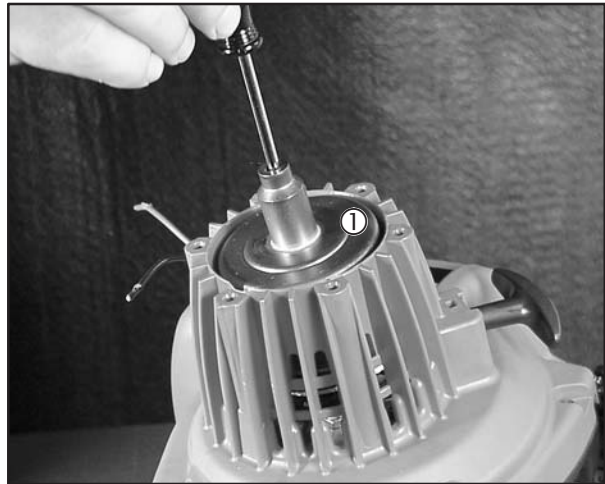

Fig. 8

3. Remove clutch (1) and thrust washer (2), Fig. 9.

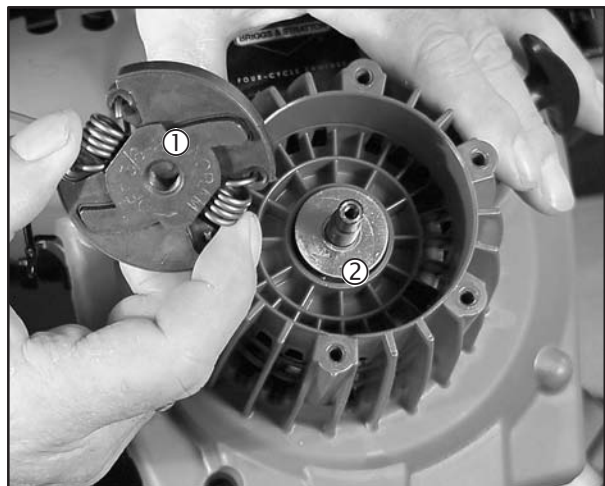

Fig. 9

4. Remove 2 screws (1) from blower housing, Fig. 10.

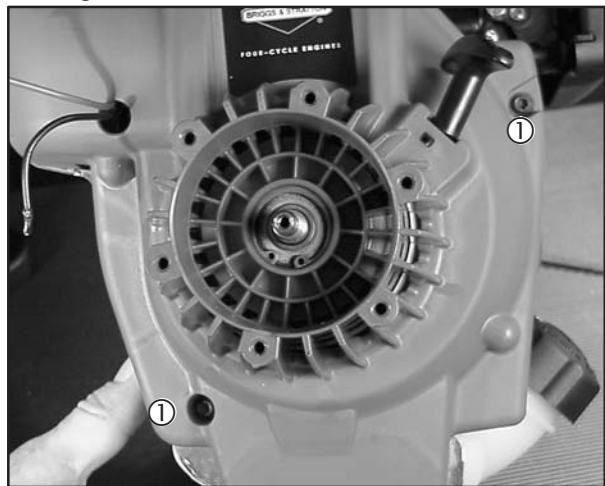

Fig. 10

5. Remove 4 screws (2) from cylinder shield side, Fig. 11.
6. Remove blower housing.

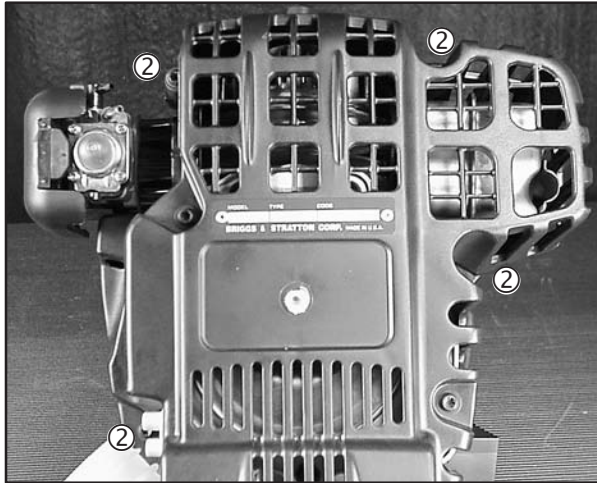

Fig. 11

7. Check ball bearing for rough spots or excessive looseness (wear).
 - a. If bearing is bad the blower housing must be replaced.

Starter rope inspection and replacement procedure is the same as direct drive engine.

Install Blower Housing – Clutch Drive Engine

Place a drop of engine oil on ball bearing journal on flywheel nut/crank adapter.

Assemble blower housing to engine.

NOTE: Be sure stop switch wires are routed through blower housing.

1. Install 4 screws (2) from cylinder shield side, Fig. 12.

Torque screws to 25 in. lbs. (3 Nm).

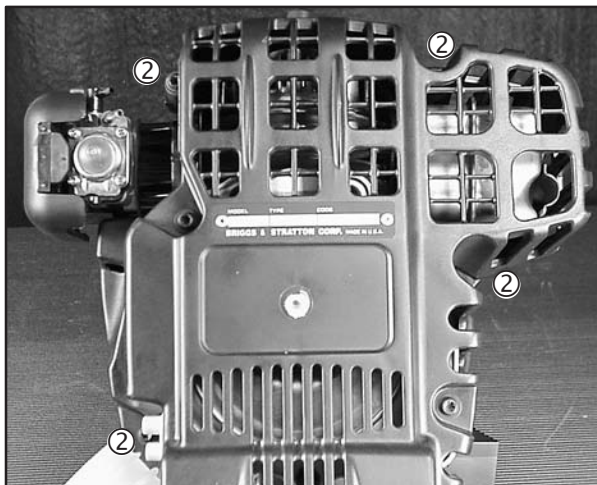

Fig. 12

2. Install 2 screws in blower housing, Fig. 13. Torque screws to 40 in. lbs. (5 Nm).

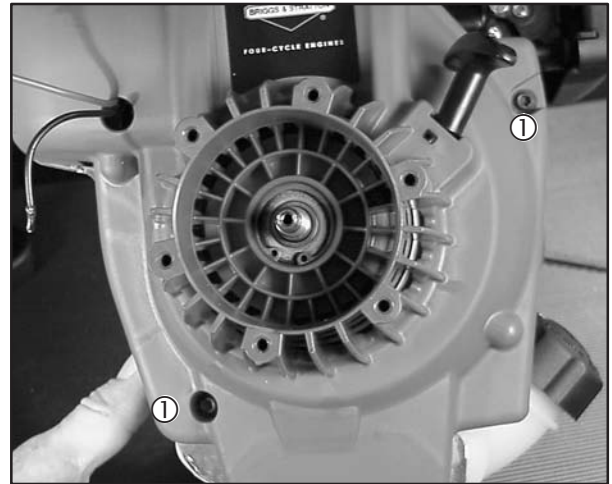

Fig. 13

3. Install thrust washer (1), Fig. 14.
4. Assemble clutch to shaft with writing up (2). Hand tighten clutch.
5. Assemble clutch drum to engine, Fig. 15. Torque screw to 20 in. lbs. (2.0 Nm).

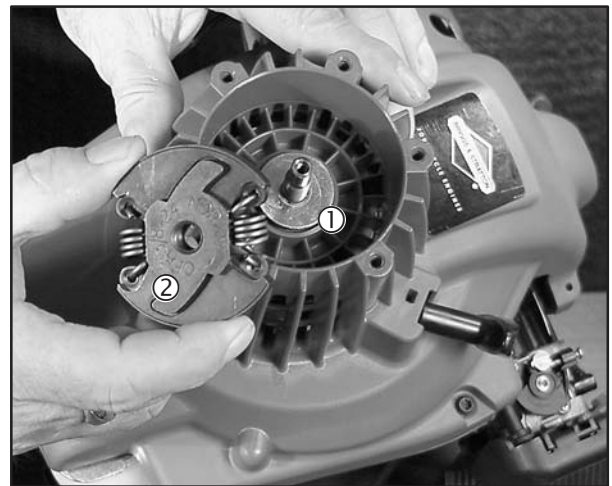

Fig. 14



Fig. 15

- Assemble clutch housing cover to blower housing.

NOTE: Raised boss (1) on clutch housing cover must fit in recessed boss (2) on blower housing, Fig. 16.

Torque screws to 20 in. lbs. (5.0 Nm).

2

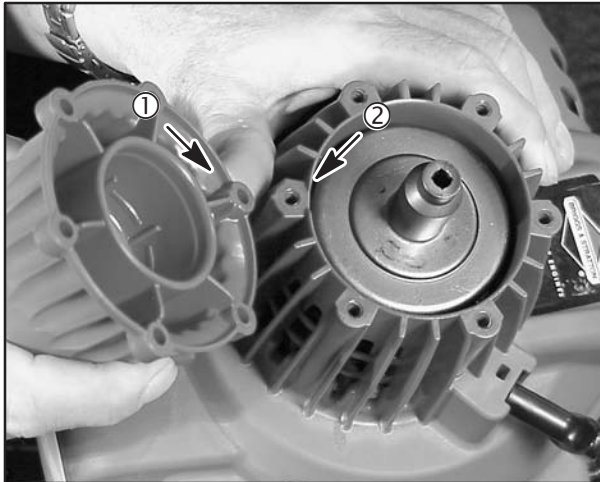

Fig. 16

IGNITION COIL

Remove Coil

Use the T-25 driver.

- Disconnect stop switch wire (1).
- Remove 2 screws (2) and ignition coil with ground wire, Fig. 17.

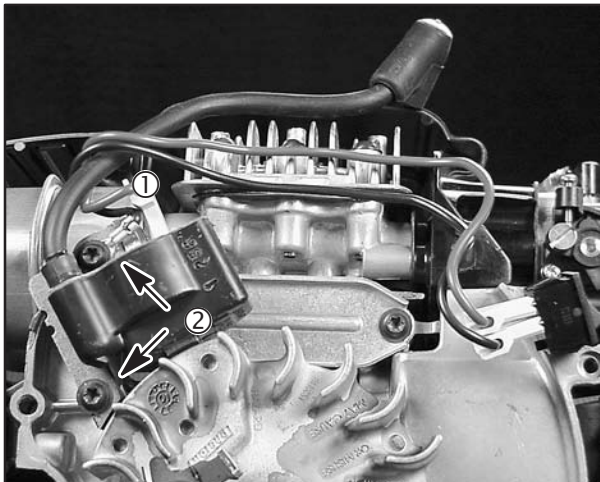

Fig. 17

Install Coil

- Rotate flywheel so that magnets are away from coil.

- Install coil. Install stop switch wires.

NOTE: Route stop switch wires behind spark plug wire and then over spark plug as shown, Fig. 18.

- Pull coil up as far as it will go and temporarily tighten screws.

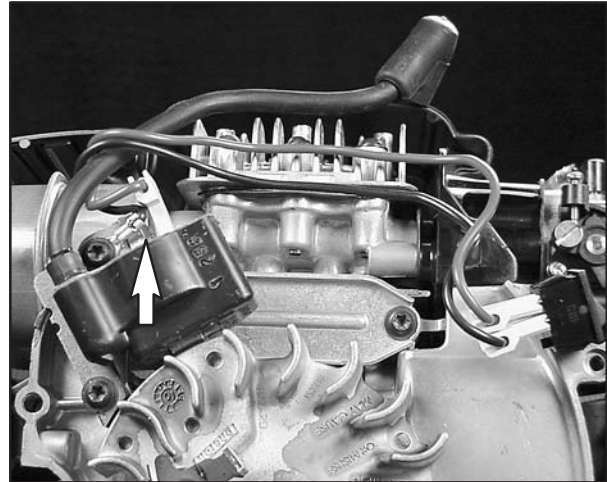

Fig. 18

Adjust Air Gap

- Rotate flywheel so that magnets are under armature.
- Insert feeler gage .010" – .014" (.25 – .35 mm) between flywheel magnets and armature, Fig. 19.
- Loosen coil mounting screws so magnet pulls coil down to feeler gage.
- Torque screws to 60 in. lbs.
- Remove feeler gage.

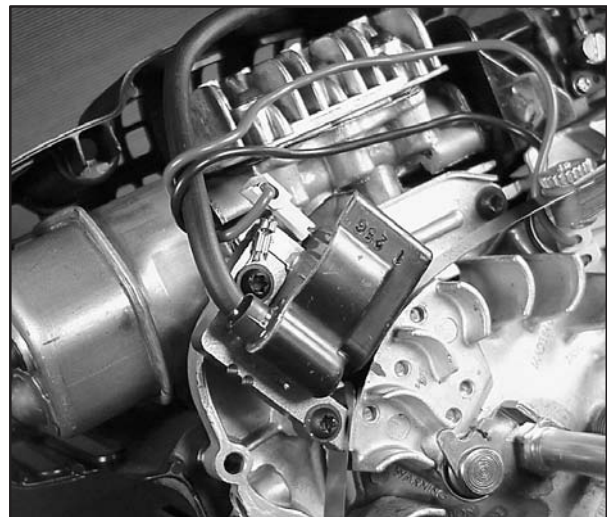

Fig. 19

FLYWHEEL

Remove Flywheel – Direct Drive Engine

Remove the ignition coil.

1. Install flywheel puller Tool #19538 (1) with the concave side down.
2. Rotate puller so that it is under the starter pawls (2).
3. Insert the driver in to flywheel nut /crank adapter (3).
4. Secure flywheel with strap wrench Tool #19433.
5. Turn driver counterclockwise to loosen flywheel nut/crank adapter, Fig. 20.
6. Continue turning until flywheel loosens.

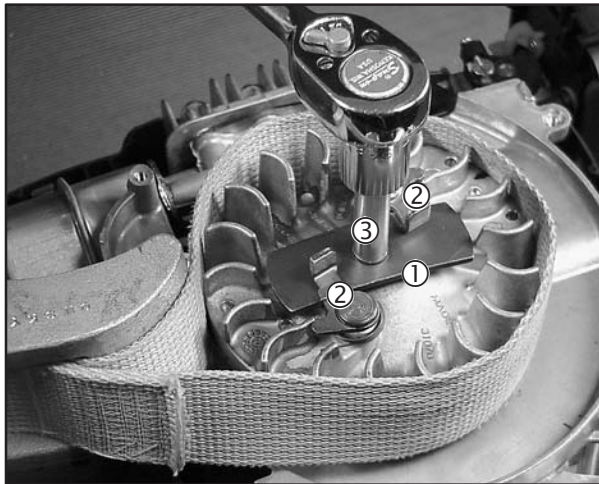

Fig. 20

NOTE: The flywheel key is part of the flywheel casting.

Check the key (1) for damage. If key is damaged or sheared the flywheel must be replaced, Fig. 21.

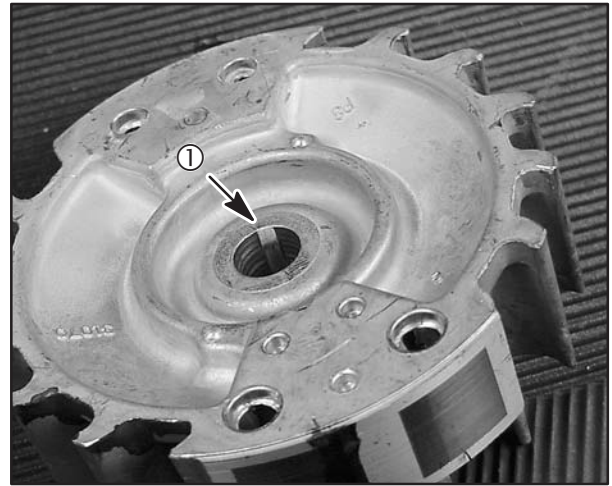

Fig. 21

Install Flywheel – Direct Drive Engine

Align flywheel key with keyway in crankshaft and install flywheel.

1. Secure flywheel with strap wrench Tool #19433.
2. Install flywheel nut/crank adapter and insert driver into flywheel nut/crank adapter.
3. Torque to 170 in. lbs. (19 Nm), Fig. 22.

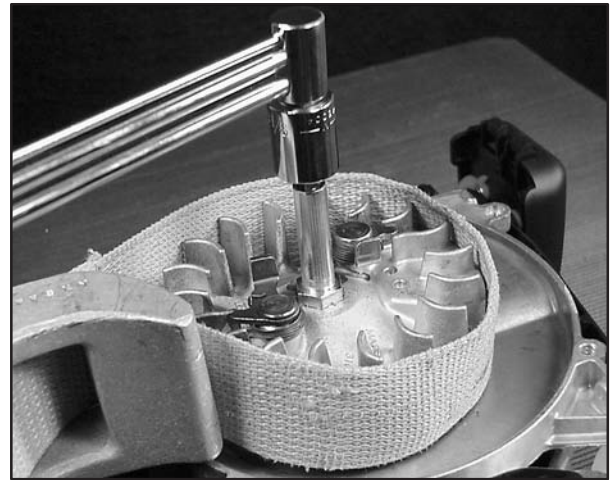

Fig. 22

4. Install ignition coil.

Remove Flywheel – Clutch Drive Engine

Remove the ignition coil.

1. Secure flywheel with strap wrench Tool #19433.
2. Loosen flywheel nut/crank adapter (1) with 9/16" wrench, Fig. 23. Then remove.

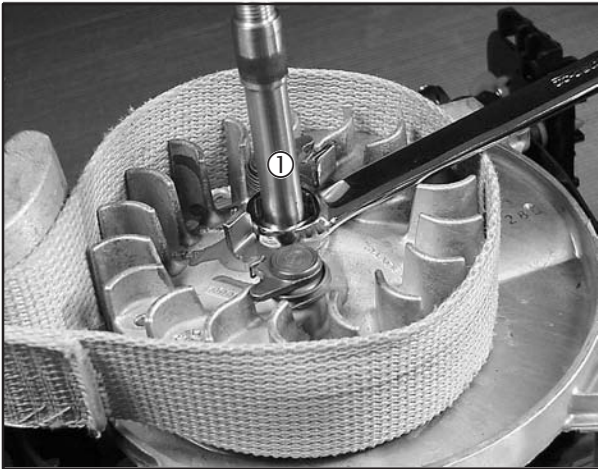

Fig. 23

3. Thread flywheel nut/tool (1) from Tool #19538 on to crankshaft, Fig. 24.



Fig. 24

4. Install flywheel puller Tool #19538 with the concave side down.
5. Rotate puller so that it is under the starter pawls.
6. Insert the driver in to flywheel nut.
7. Secure flywheel with strap wrench Tool #19433.
8. Turn driver until flywheel loosens.

Check the key for damage. If key is damaged or sheared the flywheel must be replaced.

Install Flywheel – Clutch Drive Engine

Align flywheel key with keyway in crankshaft and install flywheel.

1. Secure flywheel with strap wrench Tool #19433.
2. Install flywheel nut/crank adapter and torque to 170 in. lbs. (19 Nm).

FUEL TANK

The fuel tank and fuel lines are serviced as an assembly.

Remove Fuel Tank

Drain fuel tank.

1. Disconnect fuel lines at carburetor.
2. Remove fuel tank, Fig. 25.
3. Remove rubber tank supports (1).
4. Remove heat shield (2).

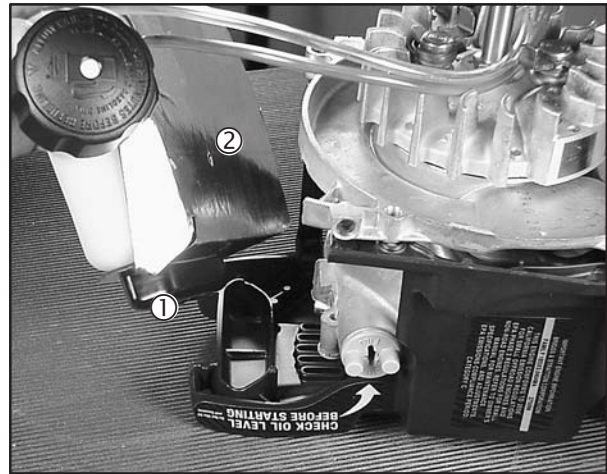

Fig. 25

Install Fuel Tank

1. Install heat shield and rubber tank supports.
2. Insert tank in to pocket in cylinder shield.
3. Install fuel supply line (1) and fuel return line (2), Fig. 26.

NOTE: Fuel line is colored. Fuel return line is clear.

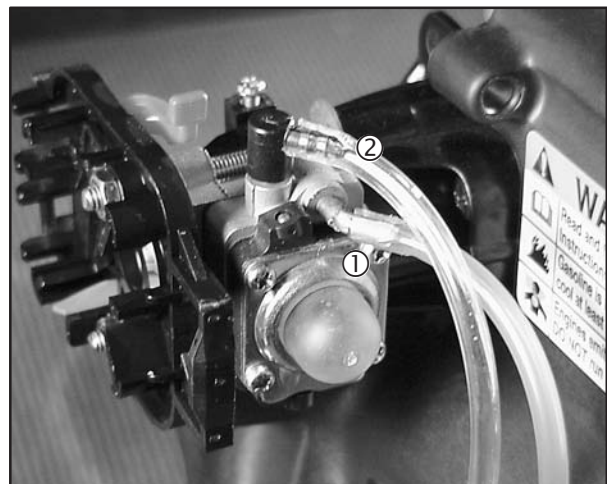

Fig. 26

CYLINDER HEAD

NOTE: Valves and seats are not serviceable.

Remove Cylinder Head

Remove the flywheel and ignition coil.

1. Remove 2 screws (1) and cylinder shield, Fig. 27.

Use the T-25 driver.

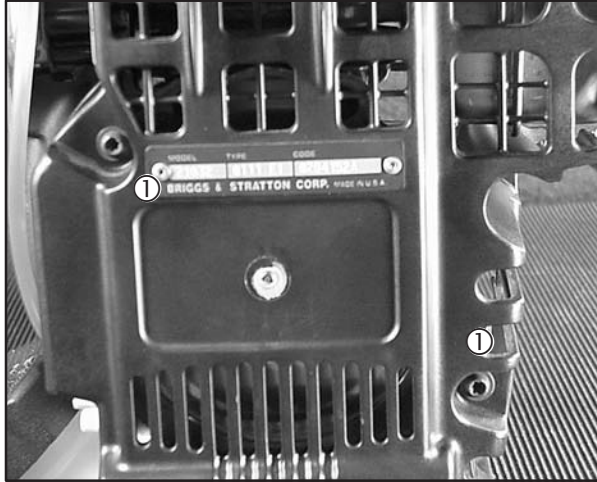

Fig. 27

2. Remove 7 cylinder head bolts (2), Fig. 28.
3. Remove cylinder head and discard gasket.

NOTE: With the cylinder head removed, check the cylinder bore. If the bore is worn or scored the engine must be replaced.

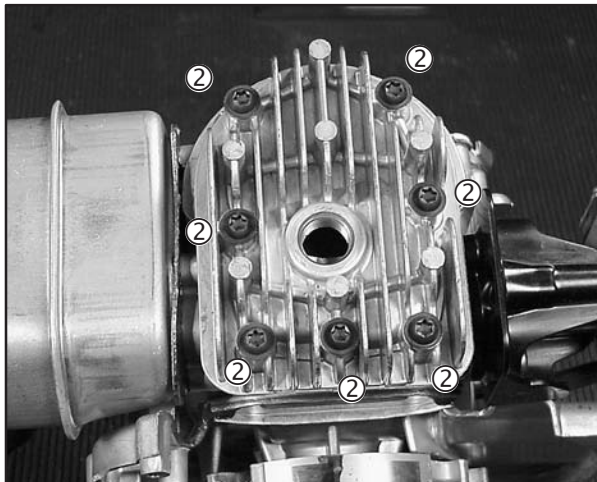

Fig. 28

Install Cylinder Head

1. Install cylinder head with new gasket.
2. Torque head bolts in sequence shown to 75 in. lbs. (8.5 Nm), Fig. 29.

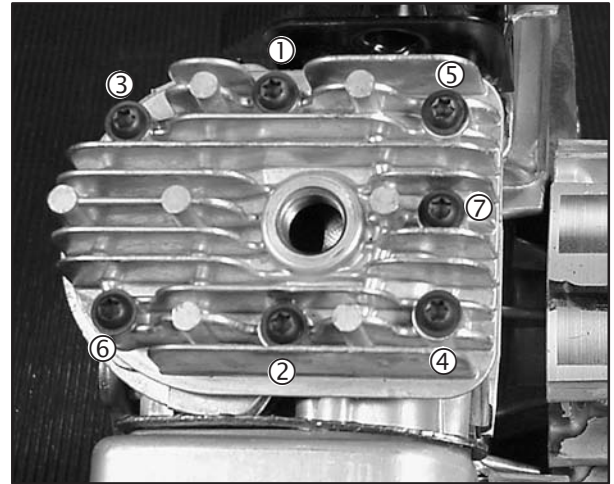

Fig. 29

MUFFLER

Replace Muffler

Use the T-25 driver.

1. Remove the top 3 muffler bolts (1), Fig. 30. Remove muffler. Discard gasket.

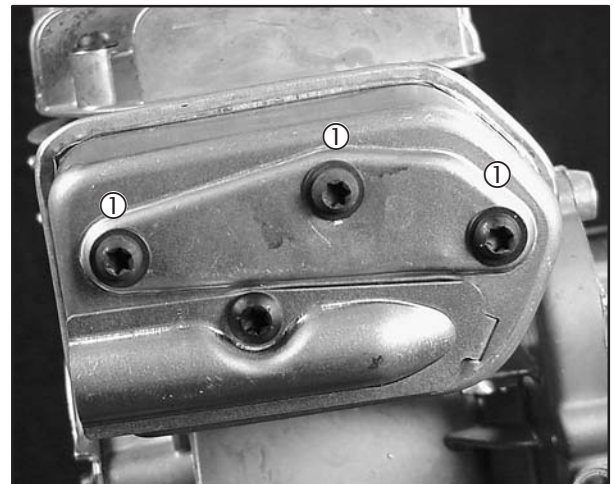

Fig. 30

2. Install muffler with new gasket. Torque screws to 60 in. lbs.

2

3. Install cylinder shield. Torque screws (1) to 40 in. lbs. (5 Nm), Fig. 31.

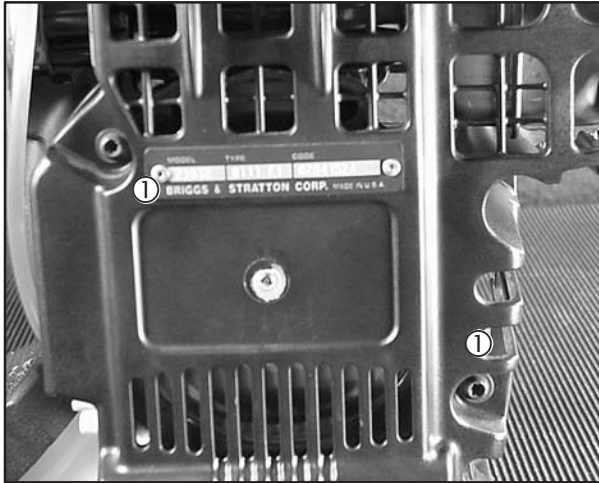

Fig. 31

CARBURETOR

The carburetor is serviced as an assembly.

Remove Carburetor

Drain fuel tank.

1. Disconnect fuel lines at carburetor.
2. Remove air cleaner cover and filter.
3. Remove 2 nuts (1), Fig. 32.
4. Remove air cleaner base.
5. Slide carburetor from studs.

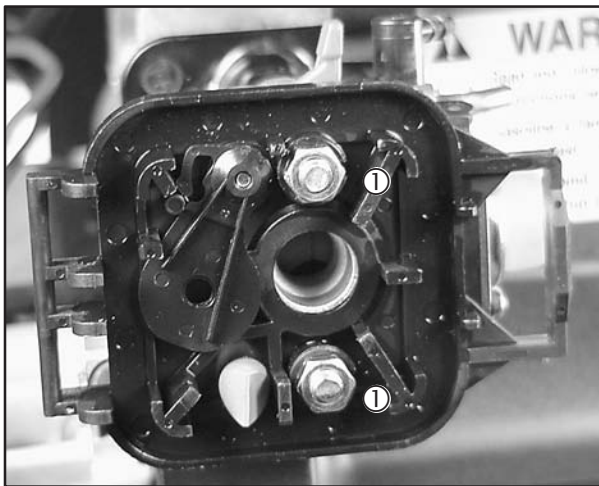

Fig. 32

6. Remove and discard the old mounting gasket.

Install Carburetor

1. Install new mounting gasket.

Make sure pulse hole in gasket (1) is aligned with pulse channel (2) in carburetor spacer, Fig. 33.



Fig. 33

2. Slide carburetor on to studs, Fig. 34.

NOTE: Make sure O-ring (1) is assembled to carburetor.



Fig. 34

3. Install air cleaner base.
4. Insert breather check valve (1) through air cleaner base. Make sure slot in breather valve is in a vertical position as shown, Fig. 35.
5. Install nuts (2).

 - a. Torque nuts to 25 in. lbs. (3 Nm).

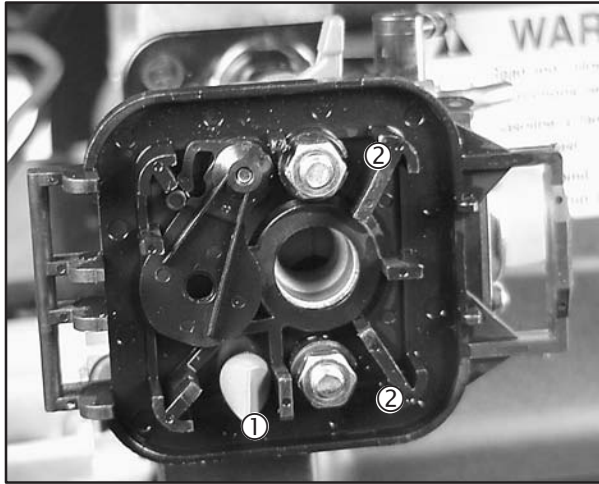

Fig. 35

6. Install fuel supply line (1) and fuel return line (2), Fig. 36.
7. Assemble throttle cable to carburetor.
8. Assemble air cleaner.

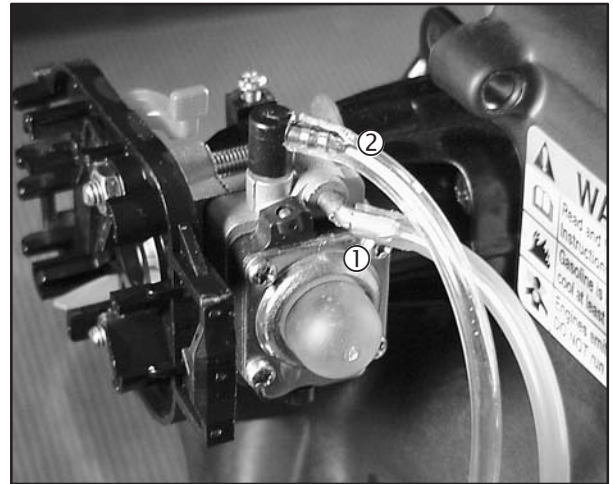

Fig. 36

Idle Speed Adjustment

NOTE: Correct adjustment is necessary to obtain proper acceleration and clutch disengagement on clutch drive engines

1. Start engine and warm up approximately 5 minutes before adjusting.
2. Make sure throttle lever is contacting idle adjustment screw (1), Fig. 37.
3. Adjust idle speed to:

3600 RPM – Clutch Drive Engine

4000 RPM – Direct Drive Engine



Fig. 37

SPECIFICATIONS

Micro Engine Dimensions

Cylinder Bore	1.575 in. (40.00 mm)
Piston Ring End Gap – Top Ring	.004 – .011 in. (.10 – .28 mm)
Piston Ring End Gap – Second Ring	.004 – .011 in. (.10 – .28 mm)
Piston Ring End Gap – Oil Control Rings	.008 – .027 in. (.20 – .69 mm)
Spark Plug Gap	.022 – .028 in. (.56 – .71 mm)

Micro Engine Torque Specifications

Fastener Location	Quantity Used	Torque Inch Pounds	Torque Newton Meters
Blower Housing	2	40	5
Camshaft Cover	2	50	6
Carb Adapter	2	60	7
Carb Mount Stud	2	25	3
Clutch Drum	1	20	2
Cylinder Head	7	75	8
Cylinder Shield to Blower Housing	4	25	3
Cylinder Shield (Rear Housing)	2	40	5
Flywheel Nut/ Crank Adapter	1	170	19
Ignition Coil	2	60	7
Muffler Deflector	2	40	5
Muffler	3	60	7
Spark Plug #696876	1	180	20
Sump Cover	9	60	7
Valve Cover	2	60	7

***Repair Manuals for other
Briggs & Stratton Engines, order:***

CE8069 – Out of Production Engines (From 1919-1981)

270962 – Single Cylinder “L” Head (Built after 1981)

271172 – Twin Cylinder “L” Head

272144 – Vanguard™ V-Twin OHV

272147 – Single Cylinder OHV

273521 – Intek™ V-Twin Cylinder OHV

275110 – Outboard

MS-0729 – 3 Cylinder Liquid Cooled



**Quality Starts With A
Master Service Technician**



**Equipment & Engine
Training Council**

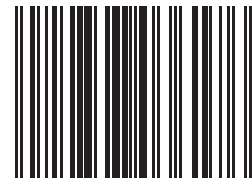

0 24847 03617 6

BRIGGS & STRATTON CORPORATION
Milwaukee, WI 53201
Part No. 275072-12/03 Printed in U.S.A.
www.briggsandstratton.com