

MATRIX AC/DC • AC/DC R

2200 • 3000

EN

Operator's manual

READ CAREFULLY



**WELDING
TOGETHER**

CEA COSTRUZIONI ELETTROMECCANICHE ANNETTONI S.p.A.

C.so E. Filiberto, 27 - 23900 Lecco - Italy
Tel. ++39.0341.22322 - Fax ++39.0341.422646
Cas. Post. (P.O.BOX) 205
E-mail: cea@ceaweld.com - web: www.ceaweld.com

Introduction	2
Description	2
Features	2
Usage limits (IEC 60974-1)	3
Technical data	3
Open the packaging	4
Installation	4
Connection to the electrical supply	4
Instructions for use	4
Interfacing accessories (optional)	5
TIG welding	6
Electrode welding (MMA)	7
Maintenance	7
Optional	8
The pointing out of any difficulties and their elimination	8
Digital interface PCB replacement	8
Meaning of graphic symbols on machine	9
Adjustment of electronic circuit board	9
Wiring diagram (MATRIX 2200 AC/DC)	10
Wiring diagram (MATRIX 3000 AC/DC - AC/DC R)	12
Key to the electrical diagram	14
Colour key	14

Introduction

Thank you for buying our product.

In order to get the best performance out of the plant and ensure the maximum lifespan of its parts, the use and maintenance instructions contained in this manual must be read and strictly complied with, as well as **the safety instructions contained in the relevant folder**. If repairs to the plant are required, we recommend that our clients contact our service centre workshops, as they have the necessary equipment and personnel that are specifically trained and constantly updated.

All our machines and equipment are constantly developed and so changes may be made in terms of their construction and features.

Description

MATRIX 2200 AC/DC

Powerful, compact, and light weight, the **MATRIX 2200 AC/DC** units represent the most innovative, high performance, and technically advanced single-phase inverter generators for TIG welding to be found. The **PFC (Power Factor Correction)** device fitted optimises absorption of energy from the mains, means that these high power generators can be connected to power supply systems with 16A fuses without any problem. The user friendly digital control and advanced functions ensure complete stability of all welding parameters, guaranteeing high quality TIG welding for all metals, aluminium, and its alloys, as well as MMA welding with any type of electrode. The **MATRIX 2200 AC/DC** units are the ideal solution for all professional welding applications and for maintenance work that calls for power and portability.

MATRIX 3000 AC/DC - MATRIX 3000 AC/DC R

Using the most modern IGBT based inverter technology, the three-phase TIG generator with high frequency **MATRIX 3000 AC/DC** or **3000 AC/DC R** ignition, comes with an innovative digital control for all welding parameters.

Technologically cutting-edge, robust, easy to use with both direct and alternating current, fitted with high potential digital control, this generator can be used for high quality TIG welding of all metals including aluminium and alloys. This means that the machine is particularly suitable for specific uses in industry and the maintenance sector.

It also guarantees excellent performance for MMA welding, even when using particularly difficult cellulosic and basic electrodes.

Features

The characteristics found in all welding machines in the MATRIX AC/DC range are:

- Innovative and compact design.
- Compact size and light weight for easy transportation.
- Metallic main structure with shock-proof plastic front panel.
- Protective visor on the control panel.
- Robust handle integrated into the chassis.
- Digital control, regulation and monitoring of all welding parameters.
- Digital display for pre-setting welding parameters.
- Digital ammeters and voltmeters are standard fittings, with pre-setting of welding current and saving of the latest value (Hold-function).
- coldTACK function in TIG HF DC. Innovative spot welding device to achieve precise and safe joining with a minimal thermal input. "Multi-coldTACK" function grants cold spotting in a rapid sequence, thus further widening the benefits of the single spot. Thanks to "Perfect-Point" function, coldTACK allows to obtain the most precise spot positioning.
- Feature that makes it possible to save and call up personalised welding programs.
- Self-diagnosis device.
- Overheating thermostatic protection.
- Automatic compensation for mains voltage fluctuations within $\pm 20\%$.
- Safety barrier against excess voltage from mains.
- Electromagnetic disturbance is reduced due to high frequency being involved only during the arc ignition phase.
- "Energy Saving" function to operate the power source cooling fan and the torch water cooling only when necessary.
- Low absorbed current consumption.
- This generator also conforms to all the standards and directives in force in the European Community.

- **TIG**
 - Excellent TIG welding characteristics.
 - High frequency arc striking of TIG welding, precise and efficient even from long distance.
 - Using special TIG torches allows remote adjustment of welding current directly from the torch.
 - The diameter of the electrode used is set to allow greater control of the ignition and dynamics of the arc.
 - Standard built-in pulsation (from 0,5 to 2000 Hz) with provision for entering the SYN Pulse function.
 - Square, mixed, sinusoidal, or triangular wave shape selector.
 - Square welding wave frequency balancing / regulation and "Balance Plus".
- **MMA**
 - The VRD (Voltage Reduction Device) can be activated, which reduces voltages to below 12 V, which means that the welding machine can be used in ambient conditions in which there is a high electrical risk, thereby providing maximum operator safety.
 - "Arc Force" adjustable to select the best dynamic characteristics for the welding arc.
 - "Hot Start" adjustable to improve ignition with particularly difficult electrodes.
 - Anti-sticking function to avoid the electrodes sticking.

MATRIX 2200 AC/DC

- The PFC device makes the wave form of the current absorbed sinusoidal, which results in no harmonic disturbance on the mains and optimisation of absorption, which allows you to use the generator's full power with a 16 A fuse, as well as ensuring greater protection of the welding machine against fluctuations in the power supply voltage.

MATRIX 3000 AC/DC R

- Suitable for use on all robotic systems.
- Optional "RoboMAT 1" interface that handles all process start/stop signals, regulation of the principal welding parameters, and also acts as a flexible, efficient interfacing system that meets all Analogue / Digital connection requirements.



Usage limits (IEC 60974-1)

The use of a welder is typically discontinuous, in that it is made up of effective work periods (welding) and rest periods (for the positioning of parts, the replacement of wire and underflushing operations etc. This welder is dimensioned to supply a I_2 max nominal current in complete safety for a period of work of X% of the total usage time. The regulations in force establish the total usage time to be 10 minutes. The work cycle is considered to be X% of this period of time. If the permitted work cycle time is exceeded, an overheat cut-off occurs to protect the components around the welder from dangerous overheating. Activation of thermal protection is signaled by "t° C" flashing on control panel display (for further information see the MTA control panel manual). After several minutes the overheat cut-off rearms automatically and the welder is ready for use again.

Technical data

The general technical data of the system are summarized in table 1.

Table 1

Model	MATRIX 2200 AC/DC		MATRIX 3000 AC/DC MATRIX 3000 AC/DC R		
	TIG	MMA	TIG	MMA	
Power supply 50/60 Hz	V	1~ 230 ±20%		3~ 400 ±20%	
Power supply: Z_{max}	Ω	(*)		0,092	
Input power @ I_2 Max	kVA	6,5	7,0	9,6	
Delayed fuse (I_2 @ 100%)	A	16		10	
Power factor / cosφ		0,99 / 0,99		0,95 / 0,99	
Efficiency degree	η	0,77		0,76	0,81
Open circuit voltage	V	100		100	
Current range	A	5÷220	10÷180	5÷300	10÷250
Duty cycle @ 100% (40°C)	A	140	120	210	190
Duty cycle @ 60% (40°C)	A	180	150	250	220
Duty cycle @ X% (40°C)	A	220 (30%)	180 (30%)	300 (35%)	250 (40%)
Usable electrodes	mm	1,2÷2,4	1,6÷4,0	1,2÷4,0	1,6÷5,0
Standards		IEC 60974-1 • IEC 60974-3 • IEC 60974-10 CE S		IEC 60974-1 • IEC 60974-3 • IEC 60974-10 CE S	
Protection class		IP 23 S		IP 23 S	
Insulation class		F		F	
Dimensions   	mm	465 - 390 - 185		495 - 390 - 185	
Weight	kg	15,5		19	

IMPORTANT:

These systems, tested in accordance with the requirements of the EN/IEC 61000-3-3 standard, satisfy the requirements laid down by the EN/IEC 61000-3-11 standard.

MATRIX 2200 AC/DC

(*) This equipment meets the requirements laid down in the EN/IEC 61000-3-12 standard on harmonic currents.

MATRIX 3000 AC/DC - AC/DC R

This equipment complies with EN/IEC 61000-3-12 provided that the maximum permissible system impedance Z_{max} is less than or equal to 0,092 at the interface point between the user's supply and the public system. It is the responsibility of the installer or user of the equipment to ensure, by consultation with the distribution network operator if necessary, that the equipment is connected only to a supply with maximum permissible system impedance Z_{max} less than or equal to 0,092.

How to lift up the machine

The weld machine has a strong handle all in one with the frame, used for transporting the machine manually only.

NOTE: These hoisting and transportation devices conform to European standards. Do not use other hoisting and transportation systems.

Open the packaging

The system essentially consists of:

- **MATRIX AC/DC** or **AC/DC R** weld unit.
- Separately:
 - Welding TIG torches (optional).
 - Neck strap (optional MATRIX 2200 AC/DC).
 - Ground cable, complete with rapid coupling (optional).
 - Coolant unit for welding torch (optional).
 - trolley for transportation (optional).
 - "RoboMAT 1" analogue / digital robot interface (optional this interface must only be used for automatic / robotised equipments).
 - Generator interconnection cable - robot interface (optional - this interface must only be used for automatic / robotised equipments).

Upon receiving the system:

- Remove the welding generator and all relevant accessories-components from their packaging.
- Check that the weld machine is in good condition, if not report any problems immediately to the seller-distributor.
- Make sure all ventilation grilles are open and that no foreign bodies are blocking the air circulation.

Installation

The installation site for the system must be carefully chosen in order to ensure its satisfactory and safe use. The user is responsible for the installation and use of the system in accordance with the producer's instructions contained in this manual. Before installing the system the user must take into consideration the potential electromagnetic problems in the work area. In particular, we suggest that you should avoid installing the system close to:

- Signalling, control and telephone cables.
- Radio and television transmitters and receivers.
- Computers and control and measurement instruments.
- Security and protection instruments.

Persons fitted with pace-makers, hearing aids and similar equipment must consult their doctor before going near a machine in operation. The environment in which the equipment is installed must be suitable for the casing's protection level. This system is cooled by means of the forced circulation of air, and must therefore be placed in such a way that the air may be easily sucked in and expelled through the apertures made in the frame.

The welding unit is characterised by the following levels:

- Protection level IP 23 S indicates that the equipment can be used both indoors and outdoors.
- Use class "S" means that the equipment can be used in conditions subject to heightened electrical shock.

Connection to the electrical supply

Connection of the machine to the user line (electrical current) must be performed by qualified personnel.

Before connecting the welding machine to the mains power supply, make sure that rated voltage and frequency correspond to those provided by the mains power supply and that the welding machine's power switch is turned to "O".

MATRIX 2200 AC/DC • Single-phase power supply

Use the welder's own plug to connect it up to the main power supply. Proceed as follows if you have to replace the plug:

- 2 conducting wires are needed for connecting the machine to the supply.
- The third, which is YELLOW GREEN in colour is used for making the "GROUND" connection.

MATRIX 3000 AC/DC - AC/DC R • Three-phase power supply

The four-pole cable supplied with the system must be used for the connection to the mains power supply. This cable is made up of:

- Three conductors that are used to connect the machine to the power supply.
- The fourth, which is YELLOW-GREEN, is used to form the "GROUND" connection.

Connect a suitable load of normalised plug (3p+t) to the power cable and provide for an electrical socket complete with fuses or an automatic switch. The ground terminal must be connected to the ground conducting wire (YELLOW-GREEN) of the supply.

Table 2 shows the capacity values that are recommended for fuses in the line with delays.

NOTE: Any extensions to the power cable must be of a suitable diameter, and absolutely not of a smaller diameter than the special cable supplied with the machine.

Instructions for use

COMMAND AND CONTROL UNITS (Fig. A)

- Pos. 1** MTA command and control panel.
- Pos. 2** Positive pole quick connection.
- Pos. 3** Fast coupling TIG torch gas tube.
- Pos. 4** TIG weld auxiliary control connector (torch button, remote controlpedal, etc.).
- Pos. 5** Negative pole quick connection.
- Pos. 6** Power supply switch. In the "O" position the welder is off.
- Pos. 7** Mains cable.
- Pos. 8** Welding gas hose.

Table 2

Model		MATRIX 2200 AC/DC		MATRIX 3000 AC/DC MATRIX 3000 AC/DC R	
		TIG	MMA	TIG	MMA
Input power @ I ₂ Max	kVA	6,5	7,0	9,6	
Delayed fuse (I ₂ @ 100%)	A	16		10	
Duty cycle @ X% (40°C)	A	220 (30%)	180 (30%)	300 (35%)	250 (40%)
Mains cable					
Length	m	3,5		4	
Section	mm ²	2,5		2,5	
Ground cable					
Section	mm ²	25		35	



Interfacing accessories (optional)

“RoboMAT 1” analogue / digital robot interface
 Fitted on the back of the MATRIX 3000 AC/DC R welding machine (Pos. 1, Fig. B).

“RoboMAT 1” analogue / digital robot interface connection cable - Cutting robot or for automatic equipment

Connect the cable to the analogue / digital interface as shown in figure (Pos. 2, Fig. B).

To connect the other end of this cable see the diagram in the manual for the “RoboMAT 1” analogue / digital robot interface.

IMPORTANT: Do not keep the “RoboMAT 1” analogue / digital robot interface connected to the generator, unless it is also powered by the automatic system.

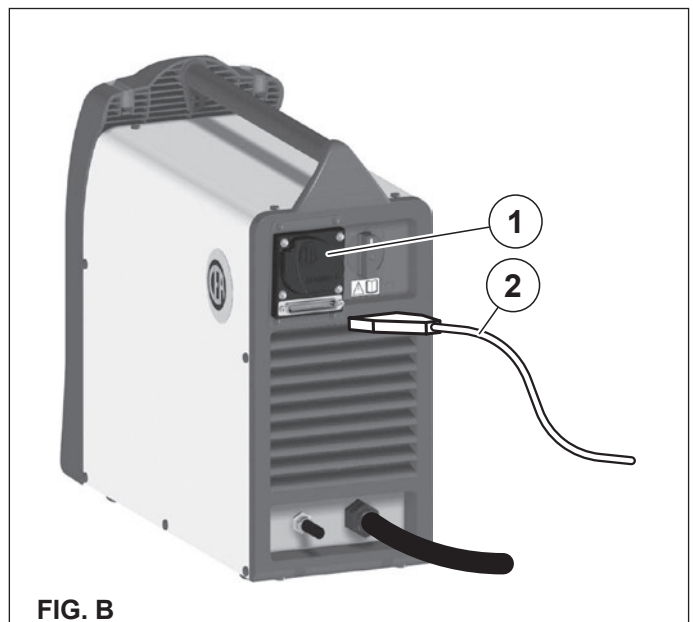

TIG welding

In the TIG process welding is achieved by melting the two metal pieces to be joined, with the possible addition of material from the outside, using an arc ignited by a tungsten electrode. The molten bath and the electrode are protected by an inert gas (for example, Argon). This type of welding is used to weld thin sheet metal or when elevated quality is required.

1) Connecting the welding cables (Fig. C):

- Connect the gas hose to the Argon cylinder.
- With the machine switched off:
 - Connect the ground cable to the snap-on connector marked + (positive).
 - Connect the relative ground clamp to the workpiece or to the workpiece support in an area free of rust, paint, grease, etc..
 - Connect the TIG torch power cable to the snap-on connector marked - (negative).
 - Connect the torch gas tube to the connection (Pos. 3, Fig. A).
 - Insert the torch button connector in the 6 poles holder (Pos. 4, Fig. A).

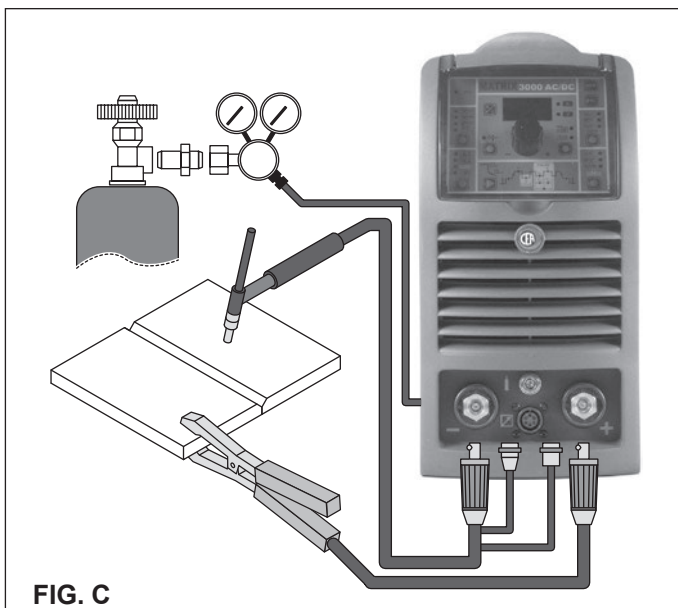

FIG. C

- 2) Switch the welding machine on by moving the power supply switch to I (Pos. 6, Fig. A).
- 3) Make the adjustments and select the parameters on the control panel (for further information see the MTA control panel manual).

TIG WELDING WITH "Lift" TYPE STRIKING

- 4a) Open the gas cylinder and flow regulator.
- 5a) Put the electrode at the point at which welding is to begin, put the TIG torch at an angle so that the edge of the gas nozzle is not on top of the piece to be welded, keeping contact between the point of the electrode and the piece to be welded (Fig. D-1).
- 6a) Press the torch button.
- 7a) The "Lift" function strikes the arc when the TIG torch electrode comes into contact with the workpiece and is then removed (Fig. D-2).
- 8a) Carry out TIG welding (Fig. D-3).
To end welding:
 - Lift the torch slowly, at a certain point the welding current decreases, and then stop.
 - The welding machine follows an automatic down slope along with extinguishing of the arc.
- 9a) When finished welding remember to shut off the gas cylinder.

TIG WELDING WITH HIGH FREQUENCY STRIKING (HF)

- 4b) Open the gas cylinder and flow regulator.
- 5b) Put the electrode at the point at which welding is to begin, put the TIG torch at an angle so that the edge of the gas nozzle is not on top of the piece to be welded, keeping a 2-3 mm gap between the point of the electrode and the piece to be welded (Fig. E-1).
- 6b) Press the torch button.
- 7b) The voltaic arc strikes even without contact between the TIG torch electrode and the workpiece (Fig. E-2).
- 8b) To continue welding put the torch back in its normal position (Fig. E-3).

IMPORTANT: The high frequency switches off automatically after switching on.

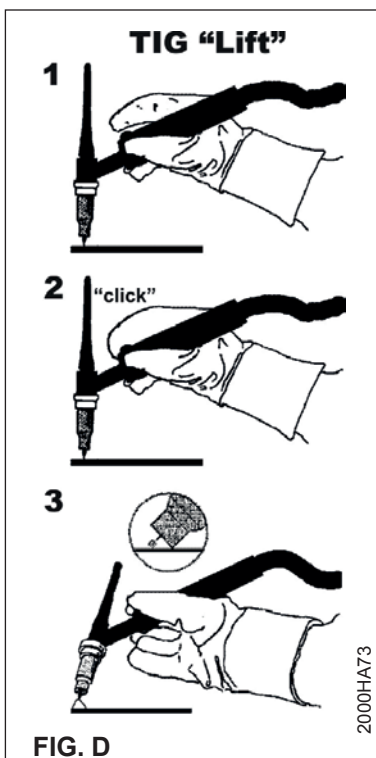

FIG. D

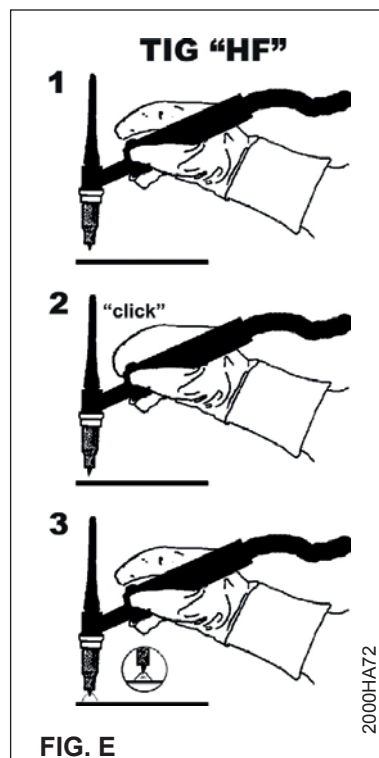

FIG. E

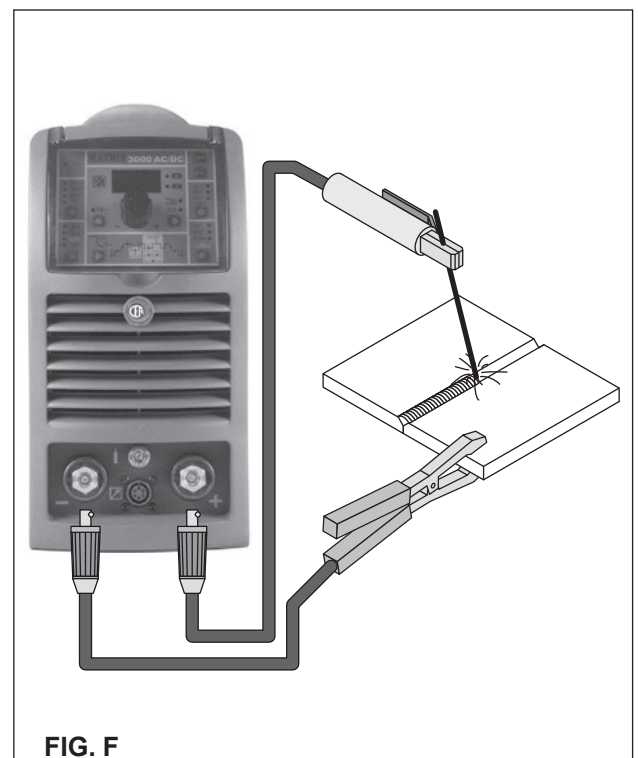

FIG. F

PART TO BE WELDED

The part to be welded must always be connected to ground in order to reduce electromagnetic emission. Much attention must be afforded so that the ground connection of the part to be welded does not increase the risk of accident to the user or the risk of damage to other electric equipment. When it is necessary to connect the part to be welded to ground, you should make a direct connection between the part and the ground shaft. In those countries in which such a connection is not allowed, connect the part to be welded to ground using suitable capacitors, in compliance with the national regulations.

WELDING PARAMETERS

Table 3 shows the currents to use with the respective electrodes for TIG welding. This input is not absolute but is for your guidance only; read the electrode manufacturers' instructions for a specific choice. The diameter of the electrode to use is directly proportional to the current being used for welding.

Table 3

Ø ELECTRODE (mm)	CURRENT (A)
1,2	10 ÷ 80
1,6	70 ÷ 150
2,4	140 ÷ 250
3,2	225 ÷ 400
4,0	300 ÷ 500

Electrode welding (MMA)

The welding electrode is used to weld most metals (various types steel, etc.), for which rutilic and basic electrodes are used.

- Connecting the welding cables (Fig. F):
Disconnect the machine from the mains power supply and connect the welding cables to the output terminals (Positive and Negative) of the welding machine, attaching them to the clamp and ground with the polarity specified for the type of electrode being used (Fig.F). Always follow the electrode manufacturer's instructions. The welding cables must be as short as possible, they must be near to one another, positioned at or near floor level. Do not touch the electrode clamp and the ground clamp simultaneously.
- Switch the welding machine on by moving the power supply switch to I (Pos. 6, Fig. A).
- Make the adjustments and select the parameters on the control panel (for further information see the MTA control panel manual).
- Carry out welding by moving the torch to the workpiece. Strike the arc (press the electrode quickly against the metal and then lift it) to melt the electrode, the coating of which forms a protective residue. Then continue welding by moving the electrode from left to right, inclining it by about 60° compared with the metal in relation to the direction of welding.

PART TO BE WELDED

The part to be welded must always be connected to ground in order to reduce electromagnetic emission. Much attention must be afforded so that the ground connection of the part to be welded does not increase the risk of accident to the user or the risk of damage to other electric equipment. When it is necessary to connect the part to be welded to ground, you should make a direct connection between the part and the ground shaft. In those countries in which such a connection is not allowed, connect the part to be welded to ground using suitable capacitors, in compliance with the national regulations.

WELDING PARAMETERS

Table 4 shows some general indications for the choice of electrode, based on the thickness of the parts to be welded. The values of current to use are shown in table 5 with the respective electrodes for the welding of common steels and low-grade alloys. These data have no absolute value and are indicative data only. For a precise choice follow the instructions provided by the electrode manufacturer.

Table 4

WELDING THICKNESS (mm)	Ø ELECTRODE (mm)
1,5 ÷ 3	2
3 ÷ 5	2,5
5 ÷ 12	3,2
≥ 12	4

Table 5

Ø ELECTRODE (mm)	CURRENT (A)
1,6	30 ÷ 60
2	40 ÷ 75
2,5	60 ÷ 110
3,2	95 ÷ 140
4	140 ÷ 190
5	190 ÷ 240

The current to be used depends on the welding positions and the type of joint, and it increases according to the thickness and dimensions of the part.

The current intensity to be used for the different types of welding, within the field of regulation shown in table 5 is:

- High for plane, frontal plane and vertical upwards welding.
- Medium for overhead welding.
- Low for vertical downwards welding and for joining small pre-heated pieces.

A fairly approximate indication of the average current to use in the welding of electrodes for ordinary steel is given by the following formula:

$$I = 50 \times (\text{Øe} - 1)$$

Where:

I = intensity of the welding current

Øe = electrode diameter

Example:

For electrode diameter 4 mm

$$I = 50 \times (4 - 1) = 50 \times 3 = 150A$$

Maintenance

ATTENTION: Before carrying out any inspection of the inside of the generator, disconnect the system from the supply.

SPARE PARTS

Original spare parts have been specially designed for our equipment. The use of non-original spare parts may cause variations in performance or reduce the foreseen level of safety.

We decline all responsibility for the use of non-original spare parts.

GENERATOR

As these systems are completely static, proceed as follow:

- Periodic removal of accumulated dirt and dust from the inside of the generator, using compressed air. Do not aim the air jet directly onto the electrical components, in order to avoid damaging them.
- Make periodical inspections in order to individuate worn cables or loose connections that are the cause of overheating.

Optional

The remote controls can be only used in the 2-STROKE and 4-STROKE welding modes.

MANUAL REMOTE CONTROL

WARNING: *When using the machine for TIG welding it is OBLIGATORY to use the kit for simultaneously use – CEA code n° 460056.*

Weld current can be measured at a distance by connecting up this control. The display will show the previous maximum weld current value set on the welder. The remote control will adjust welding current from the minimum to this value (for further information see the MTA control panel manual). Just turn the adjustment knob on the welder to change the maximum output value.

FOOT SWITCH

The foot switch replaces the torch button and the welding current setting knob. The display will show the previous maximum weld current value set on the welder. The pedal will adjust the welding current from the minimum to this value (for further information see the MTA control panel manual). Just turn the adjustment knob on the welder to change the maximum output value.

NOTE:

- *To use the pedal control correctly, set the "welding mode" to 2-STROKE and then the welding parameters SLOPE UP time to 0 sec., SLOPE DOWN time to 0 sec.*
- *When using the machine for TIG welding the operator can use the torch button to start the weld and the pedal to regulate the welding current remotely.*

AIR AND/OR WATER-COOLED TORCH UP/ DOWN

The up/down torch replaces the current setting knob on the front of the welder. Press right (+) and left (-) button to adjust the active parameter. With this kind of torch, it is also possible to scroll the saved programmes by pressing the two (+) and (-) buttons. Turn the knob to scroll the programmes until an empty and unused programme is found.

NOTE: *Programme sequences can be created by placing an empty programme between saved ones.*

NOTE: *The value shown on the display during welding represents the effective current output with all types of control.*

The digital control unit of the generator is fitted with a control recognition device which allows it to identify which device is connected and take action accordingly. To allow the command recognition device to work correctly, connect (with the machine switched off) the required accessory to the relative connector and then switch on the welding machine with the on/off switch.

NOTE: *It is not possible to memorize or open programmes when the remote controls are connected (except for the torch with UP/DOWN commands).*

If a remote control is connected (followed by self-acknowledgement procedure) the machine will automatically return to the manual-welding phase if it has been pre-set for automatic welding.

The pointing out of any difficulties and their elimination

The supply line is attributed with the cause of the most common difficulties. In the case of breakdown, proceed as follows:







- 1) Check the value of the supply voltage
- 2) Check that the power cable is perfectly connected to the plug and the supply switch
- 3) Check that the power fuses are not burned out or loose
- 4) Check whether the following are defective:
 - The switch that supplies the machine.
 - The plug socket in the wall.
 - The generator switch.







NOTE: *Given the required technical skills necessary for the repair of the generator, in case of breakdown we advise you to contact skilled personnel or our technical service department.*

Digital interface PCB replacement

- Unscrew the 4 screws fastening the front rack panel.
- Remove the adjustment knob.
- Extract wiring connectors from digital interface PCB.
- Unscrew small supporting columns.
- Remove digital interface PCB by lifting it out of its supports.
- Proceed vice versa to assemble new digital interface PCB.

Meaning of graphic symbols on machine

	Power supply switch
	System for use in environments with increased risk of electroshock
	Product suitable for free circulation in the European Community
	Danger! High voltage
	Grounding
	Positive pole snap-in connector
	Negative pole snap-in connector

	Connector for the remote control
	Warning!
	Fast coupling TIG torch gas tube
	Before using the equipment you should carefully read the instructions included in this manual
	MMA welding
	TIG welding
	Special disposal

Adjustment of electronic circuit board

PT1 Adjustment of the maximum current
 PT2 Adjustment of the minimum current

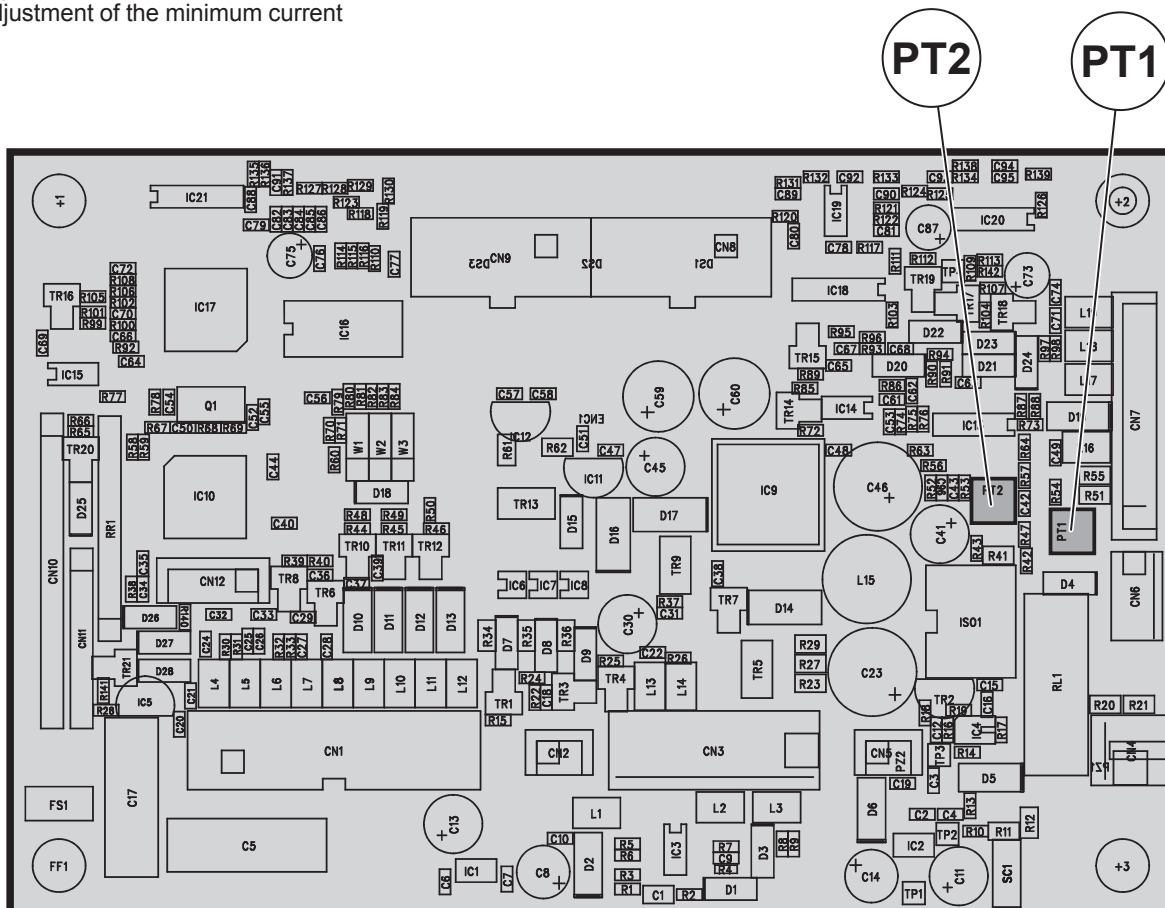

Wiring diagram (MATRIX 2200 AC/DC)

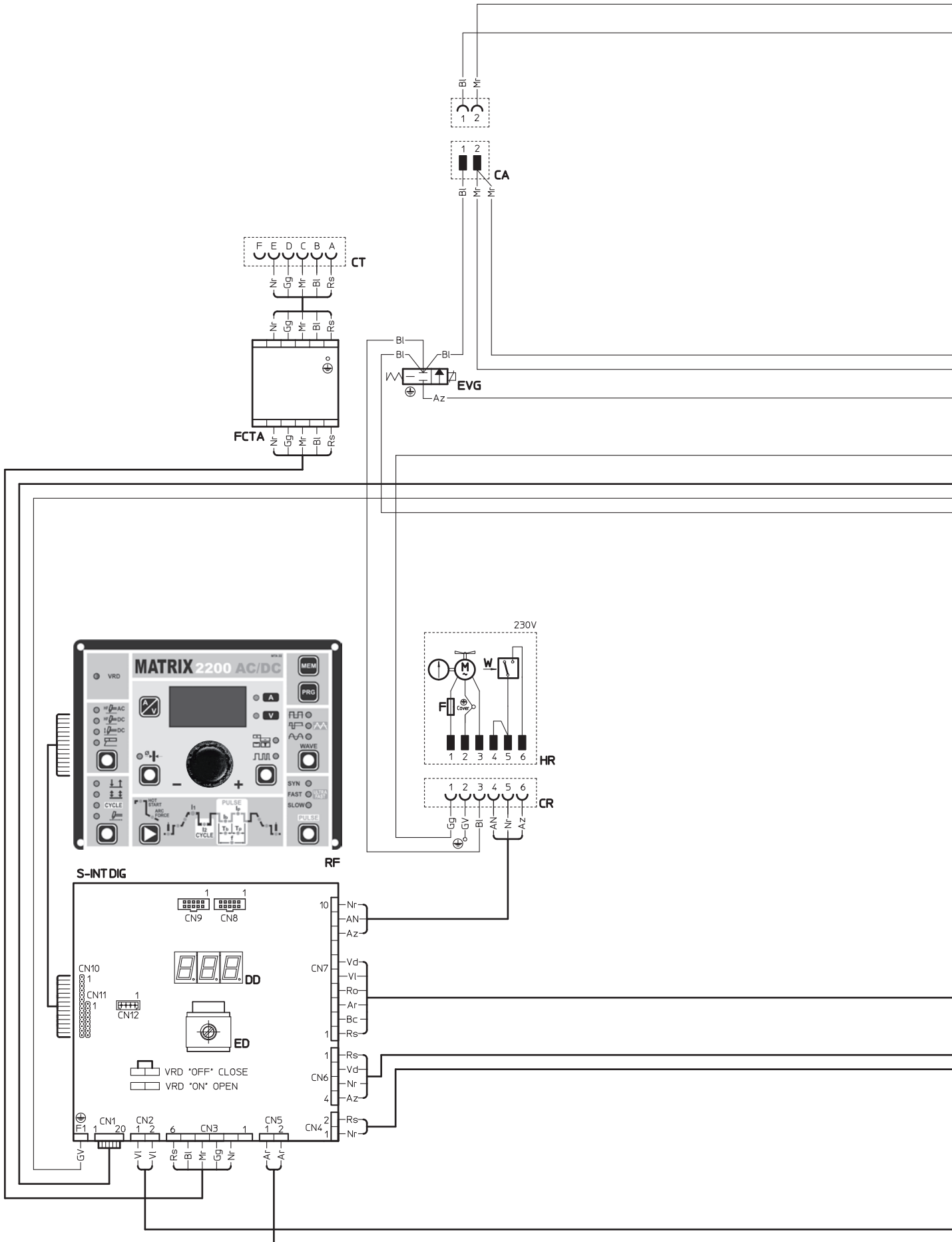

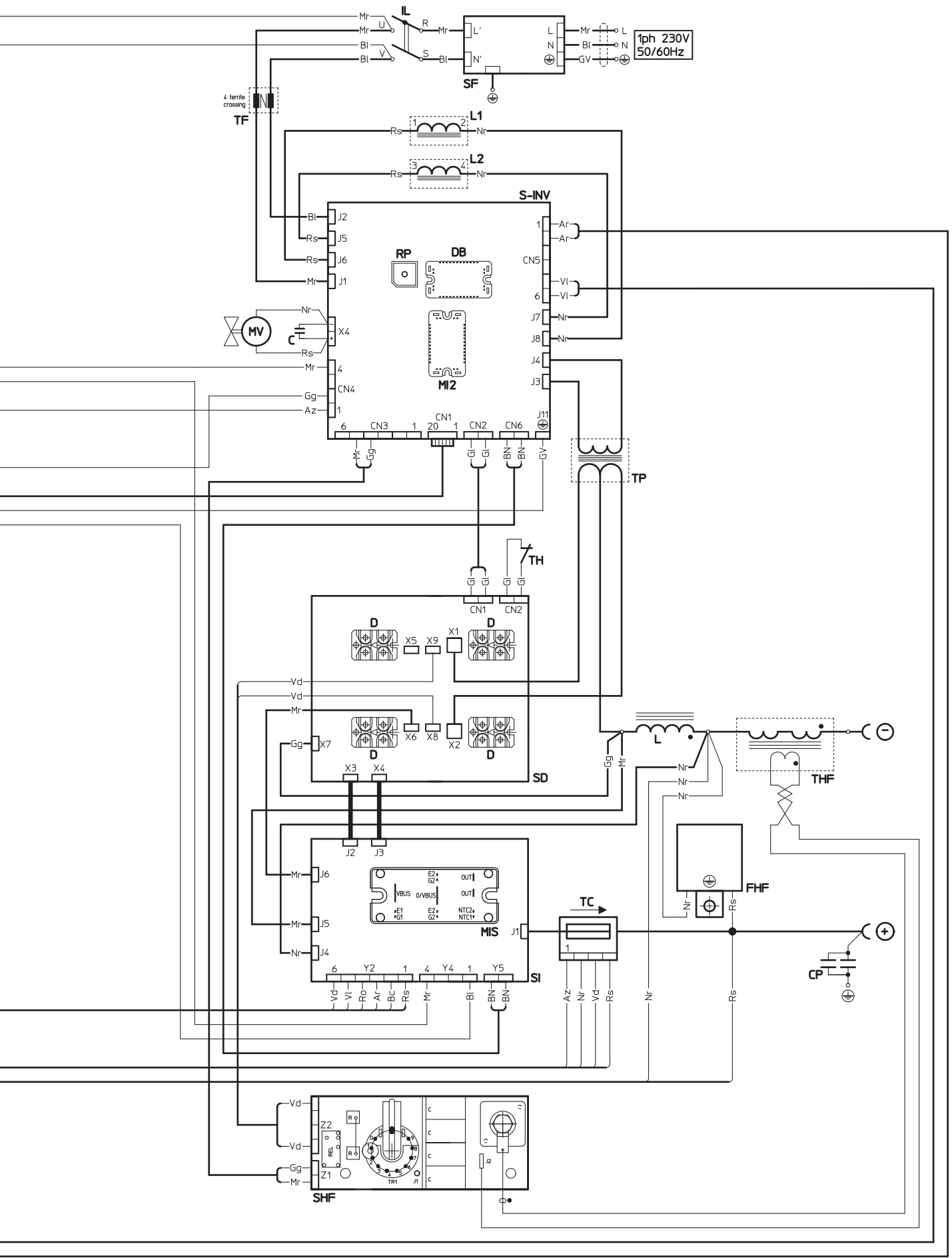

Wiring diagram (MATRIX 3000 AC/DC - AC/DC R)

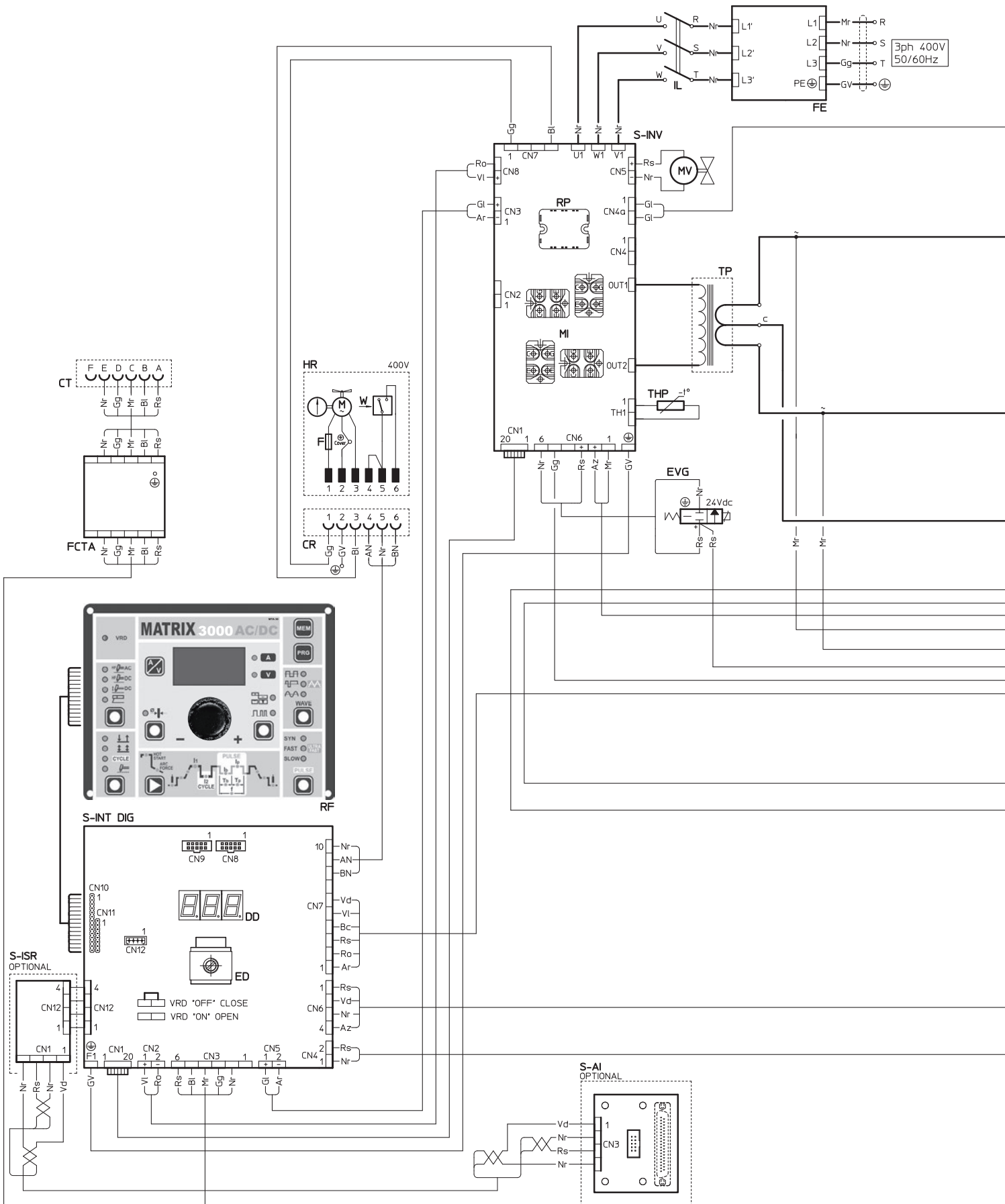

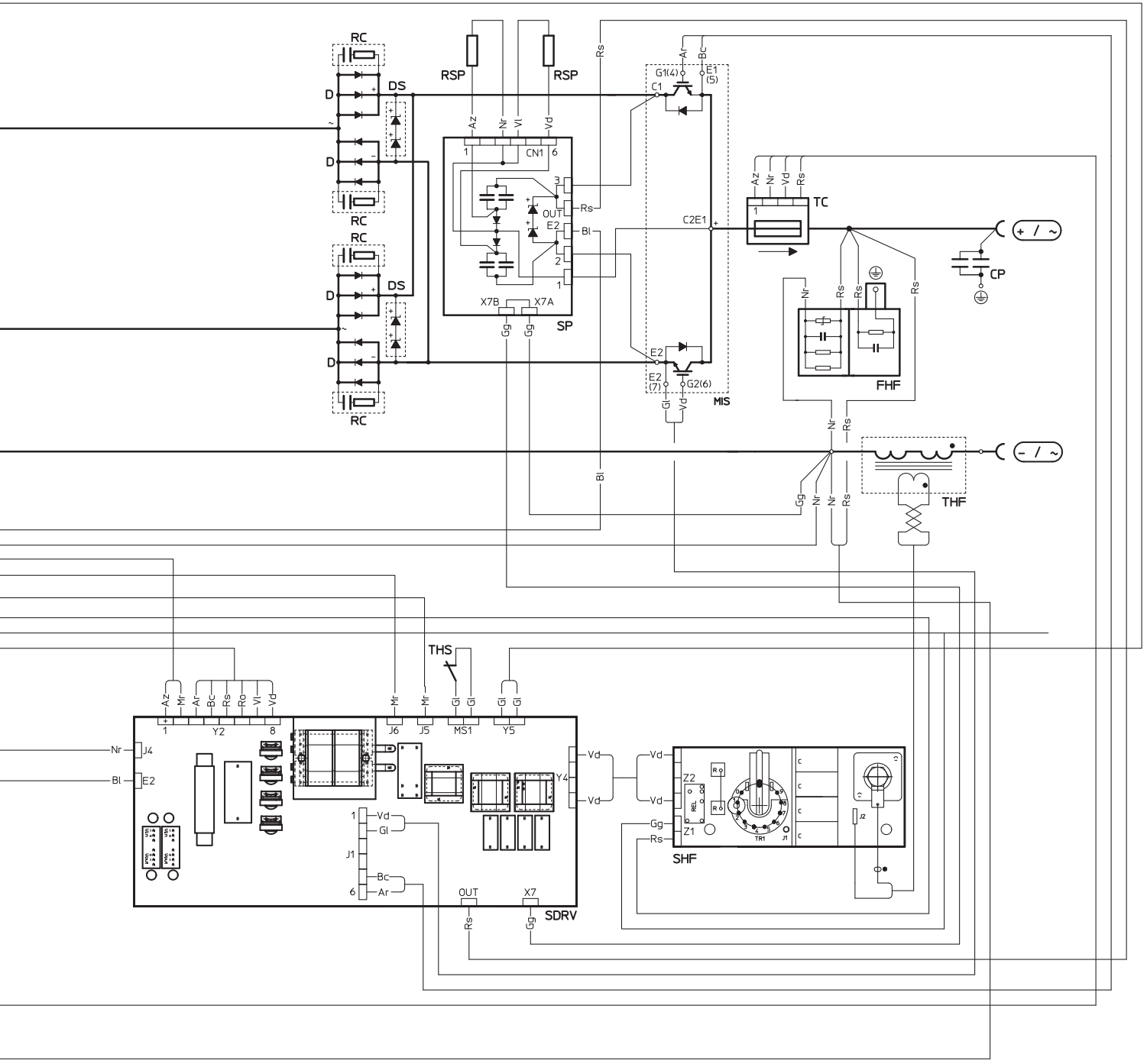

•1 C	•2 CA	•3 CP	•4 CR	•5 CT	•6 D	•7 DB	•8 DD	•9 DS	•10 ED
•11 EVG	•12 F	•13 FCTA	•14 FE	•15 FHF	•16 HR	•17 IL	•18 L	•19 L1-2	•20 M
•21 MI	•22 MI2	•23 MIS	•24 MV	•25 RC	•26 RF	•27 RP	•28 RSP	•29 S-AI	•30 S-INT DIG
•31 S-INV	•32 S-ISR	•33 SD	•34 SDRV	•35 SF	•36 SHF	•37 SI	•38 SP	•39 TC	•40 TF
•41 TH	•42 THF	•43 THP	•44 THS	•45 TP	•46 W				

Key to the electrical diagram

•1 Capacitor •2 Power supply connector 230V 50/60Hz •3 EMC capacitors
 •4 Power supply connector for the cooling system •5 TIG torch connector
 •6 Secondary diode •7 "Dual Boost Chopper" IGBT •8 Digital display •9
 Secondary diode discharger •10 Encoder •11 Gas solenoid valve •12 Fuse
 •13 Torch filter complete with connector •14 EMC filter •15 HF filter •16 Water
 cooling system •17 Power supply switch •18 Inductor •19 PFC inductances
 •20 Electric pump •21 Primary IGBT circuit •22 "Full Bridge" IGBT
 •23 Secondary IGBT circuit •24 Fan motor •25 Secondary R-C diode •26
 Membrane keyboard •27 Primary rectifier •28 Secondary IGBT protection
 board resistance •29 Interface for automation (optional extra) •30 Digital
 interface PCB •31 Inverter PCB •32 Automation interface isolation board
 (optional extra) •33 Secondary circuit diodes PCB •34 Secondary circuit
 PCB •35 EMC filter PCB •36 High frequency (HF) PCB •37 Secondary circuit
 IGBT board •38 Secondary IGBT protection board •39 Current transducer
 •40 Toroidal ferrite •41 Secondary circuit diode thermostat •42 HF
 transformer •43 Primary circuit thermistor •44 Secondary circuit thermostat
 •45 Transformer •46 Pressure switch

Colour key

AN Orange-Black
Ar Orange
Az Sky blue
Bc White
Bl Blue
BN White-Black
Gg Grey
Gl Yellow
GV Yellow-Green
Mr Brown
Nr Black
Ro Pink
Rs Red
Vd Green
VI Violet

MATRIX AC/DC • AC/DC R

2200 • 3000

IT

Lista ricambi

LEGGERE ATTENTAMENTE

EN

Spare parts list

READ CAREFULLY



**WELDING
TOGETHER**

CEA COSTRUZIONI ELETTROMECCANICHE ANNETTONI S.p.A.

C.so E. Filiberto, 27 - 23900 Lecco - Italy
Tel. ++39.0341.22322 - Fax ++39.0341.422646
Cas. Post. (P.O.BOX) 205
E-mail: cea@ceaweld.com - web: www.ceaweld.com

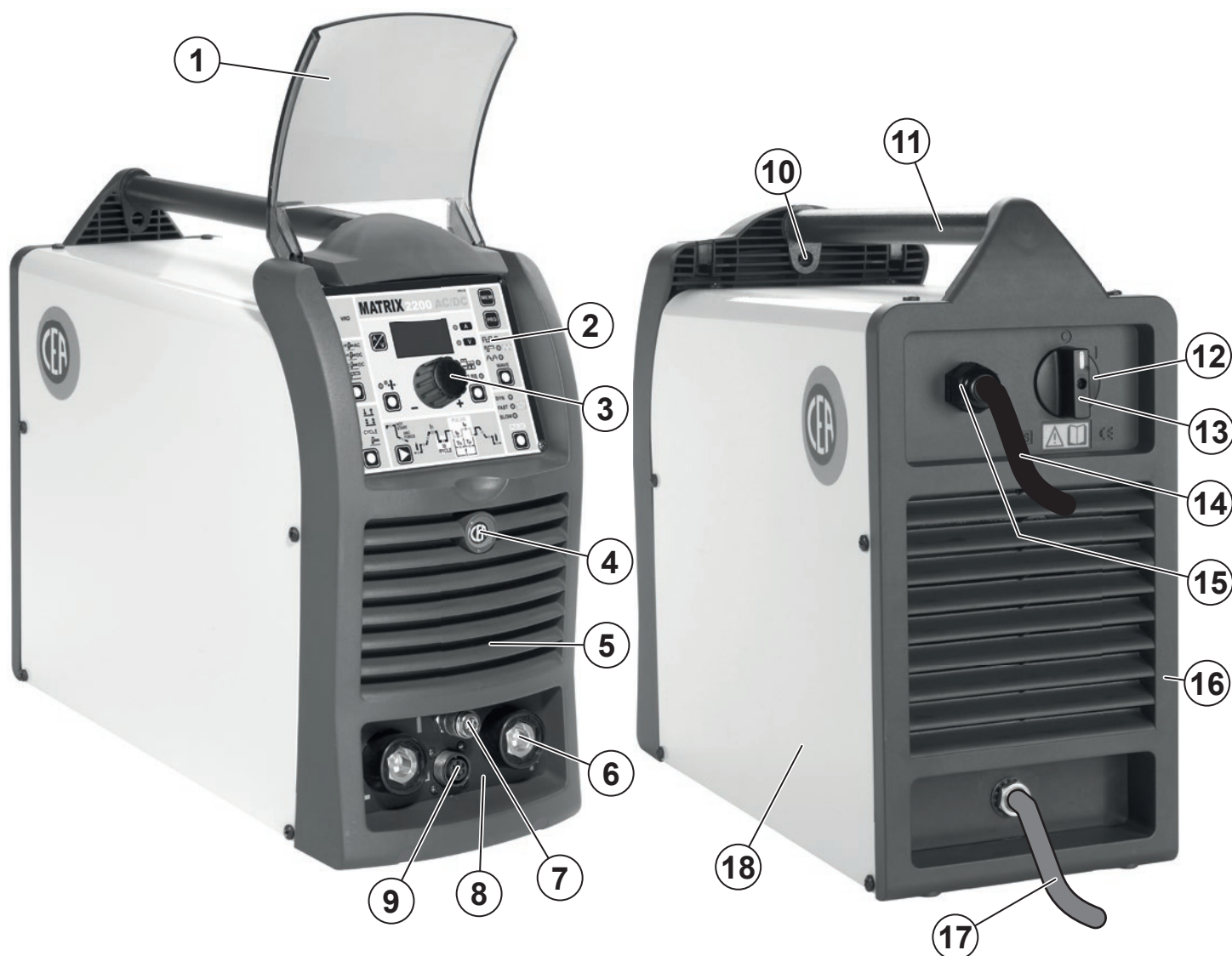

Pos.	MATRIX 2200 AC/DC	Descrizione	Description
1	352453	Visiera rack frontale	Front rack transparent visor
2	447846	Tastiera a membrana MATRIX 2200 AC/DC	MATRIX 2200 AC/DC Membrane keyboard
3	438888	Manopola senza indice Ø29mm	Ø29mm Knob without index
4	468191	Adesivo logo CEA Ø20mm	CEA logo sticker Ø20mm
5	352452	Pannello frontale senza adesivo logo CEA Ø20mm	Front panel without CEA logo sticker Ø20mm
6	403611	Attacco rapido	Quick connection
7	403635	Attacco rapido gas	Gas quick connection
8	468282	Adesivo dinse	Dinse sticker
9	419050	Connettore comando a distanza	Remote control socket
10	462694	Gancio attacco tracolla	Carrying belt hook
11	438108	Maniglia	Handle
12	438710	Manopola interruttore alimentazione	Mains switch knob
13	435375	Interruttore alimentazione	Mains switch
14	235942	Cavo alimentazione	Mains cable
15	427895	Pressacavo completo di ghiera	Cable clamp with lock ring
16	352404	Pannello posteriore	Rear panel
17	485040	Tubo gas	Gas tube
18	420493	Coperchio con adesivi logo CEA	Cover with CEA logo stickers

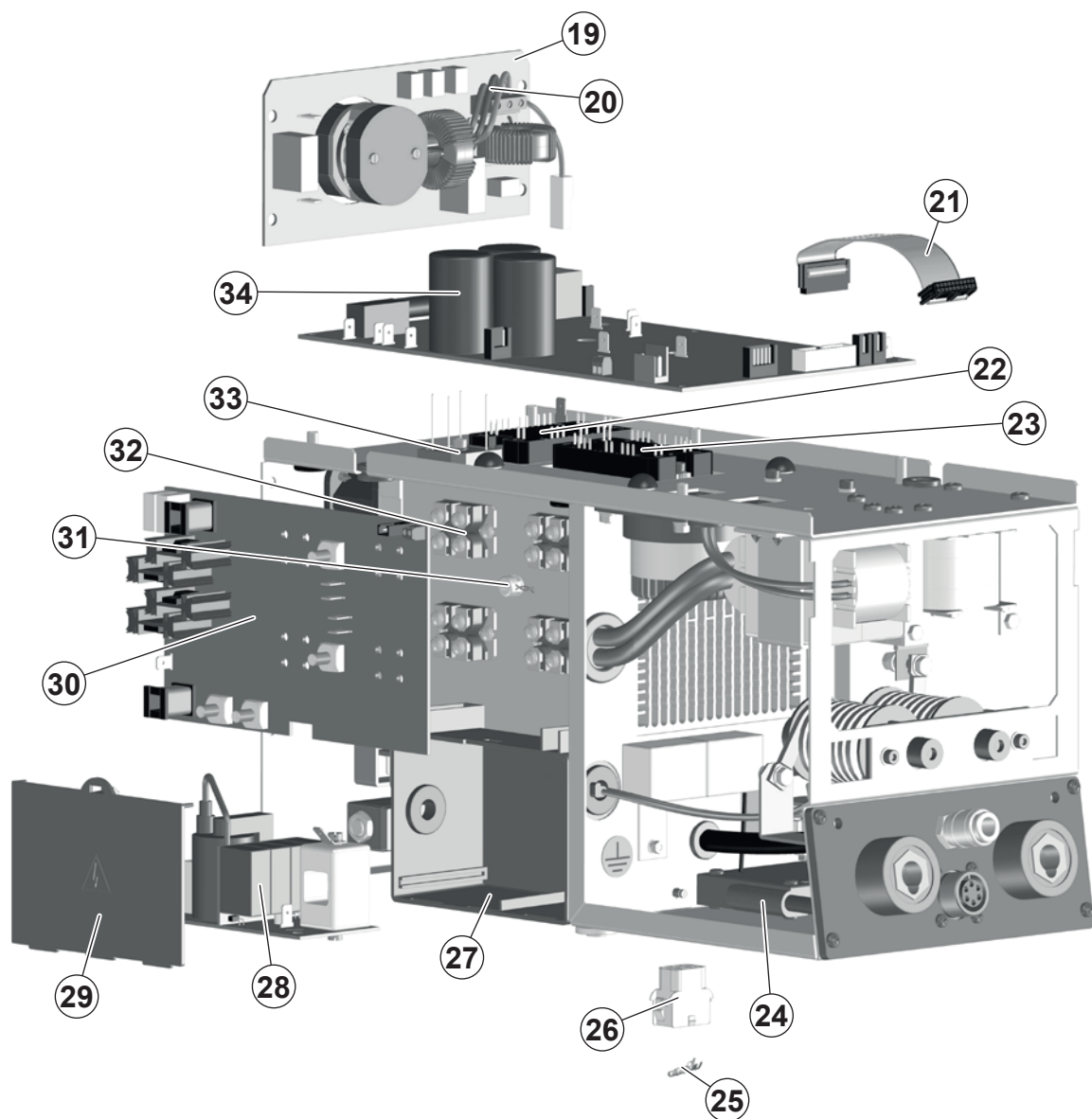

Pos.	MATRIX 2200 AC/DC	Descrizione	Description
19	377094	Scheda filtro EMC	EMC filter PCB
20	413538	Cablaggio scheda filtro EMC	EMC filter PCB wiring
21	413536	Cablaggio ausiliario	Auxiliary wiring
22	286036	IGBT "Dual Boost Chopper"	"Dual Boost Chopper" IGBT
23	286038	IGBT "Full Bridge"	"Full Bridge" IGBT
24	376930	Filtro torcia completo di connettore	Torch filter with connector
25	403782	Terminale per connettore femmina 3x2 vie	Terminal for 3x2 poles female connector
26	419074	Connettore femmina 3x2 vie	3x2 Poles female connector
27	352466	Scatola scheda HF	HF PCB box
28	377059	Scheda alta frequenza (HF)	High frequency (HF) PCB
29	352468	Coperchio scatola scheda HF	HF PCB cover
30	377097	Scheda diodi circuito secondario	Secondary circuit diode PCB
31	478786	Termostato diodi circuito secondario	Secondary circuit diode thermostat
32	423236	Diodo secondario	Secondary diode
33	455509	Raddrizzatore primario	Primary rectifier
34	240473	Complessivo scheda inverter primario	Primary inverter PCB assembly

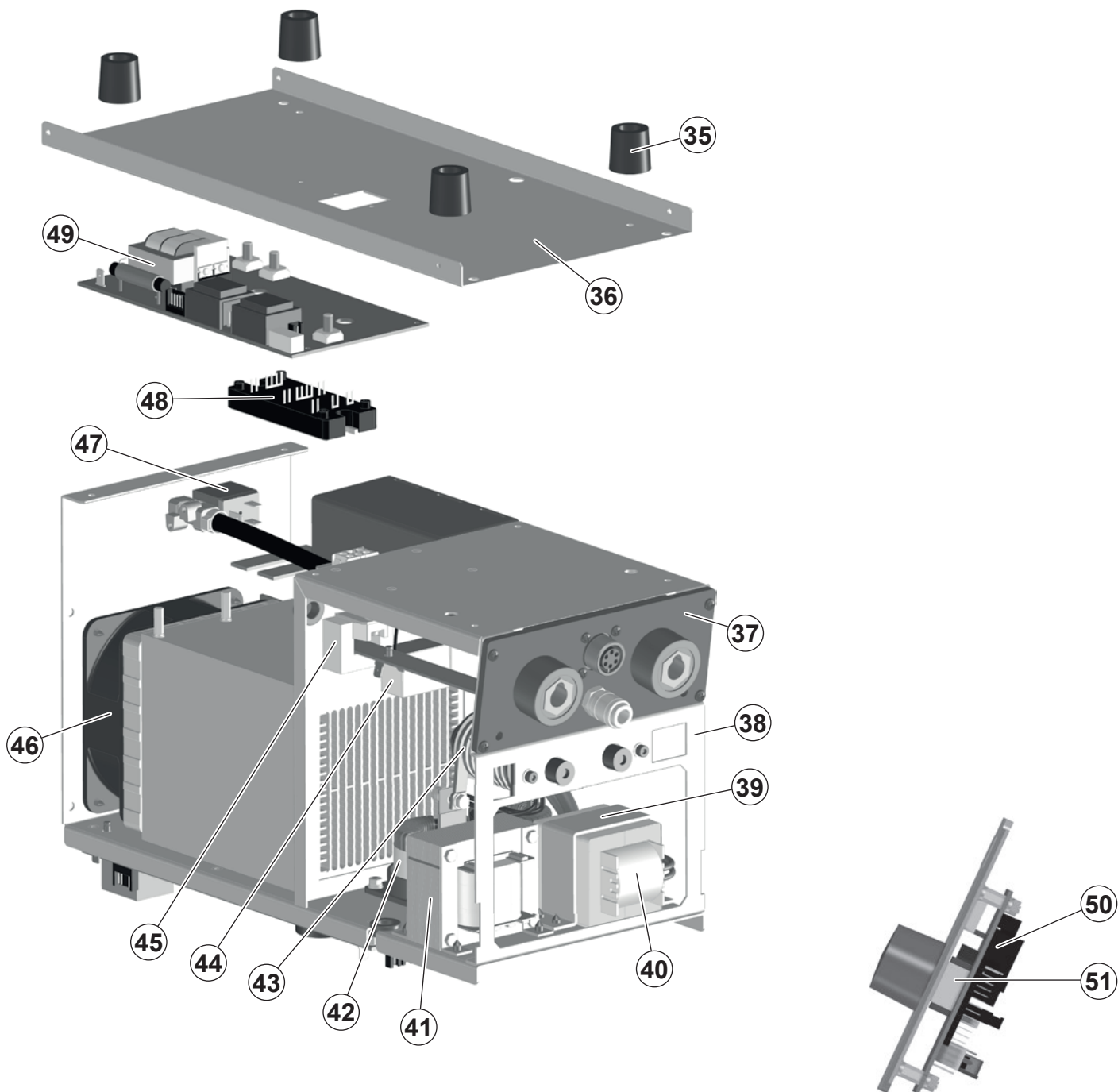

Pos.	MATRIX 2200 AC/DC	Descrizione	Description
35	431331	Piedino d'appoggio	Foot
36	404933	Basamento	Base
37	352944	Isolamento dinse	Dinse Insulation
38	449495	Telaio metallico interno	Internal metallic frame
39	463217	Staffa fissaggio trasformatore	Transformer support
40	481402	Trasformatore	Transformer
41	240234	Induttore	Inductor
42	240232	Induttanze PFC	PFC inductors
43	239995	Trasformatore HF	HF transformer
44	427681	Filtro HF	HF filter
45	481946	Trasduttore di corrente	Current transducer
46	486383	Motore ventilatore	Fan motor
47	425933	Elettrovalvola gas	Gas solenoid valve
48	286041	IGBT secondario	Secondary IGBT
49	240510	Complessivo IGBT secondario	Secondary IGBT assembly
50	377095	Scheda interfaccia digitale	Digital Interface PCB
51	454150	Encoder	Encoder

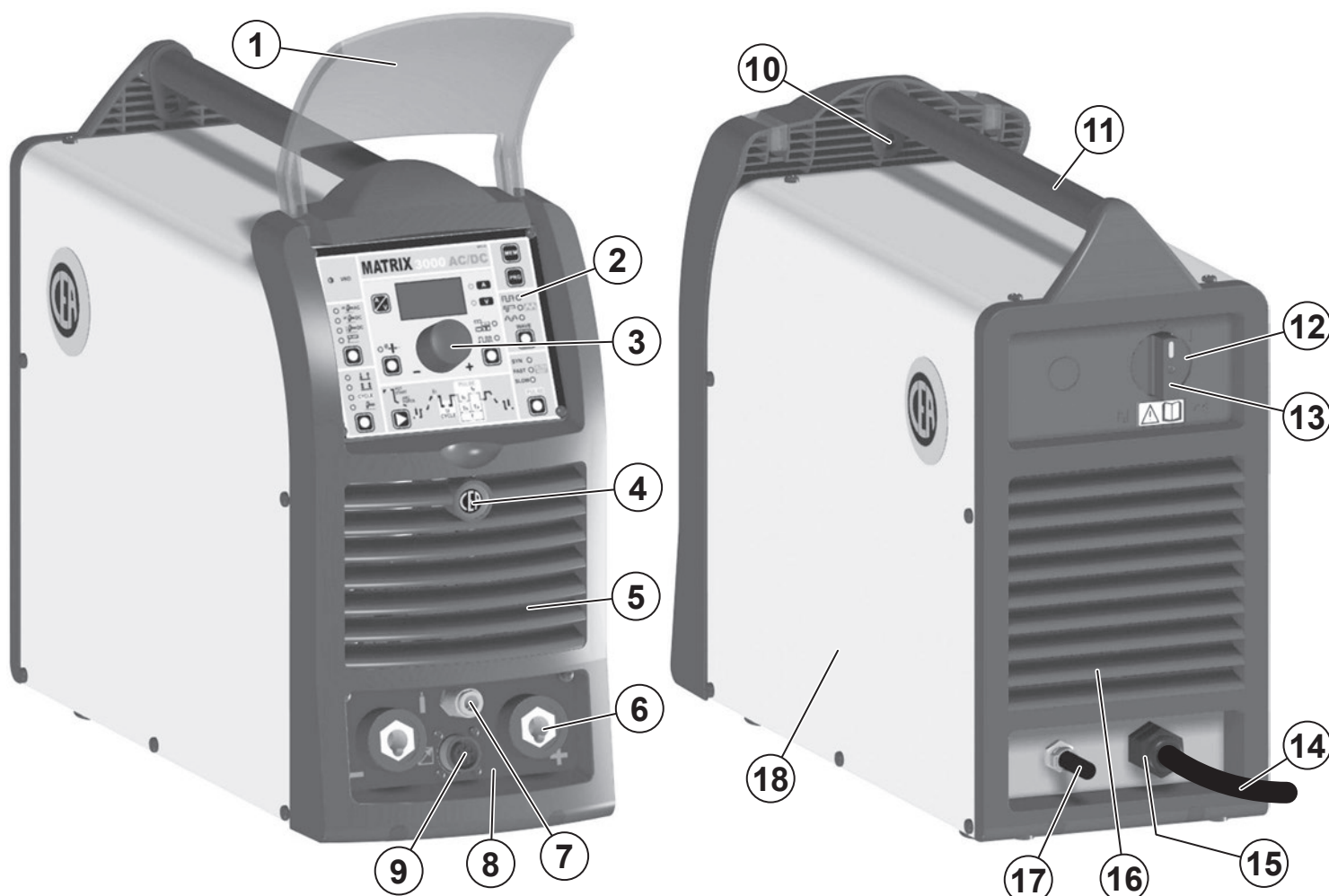

Pos.	MATRIX 3000 AC/DC - AC/DC R	Descrizione	Description
1	352453	Visiera rack frontale	Front rack transparent visor
2	447859	Tastiera a membrana MATRIX 3000 AC/DC	Membrane Keyboard MATRIX 3000 AC/DC
3	438888	Manopola senza indice Ø29mm	Ø29mm Knob without index
4	468191	Adesivo logo CEA Ø20mm	CEA logo sticker Ø20mm
5	352452	Pannello frontale senza adesivo logo CEA Ø20mm	Front panel without CEA logo sticker Ø20mm
6	403611	Attacco rapido	Quick connection
7	403635	Attacco rapido gas	Gas quick connection
8	468282	Adesivo frontale	Front sticker
9	419050	Connettore comando a distanza	Remote control socket
10	462694	Gancio attacco tracolla	Carrying belt hook
11	438104	Maniglia	Handle
12	438710	Manopola interruttore alimentazione	Mains switch knob
13	435755	Interruttore alimentazione	Mains switch
14	235994	Cavo alimentazione	Mains cable
15	427895	Pressacavo completo di ghiera	Cable clamp with lock ring
16	352404	Pannello posteriore	Rear panel
17	485040	Tubo gas	Gas tube
18	420487	Coperchio con adesivi logo CEA	Cover with CEA logo stickers

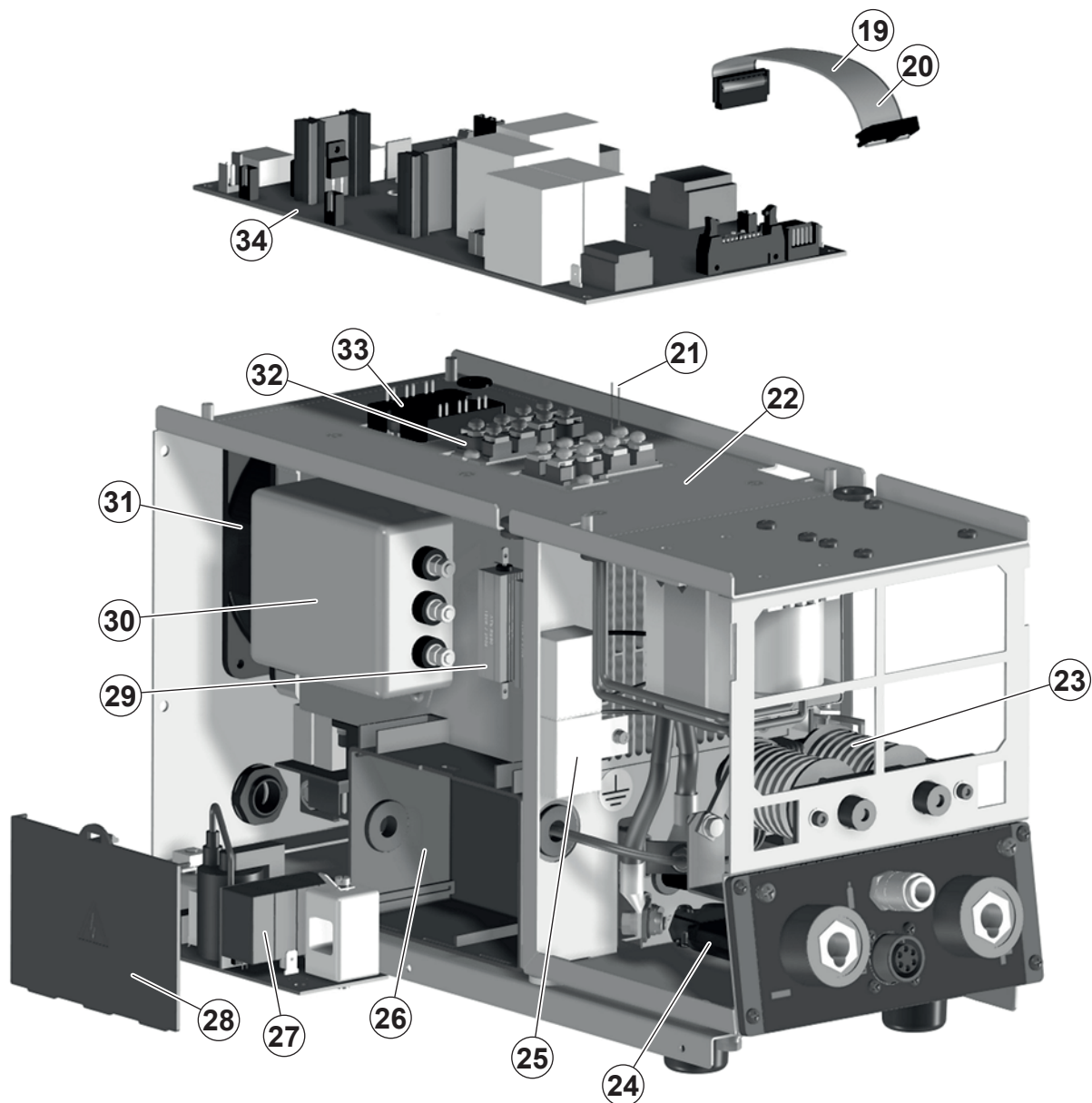

Pos.	MATRIX 3000 AC/DC - AC/DC R	Descrizione	Description
19	413466	Cablaggio ausiliario	Auxiliary wiring
20	413518	Cablaggio RoboMat 1 - Matrix 3000 AC / DC R (solo per MATRIX 3000 AC/DC R)	RoboMat 1 - Matrix 3000 AC / DC R Wiring (only for MATRIX 3000 AC/DC R)
21	478867	Termistore circuito primario	Primary circuit thermistor
22	353052	Isolamento scheda inverter	Inverter PCB insulation
23	239989	Trasformatore HF	HF transformer
24	376930	Filtro torcia completo di connettore	Torch filter with connector
25	427681	Filtro HF	HF filter
26	352466	Scatola scheda HF	HF PCB box
27	377059	Scheda alta frequenza (HF)	High frequency (HF) PCB
28	352468	Coperchio scatola scheda HF	HF PCB cover
29	457122	Resistore scheda protezione IGBT secondario	Secondary IGBT protection PCB resistor
30	376887	Filtro EMC	EMC Filter
31	486383	Motore ventilatore	Fan motor
32	286046	IGBT circuito primario	Primary circuit IGBT
33	455508	Raddrizzatore primario	Primary rectifier
34	240459	Complesso scheda inverter primario	Primary inverter PCB assembly

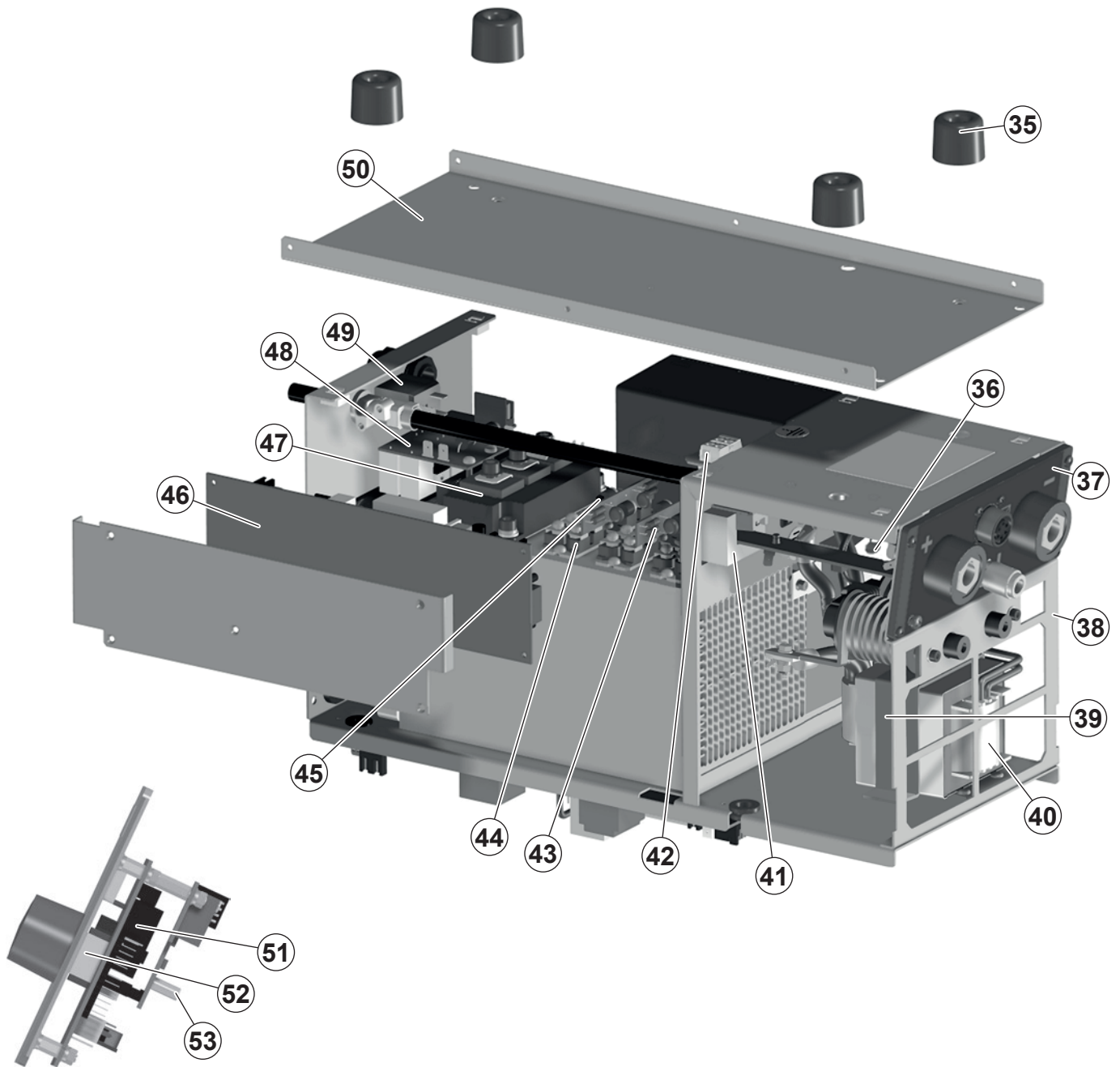

Pos.	MATRIX 3000 AC/DC - AC/DC R	Descrizione	Description
35	431329	Piedino d'appoggio	Foot
36	418858	Assieme condensatori	Capacitors assembly
37	352944	Isolamento dinse	Dinse Insulation
38	449485	Telaio metallico interno	Internal metallic frame
39	463218	Staffa fissaggio trasformatore	Transformer support
40	481436	Trasformatore	Transformer
41	481946	Trasduttore di corrente	Current transducer
42	419074	Connettore femmina 3x2 vie	3x2 Poles female connector
43	377144	Scheda snubber / diodi circuito secondario	Secondary circuit diode / snubber PCB
44	423236	Diodo secondario	Secondary diode
45	478846	Termostato circuito secondario	Secondary circuit thermostat
46	377143	Scheda circuito secondario	Secondary circuit PCB
47	286047	IGBT secondario	Secondary IGBT
48	377154	Scheda protezione IGBT secondario	Secondary IGBT protection PCB
49	425938	Elettrovalvola gas	Gas solenoide valve
50	404912	Basamento	Base
51	377152A	Scheda interfaccia digitale	Digital Interface PCB
52	454150	Encoder	Encoder
53	377170	Scheda isolamento interfaccia per automazione (solo per MATRIX 3000 AC/DC R)	Robotic interface isolation PCB (only for MATRIX 3000 AC/DC R)

IT Ordinazione dei pezzi di ricambio

Per la richiesta di pezzi di ricambio indicare chiaramente:

- 1) Il numero di codice del particolare
- 2) Il tipo di impianto
- 3) La tensione e la frequenza che rileverete dalla targhetta dei dati posta sull'impianto
- 4) Il numero di matricola

ESEMPIO

N° 2 pezzi, codice n. 352453 - per l'impianto MATRIX 3000 AC/DC - 400 V - 50/60 Hz - Matricola n°

EN Ordering spare parts

To ask for spare parts clearly state:

- 1) The code number of the piece
- 2) The type of device
- 3) The voltage and frequency read on the rating plate
- 4) The serial number of the same

EXAMPLE

N. 2 pieces code n. 352453 - for MATRIX 3000 AC/DC - 400 V - 50/60 Hz - Serial number



MTA 22 - 30



**WELDING
TOGETHER**

CEA COSTRUZIONI ELETTROMECCANICHE ANNETTONI S.p.A.

C.so E. Filiberto, 27 - 23900 Lecco - Italy
Tel. ++39.0341.22322 - Fax ++39.0341.422646
Cas. Post. (P.O.BOX) 205
E-mail: cea@ceaweld.com - web: www.ceaweld.com

Control panel	2	Editing the maximum and minimum limits for welding parameters	14
Introduction	2	Creating and memorising automatic welding points	15
Displaying the software version installed	5	PROGRAMMED and/or MANUAL welding	15
Electrode welding (MMA)	5	Calling up saved programs	15
TIG "AC" welding	5	Viewing the parameters set	16
TIG "DC" welding	8	Activating the VRD device	16
TIG "AC and LIFT DC" welding with the SPOT WELDING function on	8	Auxiliary functions	16
TIG HF DC welding with TACK function active and single ColdTack point	9	Factory default	16
TIG HF DC welding with TACK function active and Multi-ColdTack function	9	Error and protection conditions	16
TIG "AC and DC" welding - Welding parameters	10		
STANDARD CONFIGURATION (Std)	10		
1 - "BASIC" WELDING PARAMETERS	10		
2 - WELDING PARAMETERS with PULSE mode active	10		
3 - WELDING PARAMETERS with PULSE mode and CYCLE welding mode active (CYCLE LED on)	12		
SPECIAL CONFIGURATION (SPE)	13		

Introduction

This manual describes the functions on and how to use the following control panels:

- MTA 22
- MTA 30

Control panel

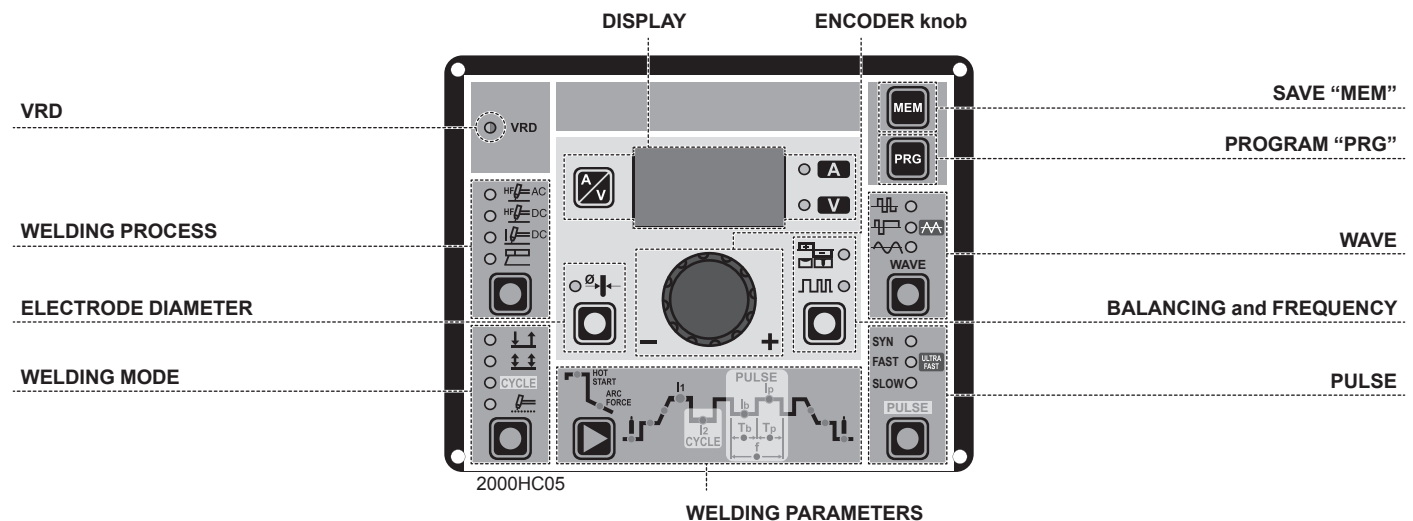

VRD

The Voltage Reduction Device (VRD) is a safety device that reduces the voltage. It prevents voltages forming on the output terminals that may pose a danger to people.

Two-tone LED (off - red - green) indicates enabling of the VRD device.

The standard, preset settings for the firm do not activate the VRD function on the welding machine and so this LED is normally off. To activate the VRD device, see the relevant paragraph.

WELDING PROCESS

The MATRIX welding machine offers 4 TIG/Electrode welding processes. Each time the button is pushed, the welding machine switches to select the welding process indicated by the LED that stays lit, in the following order:

- L1** TIG AC with HF ignition
- L2** TIG DC with HF ignition
- L3** TIG DC with "Lift" type ignition
- L4** ELECTRODE (MMA)

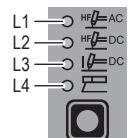

■ ELECTRODE DIAMETER

For TIG welding with HF ignition, it allows you to use the relevant key to set the diameter of the tungsten electrode used, and/or to change it using the ENCODER knob, in order to achieve the best control of the AC arc in a synergic manner.



WARNING: The electrode diameter CANNOT be selected when the welding machine is set for the SPECIAL configuration.

■ WELDING MODE

The MATRIX welding machine offers 4 welding modes. Each time the button is pushed, the welding machine switches to select the welding mode indicated by the LED that stays lit, in the following order:

L5 2 STROKES

L6 4 STROKES

L7 CYCLE

L8 SPOT WELDING

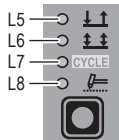

L5 2 STROKES

When the torch button is pushed welding begins starting with the INITIAL CURRENT (if SLOPE UP is selected), while when it is released welding ends when the FINAL CURRENT is reached (if SLOPE DOWN is set).

L6 4 STROKES

TIG welding takes place as follows:

- When the torch button is pushed welding begins at the INITIAL current.
- When the torch button is released the SLOPE UP process is carried out (if applicable) and the current returns to the PRINCIPAL value **I1**.
- When the torch button is pushed the SLOPE DOWN process is carried out (if applicable) and the current returns to the FINAL value.
- When the button is released the welding cycle ends.

L7 CYCLE

When this function has been activated, TIG welding takes place as follows:

- When the torch button is pushed welding begins at the INITIAL current.
- When the torch button is released the SLOPE UP process is carried out (if applicable) and the current returns to the PRINCIPAL value **I1**.
- When the torch button is pressed and released within less than 1 second the welding current goes to the CYCLE value (**I2**), and by repeating this operating you can move between the two current levels (**I1**), (**I2**) an infinite number of times.
- When the torch button is pushed and held down (for longer than 1 second) you exit the cycle, the SLOPE DOWN process is carried out (if applicable) and the current returns to the FINAL value. When the torch button is released the welding cycle ends.

This welding mode is especially indicated for welding profiles with different thickness, where continuous current variation is required. Also, when welding aluminium, it allows you to have a higher initial current, thereby facilitating pre-heating of the workpiece.

L8 SPOT WELDING

This can be used by pushing the torch button to spot weld for a pre-set period of time (in seconds) at the end of which the arc switches off automatically. The tack welding function is divided into 3 types:

- TIG AC and TIG LIFT DC tack welding.
- TIG HF DC tack welding with a single coldTack point.
- TIG HF DC tack welding with a Multi-ColdTack function.

See the relevant paragraphs in the subsequent pages of this manual.

■ DISPLAY

Displays the selections made using the various Keys (with corresponding LED on or flashing) and regulated using the ENCODER knob.

The button can also be used to view:

L32 AMPERE (CURRENT)

- When the machine is in stand-by, the Amps (A) set.
- When the machine is welding the real Amps (A) at which the operator is actually welding.



WARNING: LED **L32** switched on and steady.

L33 VOLT (VOLTAGE)

- The actual VOLTS (V) at the welding clamps (the value displayed CANNOT BE CHANGED OR REGULATED).

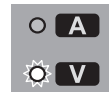

WARNING: LED **L33** switched on and steady.

■ ENCODER knob

This is used to regulate and change the welding parameters, according to which LED is switched on and the value shown on the DISPLAY, which is necessary for the machine to work correctly.



■ SAVE "MEM"

Used to save the parameters for the welding programs.



■ PROGRAM "PRG"

Used to call up welding programs.



■ WAVE

During TIG AC welding with HF ignition, it makes it possible to control the following wave shapes:

L24 DYNAMIC TIG

L25 SPEED TIG

L25 COLD TIG

L26 SOFT TIG

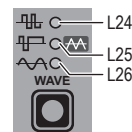

L24 DYNAMIC TIG

Square wave: highly dynamic arc for all applications.

WARNING: LED **L24** switched on and steady.

L25 SPEED TIG

Mixed wave: excellent penetration with high welding speed and low electrode consumption.

WARNING: LED **L25** switched on and steady.

L25 COLD TIG

Triangular wave: low heat generation with reduced distortion, ideal for minor thicknesses.

WARNING: LED **L25** switched on and flashing.

L26 SOFT TIG

Sinusoidal wave: gentle, soft arc with low noise, ideal for average thicknesses.

WARNING: LED **L26** switched on and steady.

■ BALANCING and FREQUENCY

During TIG AC welding with HF ignition, it makes it possible to set one of the following parameters, using the relevant key:

L30 BALANCING of the TIME and AMPLITUDE of the AC welding current (BALANCE PLUS)

L31 FREQUENCY of the AC welding current

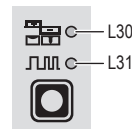

L30 BALANCING of the TIME and AMPLITUDE of the AC welding current (BALANCE PLUS)

It is possible to adjust both the time (t) and the amplitude of the current (I) independently or simultaneously, using positive or negative values for the time the electrode stays in place. These settings ensure perfect control of penetration and cleanliness, with a drastic reduction in side incisions.

L31 FREQUENCY of the AC welding current

The high frequency makes it possible to weld minor thicknesses with excellent results, while the low frequency is ideal for welding average thicknesses, or where edge preparation is poor.

WARNING: LED **L31** switched on and flashing.

■ PULSE

When using one of the 3 TIG welding processes, it makes it possible to set one of the 4 pulsation modes available on the welding machine, using the relevant button:

L27 SYN PULSE

L28 FAST PULSE

L28 ULTRA FAST PULSE

L29 SLOW PULSE

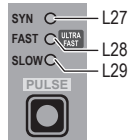

L27 Synergic pulsations (SYN PULSE)

WARNING:

LED **L27** switched on and steady.

This can only be programmed when the TIG DC with HF ignition or TIG DC with "Lift" type ignition welding processes are used.

L28 Fast pulsations (FAST PULSE)

WARNING:

LED **L28** switched on and steady.

This can only be programmed when the TIG DC with HF ignition or TIG DC with "Lift" type ignition welding processes are used.

L28 Ultra fast pulsations (ULTRA FAST PULSE)

WARNING:

LED **L28** switched on and flashing.

Attivabile solo con i processi di saldatura TIG DC con innesco HF o TIG DC con innesco tipo "Lift".

L29 Slow pulsations (SLOW PULSE)

WARNING:

LED **L29** switched on and steady.

This can only be programmed when the 3 TIG welding processes are used.

WARNING: The operator can decide to TIG weld without using any pulsation mode. If this is the case, the 4 LEDs are switched off.

■ WELDING PARAMETERS

Each time the button is pushed, the welding machine selects the next function according to the machine configuration, the welding process, the welding mode, etc...

1A - STANDARD CONFIGURATION Electrode welding (MMA)

When using the electrode welding process, this allows you to select the following welding parameters, based on which LED is flashing:

L9 HOT START

L10 ARC FORCE

L11 PRINCIPAL welding CURRENT I_1

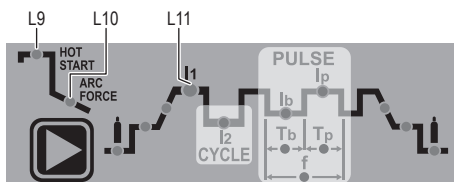

1B - STANDARD CONFIGURATION TIG welding

When one of the 3 TIG welding processes available on the welding machine is activated, this allows you to select the following welding parameters, based on which LED is flashing:

L12 PRE-GAS duration

L13 SLOPE UP duration

L14 BASE current duration T_b

WARNING: This can only be programmed when SLOW pulsation is activated.

L15 PEAK current duration T_p

WARNING: This can only be programmed when SLOW pulsation is activated.

L16 SLOPE DOWN duration

L17 POST-GAS duration

L18 INITIAL welding CURRENT

L11 PRINCIPAL welding CURRENT I_1

L19 CYCLE CURRENT I_2

WARNING: This can only be programmed when the CYCLE welding mode is active.

L20 BASE CURRENT I_b

WARNING: This can only be programmed when at least one pulsation mode is activated.

L21 PEAK CURRENT I_p

WARNING: This can only be programmed when at least one pulsation mode is activated.

L22 FINAL welding CURRENT

L23 PULSATION FREQUENCY f

WARNING: NOT programmable when SLOW pulsation mode is active.

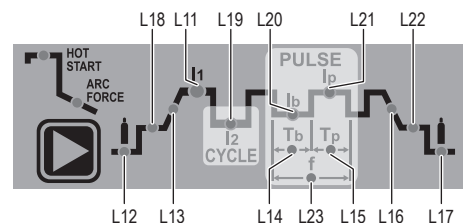

2 - SPECIAL CONFIGURATION (only for expert welders) TIG welding

For this configuration, in addition to the parameters already defined for the STANDARD configuration, you can also set the following parameters:

L9 IGNITION CURRENT

WARNING: This can only be programmed when the TIG AC with HF ignition or TIG DC with HF ignition welding processes are used.

L9 IGNITION TIME duration

WARNING: Only programmable when the TIG AC with HF ignition welding process is activated.

L18 INITIAL welding CURRENT

WARNING: This can only be programmed when the TIG AC with HF ignition or TIG DC with HF ignition welding processes and the 2 STROKES welding mode are used.

L22 FINAL welding CURRENT

WARNING: This can only be programmed when the TIG AC with HF ignition or TIG DC with HF ignition welding processes and the 2 STROKES welding mode are used.

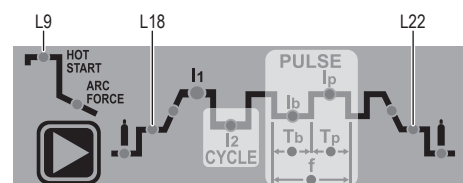

WARNING: This special parameter is only to be activated by qualified personnel, or those trained by technicians.

Displaying the software version installed

The **MATRIX AC/DC** are fitted with a digital control with software on board defined in the factory. This software is subject to continuous evolution and improvement. The software is identified by a specific number that can be viewed on the DISPLAY (D) as follows:

- 1) When the welding machine is off, push and hold the “MEM” **SAVE** key down (T1).
- 2) Start the welding machine by turning the power supply switch to position I.
- 3) For a few seconds the DISPLAY (D) shows the type of software on board (e.g. b01) where:
 - **b** indicates the welding machine model.
 - **01** indicates the VERSION of the software installed

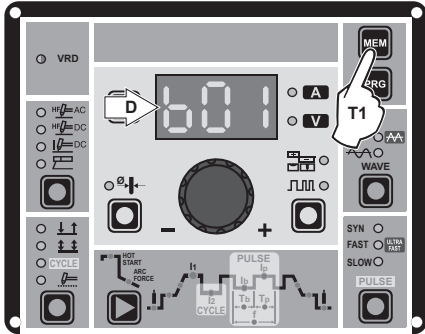

- **PRINCIPAL welding CURRENT I₁ (L11):**

2200 AC/DC	3000 AC/DC
10 ÷ 180 A	10 ÷ 250 A

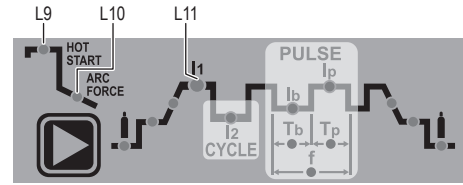

The value for the welding parameters can be regulated using the ENCODER Knob (E).

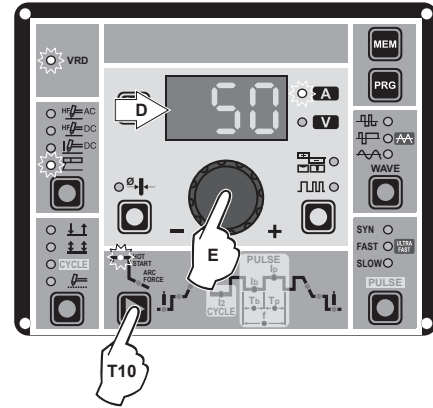

Electrode welding (MMA)

- 1) Start the welding machine by turning the power supply switch to position I.
- 2) **WELDING PROCESS SELECTION**
Push the WELDING PROCESS SELECTION key (T7) to select the ELECTRODE welding processes for welding with “HOT START” or “ARC FORCE” devices that can be programmed by the user.
- 3) Turn the ENCODER Knob (E) until the DISPLAY shows the CURRENT VALUE at which you wish to weld, in relation to the diameter of the electrode you are using.

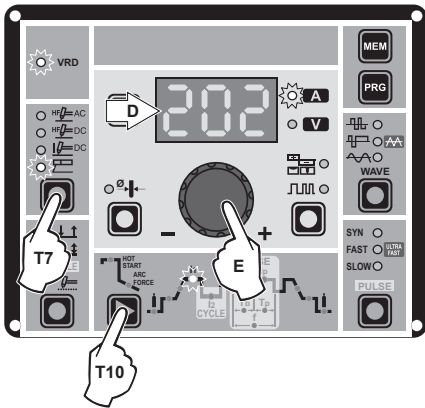

- 5) To exit these functions hold the WELDING PARAMETERS SELECTION key (T10) down for about 1 second, after which the DISPLAY INDICATION LED switches on and the welding machine is once again ready to weld at the current indicated on the DISPLAY (D).
- 6) Once the all the selections/regulations indicated above have been made, welding can begin.
- 7) During the welding process the DISPLAY (D) shows the real Amps (A) at which the operator is actually welding.

4) WELDING PARAMETERS SELECTION

To refine the weld quality, the following parameters can be set by pushing the WELDING PARAMETERS SELECTION key (T10) in succession:

- **HOT START** - This increases the welding current, in percentage terms, for a time interval that can be set at the start of the welding process, thereby reducing the risk of poor fusion at the start of the joint (**L9** - HOT START - 00-100).
- **MMA ARC FORCE** - Regulates, in percentage terms, the dynamic characteristics of the arc (**L10** - ARC FORCE - 00-100).

TIG “AC” welding

- 1) Start the welding machine by turning the power supply switch to position I.
- 2) Push the WELDING PROCESS SELECTION key (T7) to select the **TIG “HF AC”** welding processes for TIG welding in alternating current with high frequency (HF) ignition.
- 3) **ELECTRODE DIAMETER SELECTION**
Select the diameter of the electrode to achieve the best control of ignition in a synergic manner. Selection is done by pushing the ELECTRODE DIAMETER Key (T8) (ELECTRODE DIAMETER LED flashing) and using the ENCODER Knob (E) to regulate the value indicated on the DISPLAY (D).

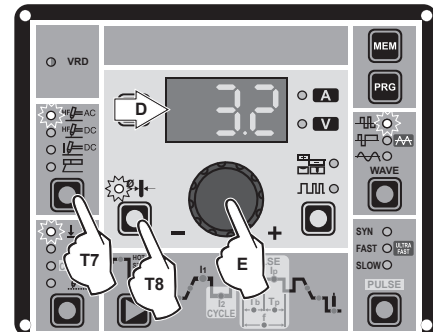

To confirm the diameter selected, simply push the ELECTRODE DIAMETER Key (T8) again (ELECTRODE DIAMETER LED off).

4) SELECTING THE WAVE SHAPE

By pushing the WAVE (T3) button the operator can choose the best wave shape for their welding needs, from the 4 wave shapes included:

- L24 DYNAMIC TIG**
- L25 SPEED TIG**
- L25 COLD TIG**
- L26 SOFT TIG**

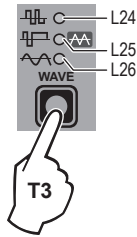

L24 DYNAMIC TIG

Square wave: highly dynamic arc for all applications.

WARNING:

LED **L24** switched on and steady.

The display shows the peak current for pre-setting and welding.

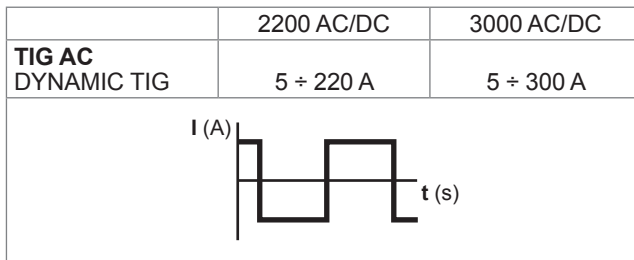

L25 SPEED TIG

Mixed wave: excellent penetration with high welding speed and low electrode consumption. Ideal for average / thick thicknesses and vertical welds. Increases penetration, thermal control of the arc, and lifespan of the electrode.

WARNING:

LED **L25** switched on and steady.

The display shows the peak current for pre-setting and welding.

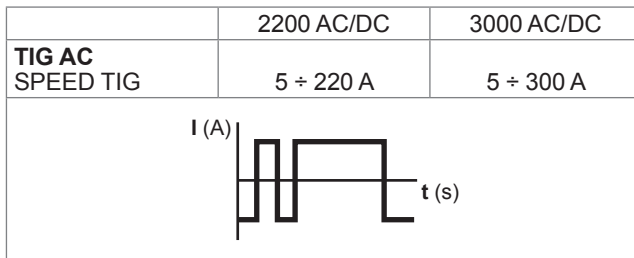

L25 COLD TIG

Triangular wave: low heat generation with reduced distortion, ideal for minor thicknesses.

WARNING:

LED **L25** switched on and flashing.

The display shows the "RMS" current value for pre-setting and welding.

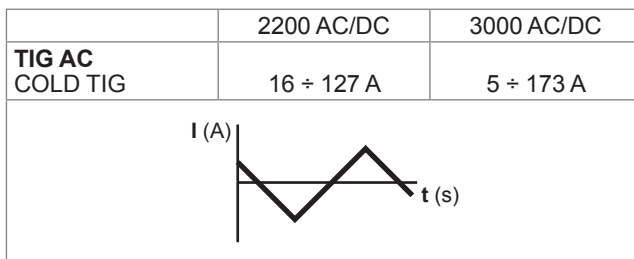

L26 SOFT TIG

Sinusoidal wave: ensures a gentle, soft arc with limited noise, ideal for average thicknesses and butt welding.

WARNING:

LED **L26** switched on and steady.

The display shows the "RMS" current value for pre-setting and welding.

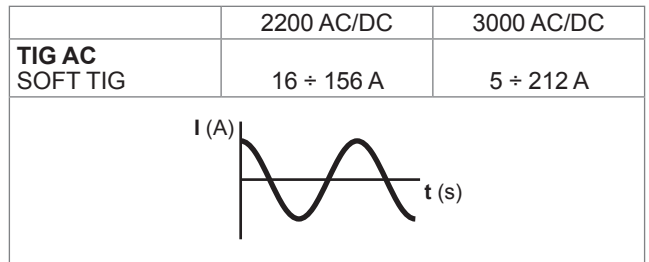

5A) BALANCING of the TIME (t) (-35÷+10)

It allows you to adjust the time (t) the positive or negative electrode stays in place independently, guaranteeing perfect control of penetration and cleanliness, drastically reducing side incisions.

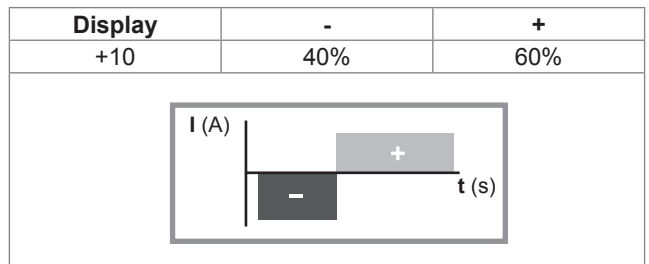
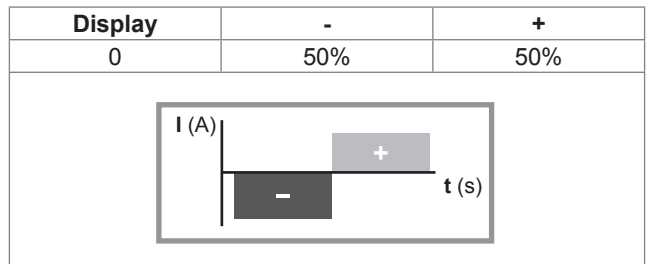
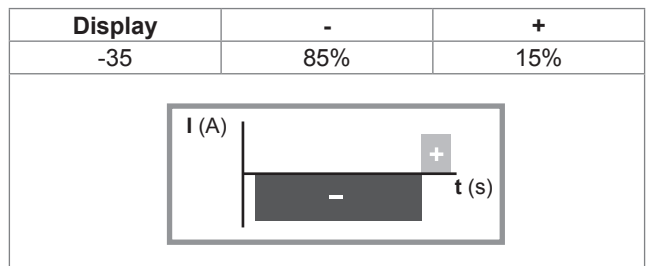

Push the BALANCING and FREQUENCY key (T4) once and use the ENCODER Knob (E) to regulate the value indicated on the DISPLAY (D).

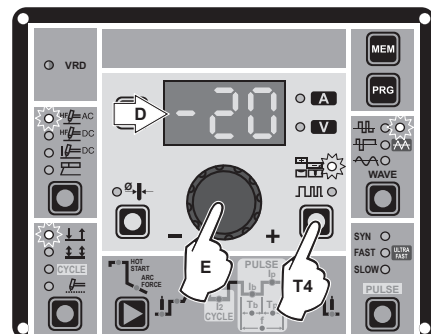

LED **L30** switched on and flashing.

To exit, simply push the BALANCING and FREQUENCY (T4) key again (BALANCING LED off).

5B) **BALANCING the AMPLITUDE of the CURRENT (I) (-50÷+20)**

It is possible to adjust the amplitude of the current (I) while the electrode stays in place independently, using positive or negative values, guaranteeing perfect control of penetration and cleanliness, drastically reducing side incisions.

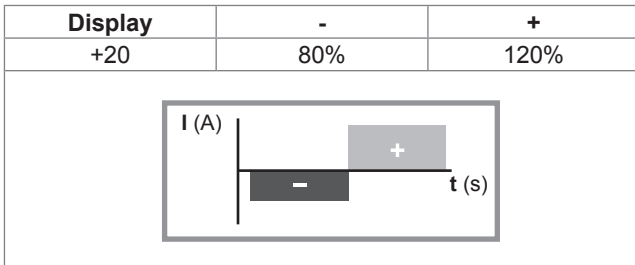
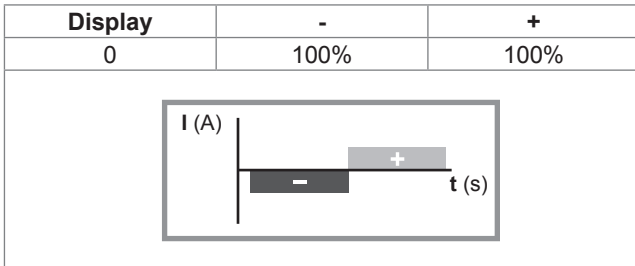
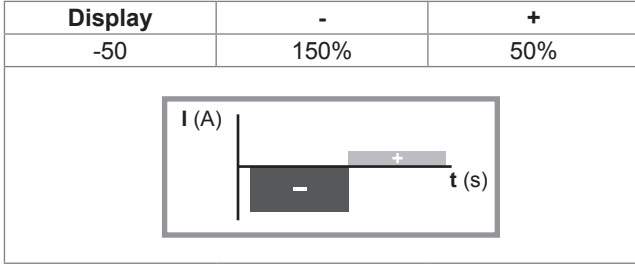

Press the BALANCING and FREQUENCY (T4) key once, wait a few seconds, and hold the same key down for at least 2 seconds. Then use the ENCODER Knob (E) to adjust the value shown on the DISPLAY (D).

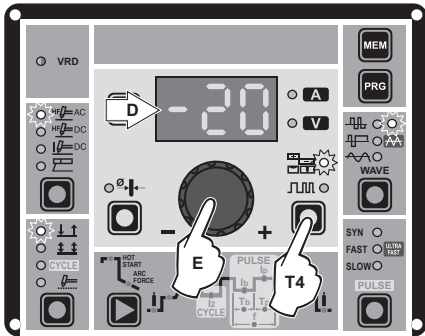

LED **L30** flashing intermittently.

To exit, simply push the BALANCING and FREQUENCY (T4) key again (BALANCING LED off).

5C) **BALANCING (BALANCE PLUS)**

It is possible to adjust the time (t) and amplitude of the current (I) while the electrode stays in place simultaneously and independently, using positive or negative values, guaranteeing perfect control of penetration and cleanliness, drastically reducing side incisions.

For simultaneous setting of the parameters, following the instructions given in points 5A and 5B in succession, with the help (if necessary) of the example shown below.

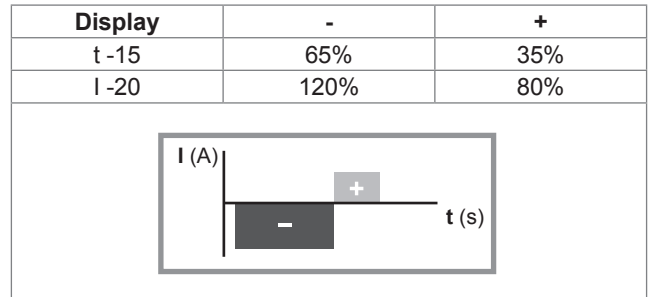

6) **FREQUENCY CONTROL IN AC (40 ÷ 250 Hz)**

This controls the frequency for the various wave shapes, for better directional control, reducing the thermally altered area, with greater penetration and lower electrode consumption. The high frequency makes it possible to weld very small thicknesses with excellent results, while the low frequency is ideal for welding average thicknesses, or where edge preparation is poor.

MIN 40 Hz



MAX 250 Hz

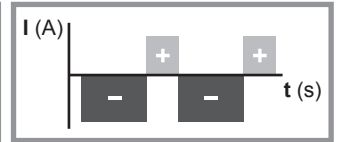

To regulate the FREQUENCY push the BALANCING and FREQUENCY key (T4) twice (FREQUENCY LED flashing) and use the ENCODER Knob (E) to regulate the value indicated on the DISPLAY (D).

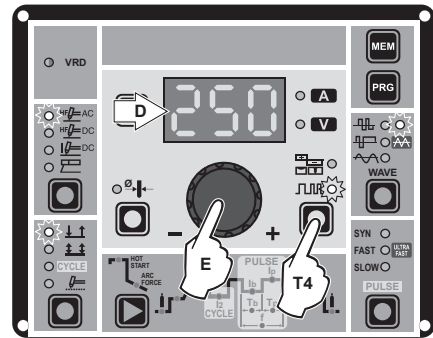

To exit, simply push the BALANCING and FREQUENCY (T4) key again (FREQUENCY LED off).

7) Press the WELDING MODE SELECTION Key (T9) and go to one of the 4 options available:

- L5** 2T
- L6** 4T
- L7** CYCLE
- L8** SPOT WELD

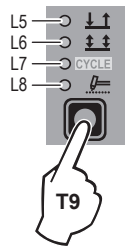

8) By pushing the WELDING PARAMETERS SELECTION key a number of times it is possible to set the various TIG WELDING PARAMETERS (see the "TIG AC and DC Welding" paragraph - WELDING PARAMETERS).

9) Once the all the selections/regulations indicated above have been made, welding can begin.

10) During the welding process the DISPLAY shows the real Amps (A) at which the operator is actually welding.

TIG "DC" welding

- 1) Start the welding machine by turning the power supply switch to position I.
- 2) Press the WELDING PROCESS SELECTION Key (T7) and select:

L2 a TIG "HF DC" welding process for direct current TIG welding with high frequency ignition.

L3 a TIG "Lift DC" welding process for direct current TIG "Lift" type welding without high frequency.

WARNING: The "Lift" ignition current is created by pushing the torch button only after having touched the workpiece with the electrode.

- 3) **ELECTRODE DIAMETER SELECTION**

Select the diameter of the electrode to achieve the best control of ignition in a synergic manner. Selection is done by pushing the ELECTRODE DIAMETER Key (T8) (ELECTRODE DIAMETER LED flashing) and using the ENCODER Knob (E) to regulate the value indicated on the DISPLAY (D).

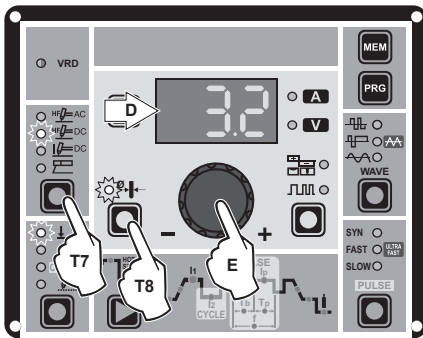

To confirm the diameter selected, simply push the ELECTRODE DIAMETER Key (T8) again (ELECTRODE DIAMETER LED off).

- 4) Press the WELDING MODE SELECTION Key (T9) and go to one of the 4 options available:

- L5** 2T
- L6** 4T
- L7** CYCLE
- L8** SPOT WELD

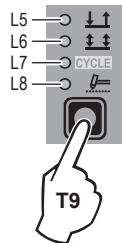

- 5) Turn the ENCODER Knob (E) until the DISPLAY (D) shows the CURRENT VALUE at which you wish to weld.

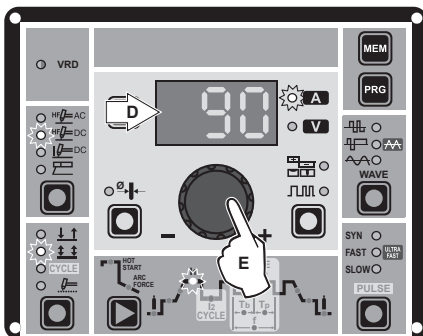

- 6) By pushing the WELDING PARAMETERS SELECTION (T10) key a number of times it is possible to set the various TIG WELDING PARAMETERS (see the "TIG AC and DC Welding" paragraph - WELDING PARAMETERS).
- 7) Once the all the selections/regulations indicated above have been made, welding can begin.
- 8) During the welding process the DISPLAY shows the real Amps (A) at which the operator is actually welding.

TIG "AC and LIFT DC" welding with the SPOT WELDING function on

- 1) Start the welding machine by turning the power supply switch to position I.
- 2) Press the WELDING PROCESS SELECTION Key (T7) and select one of the welding machine's 2 TIG processes:

L1 TIG "HF AC"

L3 TIG "Lift DC"

- 3) Press the WELDING MODE SELECTION Key (T9) and go to one of the **SPOT WELDING** function.

- 4) Press and release the WELDING PARAMETERS SELECTION Key (T10) until the SPOT WELD LED starts flashing.

- 5) Rotate the ENCODER knob (E) to set the SPOT WELDING time required:



	2200 AC/DC - 3000 AC/DC
TIG AC	0,1 ÷ 10,0 sec
TIG LIFT DC	0,01 ÷ 10,0 sec

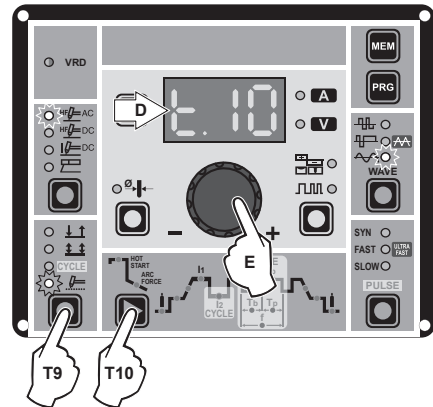

- 6) By pushing the WELDING PARAMETERS SELECTION (T10) key a number of times it is possible to set the various TIG WELDING PARAMETERS (see the "TIG AC and DC Welding" paragraph - WELDING PARAMETERS).
- 7) Hold the SELECT WELDING PARAMETERS (T10) key down to save the parameters chosen.
- 8) Once the all the selections/regulations indicated above have been made, welding can begin.
- 9) During the welding process the DISPLAY shows the real Amps (A) at which the operator is actually welding.

TIG HF DC welding with TACK function active and single ColdTack point

Innovative TIG HF DC tack weld device that makes it possible to do precise, safe tack welding with very little heat applied. Thanks to the "Perfect-Point" mode, ColdTack guarantees perfect centring of the welding point. The "Perfect-Point" mode is activated by touching the workpiece to be welded with the tungsten tip, at the exact point at which you wish to do the tack weld. Proceed as follows:

- 1) Start the welding machine by turning the power supply switch to position I.
- 2) Push the SELECT WELDING PROCESS (T5) key and select the TIG DC process, with HF ignition.
- 3) Press the WELDING MODE SELECTION Key (T9) and go to one of the **SPOT WELDING coldTack** function. The TACK WELD and $\uparrow\downarrow$ LEDs are lit continuously.
- 4) Press and release the WELDING PARAMETERS SELECTION Key (T10) until the SPOT WELD LED starts flashing.
- 5) Rotate the ENCODER knob (E) to set the SPOT WELDING time required (0,01-10,0 sec).

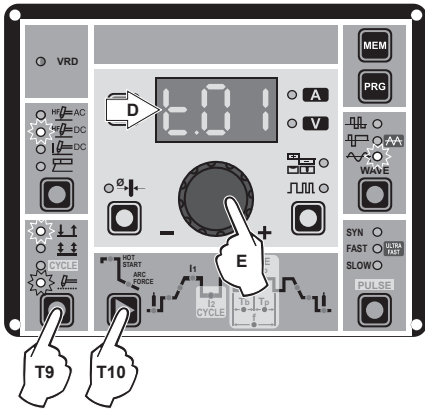

- 6) By pushing the WELDING PARAMETERS SELECTION (T10) key a number of times it is possible to set the various TIG WELDING PARAMETERS (see the "TIG Welding" paragraph - WELDING PARAMETERS).
- 7) Hold the SELECT WELDING PARAMETERS (T10) key down to save the parameters chosen.
- 8) Once the all the selections/regulations indicated above have been made, welding can begin. Ignite the arc using "distance" ignition or by touching the workpiece to be welded with the tungsten tip. In the latter case, the "Perfect-Point" mode is activated.
- 9) During the welding process the DISPLAY shows the real Amps (A) at which the operator is actually welding.

TIG HF DC welding with TACK function active and Multi-ColdTack function

The Multi-ColdTack function can be used for cold tacking in quick succession, to further extend the benefits of an individual ColdTack point. Thanks to the "Perfect-Point" mode, ColdTack guarantees perfect centring of the welding point. The "Perfect-Point" mode is activated by touching the workpiece to be welded with the tungsten tip, at the exact point at which you wish to do the tack weld. Proceed as follows:

- 1) Start the welding machine by turning the power supply switch to position I.
- 2) Push the SELECT WELDING PROCESS (T5) key and select the TIG DC process, with HF ignition.
- 3) Press the WELDING MODE SELECTION Key (T9) and go to one of the **SPOT WELDING Multi-coldTack** function. The TACK WELD LED flashes, whereas the $\uparrow\downarrow$ LED is lit continuously.
- 4) Push and release the SELECT WELDING PARAMETERS (T10) key to be able to set the 2 parameters by rotating the ENCODER Knob (E):
 - Total tack welding time "t..." for the sequence of individual ColdTack points (0,01-10,0 sec).
 - Individual ColdTack point "P..." time (0,01-1,0 sec).

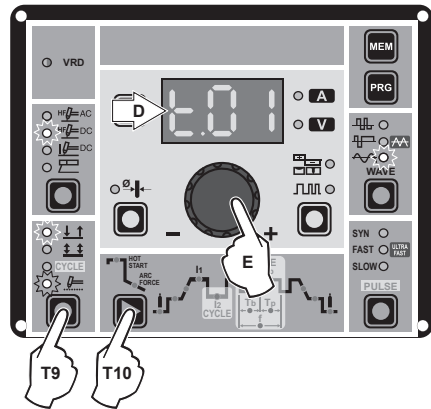

- 5) By pushing the WELDING PARAMETERS SELECTION (T10) key a number of times it is possible to set the various TIG WELDING PARAMETERS (see the "TIG Welding" paragraph - WELDING PARAMETERS).
- 6) Hold the SELECT WELDING PARAMETERS (T10) key down to save the parameters chosen.
- 7) Once the all the selections/regulations indicated above have been made, welding can begin. Ignite the arc using "distance" ignition or by touching the workpiece to be welded with the tungsten tip. In the latter case, the "Perfect-Point" mode is activated.
- 8) During the welding process the DISPLAY shows the real Amps (A) at which the operator is actually welding.

TIG "AC and DC" welding - Welding parameters

- The **MATRIX AC/DC** can be configured in the following 2 ways:
- **STANDARD (Std)** configuration.
- **SPECIAL (SPE)** configuration.

STANDARD CONFIGURATION (Std)

When it leaves the factory the welding machine is normally configured in STANDARD (Std) mode.

To check the configuration, carry out the following operations:

- 1) When the welding machine is off, push and hold the "PRG" PROGRAM key down (T2).
- 2) Start the welding machine by turning the power supply switch to position I.
- 3) The DISPLAY (D) shows the following message: **Std** (welder configured in STANDARD mode).

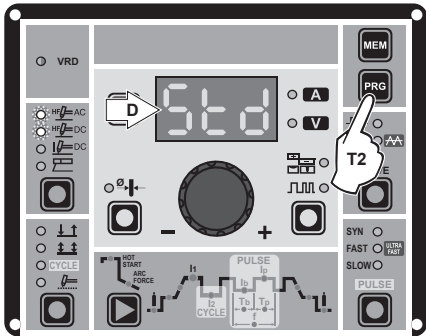

- 4) Press the "PRG" PROGRAM key (T2) to confirm.

The **WELDING PARAMETERS** included, programmable, and that can be edited (by turning the ENCODER key) in a **STANDARD (Std)** configuration can be broken down into 3 different sub-groups:

1 - "BASIC" WELDING PARAMETERS

Press the WELDING PARAMETERS SELECTION Key (T10) a number of times to set:

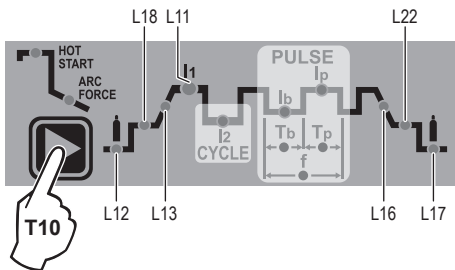

L12 PRE-GAS duration (0,05 ÷ 1,00 sec)

WARNING: This **CANNOT** be programmed when the TIG DC with "Lift" type ignition welding processes is active.

L18 INITIAL welding CURRENT

	2200 AC/DC	3000 AC/DC
TIG DC	5 ÷ 220 A	5 ÷ 300 A
TIG AC		
DYNAMIC TIG	5 ÷ 220 A	5 ÷ 300 A
SPEED TIG	5 ÷ 220 A	5 ÷ 300 A
COLD TIG	16 ÷ 127 A	5 ÷ 173 A
SOFT TIG	16 ÷ 156 A	5 ÷ 212 A

WARNING: This can only be programmed when 4 STROKES or CYCLE welding mode is activated.

L13 SLOPE UP duration (0,0 ÷ 5,0 sec)

L11 PRINCIPAL welding CURRENT I1

	2200 AC/DC	3000 AC/DC
TIG DC	5 ÷ 220 A	5 ÷ 300 A
TIG AC		
DYNAMIC TIG	5 ÷ 220 A	5 ÷ 300 A
SPEED TIG	5 ÷ 220 A	5 ÷ 300 A
COLD TIG	16 ÷ 127 A	5 ÷ 173 A
SOFT TIG	16 ÷ 156 A	5 ÷ 212 A

L16 SLOPE DOWN duration (0,0 ÷ 8,0 sec)

L22 FINAL welding CURRENT

	2200 AC/DC	3000 AC/DC
TIG DC	5 ÷ 220 A	5 ÷ 300 A
TIG AC		
DYNAMIC TIG	5 ÷ 220 A	5 ÷ 300 A
SPEED TIG	5 ÷ 220 A	5 ÷ 300 A
COLD TIG	16 ÷ 127 A	5 ÷ 173 A
SOFT TIG	16 ÷ 156 A	5 ÷ 212 A

WARNING: This can only be programmed when 4 STROKES or CYCLE welding mode is activated.

L17 POST GAS duration (0,5 ÷ 25,0 sec)

WARNING: When the post-gas LED flashes and the LED I1 is on at the same time, this means that the welding machine is in the post-gas stage.

To exit the setting phase, hold the WELDING PARAMETERS SELECTION key (T10) down for about 1 second.

2 - WELDING PARAMETERS with PULSE mode active:

Pulsed TIG welding allows greater control of the arc and better deformation of the material.

The **MATRIX AC/DC** can be used for TIG AC and DC pulsed welding in 4 different modes:

- SLOW PULSE
- FAST PULSE
- ULTRA FAST PULSE
- SYN PULSE

WARNING: Pulsation is deactivated automatically for the duration of the INITIAL and FINAL current.

2A) SLOW PULSE

TIG pulse welding with manual setting of parameters.

WARNING: This can only be programmed when the 3 TIG welding processes are used.

Press the PULSE key (T5) until the required pulsation is active.



Press the WELDING PARAMETERS SELECTION Key (T10) a number of times to set the following (in addition to the WELDING PARAMETERS defined as being "BASIC"):

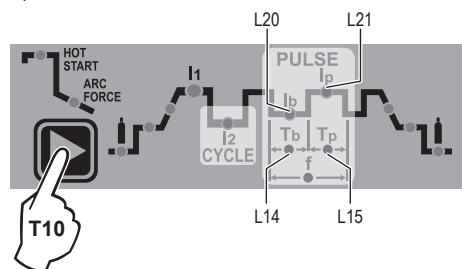

L21 PEAK CURRENT I_p

	2200 AC/DC	3000 AC/DC
TIG DC	5 ÷ 220 A	5 ÷ 300 A
TIG AC		
DYNAMIC TIG	5 ÷ 220 A	5 ÷ 300 A
SPEED TIG	5 ÷ 220 A	5 ÷ 300 A
COLD TIG	16 ÷ 127 A	5 ÷ 173 A
SOFT TIG	16 ÷ 156 A	5 ÷ 212 A

L20 BASE CURRENT I_b

	2200 AC/DC	3000 AC/DC
TIG DC	5 ÷ 220 A	5 ÷ 300 A
TIG AC		
DYNAMIC TIG	5 ÷ 220 A	5 ÷ 300 A
SPEED TIG	5 ÷ 220 A	5 ÷ 300 A
COLD TIG	16 ÷ 127 A	5 ÷ 173 A
SOFT TIG	16 ÷ 156 A	5 ÷ 212 A

L15 PEAK current duration T_p

	2200 AC/DC - 3000 AC/DC
TIG DC	0,01 ÷ 0,99 sec
TIG AC	0,10 ÷ 0,99 sec

L14 BASE current duration T_b

	2200 AC/DC - 3000 AC/DC
TIG DC	0,01 ÷ 0,99 sec
TIG AC	0,10 ÷ 0,99 sec

To exit the setting phase, hold the WELDING PARAMETERS SELECTION key (T10) down for about 1 second.

2B) FAST PULSE

TIG pulse welding with manual setting of parameters.

WARNING: This can only be programmed when the TIG DC with HF ignition or TIG DC with "Lift" type ignition welding processes are used.

Press the PULSE key (T5) until the required pulsation is active.

Press the WELDING PARAMETERS SELECTION Key (T10) a number of times to set the following (in addition to the WELDING PARAMETERS defined as being "BASIC"):

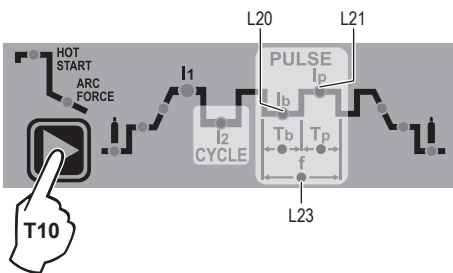

L20 BASE CURRENT I_b

2200 AC/DC	3000 AC/DC
5 ÷ 220 A	5 ÷ 300 A

L21 PEAK CURRENT I_p

2200 AC/DC	3000 AC/DC
5 ÷ 220 A	5 ÷ 300 A

L23 PULSATION FREQUENCY f

	2200 AC/DC - 3000 AC/DC
FAST	0,5 ÷ 500 Hz

To exit the setting phase, hold the WELDING PARAMETERS SELECTION key (T10) down for about 1 second.

2C) ULTRA FAST PULSE

TIG pulse welding with manual setting of parameters.

WARNING: This can only be programmed when the TIG DC with HF ignition or TIG DC with "Lift" type ignition welding processes are used.

The possibility of using pulsation frequencies that are not as high, up to 2000 Hz, ideal for welding minor thicknesses, makes it possible to achieve a great reduction in the arc cone and the area thermally altered, with a more stable, concentrated arc and an increase in weld penetration and speed.



Press the PULSE key (T5) until the required pulsation is active.

Press the WELDING PARAMETERS SELECTION Key (T10) a number of times to set the following (in addition to the WELDING PARAMETERS defined as being "BASIC"):

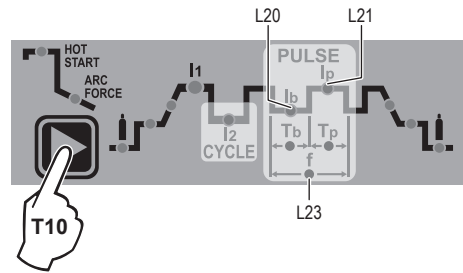

L20 BASE CURRENT I_b

2200 AC/DC	3000 AC/DC
5 ÷ 220 A	5 ÷ 300 A

L21 PEAK CURRENT I_p

2200 AC/DC	3000 AC/DC
5 ÷ 220 A	5 ÷ 300 A

L23 PULSATION FREQUENCY f

	2200 AC/DC - 3000 AC/DC
ULTRA FAST	500 ÷ 2000 Hz

To exit the setting phase, hold the WELDING PARAMETERS SELECTION key (T10) down for about 1 second.

2D) SYN PULSE

TIG pulse welding with synergic setting of parameters.

WARNING: This can only be programmed when the TIG DC with HF ignition or TIG DC with "Lift" type ignition welding processes are used.

Press the PULSE key (T5) until the required pulsation is active.

Press the WELDING PARAMETERS SELECTION Key (T10) a number of times to set the following (in addition to the WELDING PARAMETERS defined as being "BASIC"):

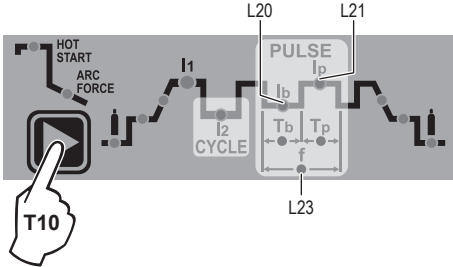

L20 BASE CURRENT I_b

2200 AC/DC	3000 AC/DC
25 ÷ 220 A	25 ÷ 300 A

This function, which is good for less skilled operators, makes it possible to change the pulsation parameter (Peak current I_p) and the other values for the corresponding pulsation parameters (Base current I_b - Pulsation frequency f) vary automatically. To exit the setting phase, hold the WELDING PARAMETERS SELECTION key (T10) down for about 1 second.

3 - WELDING PARAMETERS with PULSE mode and CYCLE welding mode active (CYCLE LED on)

When this welding mode is active it is possible to work at 2 different pulse current levels (I₁ and I₂). To do so you must also set (not only pulse parameters I_b, I_p, and f, but also the 2nd level PEAK current (I_{2p}). The other 2nd level pulse parameters (BASIC CURRENT I_{2b} and FREQUENCY f) are achieved synergically. The FREQUENCY remains constant while the 2nd level BASIC CURRENT I_{2b} is proportional to the ratio between the 1st level currents.

3A - SLOW PULSE + CYCLE

Press the PULSE key (T5) until the required pulsation is active (SLOW LED on). Press the WELDING MODE SELECTION key (T9) until the CYCLE welding mode is active (CYCLE LED on).

Press the WELDING PARAMETERS SELECTION Key (T10) a number of times to set the following (in addition to the WELDING PARAMETERS defined as being "BASIC"):

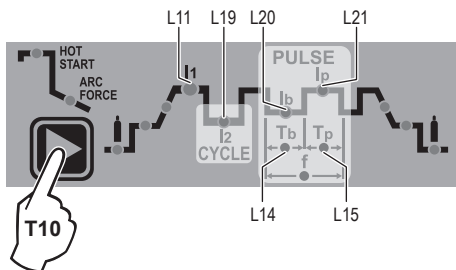
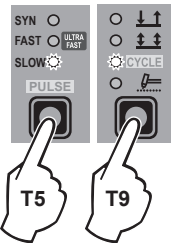

L11-L21 1st LEVEL PEAK CURRENT I_{1p}

	2200 AC/DC	3000 AC/DC
TIG DC	5 ÷ 220 A	5 ÷ 300 A
TIG AC		
DYNAMIC TIG	5 ÷ 220 A	5 ÷ 300 A
SPEED TIG	5 ÷ 220 A	5 ÷ 300 A
COLD TIG	16 ÷ 127 A	5 ÷ 173 A
SOFT TIG	16 ÷ 156 A	5 ÷ 212 A

L19 2nd LEVEL PEAK CURRENT I_{2p}

	2200 AC/DC	3000 AC/DC
TIG DC	5 ÷ 220 A	5 ÷ 300 A
TIG AC		
DYNAMIC TIG	5 ÷ 220 A	5 ÷ 300 A
SPEED TIG	5 ÷ 220 A	5 ÷ 300 A
COLD TIG	16 ÷ 127 A	5 ÷ 173 A
SOFT TIG	16 ÷ 156 A	5 ÷ 212 A

L20 1st LEVEL BASE CURRENT I_{1b}

	2200 AC/DC	3000 AC/DC
TIG DC	5 ÷ 220 A	5 ÷ 300 A
TIG AC		
DYNAMIC TIG	5 ÷ 220 A	5 ÷ 300 A
SPEED TIG	5 ÷ 220 A	5 ÷ 300 A
COLD TIG	16 ÷ 127 A	5 ÷ 173 A
SOFT TIG	16 ÷ 156 A	5 ÷ 212 A

L15 PEAK current duration T_p

	2200 AC/DC - 3000 AC/DC
TIG DC	0,01 ÷ 0,99 sec
TIG AC	0,10 ÷ 0,99 sec

L14 BASE current duration T_b

	2200 AC/DC - 3000 AC/DC
TIG DC	0,01 ÷ 0,99 sec
TIG AC	0,10 ÷ 0,99 sec

To exit the setting phase, hold the WELDING PARAMETERS SELECTION key (T10) down for about 1 second.

3B - FAST PULSE + CYCLE

Press the PULSE key (T5) until the required pulsation is active (FAST LED on). Press the WELDING MODE SELECTION key (T9) until the CYCLE welding mode is active (CYCLE LED on).

Press the WELDING PARAMETERS SELECTION Key (T10) a number of times to set the following (in addition to the WELDING PARAMETERS defined as being "BASIC"):

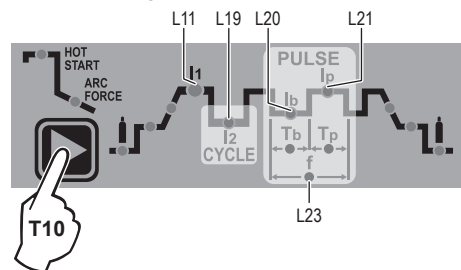
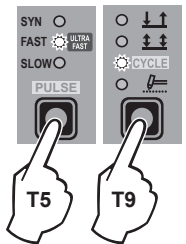

L11 - L21 1st LEVEL PEAK CURRENT I_{1p}

2200 AC/DC	3000 AC/DC
5 ÷ 220 A	5 ÷ 300 A

L19 2nd LEVEL PEAK CURRENT I_{2p}

2200 AC/DC	3000 AC/DC
5 ÷ 220 A	5 ÷ 300 A

L20 1st LEVEL BASE CURRENT I_{1b}

2200 AC/DC	3000 AC/DC
5 ÷ 220 A	5 ÷ 300 A

L23 PULSATION FREQUENCY f

	2200 AC/DC - 3000 AC/DC
FAST	0,5 ÷ 500 Hz

To exit the setting phase, hold the WELDING PARAMETERS SELECTION key (T10) down for about **1 second**.

3C - ULTRA FAST PULSE + CYCLE

Press the PULSE key (T5) until the required pulsation is active (ULTRA FAST LED flashing). Press the WELDING MODE SELECTION key (T9) until the CYCLE welding mode is active (CYCLE LED on).

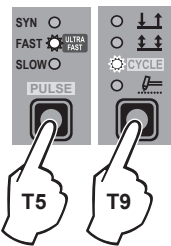

Press the WELDING PARAMETERS SELECTION Key (T10) a number of times to set the following (in addition to the WELDING PARAMETERS defined as being "BASIC"):

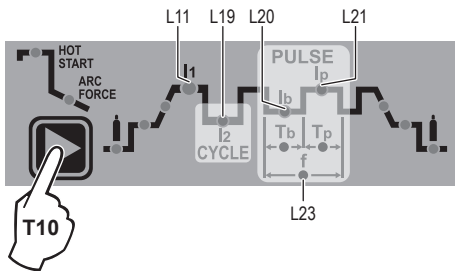

L11 - L21 1st LEVEL PEAK CURRENT I_{1p}

2200 AC/DC	3000 AC/DC
5 ÷ 220 A	5 ÷ 300 A

L19 2nd LEVEL PEAK CURRENT I_{2p}

2200 AC/DC	3000 AC/DC
25 ÷ 220 A	25 ÷ 300 A

L20 1st LEVEL BASE CURRENT I_{1b}

2200 AC/DC	3000 AC/DC
5 ÷ 220 A	5 ÷ 300 A

L23 PULSATION FREQUENCY f

	2200 AC/DC - 3000 AC/DC
ULTRA FAST	500 ÷ 2000 Hz

To exit the setting phase, hold the WELDING PARAMETERS SELECTION key (T10) down for about **1 second**.

3D - SYN PULSE + CYCLE

Press the PULSE key (T5) until the required pulsation is active (SYN LED on). Press the WELDING MODE SELECTION key (T9) until the CYCLE welding mode is active (CYCLE LED on).

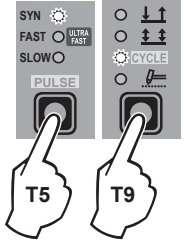

Press the WELDING PARAMETERS SELECTION Key (T10) a number of times to set the following (in addition to the WELDING PARAMETERS defined as being "BASIC"):

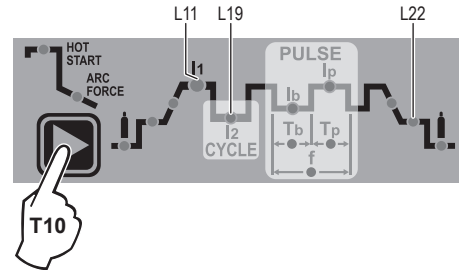

L11 - L21 1st LEVEL PEAK CURRENT I_{1p}

2200 AC/DC	3000 AC/DC
25 ÷ 220 A	25 ÷ 300 A

WARNING: When the SYN PULSE function is active, the 1st level PEAK CURRENT (I_{1p}) is regulated to achieve a synergy with the values for the other 1st level parameters (I_{1b}, f).

L19 2nd LEVEL PEAK CURRENT I_{2p}

2200 AC/DC	3000 AC/DC
5 ÷ 220 A	5 ÷ 300 A

WARNING: When the SYN PULSE function is active, the 2nd level PEAK CURRENT (I_{2p}) is regulated to achieve a synergy with the values for the other 2nd level parameters (I_{2b}, f).

If you want to do a test weld, during the test the LED for the parameter selected flashes and the DISPLAY shows the value for the parameter you are setting.

To exit the setting phase, hold the WELDING PARAMETERS SELECTION key (T10) down for about **1 second**.

NOTE: During the welding process if LED I_{2p} and LED I₁ stay switched on on the DISPLAY, the 1st level current at which you are welding is displayed.

NOTE: During the welding process if LED I₂ and LED I_p stay switched on on the DISPLAY, the 2nd level current at which you are welding is displayed.

SPECIAL CONFIGURATION (SPE)

In welding processes:

- TIG AC with HF ignition
- TIG DC with HF ignition

The **MATRIX AC/DC** makes it possible to activate modification of some WELDING PARAMETERS therefore providing a more expert welder with a more versatile welding machine. Activation will only take place after the machine configuration is changed from STANDARD (Std) to SPECIAL (SPE), which must be done as follows:

- 1) When the welding machine is off, push and hold the "PRG" PROGRAM key down (T2).
- 2) Start the welding machine by turning the power supply switch to position I.
- 3) The DISPLAY (D) shows the following message: **Std** (welder configured in STANDARD mode).

- 4) Turn the ENCODER Key (E) until the DISPLAY (D) shows the following message: **SPE** (welder configured in SPECIAL mode).

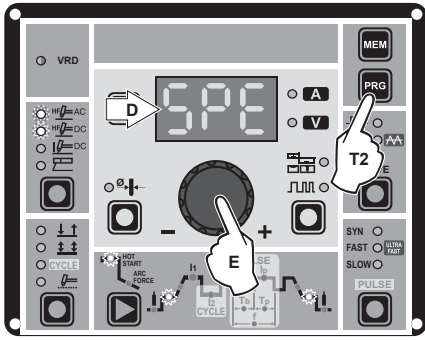

- 5) Press the “PRG” PROGRAM key (T2) to confirm.

The **WELDING PARAMETERS** included, that can be programmed and changed (by turning the ENCODER knob) in the **SPECIAL (SPE)** configuration, along with those in the STANDARD configuration, can be set by pushing the WELDING PARAMETER SELECTION button (T10) successively:

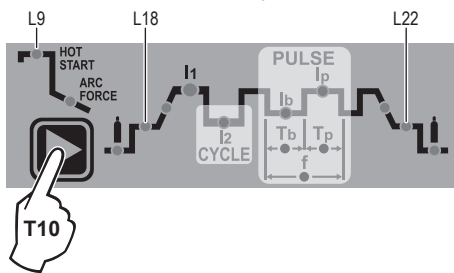

L9 IGNITION CURRENT

	2200 AC/DC	3000 AC/DC
	5 ÷ 220 A	5 ÷ 300 A

WARNING: This can only be programmed for TIG AC with HF ignition - TIG DC with HF ignition welding processes.

L9 IGNITION TIME duration (t.01 (0,01 sec) - t.50 (0,50 sec))

WARNING: This can only be programmed when the TIG AC with HF ignition welding process is active.

WARNING: If the value of these 2 parameters is too low, this could prejudice ignition.

L18 IGNITION welding CURRENT

	2200 AC/DC	3000 AC/DC
TIG DC	5 ÷ 220 A	5 ÷ 300 A
TIG AC		
DYNAMIC TIG	5 ÷ 220 A	5 ÷ 300 A
SPEED TIG	5 ÷ 220 A	5 ÷ 300 A
COLD TIG	16 ÷ 127 A	5 ÷ 173 A
SOFT TIG	16 ÷ 156 A	5 ÷ 212 A

WARNING: This can only be programmed when the TIG AC with HF ignition or TIG DC with HF ignition welding processes and the 2 STROKES welding mode are used.

L22 FINAL welding CURRENT

	2200 AC/DC	3000 AC/DC
TIG DC	5 ÷ 220 A	5 ÷ 300 A
TIG AC		
DYNAMIC TIG	5 ÷ 220 A	5 ÷ 300 A
SPEED TIG	5 ÷ 220 A	5 ÷ 300 A
COLD TIG	16 ÷ 127 A	5 ÷ 173 A
SOFT TIG	16 ÷ 156 A	5 ÷ 212 A

WARNING: This can only be programmed when the TIG AC with HF ignition or TIG DC with HF ignition welding processes and the 2 STROKES welding mode are used.

To exit the setting phase, hold the WELDING PARAMETERS SELECTION key (T10) down for about **1 second**.

WARNING: These WELDING PARAMETERS are only to be activated by qualified personnel, or those trained by technicians.

Editing the maximum and minimum limits for welding parameters

Welding machine in STANDARD (Std) configuration:

In welding processes:

- TIG AC with HF ignition
- TIG DC with HF ignition

The **MATRIX AC/DC** makes it possible to activate modification of the MAXIMUM AND MINIMUM LIMITS for some WELDING PARAMETERS thereby providing a more expert welder with a more versatile welding machine.

Proceed as follows:

- 1) Switch on the welding machine holding down the WELDING PARAMETERS SELECTION key (T10).
- 2) Press the WELDING PARAMETERS SELECTION Key (T10) a number of times to set the limits for the following welding parameters:

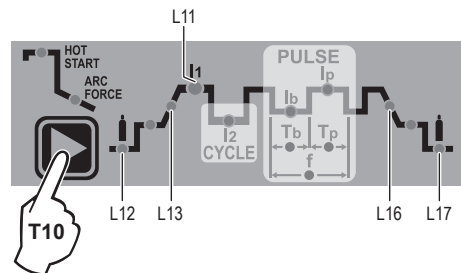

L12 PRE-GAS duration (maximum limit settable from 1,00 to 2,50 sec)

L13 SLOPE UP duration (maximum limit settable from 5,00 to 10,0 sec)

L11 MINIMUM CURRENT for remote controls - minimum limit settable:

	2200 AC/DC	3000 AC/DC
	5 ÷ 220 A	5 ÷ 300 A

WARNING: If the minimum limit setting (for the remote control MINIMUM CURRENT) is greater than or equal to the value for the PRINCIPAL welding CURRENT **I₁**, you will weld at the PRINCIPAL welding CURRENT **I₁**, irrespective of the setting you have chosen for the remote control.

L16 SLOPE DOWN duration (maximum limit settable from 8,00 to 15,0 sec)

L17 POST-GAS duration (maximum limit settable from 10,0 to 25,0 sec)

To exit the setting phase, hold the WELDING PARAMETERS SELECTION key (T10) down for about **1 second**. The values set are now active and welding can begin.

Creating and memorising automatic welding points

Once you have defined the parameters the operator requires to do their work properly, you can save them in the memory and create a WELDING PROGRAM by proceeding as follows.

WARNING: To access the setting saving phase, the **PRINCIPAL CURRENT LED 11** must be switched on without flashing.

- 1) Hold the "PRG" PROGRAM Key (T2) down for at least **5** consecutive seconds until the DISPLAY (D) reads **Pr**, accompanied by a flashing number (e.g. Pr 1).
In order to be able to choose WELDING PROGRAM that is free, simply rotate the ENCODER knob (E) and look for a program for which the control panel has all the LEDs for the various settings switched off.

WARNING: The MTA control panel allows you to save a maximum of **6** WELDING PROGRAMS.

It is also possible to overwrite a program already saved.

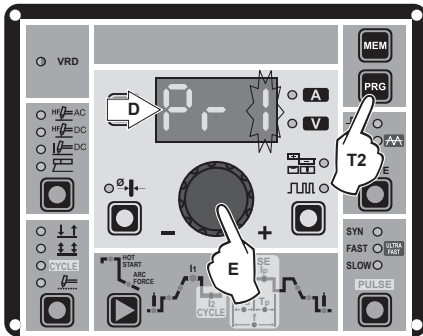

- 2) To **SAVE** the PROGRAM hold the "MEM" SAVE Key (T1) down until the DISPLAY reads "**Sto**".
- 3) The WELDING PROGRAM has now been saved and its number appears in the DISPLAY (D) along with the other settings saved (corresponding LEDs on without flashing).

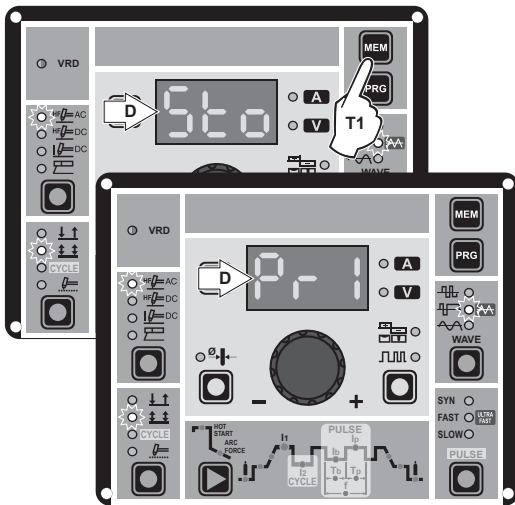

PROGRAMMED and/ or MANUAL welding

PROGRAMMED WELDING

When the WELDING PROGRAM has been saved, the operator can weld using only pre-set values as they cannot edit any type of parameter / function. To edit, switch to MANUAL welding mode.

MANUAL WELDING

To go back to set / edit the parameters selected or to create a new program, proceed as follows:

- 1) Hold the "PRG" PROGRAM Key (T2) down (about **3** seconds) until the DISPLAY (D) shows the number of the program selected flashing (e.g. **Pr6**).

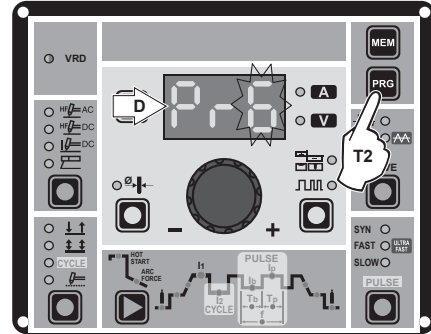

- 2) Turn the ENCODER Key (E) anticlockwise until the DISPLAY (D) shows 3 dashes.



- 3) Press and release the "PRG" PROGRAM key (T2) and the machine goes back to the initial operation condition.
- 4) You can now set or edit the individual parameters or create new programs.
- 5) Rotate the ENCODER Knob (E) to scroll the programs until you find an empty, unused program slot.

Calling up saved programs

- 1) Hold the "PRG" PROGRAM Key (T2) down (about **3** seconds) until the DISPLAY (D) shows the number of the program selected flashing (e.g. Pr 6).
- 2) Turn the ENCODER Knob (E) until the DISPLAY (D) shows the program number (flashing) you wish to call up (e.g. Pr5).

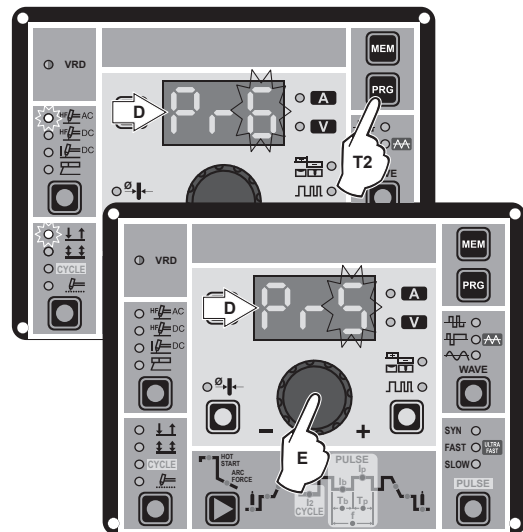

NOTE: If when you are rotating the ENCODER knob (E) to look for a saved welding program to call up the MTA panel does not have any LEDs switched on without flashing, this means that the welding program you are trying to call up has not been saved and, as a result, cannot be called up!

- 3) Press and release the “PRG” PROGRAM key (T2) to call up the program number selected.
- 4) You can now carry out **PROGRAMMED** welding.

Viewing the parameters set

- 1) Call up the program required (see the “Calling up saved programs” paragraph).
- 2) Press and release the WELDING PARAMETERS SELECTION Key (T10) to view the parameters set in sequence.
- 3) Hold the WELDING PARAMETERS SELECTION Key (T10) down for more than 1 second to go back to the program selected.

NOTE: If the parameters set are edited, you automatically exit programming.



Activating the VRD device

To activate the VRD device, which must be done when the welding machine is switched off:

- 1) Use a suitable screwdriver to unscrew the 4 screws that fix the MTA control panel to the welding machine.
- 2) Position JUMPER W1 on the DIGITAL INTERFACE BOARD in the correct position, following the instructions given in Figure A.
- 3) Use a suitable screwdriver to tighten the 4 screws that fix the MTA control panel to the welding machine.
- 4) Start the welding machine by pushing the switch on the rear panel to position I.

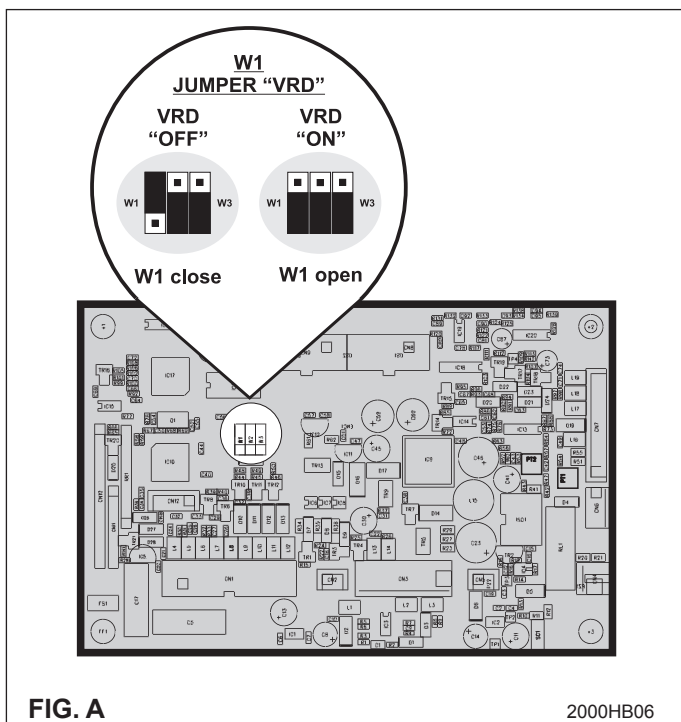

When the MTA control panel switches on the VRD LED will come on and will be GREEN, which means that the VRD function is on.

To “deactivate” the VRD device and therefore start to weld, follow this simple procedure: First touch the workpiece with the electrode, then detach it and ignite the arc within a MAX of 0,3 seconds, otherwise if this time is exceeded the VRD device starts and prevents welding.

During welding the VRD LED turns RED, which does not indicate any malfunction on the welding machine, but that the VRD device has been deactivated to allow welding.

Auxiliary functions

“Energy saving”

This function manages correct functioning of the cooling fan and cooling equipment that only run when strictly necessary, that is:

- **FAN MOTOR** - The fan is activated when:
 - During welding or for a certain period of time after this is finished.
 - When the thermostat intervenes or for a certain period of time after it has just been reset.
- **COOLING DEVICE** - The cooling device is activated:
 - For a few seconds when the machine switches on. This operation is used to make the cooling liquid circulate through the plant at the correct pressure. Call the technical service department if, when the cooling system is switched off, the error does not disappear from the DISPLAY (D).
 - During welding or for a certain period of time after this is finished.

Factory default

WARNING: This operation results in complete resetting of all parameters to the factory settings.

To reset the settings, you must:

- When the welding machine is off, push and hold the WELDING PROCESS SELECTION (T7) and WELDING MODE SELECTION (T9) keys down together.
- Switch on the welding machine and hold down the keys until the DISPLAY (D) reads 80.
- Release the two keys.
- The reset procedure has now been completed successfully.

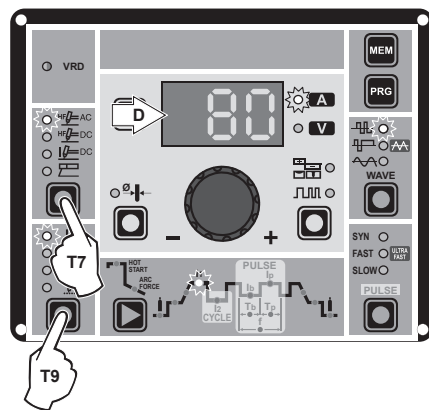

Error and protection conditions

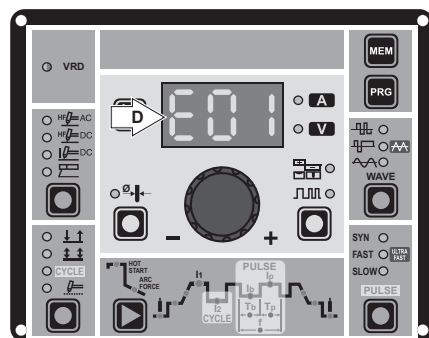

The equipment is protected against problems and if any arise the DISPLAY shows fixed or flashing (error code) messages (depending on the type of error) that serve to inform the operator that a fault has occurred in the equipment (see table 1).

The table provides a summary of all the error conditions that may arise on the equipment and, if possible, what the operator must do to attempt to resolve the problem.

Automatic reset error: once the alarm condition has been resolved the equipment starts working again and the operator can weld again!

PLEASE NOTE: If the fault persists look for the cause of the fault and contact our technical assistance department if necessary.

All of this is necessary to allow our technical assistance department (which must be contacted each time error messages appear on the equipment's operator interface) to resolve problems more easily, as quickly as possible and thanks to the user's reports, also because, in the meantime the machine will not allow the operator to do their work.

Table 1

Display	Diagnosis
E01	PRESSURE SWITCH This message appears when the cooling equipment is connected to the machine and its pressure switch does not close due to a lack of pressure in the hydraulic circuit. Automatic reset error.
E02	OVER VOLTAGE This message appears when the power supply voltage for the MATRIX 3000 AC/DC - AC/DC R exceeds 500V . If the fault persists look for the cause of the fault and contact our technical assistance department if necessary. Automatic reset error.
E03	UNDER VOLTAGE This message appears when the power supply voltage for the MATRIX 3000 AC/DC - AC/DC R drops below 280V . If the fault persists look for the cause of the fault and contact our technical assistance department if necessary. Automatic reset error.
t°C	THERMAL PROTECTION The welding stops due to an excessively high temperature (thermostat activated). Automatic reset error.

WARNING: The MATRIX 2200 AC/DC welding machine has a built-in electronic protective device to deal with fluctuations in mains voltage that switches the machine off automatically (voltage exceeding 300 V), without indicating any type of error or warning message for the operator. Subsequently it starts functioning again automatically when the voltage has dropped to below the value indicated above.



CEA COSTRUZIONI ELETTROMECCANICHE ANNETTONI S.p.A.

C.so E. Filiberto, 27 - 23900 LECCO - ITALY

Cas. Post. (P.O. BOX) 205

Tel. +39 0341 22322 - Fax +39 0341 422646

cea@ceaweld.com

www.ceaweld.com



ISO 9001: 2008

