



MAINTENANCE AND DESIGN OF STEEL ABUTMENT PILES IN IOWA BRIDGES



Final Report
Iowa Highway Research Board Project TR-622
September 2, 2014
WJE No. 2010.0738



Prepared for:
Iowa Department of Transportation
Office of Bridges and Structures
800 Lincoln Way
Ames, IA 50010



Prepared by:
Wiss, Janney, Elstner Associates, Inc.
330 Pfingsten Road
Northbrook, Illinois 60062
847.272.7400 tel | 847.291.4813 fax

Disclaimer

The contents of this report reflect the views of the authors, who are responsible for the facts and the accuracy of the information presented herein. The opinions, findings, and conclusions expressed in this publication are those of the authors and not necessarily those of the sponsors.

The sponsors assume no liability for the contents or use of the information contained in this document. This report does not constitute a standard, specification, or regulation. The sponsors do not endorse products or manufacturers. Trademarks or manufacturers' names appear in this report only because they are considered essential to the objectives of the document.

Statement of Non-Discrimination

Federal and state laws prohibit employment and/or public accommodation discrimination on the basis of age, color, creed, disability, gender identity, national origin, pregnancy, race, religion, sex, sexual orientation or veteran's status. If you believe you have been discriminated against, please contact the Iowa Civil Rights Commission at 800-457-4416 or Iowa Department of Transportation's affirmative action officer. If you need accommodations because of a disability to access the Iowa Department of Transportation's services, contact the agency's affirmative action officer at 800-262-0003.

Technical Report Documentation Page

1. Report No. TR-622	2. Government Accession No.	3. Recipient's Catalog No.	
4. Title and Subtitle Maintenance and Design of Steel Abutment Piles in Iowa Bridges		5. Report Date September 2, 2014	
		6. Performing Organization Code	
7. Author(s) Wade M. Clarke, P.E., S.E.; Paul D. Krauss, P.E.; John S. Lawler, P.E.		8. Performing Organization Report No.	
9. Performing Organization Name and Address Wiss, Janney, Elstner Associates, Inc. 330 Pfingsten Road Northbrook, IL 60062		10. Work Unit No. (TRAIS)	
		11. Contract or Grant No.	
12. Sponsoring Organization Name and Address Iowa Highway Research Board Iowa Department of Transportation 800 Lincoln Way Ames, IA 50010		13. Type of Report and Period Covered	
		14. Sponsoring Agency Code TR-622	
15. Supplementary Notes			
16. Abstract <p>Soil consolidation and erosion caused by roadway runoff have exposed the upper portions of steel piles at the abutments of numerous bridges, leaving them susceptible to accelerated corrosion rates due to the abundance of moisture, oxygen, and chlorides at these locations. This problem is compounded by the relative inaccessibility of abutment piles for close-up inspection and repair. The objective of this study was to provide bridge owners with recommendations for effective methods of addressing corrosion of steel abutment piles in existing and future bridges</p> <p>A review of available literature on the performance and protection of steel piles exposed to a variety of environments was performed. Eight potential coating systems for use in protecting existing and/or new piles were selected and subjected to accelerated corrosion conditions in the laboratory. Two surface preparation methods were evaluated in the field and three coating systems were installed on three piles at an existing bridge where abutment piles had been exposed by erosion. In addition, a passive cathodic protection (CP) system using sacrificial zinc anodes was tested in the laboratory. Several trial flowable mortar mixes were evaluated for use in conjunction with the CP system.</p> <p>For existing abutment piles, application of a protective coating system is a promising method of mitigating corrosion. Based on its excellent performance in accelerated corrosion conditions in the laboratory on steel test specimens with SSPC-SP3, -SP6, and -SP10 surface preparations, glass flake polyester is recommended for use on existing piles. An alternative is epoxy over organic zinc rich primer. Surface preparation of existing piles should include abrasive blast cleaning to SSPC-SP6. Although additional field testing is needed, based on the results of the laboratory testing, a passive CP system could provide an effective means of protecting piles in existing bridges when combined with a pumped mortar used to fill voids between the abutment footing and soil. The addition of a corrosion inhibitor to the mortar appears to be beneficial.</p> <p>For new construction, shop application of thermally sprayed aluminum or glass flake polyester to the upper portion of the piles is recommended.</p>			
17. Key Words —steel abutment piles, corrosion		18. Distribution Statement No restrictions.	
19. Security Classification (of this report) Unclassified.	20. Security Classification (of this page) Unclassified.	21. No. of Pages	22. Price NA



MAINTENANCE AND DESIGN OF STEEL ABUTMENT PILES IN IOWA BRIDGES

John S. Lawler
Project Associate

Paul D. Krauss
Project Advisor

Wade M. Clarke
Project Manager

Final Report
Iowa Highway Research Board Project TR-622
September 2, 2014
WJE No. 2010.0738



Prepared for:
Iowa Department of Transportation
Office of Bridges and Structures
800 Lincoln Way
Ames, IA 50010



Prepared by:
Wiss, Janney, Elstner Associates, Inc.
330 Pfingsten Road
Northbrook, Illinois 60062
847.272.7400 tel | 847.291.4813 fax

TABLE OF CONTENTS

Introduction..... 1
 Background..... 1
 Field Investigation of Abutment Piles in Iowa Bridges 1
 Problem Statement..... 3
 Project Objectives..... 3
 Scope of Work..... 3
 Literature Review..... 4
 Mechanisms of Pile Corrosion 4
 Buried Piles..... 4
 Exposed Piles 6
 Marine Piles 7
 Methods of Addressing Pile Corrosion 7
 Sacrificial Corrosion Allowance..... 7
 Barrier Coatings..... 8
 Galvanic Coatings..... 9
 Concrete Encasement..... 11
 Cathodic Protection..... 11
 Laboratory Testing of Coatings 12
 Field-Applied Coatings - Existing Piles 12
 Shop-Applied Coatings - New Piles..... 14
 Visual Evaluation 15
 Electrochemical Testing..... 16
 Findings of Laboratory Testing of Coatings 18
 Field Testing of Coatings..... 19
 Surface Preparation 19
 Coating Application 20
 Findings of Field Testing of Coatings 21
 Laboratory Testing of Cathodic Protection System 22
 Test Setup..... 22
 Selection of Flowable Mortars..... 24
 Electrochemical Testing..... 26
 Methods 26
 Testing Results..... 26
 Protection of Mortar-embedded Plates 28
 Post-Exposure Inspection of Steel Plates 28
 Findings of Laboratory Testing of Cathodic Protection System 30
 Recommendations..... 31
 Existing Bridges 31
 New Bridges..... 32
 Future Work 33
 Exposure of Field Coated Test Piles..... 33
 Installation of Shop Coated Piles..... 33
 Cathodic Protection Field Trial..... 33
 Evaluation of Runoff Diversion Methods..... 34
 Summary and Conclusions 34

Figures

Appendix A - Bibliography

Appendix B - Laboratory Testing of Coatings Photographic Log

MAINTENANCE AND DESIGN OF STEEL ABUTMENT PILES IN IOWA BRIDGES

INTRODUCTION

The Iowa Department of Transportation (Iowa DOT) has identified a need for the investigation of methods to address corrosion of steel piles supporting bridge abutments. Approaches for mitigating this problem in existing bridges and for limiting deterioration of abutment piles in future bridges were evaluated in this study.

BACKGROUND

Since their initial use in the early 1900's, driven steel piles have proven to be an economical and effective system for the support of bridge abutments and piers and consequently are used extensively throughout the nation's bridge inventory. Historically, many bridge owners and designers have not made provisions for corrosion protection of steel piles used in this application. This lack of corrosion protection has been based on the assumption that with little oxygen available, corrosion of the buried piles would occur at a very slow rate and could be ignored, or addressed by selecting a cross section of slightly greater area than that required to resist structural demands. During recent inspections and investigations, however, Iowa DOT has observed corrosion at upper portions of steel piles, where erosion and soil consolidation have created voids between the soil and the bottom of abutment footings. The presence of oxygen, moisture, and deicing salt laden water has accelerated the corrosion rates of piles at these locations. Other bridge owners have also observed this problem: five states responding to a late 1990's survey of state DOTs regarding problems associated with steel pile corrosion indicated that they had observed corrosion of exposed portions of steel piles directly below bridge abutments (Beavers and Durr 1998).

Field Investigation of Abutment Piles in Iowa Bridges

In 2006, as part of a project investigating problems at the ends of bridges, Iowa DOT requested that WJE examine and document the condition of steel abutment piles at twelve highway bridges at various locations around the state. In 2008, three additional bridges were included in the study. The purpose of the investigation was to determine the extent to which the steel abutment piles at the selected bridges had deteriorated, and to document the physical conditions at each abutment. The investigation was limited to the upper portions of the piles directly below the abutment footings, where corrosion had been observed at several bridges during previous Iowa DOT inspections.

A total of fifteen bridges were selected for examination. The bridges were constructed over a period of time ranging from 1934 to 1999. The abutments at fourteen of the bridges are supported on HP10x42 steel piles, and the abutments at one bridge are supported on HP12x53 piles. The bridges examined carry two to four traffic lanes supported by steel or pre-cast concrete girders. Twelve of the bridges were constructed with exposed soil embankments at the abutments, while the embankments of three bridges were protected with macadam stone.

At bridges with severe erosion and exposed piles, at least one of those piles was selected for evaluation. In several cases, a second, covered pile was also examined for purposes of comparison. At bridges with little erosion and no exposed piles, a single pile location was selected for excavation and examination. Where efforts had been made to control erosion and cover exposed piles the previously exposed piles were uncovered and examined. Excavation was primarily performed by hand digging. Each pile was

typically exposed to a depth of approximately 24 inches. Soil was removed from the surfaces of the web and flanges to expose all sides of the pile.

Site testing included measurement of soil resistivity, soil pH, chloride content, and sulfate content. The free-corrosion potential of the steel piles and the soil redox potential (Eh) were also measured. Thickness measurements were taken at one or two representative cross sections at each selected pile. Where piles were exposed by erosion, thickness was typically measured at cross sections above and below the existing grade line.

The study found that several of the bridge abutments exhibited severe erosion, caused by roadway runoff passing through transverse joints in the roadway or around the abutment wing walls. An example is shown in Figure 1. In many cases, after excavation of the more obvious exposed piles, it was evident that several inches of the upper portions of adjacent piles were also exposed. At several bridges, previous attempts to control and/or repair erosion were apparent. These included staked sheets of plywood installed to divert runoff (Figure 2), the use of soil to fill ditches caused by erosion and to cover exposed piles, and the use of pumped grout to fill the void under the abutment (Figure 3). Where soil fill was used, voids were observed under the abutments around the piles when the fill was removed from the face of the abutment concrete. The pumped grout was effective in filling voids and covering the previously exposed piles.

Corrosion of varying severity was observed at all of the piles that had been exposed by erosion or soil consolidation. Laminar corrosion, such as that shown in Figure 4, was commonly observed at exposed portions of piles. Pitting, shown in Figure 5, was evident to some degree at both exposed and covered piles. Typically, however, very little corrosion was observed at piles that were fully covered. An example of a covered pile after excavation is shown in Figure 6. Perforations caused by corrosion were observed in one exposed pile, as shown in Figure 7.

As expected, the most severe corrosion was observed in piles that were exposed by erosion caused by roadway runoff. These piles exhibited the greatest reduction in cross sectional area and the shortest expected remaining life. Corrosion was significantly more severe at pile segments that were located above the grade line, compared to portions that were covered with soil. High chloride contents, low soil resistivity and extensive section loss were observed at areas exhibiting severe runoff erosion. Areas that exhibited little runoff erosion typically had lower chloride content, higher resistivity, and little section loss. Several of the exposed piles were nearing or had reached a 50 percent reduction in cross sectional area. Average rates of cross sectional area loss for portions of piles exposed to the atmosphere ranged from approximately 0.3 percent/year to 1.4 percent/year. The most severe section loss corresponded to an average thickness loss rate of approximately 4 mils/year for each face of the pile flanges at the measured cross section. Averaged section loss rates for the excavated below-grade portions of exposed piles ranged from less than 0.1 percent to approximately 0.8 percent/year. Soil-covered piles, even those situated in soils with relatively low resistivity and high chloride content, exhibited little corrosion, presumably due to a limited supply of oxygen. The expected remaining life of all of the fully soil-covered piles was greater than 50 years. Section loss rates for soil-covered piles were typically less than 0.1 percent/year.

Soil pH did not appear to be a factor contributing to the corrosion of any of the examined piles. In addition, the combination of low levels of sulfate content and relatively aerobic conditions indicated by the redox potential (Eh) measurements suggest that microbial-induced corrosion did not play a significant role in determining site corrosivity. Steel free-corrosion potential measurements indicated that all of the

piles were subject to some degree of corrosion. The correlation between potential and observed section loss was not as strong, however, as that observed between resistivity and section loss.

The greatest factor contributing to corrosion of the examined piles was roadway runoff, causing erosion and exposure to oxygen and introducing moisture and chlorides to the sites. Where piles remained covered with soil, corrosion was observed to occur slowly.

The effects of possible corrosion at depths greater than the top few feet of the piles were beyond the scope of the 2006 investigation. Nevertheless, several methods assessed in the current study for protecting against the predominantly atmospheric corrosion at the tops of the abutment piles will also be effective for mitigating corrosion in the buried portion of piles located in corrosive soil environments, as is discussed further in the Recommendations section of this report.

PROBLEM STATEMENT

Soil consolidation and erosion caused by roadway runoff have exposed the upper portions of steel piles at the abutments of numerous bridges in Iowa and elsewhere. The exposed portions of the piles are susceptible to accelerated corrosion rates due to the abundance of moisture, oxygen, and chlorides at these locations. Severe corrosion, if not addressed, has the potential to reduce the capacities of the piles to an extent that they can no longer support abutment reactions, a serious problem that would be difficult and costly to address. This problem is compounded by the relative inaccessibility of abutment piles for close-up inspection and repair. Bridge owners would benefit from effective methods of addressing corrosion of steel abutment piles with which they could extend the service lives of existing and future bridges.

Project Objectives

The objectives of this project are summarized as follows:

- Identify effective methods of addressing the problem of pile corrosion in existing bridges.
- Identify an effective strategy to limit steel pile corrosion in new bridges in the future.

Scope of Work

The objectives of the project were accomplished through completion of the following tasks:

1. **Literature Review:** A review of available literature on the performance and protection of steel piles and buried steel structures was performed.
2. **Laboratory Testing of Coatings:** Eight potential coating systems for use in protecting existing and/or new piles were selected and subjected to accelerated corrosion conditions in the laboratory.
3. **Field Testing of Coatings:** Based on the results of the laboratory tests, coatings were selected for trial application in the field. Two surface preparation methods were evaluated and three coating systems were installed on three piles at an existing bridge where abutment piles had been exposed by erosion. Coatings were also selected for trial installation on new bridge piles, to be coordinated with a future IaDOT bridge construction project.
4. **Laboratory Testing of Cathodic Protection System:** A passive cathodic protection (CP) system using sacrificial zinc anodes was tested in the laboratory. In addition, several trial flowable mortar mixes were evaluated. The mortar allows conduction of ions from the CP system anode to

the exposed (above-ground) portion of a pile to mitigate corrosion. Results of the laboratory tests can be used to develop a trial CP and mortar system for installation on an existing bridge.

5. **Summary Report:** This report was prepared to summarize the findings of the literature review, laboratory testing, and field testing. Consistent with the project objectives, this report focuses on effective methods of addressing corrosion of piles in existing bridges, and strategies for limiting pile corrosion in new bridges in the future.

LITERATURE REVIEW

To aid in our evaluation of methods of addressing pile corrosion, WJE reviewed available research on the topic. While the primary focus of the current study is to address the predominantly atmospheric corrosion of the exposed portions of piles, the reviewed literature included discussions of the mechanisms of corrosion of buried steel structures, marine piles, and steel structures exposed to the atmosphere. Investigations of various means of addressing corrosion of piles in these environments were also reviewed. These methods included sacrificial corrosion allowance, application of protective coatings or concrete encasement, and cathodic protection.

Mechanisms of Pile Corrosion

Buried Piles

Much of the available research on steel piles focuses on corrosion in soil. Buried steel piles corrode by means of an electrochemical reaction wherein a current flows through an electrolyte (the soil and pore moisture) from the anode region of a pile to the cathode region, with the steel pile completing the circuit. The anode region has a more negative potential, and is subject to corrosion, while the cathode is protected from corrosion. Numerous factors affect this electrochemical reaction, including soil oxygen content, moisture content, pH, resistivity, and soluble salt content (Beavers and Durr 1998).

For corrosion to occur, oxygen is needed to support the cathodic reduction reaction, the necessary counterpart to the anodic oxidation reaction where corrosion products (rust) develop. Corrosion of buried steel therefore occurs primarily in the vicinity of aerobic (oxygen-rich) conditions, which usually only exist above the lowest design ground water level. The maximum dissolved oxygen content in an aqueous phase is only 8.0×10^{-4} percent (8 ppm) at 77°F [25°C]) compared with 20% (200,000 ppm) in the atmosphere (NACE International December 2001). If the piles are continuously submerged, corrosion loss should be small.

In disturbed soils, the soil matrix has been modified by digging, backfilling, upheaval, or erosion, resulting in an increase in the availability of oxygen and consequently an increase in the probability of corrosion. Disturbed soils containing man-made products such as slag, ash or cinders, can be particularly corrosive. Undisturbed soils are generally oxygen deficient by comparison. Early research by the National Bureau of Standards (NBS) and recent research are consistent in finding that corrosion is generally minimal when steel is below the water table and in undisturbed soils even when soils are corrosive (M. Romanoff 1962) (M. Romanoff 1957) (Beavers and Durr 1998). Romanoff (1962) concludes "It was observed that soil environments which are severely corrosive to iron and steel buried under disturbed conditions in excavated trenches were not corrosive to steel pilings driven in undisturbed soil. The difference in corrosion is attributed to the differences in oxygen concentration. The data indicate that undisturbed soils are so deficient in oxygen at levels a few feet below ground line or below the water table zone, that steel pilings are not appreciably affected by corrosion regardless of the soil

types or the soil properties.” Though piles are generally not affected by corrosion in undisturbed soils, a majority of steel piles pass through an upper layer of disturbed soils (Beavers and Durr 1998).

Variability in soil oxygen content adds to the aggressiveness of a buried environment and produces *differential aeration cells*. Macrocell differential aeration cells are the most common form of severe corrosion for steel piles in soils. Stratification of soils creates an environment for differential aeration cells; for example, steel areas in oxygen deficient layers such as wet clays or below the water table, become anodes while areas in oxygen-rich layers such as porous sands become cathodes. Further, as corrosion current flows, the electrochemical reactions create local environments that can exacerbate the attack. The reduction reactions cause an increase in pH at the cathode, promoting the formation of tenacious protective passive films on the steel. However, hydrolysis of the iron at the anode creates hydrogen ions that reduce the pH in the vicinity of the anode, and this acidic environment destabilizes any oxide films and increases the rate of attack (NACE International, December 2001). Factors affecting this form of corrosion include the relative area ratio of the anode to cathode and the stratification of the soil. Large cathodic and small anodic areas promote the highest rate of corrosion.

In locations where sufficient oxygen is present to promote corrosion, corrosion rates are dependent on several soil characteristics. These include soil resistivity, a measure of the soil’s ability carry electrical current. When the soil resistivity is low, corrosion rates are increased due to the highly conductive soil path. Resistivity provides an indication of the presence of soluble salts such as chlorides. Typical guidelines linking soil corrosiveness to soil resistivity, taken from Peabody’s *Control of Pipeline Corrosion*, indicate that soils with resistivities between 0 and 500 Ω -cm are very corrosive, while soils with resistivities from 2,000 to 10,000 Ω -cm are mildly corrosive.

Increased corrosion rates are also observed in low pH environments, where the protective passive films on the steel are destabilized. Both sulfate and chloride ions in the soil will lower the resistivity of the soil. Chlorides will also promote the breakdown of the passive film, while sulfates may contribute to corrosion by encouraging the growth of sulfate reducing bacteria, which can generate highly corrosive byproducts. The California Department of Transportation (Caltrans) uses the following limits for determining if the soils at a site are corrosive: chloride concentration is 500 ppm or greater, sulfate concentration is 2000 ppm or greater, or the pH is 5.5 or less (Caltrans 2012).

Correlations between general corrosiveness of soils and two types of potential measurements have been established in the literature: the structure-to-soil potential of the underground steel structure in the absence of cathodic protection (free corrosion potential) and the soil redox potential (Eh). The structure-to-soil potential is measured by placing a copper-copper sulfate reference electrode (CSE) in the ground over the structure and measuring the voltage difference between the structure and the reference electrode using a high impedance voltmeter. The soil redox potential (Eh) is measured in a similar fashion, but a platinum electrode, instead of the steel structure, is measured. The platinum electrode is placed in the soil stratum of interest and the reference electrode is placed on the ground surface. The Eh is a measure of the oxidizing or reducing conditions in the soil. When conditions in the soil are oxidizing (aerobic) the value is more positive than when conditions in the soil are reducing (anaerobic). In unsaturated soil, aerobic conditions prevail and the Eh values tend to be more positive (NACE International December 2001). Soil redox potential can be used as an indicator of the presence of sulfate-reducing bacteria, along with the sulfate content of the soil. Anaerobic conditions favor the activity of sulfate-reducing bacteria. In this case corrosion can occur even when oxygen is not readily available (Beavers and Durr 1998).

In summary, to gain a comprehensive understanding of the potential for corrosion of buried piles at a given site, soil type and strata as well as the location of the low water table level relative to the pile elevations should be considered. Field measurements of soil resistivity and pH, laboratory analysis of soils for sulfate and chloride content, free-corrosion potential measurements of the steel piles, and soil redox potential measurements can be performed. Due to the complex interaction of these factors, it is difficult to reliably calculate an actual corrosion rate for steel piles at a given site. However, estimates of the potential for corrosion can be made by comparing site conditions with those for which piles have been unearthed and corrosion rates determined and documented (Caltrans 2012).

In a 2008 study (Decker March 2008) completed on 20 abandoned piles installed in the early 1970s in Utah, piles were found to typically average between 2 and 9 $\mu\text{m}/\text{year}$ (0.08 to 0.35 mil/year) in section loss after 34 to 38 years of exposure. Thickness loss was found to be most critical within the groundwater fluctuation zone. For abutment piles, where high chloride concentrations were found in the surrounding soils, the average pile corrosion rate increased to 13 $\mu\text{m}/\text{year}$ (0.51 mil/year) within the embankment and to a maximum corrosion rate of 48 $\mu\text{m}/\text{year}$ (1.9 mil/year) in the underlying undisturbed soil. This differential rate of section loss is indicative of macrocell corrosion.

Additional documented corrosion rates of unearthed piles in various soil conditions are summarized in NCHRP Report 408 (Beavers and Durr 1998). Corrosion rates provided in Report 408 averaged from 0 mil/year for piles below the water table to 4.4 mil/year for piles in slag and cinder fill at or near the water table.

Exposed Piles

Unlike piles that are completely buried in soil, steel piles that are exposed to the atmosphere, such as those that have been uncovered by erosion or soil consolidation, are in an environment with ample available oxygen. Corrosion in the exposed portion of these piles is therefore dependent on the availability of an electrolyte. Moisture from humidity, rainwater, adjacent soils, and runoff can provide this electrolyte. As previously discussed, the presence of chlorides greatly accelerates corrosion rates. Corrosion rate is also affected by average temperature and temperature variations (Coburn 1978, 717-723).

Corrosion rates can be very slow for steel left exposed in arid, rural environments, where few airborne pollutants are present and little moisture is available. By contrast, corrosion rates of exposed steel can be quite rapid in marine environments, where ample moisture is present and chlorides are abundant. For example, in a study comparing average 2-year corrosion rates of steel specimens exposed in various environments, specimens in Phoenix Arizona, classified as a rural arid environment, exhibited an average corrosion rate of 0.18 mils/year. A higher moisture rural exposure, State College, Pennsylvania, resulted in a corrosion rate of 0.90 mils/year. Corrosion rates for specimens exposed in marine environments varied with distance from the ocean. Exposure 800 feet from the ocean in Kure Beach, North Carolina produced an average corrosion rate of 5.8 mils/year, while exposure directly on the beach at Cape Canaveral, Florida produced a corrosion rate of 42 mils/year (Coburn 1978, 717-723).

At bridge abutments, the upper portions of piles are frequently wetted by runoff and seepage, and runoff is commonly laden with deicing salts. Adjacent soils and ponding in the depressions that often form due to consolidation of the disturbed soils at the tops of driven piles keep moisture levels high and prevent drying. The worst case average corrosion rate of approximately 4 mils/year measured during WJE's 2006 study is comparable to that observed in a mild marine exposure. Note that this corrosion rate is the

average over the life of the bridge, and does not take into consideration the time required for erosion, soil consolidation, and pile exposure to occur, indicating that average corrosion rate after exposure was likely greater than this value. The moist, chloride and oxygen rich environment to which exposed abutment piles are subjected has the potential to lead to relatively rapid atmospheric corrosion.

Marine Piles

Steel piles used in marine applications are subjected to a severe corrosion environment. This environment consists of several zones of exposure, in which the previously discussed mechanisms of corrosion experienced by buried and exposed piles act. These zones include an embedded zone, where the pile is surrounded by soil below the mud line; an erosion zone, where pile surfaces are abraded by soil particles lifted by the movement of the water; a submerged zone where the pile is continuously submerged in seawater; a tidal zone, where the pile is alternately immersed in seawater and exposed to the atmosphere; a splash zone, where the pile is exposed to the atmosphere and frequently wetted by large droplets of seawater; and an atmospheric zone, where the pile is exposed to a marine atmosphere, but not frequently splashed by waves (Escalante 1977) (Davis 2000).

NBS Monograph 158 *Corrosion and Protection of Steel Piles in a Natural Seawater Environment* (Escalante 1977) presents the average corrosion rates of uncoated ASTM A36 steel piles used as control specimens in a study of corrosion protection methods for marine piles. These piles exhibited the greatest corrosion rates in the erosion zone (approximately 9 mils/year), and above the mean high water line in the splash and atmospheric zones (approximately 8 to 12 mils/year). Corrosion rates in the submerged zone (4 to 8 mils/year) were lower, as were those in the embedded zone (1 to 2 mils/year). Due to the severe environment to which they are exposed, unlike buried piles, marine piles are typically protected from corrosion. A substantial amount of research on the effectiveness of various protection methods has been conducted. As previously discussed, the exposed abutment pile environment has much in common with a marine atmospheric exposure. Therefore, several of these studies were reviewed during WJE's selection of coatings to be evaluated for application to abutment piles.

Methods of Addressing Pile Corrosion

A common method of addressing corrosion of buried steel piles is to simply allow the piles to corrode, while providing additional sacrificial steel material such that adequate material remains to provide the needed capacity over the service life of the supported structure. Other types of buried steel structures, such as pipelines, corrugated steel culverts, reinforcement for mechanically stabilized earth structures, and marine piles, are typically protected against corrosion. A variety of protection methods for these structures have been used and studied. Barrier coatings isolate the steel from the corrosive environment, disrupting the electrolytic pathways. Galvanic coatings provide a layer of a more active metal over the steel substrate. As a result, the steel becomes the cathode in the corrosion cell. Concrete encasement provides a barrier to chlorides and its high pH encourages the formation of a passive protective film that slows corrosion. Cathodic protection overrides the basic corrosion cell by providing anodic current, making the structure to be protected a cathode, where no metal consumption occurs.

Sacrificial Corrosion Allowance

Sacrificial corrosion allowance is an additional thickness of metal beyond that required structurally, provided to account for section loss over the service life of the pile. The quantity of sacrificial metal to add for a particular situation depends on the corrosion rate and design life for the pile. For example, Caltrans recommends a material loss rate of 1 mil/year for steel piling exposed to corrosive soil and/or

water, 4 mils/year for piles in the immersed zone, and 5 mils/year for piles in the scour zone (Caltrans 2012). These rates apply to each exposed surface of the pile, i.e. each face of a pile flange or web. Multiplying the corrosion rate by design life provides an estimated loss of material to each surface exposed to soil. If a site is characterized as noncorrosive, then Caltrans recommends no sacrificial metal be added. Note that the corrosion rates recommended by Caltrans for piles in soil are lower than the upper range of values reported in NCHRP Report 408 (4.4 mils/year maximum).

Although sacrificial corrosion allowance could be used to address corrosion of the exposed portion of abutment piles in new bridges, corrosion rates at these locations are extremely variable and can be severe, as observed in WJE's 2006 study. The worst case average corrosion rate of approximately 4 mils/year found in WJE's study is substantially greater than the rate recommended by Caltrans for piles embedded in corrosive soil, and comparable to that for piles submerged in corrosive water. For purposes of comparison, assuming a 75-year design life and using the Caltrans recommendation of 1 mil/year for each surface of a buried pile, a 0.15 inch sacrificial thickness would be required. Assuming a 4 mil/year corrosion rate for an exposed abutment pile, a 0.6 inch sacrificial thickness would be required. This sacrificial thickness is greater than the 0.42 inch thickness of the HP10x42 piles commonly used in Iowa bridges. This suggests that use of sacrificial coating allowance may not be a practical solution for new abutment piles, unless combined with corrosion protection.

Barrier Coatings

Numerous coatings have been applied to buried steel structures to protect them from corrosion. Common barrier protection methods used on buried pipelines include coal tar enamels and epoxies, urethanes, fusion bonded epoxy, polyethylene tapes, and extruded polyolefin wraps (Peabody 2001). These coatings are typically mill-applied. Bituminous mastic products are also available for field application at pipe joints and for coating repairs, often in combination with a protective wrap. In pipelines, where localized pitting at locations of coating failure can lead to pipe leaks, coatings are typically used in combination with cathodic protection. While tapes and extrusions are not practical for application to an H-pile, the fusion bonded epoxy and liquid coatings used on pipelines were considered as possible coatings for abutment piles.

Fusion bonded epoxy and extruded polymeric barrier coatings have also been used as corrosion protection for steel reinforcement of mechanically stabilized earth structures (MSE), often in combination with galvanizing and/or sacrificial corrosion allowance. An estimate of the duration of protection provided by an 18-mil fusion bonded epoxy coating in this application, where fill material is free draining and carefully controlled, is 16 years (Elias 2009). Designers provide an additional sacrificial steel thickness to provide adequate cross section for the remaining service life of the structure.

An even greater variety of barrier coatings are used to protect steel exposed to the atmosphere. A useful reference that compares the expected service life of a number of coating and surface preparation combinations in a variety of exposures is "Expected Service Life and Cost Considerations for Maintenance and New Construction Protective Coating Work" (Helsel 2008). This document presents the "Practical" service life for various coatings, or the time until 5 to 10 percent coating breakdown occurs and active corrosion of the substrate is present. WJE reviewed the estimated service lives of various coating systems in marine atmospheric exposures. The service lives of some of the better performing coatings are reproduced in Table 1.

Table 1. Estimated Service Lives of Barrier Coating Systems in Marine Exposures (Helsel 2008)

Coating	Thickness (mils)	Surface Preparation	Service Life (years)
Surface Tolerant Epoxy	10	Hand/Power Tool	9
Surface Tolerant Epoxy	10	Blast	12
Coal Tar Epoxy	16	Blast	14
Organic Zinc Epoxy/Epoxy	11	Blast	15
Inorganic Zinc/Epoxy	11	Blast	17

Marine piles are subjected to embedded, immersed, and severe atmospheric exposures. Barrier coatings that perform well in the embedded and atmospheric exposure zones of a marine pile would likely perform well on an abutment pile. NBS Monograph 158 presents the results of a study comparing the performance of a number of coating systems used on marine piles immersed in seawater for six years. This study found “the coal tar epoxies on the H-piles have deteriorated considerably in the atmospheric zone with resulting metal losses averaging 2.3 mils per year. Below the waterline the loss has been minimal and on the order of 0.25 mils per year.” Another coating that was tested in the study, polyester glass flake, exhibited better performance: “Flange thickness measurements were not made for two reasons. First, coating breakdown was so minimal that little would be gained by removing the coating for examination. Secondly, and equally important, it was very difficult to remove the polyester glass flake by sandblasting...Even in the atmospheric and splash zones little damage developed.” The estimated corrosion rate for the pile protected by this coating was less than 0.1 mils per year.

Another study (Kumar 2006) compares the performance of coatings of marine piles after 33 years of exposure. The authors report: “The maximum corrosion rate was found to be 0.1 mm/side/year [3.93 mil/side/year] to 0.07 mm/side/year [2.76 mil/side/year] in the splash zone and immersed zone, respectively for the coal tar epoxy coating. The maximum corrosion rate was found to be 0.019 mm/side/year [0.748 mil/side/year] for the polyester glass flake coating.” Various other epoxies, vinyls, and polyurethanes over zinc rich primers were also evaluated in the study after 5, 10, and 20 years of exposure, but did not perform as well as the polyester glass flake coating.

Galvanic Coatings

Of the various galvanic coatings applied to steel, zinc hot dip galvanizing is used most frequently. This coating involves dipping the steel part in cleaning and molten zinc baths, producing a series of anodic zinc-iron alloy layers that are metallurgically bonded to the steel. Corrugated steel culverts and reinforcement for mechanically stabilized earth structures are buried elements that commonly galvanized for corrosion protection. Estimates of corrosion rates of zinc and galvanized steel in soil are provided in several publications for use in durability design of these types of structures. FHWA-NHI-09-087 (Elias 2009), addressing steel reinforcing of MSE structures, provides the following estimates of corrosion rates for zinc and steel in carefully controlled fill soils: zinc, first 2 years - 0.58 mil/side/year; zinc, thereafter until depletion - 0.16 mil/side/year; steel - 0.47 mil/side/year. Similar corrosion rates are given in standards for corrugated steel culvert design (AS/NZS2041.1:2011 2011).

A typical H-pile would be hot dip galvanized per ASTM A123 to Grade 100, which would provide a zinc coating thickness of 3.9 mils. Based on the preceding corrosion rates, a 4-mil thickness of zinc coating could be expected to last approximately 18 years in a moderately corrosive soil (resistivity greater than 3000 ohm-cm and chloride content less than 100 ppm). It should be noted that only seven soil samples of over thirty samples tested, removed from around piles during WJE’s 2006 study, exhibited chloride content less than 100 ppm. The chloride contents of the remaining samples ranged from 290 ppm to over 14000 ppm, with chloride contents over 1000 ppm being common. This suggests that an 18 year zinc coating life projection may be optimistic for typical abutment conditions. For a temperate marine atmospheric exposure, the “User’s Guide to Hot Dip Galvanizing” (NACE 1983) suggests an expected life of greater than 40 years for hot dip galvanizing with a 4 mil zinc thickness.

NCHRP Synthesis 254: *Service Life of Drainage Pipe* (Gabriel 1998) discusses aluminizing of corrugated steel pile, a process wherein steel is dipped into molten aluminum to provide a bonding layer of aluminum-iron alloy between the steel and aluminum layers. The aluminum layer oxidizes, providing a passive protective coating. Synthesis 254 reports several studies that found that aluminized pipe performed more than 2 times better than galvanized pipe in terms of service life in various conditions.

Another form of applying metallic protective coatings to steel is metallizing, in which zinc, aluminum, or a combination thereof are thermally sprayed onto the steel substrate, with wire-arc spray being the most common application method. The advantages of these coatings relative to other common pile coatings are summarized in NCHRP Report 528: *Thermally Sprayed Metal Coatings to Protect Steel Pileings* (Ellor 2004): “TSMC’s offer advantages in generally higher mechanical damage resistance, low self-corrosion rates, and the ability to provide steel corrosion control via cathodic protection at coating defects.” Because of their porous nature, thermally sprayed coatings are often used in conjunction with a thin sealer to extend service life in severe exposures. Practical service life estimates, reproduced from Helsel (Helsel 2008), for zinc metallizing systems are provided in Table 2:

Table 2. Estimated Service Lives of Zinc Metallizing Systems in Marine Exposures (Helsel 2008)

Metallizing System	Thickness (mils)	Surface Preparation	Service Life (years) Marine Atmospheric	Service Life (years) Saltwater Immersion
Zinc Metallizing	5	Blast	16	-
Zinc Metallizing/Sealer	9	Blast	18	15
Zinc Metallizing/Sealer/Epoxy or Polyurethane	13	Blast	22	18

Zinc is more electrochemically active than aluminum, and provides a greater degree of cathodic protection to steel. However, it is consumed more rapidly than aluminum when exposed to saltwater. NCHRP Report 528 recommends aluminum or 85:15 percent weight zinc-aluminum alloy for marine atmospheric exposure, and aluminum for seawater immersion or alternate wet-dry exposure to seawater. Results of testing conducted as part of that study suggest that abrasion and impact resistance performance of thermally applied metallic coatings is improved by a sealer coat.

Piles coated with thermally sprayed aluminum, thermally sprayed zinc and hot dip galvanized zinc were evaluated in the previously discussed studies of protective coatings for marine piles (Escalante 1977) (Kumar 2006). After six years of exposure, the NBS Monograph 158 study reports overall average pile corrosion rates of 0.03 mil/year, 0.10 mil/year, 0.14 mil/year, and 0.16 mil/year for sealed thermally sprayed aluminum, sealed thermally sprayed zinc, hot dip galvanized, and thermally sprayed aluminum with no sealer, respectively. According to Kumar (Kumar 2006), of the coating systems tested, thermally sprayed aluminum with a sealer provided the best protection to marine piles exposed for 20 years at Buzzard's Bay, Massachusetts (thermally sprayed zinc and hot dip galvanizing were not evaluated in that study). Unsealed thermally sprayed aluminum also performed well. Thermally sprayed aluminum did not perform as well as the polyester glass flake coating in the warmer waters of the study's La Costa, Florida test site.

Due to the difficult site conditions, neither zinc nor aluminum metallizing are suitable for application to existing abutment piles. NCHRP Report 528 states: "Thermal spraying should never be selected for applications in which it is not possible to provide the highest quality surface preparation." In addition, the application process is extremely sensitive to conditions that are difficult to control in the field, such as humidity and surface moisture. These coatings were, however, considered as possible coatings for shop application to new piles, along with hot dip galvanizing.

Concrete Encasement

Concrete encasement is frequently used to provide protection to steel marine piles in the tidal and splash zones. The concrete slows the migration of chlorides to the embedded steel, and the high pH in the portland cement matrix provides passive chemical protection to slow corrosion. Jacketing with concrete after surface preparation is a common repair method for marine piles exhibiting corrosion deterioration (Gerwick 2007).

Cathodic Protection

In a passive cathodic protection system, an anode made from a metal (e.g., zinc) that will corrode more readily than the metal (e.g., steel pile) being protected is introduced into the corrosion system. This anode corrodes and is consumed to provide the protective current to the cathode metal. This takes advantage of a naturally occurring reaction between dissimilar metals. In an impressed current cathodic protection system, an external power source is used to provide the protective current to the metal. Due to its monitoring, maintenance, and power requirements, an impressed current system was determined to be impractical for widespread application to bridge abutment piles. The current study therefore focused on passive cathodic protection systems as a possible means of corrosion protection.

For a cathodic protection system to be effective, the protected structure must be surrounded by an electrolyte that completes the circuit. This is a major limitation of the use of cathodic protection systems on abutment piles, as they would not protect exposed portions of piles in the areas where corrosion has been observed to be most severe. As a possible means of addressing this issue, a variety of conductive mortar mixes were evaluated for use in filling voids between the abutment footing and the soil and in encapsulating portions of piles exposed by erosion, thereby facilitating cathodic protection of these areas.

Another disadvantage of a passive cathodic protection system is its relative inefficiency in protecting large uncoated structures. Galvanic anodes are typically used in combination with coatings to protect submerged portions of marine piles and to mitigate corrosion in pipelines. Coatings provide a substantial reduction in the current flow required of the cathodic protection system (Peabody 2001). According to

Peabody, “galvanic anodes are generally used in cases where small amounts of current are required (typically less than 1A) and areas where soil resistivity is low enough (typically less than 10,000 ohm-cm) to permit obtaining the desired current with a reasonable number of anodes.” Often, galvanic anodes are installed at isolated locations where repairs have been made, or coatings have been damaged or are incomplete. Peabody writes: “Typically, with anodes spaced 1 foot from the pipe, protection could be expected for 4 to 5 feet if using zinc anodes and 8 to 10 feet if using magnesium anodes.” Based on site conditions, the number and location of anodes can be varied to provide an optimum level of protection to the greatest area of the structure. A reasonable number of anodes installed close to the abutments, and near the surface, could therefore be expected to protect the upper portions of abutment piles, where the probability of corrosion is greatest.

LABORATORY TESTING OF COATINGS

In order to evaluate coatings for application to the upper portions of steel piles, WJE performed cyclic saltwater immersion testing on coated steel coupons. Eight potential coatings for application to existing piles in the field and/or to new piles in the shop were tested in accelerated corrosion conditions.

Field-Applied Coatings - Existing Piles

In order to evaluate coatings to be applied to existing piles in the field, panels measuring 1/4 inch x 2 inch x 4 inch were cut from ASTM A36 steel plate material that exhibited corrosion equivalent to a severe SSPC Rust Grade D (steel surface completely covered with rust, pitting visible). Figure 8 shows the steel plate material prior to surface preparation. This plate material was corroded by exposure to salt spray for several hundred hours followed by exposure to a natural outdoor environment, for a number of years.

Test panels were prepared to three different SSPC surface preparation standards: SP3 Power Tool Cleaning, SP6 Commercial Blast Cleaning, and SP10 Near-White Blast Cleaning. The SP3 surface preparation requires removal of all loose corrosion product. This surface preparation was performed with a pneumatic needle scaler. The SP6 and SP10 preparations were performed using dry abrasive blast cleaning with G40 steel grit. The SP6 standard requires that all corrosion products be removed from 2/3 of the surface, with only minor discolorations caused by rust present in the remaining 1/3. The SP10 standard requires that staining be limited to no more than 5 percent of the area. Test panels prepared to these three specifications are shown in Figure 9, Figure 10, and Figure 11, respectively. Surface preparation of all test panels and coating of the majority of the test panels was performed by Corrosion Control Consultants and Laboratories, Inc.

The following potential field- or shop-applied coatings were each applied to three SSPC SP-3 prepared panels, three SSPC SP-6 prepared panels, and two SSPC SP-10 prepared panels:

- **Bituminous Mastic (BM): *Royston R28 Rubberized Mastic*.** Bituminous mastic is used as a field coating for buried steel pipelines. It can be applied in relatively thick, uniform coats with a brush and does not require mixing of components. In addition, it was initially anticipated that the coating would be tolerant of marginally prepared surfaces. These characteristics made the coating a promising candidate for field application to existing piles, where it was anticipated that difficult, confined working conditions might limit the use of spray application equipment and hinder surface preparation efforts. Figure 12 shows several test panels coated with bituminous mastic. This coating was applied to the panels by WJE personnel in two coats, using a brush. Coating thicknesses ranged from 8 mils to 11 mils, with an average measured thickness of 9 mils.

- **Non-Shrink Grout (GR): *Masterflow 928*.** During our initial field investigation of abutment piles, WJE exposed a pile that was encapsulated by mortar at a location where mortar had been pumped into a void between the abutment footing and the eroded embankment soil. Minimal corrosion and section loss were observed at this pile, indicating that grout encapsulation may be an effective method of protection of existing piles. In addition, concrete jackets are often used as a repair for corroded marine piles. Figure 13 shows test panels during grout encapsulation, performed by WJE personnel. The size of grout specimens was limited by the capacity of the dipping mechanism. The grout was poured into 3-inch diameter by 6-inch deep cylinders, with the steel panels centered at the tops of the cylinders. This configuration provided cover of approximately 1 3/8 inch at the center of the panels, decreasing to 3/8 inch at panel edges.
- **Glass Flake Polyester (PG): *Corrocoat Polyglass Zipcoat*.** Previous research on marine pile coatings has shown this material to be an effective coating in tidal, splash, and atmospheric zones. In addition, the coating is frequently used in the splash zone of offshore oil platforms, where resistance to abrasion damage is an additional concern. Its high abrasion and impact resistance suggests that the coating would withstand damage during driving. A test panel coated with glass flake polyester is shown in Figure 14. Spray application equipment was used to apply the glass flake polyester in one coat, as shown in Figure 15. Coating thicknesses ranged from 18 mils to 24 mils, with an average measured thickness of 22 mils.
- **Surface Tolerant Phenalkamine Epoxy (ST): *Carbomastic 615 HS*.** Due to the potential for less than ideal surface preparations in the field, WJE chose to evaluate a surface tolerant epoxy. A test panel coated with this epoxy is shown in Figure 14. This coating was spray applied in a single coat. Coating thicknesses ranged from 8 mils to 9 mils, with an average measured thickness of 8 mils.
- **Cycloaliphatic Amine Epoxy over Organic Zinc Rich Epoxy (OZ): *Carboguard 890* and *Carbozinc 859*.** Although previous research has shown inorganic zinc primers to perform slightly better in saltwater environments, due to the difficulty of providing the near white blasted steel surface necessary for application of inorganic zinc primers in the field, an organic zinc rich primer was chosen because it is more tolerant of poorly prepared substrates. This coating system, shown in Figure 14, was spray applied in two coats, one for each coating. Zinc rich epoxy coating thicknesses ranged from 3 mils to 7 mils, with an average measured thickness of 5 mils. Top coat thicknesses ranged from 8 mils to 11 mils, with an average measured thickness of 10 mils.

Due to the extensive pitting of the pre-corroded test panels, coating dry film thicknesses were measured on smooth steel blanks that were coated simultaneously with the actual test panels. The coatings and surface preparations for the field-applied coating test panels are summarized in Table 3. Note that several of these coatings, including grout (or concrete) encapsulation, glass flake polyester, and epoxy over organic zinc rich primer are appropriate for shop application on new piles as well as field application on existing piles.

Table 3. Sample Identifiers for Coatings and Surface Preparations for Possible Field Application

Coating	Abbreviation	SSPC-SP10	SSPC-SP6	SSPC-SP3	Total
Bituminous Mastic	BM	BM10A & B	BM6A, B & C	BM3A, B & C	8
Grout	GR	GR10A & B	GR6A, B & C	GR3A, B & C	8
Glass Flake Polyester	PG	PG10A & B	PG6A, B & C	PG3A, B & C	8
Surface Tolerant Epoxy	ST	ST10A & B	ST6A, B & C	ST3A, B & C	8
Epoxy over Organic Zinc Rich	OZ	OZ10A & B	OZ6A, B & C	OZ3A, B & C	8
Total		12	18	18	48

Shop-Applied Coatings - New Piles

In order to evaluate potential coatings to be applied to new piles in the shop, 1/4 inch x 2 inch x 4 inch panels were cut from new ASTM A36 plate material that exhibited no corrosion. These panels were then dry abrasive blast cleaned to the SSPC SP-5 White Metal Blast Cleaning standard. Surface preparation and coating was performed by Plasma Coatings. The following possible shop applied coatings were each applied to two SP-5 panels:

- Thermally Sprayed Aluminum (TA): Arc sprayed 99.5 percent pure Aluminum. Previous research on marine pile coatings has shown this to be an effective coating in tidal, splash and atmospheric zones. Its high abrasion and impact resistance suggests that the coating would withstand damage during driving. A test panel coated with thermally sprayed aluminum is shown in Figure 16. The coating thickness specified and reported by Plasma Coatings was 10 mils to 12 mils; however WJE measured thicknesses averaging 38 mils for Panel A and 53 mils for Panel B.
- Fusion Bonded Epoxy (FB): *Protech/Oxyplast*. Commonly used to protect buried steel structures, it was anticipated that this coating would provide an excellent barrier. A test panel coated with fusion bonded epoxy is shown in Figure 16. Coating thicknesses ranged from 8 mils to 13 mils, with an average thickness of 10 mils.
- Thermally Sprayed Zinc with Aluminum Pigmented Overcoat (AZ): Arc sprayed 99.9 percent pure zinc with an overcoat of cold-applied *Intertherm 751*. The selection of the zinc coating was based on previous research on marine pile coatings that has shown thermally applied zinc to be an effective coating in tidal, splash, and atmospheric zones. Its high abrasion and impact resistance suggests that the coating would withstand damage during driving. The coating thickness specified and reported by Plasma Coatings was 10 mils to 12 mils; however WJE measured thicknesses averaging 39 mils for Panel A and 21 mils for Panel B.

The coatings and surface preparations for the potential shop-applied coating test panels are summarized in Table 4.

Table 4. Sample Identifiers for Coatings and Surface Preparation for Possible Shop Application

Coating	Abbreviation	SSPC-SP5
Fusion Bonded Epoxy	FB	FB5A & B
Thermally Sprayed Aluminum	TA	TA5A & B
Thermally Sprayed Zinc with Aluminum Overcoat	AZ	AZ5A & B
Total		6

Each field and shop specimen (with the exception of the formed grout encapsulated panels) was scribed on one side in accordance with ASTM D1654 - *Standard Test Method for Evaluation of Painted or Coated Specimens Subjected to Corrosive Environments*, as shown in Figure 17. The purpose of the scribe was to determine the susceptibility of the coating to undercutting or rust creepage under the coating around the exposed steel, an important characteristic given the challenging field conditions, which may result in a less than perfect application of the coatings on existing piles, and the potential for coating damage during driving of new piles.

Using the timer-equipped dipping mechanism shown in Figure 18, the test panels were cyclically immersed in a 15 percent by weight saltwater solution. This solution was comprised of water and rock salt (sodium chloride), which IaDOT uses for deicing purposes on its roadways. Test cycles consisted of 15 minutes of partial immersion (an approximately 2-inch length of the 4-inch long specimen was immersed) followed by 45 minutes of air drying prior to re-immersion. Magnetic automatic stirrers, shown in Figure 19, were used to aid in keeping the salt in solution. The saltwater solution was refreshed at approximately 2 week intervals and replaced monthly.

Corrosion rates were monitored over a 12-month test period and specimens were photographed and evaluated visually.

Visual Evaluation

Specimens were photographed after 3 and 9 months of continuous cyclic testing, and at the end of the test, after 12 months. A photographic log showing the extent of corrosion at each interval on a representative panel for each coating/surface preparation is provided in Appendix B. At the end of testing, the panels were evaluated for the presence of corrosion in accordance with ASTM D1654.

The maximum and mean rust creepage (undercutting) measurements for each coating and surface preparation combination are presented in Figure 20. The bituminous mastic (BM) and surface tolerant epoxy (ST) coatings exhibited substantial undercut for all surface preparations. Undercut was also present in the fusion boded epoxy with an SSPC-SP5 preparation (FB5) and epoxy over organic zinc primer with an SSPC-SP3 preparation (OZ3). Small, isolated areas of minor undercut were observed in the epoxy over organic zinc primer with SSPC-SP6 and -SP10 surface preparations (OZ6 and OZ10) and the polyester glass flake with SSPC-SP3 surface preparation (PG3). Polyester glass flake with SSPC-SP6 and -SP10 surface preparations (PG6 and PG10) exhibited corrosion only at the original scribe, with no

undercut. No substrate corrosion was observed on the thermally sprayed aluminum (TA5) or thermally sprayed zinc (AZ5) specimens with SSPC-SP5 preparation.

Several specimens exhibited corrosion away from the scribes, along the corners and edges of the test panels. These areas of corrosion were evaluated as an approximate percentage of the total panel edge surface area (3 square inches for a 12 inch perimeter by 1/4 inch thick panel). The maximum ratio of corroded edge surface to total edge surface for the bituminous mastic (BM3) was 23 percent; for the surface tolerant epoxy (ST6), 21 percent; and for the fusion bonded epoxy (FB5) 11 percent. The SSPC-SP3 prepared polyester glass flake specimens exhibited small isolated areas of corrosion along panel edges, with a maximum ratio of 3 percent. The remaining specimens (PG6, PG10, OZ3, OZ6, OZ10, TA5, and AZ5) exhibited no corrosion at panel edges. No blistering or softening was observed in any of the coatings.

All of the grout encased specimens showed evidence of splitting cracks and corrosion staining on the surface of the grout encasement. Staining and splitting were less severe in the specimens with SSPC-SP10 surface preparation than in those with SSPC-SP3 and -SP6 surface preparations.

Electrochemical Testing

After 3 months of dipping, and again after 9 months of dipping, electrochemical testing was conducted to estimate the corrosion rate of each specimen using the test setup shown in Figure 21. Prior to electrochemical testing, the cyclic dipping was interrupted so that each of the samples was submerged in solution for 20 hours to ensure electrochemical stabilization prior to testing.

For the specimens with one of the seven coating types (excluding the grout encased specimens), linear polarization resistance (LPR) testing was performed. LPR is a method of measuring corrosion rates of metals submerged in a conductive solution. The rate of corrosion is measured by determining the current required to change the potential, measured with a reference electrode, a controlled amount. For the testing performed on the coated specimens, the current between each submerged sample and a reference silver/silver chloride (Ag/AgCl) electrode was measured relative to an applied voltage that ranged between 0 and -0.01 volts. The corrosion current was determined and the corrosion rate was calculated from the measured current using the following equation, based on Faraday's Law:

$$CR = \frac{I_{corr} * E}{A * D} * K$$

where CR is the corrosion rate in mils per year, I_{corr} is the corrosion current measured in the LPR test, E is the equivalent weight of the corroding metal (a constant), A is the area of exposed steel, D is the density of the corroding metal, and K is a unit conversion constant.

For the grout encased specimens, the grout itself provides significant resistance to electron flow that obscures the corrosion rate of the encased steel coupon in a typical LPR test. To obtain an estimate of the corrosion rate of the grout coated specimens, potentiostatic electrochemical impedance spectroscopy (EIS) was performed on each specimen to determine the resistance of the grout encasement. The setup for potentiostatic EIS testing is similar to the LPR test, except that alternating current, instead of direct current, is applied to the specimen. The result is that the resistance to electron flow due to the grout encasement can be decoupled from the system's capacitance. Corrosion rate for the grout encased specimens was then estimated by subtracting the resistance of the grout (estimated by EIS) from the total

resistance of the system to isolate the polarization resistance of the specimen. The corrosion rate can then be determined from the polarization resistance.

The estimated corrosion rate at 3 and 9 months is plotted for each of the specimen groups in Figure 22, Figure 23, and Figure 24. The specimens are grouped into the following categories for comparisons: inert coating (non-corroding), active coating (more susceptible to corrosion than steel), and grout encasement. Although the epoxy over organic (zinc rich) coating does include zinc, which is more susceptible to corrosion than steel, it is included in the inert coating category because the epoxy outer coating layer inhibits active zinc corrosion away from the scratch. Diagonal hatching indicates that corrosion was observed on the specimen away from the mechanically inscribed area. For the grout encased specimens, diagonal hatching indicates that corrosion product was noted on the exterior of the grout encasement on a majority of the specimens in the group. For each series of specimens, the average, minimum, and maximum corrosion rate is plotted. Since different sample areas and test techniques were used for each of the coating types, the estimated corrosion rates, shown on the y-axis, cannot be compared directly between the figures. For the coated specimens, the area of exposed steel assumed was 1 inch times the measured width of the mechanically inscribed area. For the active coating types, the corrosion rates were calculated based on the total area of sample exposed to the solution and not just the scribed area. For the grout encased specimens, which did not have any physically exposed steel area, the full area of the steel coupon was assumed to be exposed because moisture and salt products penetrate the grout and reach the coupons approximately uniformly over the entire area. Therefore, the corrosion rates shown are intended for comparison within each specimen group, and not between coating type categories or with rates determined in other studies.

Figure 22 shows a plot of the corrosion rates for the specimens with inert coating types assuming that only the scribed area undergoes corrosion. For all inert coating types, corrosion rates increased between the 3- and 9-month testing dates. Corrosion rates for the bituminous mastic and surface tolerant epoxy coated specimens were similar in magnitude and higher than for specimens with other coating types. In both cases, improved surface preparation tended to increase corrosion rates for both 3- and 9-month testing dates, an unexpected finding. The glass flake polyester coated specimens had significantly lower corrosion rates compared to other inert coating types, with little correlation between surface preparation and performance. The specimens with epoxy over organic (zinc rich) and fusion bonded epoxy coatings showed increased corrosion rates with test exposure, but overall lower corrosion rates than those measured for the bituminous mastic and surface tolerance epoxy coated specimens. Improved surface preparation correlates positively with lower corrosion rates for the epoxy over organic (zinc rich) coated specimens.

Figure 23 shows a plot of the corrosion rates measured for the specimens coated with active coating types. All of the specimens with active coatings showed a higher open circuit corrosion potential (mV vs Ag/AgCl) than specimens with inert coatings, indicating that the corrosion rate measured is from corrosion of the coating material and not the exposed base steel. This finding is supported by visual observations at 3 and 9 months, which did not note any visible mild steel (red rust) corrosion product at or away from the mechanically inscribed areas. Therefore, for these active coating types, the corrosion rate is more a measure of how quickly the coating is getting consumed than a measure of corrosion of the underlying steel coupon. Therefore, the corrosion rates were calculated based on the total area of sample exposed to the solution and not just the scribed area. The specimens coated with thermally sprayed zinc with an aluminum pigmented overcoat had a higher corrosion rate than the specimens coated with only thermally sprayed aluminum. This indicates that the aluminum pigmented overcoat is not as an effective barrier as the thermal sprayed aluminum. The specimens coated with thermally sprayed aluminum

showed very little change in corrosion rate between 3 and 9 months, and overall showed very low corrosion rates.

The corrosion rates estimated for the grout encased specimens are plotted in Figure 24. The corrosion rates were calculated based on the entire steel coupon surface area. The corrosion rate of the grout encased specimens was shown to increase with time and decrease as surface preparation of the steel improved.

Findings of Laboratory Testing of Coatings

During the program of regular cyclic exposure to salt brine and air, the specimens were electrochemically tested at 3 and 9 months to calculate their corrosion rates, and visually examined after 3, 9 and 12 months of exposure. The findings of the corrosion rate measurements are summarized as follows:

- **Barrier coatings:** Specimens coated with surface tolerant epoxy (ST) and bituminous mastic (BM) had high corrosion rates at both 3 and 9 months compared to the other barrier coatings tested. Improved surface preparation did not improve the performance of these two coatings. Specimens coated with glass flake polyester (PG) had the lowest and most consistent corrosion rate. Epoxy over organic zinc rich (OZ) and fusion bonded epoxy (FB) had low corrosion rates except for the OZ coating with SSPC-SP3 surface preparation (OZ3).
- **Active coatings:** The samples with thermally sprayed aluminum coating had lower corrosion rates than the thermally sprayed zinc with aluminum pigmented overcoat material.
- **Grout encasement:** Grout encasement performed better with improved sample surface preparation but all samples showed active corrosion and rust staining after the 9 month test period. As previously discussed, the grout cover over the embedded steel panels was minimal due to the limited size of the grout specimens that could be accommodated by the dipping mechanism. It is anticipated that performance would have improved substantially with greater cover distances. The results underscore the need for quality surface preparation, and use of a relatively large, accurately positioned form to ensure adequate cover.
- Generally, corrosion rates increased with exposure test time. Specimens coated with glass flake polyester and thermally sprayed aluminum showed the least change in corrosion rate with time.

Electrochemical testing of the specimens coupled with visual observation of the specimens indicate three general levels of coating performance: very effective (relatively low corrosion rates and no spread of steel corrosion away from original exposed steel area), moderately effective (relatively moderate corrosion rates and some spread of steel corrosion), and relatively ineffective (relatively high corrosion rates and obvious damage to coating around exposed steel and corrosion away from scribe). The coating and surface preparation types corresponding to each level of performance are as follows:

- **Very effective:** Glass flake polyester (PG) with SSPC-SP3, -SP6, and -SP10 surface preparations, thermally applied aluminum (TA) with SSPC-SP5 surface preparation, and thermally applied zinc with aluminum pigmented overcoat (AZ) with SSPC-SP5 surface preparation.
- **Moderately effective:** Fusion bonded epoxy with SSPC-SP5 surface preparation (FB), epoxy over organic zinc rich primer (OZ) with SSPC-SP6 and -SP10 surface preparations, and grout encasement with SSPC-SP6 and -SP10 surface preparations.

- **Relatively ineffective:** Surface tolerant epoxy (ST) and bituminous mastic (BM) with SSPC-SP3, -SP6 and -SP10 surface preparations, epoxy over organic zinc rich primer (OZ) with SSPC-SP3 surface preparation, and grout encasement with SSPC-SP3 surface preparation.

FIELD TESTING OF COATINGS

Access to existing abutment piles for surface preparation and coating is challenging. In order to limit excavation effort and expense, it is desirable to minimize the size of the excavation under the abutment footing around each pile. This results in a relatively constricted work area for surface preparation and coating. In addition, groundwater seepage typically collects in the bottom of the excavation and on pile surfaces, resulting in a damp, muddy work environment. A variety of surface preparation techniques and coatings were selected for field testing in order to evaluate the practicality and effectiveness of their application in these difficult conditions.

Surface preparation methods selected for field testing included abrasive blast cleaning and the *MBX Bristle Blaster*, a mechanical surface preparation tool that reportedly provides a cleaned surface comparable to that required by SSPC SP-10, and an anchor profile on steel substrate of 2 to 3 mils (Stango 2010). Based on their excellent performance in the laboratory dip testing, the glass flake polyester and the epoxy over organic zinc rich primer were selected as coatings for trial application in the field. In addition, formed grout encapsulation was selected in order to evaluate its performance with greater cover over the encased steel than that provided in the laboratory study, and to assess the practicality of constructing and filling a suitable form under the abutment footing.

The bridge selected for the coating field testing was Bridge No. 9081.5S034, located approximately 6 miles east of Ottumwa, Iowa, carrying Highway 34 over Bear Creek and the Canadian Pacific Railroad. Three of the HP10x42 abutment piles were excavated for trial surface preparation and coating application. Erosion had occurred under the abutment footing at the north end of the west abutment, as shown in Figure 25. The north-most pile at this abutment (Pile 1) and the adjacent pile (Pile 2) were partially exposed by the erosion prior to excavation. Pile 3, located at the east abutment, was covered with soil (prior to excavation).

Hand digging was used to create excavations measuring approximately 30 inches high by 58 inches wide, and extending approximately 20 inches beyond the far flange of each pile, under the abutment footings, as shown in Figure 26. Soil was then removed from the pile surfaces using a chipping hammer with a spade bit, a small spade, and a putty knife. An example of a pile after mechanical soil removal is shown in Figure 27. A crew of two prepared the excavations and removed the soil from the pile surfaces at the two piles exposed by erosion in approximately 10 hours (10 man-hours/pile). The soil-covered pile was excavated and cleaned of soil in approximately 6 hours (12 man-hours/pile). After the excavations were complete, a small sump pit was dug at the low point of each excavation. Groundwater seepage was pumped and/or bailed from these pits prior to and during the cleaning and coating operations.

Surface Preparation

The two piles at the west abutment were abrasive blast cleaned by IaDOT personnel, as shown in Figure 28. A 90-degree blast nozzle was used to facilitate cleaning the side and rear facing surfaces of the piles. Certain portions of the piles were more difficult to reach and required greater effort and multiple treatments to achieve a quality surface preparation. An example is the intersection of the web, flange and abutment footing on the west side of the pile (Figure 29). The clay soil and corrosion product was

difficult to remove from these hard to reach corners, both mechanically prior to blast cleaning, and during the blast cleaning operation.

Typical finished cleaned surfaces are shown in Figure 30 and Figure 31. Based on comparison with SSPC-VIS1 reference photographs, the surface shown in Figure 30 meets the requirements of SP6 for area of rust staining remaining on the surface (less than 1/3). The surface shown in Figure 31 meets the requirements of SP10 for area of rust staining remaining on the surface (less than 5 percent). The superior preparation was achieved on surfaces that were more accessible, for example the faces of the flanges. Following blast cleaning, the piles were solvent cleaned. Including blast equipment set-up time, the time required for a two person crew to clean the two piles was approximately 4 hours (4 man-hours/pile).

The pile at the east abutment was prepared using the *MBX Bristle Blaster*. The tool was used in accordance with the manufacturer's instructions regarding application of pressure to the tool and direction of tool travel. Bristle wheels were replaced at approximately 1 hour intervals. A typical prepared surface is shown in Figure 32. Based on comparison with SSPC-VIS3 reference photographs, the cleaned surface was superior to that of an SP3 preparation, as much of the tightly adherent corrosion product was removed. Nevertheless, abrasive blasting provided a higher quality surface preparation. While a visibly textured surface was provided by the first few passes with a new bristle wheel, as the wheel wore, the cleaned surface took on a burnished appearance similar to that produced by a standard power wire brush. This indicates that the bristle wheels would likely need to be replaced very frequently for this application, perhaps after every 10 to 15 minutes of use, in order to achieve a surface profile comparable to that described in the product research report (Stango 2010). Tight corners such as web/flange intersections and the area directly adjacent to abutment concrete (Figure 33) were difficult to thoroughly clean due to interference between the body of the tool and the pile and footing. These areas were touched up with a standard power wire brush. Following cleaning with the *MBX Bristle Blaster*, the pile was solvent cleaned. Time required to prepare the surface of the pile using the *MBX Bristle Blaster* was approximately 5 man-hours.

Coating Application

WJE's initial intent was to retain a painting contractor to apply the coatings using airless spray equipment as this was the application method recommended by coating manufacturers and used in the lab tests; however, we were unable to locate a contractor willing to take on a one-day assignment during the busy summer season, particularly given the site conditions. A rented airless spray unit was brought to the site. Unfortunately, the equipment had not been properly cleaned by the previous user and was not functional. As a result, the coatings were applied by WJE with brush and roller. The airless spray gun assembly was brought into the excavations to determine if adequate clearance for coating was provided. A minimum standoff distance of approximately 12 inches to all pile surfaces could be achieved with the spray gun, within the range of typical recommended standoff distances for airless spray equipment.

The glass flake polyester was applied to Pile 1 using a brush. Three coats were applied, following manufacturer's recommendations for recoat times. The coated pile is shown in Figure 34. Likely due to the relatively high ambient temperature (85°F) and material temperature at the time of application, pot life for this coating was very short, on the order of 20 minutes. The epoxy over organic zinc rich primer system was applied to Pile 2. Two coats of each coating were applied with brush and roller, following manufacturer's recommendations. The applied primer and top coats are shown in Figure 35 and Figure 36, respectively. Coating thicknesses could not be accurately measured due to pitting on the pile

surfaces; however, ranges of approximate dry film thicknesses were estimated based on wet film measurements made on the pitted surfaces. Estimated coating thicknesses for the glass flake polyester, zinc rich primer, and epoxy were 12 to 18 mils, 3 to 5 mils, and 7 to 10 mils, respectively. Time required for coating application was approximately 1 man-hour/pile. The smallest kits offered by the coating manufacturers, ranging from 0.8 gal to 2 gal, provided more than enough material to coat the piles.

For the formed grout encapsulation of Pile 3, a 20-inch diameter fiber form tube was cut to length, then cut lengthwise and positioned around the pile. Foam spacer blocks were positioned at the flange tip to center the form tube on the pile and provide a minimum cover of 2 1/2 inches. The form tube was battered to match the batter of the pile. A second, shorter length of form tube was cut to size and positioned above the original form, butted against the abutment footing. Seams were taped, gaps were filled with expanding foam, and ratchet straps were placed around the form tube and lightly tensioned. Fill and vent holes were placed at the top of the form. The completed form is shown in Figure 37. The non-shrink grout (*Masterflow 928*) was mixed at a water-grout ratio of approximately 1:5 and pumped manually through a fill hole at the top of the form, as shown in Figure 38. The form was filled until grout flowed freely from the vent hole. Twelve 55-lb. bags of grout were used.

The grout was left to cure for approximately 14 hours and the form was stripped. Due to the batter of the pile and the uneven surface of the abutment concrete, an approximately 1 1/2 in. gap remained between the grout and the abutment concrete. This gap was dry packed with the same non-shrink grout used in the form. The completed formed grout encapsulation is shown in Figure 39. Time required for a two person crew to complete the formed grout repair, not including cure time, was approximately 6 hours (12 man-hours/pile).

Findings of Field Testing of Coatings

Based on our field trials, abrasive blast cleaning provided the most effective and efficient means of surface preparation. The *MBX Bristle Blaster* was more time consuming than blast cleaning and the quality of the prepared surface, based on visual evaluation, was inferior to that provided by blast cleaning. The size of the excavations around the piles allowed adequate access to all surfaces of the piles when a 90-degree blast nozzle was used. Use of a 135-degree nozzle in addition to the 90-degree nozzle would be beneficial in reaching some pile surfaces. It is feasible to achieve an SP6 surface preparation in all areas of the pile and an SP10 surface preparation in many areas. This will require diligent workers and/or close supervision due to the uncomfortable working conditions. Coatings that exhibit good performance on SP6 surfaces should be used.

Ideally, in order to meet SSPC standards and promote greater removal of contaminants such as chlorides, after removing the soil by mechanical means and prior to blast cleaning, remaining soil should be removed from the pile surfaces by light pressure washing, followed by solvent cleaning; however, this presents some challenges due to the resulting ponding of water in the excavation and the difficulty of keeping the cleaned pile surfaces free of dirt during cleaning and coating operations. A sump pit and pump should be provided and operated during washing, and solvent cleaning should be repeated after blast cleaning. Due to the high moisture environment under the abutments, initial coating should be performed during the same work shift as the surface preparation operation in order to maintain the quality of the prepared surface.

Either of the field-tested coating systems can be applied to existing piles. A smooth steel blank should be coated simultaneously with the piles to assist in determining coating thicknesses. It is anticipated that a trained applicator could apply the polyester glass flake, zinc rich primer, and/or epoxy top coat in a single coat each, using airless spray equipment. Advantages of the polyester glass flake are that it is a single coat system (when spray applied) with short tack-free and cure times. Therefore, backfilling or grouting could commence soon after initial application of the coating. On the other hand, the short pot life in warmer temperatures will present challenges in the field if airless spray equipment is used. Local applicators are likely more familiar with the zinc rich primer and epoxy coatings, which have longer pot lives. Therefore the epoxy system will likely be easier to apply in the field using airless spray equipment than the polyester glass flake coating. Should brush and roller application be necessary, polyester glass flake has the advantages of short recoat, tack-free, and cure times.

Field installation of the formed grout encapsulation was less efficient than application of the coatings due to the substantial time required to construct and fill the form, and the cure time required prior to dry-packing grout between the abutment footing and the formed grout. In addition, due to the large diameter form tube required to provide adequate cover over pile flange tips, a significant amount of grout material was needed to encapsulate a pile, while relatively little coating material was needed to coat a pile.

LABORATORY TESTING OF CATHODIC PROTECTION SYSTEM

To evaluate the effectiveness of a cathodic protection (CP) system at protecting steel piles, WJE set up a soil box in the laboratory consisting of piles connected to a sacrificial zinc anode buried in soil and sand. The soil box was subjected to cycles of saltwater application to promote corrosion of the simulated steel piles. Electrochemical testing was conducted throughout the testing period to measure corrosion rates and cathodic depolarization, and a visual evaluation of the pile and anode conditions was performed at the end of testing.

The primary goals of this laboratory testing were to:

1. Assess the depth of protection needed for cathodic protection current for a bare steel pile.
2. Assess the distance effects from the anode on cathodic protection current attenuation.
3. Determine if cathodic protection is adversely affected by the soil gap beneath bridge abutments.
4. Evaluate the use of flowable mortars used for filling soil gaps beneath bridge abutments and cathodic protection.

If a gap forms below abutments on an actual bridge due to soil erosion or consolidation and the soil loses contact with the steel pile surface, cathodic protection may be ineffective at protecting the exposed steel since a current path between the galvanic anode and the upper steel section may not be present. One strategy for providing that current path is to fill the gap with flowable mortar. This strategy was evaluated through the laboratory testing by placing plates embedded in mortar within the experimental soil box and connecting them to the anode.

Test Setup

For the laboratory test, three test piles were constructed and installed in a 4 foot x 4 foot x 16 foot soil tank, as shown in Figure 40. Drawings for this test setup are included in Figure 41 and Figure 42. The test piles were each constructed of three 1/4 x 6 x 6 inch and one 1/4 x 6 x 12 inch plates of ASTM A36 steel fastened to 1 1/2 inch x 1 1/2 inch x 1/4 inch PVC double angles. A wire lead was connected to each

plate, as shown in Figure 43. The piles were spaced at 5 ft. on center, the approximate average pile spacing of the bridges reviewed in the previous WJE abutment pile study. The soil tank, constructed of modular formwork, was lined with a poly sheet moisture barrier. A perforated drain pipe with a valve allowed variation of the height of the water table during testing, and a 5 1/2-inch layer of gravel at the base of the soil tank facilitated drainage. This is shown in Figure 44 and Figure 45. A 2-foot layer of silty clay soil was placed over the gravel in 6-inch lifts and compacted with a hand tamper after each lift. The tank was then filled with water to a level several inches above the top of the soil. This water level was maintained for 21 days to reduce oxygen levels in the soil. After draining the water, the top surface of the soil was graded to provide a uniform height of soil for each pile, and a 7-inch surface layer of sand was added.

Zinc soil anodes, consisting of 5-lb bars of zinc packaged in a cloth bag filled with a low resistance backfill mixture consisting of hydrated gypsum, bentonite and sodium sulfate, were buried a fixed distance from the piles in the soil. Two anodes were installed in the soil box at the locations shown on Figure 41. Anode No. 1 was the primary anode used throughout this test program. Anode No. 2 was connected to the piles for only a limited period to assess the reduction in efficiency of Anode No. 1 over time, as discussed further below.

Switches and instrumentation, including buried reference cells, were installed to allow measurement of the cathodic protection current being provided vertically along individual piles and the corrosion potential of the steel elements. The discrete plates that made up each of the test piles were numbered and wired together in two ways during this course of this investigation. In Setup No. 1, shown in Figure 46, the plates were connected to Anode No. 1 through 1-ohm resistors and individual switches. Setup No. 2, shown Figure 47, was used in the latter half of this test program to examine the protection provided to the individual plates, and consisted of individual resistors and switches in line between the anode and the plates. When they were connected, the plates embedded in mortar blocks were individually wired through a resistor to Anode No. 1 in a manner similar to that used for the plates in Setup No. 2. The switches permitted depolarization testing, while the purpose of the resistors was to support measurement of electrical current.

Applications of a saltwater solution consisting of 15 percent by weight sodium chloride began on June 14, 2011, with each application consisting of 25 gallons of solution. Saltwater applications were performed weekly for 15 weeks, followed by a four to six week interval between applications for 4 months. Based on samples taken at the conclusion of the test, the chloride content at mid-depth of the sand was 0.36 percent by weight, while the chloride concentrations at 1/4 and 3/4 of the thickness of soil layer were both 1.0 percent by weight. After the saltwater applications, the resistivity of the upper sand layer had decreased to less than 10 ohm-cm. After 8 weeks of saltwater application, Anode No. 1 was electrically connected to all three test piles. Electrochemical and depolarization tests were performed at intervals through February 25, 2013.

Depolarization tests and cathodic protection current measurements were conducted periodically throughout the test program, and the test configurations were modified a number of times during this study. A timeline identifying the key milestones during the execution of this program is given in the following table.

Date	Time elapsed from when Anode No. 1 first connected to the Piles (days)	Activity
4/12/2011	-120	Soil placed around piles and tank filled with fresh water for 21 days
6/10/2011	-61	Sand added
6/14/2011	-57	Salt water solution first added
8/10/2011	0	Connected to Anode No. 1 using Setup No. 1
9/9/2011	30	Depolarization Test 1
1/26/2012	169	Depolarization Test 2
2/22/2012	196	Depolarization Test 3
2/24/2012	198	Connected piles to Anode No. 2
3/2/2012	205	Depolarization Test 4
3/2/2012	205	Reconnected piles to Anode No. 1
3/27/2012	230	Depolarization Test 5
5/3/2012	267	Depolarization Test 6
5/24/2012	288	Depolarization Test 7
7/19/2012	344	Rewired connections using Setup No. 2
7/19/2012	344	Depolarization Test 8
7/24/2012	349	Cast mortar around Plate 1 of Piles A and C
8/1/2012	357	Connected mortar blocks to Anode No. 1
8/10/2012	366	Depolarization Test 9
9/5/2012	392	Depolarization Test 10
10/18/2012	435	Depolarization Test 11
1/22/2013	531	Depolarization Test 12
2/25/2013	565	Depolarization Test 13
3/14/2013	582	Decommissioning and autopsy of samples

Selection of Flowable Mortars

On July 24, 2012, flowable mortar, based on a controlled low strength material (CLSM) mixture proportions, was cast around the top plates (Plate 1) of two of the piles. At the same time, six ¼ x 6 x 12 inch steel plates were partially embedded in mortar blocks, such that 7 inches of the plate was embedded in the mortar. The minimum thickness of the mortar over the plates was 1 inch on the bottom of the blocks. After curing for one week, the blocks were partially buried in the sand in the soil box. The layout of the mortar blocks is shown schematically in Figure 48. Photos of the soil box and mortar block configurations are shown in Figure 49 and Figure 50.

WJE conducted ASTM C109 compressive strength testing and Louisiana DOTD TR 233-11 resistivity testing on several mortar samples of a variety of mixes to determine what type of flowable fill would be appropriate for use in encasing the plies. Ultimately, three mixes were selected: a control mix, a mix

containing corrosion inhibitor (CI), and a mix where 15 percent of the cement was replaced with bentonite. The mix designs and test results for the selected materials are as follows:

Table 5. Mix designs for selected mortars

Material	Control	CI	15% Bentonite
Cement (lbs/cu yd)	102	101	91
Water (lbs/cu yd)	425	396	553
Fine Aggregate (lbs/cu yd)	2748	2737	2471
Fly Ash (lbs/cu yd)	509	507	376
Bentonite (lbs/cu yd)	0	0	82
Corrosion inhibitor (Grace DCI) (gal/cu yd)	0	4	0
Superplasticizer (BASF Glenium 3030 NS) (oz/cwt)	0	0	146

Table 6. Test results for selected mortars

Mix Description	Water-cementitious material ratio w/cm	Resistivity (kΩ-cm)		Compressive Strength (psi)	
		7 Day	42 Day	7 Day	28 Day
Control	0.59	1.4	4.4	200	453
CI	0.55	1.4	1.8	190	463
15% Bentonite	1.16	1.0	2.5	67	127

The addition of CI appeared to have little effect on the compressive strength and early-age resistivity of the mix, but the resistivity at 42 days was significantly lower than that of the control mix. A low resistivity is desirable as that will facilitate transfer of the cathodic protection current. The bentonite sample had a much lower strength than the other two mixes. The early-age resistivity of the mix was low, but by 42 days the resistivity was higher than that of the CI mix. The samples were wet when the resistivity testing was performed.

WJE directly evaluated the effectiveness of the flowable mortar at carrying cathodic protection current in two ways: 1) by casting a mortar block around the top plate in two of the pile assemblies, and 2) by placing steel plates embedded in blocks of flowable mortar in the soil tank and connecting these to the anode.

The three mixes were duplicated and cast into six 6 x 12 x 7 inch blocks (two of each material), with each block encapsulating the bottom half of the steel plate. The six blocks were buried in the soil box at approximately the same distance from the anode with the top of the block 2 inches above the sand. Each plate was connected by a wire lead to the anode.

The CI and bentonite mixes were also each cast in a block of the same size around the top plate of an embedded pile (Piles A and C, respectively). The middle pile (Pile B) did not have a mortar block cast around its top plate. The pile plates were not cleaned before the mortar was cast around them.

Electrochemical Testing

Methods

The most common method for evaluating the amount of corrosion protection is to perform a depolarization (or polarization decay) test. This test measures the polarization of the steel, i.e. the shift in corrosion potential away from the natural corroding state due to the cathodic protection, by measuring the magnitude of the change in the corrosion potential as the steel drifts back toward the natural corroding state after the cathodic protection current is removed. Figure 51 shows a schematic of corrosion potentials throughout a depolarization test. When the anode and steel are first disconnected, there is an immediate shift in potential to the instant off potential. This change is called the iR -drop and is related to the current flowing through the system to the reference electrode used for the measurement; this is considered a measurement artifact and is not a component of the polarization. The depolarization is the difference between the instant-off potential and the final depolarized potential after the effect of protection current decays away. NACE SP0169 *Control of External Corrosion on Underground or Submerged Metal Piping Systems* provides criteria for evaluating the level of protection provided to buried steel. One criterion is that CP systems should provide a minimum of 100 mV depolarization after 4 hours of decay to be effective. It should be noted that the 100 mV depolarization criteria was developed through empirical evaluations of data from impressed current (rectifier driven) CP systems, and this criteria may not be fully applicable when evaluating galvanic CP system performance. Nevertheless, 4-hour depolarization tests were performed on the steel piles and mortar-embedded plates in this study.

In addition to depolarization tests, the current passing between the anode and the piles was measured. Since the corrosion current is the directly proportional to the rate of metal loss at the anode through corrosion, the anode consumption projected based on the total charge passed was compared to the mass loss of the anode through the course of this study. To determine the mass loss, the anodes were removed from the anode bags and weighed at the beginning of testing and again at the end of the testing after the corrosion product was cleaned away from the anodes.

Testing Results

The corrosion potentials of the three piles measured relative to both reference cells (Nos. 1 and 2) were nearly identical. Therefore, the potential measured at Reference Cell No. 1 only will be presented throughout this discussion.

Protection of Piles by Anode No. 1

Current. Figure 52 shows the current from Anode No. 1 measured throughout the study. Currents provided by galvanic anodes typically decrease with time first as the anode polarizes and then as corrosion product accumulates around the anode, and such a trend was observed here. The measured mass of the anode before and after testing is shown in Table 7. The actual mass loss is approximately equal to the projected mass loss calculated from the charged passed indicating that most of the corrosion occurring at the anode was due to the galvanic reaction to cathodically protect the test piles and samples.

Table 7. Actual and projected mass loss at the anode

Anode	Initial mass (g)	Mass after test (g)	Actual mass loss (g)	Actual mass loss (%)	Charged Passed (Coulombs)	Projected mass loss (g)

Anode 1	2395.5	2063.1	332.4	13.9%	1,044,000	356
Anode 2	2340.9	2311.7	29.2	1.2%	19,000	6

Depolarization. Test Setup No. 1 was used to compare the performance of the three simulated piles when protected by a single anode. When depolarization tests were conducted relative to Anode 1 using wiring Setup No. 1, the connection between the anode and each individual pile stack was broken, but the plates were left connected. As a result, the measured depolarization represented the entire individual test piles such that depolarization was similar at all vertical plates. This is illustrated in Figure 53, which shows the 4-hour depolarization at each plate in the piles. As can be seen, the performance is generally similar in all three pile stacks. The magnitude of the depolarization was typically between approximately 50 and 125 mV, indicative of protection that is adequate, if not always meeting the 100 mV threshold discussed above.

At the conclusion of the initial depolarization tests using wiring Setup No. 1, the individual plates were disconnected and it was noted that the corrosion potential of the plates shifted differently depending on their relative location in the pile stack. Typically, as shown in Figure 55, the upper plate (Plate 1) shifted positive an additional 100 mV or more, while the lower plates shifted slightly more negative. This indicates that the upper plates were polarized (cathodically protected) a greater amount than the lower plates.

To further assess the polarization effects vertically along the sample piles, the connections to the plates was reconfigured according to wiring Setup No. 2. With this setup, the depolarization tests were conducted with the connection between each plate being broken when the connection to the anode was broken. In this way, the elevation within the soil box where greater depolarization is occurring can be better identified. As shown in Figure 42, which depicts the initial setup, Plate 1 was half exposed in air and half covered in sand, Plate 2 was buried half covered in sand and half covered in soil, while Plates 3 and 4 were buried in soil only. Approximately two weeks after the wiring was modified, Plate 1 of Piles A and C were embedded in mortar, as discussed above.

Figure 54 shows the 4-hour depolarization at each plate in the piles when testing was conducted based on wiring Setup No. 2. The depolarization measured at Plates 3 and 4 in each pile was low, approaching zero. The depolarization measured at Plates 1 and 2 in each pile was variable but generally much greater than the lower plates. This reflects differences in corrosivity and oxygen availability with depth and soil strata between the upper and lower plates.

Effect of Mortar Cast on Upper Plates. At Pile B, where no mortar was cast around the plate, the depolarization at Plates 1 and 2 remained similar through this second phase of the test program, as shown on Figure 43. The depolarization at Plates 1 and 2 on Piles A and C was affected when Plate 1 on these piles was embedded in mortar, though the magnitude of that effect varied between the piles and appeared to fade with time. Within 50 days of the installation of the mortar, the depolarization of Plate 1 in both these piles dropped from over 250 mV to about 100 mV, while the depolarization of Plate 2 in Pile A dropped from about 225 mV to less than 50 mV. After 150 days, the upper plates on the piles behaved similarly. This may reflect an initial passivation of the plates due to the mortar contact followed by a reduction in the resistivity of the mortar with time as moisture penetrated the relatively porous mortar materials. In contrast to the upper plates, the performance of Plates 3 and 4 in all three piles was similar regardless of whether Plate 1 was embedded in mortar, as shown in Figure 54.

The current provided to each of the plates that made up the piles was measured independently. The protective current density was calculated as the ratio of this current to the surface area of each plate in contact with this soil. The average current density at each plate for the three piles measured between 230 and 287 days, the period immediately prior to installation of the mortar embedment, is plotted in Figure 56. This figure highlights the greater current densities provided at the near surface zone of the soil box. Most current is being provided to the upper 2 feet of the test piles.

Protection of Mortar-embedded Plates

One week after the mortar was cast around the mortar-embedded plates, the blocks were installed in the soil box and connected to Anode No. 1. Figure 57 and Figure 58 show the average current to each plate based on the type of mortar used and the 4-hour depolarization at each plate. The current to the embedded plates was initially high, but decayed quickly, though more slowly for the mortar produced with 15 percent bentonite. Depolarization of the embedded plates was highest for the mortar mixture containing corrosion inhibitor, though consistently greater than 100 mV (0.1 V) for both that mixture and the control mixture. The plate embedded in the mortar mixture containing bentonite was initially high but dropped to less than 60 mV on both plates at the final measurement.

Anode Efficiency

The piles were connected to Anode No. 2 for a limited time to provide a reference for assessing the decrease in the performance of Anode No. 1 after it had been supplying current for 198 days. The current provided by Anode No. 2 was initially high, near 65 mA, as the anode polarized and decreased with time, as shown in Figure 59. The current just before Anode No. 2 was disconnected after 7 days was about 30 mA, and the 4-hour depolarization was over 200 mV. This current is slightly higher than the current from Anode No. 1 which ranged from about 15 to 20 mA before and after the temporary connection to Anode No. 2 was made. This suggests that some minor reduction in the efficiency of Anode No. 1 had occurred after nearly 200 days of service.

Post-Exposure Inspection of Steel Plates

On March 14, 2013, the three piles and six plates were removed from the soil box and broken out of the mortar blocks and autopsied. The piles were cleaned with a wire brush to remove loose corrosion products, then both faces of the piles visually rated from 1 (best) to 10 (most severe) based on their appearance. The mortar embedded plates were assessed visually to determine the effectiveness of the encasement. The following summarizes the observations from the end of testing:

Piles

- The three piles were generally in similar condition at the completion of this program (Figure 60 and Figure 61). The corrosion product formed above the sand surface (exposed to air) was finer and denser than that formed below the sand and soil surfaces, which was porous, poorly bonded, and easily removed by a wire brush. The cathodic protection current was not able to reduce or prevent corrosion of the sections of plates just above the soil line. The average of the visual ratings of both sides of the plates is shown relative to location in the piles in Figure 62. The top half of Plate 1 and all of Plate 4 had the highest (worst) visual condition ratings for all piles at the end of testing.
- The top of Plate 1 was exposed to the air until the mortar blocks were cast. The condition of Plate 1 on the piles before and after mortar was cast around the plates on Piles A and C can be seen in Figure 63, Figure 64, and Figure 65. On all three piles, the top half of Plate 1, which was exposed to air above the sand level (shown as a white line in the photos), underwent a different type of corrosion

process than the rest of the pile length, likely due to exposure to air and condensation of moisture. The corrosion product on this section of the pile was produced prior to casting of the mortar blocks and was much more difficult to remove, indicating a fine, dense composition. Before the mortar was installed, corrosion was less severe on the portion of the plate buried in the sand, reflecting the protection provided by the anode to the lower portion of the plates through the electrolytic path provided by the soil. Despite being furthest from the anode, the portion of Pile A encased in the CI mortar had the slightly better visual appearance than Plate 1 in the other two piles, suggesting that the CI mortar may have provided better protection than the Bentonite mortar.

- There was a local increase in the severity of corrosion at the sand-soil transition line on the all piles. The top half of Plate 2 of all piles was in contact with the sand and exhibited less pitting than the lower half of these plates in contact with soil.
- Plate 4 was in contact with soil, which likely retained more moisture than the sand layer. Both sides of Plates 4 on all three piles exhibited severe pitting and were in poor condition in all three piles. The partial submersion in the saltwater and lack of significant drying likely led to the more severe corrosion within the soil layer. The change in soil strata likely set up a differential aeration zone that promoted pile corrosion. Plate 4 of Pile C did not undergo as severe corrosion as the other two piles, possibly because it was closest to the CP anode.

Mortar-Embedded Plates

- Figure 66 shows the condition of the mortar-embedded plates after they were removed from the mortar. No systematic application of salt water was made to the mortar block, and the corrosive environment that the embedded portion plates were subjected to was somewhat limited compared to the piles. The exposure did consist of indirect salt spray and moisture condensing on the portion of the plate above the mortar and running down the interface between the plate and mortar. This caused corrosion near the top of the mortar and also at the bottom of the plate where moisture apparently collected.
- Based on the visual assessment, the plates embedded in the corrosion inhibiting (CI) mortar performed the best of all the embedded plates. One of the CI plates had a small amount of corrosion at a bottom corner, while the other had no visible corrosion at all.
- The control and bentonite plates had localized corrosion along the bottom edge, as well as isolated spots of corrosion on each side of the embedded portion.

Anodes

- Figure 67 and Figure 68 show the condition of the anodes after cleaning. Significant loss was present at Anode No. 1, which was actively protecting the steel plates and piles, and was measured to have lost more than 300 g of its mass. Small flakes had broken off of Anode No. 2, which was only temporarily connected to the steel plates and piles.

Findings of Laboratory Testing of Cathodic Protection System

In general, electrochemical testing has demonstrated that the zinc soil anodes provided protection to the steel pile mockup; typically greater than 100 mV polarization was measured, with all depolarization tests measuring at least 50 mV. The greatest polarization and the greatest consumption of current were measured at the upper Plates 1 and 2 in the test piles. These plates, which were embedded in sand having low resistivity or were exposed, had greater exposure to oxygen than the plates buried more deeply in the soil box. This oxygen is required to support the cathodic reaction that is paired with the anodic reaction occurring at the zinc anode.

Generally similar conditions and performance were observed in the three piles. The small variations that were noted could be minor effects of anode distance, presence/type of mortar encasement, or other factors. The low soil resistivity resulting from the high chloride concentration and abundant moisture in the soil box appears to have made the slight differences in the current path length between the anode and individual piles irrelevant.

Nearly 14 percent of the Anode No. 1 was consumed in the approximately 1.6 years that this anode was in service protecting the test piles. As demonstrated during this test program, the current from this anode (and thus its rate of consumption) decreased with time and would be expected to continue to do so in the future. Based on the observed rate of decay, it is projected that the effective mass of the test anode (i.e. the original mass adjusted for the efficiency and utilization factors, which recognize that complete consumption of the anode is unlikely) would have been consumed protecting the steel plates in approximately 9 yrs.

During design of a galvanic CP system, the number and size of anodes needed for a particular structure will be dictated by the steel area to be protected, the desired life of the system, and the required protection current density. Assuming the conditions established in this study are representative of field conditions, the measured protection current densities can be used in the design process. As an example, for a typical Iowa two-lane highway bridge abutment utilizing seven HP10x42 piles, seventeen 30-lb anodes would be needed to provide protection for 20 years. This was determined by projecting the distribution of current with depth over a 60-ft pile based on the data shown in Figure 56 and considering the decay of current with time as shown in Figure 52 projected into the future. The large amount of zinc is needed because of the assumed large bare steel surface area of the pile to be protected. An alternate approach to design of the cathodic protection for this example abutment would be to consider the life expectancy of a system if one 30-lb anode were connected to each pile. Based on that assumption and the measured protection current densities during this study, the anticipated life of each anode would be approximately 8 years. Note that the current density measured in this study was likely significantly higher than would be the case in a field installation, where soil corrosivity may be much less and seasonal variations would include a winter cycle where cold temperatures would be expected to slow corrosion significantly, and the life of anodes in actual service could be much greater than suggested here. Final design of CP systems for piles for bridge abutments should be based on conditions at the bridge site, but can be informed by the results of this study.

Based on the condition of Plate 1 in the three piles and as expected, the CP protection provided to the piles by the anode effectively stops at the upper ground surface and would not likely protect any pile length exposed by soil settlement. The mortar embedment provided a functional electrolytic path between the anode and the steel surfaces in the pile and individual plates that were encased in mortar, supporting the transfer of protection current to the plates. This suggests that a flowable mortar installed

around piles in the gap formed by soil erosion or settlement would provide initial protection to the steel and a path for cathodic protection currents. Therefore, cathodic protection and sub-cap grouting is a viable strategy for protecting pile surface initially exposed in this manner. A consistent 100 mV polarization was achieved in both the plates embedded in the control mortar and the mortar with corrosion inhibitor. However, based on the autopsy of the embedded steel plates after testing, the mortar containing corrosion inhibitor (CI) appeared to have performed best in preventing corrosion in this environment.

RECOMMENDATIONS

Existing Bridges

Based on the findings of this investigation, a promising method of mitigating corrosion of the upper portions of existing abutment piles is application of a protective coating. Excavations should be made to a depth below that where section loss is no longer evident (typically 1 to 2 feet below the exposed portion of the pile), or below the anticipated depth of erosion, and be of sufficient dimensions to allow surface preparation and coating work to be performed. Surface preparation should consist of abrasive blast cleaning to SSPC-SP6.

Due to the relatively small area of coverage, the cost of coating materials relative to overall cost of the coating application is expected to be small. Therefore, coating selection should be made primarily based on coating performance and practicality of application. Glass flake polyester provided superior performance in accelerated corrosion conditions in the laboratory, on SSPC-SP3, -SP6, and -SP10 surface preparations. Past studies have also shown it to provide excellent protection over a long service life in marine atmospheric exposures similar to the moist, chloride rich environment to which abutment piles are exposed. It is anticipated that this coating could be effectively applied in the field by an experienced applicator using airless spray equipment. Epoxy over an organic zinc rich primer would also provide excellent protection, though it was found to be more sensitive to inferior surface preparation in the laboratory tests, and has not performed as well as polyester glass flake in past studies of long term performance of coatings on marine piles.

The piles that were coated in the field trials were backfilled with the soil that was removed during excavation. For production repair, it would be preferable to remove these chloride laden soils, and backfill with a different material. Due to the location of the excavations below the abutment footing, it is difficult to compact the fill and to completely fill voids. The new fill material is therefore susceptible to erosion. Ideally, backfilling would be accomplished with pumped controlled low strength material (CLSM) to provide additional protection against chlorides, completely fill voids, and protect against further erosion.

Although further testing in the field is required, based on the findings of the laboratory testing, galvanic cathodic protection could potentially provide an effective method for mitigating corrosion of existing abutment piles, provided a mortar with mix proportions similar to those of a CLSM mix is introduced into any voids to provide a current path between the anode and the pile surface. It appears that incorporation of a corrosion inhibitor into the mortar would be beneficial both in reducing the resistivity of the mortar and in taking advantage of any corrosion inhibiting action provided by the admixture. However, it should be expected that the CP current demand will be high and a large mass of zinc will be required due to the large bare steel area of the piles.

Installation of a CP system would have the advantage of requiring substantially less excavation effort as compared with coating application; the effort and costs associated with installing and maintaining a CP system may compare favorably to those associated with excavating, preparing pile surfaces, and applying coatings. In addition, a CP system could potentially protect a greater length of an existing pile than a coating applied to the top few feet of pile.

At existing exposed piles where erosion has progressed slowly, soils exhibit relatively low chloride content, and piles exhibit little section loss, consideration should be given to filling gaps between grade and the abutment footing and encapsulating the piles with pumped CLSM with a corrosion inhibiting admixture. This would provide a relatively economical means of slowing the progress of corrosion and reducing future maintenance requirements at abutments that do not yet exhibit severe corrosion conditions.

New Bridges

Protective coatings should also be considered as a means of mitigating corrosion of abutment piles in new bridges. These coatings could be applied to the upper pile sections such that approximately 5 to 10 feet of each pile below the abutment footing is coated. Several excellent coatings that are not practical for application to existing piles can be used on new bridges, due to the controlled shop environment in which they can be applied. However, unlike coatings applied to existing piles, coatings on new piles must be able to withstand impact and abrasion due to handling and driving. Thermally sprayed aluminum provided excellent protection in the accelerated corrosion conditions of the laboratory testing. Previous studies have also shown this coating to exhibit a long service life in marine applications, and to exhibit superior abrasion and impact resistance, particularly when provided with a sealer. Glass flake polyester is another coating that performed well in the laboratory test, has performed well in long term studies in marine environments, and exhibits good abrasion resistance. It is anticipated that either of these coatings could effectively mitigate future corrosion of new abutment piles. These coatings should be applied on surfaces prepared to SSPC-SP5 or -SP10.

Thermally sprayed zinc also provided excellent corrosion protection in the laboratory tests conducted as part of this study, though previous research suggests that it may not perform as well as thermally sprayed aluminum after long term exposure to moist, chloride rich conditions. Based on a review of relevant literature, hot dip galvanizing, though not tested in this study, would also likely provide good protection if sufficient zinc thickness is provided.

As erosion begins to expose shop coated piles, it is recommended that pumped CLSM be used to fill voids between the soil and abutment. This will provide protection against further erosion, slow the progress of chlorides, reduce the levels of available oxygen, and prolong the life of the coating.

Due to the cost of installation and required maintenance, a galvanic cathodic protection system is not recommended for installation on new bridges. While the benefits of combined coating and cathodic protection systems are demonstrated in pipelines, piles can typically accommodate localized corrosion at small isolated areas of coating failure, unlike pipelines in which leaks can occur due to localized pitting. Therefore, the benefits are unlikely to outweigh the costs for a typical bridge abutment. If conditions deteriorate, cathodic protection could be installed in the future. The demand on future CP systems and the required number and weight of anodes will be significantly reduced if a coating, even a deteriorated one, is present to limit the exposed steel area.

Although thermally applied metallic coatings generally have higher initial costs than paint coatings, several studies, including a 1997 study by the FHWA (Ellor 2004), have shown them to have favorable life cycle costs on a per square foot basis due to their longer service lives and reduced maintenance costs. For the case of abutment piles, where coating maintenance is impractical, or at best difficult and costly, longer service life provides greater benefit than in a typical application. Regardless of the type of coating selected, costs associated with transporting piles to coating facilities and increased construction time are likely to outweigh costs associated with the coating materials themselves and their application.

Although the primary focus of this study is the atmospheric corrosion that has been observed at the exposed uppermost portions of abutment piles, substantial deterioration of buried piles in disturbed soils has been observed in several bridges throughout the nation. A recent example is the Leo Frigo bridge carrying I-43 over the Fox River in Green Bay, Wisconsin, where severe section loss in the vicinity of the water table in piles passing through an ash fill layer resulted in failure of the piles and significant settlement of one of the piers. If protection measures are to be installed to address future atmospheric corrosion of the upper portions of abutment piles at a new bridge, it would be prudent to evaluate the potential for corrosion of the buried portions of the piles as well. If site conditions warrant, consideration should be given to extending the protection to a depth where significant corrosion is unlikely to occur, such as to some limited distance below the water table. The coatings recommended above are well suited to this purpose. For installation in particularly corrosive environments, these coatings could be combined with sacrificial corrosion allowance to increase the service life of the piles.

Future Work

Based on the findings of the current study, recommendations for future work include the following:

Exposure of Field Coated Test Piles

WJE recommends that the three piles that were coated and encapsulated as part of this study be excavated and examined to evaluate the performance of the protection systems. Erosion and grade profile at the abutments, coating deterioration, and any observed pile corrosion should all be documented. A reasonable time frame for performing this examination would be approximately five years from the date they were coated (late spring or summer of 2018).

Installation of Shop Coated Piles

In order to evaluate the resistance of selected coatings to damage during handling and driving, we recommend that several shop coated piles be driven. This could likely be accomplished most economically if coordinated with a planned Iowa DOT bridge construction project. Coated test piles could be driven and subsequently pulled or exposed by excavation, allowing observation and documentation of coating damage. Additional coated piles could be installed as part of the permanent structure, allowing for long term observation. This exercise would also facilitate an evaluation of the costs associated with coating new piles.

Cathodic Protection Field Trial

The laboratory study of cathodic protection reported above evaluated the system performance under very corrosive conditions. To provide a basis for evaluating the performance of the installation of CP system in more realistic conditions, where the soil corrosivity may be less, a field trial is recommended. The objective of the field trial would be to: 1) verify applicability of galvanic anodes in field (proof of concept), 2) determine output from anodes with time in this setting (expected lifespan), and 3) assess

effect of anode location relative to the abutment. This field trial could consist of 30-lb zinc anodes buried at the site, each connected to a pile (one anode per pile). A mortar of similar composition to the tested corrosion inhibitor mix could be pumped into the void between the abutment and grade after anode installation. A possible limitation of the cathodic protection system combined with grouting of voids that could be evaluated in the field is the potential for additional erosion to occur at the grout/soil interface, exposing a new length of pile that would not be protected by the CP system.

As previously discussed, the life of a 30-lb zinc anode connected to an uncoated HP10x42 pile can be expected to be at least 8 years, and likely longer. The objective of the study would be achieved by monitoring consumption of the anodes both electrically (by measurement of current from each anode) and by extracting and weighing the anodes after 8 years. Periodic depolarization testing would also provide insight into the level of protection achieved at the piles. The configuration of the anode installation could be varied from one abutment to the other to evaluate the requirements for the layout of the anodes. In addition, the corrosivity of the soil system could be evaluated through steel test coupons weighed and then buried at various depths at the site. Some coupons would be left to corrode independently, while others would be wired to the pile/anode system and receive similar protection as the piles.

Evaluation of Runoff Diversion Methods

In WJE's 2006 study, many of the abutments where exposed piles were observed were found to exhibit the most severe erosion at the ends of the abutment, where runoff passed along the wingwalls, then under the abutment. This erosion could be minimized by directing runoff away from the abutment. Potential methods of accomplishing this could include extending the bridge barrier a greater distance beyond the end of the bridge or providing longer wingwalls with a greater included angle to the abutment. Due to the multitude of specification requirements for roadside drainage, barrier rails, transitions, and curbs, any possible runoff diversion methods should be evaluated in close cooperation with Iowa DOT engineers.

SUMMARY AND CONCLUSIONS

Soil consolidation and erosion caused by roadway runoff have exposed the upper portions of steel piles at the abutments of numerous bridges in Iowa and elsewhere. The exposed portions of the piles are susceptible to accelerated corrosion rates due to the abundance of moisture, oxygen, and chlorides at these locations. Severe corrosion, if not addressed, has the potential to significantly reduce the capacities of the piles, a problem that would be difficult and costly to address. This problem is compounded by the relative inaccessibility of abutment piles for close-up inspection and repair. The objective of this study was to provide bridge owners with recommendations for effective methods of addressing corrosion of steel abutment piles in existing and future bridges.

A review of available literature on the performance and protection of steel piles exposed to a variety of environments was performed. Eight potential coating systems for use in protecting existing and/or new piles were selected and subjected to accelerated corrosion conditions in the laboratory. Two surface preparation methods were evaluated in the field and three coating systems were installed on three piles at an existing bridge where abutment piles had been exposed by erosion. Based on the findings of the literature review, laboratory tests, and field tests, application of a protective coating was determined to be a promising option for mitigation of corrosion of both new and existing abutment piles. Abrasive blast cleaning to SSPC-SP6 is recommended for surface preparation of existing piles, while SSPC-SP5 or SP10 are recommended for new piles. Recommended coatings for existing piles are glass flake polyester as a first choice, followed by epoxy over organic zinc rich primer as an alternative. Recommended coatings for new piles are thermally sprayed aluminum and glass flake polyester.

A passive cathodic protection (CP) system using sacrificial zinc anodes was tested in the laboratory. In addition, several trial flowable mortar mixes were evaluated. The mortar allows conduction of ions from the CP system anode to the exposed (above-ground) portion of a pile to mitigate corrosion. Results of the laboratory tests can be used to develop a trial CP and mortar system for installation on an existing bridge. Based on the results of the laboratory tests, galvanic CP could be an effective means of mitigating corrosion of abutment piles in existing bridges, when combined with a pumped mortar used to fill voids between the abutment footing and soil. The addition of a corrosion inhibitor to the mortar appears to be beneficial.

Several recommendations for future work are proposed, including exposure of the field coated test piles, installation of shop coated test piles, a field trial of a CP system, and evaluation of runoff diversion systems.

Figures



Figure 1. Erosion and exposed pile at bridge abutment



Figure 2. Staked plywood sheets for erosion control



Figure 3. Erosion repair using grout material



Figure 4. Laminar corrosion at bridge pile



Figure 5. Pitting in bridge pile



Figure 6. Covered pile after excavation with little corrosion



Figure 7. Perforations in flange and web of exposed pile



Figure 8. Test panels cut from ASTM Rust Grade D corroded 1/4 in. ASTM A36 steel plate, prior to surface preparation

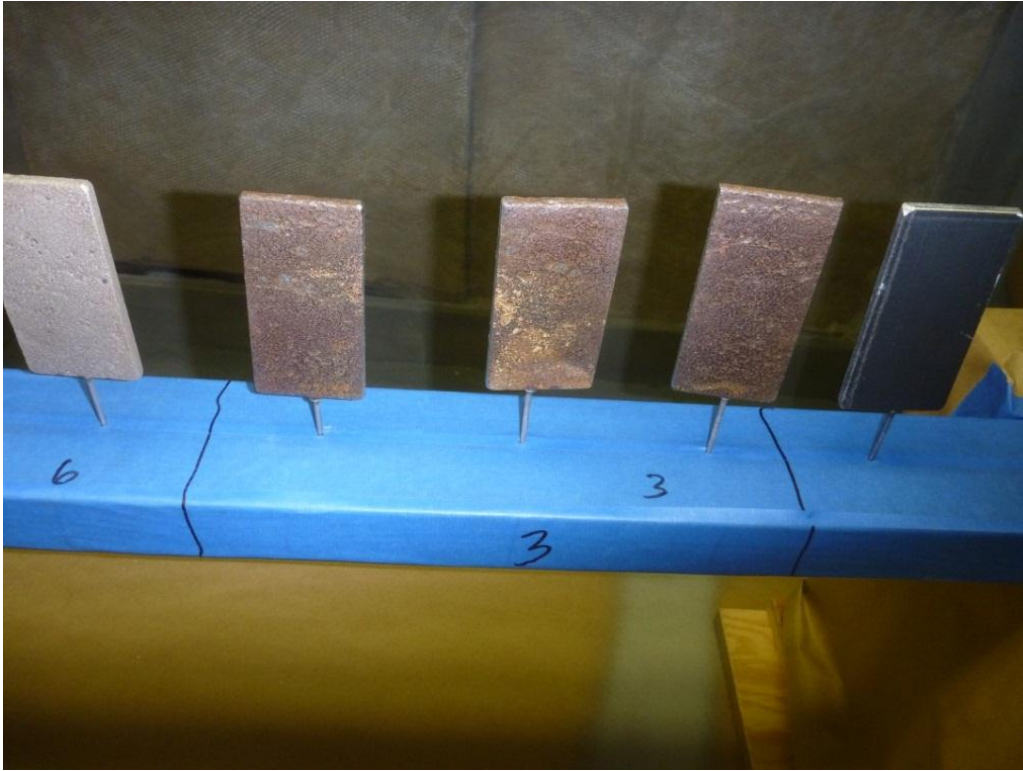

Figure 9. Test panels prepared to SSPC SP-3 standard

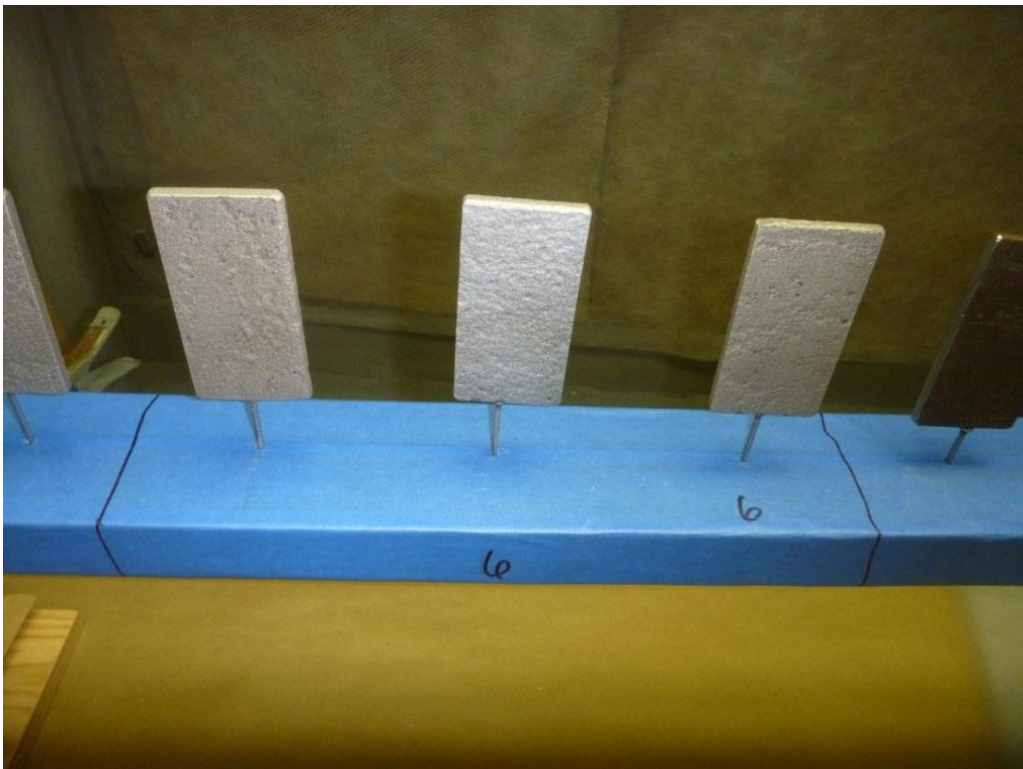

Figure 10. Test panels prepared to SSPC SP-6 standard

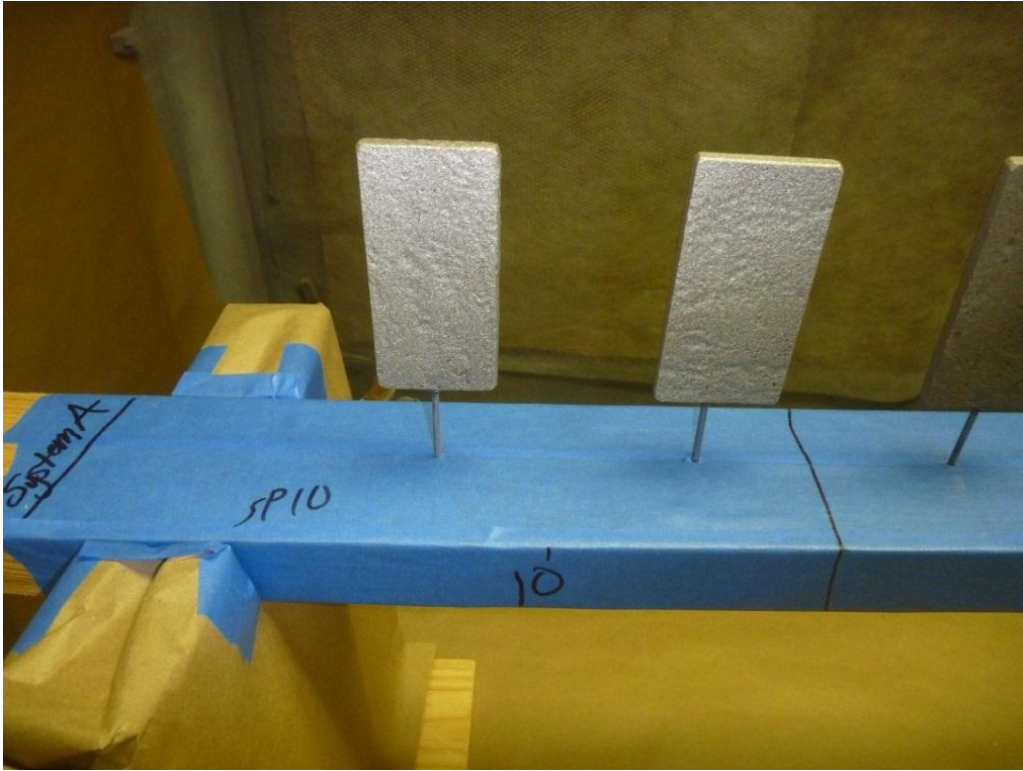

Figure 11. Test panels prepared to SSPC SP-10 standard

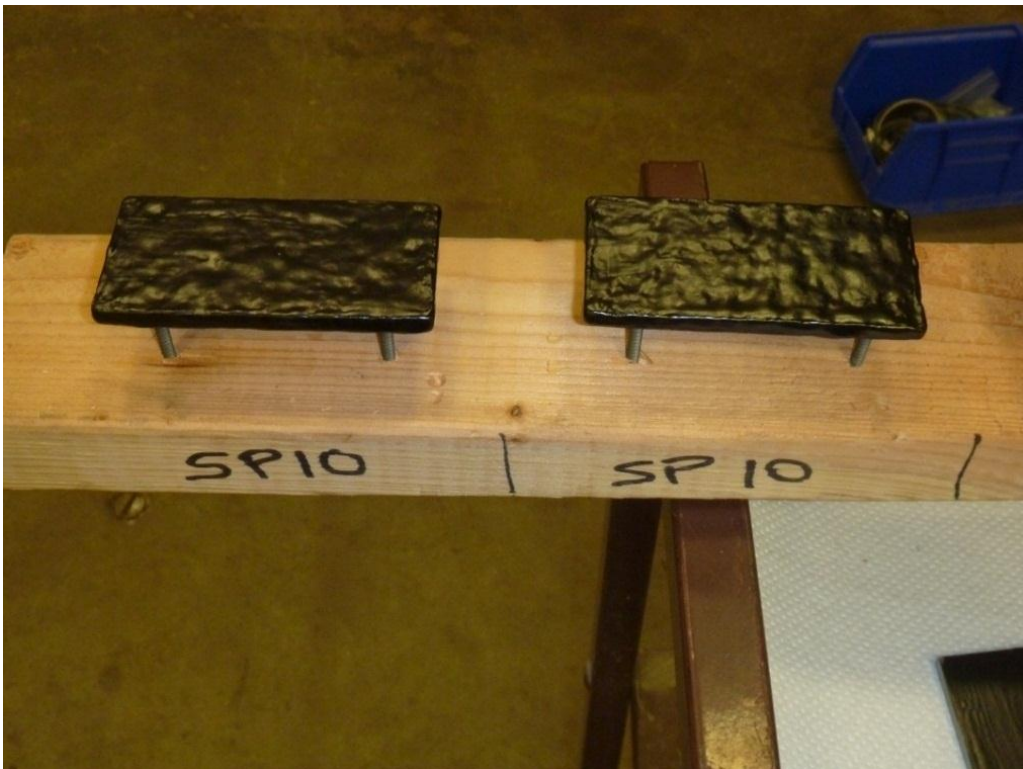

Figure 12. Test panels coated with bituminous mastic



Figure 13. Formed grout encapsulation of test panels

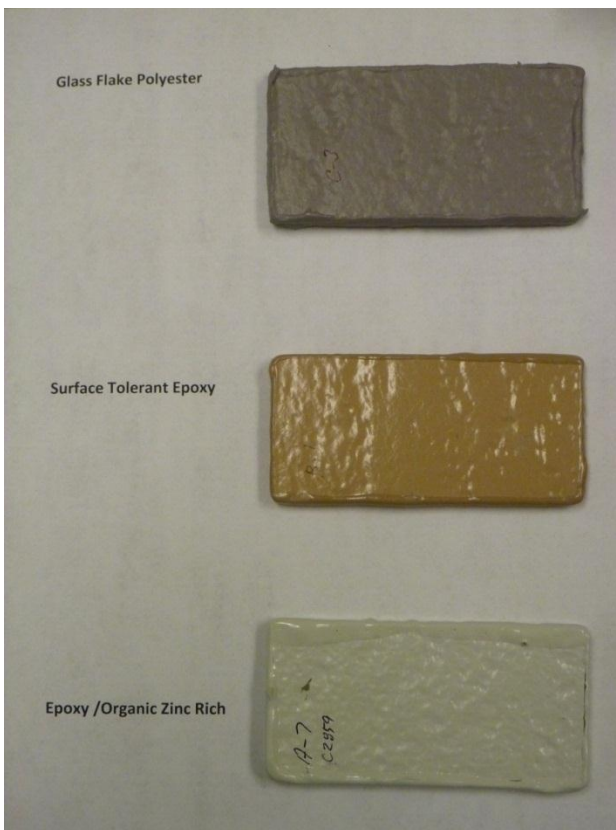

Figure 14. Test panels coated with glass flake polyester, surface tolerant epoxy, and epoxy over organic zinc rich primer



Figure 15. Spray application of glass flake polyester coating

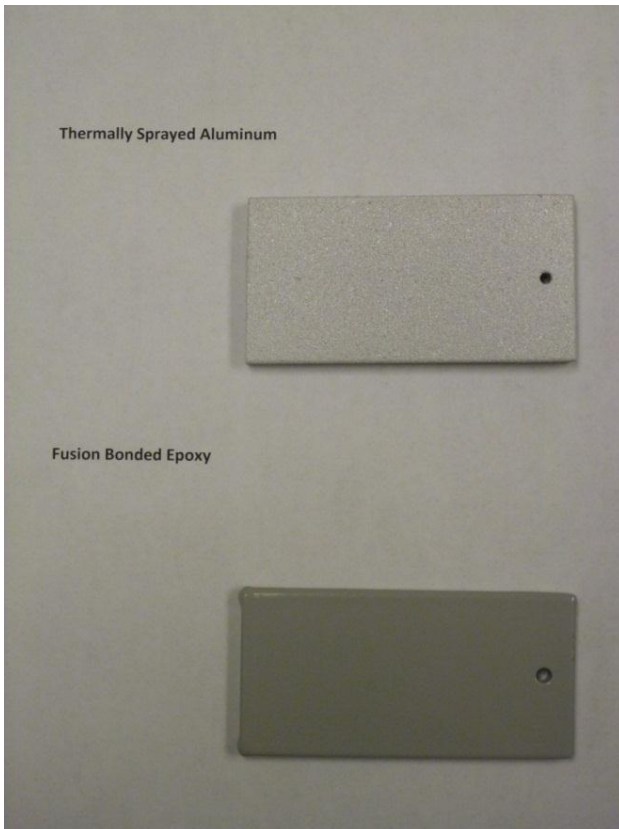

Figure 16. Test panels coated with thermally sprayed aluminum and fusion bonded epoxy

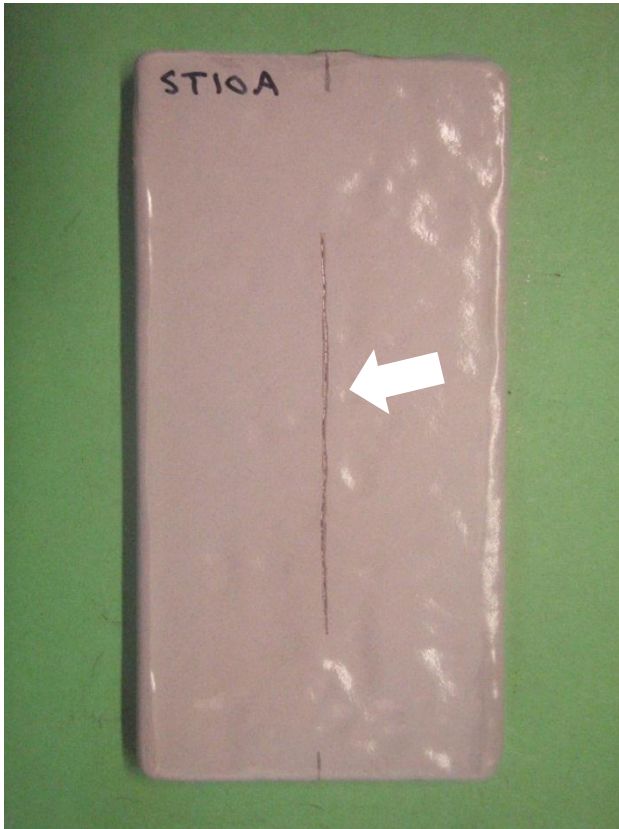

Figure 17. Typical scribe mark on coated test panel



Figure 18. Cyclic immersion test setup



Figure 19. Close-up view of test panels. Arrow points to automatic stirrer.

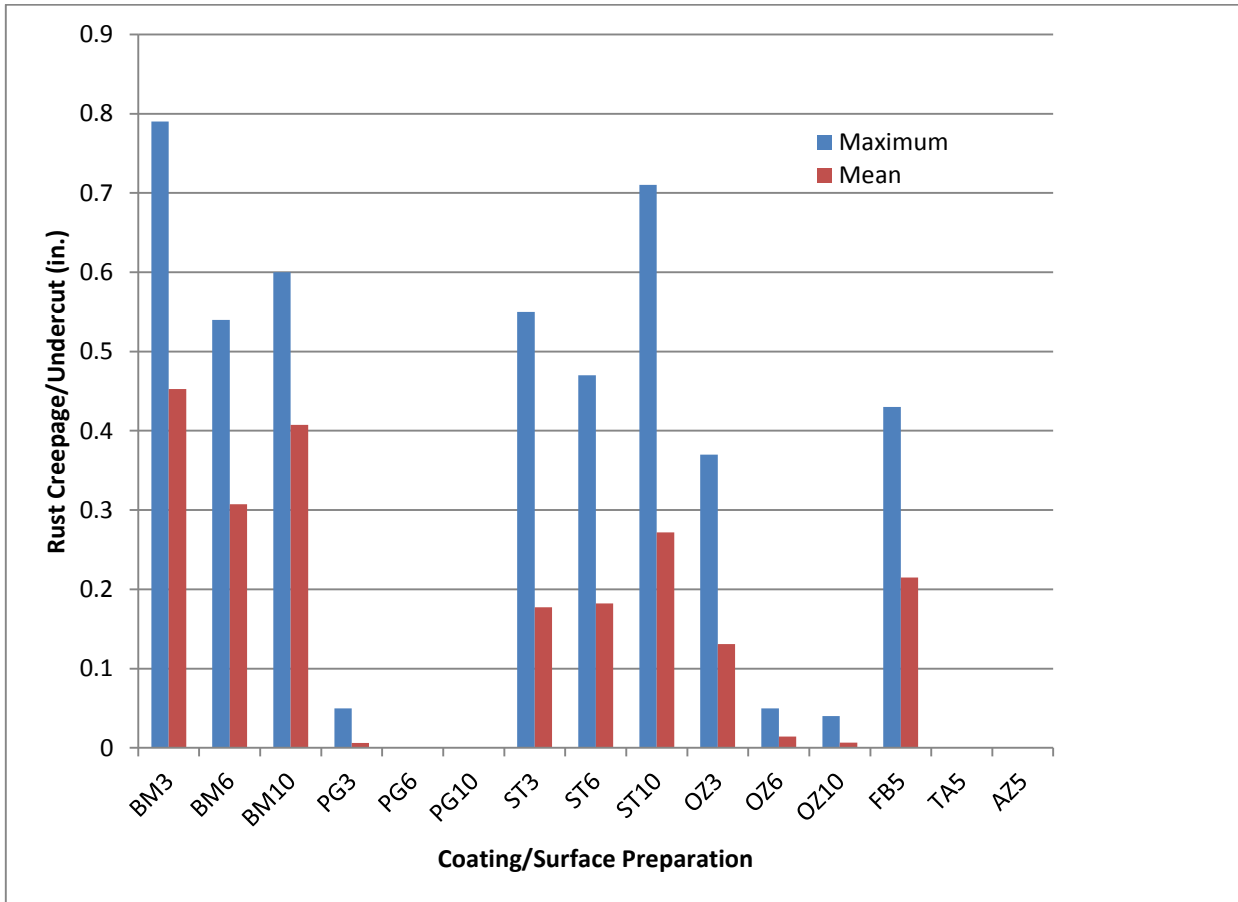

Figure 20. Maximum and mean undercut for each coating and surface preparation combination after 12 months of cyclic dip testing



Figure 21. Test setup used for LPR and Potentiostatic EIS testing. Hidden from view in the grey bucket is a salt solution deep enough to submerge 50% of the coated specimen (working electrode), a Ag/AgCl reference electrode, and a graphite counter electrode. The Gamry unit to the left is a potentiostat used to control the tests.

Estimated Corrosion Rate Over Area of Scratch, as Measured by Linear Polarization Resistance

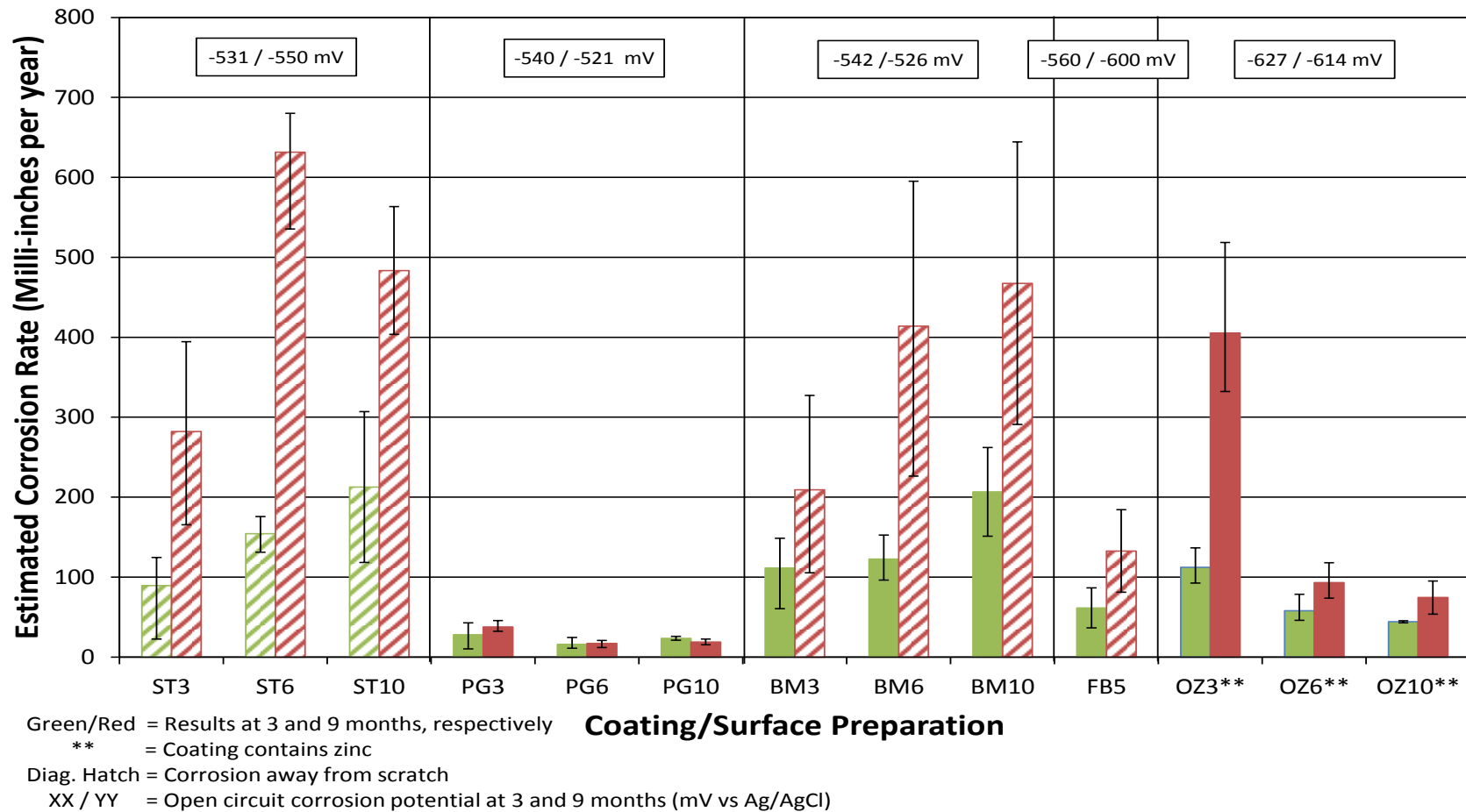

Figure 22. Estimated corrosion rate of specimens with inert coating types after 3 and 9 months of cyclic dipping. Specimen groups are named along the x-axis indicating type of coating and surface preparation.

Estimated Corrosion Rate Over Submerged Surface Area, as Measured by Linear Polarization Resistance

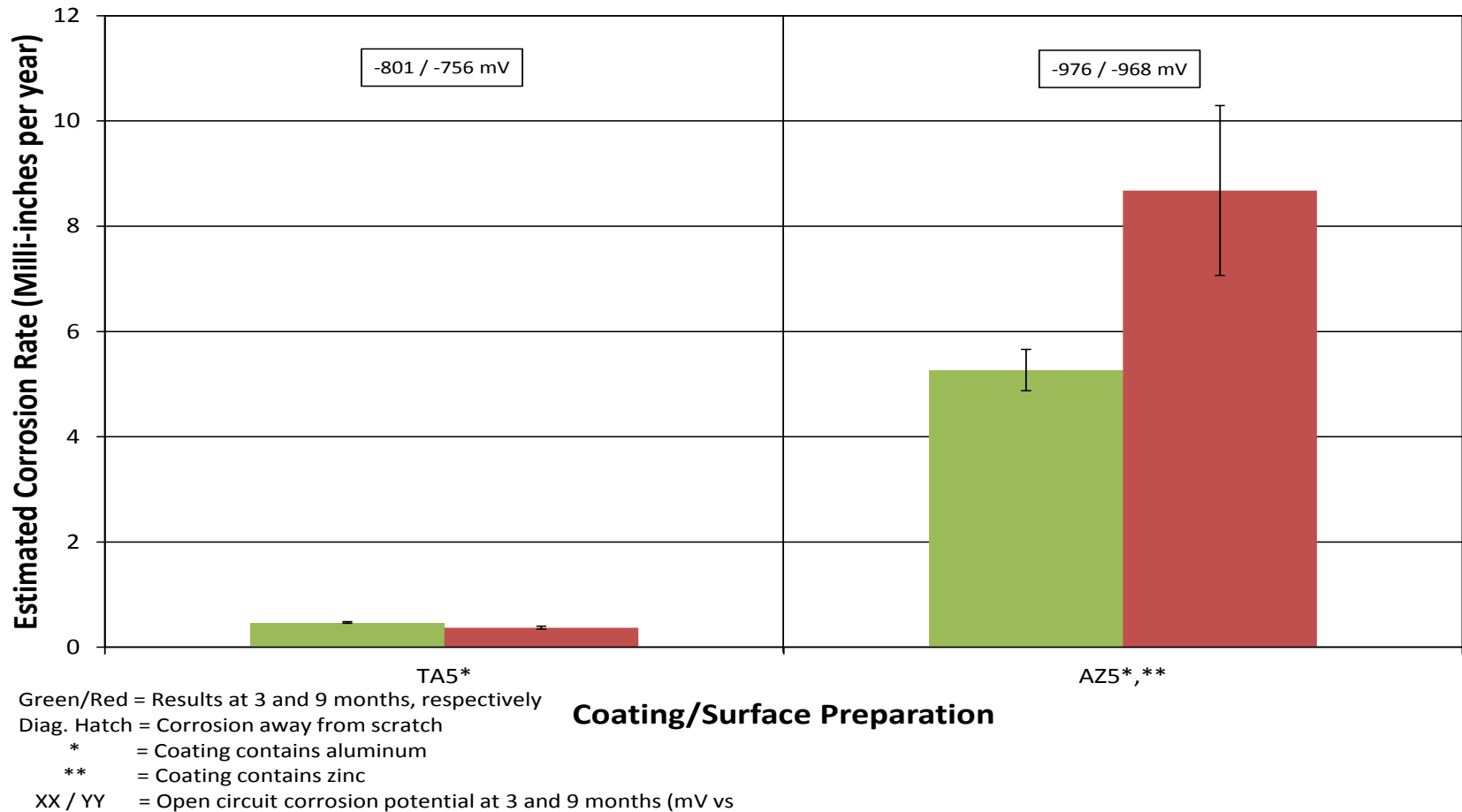

Figure 23. Estimated corrosion rate of specimens with active coating types after 3 and 9 months of cyclic dipping. Specimen groups are named along the x-axis indicating type of coating and surface preparation.

**Estimated Corrosion Rate Over Entire Coupon Area,
as Measured by Linear Polarization Resistance and Potentiostatic EIS**

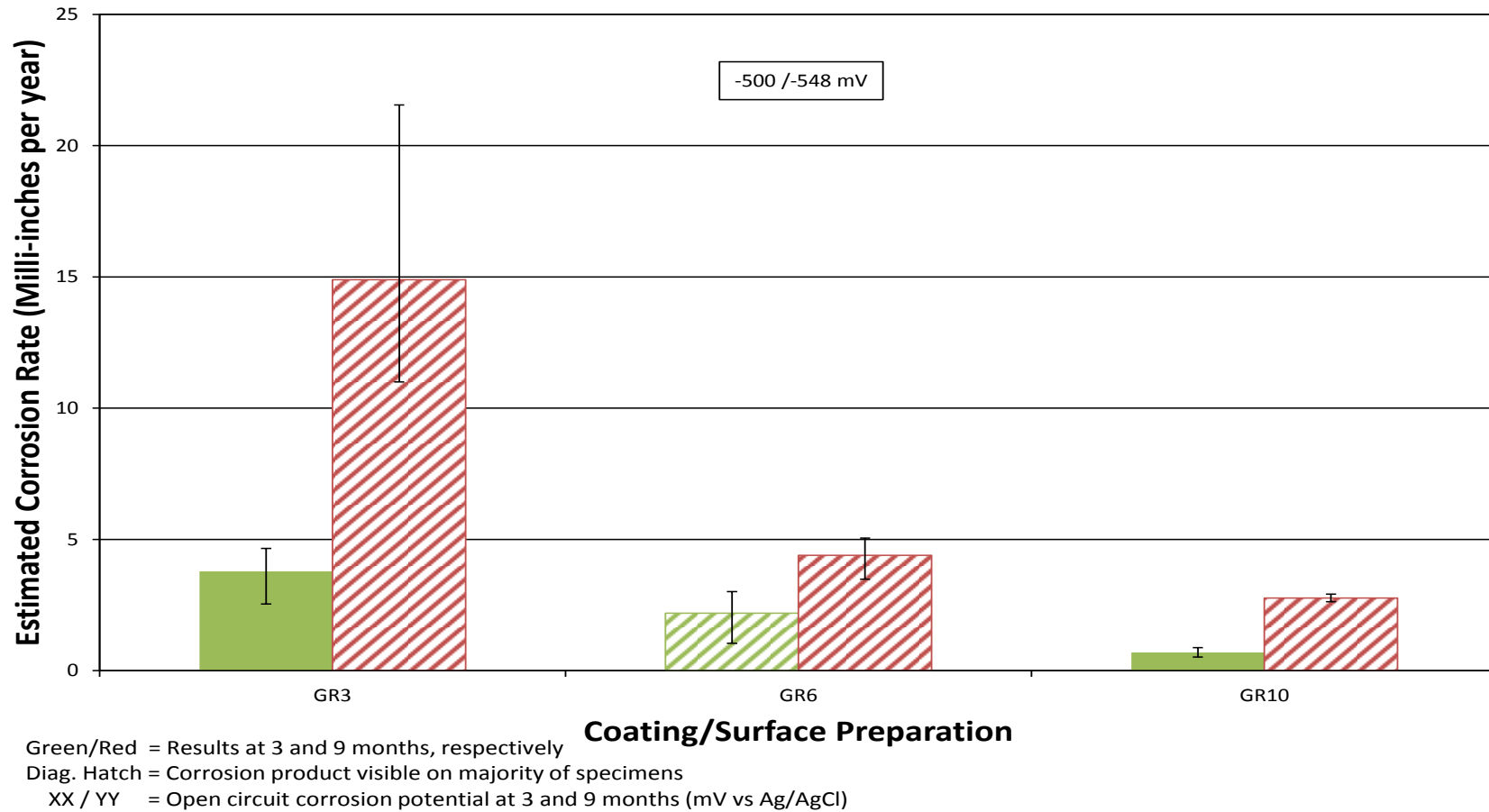

Figure 24. Estimated corrosion rate of specimens encased in grout after 3 and 9 months of cyclic dipping. Specimen groups are named along the x-axis indicating grout encasement and type of surface preparation.



Figure 25. Erosion at north end of west abutment of Bridge No. 9081.5S034



Figure 26. Excavations at Piles 1 and 2



Figure 27. Pile 1 after mechanical removal of soil from pile surfaces



Figure 28. Abrasive blast cleaning of Pile 1



Figure 29. Example of difficult-to-reach location on pile requiring additional cleaning effort. Note remnants of clay soil in corner of web, flange, and footing.



Figure 30. Typical abrasive blast cleaned surface at relatively difficult to reach area of pile



Figure 31. Typical abrasive blast cleaned surface at relatively easy to reach area of pile



Figure 32. Typical prepared surface using the MBX Bristle Blaster



Figure 33. Pile/abutment interface inaccessible for surface preparation with MBX Bristle Blaster



Figure 34. Field application of polyester glass flake coating



Figure 35. Field application of zinc rich organic primer



Figure 36. Field application of epoxy top coat



Figure 37. Completed form for formed grout encapsulation



Figure 38. Filling of grout form using manual grout pump



Figure 39. Completed formed grout encapsulation



Figure 40. Soil tank for cathodic protection test

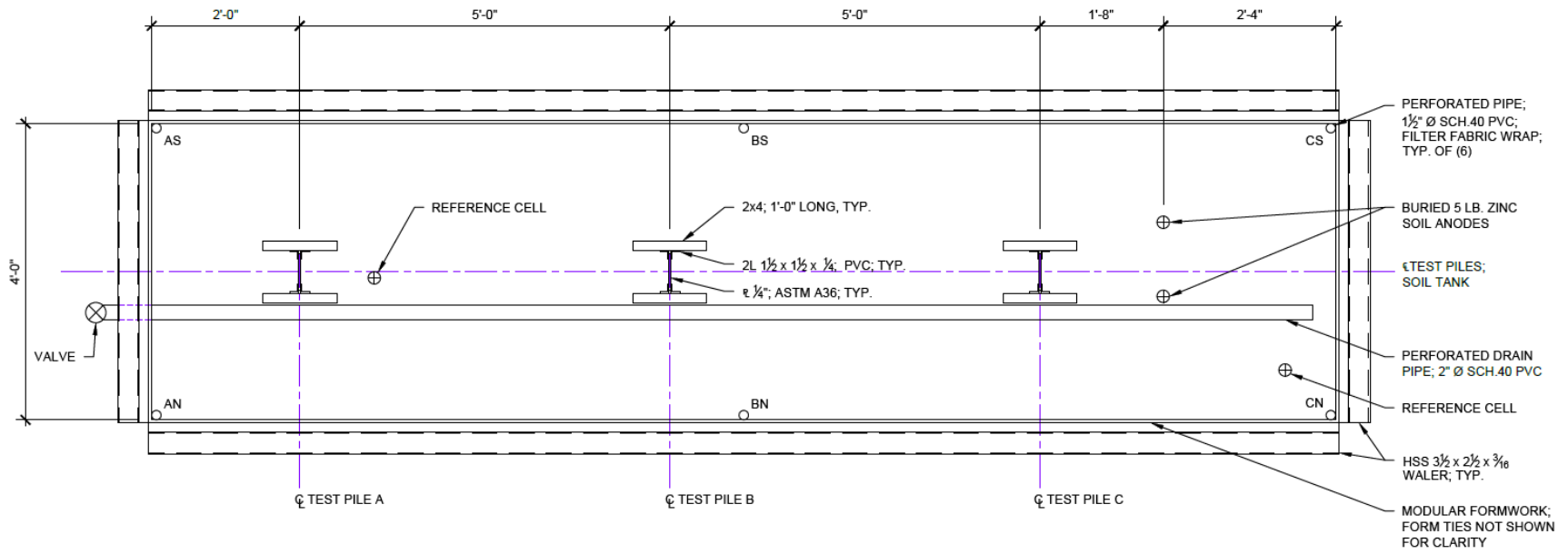

Figure 41. Plan of soil box layout

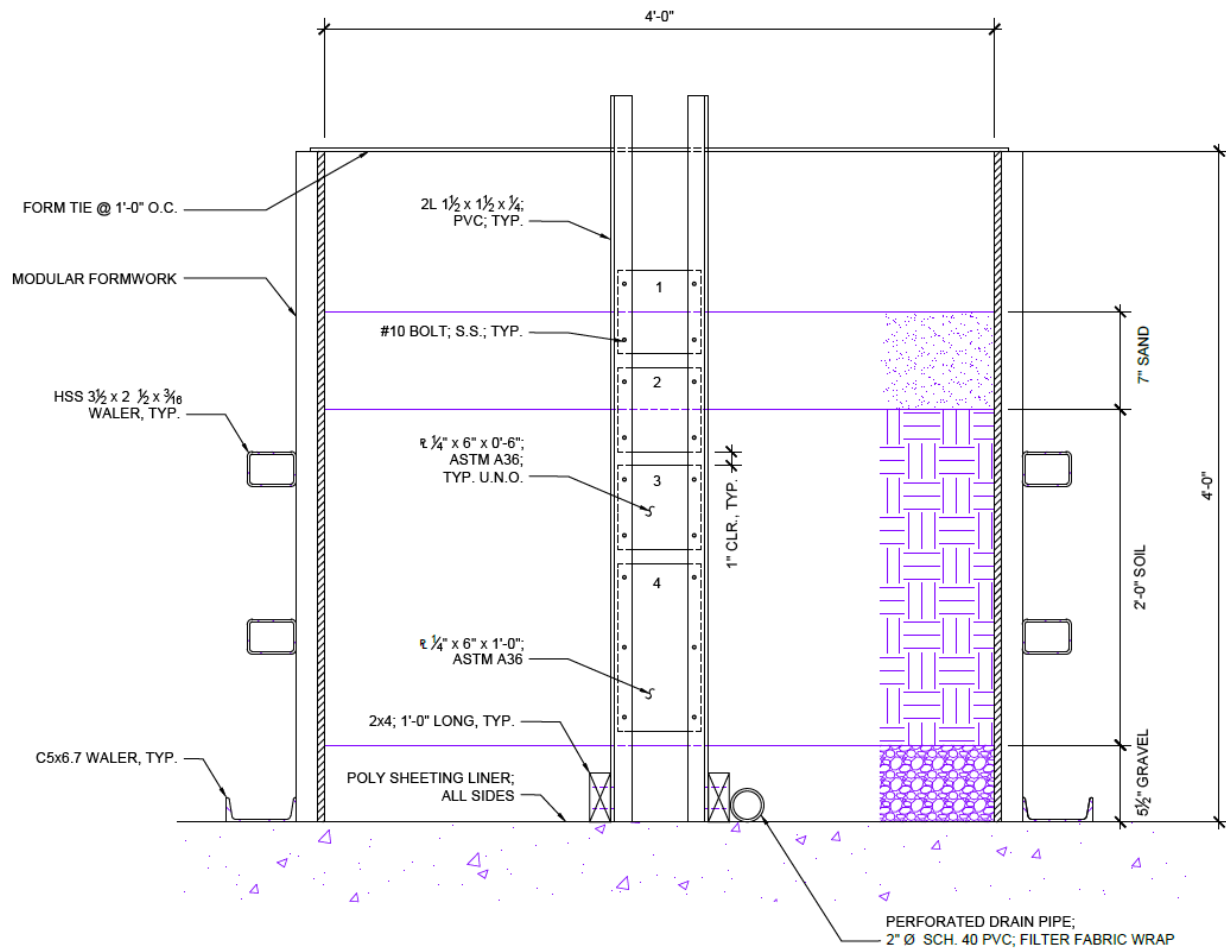

Figure 42. Section through soil box



Figure 43. Partially assembled test pile.



Figure 44. Perforated drain and poly sheet barrier.



Figure 45. Test piles and gravel installed in soil tank. Note vertically oriented perforated PVC pipes for monitoring of water level during test.

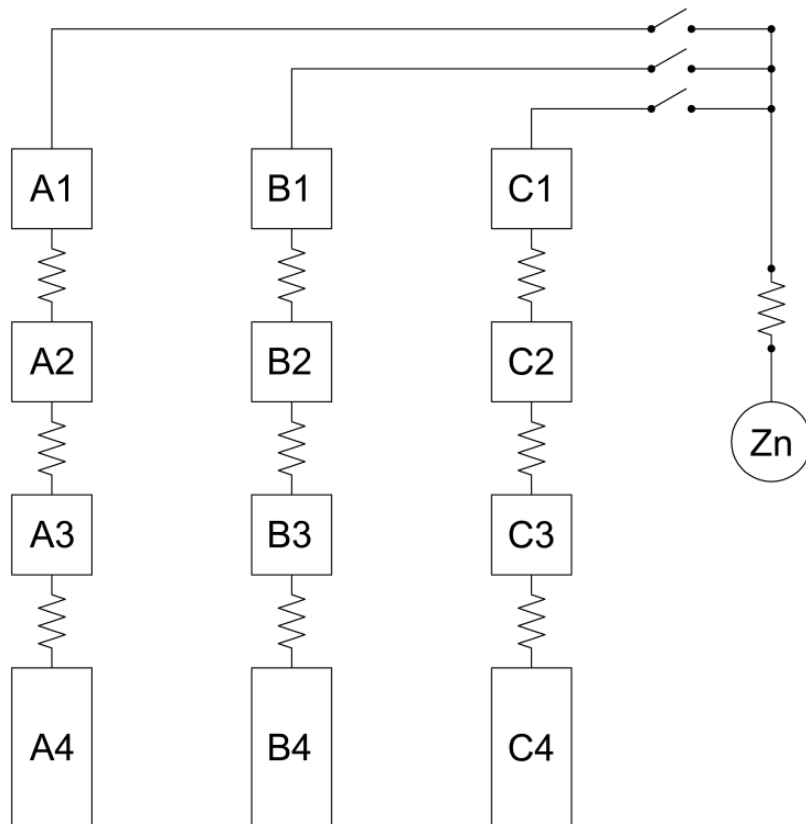

Figure 46. Wiring diagram for Setup No. 1. All resistors shown were 1 ohm.

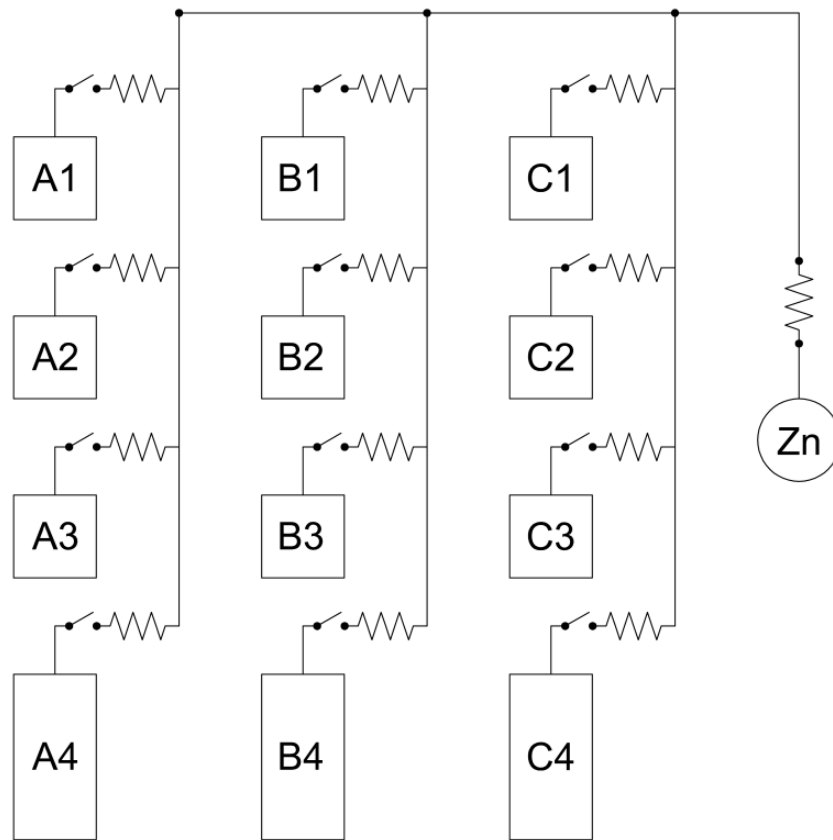

Figure 47. Wiring diagram for Setup No. 2 All resistors shown were 1 ohm.

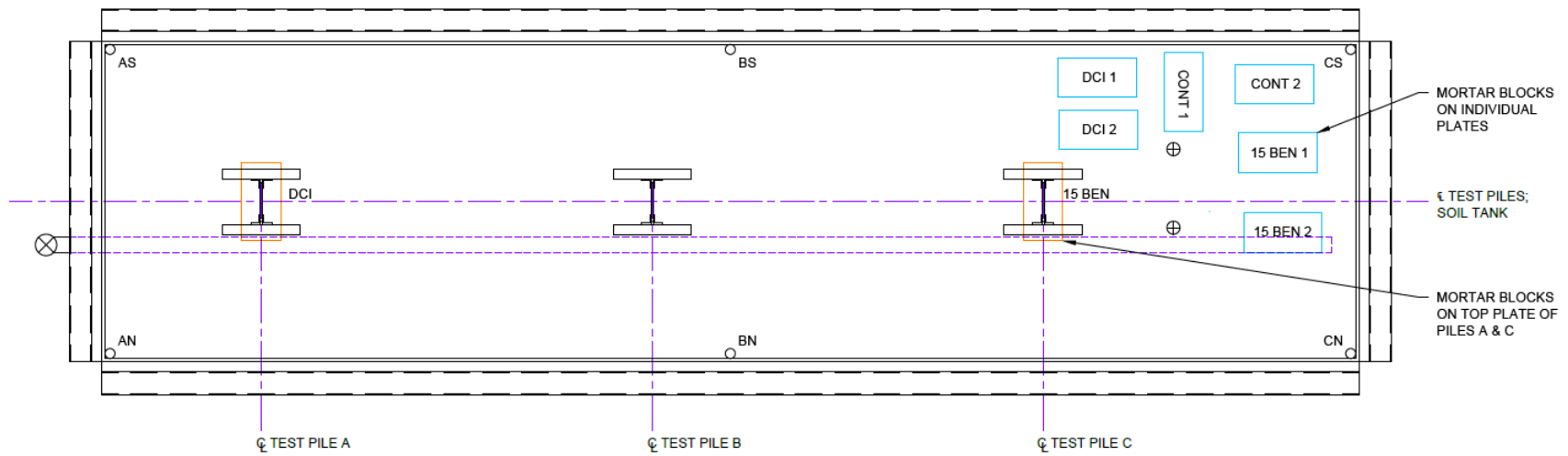

Figure 48. Layout of mortar blocks around individual plates (blue) and top pile plates (orange)



Figure 49. Overall view of soil box

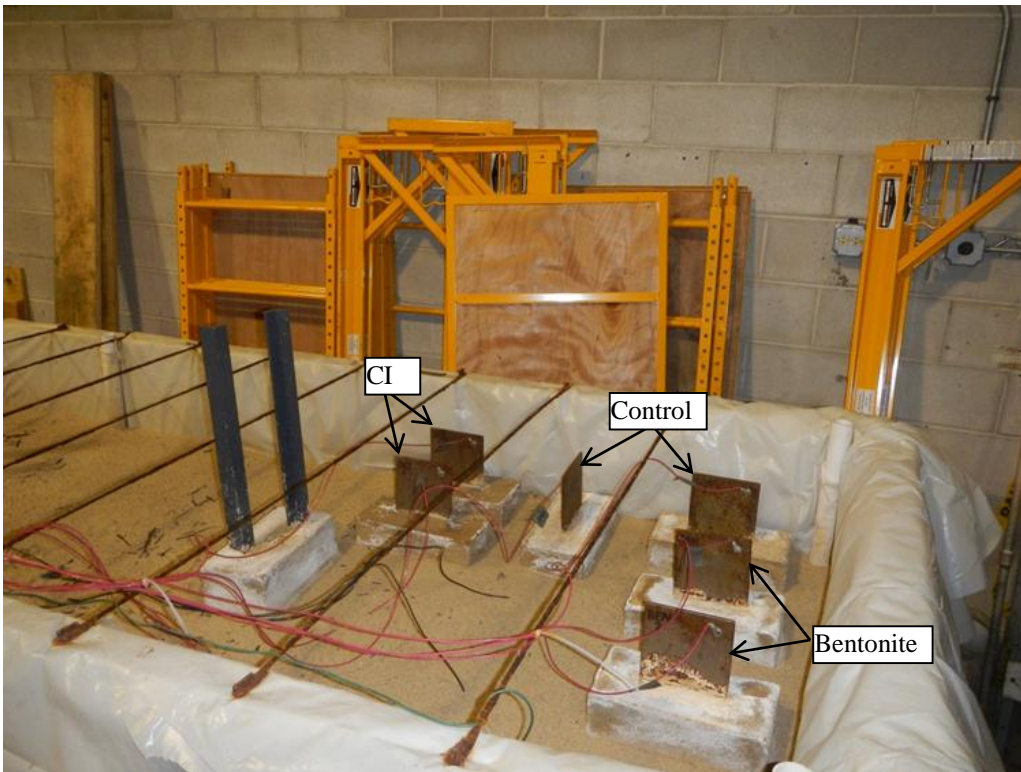

Figure 50. Layout of mortar blocks

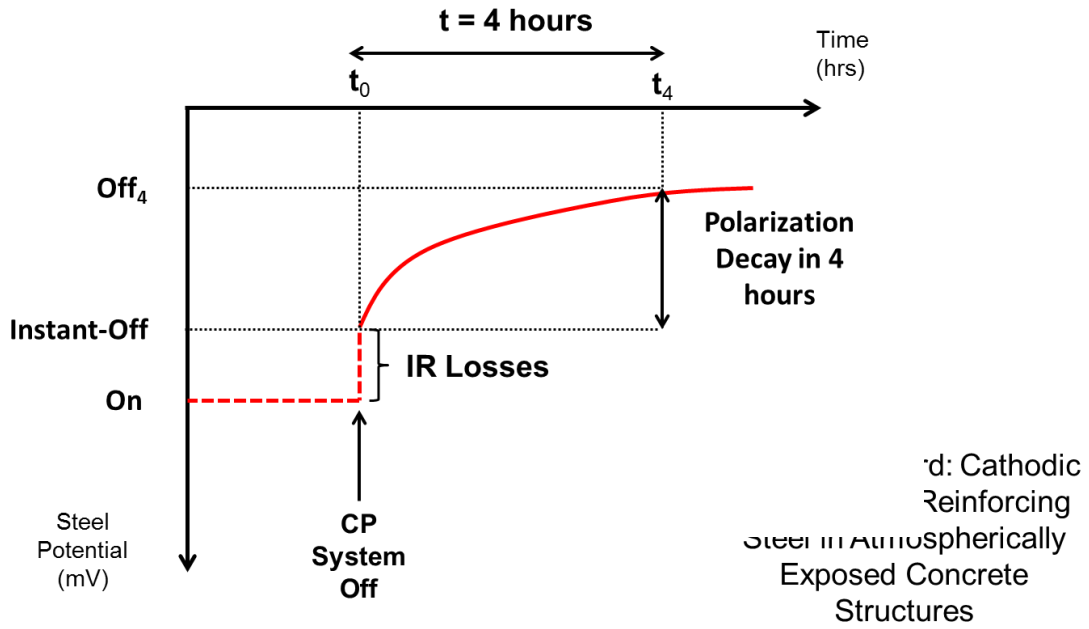

Figure 51. Typical potentials measured in depolarization test.

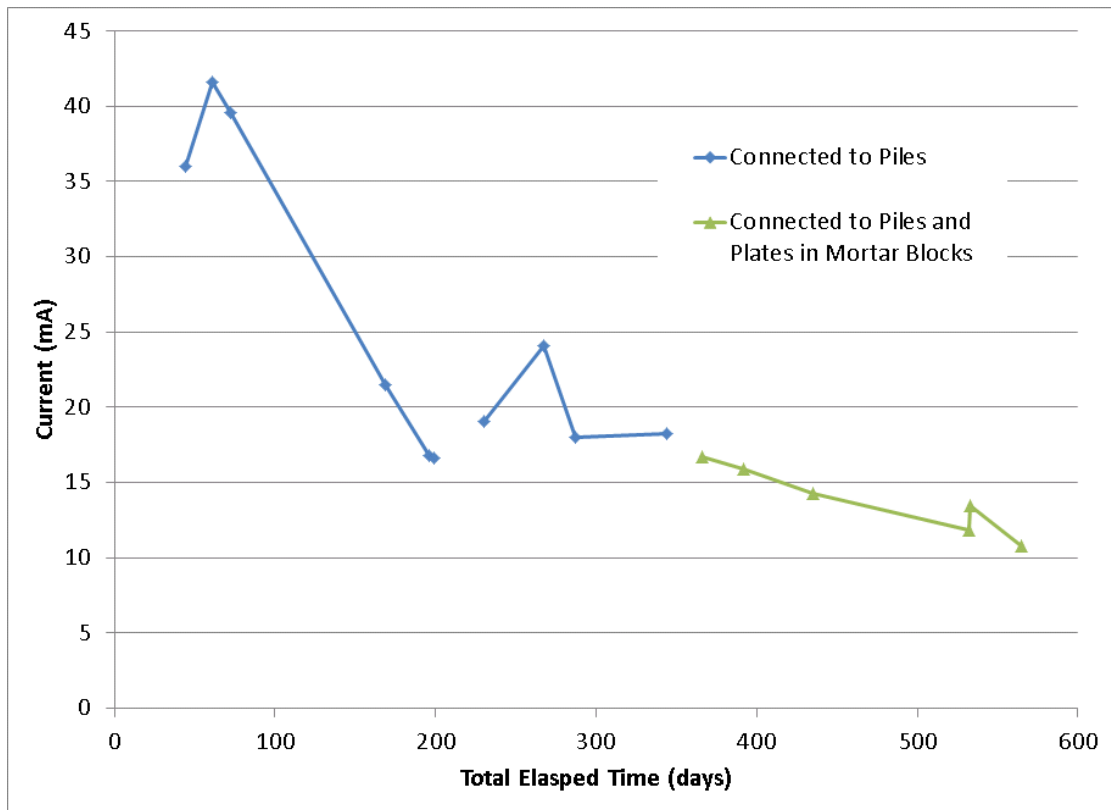

Figure 52. Total current from Anode No. 1 to 1) piles and 2) piles and plates in mortar blocks

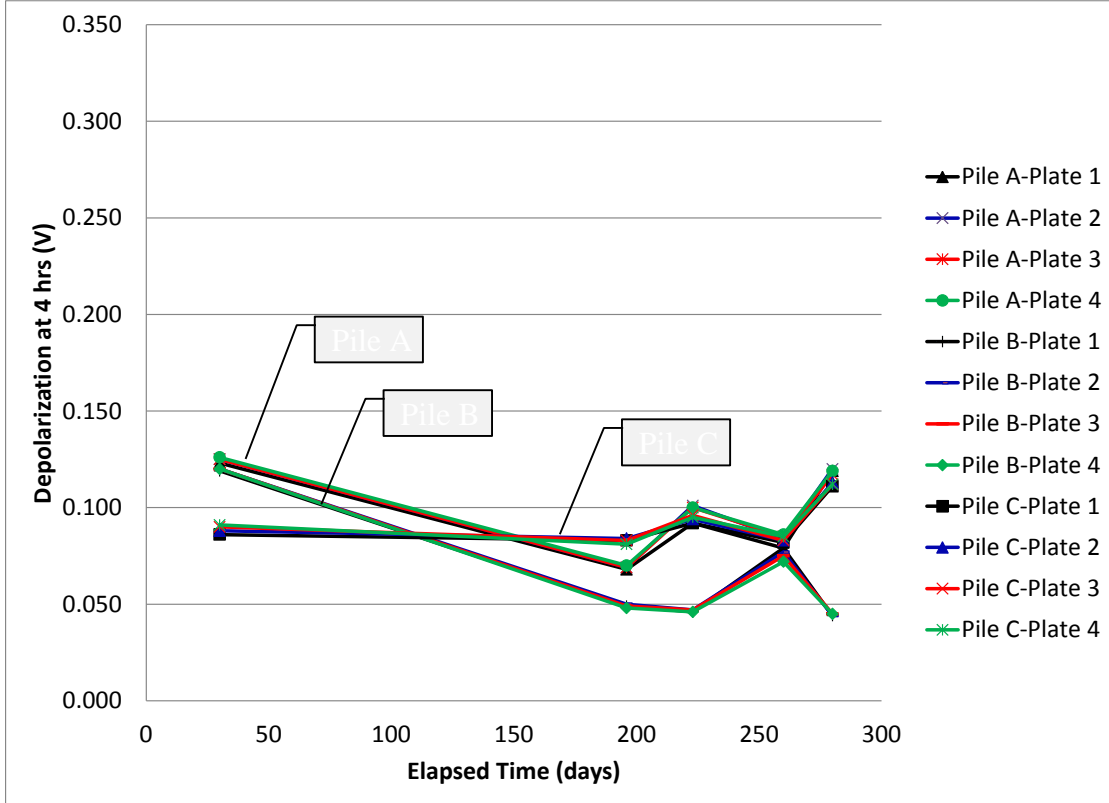

Figure 53. Depolarization after 4 hours at each pile plate versus elapsed time connected to Anode No. 1 using Setup No. 1.

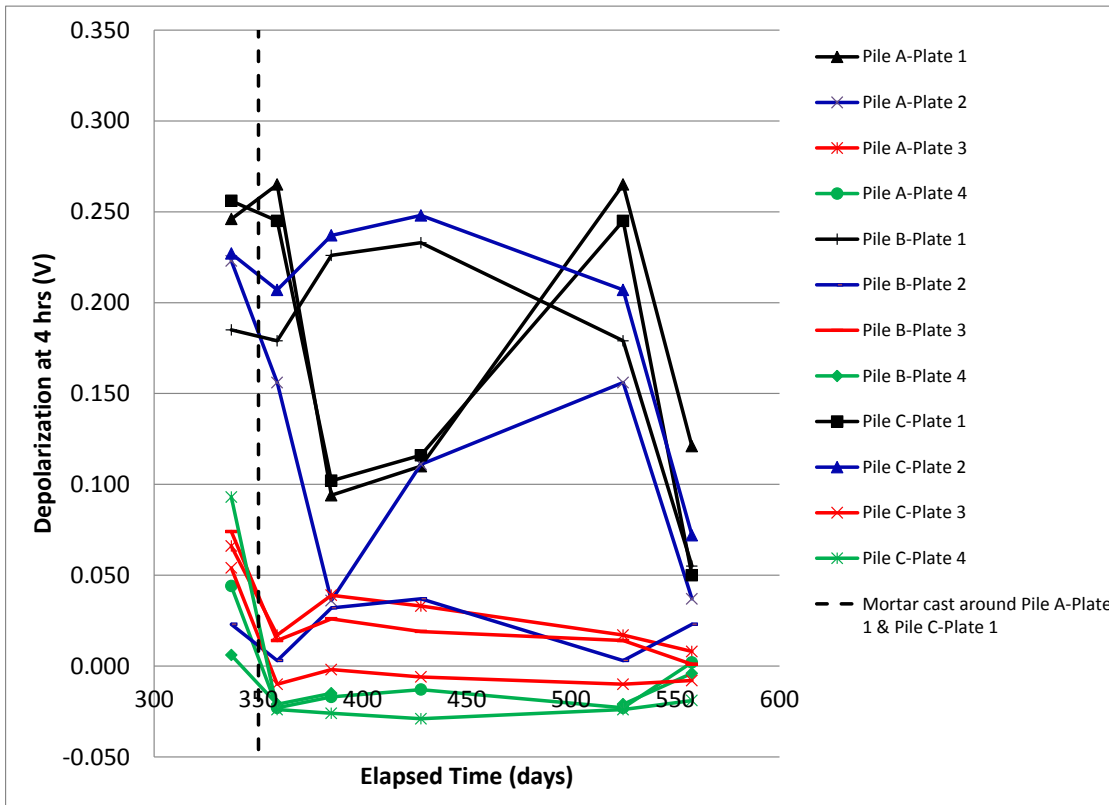

Figure 54. Depolarization after 4 hours at each pile plate versus elapsed time connected to Anode No. 1 using Setup No. 2

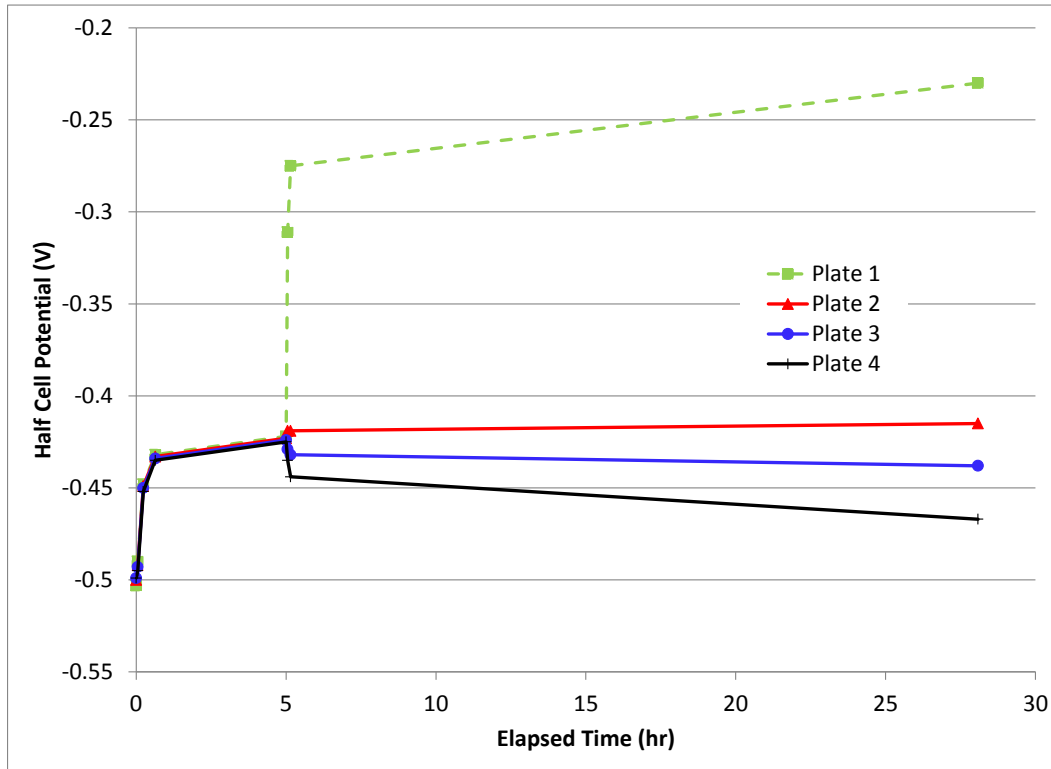

Figure 55. Typical depolarization curve, showing change in potential of Plates 1 to 4 after individual plates were disconnected from each other after 4-hour depolarization test. (This data collected relative to Reference Cell No. 1 on Feb. 22, 2012).

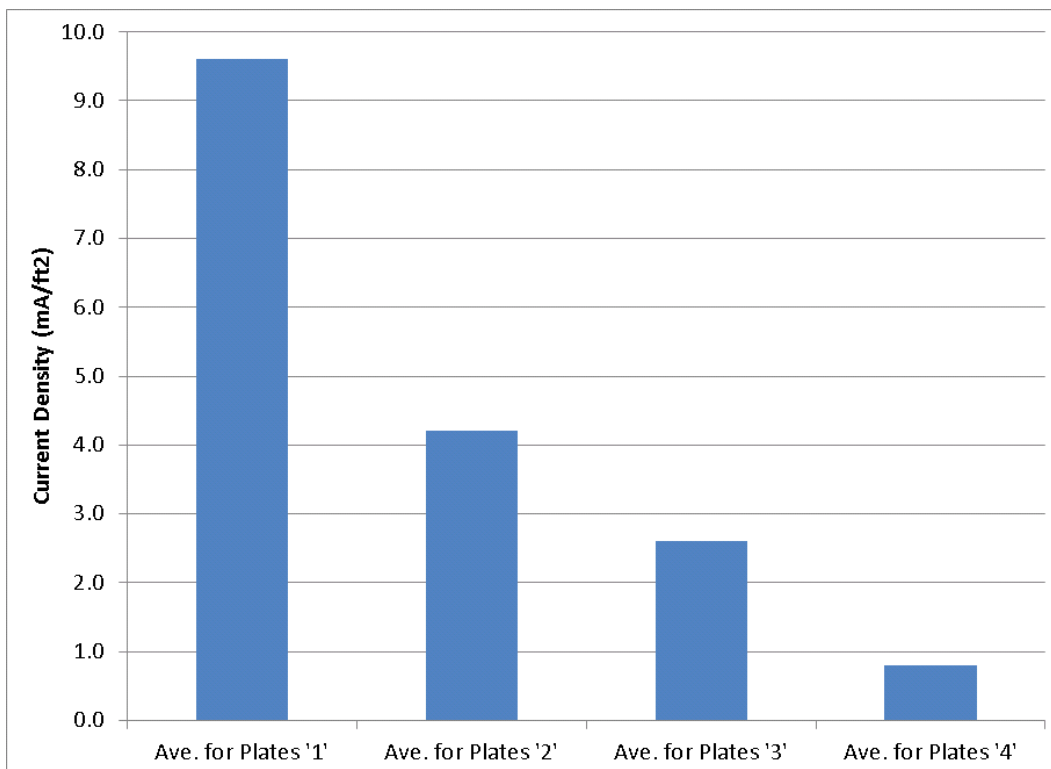

Figure 56. Average protection current density to plates between 230 and 287 days after connection was made to Anode No. 1.

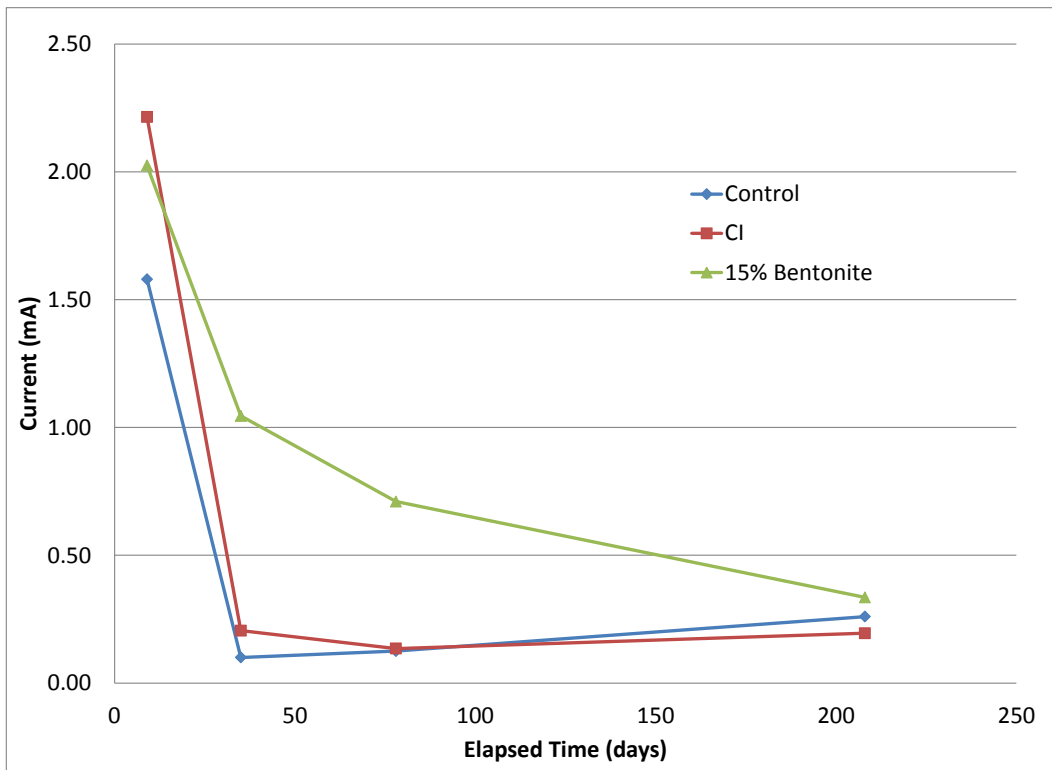

Figure 57. Average current to plates in mortar blocks versus elapsed time connected to Anode No. 1

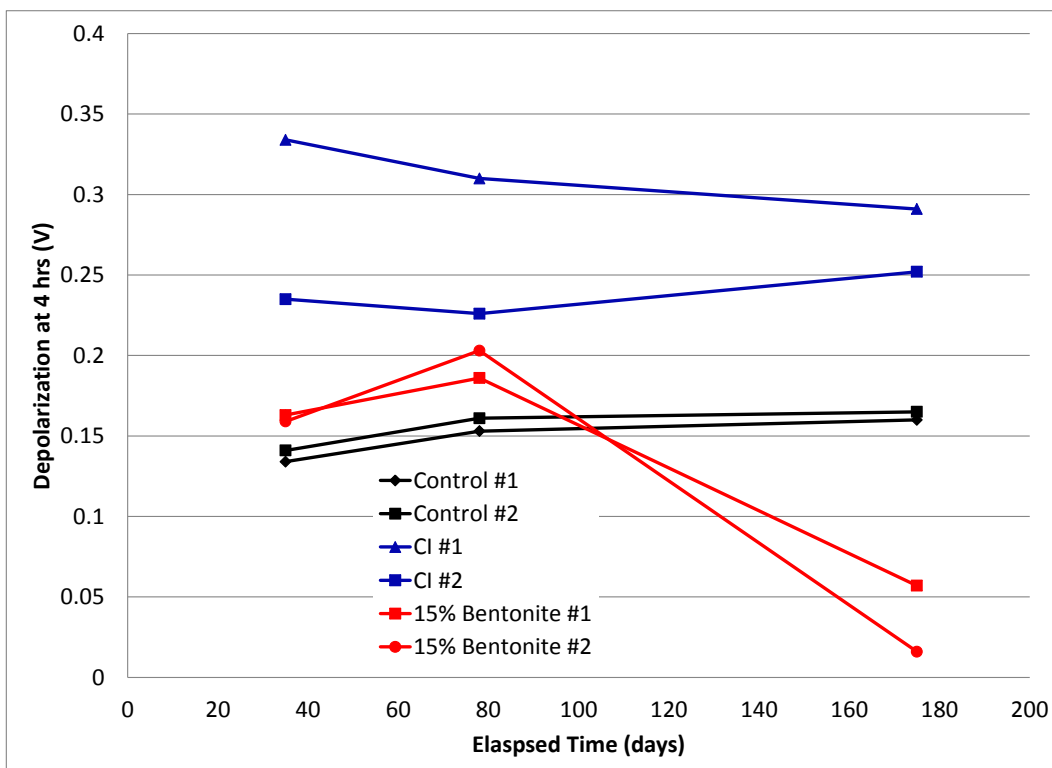

Figure 58. Depolarization after 4 hours at each plate versus elapsed time connected to Anode No. 1 using Setup No. 1.

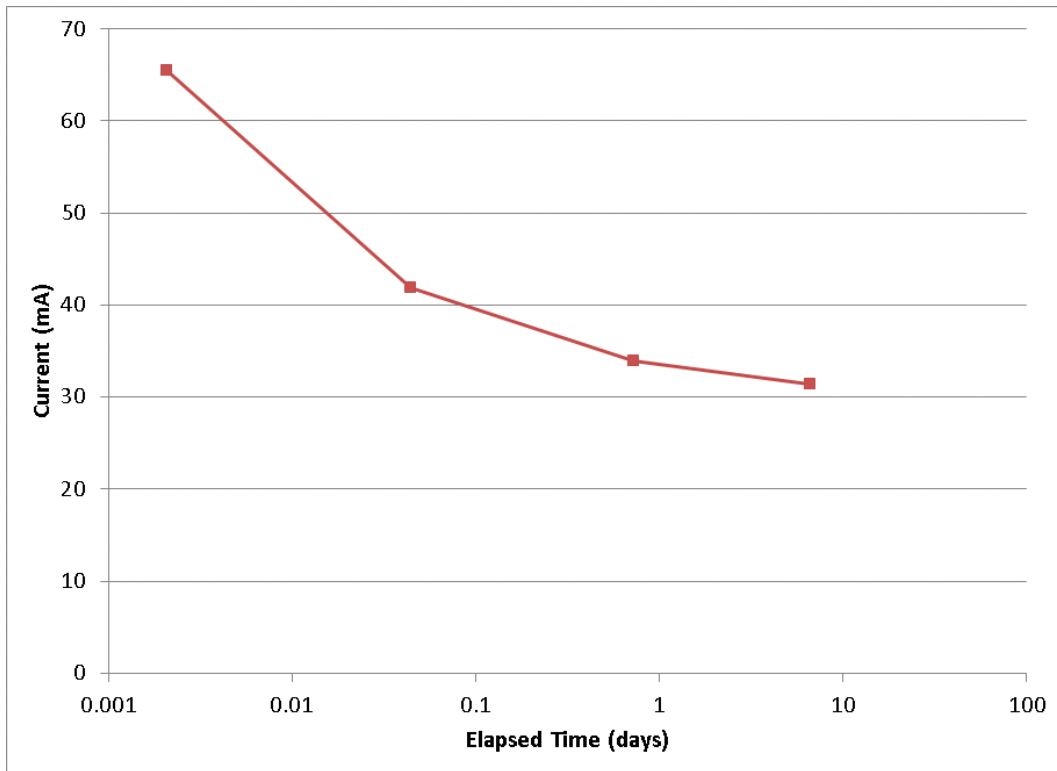

Figure 59. Total current from Anode No. 2 to piles.



Figure 60. Piles after cleaning with wire brush



Figure 61. Close-up view of top plates of each pile after cleaning with wire brush

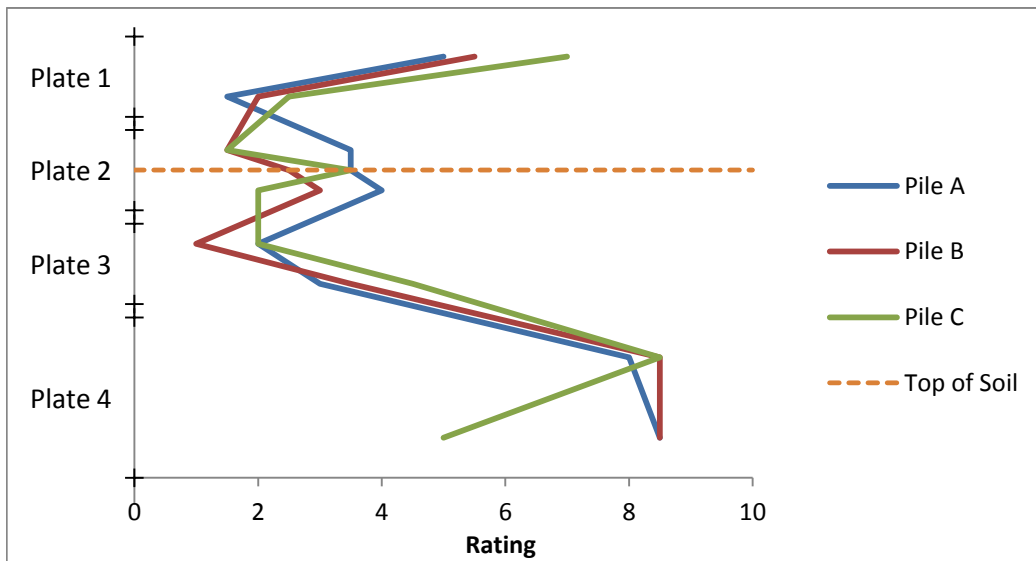

Figure 62. Visual rating of corrosion on pile top plates at end of testing, from 1 (best) to 10 (most severe).



Figure 63. Plate 1 of Pile A before and after mortar block (top of sand is white line).



Figure 64. Plate 1 of Pile B before and after mortar blocks on other piles (top of sand is white line). Note: no mortar was installed on Pile B.



Figure 65. Plate 1 of Pile C before and after mortar block (top of sand is white line).

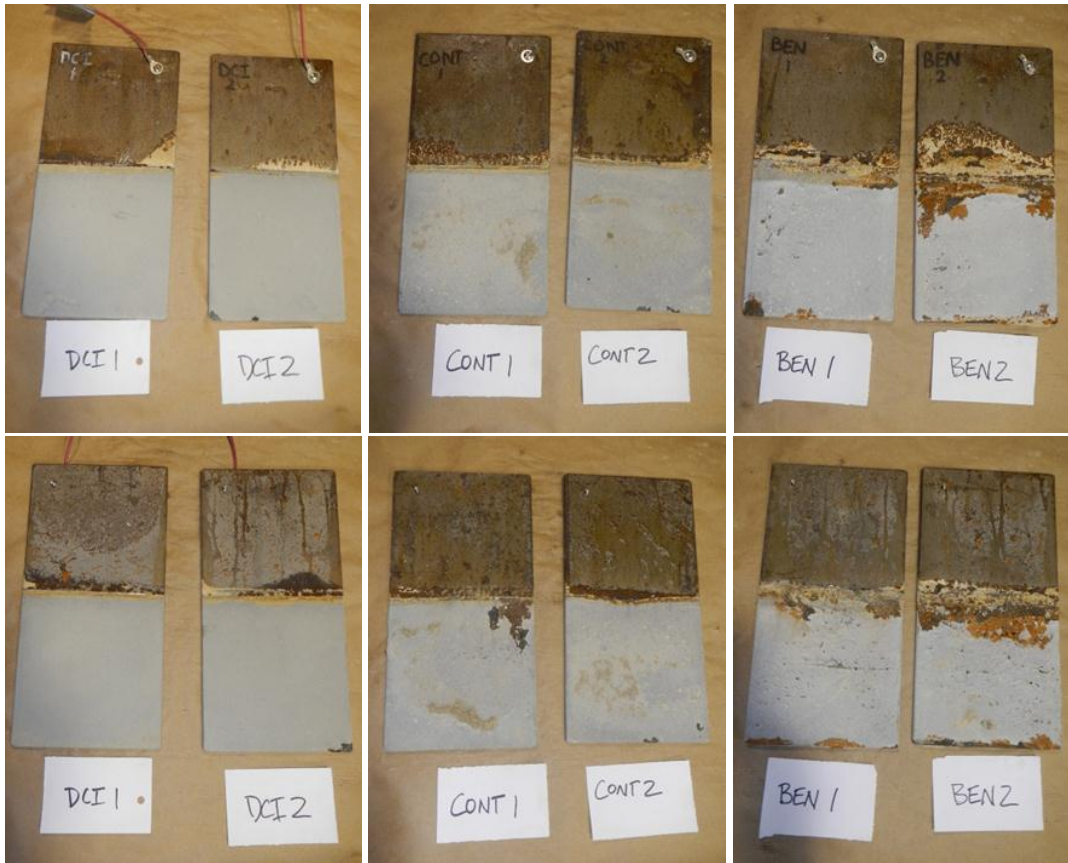

Figure 66. Both faces of embedded plates after they were broken out of the mortar blocks. The bottom half of the plates were in contact with the mortar. “DCI” is corrosion inhibitor, “CONT” is the control mortar, and “BEN” is the 15% bentonite samples.



Figure 67. Anode 1 at end of testing



Figure 68. Anode 2 at end of testing

Appendix A

Bibliography

- AS/NZS2041.1:2011. *Buried corrugated metal structures*. Sydney, AU: Standards Australia Limited/Standards New Zealand, 2011.
- Beavers, J. A., and C. L. Durr. *NCHRP Report 408 Corrosion of Steel Piling in Nonmarine Applications*. Washington, D.C.: Transportation Research Board, 1998.
- Brevoort, Gordon H., et al. *Updated Protective Coating Costs, Products, and Service Life*. Houston, TX: NACE International, 1996.
- Caltrans. "Corrosion Guidelines." 2012.
- Coburn, Seymour K. "Atmospheric Corrosion." In *Metals Handbook Ninth Edition, Volume 1*, 717-723. Metals Park, Ohio: American Society for Metals, 1978.
- Cramer, S.D. et al. "Atmospheric Corrosion in Coastal Environments." In *Innovative Ideas for Controlling the Decaying Infrastructure*, by V. Chaker, 151-164. Houston, TX: NACE International, 1995.
- Davis, J.R. *Corrosion: Understanding the Basics*. Materials Park, OH: ASM International, 2000.
- Decker, J., Rollins, K., and Ellsworth, J. "Corrosion Rate Evaluation and Prediction for Piles Based on Long-Term Field Performance." *J. Geotech. and Geoenviron. Engrg.*, March 2008: Volue 134, Issue 3, pp.341-351.
- Elias, Victor et al. *Corrosion/Degradation of Soil Reinforcements for Mechanically Stabilized Earth Walls and Reinforced Soil Slopes*. Washington, DC: National Highway Institute/Federal Highway Administration, 2009.
- Ellor, James A., et al. *NCHRP Report 528: Thermally Sprayed Metal Coatings to Protect Steel Piling*. Washington, DC: Transportation Research Board, 2004.
- Escalante, E., Iverson, W.P., et al. *Corrosion and Protection of Steel Piles in a Natural Seawater Environment*. Washington, D.C.: National Bureau of Standards, 1977.
- Gabriel, Lester H. and Moran, Eric T. *NCHRP Sythesis of Highway Practice 254: Service Life of Drainage Pipe*. Washington, DC: National Academy Press, 1998.
- Gerwick, Ben C. *Construction of Marine and Offshore Structures, Third Edition*. Boca Raton, FL: CRC Press, 2007.
- Helsel, Jayson L. et al. *Expected Service Life and Cost Considerations for Maintenance and New Construction Protective Coating Work*. Houston, TX: NACE International, 2008.
- Kumar, Ashok and Stephenson, L.D. *Thrity-three Year Study of Steel Pilings in Seawater*. Hosuton, TX: Nace International, 2006.
- Lower Mississippi Valley Division. *ES-311 Report on Corrosoin of Underground Steel Piling*. Vicksburg, MS: U.S. Army Corps of Engineers, 1969.
- NACE International. *State-of-the-Art Survey on Corrosion of Steel Piling in Soils*. Houston: NACE Publicaiton 05101, December 2001.
- NACE. *TPC Publication 9: User's Guide to Hot Dip Galvanizing for Corrosion Protection in Atmospheric Service*. Houston, TX: NACE , 1983.
- Peabody, A.W. *Peabody's Control of Pipeline Corrosion*. Houston, TX: NACE International, 2001.
- Romanoff, M. "Corrosion of Steel Pilings in Soils." *Journal of Research of the National Bureau of Standards, vol. 66C, No. 3*, July-September 1962: 22.
- Romanoff, Melvin. *Underground Corrosion*. Houston: National Bureau of Standards Circular 579, NACE, 1957.
- Stango, Robert J et al. *Surface Preparation of Ship-Construction Steel/(ABS-A) via Bristle Blasting Process*. Houston, TX: NACE International, 2010.

Appendix B

Laboratory Testing of Coatings Photographic Log

Bituminous Mastic (BM3) C: SSPC-SP3



3 Months



9 Months

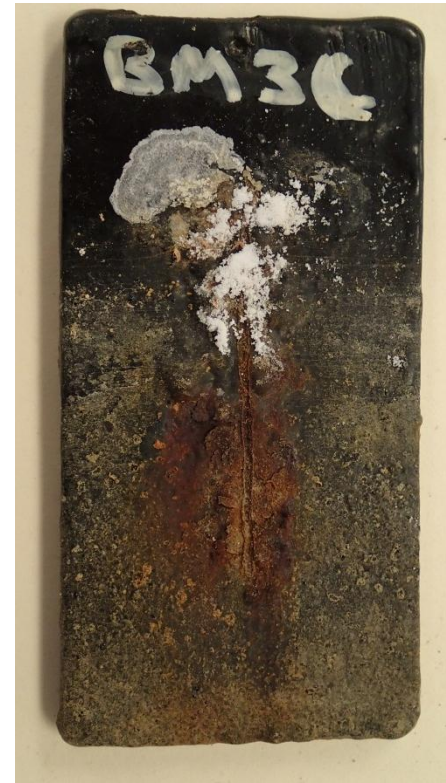

12 Months

Bituminous Mastic (BM6) B: SSPC-SP6



3 Months



9 Months

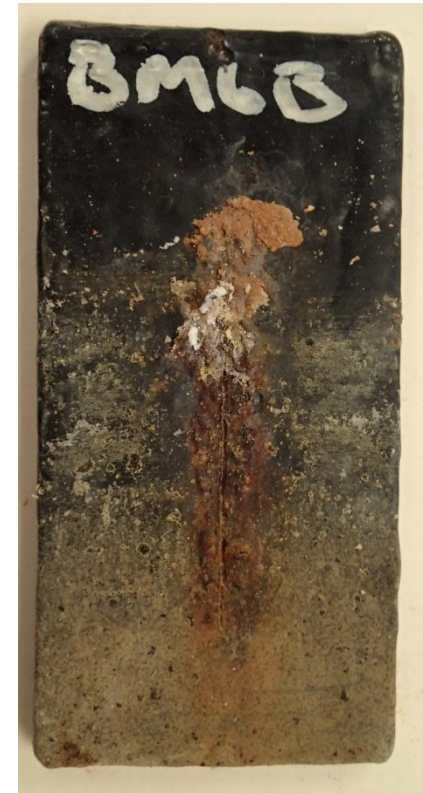

12 Months

Bituminous Mastic (BM10) B: SSPC-SP10



3 Months



9 Months



12 Months

Glass Flake Polyester (PG3) A: SSPC-SP3



3 Months



9 Months



12 Months

Glass Flake Polyester (PG6) A: SSPC-SP6



3 Months



9 Months



12 Months

Glass Flake Polyester (PG10) A: SSPC-SP10



3 Months



9 Months



12 Months

Surface Tolerant Epoxy (ST3) B: SSPC-SP3



3 Months



9 Months



12 Months

Surface Tolerant Epoxy (ST6) A: SSPC-SP6



3 Months



6 Months



12 Months

Surface Tolerant Epoxy (ST10) B: SSPC-SP10



3 Months



9 Months



12 Months

Epoxy over Organic Zinc Rich (OZ3) B: SSPC-SP3



3 Months



9 Months



12 Months

Epoxy over Organic Zinc Rich (OZ6) C: SSPC-SP6



3 Months



9 Months



12 Months

Epoxy over Organic Zinc Rich (OZ10) B: SSPC-SP10



01-2012



07-2012



Fusion Bonded Epoxy (FB5) A: SSPC-SP5

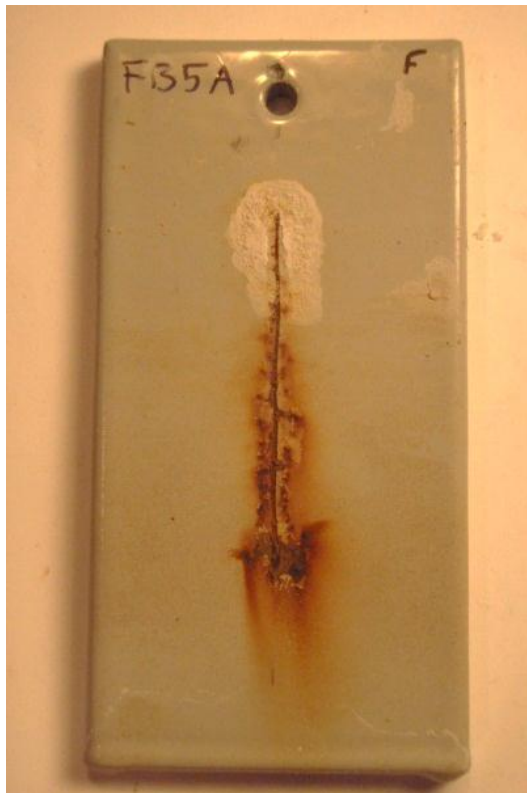

3 Months



9 Months



12 Months

Thermally Sprayed Aluminum (TA5) A: SSPC-SP5



3 Months



9 Months



12 Months

Thermally Sprayed Aluminum with Zinc Overcoat (AZ5) A: SSPC-SP5



3 Months



9 Months



12 Months

Grout (GR3) B: SSPC-SP3



3 Months



9 Months



12 Months

Grout (GR6) A: SSPC-SP6



3 Months



9 Months



12 Months

Grout (GR10) B: SSPC-SP10



3 Months



9 Months



12 Months