

Level and pressure instrumentation for the cement industry



Application examples and products













Measurement technology for the cement industry

This brochure presents examples of applied level and pressure measurement technology. Here, you'll learn which sensors fit which measuring tasks.

■ Crusher	Level measurement and point level detection	■ Clinker silo	Level measurement and point level detection
■ Conveyor belt transfer station	Level measurement and point level detection	■ Compressor	Pressure measurement
■ Raw meal silo	Level measurement and point level detection	■ Cement silo	Level and pressure measurement and point level detection
■ Cyclone	Buildup measurement	■ Silo for solid fuels	Level measurement and point level detection
■ Conveyor belt	Mass flow measurement	■ Tank for liquid fuels	Level measurement and point level detection
■ Clinker cooler	Level and pressure measurement	■ Truck loading	Point level detection

All applications can be found at
www.vega.com/cement

All sensors at a glance

Continuous level measurement					
Instrument type		Measuring range	Process fitting	Process temperature	Process pressure
VEGAPULS 64 Radar sensor for continuous level measurement of liquids		up to 30 m	Thread from G¾, ¾ NPT, flanges from DN 50, 2", mounting strap	-40 ... +200 °C	-1 ... +20 bar (-100 ... +2000 kPa)
VEGAPULS 69 Radar sensor for continuous level measurement of bulk solids		up to 120 m	Mounting strap, compression, flange from DN 80, 3", flanges from DN 80, 3", adapter flanges from DN 100, 4"	-40 ... +200 °C	-1 ... +3 bar (-100 ... +300 kPa)
SOLITRAC 31 Radiation-based sensor for continuous level measurement		up to 3 m	Mounting from outside on the vessel	any (with optional cooling)	any
WEIGHTRAC 31 Radiation-based sensor for mass flow determination		up to 2.8 m	Mounting through supplied measuring frame	any	any
Point level detection					
Instrument type		Measuring range	Process fitting	Process temperature	Process pressure
VEGACAP 65 Capacitive cable electrode for level detection		up to 32 m	Thread from G1, 1 NPT, flanges from DN 50, 2"	-50 ... +200 °C	-1 ... +64 bar (-100 ... +6400 kPa)
VEGAMIP 61 Microwave barrier for level detection in bulk solids and liquids		up to 100 m	Thread G1½, 1½ NPT, flanges, clamp, mounting strap	-40 ... +80 °C, +450 °C with mounting adapter	-1 ... +4 bar (-100 ... +400 kPa)
VEGASWING 63 Vibrating level switch with tube extension for liquids		up to 6 m	Thread from G¾, ¾ NPT, flanges from DN 25, 1"	-50 ... +250 °C	-1 ... +64 bar (-100 ... +6400 kPa)
VEGAWAVE 61 Vibrating level switch for powders		Bulk solids from 8 g/l	Thread G1½, 1½ NPT, flanges from DN 50, 2"	-50 ... +250 °C	-1 ... +25 bar (-100 ... +2500 kPa)
VEGAWAVE 62 Vibrating level switch with suspension cable for powders		Bulk solids from 8 g/l	Thread G1½, 1½ NPT, flanges from DN 50, 2"	-40 ... +150 °C	-1 ... +6 bar (-100 ... +600 kPa)
VEGAWAVE 63 Vibrating level switch with tube extension for powders		Bulk solids from 8 g/l	Thread G1½, 1½ NPT, flanges from DN 50, 2"	-50 ... +250 °C	-1 ... +25 bar (-100 ... +2500 kPa)
Pressure measurement					
Instrument type		Deviation	Process fitting	Process temperature	Measuring range
VEGABAR 82 Pressure transmitter with ceramic measuring cell		0.2 % 0.1 % 0.05 %	Thread G½, ½ NPT, flanges from DN 15, 1½"	-40 ... +150 °C	-1 ... +100 bar (-100 ... +10000 kPa)



Cement industry

Robust, state-of-the-art instrumentation

VEGA is a global supplier and equipment provider to international cement producers and the large plant builders in the cement industry. Level and pressure sensors have been used for many years in different applications and areas of cement production: from crusher monitoring to controlling the filling of silos and vehicles.

Maintenance-free and reliable

Sensors for use in cement production must deliver accurate measuring results under harsh operating conditions. Robust VEGA sensors enable maintenance-free operation in all areas of the cement plant operation.

Solution for all measuring tasks

Whether point level, level or pressure, VEGA offers the right solution for different measuring tasks. Undeterred by extreme operating conditions or large ranges, VEGA sensors can overcome all measurement challenges with flying colors.





plics® – easy is better

Instrument platform plics®

The plics® idea is simple: Each instrument is assembled from prefabricated components once the order is received. This modular design allows full flexibility when selecting the required sensor features. You receive your customised, user-friendly instrument within an amazingly short time. The best part: these instruments are more cost-effective and advantageous in every way – throughout their entire life cycle.



Display and adjustment

The display and adjustment module PLICSCOM is used for measured value indication, adjustment and diagnosis directly on the sensor. Its simple menu structure enables quick setup. Status messages are displayed in plain text. The optional Bluetooth feature allows wireless operation.

Connection

The VEGACONNECT connects your instrument to a PC via the USB interface. PLICSCOM with Bluetooth enables data transfer with wireless technology. The instruments are configured with the tried and trusted adjustment software PACTware and the appropriate DTM or with an app on a smartphone or tablet PC. For EDD-based systems we also offer graphics-driven EDDs.

Asset management and maintenance

The integrated self-monitoring function of plics® instruments permanently informs the user on the status of the instruments. Status messages allow proactive and cost-effective maintenance. All diagnostic data can be called up easily and quickly in plain text via the built-in memory functions.





Crusher

Reliable

Reliable measurement ensured even in noisy environments

Cost effective

Uninterrupted operation thanks to optimal process feed

User friendly

Simple installation and setup

Level measurement and point level detection in rock crushers

The large boulders are extracted from the solid bedrock with blasting. This very first stage in the process is needed to enable these very large rocks to be crushed by smaller, secondary jaw and roller crushers, which create the smaller sizes for screening to produce the basic building materials like gravel, grit or sand. To enable efficient, continuous operation and keep wear on the crusher as low as possible, level measurement and point level detection are required.



VEGAPULS 69

Non-contact level measurement with radar in rock crushers

- Reliable measurement and control, independent of extreme dust generation and weather conditions
- Maximum operational reliability through noise insensitivity
- Maintenance-free non-contact measuring method



VEGAMIP 61

Microwave barrier for point level detection in rock crushers

- Maintenance-free non-contact measuring method
- High measurement certainty despite dirt and buildup
- Even external measurement via solid plastic or ceramic window

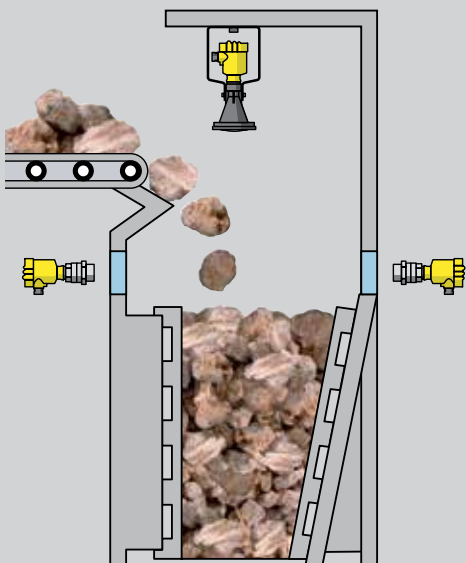



Conveyor belt transfer station

Reliable

Reliable monitoring of silo filling

Cost effective

Optimal utilization of conveyor belt capacity

User friendly

Maintenance-free operation

Level measurement and point level detection at the belt transfer point

The transport of coarse and fine bulk solids within a stone processing facility takes place in most cases via conveyor belts. To achieve an even throughput and compensate for volume fluctuations during transport, belt transfer points are integrated in the conveyor line. The incoming bulk material is briefly stored in a buffer silo to prevent belt overfilling. This is the point where the level and the point level must be monitored.



VEGAPULS 69

Non-contact level measurement with radar at the belt transfer station

- Highly reliable even in dusty environments
- Maintenance-free non-contact measurement
- Maximum operational reliability due to noise insensitivity



VEGACAP 65

Overflow protection with capacitive point level detection at the belt transfer station

- Reliable measuring results, unaffected by buildup
- Dependable switching point ensured by large gravity weight
- Long service life thanks to robust, cut to length cable probe

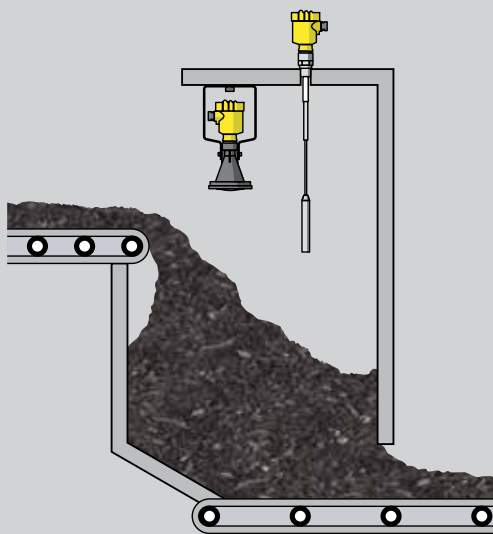



Raw meal silo

Reliable

Reliable measurement ensures a continuous supply of raw material

Cost effective

Optimal stocks ensure continuous production

User friendly

Maintenance-free operation

Level measurement and point level detection in raw meal silos

Before being burned in the rotary kiln, the material from the blending bed and the aggregates are ground to a fine raw meal in large mills. The powdery material is then transported to the silo by a pneumatic conveyor system. Reliable monitoring of the level is essential for optimal raw material storage.



VEGAPULS 69

Level measurement with radar in raw meal silos

- Reliable measurement, unaffected by dust and buildup
- Maintenance-free operation thanks to encapsulated antenna system
- High plant availability, because wear and maintenance-free



VEGAWAVE 63

Vibrating level switch as overflow protection in raw meal silos

- Reliable product-independent switching point
- Long service life thanks to robust sensor construction
- Simple setup without adjustment

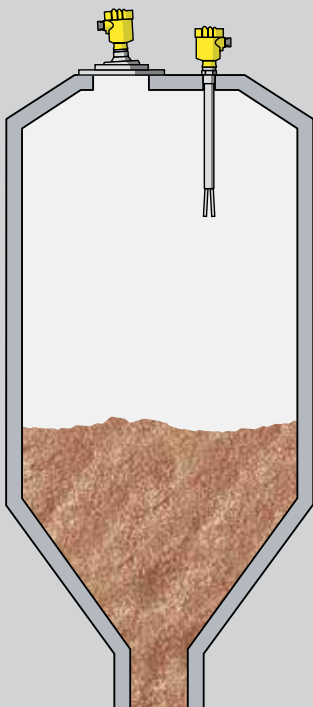



Cyclone

Reliable

Reliable buildup measurement despite high temperatures

Cost effective

Monitoring the formation of buildup ensures high availability of the cyclone

User friendly

Simple external mounting

Buildup measurement in cyclones

In clinker production, cyclones are used to preheat the raw meal. Before the raw meal enters the rotary kiln it is preheated to +900 °C in the cyclone. Constant monitoring of the buildup thickness on the walls ensures a continuous process.



SOLITRAC 31

Radiometric measurement of buildup in cyclones

- Exact measuring results, independent of process conditions
- High process reliability through buildup detection
- High plant availability thanks to non-contact measurement



VEGASOURCE 31

Container for radioactive source capsules

- High operational safety ensured through pneumatic opening and closing of source holder
- Comprehensive shielding reduces size of controlled areas
- Minimal space requirements and simple mounting

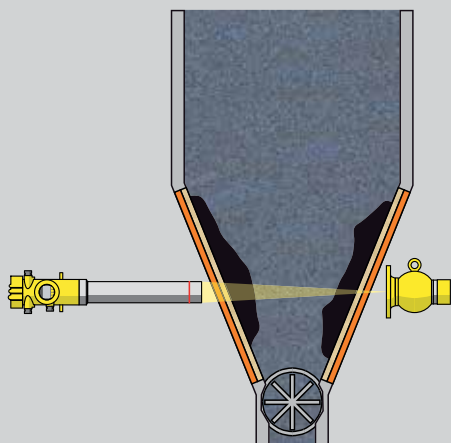



Conveyor belt

Reliable

Reliable measurement despite changing belt tension and vibrations

Cost effective

Optimal mass flow measurement allows exact accounting of bulk solids

User friendly

Maintenance-free operation

Mass flow measurement on conveyor belts

Bulk aggregates are fed into production processes via conveyor belts or screw conveyors. For effective feed control to and from these processes, or inter-production unit billing, the mass flow of the conveyed bulk material must be measured. A reliable belt-weighing scale system and mass flow rate ensures accurate measurement and smooth operation of the plant.



WEIGHTRAC 31

Radiometric mass flow measurement of solids on conveyor belts

- Reliable measurement, independent of dust and dirt
- Accurate and repeatable mass flow measurement
- Wear-free, contactless weighing



VEGASOURCE 31

Source holder as receptacle for the radiation capsule

- High operational reliability with pneumatic actuation of the source holder
- Effective shielding allows minimal use of control areas
- Minimal space requirement and simple installation

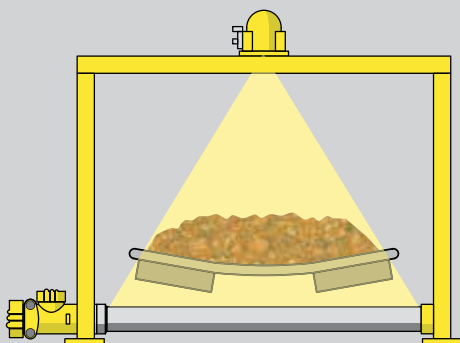



Clinker cooler

Reliable

Reliable monitoring of cooler process

Cost effective

Optimal cooling with minimum energy expenditure

User friendly

Maintenance-free measurement

Level and pressure measurement in the clinker cooler

To produce cement, the raw meal is burned to clinker in a long rotary kiln. After leaving the rotary kiln, the clinker has a temperature of up to +1300 °C and must be cooled down to a temperature of about +200 °C for further storage. To achieve this, the clinker bed is cooled with a continuous stream of air. Pressure monitoring is required in the lower part of the clinker cooler to make the cooling as effective as possible. The material height of the hot clinker, at over 1000 °C on the conveyor belt, also has to be reliably measured.



VEGAPULS 68

Non-contact level measurement with radar in the clinker cooler

- Reliable measurement despite extremely high media temperatures
- Effective antenna cooling via blower or compressed air
- Long service life by utilising a temperature-resistant antenna system



VEGABAR 82

Pressure transmitter for pressure monitoring in the clinker cooler

- High plant availability thanks to rugged measuring cell
- Maintenance-free through front-flush mounting

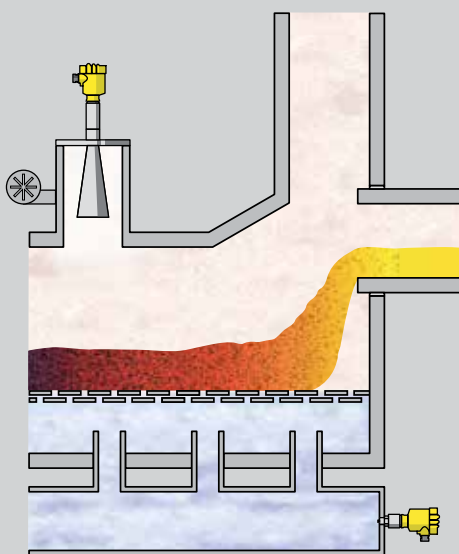



Clinker silo

Reliable

Reliable measurement despite high temperatures

Cost effective

Optimal stocks enable continuous production

User friendly

Maintenance-free operation

Level measurement and point level detection in clinker silos

After the raw meal is burned, the emerging clinker of varying consistency is stored for further processing. The silos are filled and emptied through different openings. Continuous operation of the subsequent production processes is ensured by level measurement and point level detection.



VEGAPULS 69

Level measurement with radar in clinker silos

- Exact measurement right to the bottom of the discharge funnel thanks to small beam angle
- High measurement certainty, unaffected by dust and temperature changes
- Maintenance-free through non-contact measurement



VEGACAP 65

Capacitive point level detection in clinker silos

- Robust construction ensures a long service life
- Reliable measurement, unaffected by buildup
- Cut to length cable probes allow high flexibility



Compressor

Reliable

Safety shutdown in case of excessive pressure

Cost effective

Constant supply of compressed air for production

User friendly

Maintenance-free operation

Pressure measurement in air compressor systems

The air compressor system generates the necessary compressed air to transport the material from the silos via the network of feed pipes. To ensure a smooth, steady flow of material, reliable pressure monitoring in the compressors and conveying channels is required.



VEGABAR 82

Pressure transmitter for monitoring pressure in air compressor systems

- High plant availability ensured through high overload resistance of the ceramic CERTEC® measuring cell
- Reliable measurement, unaffected by pressure shocks
- Maintenance-free operation thanks to wear-free measuring cell

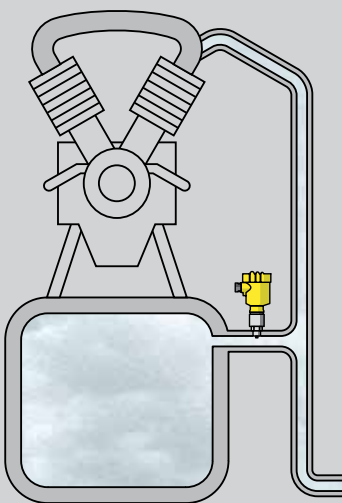



Cement silo

Reliable

Reliable measurement ensures a continuous supply of raw material

Cost effective

Optimal stocks enable continuous production

User friendly

Maintenance-free operation

Level and pressure measurement and point level detection in cement silos

Before further processing, the cement is stored in tall silos. The cement is transported both in and out of the silo via pneumatic conveying. Efficient storage and transport of the product is ensured by accurate level measurement and point level detection, as well as also monitoring the pneumatic conveying system pressure.



VEGAPULS 69

Non-contact level measurement with radar in cement silos

- Reliable measurement, unaffected by dust generation and buildup
- Maintenance-free operation through non-contact measurement
- Simple mounting with swivelling holder



VEGAWAVE 62

Vibrating level switch as overflow protection in cement silos

- Reliable function through product-independent switching point
- Robust sensor construction for long service life
- Simple setup without adjustment



VEGABAR 82

Pressure transmitter for monitoring pressure in pipelines

- High plant availability ensured through very high overload resistance
- Maintenance-free operation with highly abrasion resistant ceramic CERTEC® measuring cell

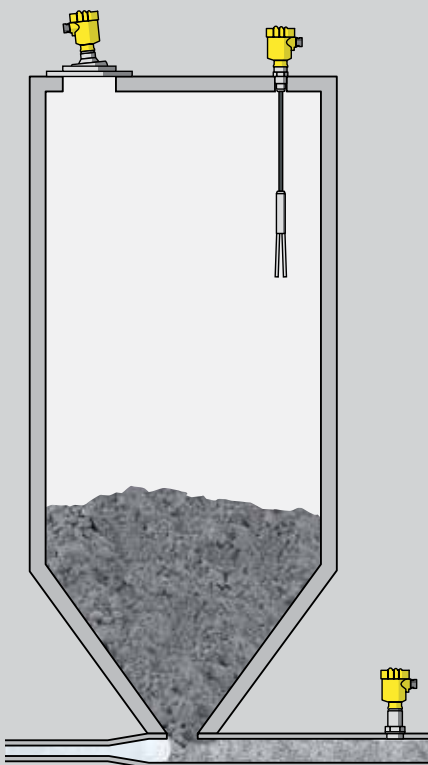



Silo for solid fuels

Reliable

Reliable measurement ensures a continuous supply of fuel

Cost effective

Exact content measurement reduces logistics costs

User friendly

Maintenance-free operation

Level measurement and point level detection in silos for solid fuels

Large amounts of energy are needed to burn clinker in rotary kilns. Apart from conventional energy sources such as gas, oil and coal, solid substitute fuels such as dried sewage sludge, old tires or meat and bone meal are increasingly being used. Since the required amounts of energy represent a significant cost factor in cement production, exact level measurement of the solid fuels is essential.



VEGAPULS 69

Level measurement with radar in silos for solid fuels

- High measurement certainty, independent of product properties
- Exact measurement to the bottom of the discharge funnel thanks to small beam angle
- Very good signal focusing reduces interfering reflections



VEGAWAVE 62

Overfill protection with vibrating level switch in silos for solid fuels

- Reliable function through product-independent switching point
- Immune to buildup
- Very robust construction minimizes maintenance costs

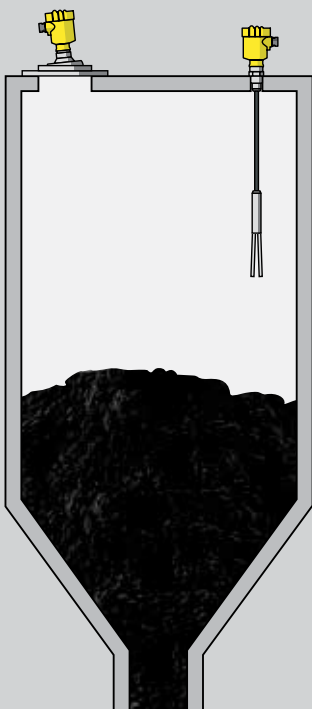



Tank for liquid fuels

Reliable

Reliable measurement under all operating conditions

Cost effective

Optimal storage

User friendly

Maintenance-free operation

Level measurement and point level detection in tanks for liquid fuels

Large amounts of energy are needed to burn clinker in rotary kilns. Substitute liquid fuels such as spent oils or recovered solvents are often used for this purpose. The fuel storage tanks often contain a mixture of solvents, which can produce fumes and vapours in the air space. Due to the large amount of energy needed in cement production, the fuel inputs represent a significant cost factor, so accurate level measurement is essential.



VEGAPULS 64

Level measurement with radar in tanks for liquid fuels

- Good focusing means reliable measurement right down to the bottom, thanks to 80 GHz technology
- Reliable measurement, independent of product properties
- Simple installation in small mounting sockets allows universal use



VEGASWING 63

Vibrating level switch for protection against overfilling in liquid fuel tanks

- Accurate and reliable function through product-independent switching point
- Reliable point level detection in compliance with SIL2 and WHG
- Adjustment-free setup and maintenance-free operation

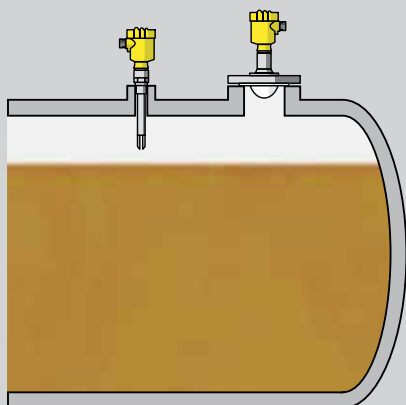



Truck loading

Reliable

Reliable measurement under tough operating conditions

Cost effective

Optimal filling of silo vehicles

User friendly

Simple setup and commissioning

Point level detection during the loading of trucks

Dust-free, closed loading systems are needed for fine aggregates and finished products such as cement. Automated loading of trucks is preferred in the industry and, while the load quantity is determined with a weighing system, it must be ensured that the truck is in the correct place and not overfilled. Reliable point level detection and vehicle positioning shortens loading times, increases throughput and improves the efficiency of the entire system.



VEGAWAVE 61

Overfill protection with vibrating level switch

- Reliable operation even in extremely dusty environment
- Independent of the properties of the bulk solid materials and the bulk density
- Long service life thanks to robust sensor design



VEGAMIP 61

Position detection of vehicles with radar

- Reliable position detection in all weather conditions
- Fast and precise detection of a vehicle's position
- Maintenance-free operation thanks to non-contact measuring method

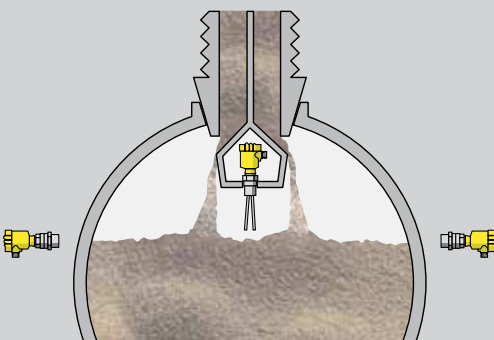



VEGA Grieshaber KG
Am Hohenstein 113
77761 Schiltach
Germany

Phone +49 7836 50-0
Fax +49 7836 50-201
E-mail info.de@vega.com
www.vega.com

Looking Forward **VEGA**