

KIMBERLEY PRODUCTS

Product Catalogue

KIMBERLEY™

www.kimprod.com.au

ACCESS PANELS & FRAMES

SOFTLINE METAL ACCESS PANEL WITH SNAP LOCK



CUTOUT	OUTER FRAME	CODE
200mm x 200mm	235mm x 235mm	K120472
200mm x 300mm	235mm x 335mm	K120474
300mm x 300mm	335mm x 335mm	K120476
400mm x 400mm	435mm x 435mm	K120478
450mm x 450mm	485mm x 485mm	K120480
500mm x 500mm	535mm x 535mm	K120482
600mm x 600mm	635mm x 635mm	K120484

- MADE FROM POWDER COATED WHITE GALVANISED SHEET STEEL
- SMOOTH PAINTABLE DOOR PANEL
- SPRING LOADED LOCK, WHEN PRESSURE IS APPLIED, YOU CAN REMOVE THE DOOR PANEL FOR ACCESS
- 4 RIVETED SWIVEL ANCHORS ENSURE SAFER MOUNTING IN WALL OR CEILING
- COMPLETE FRAME KIT WITH SOFTENED PROFILE
- FULLY REMOVABLE DOOR PANEL
- PACKING: 10 PER BOX OR AVAILABLE SINGULARLY

SOFTLINE METAL ACCESS PANEL WITH SQUARE LOCK



CUTOUT	OUTER FRAME	CODE
150mm x 150mm	185mm x 185mm	K120520
200mm x 200mm	235mm x 235mm	K120522
200mm x 300mm	235mm x 335mm	K120524
250mm x 250mm	285mm x 285mm	K120525
300mm x 300mm	335mm x 335mm	K120527
400mm x 400mm	435mm x 435mm	K120528
500mm x 500mm	535mm x 535mm	K120530
600mm x 600mm	635mm x 635mm	K120531

- MADE FROM POWDER COATED WHITE GALVANISED SHEET STEEL
- SMOOTH PAINTABLE DOOR PANEL
- SPARE SQUARE KEYS AVAILABLE. CODE K10202
- COMPLETE FRAME KIT WITH SOFTENED PROFILE
- 4 RIVETED SWIVEL ANCHORS ENSURE SAFER MOUNTING IN WALL OR CEILING (2 ON 150MM X 150MM)
- FULLY REMOVABLE DOOR PANEL
- PACKING: 10 PER BOX OR AVAILABLE SINGULARLY

SOFTLINE METAL ACCESS PANEL WITH CYLINDER LOCK



CUTOUT	OUTER FRAME	CODE
200mm x 200mm	235mm x 235mm	K120562
200mm x 300mm	235mm x 335mm	K120564
300mm x 300mm	335mm x 335mm	K120567
400mm x 400mm	435mm x 435mm	K120568
500mm x 500mm	535mm x 535mm	K120570
600mm x 600mm	635mm x 635mm	K120571

- MADE FROM POWDER COATED WHITE GALVANISED SHEET STEEL
- SMOOTH PAINTABLE DOOR PANEL
- 4 RIVETED SWIVEL ANCHORS ENSURE SAFER MOUNTING IN WALL OR CEILING
- COMPLETE FRAME KIT WITH SOFTENED PROFILE
- FULLY REMOVABLE DOOR PANEL
- PACKING: 10 PER BOX OR AVAILABLE SINGULARLY

Softline Set-Bead BY KIMBERLEY™

**NEW RANGE
INCLUDES
450 x 450mm
FLANGED &
SET BEAD
MODELS**

SOFTLINE METAL ACCESS PANEL SET BEAD FRAME WITH SNAP LOCK

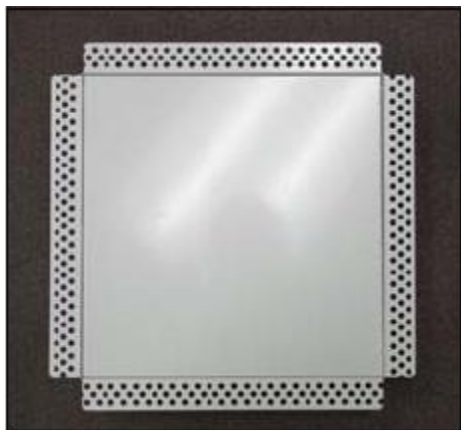

PANEL SIZE	CODE
300mm x 300mm	K123104
450mm x 450mm	K123108
600mm x 600mm	K123112

- MADE FROM POWDER COATED WHITE GALVANISED SHEET STEEL
- SMOOTH PAINTABLE DOOR PANEL
- SPRING LOADED LOCK, WHEN PRESSURE IS APPLIED
- SET BEAD FRAME
- FULLY REMOVABLE DOOR PANEL
- PACKING: 5 PER BOX OR AVAILABLE SINGULARLY

SOFTLINE METAL ACCESS PANEL SET BEAD FRAME WITH SQUARE LOCK



PANEL SIZE	CODE
300mm x 300mm	K123204
450mm x 450mm	K123208
600mm x 600mm	K123212

- MADE FROM POWDER COATED WHITE GALVANISED SHEET STEEL
- SMOOTH PAINTABLE DOOR PANEL
- SPARE KEYS AVAILABLE. CODE K10202
- SET BEAD FRAME
- FULLY REMOVABLE DOOR PANEL
- PACKING: 5 PER BOX OR AVAILABLE SINGULARLY

ACCESS PANELS & FRAMES

ALUSTAR FLUSH ACCESS PANEL WITH GYPSUM BOARD DOOR

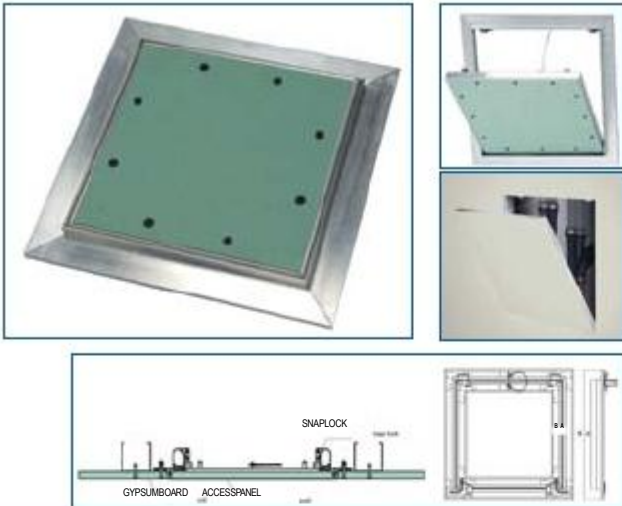

CUTOUT (A)	OUTER FRAME (B)	CODE
200mm x 200mm	245mm x 245mm	K120370
300mm x 300mm	345mm x 345mm	K120372
400mm x 400mm	445mm x 445mm	K120374
400mm x 600mm	445mm x 645mm	K120376
500mm x 500mm	545mm x 545mm	K120378
600mm x 600mm	645mm x 645mm	K120380
600mm x 1200mm	645mm x 1245mm	K120326

- FOR GYPSUM BOARD WALL AND CEILING INSTALLATION
- FRAME AND DOOR MADE FROM STURDY ALUMINIUM PROFILES
- THE DOOR IS SECURED BY 2 GALVANIZED BRACKETS
- LOCKED ON THE OPPOSITE SIDE BY MEANS OF 2 SPRING LOADED LATCHES
- FULLY REMOVABLE DOOR HATCH WITH SAFETY CABLE
- PACKING: 5 PER BOX OR AVAILABLE SINGULARLY

ROUND ALUSTAR FLUSH ACCESS WITH GYPSUM BOARD DOOR

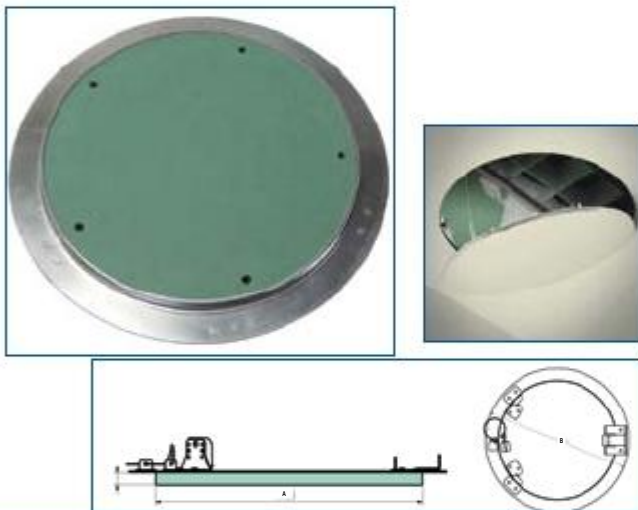

CUT OUT (A)	FRAME SIZE (B)	CODE
300mm	357mm	K121379
400mm	457mm	K121380
600mm	657mm	K121382

- FOR GYPSUM BOARD WALL AND CEILING INSTALLATION
- FRAME AND DOOR MADE FROM STURDY ALUMINIUM PROFILES
- THE DOOR IS SECURED BY 2 GALVANIZED BRACKETS
- LOCKED ON THE OPPOSITE SIDE BY MEANS OF 2 SPRING LOADED LATCHES
- FULLY REMOVABLE DOOR HATCH WITH SAFETY CABLE
- PACKING: 5 PER BOX OR AVAILABLE SINGULARLY

ALUSTAR ECO PLUS ACCESS PANEL WITH SQUARE LOCK

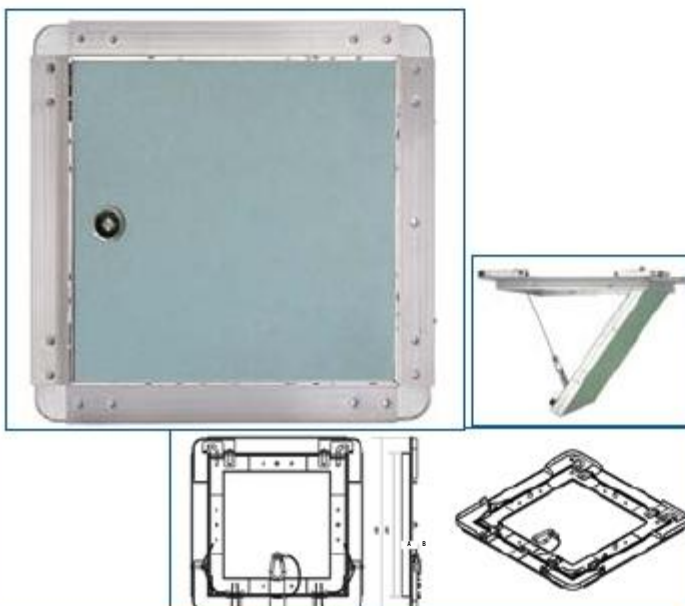

CUT OUT (A)	OUTER FRAME (B)	CODE
300mm x 300mm	343mm x 343mm	K120041
400mm x 400mm	443mm x 443mm	K120042
500mm x 500mm	543mm x 543mm	K120044
600mm x 600mm	643mm x 643mm	K120045

- APPLICATIONS INCLUDE TYPICAL GYPSUM AND MASONRY CONSTRUCTION
- FRAME AND DOOR HATCH ARE MANUFACTURED FROM STURDY ALUMINIUM FOR STABILITY AND STRENGTH
- LOW PROFILE DESIGN
- RE-ENFORCED CORNERS FOR ADDED STRENGTH
- HATCH DOOR IS COMPLETELY REMOVABLE FOR FULL ACCESS, ENSURING OH&S COMPLIANCE
- LOCKED ON THE OPPOSITE SIDE BY MEANS OF 2 SPRING LOADED LATCHES

CUSTOMWOOD PANELS

CUSTOMWOOD ACCESS PANELS - METAL WHITE FRAME WITH MDF DOOR

- K110403 - 300 x 300mm (MDF Set-Bead with slot latch)
- K110406 - 450 x 450mm (MDF Set-Bead with slot latch)
- K110409 - 600 x 600mm (MDF Set-Bead with slot latch)

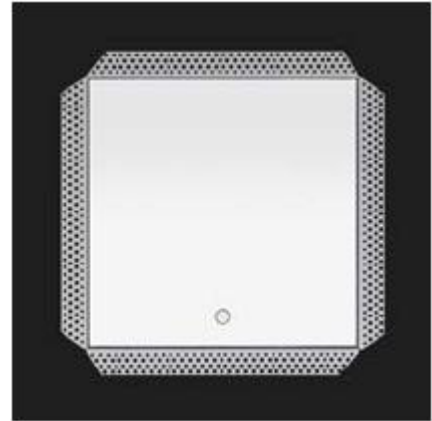

- K110503 - 300 x 300mm (MDF Flanged with slot latch)
- K110506 - 450 x 450mm (MDF Flanged with slot latch)
- K110509 - 600 x 600mm (MDF Flanged with slot latch)



- K110803 - 300 x 300mm (MDF Set-Bead with touch latch)
- K110806 - 450 x 450mm (MDF Set-Bead with touch latch)
- K110809 - 600 x 600mm (MDF Set-Bead with touch latch)

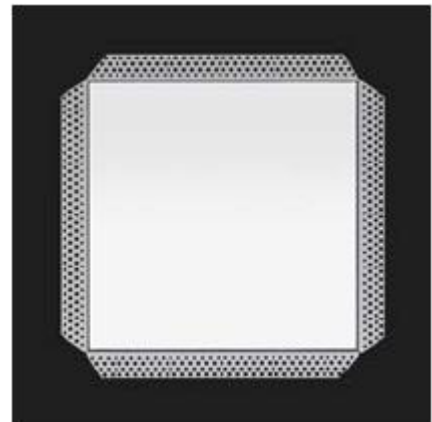

- K110903 - 300 x 300mm (MDF Flanged with touch latch)
- K110906 - 450 x 450mm (MDF Flanged with touch latch)
- K110909 - 600 x 600mm (MDF Flanged with touch latch)



METAL ACCESS PANEL C/W GALVANISED METAL DOOR

- K110706 - 450 x 450mm (Metal Access Panel Flanged with touch latch)

RW31 CUSTOMWOOD ACOUSTIC PANELS

Kimberley Rw31 Acoustic Access Panels have been designed for use where there is a noise transmission issue. The panels are constructed using a composite acoustic door panel and steel frame, and feature a square key budget lock as standard. Kimberley Rw31 panels have been independently tested, and achieve a modest rating of Rw31 in suitable openings.

Kimberley Rw31 panels are lightweight and compact, allowing for an aesthetically pleasing means of providing access into walls, ceilings, and service shafts. When installed, they sit flush with the surface, leaving a neat opening around the perimeter.

Sizes: It is easier to design and order standard sizes as these are readily available and competitively priced. Other sizes can be manufactured to order.

K112303 - 300 x 300mm (Flanged)
K112306 - 450 x 450mm (Flanged)
K112309 - 600 x 600mm (Flanged)
Other sizes available upon request

K112203 - 300 x 300mm (Set Bead)
K112206 - 450 x 450mm (Set Bead)
K112209 - 600 x 600mm (Set Bead)
Other sizes available upon request



RW34 ALL METAL ACOUSTIC PANELS

Kimberley Rw34 Acoustic Access Panels have been designed for use where there is a noise transmission issue. The panels are constructed using a metal clad acoustic door panel and steel frame, and feature a square key budget lock as standard. Kimberley Rw34 panels have been independently tested, and achieve a modest rating of Rw34 in suitable openings.

Kimberley Rw34 panels are lightweight and compact, allowing for an aesthetically pleasing means of providing access into walls, ceilings, and service shafts. When installed, they sit flush with the surface, leaving a neat opening around the perimeter.

Sizes: It is easier to design and order standard sizes as these are readily available and competitively priced. Other sizes can be manufactured to order.

K112103 - 300 x 300mm (Flanged)
K112106 - 450 x 450mm (Flanged)
K112109 - 600 x 600mm (Flanged)
Other sizes available upon request

K112003 - 300 x 300mm (Set Bead)
K112006 - 450 x 450mm (Set Bead)
K112009 - 600 x 600mm (Set Bead)
Other sizes available upon request



FIRE RATED ACCESS PANELS

with *SMOKE SEALS*

1 HOUR HINGED CEILING & WALL HATCH Set Bead or Flanged 60/60/60

K115103 - 300 x 300mm 1hr FIRE RATED (Flanged)
K115106 - 450 x 450mm 1hr FIRE RATED (Flanged)
K115109 - 600 x 600mm 1hr FIRE RATED (Flanged)
Other sizes available upon request

K115003 - 300 x 300mm 1hr FIRE RATED (Set Bead)
K115006 - 450 x 450mm 1hr FIRE RATED (Set Bead)
K115009 - 600 x 600mm 1hr FIRE RATED (Set Bead)
Other sizes available upon request



2 HOUR HINGED CEILING & WALL HATCH Set Bead or Flanged - 120/120/30

K115303 - 300 x 300mm 2hr FIRE RATED (Flanged)
K115306 - 450 x 450mm 2hr FIRE RATED (Flanged)
K115309 - 600 x 600mm 2hr FIRE RATED (Flanged)
Other sizes available upon request

K115203 - 300 x 300mm 2hr FIRE RATED (Set Bead)
K115206 - 450 x 450mm 2hr FIRE RATED (Set Bead)
K115209 - 600 x 600mm 2hr FIRE RATED (Set Bead)
Other sizes available upon request

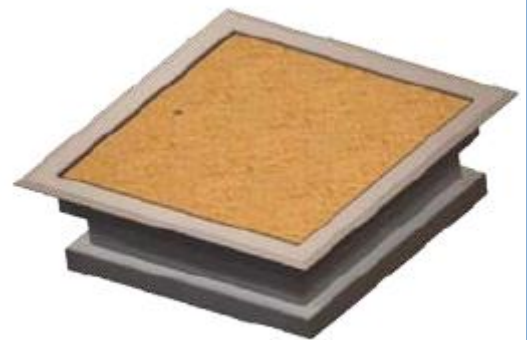

Kimberley Fire Rated Ceiling Hatches have been designed for use where fire rated protection is required. The hatches feature concealed hinges and provide lockable access to services.

Kimberley Fire Rated hatches are a compact, lightweight and aesthetically pleasing means of providing access into fire rated ceilings. When installed they sit flush with the ceiling leaving a neat opening around the perimeter. The hatch panel is secured with a locking key.

Fire Ratings: Kimberley Fire Rated Ceiling Hatches have been fire tested in fire rated ceilings to Australian Standard AS1530-4 and have attained up to 2 hour incipient fire rating for ceilings. Models are available with fire ratings of one or two hours.

Sizes: It is easier to design and order standard sizes as these are readily available and competitively priced.

However, other sizes can be manufactured to order.



ACCESS PANELS & FRAMES

HEAVY DUTY MANHOLE FRAME



OUTER FRAME	CUT OUT	CODE
450mm x 600mm	403mm x 553mm	KMH01
600mm x 600mm	553mm x 553mm	KMH02
450mm x 450mm	403mm x 403mm	KMH03

- FITS STANDARD 450mm TO 600mm CEILING JOIST CENTRES
- GREAT TIME SAVER - INSTALLATION TAKES MINUTES
- MORE ECONOMICAL THAN WOODEN FRAMES
- ATTRACTIVE HI - IMPACT WHITE PLASTIC
- CAN BE PAINTED
- QUANTITY: 5 PER BOX

LOCKABLE MANHOLE SYSTEM



Doors can be sold separately: SKMHD01-07 for KMH01, SKMHD02-02 for KMH02.

OUTER FRAME	CUT OUT	CODE
450mm x 600mm	403mm x 553mm	KMHD01
600mm x 600mm	553mm x 553mm	KMHD02

- FITS STANDARD 450mm TO 600mm CEILING JOIST CENTRES
- HEAVY DUTY MANHOLE FRAME
- INGENIOUS LOCKABLE MANHOLE DOOR
- PATENTED KEY LOCK MECHANISM
- HI - IMPACT WHITE PLASTIC CONSTRUCTION
- INCREASED SECURITY
- QUANTITY: 1 PER BOX

FLUSH MOUNTED MANHOLE SYSTEM



OUTER FRAME	CUT OUT	CODE
450mm x 450mm	403mm x 403mm	KMHF03

- TOTAL FLUSH MOUNT APPEARANCE
- ATTRACTIVE PRESENTATION INCLUDING CONCEALED HINGES
- STANDARD COMMERCIAL SLOT TYPE LOCK
- MDF DOOR - READY TO PAINT
- HINGED DOOR WITH SAFETY STRAP
- CAN BE MOUNTED IN BOTH CEILING AND WALL SITUATIONS
- PACK QUANTITY: 1 PER BOX

METAL HINGED MANHOLE SYSTEM

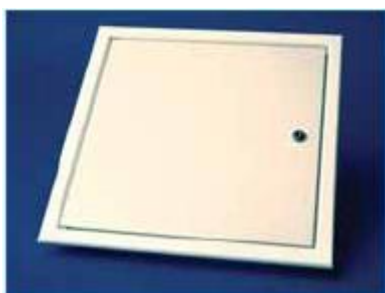

OUTER FRAME	CUT OUT	CODE
450mm x 600mm	403mm x 553mm	KMHM01
600mm x 600mm	553mm x 553mm	KMHM02
450mm x 450mm	403mm x 403mm	KMHM03

- CAN BE MOUNTED IN BOTH CEILING AND WALL SITUATIONS
- GREAT FOR USE WHERE HEADROOM IS A PROBLEM
- METAL HINGED DOOR WITH SAFETY STRAP
- HI - IMPACT WHITE INJECTION MOULDED FRAME
- STANDARD COMMERCIAL SLOT TYPE LOCK, OPERATED WITH A SCREWDRIVER
- PACK QUANTITY: 1 PER BOX

HEAVY DUTY MANHOLE FRAME WITH MELAMINE PANEL



DOORS CAN BE SOLD SEPARATELY:
SKMH01P-1 FOR KMH01P,
SKMH02P-01 FOR KMH02P,
SKMH03P-01 FOR KMH03P.
BOX QUANTITY: 5 PER BOX.

OUTER FRAME	CUT OUT	CODE
450mm x 600mm	403mm x 553mm	KMH01P
600mm x 600mm	553mm x 553mm	KMH02P
450mm x 450mm	403mm x 403mm	KMH03P

- COMPLETE WITH MELAMINE PANEL
- FITS STANDARD 450mm - 600mm CEILING JOISTS
- ATTRACTIVE APPEARANCE
- MORE ECONOMICAL THAN WOODEN FRAMES
- HI - IMPACT WHITE PLASTIC CONSTRUCTION
- INSTALLATION TAKES MINUTES

ACCESS PANELS & FRAMES

ACCESS PANEL SYSTEM



OUTER FRAME	CUT OUT	CODE
290mm x 290mm	245mm x 245mm	KAP01S
200mm x 200mm	155mm x 155mm	KAP02S
345mm x 345mm	300mm x 300mm	KAP03S

- SNAP IN, TAMPER RESISTANT DOOR, CLIPS IN 4 PLACES
- REVERSIBLE FRAME ALLOWS FLUSH MOUNTING OF MATERIALS SUCH AS TILES
- FRAME IS MOULDED IN ONE PIECE, I.E. NO MITRED JOINTS TO PREPARE
- HI-IMPACT UV STABILISED PLASTIC CONSTRUCTION CAN BE PAINTED IF DESIRED
- AVAILABLE IN 3 CONVENIENT SIZES IN THE COLOUR WHITE
- CAN BE PURCHASED INDIVIDUALLY OR IN BOX QUANTITIES OF 10
- PACK SIZE: 1 PER BOX (AVAILABLE IN 10 PACK: KAP01, KAP02, KAP03)

HEAVY DUTY MANHOLE FRAME KITS



BEFORE ASSEMBLY

OUTER FRAME	CUT OUT	CODE
450mm x 450mm	403mm x 403mm	KMHK4545
450mm x 600mm	403mm x 553mm	KMHK4560
600mm x 600mm	553mm x 553mm	KMHK6060

- SUPPLIED IN A KNOCK DOWN FORM, ENVIRONMENTALLY FRIENDLY, LESS PACKAGING
- FITS ALL STANDARD 450mm - 600mm CEILING JOIST CENTRES
- EASY TO ASSEMBLE
- CAN BE PAINTED, IF DESIRED
- GREAT TIME SAVER - INSTALLATION TAKES MINUTES
- HI-IMPACT PLASTIC CONSTRUCTION
- AUSTRALIAN MADE, AUSTRALIAN OWNED

AFTER ASSEMBLY

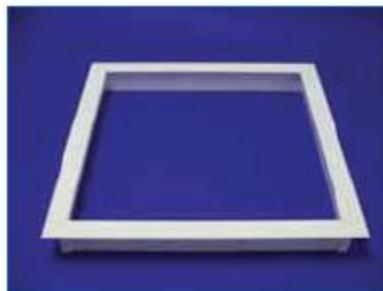

1 PACK MAKES 1 COMPLETE FRAME