

MHI

Manual No. '08-SRK-T-079

TECHNICAL MANUAL

Collection data

INVERTER WALL MOUNTED TYPE ROOM AIR-CONDITIONER (Split system, air to air heat pump type)

SRK50ZHX-S, SRK60ZHX-S

CONTENTS

1 GENERAL INFORMATION	1
1.1 Specific features.....	1
1.2 How to read the model name	1
2 SELECTION DATA	2
2.1 Specifications	2
2.2 Range of usage & limitations	4
2.3 Exterior dimensions	4
2.4 Piping system	5
2.5 Selection chart	6
3 ELECTRICAL DATA	7
3.1 Electrical wiring.....	7
4 OUTLINE OF OPERATION CONTROL BY MICROCOMPUTER	8
4.1 Operation control function by remote control switch.....	8
4.2 Unit ON/OFF button.....	9
4.3 Auto restart function	9
4.4 Custom cord switching procedure	9
4.5 Flap and louver control.....	10
4.6 3D auto operation	11
4.7 Timer operation	12
4.8 Installation location setting	12
4.9 Outline of heating operation	13
4.10 Outline of cooling operation	14
4.11 Outline of automatic operation	14
4.12 Protective control function	15
5 APPLICATION DATA	20
5.1 Selection of location for installation	22
5.2 Installation of indoor unit	24
5.3 Installation of outdoor unit.....	27
5.4 Connection of refrigerant pipings	27
5.5 Test run	29
5.6 Precautions for wireless remote control installation and operation	29

6	MAINTENANCE DATA	30
6.1	Troubleshooting procedures for electrical equipment	30
6.2	Servicing	48
7	REFRIGERANT PIPING INSTALLATION / SERVICING MANUAL	
	FOR AIR CONDITIONERS USING R410A.....	49
7.1	Outline	49
7.2	Refrigerant piping installation	50
7.3	Installation, removal and servicing.....	56
7.4	Refrigerant recovery	61

1 GENERAL INFORMATION

1.1 Specific features

The “MITSUBISHI HEAVY INDUSTRIES, LTD” room air-conditioner: SRK series are of split and wall mounted type and the unit consists of indoor unit and outdoor unit with refrigerant precharged in factory. The indoor unit is composed of room air cooling or heating equipment with operation control switch and the outdoor unit is composed of condensing unit with compressor.

(1) Inverter (Frequency converter) for multi-steps power control

- Heating/Cooling

The rotational speed of a compressor is changed in step in relation to varying load, interlocked with the indoor and outdoor unit fans controlled to change frequency, thus controlling the capacity.

- Allowing quick heating/cooling operation during start-up period. Constant room temperature by fine-tuned control after the unit has stabilized.

(2) Fuzzy control

- Fuzzy control calculates the amount of variation in the difference between the return air temperature and the setting temperature in compliance with the fuzzy rules in order to control the air capacity and the inverter frequency.

(3) Remote control flap & louver

The flap & louver can be automatically controlled by operating wireless remote control.

- Flap swing : The flaps swing up and down successively.
- Louver swing : The louvers swing left and right successively.
- 3D auto operation : Fan speed and air flow direction are automatically controlled, allowing the entire room to be efficiently conditioned.
- Memory flap : Once the flap & louver position is set, the unit memorizes the position and continues to operate at the same position from the next time.

(4) Self diagnosis function

- We are constantly trying to do better service to our customers by installing such judges that show abnormality of operation as follows.

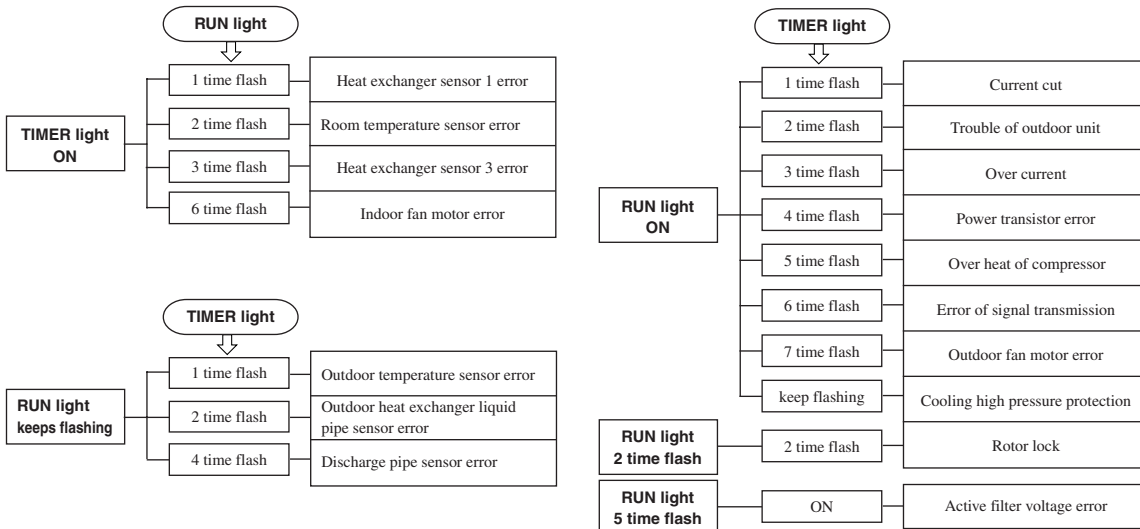

1.2 How to read the model name

Example :

SR K 50 Z HX - S

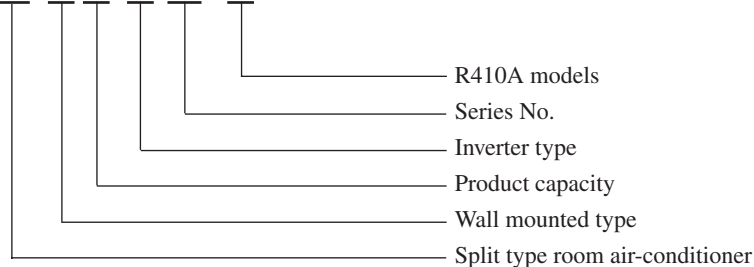

2 SELECTION DATA

2.1 Specifications

Model SRK50ZHX-S (Indoor unit)
SRC50ZHX-S (Outdoor unit)

(220/230/240V)

Item		Model	SRK50ZHX-S	SRC50ZHX-S	
Cooling capacity ⁽¹⁾		W	5000 (700~6200)		
Heating capacity ⁽¹⁾		W	6000 (700~8800)		
Power source			1 Phase, 220-240V, 50Hz		
Operation data ⁽¹⁾	Cooling input		kW	1.30 (0.2~2.20)	
	Running current (Cooling)		A	6.0/5.7/5.5	
	Heating input		kW	1.35 (0.2~2.26)	
	Running current (Heating)		A	6.2/5.9/5.7	
	Inrush current		A	6.2/5.9/5.7	
	COP			Cooling: 3.85 Heating: 4.44	
Noise level	Cooling	Sound level	dB	Hi 45, Me 38, Lo 26	
		Power level		48	
	Heating	Sound level	dB	Hi 45, Me 38, Lo 32	
		Power level		48	
Exterior dimensions Height × Width × Depth		mm	309 × 890 × 220	640 × 800 × 290	
Color			Fine snow	Stucco white	
Net weight		kg	15	43	
Refrigerant equipment Compressor type & Q'ty			-	5CS130XGB04 [Scroll type] × 1	
Motor		kW	-	0.9	
Starting method			-	Line starting	
Heat exchanger			New Louver fins & inner grooved tubing	New M fins & inner grooved tubing	
Refrigerant control			Capillary tubes + Electronic expansion valve		
Refrigerant ⁽³⁾		kg	R410A 1.4 (Pre-Charged up to the piping length of 15m)		
Refrigerant oil		ℓ	0.48 (RB68A or Freol Alpha 68M)		
Deice control			Microcomputer control		
Air handling equipment Fan type & Q'ty			Tangential fan × 1	Propeller fan × 1	
Motor		W	27	34	
Air flow	(Cooling)	CMM	Hi 13.5 Me 11 Lo 8	36.0	
	(Heating)		Hi 16.5 Me 14.5 Lo 10.5	33.0	
Air filter, Q'ty			Polypropylene net (washable) × 2	-	
Shock & vibration absorber			-	Cushion rubber (for compressor)	
Electric heater			-	-	
Operation control Operation switch			Wireless-Remote control	-	
Room temperature control			Microcomputer thermostat	-	
Pilot lamp			RUN (Green), TIMER (Yellow), HI POWER (Green), 3D AUTO (Green), ECONO (Blue)		
Safety equipment			Compressor overheat protection, Heating overload protection (High pressure control), Overcurrent protection, Frost protection, Serial signal error protection, Indoor fan motor error protection, Cooling overload protection		
Refrigerant piping	O.D	mm (in)	Liquid line: φ6.35 (1/4") Gas line: φ12.7 (1/2")		
	Connecting method		Flare connecting		
	Attached length of piping			Liquid line: 0.55 m Gas line : 0.49 m	-
	Insulation			Necessary (Both sides)	
Drain hose			Connectable		
Power source cord			-		
Connection wiring	Size × Core number		1.5 mm ² × 4 cores (Including earth cable)		
	Connecting method		Terminal block (Screw fixing type)		
Accessories (included)			Mounting kit, Clean filter (Allergen clear filter x1, Photocatalytic washable deodorizing filter x1)		
Optional parts			Interface kit		

Notes (1) The data are measured at the following conditions.

Operation	Item	Indoor air temperature		Outdoor air temperature		Standards
		DB	WB	DB	WB	
Cooling		27°C	19°C	35°C	24°C	ISO-T1, JIS C9612
Heating		20°C	-	7°C	6°C	ISO-T1, JIS C9612

The piping length is 7.5m.

- The operation data are applied to the 220/230/240V districts respectively.
- The refrigerant quantity to be charged includes the refrigerant in 15 m connecting piping. (Purging is not required even for the short piping.)
If the piping length is longer, when it is 15 to 30m, add 20 g refrigerant per meter.
- If the interface kit (SC-BIKN-E) (sold separately) is connected to the terminals on the indoor unit's circuit board, a wired remote control (sold separately) can be connected, a Super Link (with SC-ADN-E sold separately) can be connected, and the unit can be turned on and off from a CNT terminal.

Model SRK60ZHX-S (Indoor unit)
SRC60ZHX-S (Outdoor unit)

(220/230/240V)

Item		Model	SRK60ZHX-S	SRC60ZHX-S	
Cooling capacity ⁽¹⁾		W	6000 (800~6800)		
Heating capacity ⁽¹⁾		W	6800 (800~9700)		
Power source			1 Phase, 220-240V, 50Hz		
Operation data ⁽¹⁾	Cooling input	kW	1.86 (0.25~2.30)		
	Running current (Cooling)	A	8.5/8.2/7.8		
	Heating input	kW	1.67 (0.25~2.70)		
	Running current (Heating)	A	7.7/7.3/7.0		
	Inrush current	A	8.5/8.2/7.8		
	COP			Cooling: 3.23 Heating: 4.07	
	Noise level	Cooling	Sound level	Hi 47, Me 38, Lo 26	51
Power level			62	65	
Heating		Sound level	Hi 45, Me 39, Lo 33	51	
		Power level	62	65	
Exterior dimensions Height × Width × Depth		mm	309 × 890 × 220	640 × 800 × 290	
Color			Fine snow	Stucco white	
Net weight		kg	15	43	
Refrigerant equipment Compressor type & Q'ty			-	5CS130XGB04 [Scroll type] × 1	
Motor		kW	-	0.9	
Starting method			-	Line starting	
Heat exchanger			New Louver fins & inner grooved tubing	New M fins & inner grooved tubing	
Refrigerant control			Capillary tubes + Electronic expansion valve		
Refrigerant ⁽³⁾		kg	R410A 1.4 (Pre-Charged up to the piping length of 15m)		
Refrigerant oil		ℓ	0.48 (RB68A or Freol Alpha 68M)		
Deice control			Microcomputer control		
Air handling equipment Fan type & Q'ty			Tangential fan × 1	Propeller fan × 1	
Motor		W	27	34	
Air flow	(Cooling)	CMM	Hi 14.5 Me 12.5 Lo 8.5	41.5	
	(Heating)		Hi 17.0 Me 15.0 Lo 11.0	36.0	
Air filter, Q'ty			Polypropylene net (washable) × 2	-	
Shock & vibration absorber			-	Cushion rubber (for compressor)	
Electric heater			-	-	
Operation control Operation switch			Wireless-Remote control	-	
Room temperature control			Microcomputer thermostat	-	
Pilot lamp			RUN (Green), TIMER (Yellow), HI POWER (Green), 3D AUTO (Green), ECONO (Blue)		
Safety equipment			Compressor overheat protection, Heating overload protection (High pressure control), Overcurrent protection, Frost protection, Serial signal error protection, Indoor fan motor error protection, Cooling overload protection		
Refrigerant piping	O.D	mm (in)	Liquid line: φ6.35 (1/4") Gas line: φ12.7 (1/2")		
	Connecting method		Flare connecting		
	Attached length of piping		Liquid line: 0.55 m Gas line : 0.49 m	-	
	Insulation		Necessary (Both sides)		
Drain hose			Connectable		
Power source cord			-		
Connection wiring	Size × Core number		1.5 mm ² × 4 cores (Including earth cable)		
	Connecting method		Terminal block (Screw fixing type)		
Accessories (included)			Mounting kit, Clean filter (Allergen clear filter x1, Photocatalytic washable deodorizing filter x1)		
Optional parts			Interface kit		

Notes (1) The data are measured at the following conditions.

Operation	Item	Indoor air temperature		Outdoor air temperature		Standards
		DB	WB	DB	WB	
Cooling		27°C	19°C	35°C	24°C	ISO-T1, JIS C9612
Heating		20°C	-	7°C	6°C	ISO-T1, JIS C9612

The piping length is 7.5m.

- The operation data are applied to the 220/230/240V districts respectively.
- The refrigerant quantity to be charged includes the refrigerant in 15 m connecting piping. (Purging is not required even for the short piping.)
If the piping length is longer, when it is 15 to 30m, add 20 g refrigerant per meter.
- If the interface kit (SC-BIKN-E) (sold separately) is connected to the terminals on the indoor unit's circuit board, a wired remote control (sold separately) can be connected, a Super Link (with SC-ADN-E sold separately) can be connected, and the unit can be turned on and off from a CNT terminal.

2.2 Range of usage & limitations

Item	Models	SRK50ZHX-S, 60ZHX-S
Indoor return air temperature (Upper, lower limits)		Cooling operation : Approximately 18 to 32°C Heating operation : Approximately 15 to 30°C
Outdoor air temperature (Upper, lower limits)		Cooling operation : Approximately -15 to 46°C Heating operation : Approximately -15 to 21°C
Refrigerant line (one way) length		Max. 30m
Vertical height difference between outdoor unit and indoor unit		Max. 20m (Outdoor unit is higher) Max. 20m (Outdoor unit is lower)
Power source voltage		Rating ± 10%
Voltage at starting		Min. 85% of rating
Frequency of ON-OFF cycle		Max. 7 times/h (Inching prevention 5 minutes)
ON and OFF interval		Max. 3 minutes

2.3 Exterior dimensions

(1) Indoor unit

Models SRK50ZHX-S, 60ZHX-S

Unit: mm

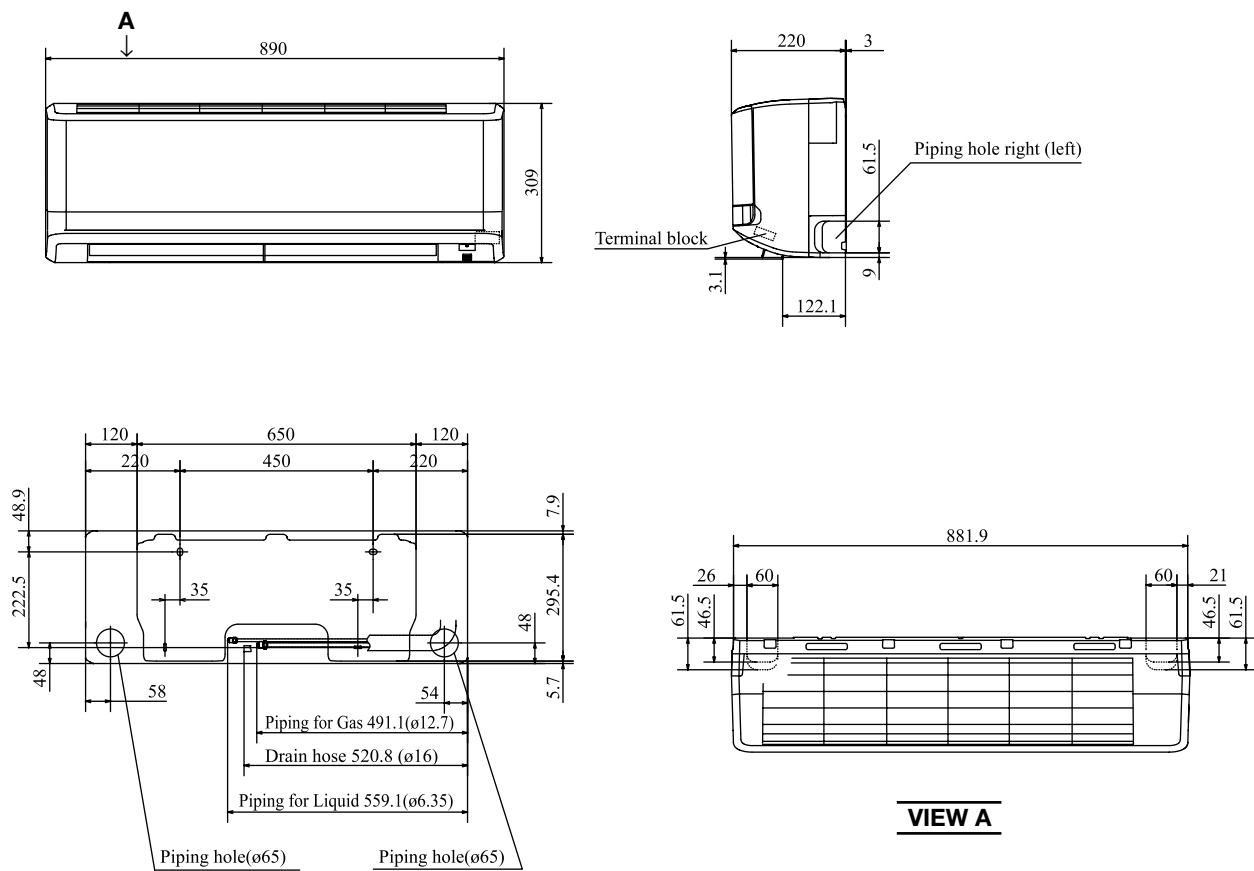

(2) Outdoor unit

Models SRC50ZH-S, 60ZH-S

Unit: mm

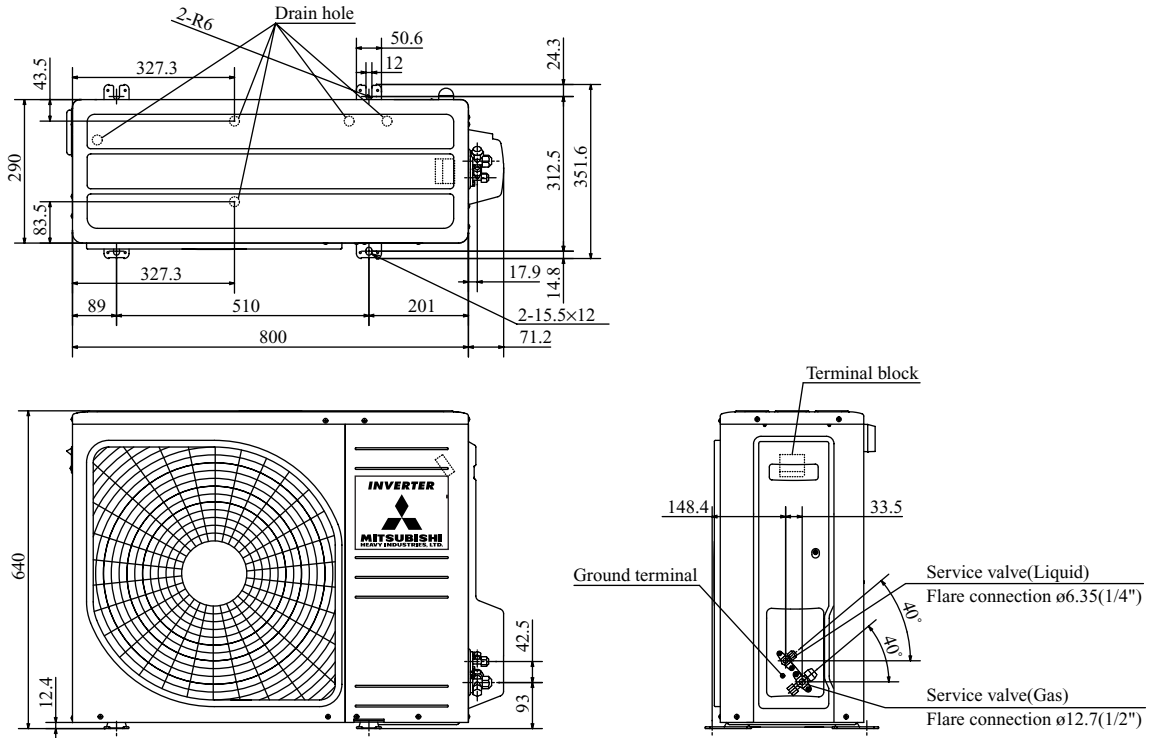

2.4 Piping system

Models SRK50ZH-S, 60ZH-S

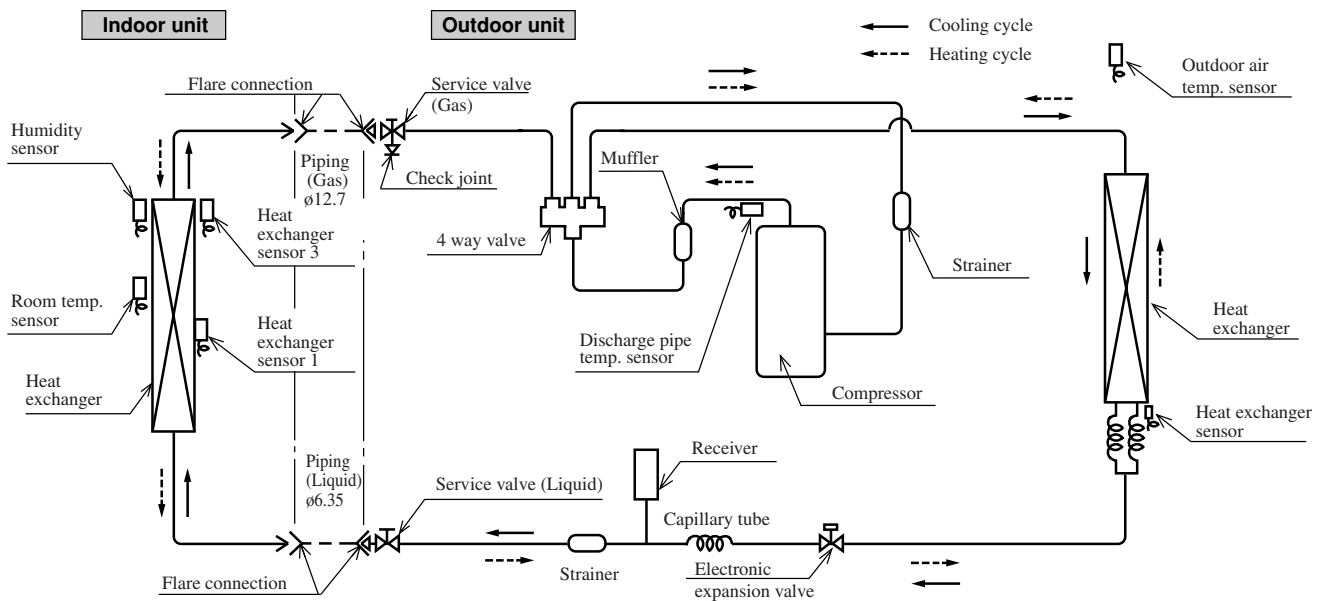

2.5 Selection chart

Correct the cooling and heating capacity in accordance with the conditions as follows. The net cooling and heating capacity can be obtained in the following way.

Net capacity = Capacity shown on specification × Correction factors as follows.

(1) Coefficient of cooling and heating capacity in relation to temperatures

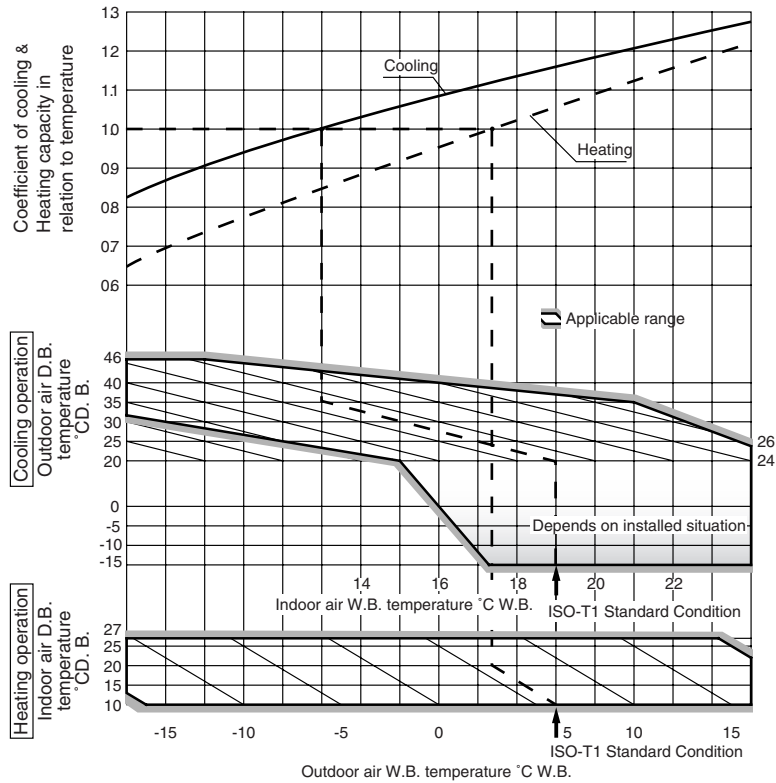

(2) Correction of cooling and heating capacity in relation to one way length of refrigerant piping

It is necessary to correct the cooling and heating capacity in relation to the one way piping length between the indoor and outdoor units.

Piping length [m]	7	10	15	20	25
Cooling	1.0	0.99	0.975	0.965	0.95
Heating	1.0	1.0	1.0	1.0	1.0

(3) Correction relative to frosting on outdoor heat exchanger during heating

In additions to the foregoing corrections (1), (2) the heating capacity needs to be adjusted also with respect to the frosting on the outdoor heat exchanger.

Air inlet temperature of outdoor unit in °CWB	-10	-9	-7	-5	-3	-1	1	3	5
Adjustment coefficient	0.95	0.94	0.93	0.91	0.88	0.86	0.87	0.92	1.00

How to obtain the cooling and heating capacity

Example : The net cooling capacity of the model SRK60ZHX-S with the piping length of 15m, indoor wet-bulb temperature at 19.0°C and outdoor dry-bulb temperature 35°C is Net cooling capacity =

$$\begin{array}{ccccccc}
 \frac{6000}{\uparrow} & \times & \frac{0.975}{\uparrow} & \times & \frac{1.0}{\uparrow} & = & 5850 \text{ W} \\
 \text{SRK60ZHX-S} & & \text{Length 15m} & & \text{Factor by air} & & \\
 & & & & \text{temperatures} & &
 \end{array}$$

3 ELECTRICAL DATA

3.1 Electrical wiring Models SRK50ZH-X-S, 60ZH-X-S

Color symbol

BK	Black
BL	Blue
BR	Brown
OR	Orange
RD	Red
WH	White
YE	Yellow
YG	Yellow/Green

Meaning of marks

Symbol	Parts name	Symbol	Parts name	Symbol	Parts name
CM	Compressor motor	Th1	Room temp.sensor	20S	4 way valve (coil)
F	Fuse	Th2,3	Heat exch.sensor (Indoor unit)	EEV	Electronic expansion valve
FM1	Fan motor (Indoor)	Th4	Heat exch.sensor (Outdoor unit)	DS	Diode stack
FM0	Fan motor (Outdoor)	Th5	Outdoor air temp.sensor	R	Reactor
SM1	Flap motor (L)	Th6	Discharge pipe temp.sensor	T	Terminal block
SM2	Flap motor (R)	HD	Humidity sensor	LS	LIMIT sw
SM3	Louver motor (L)	ZNR	Varistor		
SM4	Louver motor (R)				
SM5	Inlet motor				

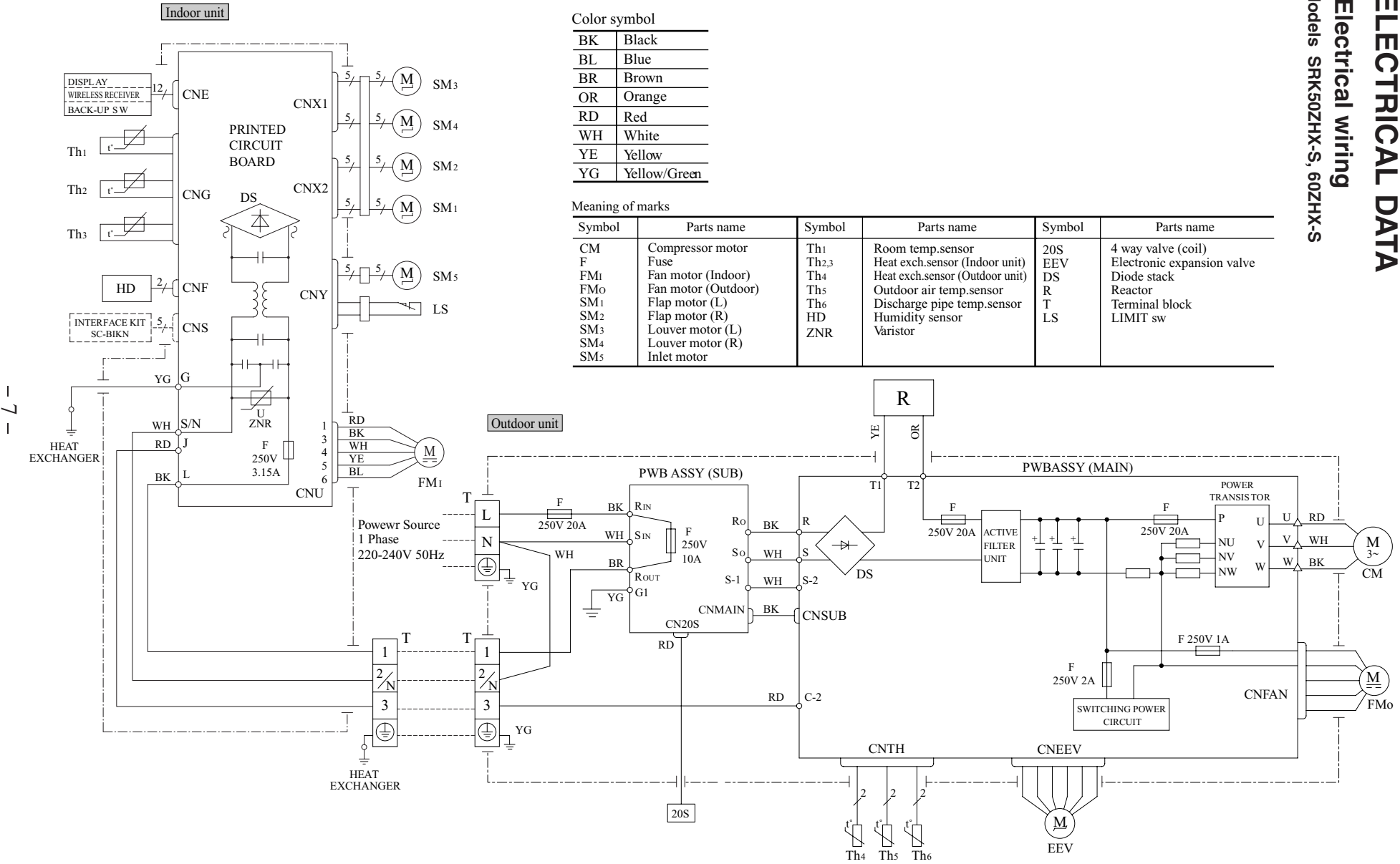

4 OUTLINE OF OPERATION CONTROL BY MICROCOMPUTER

4.1 Operation control function by remote control switch

Remote control

Models All models

◆ Operation section

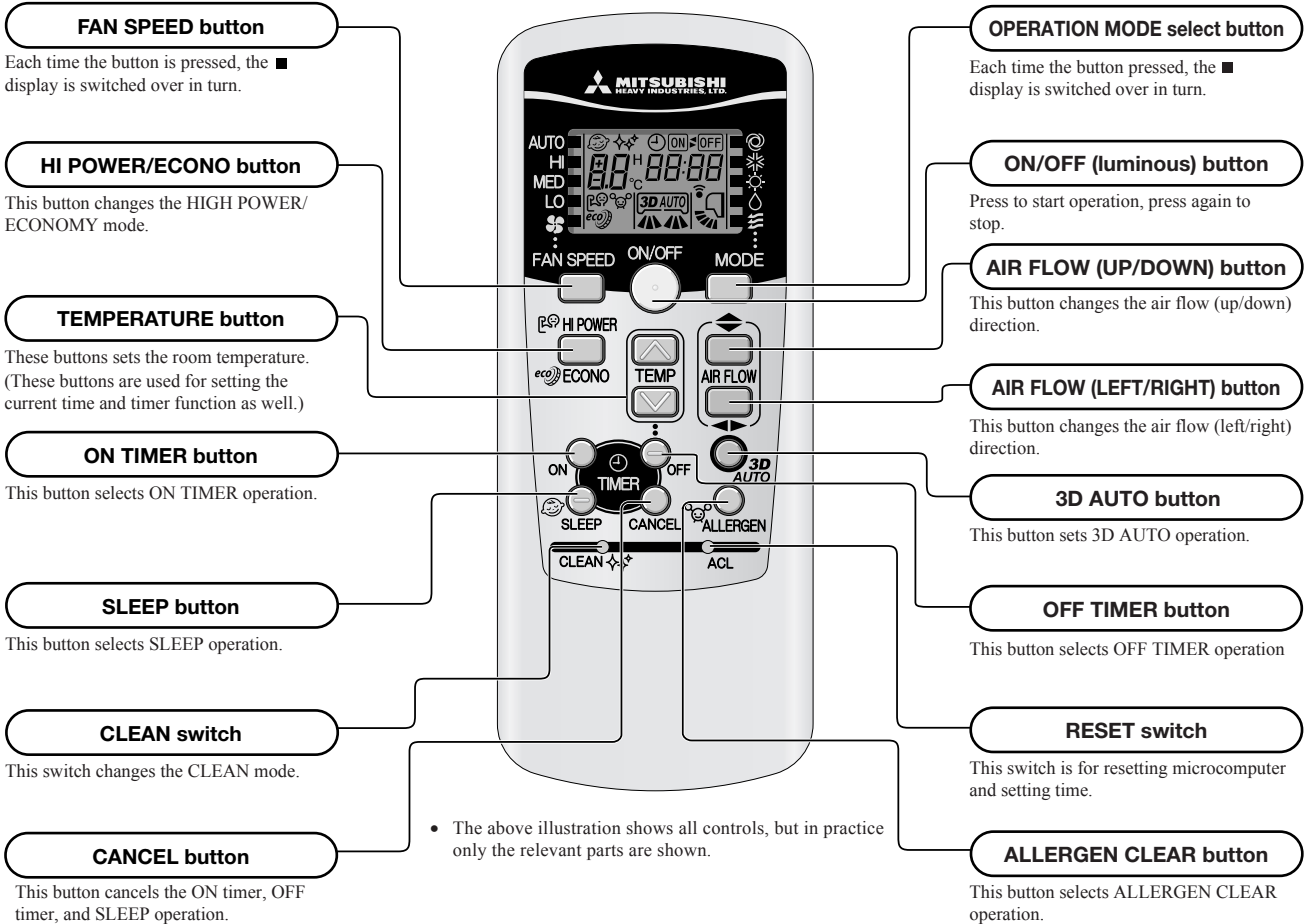

Unit indication section

Models All models

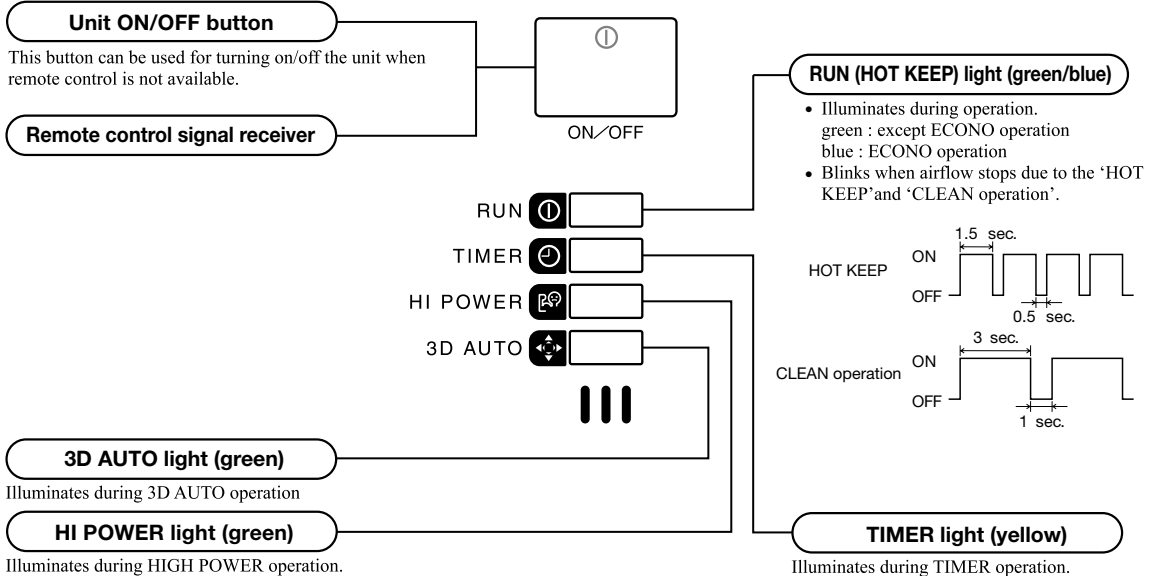

4.2 Unit ON/OFF button

When the remote control batteries become weak, or if the remote control is lost or malfunctioning, this button may be used to turn the unit on and off.

(1) Operation

Push the button once to place the unit in the automatic mode. Push it once more to turn the unit off.

(2) Details of operation

The unit will go into the automatic mode in which it automatically determines, from room temperature (as detected by sensor), whether to go into the cooling, thermal dry or heating modes.

Function	Room temperature setting	Fan speed	Flap/Louver	Timer switch
Operation mode				
Cooling	About 24°C	Auto	Auto	Continuous
Thermal dry	About 25°C			
Heating	About 26°C			

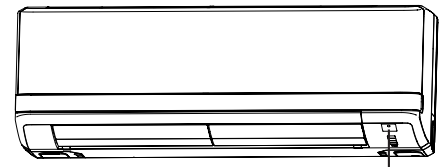

Unit ON/OFF button

4.3 Auto restart function

(1) Auto restart function records the operational status of the air-conditioner immediately prior to be switched off by a power cut, and then automatically resumes operations after the power has been restored.

(2) The following settings will be cancelled:

- (a) Timer settings
- (b) HIGH POWER operations

Notes (1) Auto restart function is set on when the air-conditioner is shipped from the factory. Consult with your dealer if this function needs to be switched off.

- (2) When power failure occurs, the timer setting is cancelled. Once power is resumed, reset the timer.
- (3) If the jumper wire (J170) "AUTO RESTART" is cut, auto restart is disabled. (See the diagram at right)

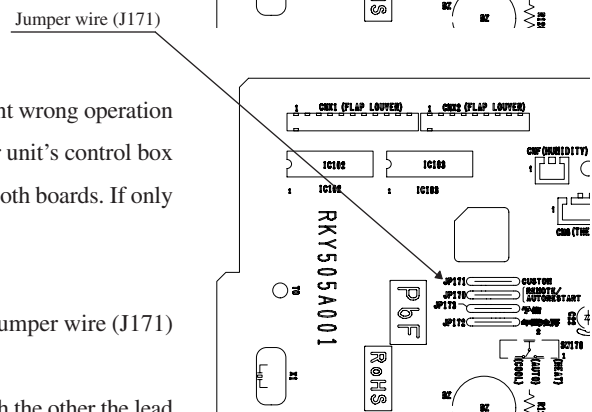
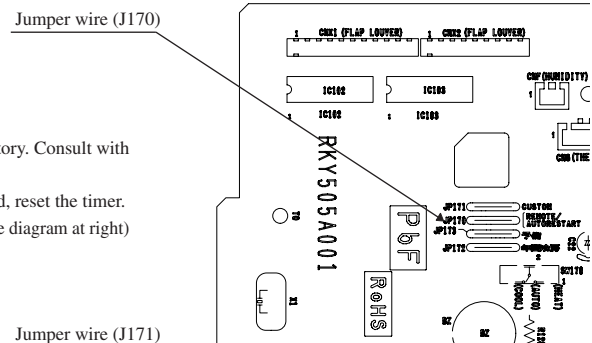

4.4 Custom cord switching procedure

If two wireless remote controls are installed in one room, in order to prevent wrong operation due to mixed signals, please modify the printed circuit board in the indoor unit's control box and the remote control using the following procedure. Be sure to modify both boards. If only one board is modified, receiving (and operation) cannot be done.

(1) Modifying the indoor unit's printed circuit board

Take out the printed circuit board from the control box and cut off jumper wire (J171) using wire cutters.

After cutting of the jumper wire, take measures to prevent contact with the other the lead wires, etc.

(2) Modifying the wireless remote control

- (a) Remove the battery.
- (b) Cut the jumper wire shown in the figure at right.

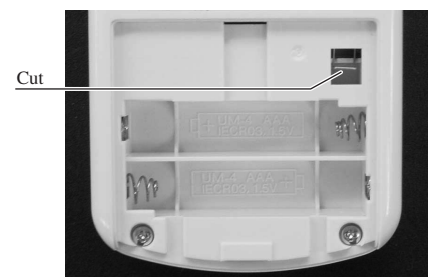

4.5 Flap and louver control

Control the flap and louver by AIRFLOW \blacklozenge (UP/DOWN) and \blacktriangleleft (LEFT/RIGHT) button on the wireless remote control.

(1) Flap

Each time when you press the AIRFLOW \blacklozenge (UP/DOWN) button the mode changes as follows.

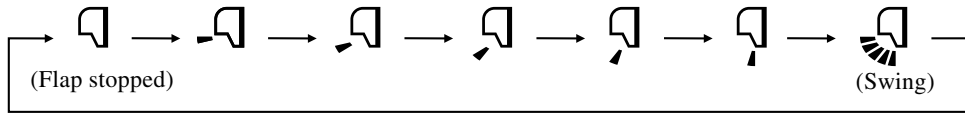

• Angle of Flap from Horizontal

Remote control display					
COOL , DRY, FAN	Approx. 5°	Approx. 20°	Approx. 35°	Approx. 45°	Approx. 60°
HEAT	Approx. 20°	Approx. 35°	Approx. 45°	Approx. 60°	Approx. 75°

(2) Louver

Each time when you press the AIRFLOW \blacktriangleleft (LEFT/RIGHT) button the mode changes as follows.

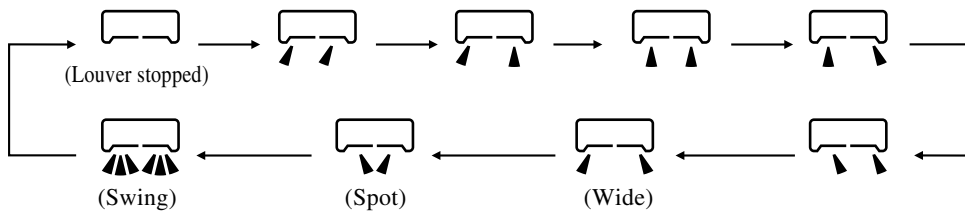

• Angle of Louver

Remote control display					
Center installation	Left Approx. 50°	Left Approx. 20°	Center	Right Approx. 20°	Right Approx. 50°
Right end installation	Left Approx. 50°	Left Approx. 45°	Left Approx. 30°	Center	Right Approx. 20°
Left end installation	Left Approx. 20°	Center	Right Approx. 30°	Right Approx. 45°	Right Approx. 50°

(3) Swing

(a) Swing flap

Flap moves in upward and downward directions continuously.

\blacklozenge In HEAT operation

\blacklozenge In COOL, DRY, FAN operation

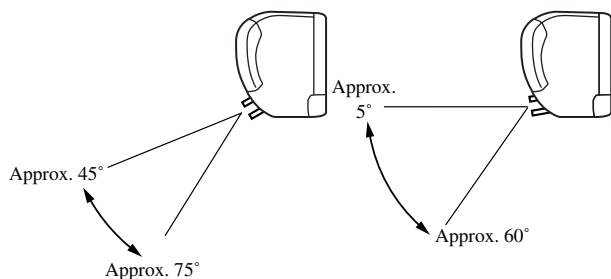

(b) Swing louver

Louver moves in left and right directions continuously.



(4) Memory flap (Flap or Louver stopped)

When you press the AIRFLOW (UP/DOWN or LEFT/RIGHT) button once while the flap or louver is operating, it stops swinging at the position. Since this angle is memorized in the microcomputer, the flap or louver will automatically be set at this angle when the next operation is started.

(5) When not operating

The flap returns to the position of air flow directly below, when operation has stopped.

4.6 3D auto operation

Control the flap and louver by 3D AUTO button on the wireless remote control.

Air flow selection and air flow direction are automatically controlled, allowing the entire room to efficiently conditioned.

(1) During Cooling and Heating (Including auto cooling and heating)

(a) Air flow selection is determined according to room temperature and setting temperature.

Operation mode	Air flow selection				
	AUTO		HI	MED	LO
At cooling	Room temp. – Setting temp. $>5^{\circ}\text{C}$	Room temp. – Setting temp. $\leq 5^{\circ}\text{C}$	HI	MED	LO
	HIGH POWER	AUTO			
At heating	Setting temp. – Room temp. $>5^{\circ}\text{C}$	Setting temp. – Room temp. $\leq 5^{\circ}\text{C}$	HI	MED	LO
	HIGH POWER	AUTO			

(b) Air flow direction is controlled according to the room temperature and setting temperature.

1) When 3D auto operation starts

	Cooling	Heating
Flap	Up/down Swing	
Louver	Wide (fixed)	Center (fixed)

2) When Room temp. – Setting temp. is $\leq 5^{\circ}\text{C}$ during cooling and when Setting temp. – Room temp. is $\leq 5^{\circ}\text{C}$ during heating, the system switches to the following air flow direction control. After the louver swings left and right symmetrically for 3 cycles, control is switched to the control in 3).

	Cooling	Heating
Flap	Horizontal blowing (Fixed)	Slant forwardl blowing (Fixed)
Louver	Left/right Swing	

3) After the flap swings for 5 cycles, control is switched to the control in 4).

	Cooling	Heating
Flap	Up/down Swing	
Louver	Center (Fixed)	

4) For 5 minutes, the following air flow direction control is carried out.

	Cooling	Heating
Flap	Horizontal blowing (Fixed)	Slant forwardl blowing (Fixed)
Louver	Wide (Fixed)	

5) After 5 minutes have passed, the air flow direction is determined according to the room temperature and setting temperature.

Operation mode	Air flow direction control		
At cooling	Room temp. – Setting temp. $\leq 2^{\circ}\text{C}$	$2^{\circ}\text{C} < \text{Room temp. – Setting temp.} \leq 5^{\circ}\text{C}$	Room temp. – Setting temp. $> 5^{\circ}\text{C}$
	The control in 4) continues.	Control returns to the control in 2).	Control returns to the control in 1).
At heating	Setting temp. – Room temp. $\leq 2^{\circ}\text{C}$	$2^{\circ}\text{C} < \text{Setting temp. – Room temp.} \leq 5^{\circ}\text{C}$	Setting temp. – Room temp. $> 5^{\circ}\text{C}$
	The control in 4) continues.	Control returns to the control in 2).	Control returns to the control in 1).

(2) During DRY Operation (including auto DRY operation)

Air flow selection	According to DRY operation.
Flap	Horizontal blowing (Fixed)
Louver	Wide (Fixed)

4.7 Timer operation

(1) Comfortable timer setting (ON timer)

If the timer is set at ON when the operation select switch is set at the cooling or heating, or the cooling or heating in auto mode operation is selected, the comfortable timer starts and determines the starting time of next operation based on the initial value of 15 minutes and the relationship between the room temperature at the setting time (temperature of room temperature sensor) and the setting temperature.

(2) Sleep timer operation

Pressing the SLEEP button causes the temperature to be controlled with respect to the set temperature.

(3) OFF timer operation

The Off timer can be set at a specific time (in 10-minute units) within a 24-hour period.

4.8 Installation location setting

When the indoor unit is installed at the end of a room, control the air flow direction so that it is not toward the side walls. If you set the remote control's installation position, keep it so that the air flow is within the range shown in the following figure.

(1) Setting

- ① **If the air conditioning unit is running, press the ON/OFF button to stop.**

The installation location setting cannot be made while the unit is running.

- ② **Press the AIR FLOW \updownarrow (UP/DOWN) button and the AIRFLOW $\leftarrow\rightarrow$ (LEFT/RIGHT) button together for 5 seconds or more.**

The installation location display illuminates.

- ③ **Setting the air-conditioning installation location.**

Press the AIR FLOW $\leftarrow\rightarrow$ (LEFT/RIGHT) button and adjust to the desired location.

Each time the AIR FLOW $\leftarrow\rightarrow$ (LEFT/RIGHT) button is pressed, the indicator is switched in the order of:



- ④ **Press the ON/OFF button.**

The air-conditioner's installation location is set.

Press within 60 seconds of setting the installation location (while the installation location setting display illuminates).

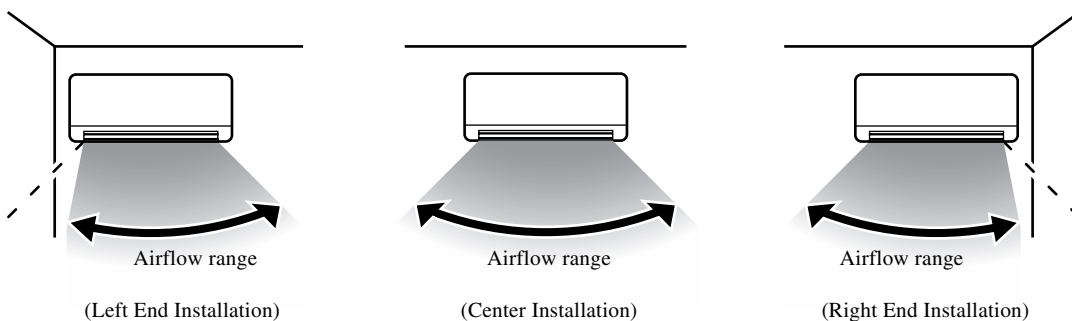
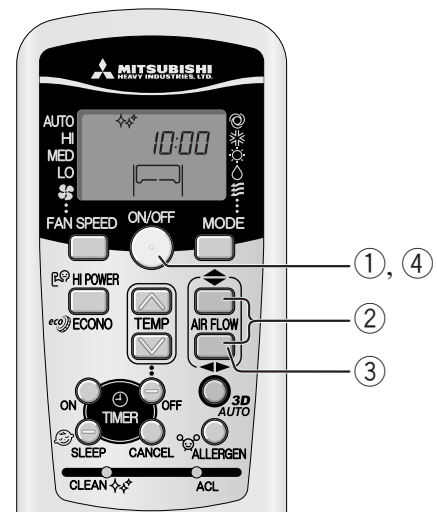

4.9 Outline of heating operation

(1) Operation of major functional components in heating mode

	Heating		
	Thermostat ON	Thermostat OFF	Failure
Compressor	ON	OFF	OFF
Indoor fan motor	ON	ON(HOT KEEP)	OFF
Outdoor fan motor	ON	OFF (few minutes ON)	OFF
4-way valve	ON	ON	OFF (3 minutes ON)

(2) Details of control at each operation mode (pattern)

(a) Fuzzy operation

Deviation between the room temperature setting correction temperature and the suction air temperature is calculated in accordance with the fuzzy rule, and used for control of the air capacity and the inverter speed.

Fan speed	Model	SRK50ZHX-S	SRK60ZHX-S
	Auto		12~106rps
HI		12~106rps	12~120rps
MED		12~74rps	12~90rps
LO		12~42rps	12~58rps

When the defrosting, protection device, etc. is actuated, operation is performed in the corresponding mode.

(b) Hot keep operation

If the hot keep operation is selected during the heating operation, the indoor blower is controlled based on the temperature of the indoor unit heat exchanger (Th2) to prevent blowing of cool wind.

(3) Defrosting operation

(a) Starting conditions (Defrosting operation can be started only when all of the following conditions are met.)

- ① After start of heating operation
When it elapsed 35 minutes. (Accumulated compressor operation time)
- ② After end of defrosting operation
When it elapsed 35 minutes. (Accumulated compressor operation time)
- ③ Outdoor unit heat exchanger sensor (Th4) temperature
When the temperature has been below -5°C for 3 minutes continuously.
- ④ The difference between the outdoor air sensor temperature and the outdoor unit heat exchanger sensor temperature
 - The outdoor air temperature $-2^{\circ}\text{C} : 7^{\circ}\text{C}$ or higher
 - -15°C _ The outdoor air temperature $< -2^{\circ}\text{C} : 4/15 \times$ The outdoor air temperature $+ 7^{\circ}\text{C}$ or higher
 - The outdoor air temperature $< -15^{\circ}\text{C} : -5^{\circ}\text{C}$ or higher
- ⑤ During continuous compressor operation
In addition, when the speed command from the indoor controller of the indoor unit during heating operation has counted 0 rps 10 times or more and all conditions of ①, ②, ③ and ④ above and the outdoor air temperature is 3°C or less are satisfied (note that when the temperature for Th4 is -5°C or less: 62 rps or more, -4°C or less: less than 62 rps), defrost operation is started.

(b) Ending conditions (Operation returns to the heating cycle when either one of the following is met.)

- ① Outdoor heat exchanger sensor (Th4) temperature: 10°C or higher
- ② Continued operation time of defrosting \rightarrow For more than 15 min.

4.10 Outline of cooling operation

(1) Operation of major functional components in Cooling mode

	Cooling		
	Thermostat ON	Thermostat OFF	Failure
Compressor	ON	OFF	OFF
Indoor fan motor	ON	ON	OFF
Outdoor fan motor	ON	OFF (few minutes ON)	OFF (few minutes ON)
4-way valve	OFF	OFF	OFF

(2) Detail of control in each mode (Pattern)

(a) Fuzzy operation

During the fuzzy operation, the air flow and the inverter speed are controlled by calculating the difference between the room temperature setting correction temperature and the suction air temperature.

Model	SRK50ZHX-S	SRK60ZHX-S
Fan speed		
Auto	12~86rps	12~110rps
HI	12~86rps	12~110rps
MED	12~62rps	12~86rps
LO	12~34rps	12~48rps

4.11 Outline of automatic operation

(1) Determination of operation mode

The unit checks the room temperature and the outdoor air temperature, determines the operation mode, and then begins in the automatic operation.

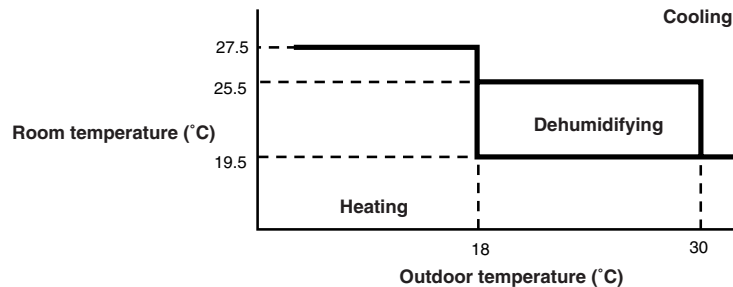

- The unit checks the temperature every hour after the start of operation and, if the result of check is not same as the previous operation mode, changes the operation mode.
- When the unit is started again within one hour after the stop of automatic operation or when the automatic operation is selected during heating, cooling or dehumidifying operation, the unit is operated in the previous operation mode.
- Setting temperature can be adjusted within the following range. There is the relationship as shown below between the signals of the wireless remote control and the setting temperature.

		Signals of wireless remote control (Display)												
		-6	-5	-4	-3	-2	-1	±0	+1	+2	+3	+4	+5	+6
Setting temperature	Cooling	18	19	20	21	22	23	24	25	26	27	28	29	30
	Dehumidifying	19	20	21	22	23	24	25	26	27	28	29	30	31
	Heating	20	21	22	23	24	25	26	27	28	29	30	31	32

4.12 Protective control function

(1) Frost prevention control (During cooling or dehumidifying)

(a) Operating conditions

- 1) Indoor heat exchanger temperature (Th2) is lower than 5°C.
- 2) 5 minutes after reaching the inverter command speed except 0 rps.

(b) Detail of anti-frost operation

Item	Indoor heat exchanger temperature	5°C or lower	2.5°C or lower
Lower limit speed		25 rps	0rps
Indoor fan		Depends on operation mode	Protects the fan tap just before frost prevention control
Outdoor fan		Depends on operation mode	Depends on stop mode
4-way valve		OFF	

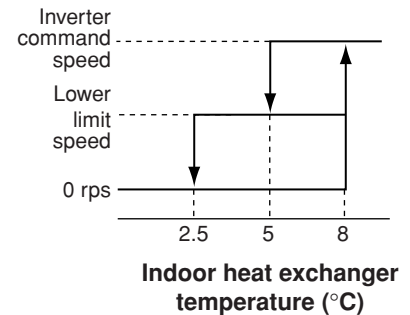

- Notes
- (1) When the indoor heat exchanger temperature is in the range of 2.5~5 °C, the speed is reduced by 4 rps at each 20 seconds.
 - (2) When the temperature is lower than 2.5 °C, the compressor is stopped.
 - (3) When the indoor heat exchanger temperature is in the range of 5~8 °C, the inverter command speed is been maintained.

(c) Reset conditions: When either of the following condition is satisfied.

- ① The indoor heat exchanger temperature (Th2) is 8°C or higher.
- ② The inverter command speed is 0 rps.

(2) Cooling overload protective control

(a) Operating conditions: When the outdoor air temperature (Th5) is 41°C or higher continues for 30 seconds while the inverter command speed of other than 0 rps.

(b) Detail of operation

- 1) The outdoor fan is stepped up by 3 speed step. (Upper limit 8th speed.)
- 2) The lower limit of inverter command speed is set to 30 rps and even if the calculated result becomes lower than that after fuzzy calculation, the speed is kept to 30 rps. However, when the thermo becomes OFF, the speed is reduced to 0 rps.

(c) Reset conditions: When either of the following condition is satisfied.

- ① The outdoor air temperature is lower than 40°C.
- ② The inverter command speed is 0 rps.

(3) Cooling high pressure control

(a) Purpose: Prevents anomalous high pressure operation during cooling.

(b) Detector: Outdoor heat exchanger sensor (Th4)

(c) Detail of operation:

(Example) Fuzzy

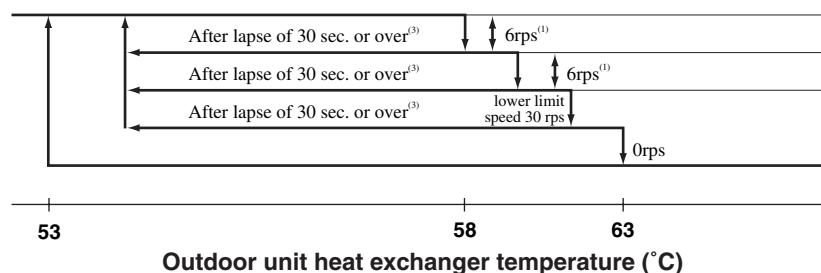

- Notes
- (1) When the outdoor heat exchanger temperature is in the range of 58~63 °C, the speed is reduced by 6 rps at each 30 seconds.
 - (2) When the temperature is 63 °C or higher, the compressor is stopped.
 - (3) When the outdoor heat exchanger temperature is in the range of 53~58 °C, if the inverter command speed is been maintained and the operation has continued for more than 30 seconds at the same speed, it returns to the normal cooling operation.

(4) Cooling low outdoor temperature protective control

(a) Operating conditions: When the outdoor air temperature (Th5) is 22°C or lower continues for 20 seconds while the inverter command speed is other than 0 rps.

(b) Detail of operation:

- ① The lower limit of the inverter command speed is set to 44 (30) rps and even if the speed becomes lower than 44 (30) rps, the speed is kept to 44 (30) rps. However, when the thermo becomes OFF, the speed is reduced to 0 rps.
- ② The upper limit of the inverter command speed is set to 50 (60) rps and even if the calculated result becomes higher than that after fuzzy calculation, the speed is kept to 50 (60) rps.

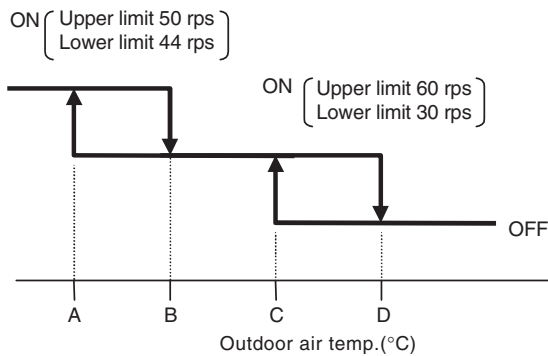

● Values of A, B, C, D

	Outdoor air temp. (°C)			
	A	B	C	D
First time	0	3	22	25
Since the seconds times	7	10	25	28

(c) Reset conditions: When either of the following condition is satisfied

- ① The outdoor air temperature (Th5) is D °C or higher.
- ② The inverter command speed is 0 rps.

(5) Heating high pressure control

(a) Purpose: Prevents anomalous high pressure operation during heating.

(b) Detector: Indoor heat exchanger sensor (Th2)

(c) Detail of operation:

(Example) Fuzzy

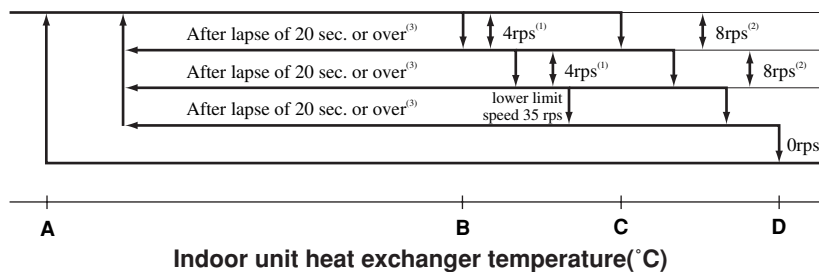

- Notes
- (1) When the indoor heat exchanger temperature is in the range of B~C °C, the speed is reduced by 4 rps at each 20 seconds.
 - (2) When the indoor heat exchanger temperature is in the range of C~D °C, the speed is reduced by 8 rps at each 20 seconds. When the temperature is D °C or higher continues for 1 minute, the compressor is stopped.
 - (3) When the indoor heat exchanger temperature is in the range of A~B °C, if the inverter command speed is been maintained and the operation has continued for more than 20 seconds at the same speed, it returns to the normal heating operation.
 - (4) Indoor blower retains the fan tap when it enters in the high pressure control. Outdoor blower is operated in accordance with the speed.

● **Temperature list**

Unit : °C

	A	B	C	D
RPSmin < 88	48.5	56	58	61
88 ≤ RPSmin < 108	44	51.5	53.5	56.5
108 ≤ RPSmin	39	46.5	48.5	51.5

Note (1) RPSmin: The lower one between the outdoor speed and the inverter command speed

(6) Heating overload protective control

(a) Operating conditions: When the outdoor air temperature (Th5) is 17°C or higher continues for 30 seconds while the inverter command speed other than 0 rps.

(b) Detail of operation:

- ① Taking the upper limit of inverter command speed range at 50 rps, if the output speed obtained with the fuzzy calculation exceeds the upper limit, the upper limit value is maintained.
- ② The lower limit of inverter command speed is set to 35 rps and even if the calculated result becomes lower than that after fuzzy calculation, the speed is kept to 35 rps. However, when the thermo becomes OFF, the speed is reduced to 0 rps.
- ③ Inching prevention control is activated and inching prevention control is carried out with the minimum speed set at 35 rps.
- ④ The outdoor fan is set on 2nd speed.
- ⑤ The indoor fan is stepped up by 1 speed step. (Upper limit 8th speed)

(c) Reset conditions: The outdoor air temperature (Th5) is lower than 16°C.

(7) Heating low outdoor temperature protective control

(a) Operating conditions: When the outdoor air temperature (Th5) is lower than 4°C or 13°C or higher continues for 30 seconds while the inverter command speed is other than 0 rps.

(b) Detail of operation: The lower limit inverter command speed is change as shown in the figure below.

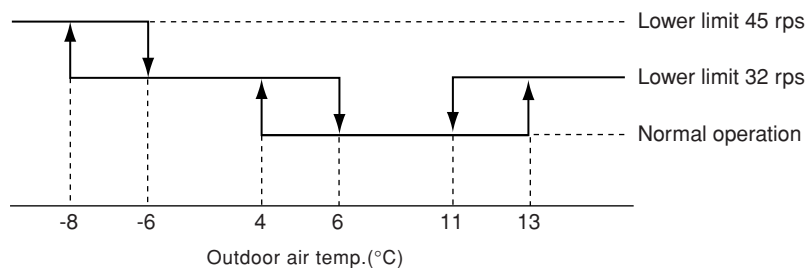

(c) Reset conditions: When either of the following condition is satisfied.

- ① The outdoor air temperature (Th5) becomes 6°C ~ 11°C.
- ② The inverter command speed is 0 rps.

(8) Compressor overheat protection

(a) Purpose: It is designed to prevent deterioration of oil, burnout of motor coil and other trouble resulting from the compressor overheat.

(b) Detail of operation

1) Speeds are controlled with temperature detected by the sensor mounted on the discharge pipe.

(Example) Fuzzy

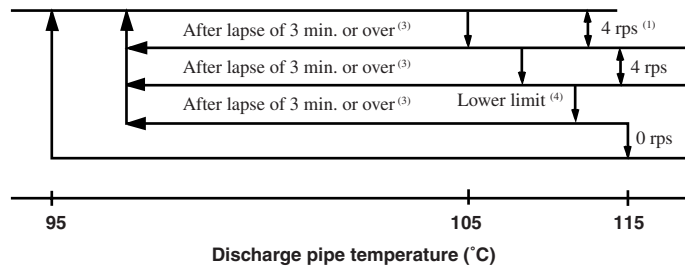

- Notes (1) When the discharge pipe temperature is in the range of 105~115°C, the speed is reduced by 4 rps.
 (2) When the discharge pipe temperature is raised and continues operation for 20 seconds without changing, then the speed is reduced again by 4 rps.
 (3) If the discharge pipe temperature is in the range of 95~105 °C even when the inverter command speed is maintained for 3 minutes when the temperature is in the range of 95~105 °C, the speed is raised by 1 rps and kept at that speed for 3 minutes. This process is repeated until the command speed is reached.

(4) Lower Limit Speed

	Cooling	Heating
Lower Limit Speed	25 rps	32 rps

2) If the temperature of 115°C is detected by the sensor on the discharge pipe, then the compressor will stop immediately. When the discharge pipe temperature drops and the time delay of 3 minutes is over, the unit starts again within 1 hour but there is no start at the third time.

(9) Current safe

(a) Purpose: Current is controlled not to exceed the upper limit of the setting operation current.

(b) Detail of operation: Input current to the converter is monitored with the current sensor fixed on the printed circuit board of the outdoor unit and, if the operation current value reaches the limiting current value, the inverter command speed is reduced.

If the mechanism is actuated when the inverter command speed is less than 30 rps, the compressor is stopped immediately. Operation starts again after a delay time of 3 minutes.

(10) Current cut

(a) Purpose: Inverter is protected from overcurrent.

(b) Detail of operation: Output current from the inverter is monitored with a shunt resistor and, if the current exceeds the setting value, the compressor is stopped immediately. Operation starts again after a delay time of 3 minutes.

(11) Outdoor unit failure

This is a function for determining when there is trouble with the outdoor unit during air conditioning.

The compressor is stopped if any one of the following in item 1), 2) is satisfied. Once the unit is stopped by this function, it is not restarted.

- 1) When the input current is measured at 1 A or less for 3 continuous minutes or more.
- 2) If the outdoor unit sends a 0 rps signal to the indoor unit 3 times or more within 20 minutes of the power being turned on.

(12) Indoor fan motor protection

When the air conditioner is operating and the indoor fan motor is turned ON, if the indoor fan motor has operated at 300 rpm or under for more than 30 seconds, the unit enters first in the stop mode and then stops the entire system.

(13) Serial signal transmission error protection

- (a) Purpose:** Prevents malfunction resulting from error on the indoor ↔ outdoor signals.
- (b) Detail of operation:** If the compressor is operating and a serial signal cannot be received from the indoor control with outdoor control having serial signals continues for 7 minute and 35 seconds, the compressor is stopped. After the compressor has been stopped, it will be restarted after the compressor start delay if a serial signal can be received again from the indoor control.

(14) Rotor lock

If the motor for the compressor does not turn after it has been started, it is determined that a compressor lock has occurred and the compressor is stopped.

(15) Outdoor fan motor protection

If the outdoor fan motor has operated at 75 rpm or under for more than 30 seconds, the inverter and fan motor are stopped.

(16) Outdoor fan control at low outdoor temperature

◆ **Cooling**

- (a) Operating conditions:** When the outdoor air temperature (Th5) is 22°C or lower continues for 30 seconds while the inverter command speed is other than 0 rps.
- (b) Detail of operation:** After the outdoor fan operates at A speed for 60 seconds; the corresponding outdoor heat exchanger temperature shall implement the following controls.

● Value of A

	Outdoor fan
Outdoor temperature > 10°C	2nd speed
Outdoor temperature ≤ 10°C	1st speed

- ① Outdoor heat exchanger temperature $\leq 21^{\circ}\text{C}$
After the outdoor fan speed drops (down) to 1 speed for 60 seconds; if the outdoor heat exchanger temperature is lower than 21°C, gradually reduce the outdoor fan speed by 1 speed. (Lower limit 1st speed)
- ② $21^{\circ}\text{C} < \text{Outdoor heat exchanger temperature} \leq 38^{\circ}\text{C}$
After the outdoor fan speed maintains at A speed for 20 seconds; if the outdoor heat exchanger temperature is 21°C~38°C, maintain outdoor fan speed.
- ③ Outdoor heat exchanger temperature $> 38^{\circ}\text{C}$
After the outdoor fan speed rises (up) to 1 speed for 60 seconds; if the outdoor heat exchanger temperature is higher than 38°C, gradually increase outdoor fan speed by 1 speed. (Upper limit 3rd speed)
- (c) Reset conditions:** When either of the following conditions is satisfied
 - ① The outdoor air temperature (Th5) is 25°C or higher.
 - ② The inverter command speed is 0 rps.

◆ **Heating**

- (a) Operating conditions:** When the outdoor air temperature (Th5) is 4°C or lower continues for 30 seconds while the inverter command speed is other than 0 rps.
- (b) Detail of operation:** The outdoor fan is stepped up by 2 speed step at each 20 seconds. (Upper limit 8th speed)
- (c) Reset conditions:** When either of the following conditions is satisfied
 - ① The outdoor air temperature (Th5) is 6°C or higher.
 - ② The inverter command speed is 0 rps.

5 APPLICATION DATA

SAFETY PRECAUTIONS

- Please read these "Safety Precautions" first then accurately execute the installation work.
- For installing qualified personnel, take precautions in respect to themselves by using suitable protective clothing, groves, etc., and then perform the installation works.
- Though the precautionary points indicated herein are divided under two headings, **⚠WARNING** and **⚠CAUTION**, those points which are related to the strong possibility of an installation done in error resulting in death, serious injury or environmental pollution are listed in the **⚠WARNING** section. However, there is also a possibility of serious consequences in relationship to the points listed in the **⚠CAUTION** section as well. In either case, important safety related information is indicated, so by all means, properly observe all that is mentioned.
- Please pay attention not to fall down the tools, etc. when installing the unit at the high position.
- After completing the installation, along with confirming that no abnormalities were seen from the operation tests. Please explain operating methods as well as maintenance methods to the user (customer) of this equipment, based on the user's manual. Moreover, ask the customer to keep this sheet together with the user's manual.
- If unusual noise can be heard during operation, consult the dealer.



WARNING



- To disconnect the appliance from the mains supply this appliance must be connected to the mains by means of a circuit breaker or a switch (use a recognized 16A) with a contact separation of at least 3mm.
- The appliance shall be installed in accordance with national wiring regulations.
- When a plug is connected to the power cord, a plug conforming to the IEC60884-1 standard must be used.
- This system should be applied to places as households, residences and the like. Application to inferior environment such as engineering shop could cause equipment malfunction.
- Please entrust installation to either the company which sold you the equipment or to a professional contractor. Defects from improper installations can be the cause of water leakage, electric shocks and fires.
- Execute the installation accurately, based on following the installation manual. Again, improper installations can result in water leakage, electric shocks and fires.
- For installation, confirm that the installation site can sufficiently support heavy weight. When strength is insufficient, injury can result from a falling of the unit.
- For electrical work, please see that a licensed electrician executes the work while following the safety standards related to electrical equipment, and local regulations as well as the installation instructions, and that only exclusive use circuits are used. Insufficient power source circuit capacity and defective installment execution can be the cause of electric shocks and fires.
- Accurately connect wiring using the proper cable, and insure that the external force of the cable is not conducted to the terminal connection part, through properly securing it. Improper connection or securing can result in heat generation or fire.
- Take care that wiring does not rise upward, and accurately install the lid/service panel. It's improper installation can also result in heat generation or fire.
- Always use accessory parts and authorized parts for installation construction. Using parts not authorized by this company can result in water leakage, electric shock, fire and refrigerant leakage.
- Ventilate the work area when refrigerant leaks during the operation. Coming in contact with fire, refrigerant could generate toxic gas.
- Confirm after the foundation construction work that refrigerant does not leak. If coming in contact with fire of a fan heater, a stove or a movable cooking stove, etc., refrigerant leaking in the room could generate toxic gas.
- Turn off the power source during working on the inside of the unit such as servicing or installing work. This may cause electric shock.
- Use only pipe, flare nut and tools that have been designed to operate with R410A. Using existing parts (R22) may cause the unit failure, even as due to serious accident such as explosion of the cooling cycle or injury etc.
- For pump down work, stop the compressor before removing the refrigerant pipe. If the refrigerant pipe is removed when the compressor is in operation with the service valves open (liquid side and gas side), air would be mixed in the refrigerant circuit and this may cause explosion and injuries due to abnormal high pressure in the cooling cycle.
- Connect the pipes for refrigerant circuit securely in installation work before compressor is operated. If the compressor is operated when the service valve is open without connecting the pipe, this may cause frostbite and injuries due to refrigerant leakage rapidly. Also, the unit is absorbed the air etc., this may cause explosion and injuries due to abnormal high pressure in the cooling cycle.
- Tighten the flare nut by torque wrench with specified method. If the flare nut were tightened with excess torque, this may cause burst and refrigerant leakage after a long period, and then, this may cause generate the harmful substance due to touch the flammable materials.
- Make sure there is no dust or clogging on both plug and socket nor loose connection of the socket before plugging of the power plug. Then, the power plug must be inserted tightly. Accumulation of dust, clogging on the socket or plug, or loose installation of the socket may cause electric shock and fire. Replace the socket if it is loose.
- Do not open the service valves (liquid side and gas side) until refrigerant piping construction, air-tightness test and evacuation are completed. This may cause frostbite and injuries due to refrigerant leakage rapidly. Also, if the refrigerant gas leakage occurs during installing work, stop the work such as brazing work and then ventilation of the room. This may cause generate the toxic gas due to touch the flammable materia.



WARNING



- Do not put the drain pipe directly into the ditch where toxic gas such as sulfur is generated. Toxic gas would flow into the room. Also, this may cause corrosion of indoor unit, and malfunction or refrigerant leakage.
- Be sure to bring back the packing material, form polystyrene, band and vinyl back etc., of the indoor and/or outdoor units after complete the installation work, and then implement appropriate measures such as breaking them.
- When setting up or moving the location of the air conditioner, do not mix air etc. or anything other than the designated refrigerant (R410A) within the refrigeration cycle.
Rupture and injury caused by abnormal high pressure can result from such mixing.
- Do not processing, splice the power cord, or share a socket with other power plugs.
This may cause fire or electric shock due to defecting contact, defecting insulation and over-current etc.
- Do not bundling, winding or processing for the power cord. Or, do not deforming the power plug due to tread it.
This may cause fire or heating.



- Execute proper grounding. Do not connect the ground wire to a gas pipe, water pipe, lightning rod or a telephone ground wire. Improper placement of ground wires can result in electric shock.



CAUTION



- Please avoid installing this unit in the locations where oil splashes and moisture are abundant (e.g., kitchens, mechanical workshops) or where the outside air is likely to flow in. These locations may cause corrosion and lower performance of the heat exchanger and cause damage to plastic parts.
- Please avoid installing this unit in the locations with corrosive gases (such as sulfurous acid gas), inflammable gases (such as thinner, gasoline) and areas where there are possibilities of gas accumulation or where a volatile inflammable material is handled. These locations can cause corrosion to the heat exchanger and damage to plastic parts. Also, the inflammable gas could cause fire.
- Please avoid installing this unit in the vicinity of equipment generating electromagnetic waves such as hospital equipment or equipment generating high-frequency waves. A failure to observe this instruction may result in controller performance errors due to noise generation.
- Please avoid installing and using this unit in a place where it is subject to sea breezes (coastal area). Installation in such a place may result in the corrosion of exterior panels and the heat exchanger.
- Do not place the remote control at locations that receives direct sunlight. This may cause malfunction and deformation.
- Spatters from welding, etc., if hit the unit, can damage (pinhole) its drain pan and other components and cause a water leak. Care must be taken in performing a welding operation near this unit and take necessary precautions to prevent spatters from entering this unit.
- For installation work, be careful not to get injured with the heat exchanger, piping flare portion or screws etc.
- For the drain pipe, follow the installation manual to insure that it allows proper drainage and thermally insulate it to prevent condensation. Inadequate plumbing can result in water leakage and water damage to interior items.
- The installation of an earth leakage breaker is necessary depending on the established location of the unit. Not installing an earth leakage breaker may result in electric shock.
- When perform the air conditioner operation (cooling or drying operation) in which ventilator is installed in the room. In this case, using the air conditioner in parallel with the ventilator, there is the possibility that drain water may backflow in accordance with the room lapse into the negative pressure status. Therefore, set up the opening port such as incorporate the air into the room that may appropriate to ventilation (For example; Open the door a little). In addition, just as above, so set up the opening port if the room lapse into negative pressure status due to register of the wind for the high rise apartment etc.
- Secure the regulated space for inspection and maintenance.
When it is not possible to keep enough space, this may cause injury due to falling from the installation place.
- To prevent the falling, institute the everlasting ladder and handrail etc., to the aisle when installing the outdoor unit in the location with rooftop or altitude.
Or, for surrounding of the outdoor unit, institute the fence and handrail etc., to the aisle to prevent the falling.
- Performing the heat insulation and condensation of the refrigerant piping.
If the heat insulation and condensation of the refrigerant piping is not correctly, this may cause the water leakage, dew dropping and household wetting etc.
- Be careful not to injury due to damage of the unit installing work when leaving of the packaging materials.



- Do not install the unit where there is a concern about leakage of combustible gas.
The rare event of leaked gas collecting around the unit could result in an outbreak of fire.
- Do not touch the suction or aluminum fin on the outdoor unit.
This may cause injury.
- Do not install the outdoor unit where is likely to be a nest for small animals.
Small animals may come into the electronic components and may cause breakdown and fire. Also, instruct the user to keep the surroundings clean.
- Do not install the outdoor unit at the place where fan airflow falls on the garden tree etc.
This may cause damage to the garden tree etc., due to the fan airflow.
- Do not put anything on the outdoor unit and operating the unit.
This may cause damage the objects or injury due to falling to the object.

5.1 Selection of location for installation

(1) Indoor unit

- Where there is no obstructions to the air flow and where the cooled and heated air can be evenly distributed.
- A solid place where the unit or the wall will not vibrate.
- A place where there will be enough space for servicing.
(Where space mentioned right can be secured)
- Where wiring and the piping work will be easy to conduct.
- The place where receiving part is not exposed to the direct rays of the sun or the strong rays of the street lighting.
- A place where it can be easily drained.
- A place separated at least 1m away from the television or the radio.
(To prevent interference to images and sound.)
- Places where this unit is not affected by the high frequency equipment or electric equipment.
- Avoid installing this unit in place where there is much oil mist.
- Places where there is no electric equipment or household under the installing unit.

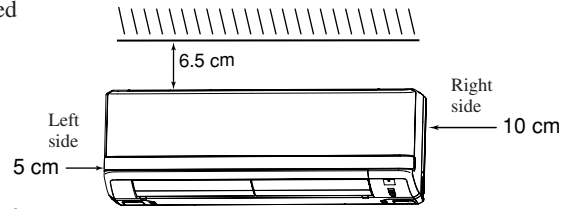

(2) Wireless remote control

- A place where the air conditioner can be received the signal surely during operating the wireless remote control.
- Places where there is no affected by the TV and radio etc.
- Do not place where exposed to direct sunlight or near heat devices such as a stove.

(3) Outdoor unit

- Where air is not trapped.
- Where the installation fittings can be firmly installed.
- Where wind does not hinder the intake and outlet pipes.
- Out of the heat range of other heat sources.
- A place where stringent regulation of electric noises is applicable.
- Where it is safe for the drain water to be discharged.
- Where noise and hot air will not bother neighboring residents.
- Where snow will not accumulate.
- Where strong winds will not blow against the outlet pipe.
- A place where no TV set or radio receiver is placed within 5m.
(If electrical interference is caused, seek a place less likely to cause the problem)
- If a operation is conducted when the outdoor air temperature is -5°C lower, the outdoor unit should be installed at a place where it is not influenced by natural wind.
- Where it is likely that the unit is subjected to strong winds, provide wind guards according to the following guidelines.
Strong winds can cause performance degradation, an accidental stop due to a rise of high pressure and a broken fan.

1) Place the unit outlet pipe perpendicular to the wind direction.

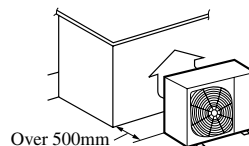

2) Install so the direction of the air from the blowing outlet will be perpendicular to the direction of the wind.

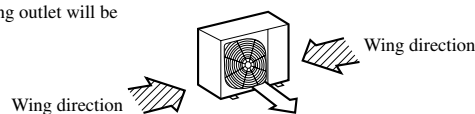

(m) Installation space

- 1) Walls surrounding the unit in the four sides are not acceptable.
- 2) There must be a 1-meter or larger space in the above.
- 3) When more than one unit are installed side by side, provide a 250mm or wider interval between them as a service space. In order to facilitate servicing of controllers, please provide a sufficient space between units so that their top plates can be removed easily.
- 4) Where a danger of short-circuiting exists, install guide louvers.
- 5) When more than one unit are installed, provide sufficient intake space consciously so that short-circuiting may not occur.
- 6) Where piling snow can bury the outdoor unit, provide proper snow guards.

		(mm)			
Size	Example installation	I	II	III	IV
L1		Open	280	280	180
L2		100	75	Open	Open
L3		100	80	80	80
L4		250	Open	250	Open

The height of a wall is 1200mm or less.

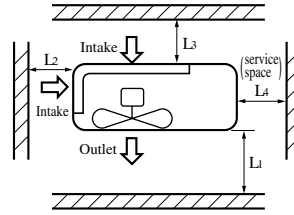

(4) Limitations for one way piping length and vertical height difference.

		Model	All models
Item			
One way piping length (ℓ)			30 m
Vertical height difference (h)	Outdoor unit is lower		20 m
	Outdoor unit is higher		20 m

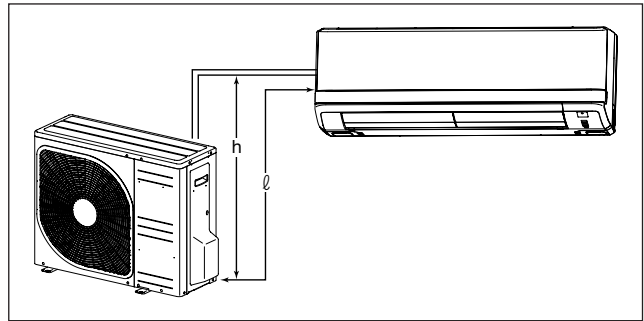

5.2 Installation of indoor unit

(1) Installation of installation board

(a) Fixing of installation board

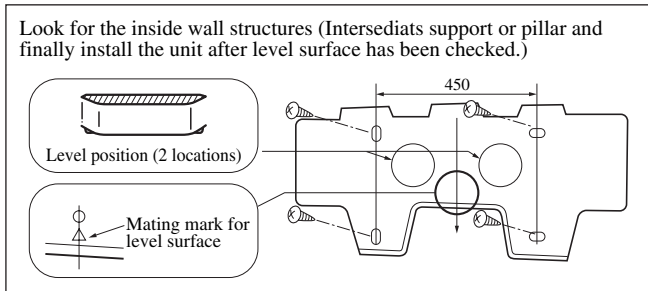

Adjustment of the installation board in the horizontal direction is to be conducted with four screws in a temporary tightened state.

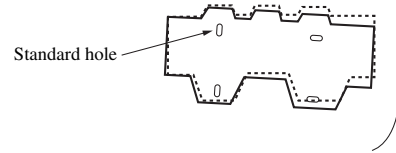

Adjust so the board will be level by turning the board with the standard hole as the center.

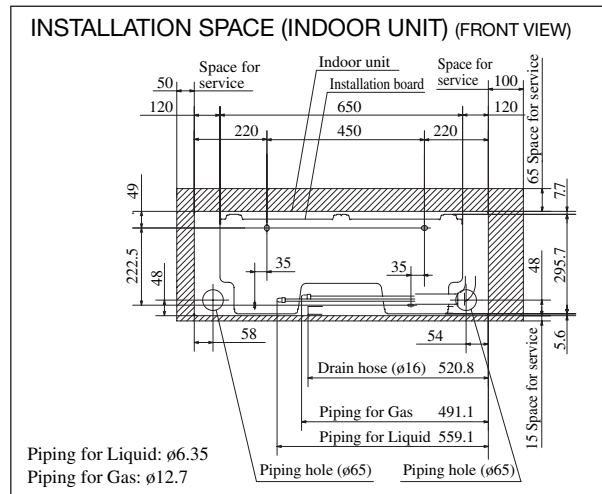
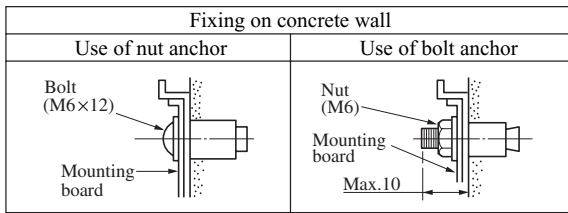

(2) Drilling of holes and fixture sleeve (Option Parts)

When drilling the wall that contains a metal lath, wire lath or metal plate, be sure to use pipe hole sleeve sold separately.

(a) Drill a hole with ø65 whole core drill

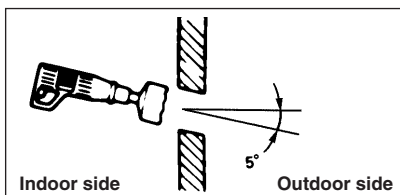

Note (1) Drill a hole with incline of 5 degree from indoor side to outdoor side.

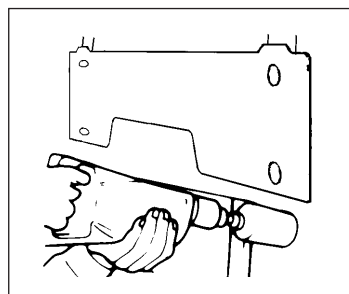

(b) Adjusting sleeve length

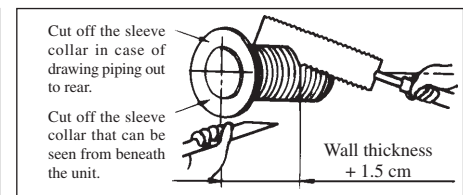

(c) Install the sleeve

(Inserting sleeve)

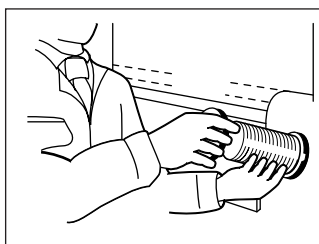

(*Sleeve + *Inclined + *Sealing plate)

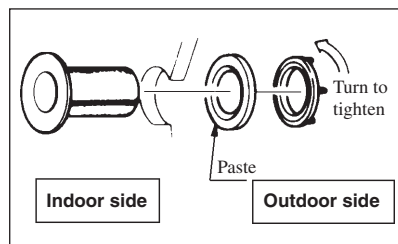

View of sleeve when installed

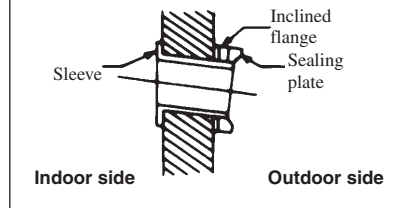

(3) Preparation of indoor unit

(a) Mounting of connecting wires

- 1) Open the air inlet panel.
- 2) Remove the service panel.
- 3) Remove the wiring clamp.
- 4) Connect the connecting wire securely to the terminal block.

Use cables for interconnection wiring to avoid loosening of the wires.

CENELEC code for cables. Required field cables.
H05RNR4G1.5 (Example) or 245IEC57

- H Harmonized cable type
- 05 300/500 volts
- R Natural-and/or synth, rubber wire insulation
- N Polychloroprene rubber conductors insulation
- R Standed core
- 4or5 Number of conductors
- G One conductor of the cable is the earth conductor (yellow/green)
- 1.5 Section of copper wire (mm²)

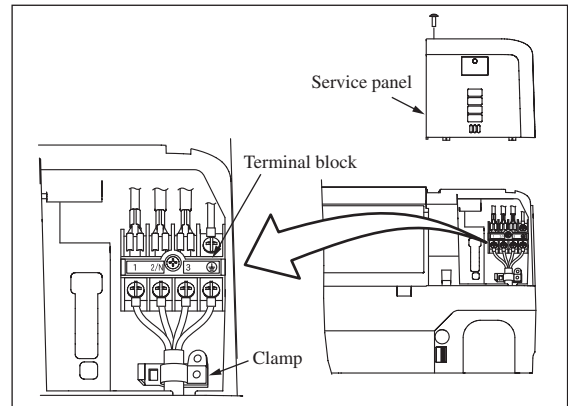

- ① Connect the connection wire securely to the terminal block. If the wire is not affixed completely, contact will be poor, and it is dangerous as the terminal block may heat up and catch fire.
- ② Take care not to confuse the terminal numbers for indoor and outdoor connections.
- ③ Affix the connection wire using the wiring clamp.
- 5) Fix the connecting wire by wiring clamp.
- 6) Attach the service panel.
- 7) Close the air inlet panel.

(b) Installing the support of piping

[Shaping the piping]

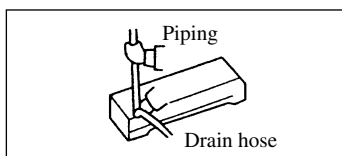

- Hold the bottom of the piping and fix direction before stretching it and shaping it.

[Taping of the exterior]

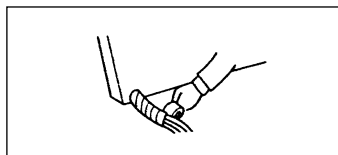

- Tape only the portion that goes through the wall. Always tape the crossover wiring with the piping.

[Matters of special notice when piping from left or center/rear of the unit.]

[Top View]

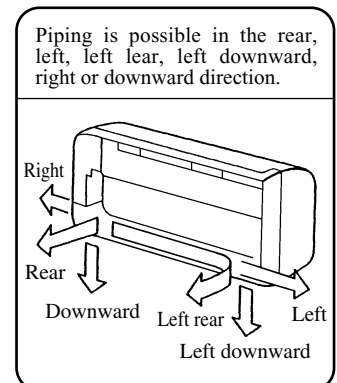
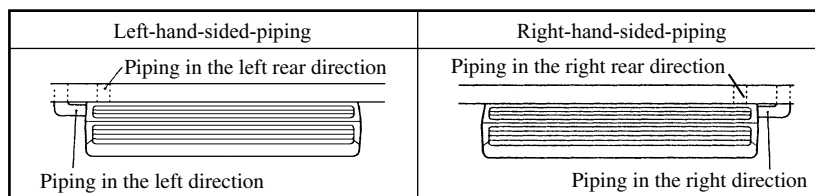

[Drain hose changing procedures]

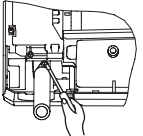
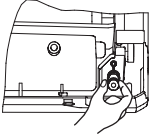
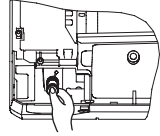
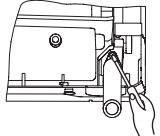
1. Remove the drain hose.	2. Remove the drain cap.	3. Insert the drain cap.	4. Connect the drain hose.
			

- Remove the screw and drain hose, making it rotate.
- Remove it with hand or pliers.
- Insert the drain cap which was removed at procedure "2" securely using a hexagonal wrench etc.
Note: Be careful that if it is not inserted securely, water leakage may occur.
- Inserted the drain hose securely, making rotate. And install the screw.
Note: Be careful that if it is not inserted securely, water leakage may occur.

Since this air conditioner has been designed to collect dew drops on the rear surface to the drain pan, do not attach the power cord above the gutter.

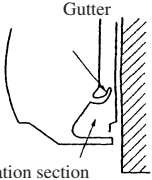

Pipe accommodation section

Drainage

- Arrange the drain hose in a downward angle.
- Avoid the following drain piping.

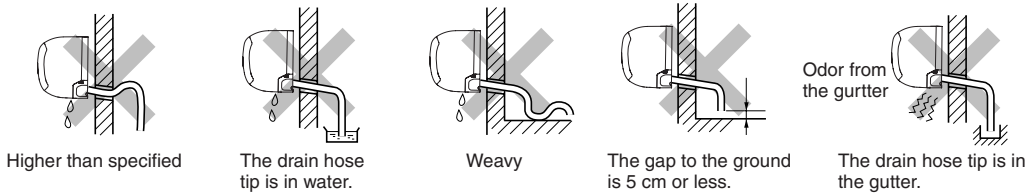

- Pour water to the drain pan located under the heat exchanger, and ensure that the water is discharged outdoor.
- When the extended drain hose is indoor, always use a shield pipe (to be arranged by the user) and ensure it is thermally insulated.

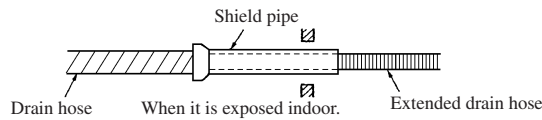

(c) Fixing of indoor unit

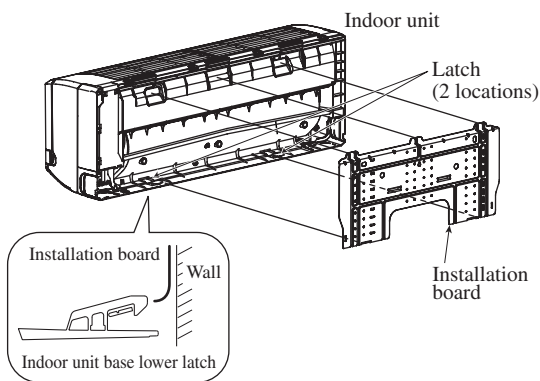

Installation Steps

① Pass the pipe through the hole in the wall, and hook the upper part of the indoor unit to the installation board.

② Gently push the lower part to secure the unit.

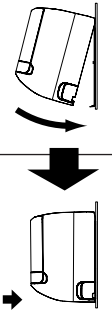

- How to remove the indoor unit from the installation board
 - ① Push up at the marked portion of the indoor unit base lower latch, and slightly pull it toward you. (both right and left hand sides)
(The indoor unit base lower latch can be removed from the installation board)
 - ② Push up the indoor unit upward. So the indoor unit will be removed from the installation board.

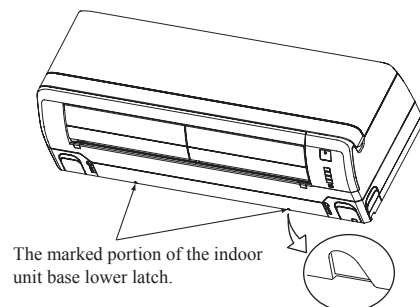

5.3 Installation of outdoor unit

(1) Installation of outdoor unit

- Make sure that the unit is stable in installation. Fix the unit to stable base.
- When installing the unit at a higher place or where it could be toppled by strong winds, secure the unit firmly with foundation bolts, wire, etc.
- Perform wiring, making wire terminal numbers conform to terminal numbers of indoor unit terminal block.
- Connect using ground screw located near \oplus mark.
- In areas where the temperatures drop below 0°C for several continuous days, do not install a drain elbow.
(Water discharge could stop due to freezing.)

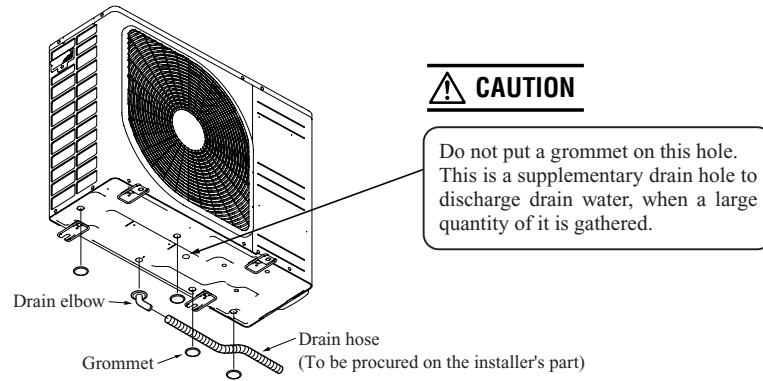

5.4 Connection of refrigerant pipings

(1) Preparation

Keep the openings of the pipes covered with tapes etc. to prevent dust, sand, etc. from entering them.

(a) Indoor unit side

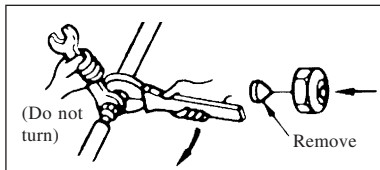

- Remove the flared nuts.
(on both liquid and gas sides)

(b) Outdoor unit side

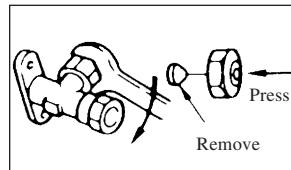

- Remove the flared nuts.
(on both liquid and gas sides)

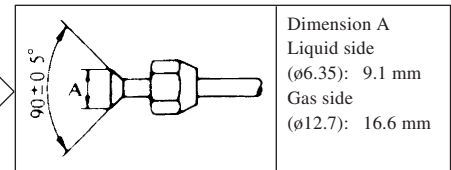

- Install the removed flared nuts to the pipes to be connected, then flare the pipes.

Dimension A
Liquid side
($\phi 6.35$): 9.1 mm
Gas side
($\phi 12.7$): 16.6 mm

(2) Connection of refrigerant piping

(a) Indoor unit side

- Connect firmly gas and liquid side pipings by Torque wrench.

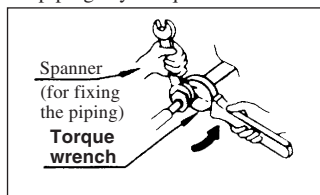

- Specified torquing value:
Liquid side ($\phi 6.35$) : 14~18N·m (1.4~1.8kgf·m)
Gas side ($\phi 12.7$) : 49~61N·m (4.9~6.1kgf·m)

- Always use a Torque wrench and back up spanner to tighten the flare nut.

(b) Outdoor unit side

- Connect firmly gas and liquid side pipings by Torque wrench.

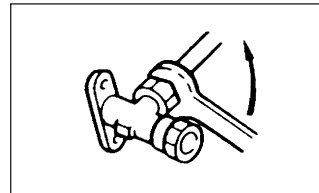

- Specified torquing value:
Liquid side ($\phi 6.35$) : 14~18N·m (1.4~1.8kgf·m)
Gas side ($\phi 12.7$) : 49~61N·m (4.9~6.1kgf·m)

- Use one more spanner to fix the valve.

(3) Air purge

- Tighten all flare nuts in the pipings both indoor and outside will so as not to cause leak.
- Connect service valve, charge hose, manifold valve and vacuum pump as is illustrated below.
- Open manifold valve handle Lo to its full width, and perform vacuum or evacuation.
Continue the vacuum or evacuation operation for 15 minutes or more and check to see that the vacuum gauge reads -0.1 MPa (-76 cmHg).
- After completing vacuum operation, fully open service valve (Both gas and liquid sides) with hexagon headed wrench.
- Detach the charge hoses.
- Check for possible leakage of gas in the connection parts of both indoor and outdoor.

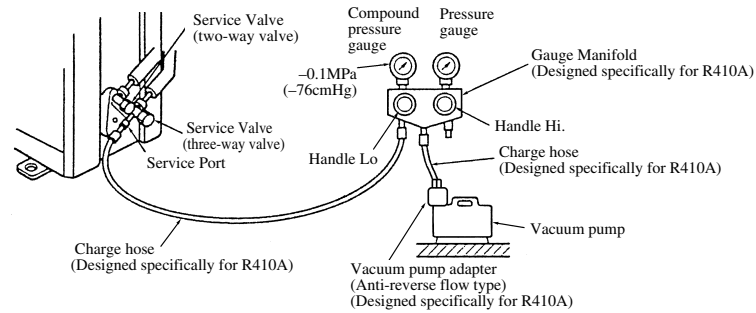

- Since the system uses service ports differing in diameter from those found on the conventional models, a charge hose (for R22) presently in use is not applicable.
Please use one designed specifically for R410A
- Please use an anti-reverse flow type vacuum pump adapter so as to prevent vacuum pump oil from running back into the system.
Oil running back into an air-conditioning system may cause the refrigerant cycle to break down.

Additional refrigerant charge

When refrigerant piping exceeds 15m conduct additional refrigerant charge by weight after refrigerant piping completion.
Additional charge amount per meter = 20 g/m

[Example]

How much amount of additional charge for 25m piping?

$$(25 - 15) \text{ m} \times 20 \text{ g/m} = 200 \text{ g} \quad \boxed{200 \text{ g for additional charge}}$$

(4) Insulation of connecting portion

- Cover the indoor unit's flare-connected joints, after they are checked for a gas leak, with an indoor unit heat insulating material and then wrap them with a tape with an attached insulation pad placed over the heat insulating material's slit area.

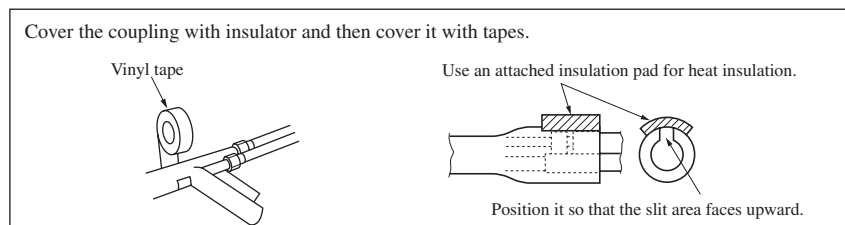

- Finishing and fixing

- Tie up the piping with wrapping tape, and shape it so that it conforms to which the pipe is attached.
- Fix them with clamps as right figure.

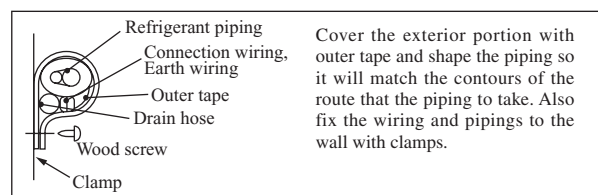

Cover the exterior portion with outer tape and shape the piping so it will match the contours of the route that the piping to take. Also fix the wiring and pipings to the wall with clamps.

5.5 Test run

- (1) Conduct trial run after confirming that there is no gas leaks.
- (2) When conducting trial run set the remote control thermostat to continuous operation position. However when the power source is cut off or when the unit's operation switch is turned off or was turned to fan operation position, the unit will not go into operation in order to protect the compressor.
- (3) Explain to the customer on the correct usage of the air conditioner in simple layman's terms.
- (4) Make sure that drain flows properly.
- (5) **Standard operation data** (220/230/240V)

Item	Model	SRK50ZHX-S	SRK60ZHX-S
	High pressure (MPa)	Cooling	–
Heating		2.3~2.4	2.5~2.6
Low pressure (MPa)	Cooling	0.8~0.9	0.7~0.8
	Heating	–	–
Temp. difference between return air and supply air (°C)	Cooling	13~14	14~15
	Heating	18~19	21~22
Running current (A)	Cooling	6.0/5.7/5.5	8.5/8.2/7.8
	Heating	6.2/5.9/5.7	7.7/7.3/7.0

Note (1) The data are measured at following conditions

Ambient air temperature

Indoor side: Cooling ... 27°C DB, 19°C WB, Heating ... 20°C DB

Outdoor side: Cooling ... 35°C DB, 24°C WB, Heating ... 7°C DB, 6°C WB

5.6 Precautions for wireless remote control installation and operation

- (1) **Wireless remote control covers the following distances:**
 - (a) **When operating facing the air conditioner:**

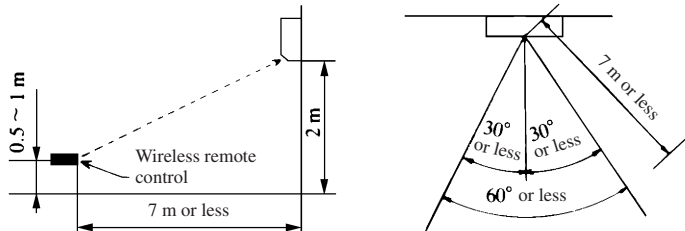

If the distances exceed the area indicated above, be sure to check the receiver status.

- (b) **When manipulating the remote control mounted on a wall:**

Make sure that it works normally (i.e., transmission/reception signal is audible) before mounting.

- Notes (1) The remote control is correctly facing the sensing element of the air conditioner when being manipulated.
- (2) The typical coverage is indicated (in the left illustration). It may be more or less depending on the installation.
- (3) The coverage may be less or even nil. If the sensing element is exposed to strong light, such as direct sunlight, illumination, etc., or dust is deposited on it or it is used behind a curtain, etc.

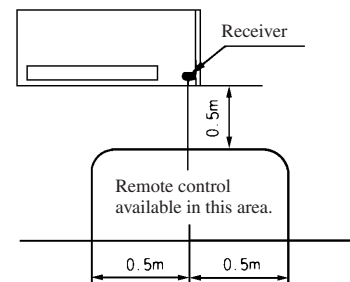

6 MAINTENANCE DATA

6.1 Troubleshooting procedures for electrical equipment

(1) Cautions

- ① If you are disassembling and checking an air conditioner, be sure to turn off the power before beginning. When working on indoor units, let the unit sit for about 1 minute after turning off the power before you begin work. When working on an outdoor unit, there may be an electrical charge applied to the main circuit (electrolytic condenser), so begin work only after discharging this electrical charge (to DC 10 V or lower).
- ② When taking out printed circuit boards, be sure to do so without exerting force on the circuit boards or package components.
- ③ When disconnecting and connecting connectors, take hold of the connector housing and do not pull on the lead wires.

(2) Items to check before troubleshooting

- ① Have you thoroughly investigated the details of the trouble which the customer is complaining about?
- ② Is the air conditioner running? Is it displaying any self-diagnosis information?
- ③ Is a power supply with the correct voltage connected?
- ④ Are the control lines connecting the indoor and outdoor units wired correctly and connected securely?
- ⑤ Is the outdoor unit's refrigerant service valve open?

(3) Troubleshooting procedure (If the air conditioner does not run at all)

If the air conditioner does not run at all, diagnose the trouble using the following troubleshooting procedure. If the air conditioner is running but breaks down, proceed to troubleshooting step (4).

Important When all the following conditions are met, we say that the air conditioner will not run at all.

- ① The RUN light does not light up.
- ② The flaps do not open.
- ③ The indoor unit fan motors do not run.
- ④ The self-diagnosis display does not function.

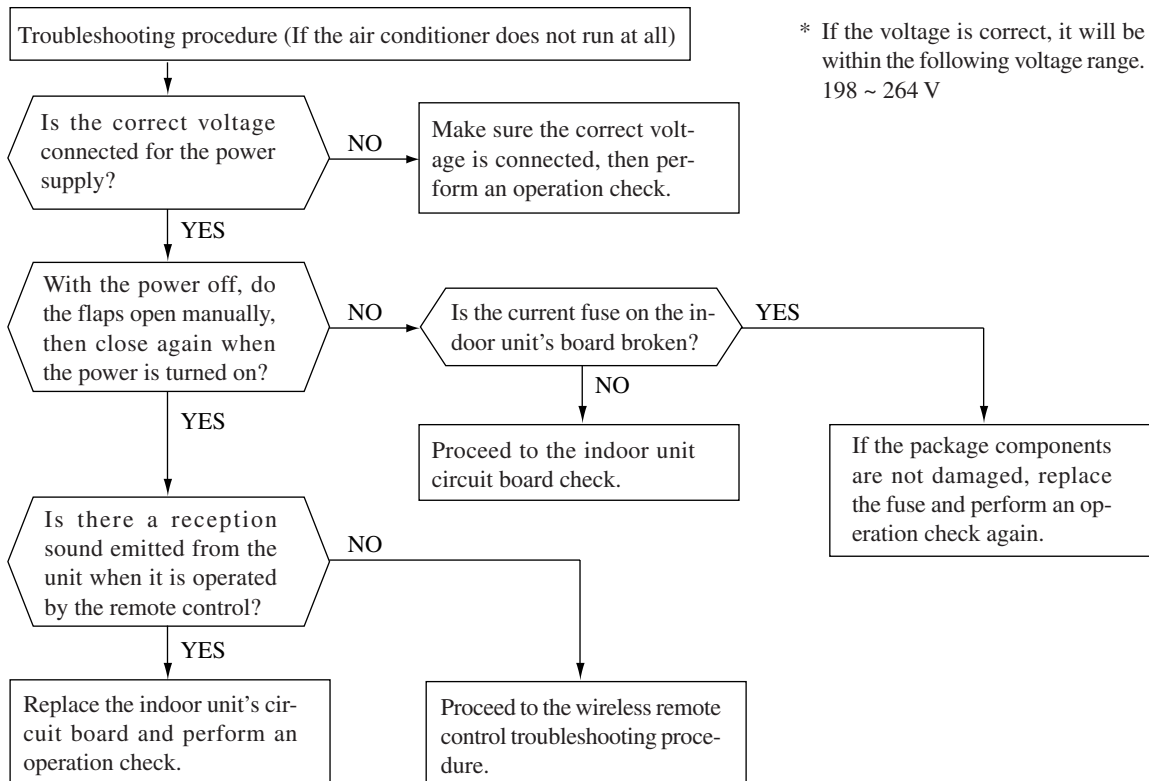

(4) Troubleshooting procedure (If the air conditioner runs)

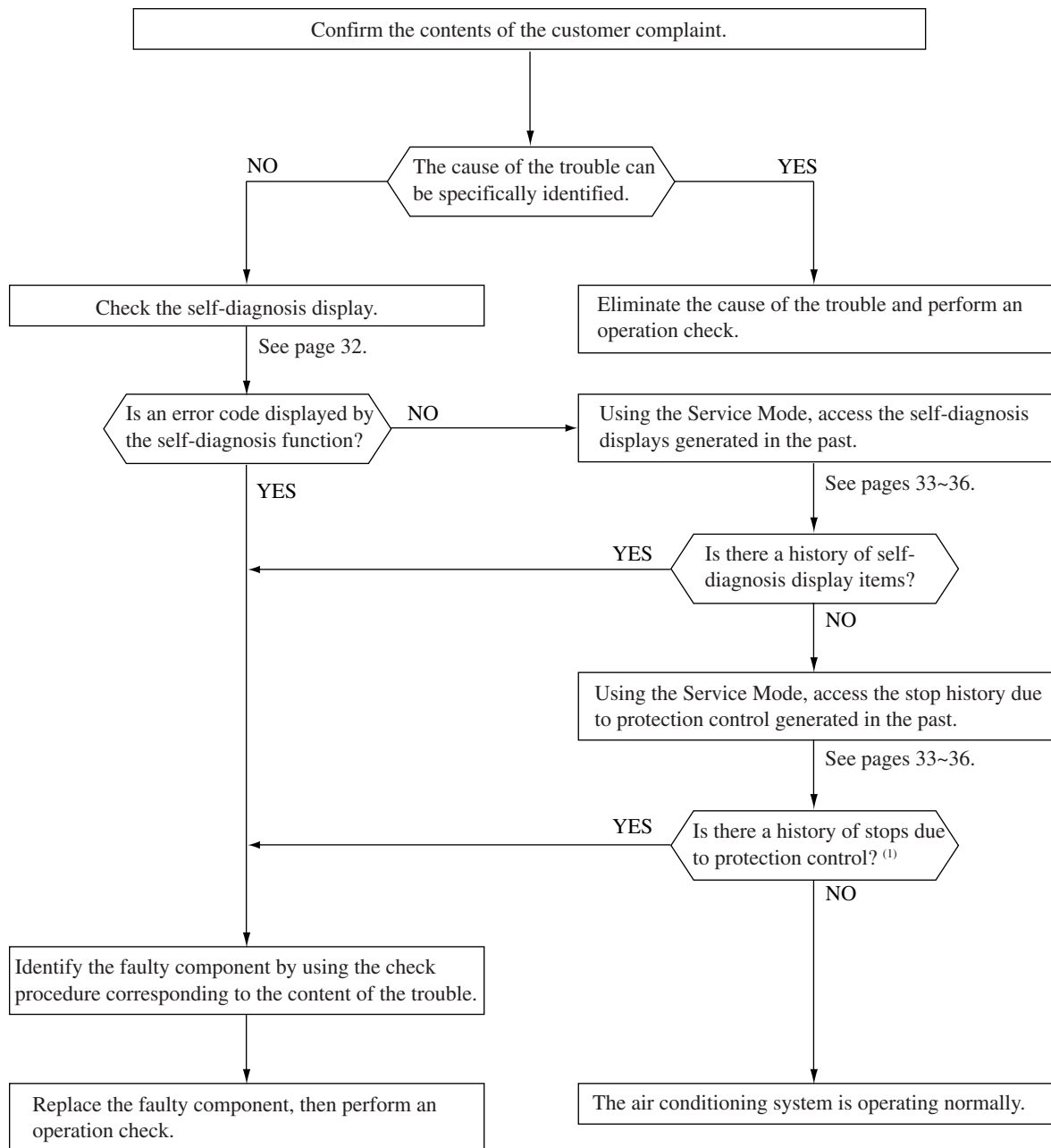

Note (1) Even in cases where only intermittent stop data are generated, the air conditioning system is normal. However, if the same protective operation recurs repeatedly (3 or more times), it will lead to customer complaints. Judge the conditions in comparison with the contents of the complaints.

(5) Self-diagnosis table

When this air conditioner performs an emergency stop, the reason why the emergency stop occurred is displayed by the flashing of display lights. If the air conditioner is operated using the remote control 3 minutes or more after the emergency stop, the trouble display stops and the air conditioner resumes operation. ⁽¹⁾

Indoor unit display panel		Outdoor unit LED	Wired remote control display	Description of trouble	Cause	Display (flashing) condition
RUN light	TIMER light					
1 time flash	ON	—	—	Heat exchanger sensor 1 error	• Broken heat exchanger sensor 1 wire, poor connector connection	When a heat exchanger sensor 1 wire disconnection is detected while operation is stopped. (If a temperature of -28°C or lower is detected for 15 seconds, it is judged that the wire is disconnected.) (Not displayed during operation.)
2 time flash	ON	—	—	Room temperature sensor error	• Broken room temperature sensor wire, poor connector connection	When a room temperature sensor wire disconnection is detected while operation is stopped. (If a temperature of -45°C or lower is detected for 15 seconds, it is judged that the wire is disconnected.) (Not displayed during operation.)
3 time flash	ON	—	—	Heat exchanger sensor 3 error	• Broken heat exchanger sensor 3 wire, poor connector connection	When a heat exchanger sensor wire 3 disconnection is detected while operation is stopped. (If a temperature of -28°C or lower is detected for 15 seconds, it is judged that the wire is disconnected.) (Not displayed during operation.)
6 time flash	ON	—	E 16	Indoor fan motor error	• Defective fan motor, poor connector connection	When conditions for turning the indoor unit's fan motor on exist during air conditioner operation, an indoor unit fan motor speed of 300 rpm or lower is measured for 30 seconds or longer. (The air conditioner stops.)
Keeps flashing	1 time flash	8 time flash	E 38	Outdoor air temperature sensor error	• Broken outdoor air temp. sensor wire, poor connector connection	When an outdoor temperature sensor wire disconnection is detected while the power is turned on or after the outdoor unit's speed has continued at 0rps or higher for 2 minutes. (If a temperature of -55°C or lower is detected for 20 seconds, it is judged that wire is disconnected.) (The compressor is stopped.)
Keeps flashing	2 time flash	8 time flash	E 37	Outdoor heat exchanger sensor error	• Broken heat exchanger sensor wire, poor connector connection	When a heat exchanger sensor wire disconnection is detected while the power is turned on or after the outdoor unit's speed has continued at 0rps or higher for 2 minutes. (If a temperature of -55°C or lower is detected for 20 seconds, it is judged that wire is disconnected.) (The compressor is stopped.)
Keeps flashing	4 time flash	8 time flash	E 39	Discharge pipe sensor error	• Broken discharge pipe sensor wire, poor connector connection	When a discharge pipe sensor wire disconnection is detected after the outdoor unit's speed has continued at 0rps or higher for 10 minutes. (If a temperature of -25°C or lower is detected for 20 seconds, it is judged that wire is disconnected.) (The compressor is stopped.)
ON	1 time flash	1 time flash	E 42	Current Cut	• Compressor locking, open phase on compressor output, shortcircuit on power transistor, closed service valve	The inverter output current (compressor motor current) exceeds the set value during compressor start. (The air conditioner stops.)
ON	2 time flash	2 time flash	E 59	Trouble of outdoor unit	• Broken compressor wire • Compressor blockage	When there is an emergency stop caused by trouble in the outdoor unit, or the input current value is found to be lower than the set value. (The air conditioner stops.)
ON	3 time flash	3 time flash	E 58	Current safe stop	• Overload operation • Overcharge • Compressor locking	When the inverter command speed is lower than the set value and the current safe has operated. (the compressor stops)
ON	4 time flash	1 time flash	E 51	Power transistor error	• Broken power transistor	When the power transistor is judged breakdown while compressor starts. (The compressor is stopped.)
ON	5 time flash	5 time flash	E 36	Over heat of compressor	• Gas shortage, defective discharge pipe sensor, closed service valve	When the value of the discharge pipe sensor exceeds the set value. (The air conditioner stops.)
ON	6 time flash	6 time flash	E 3 E 5	Error of signal transmission	• Defective power supply, • Broken signal wire, defective in/outdoor unit boards	When there is no signal between the indoor unit's board and outdoor unit's board for 10 seconds or longer (when the power is turned on), or when there is no signal for 7 minute 35 seconds or longer (during operation)(the compressor is stopped).
ON	7 time flash	ON	E 48	Outdoor fan motor error	• Defective fan motor, poor connector connection	When the outdoor unit's fan motor speed continues for 30 seconds or longer at 75 rpm or lower. (3 times) (The air conditioner stops.)
ON	Keeps flashing	2 time flash	E 35	Cooling high pressure protecton	• Overload operation, overcharge • Broken outdoor heat exchange sensor wire • Closed service valve	When the value of the outdoor heat exchanger sensor exceeds the set value.
2 time flash	2 time flash	7 time flash	E 60	Rotor lock	• Defective compressor • Open phase on compressor • Defective outdoor unit boards	If the compressor motor's magnetic pole positions cannot be correctly detected when the compressor starts. (The air conditioner stops.)
5 time flash	ON	2 time flash	E 47	Active filter voltage error	• Defective active filter	When the wrong voltage connected for the power supply. When the outdoor control PCB is faulty.
—	—	—	E 1	Error of wired remote control wiring	• Broken wired remote control wire, defective indoor unit boards	The wired remote control wire Y is open. The wired remote control wires X and Y are reversely connected. Noise is penetrating the wired remote control lines. The wired remote control or indoor control PCB is faulty. (The communications circuit is faulty.)

Notes (1)The air conditioner cannot be restarted using the remote control for 3 minutes after operation stops.

(2)The wired remote control is optional parts.

(6) Service mode (Trouble mode access function)

This air conditioner is capable of recording error displays and protective stops (service data) which have occurred in the past. If self-diagnosis displays cannot be confirmed, it is possible to get a grasp of the conditions at the time trouble occurred by checking these service data.

(a) Explanation of terms

Term	Explanation
Service mode	The service mode is the mode where service data are displayed by flashing of the display lights when the operations in item (b) below are performed with the indoor controller.
Service data	These are the contents of error displays and protective stops which occurred in the past in the air conditioner system. Error display contents and protective stop data from past anomalous operations of the air conditioner system are saved in the indoor unit controller's non-volatile memory (memory which is not erased when the power goes off). There are two types of data, self-diagnosis data and stop data, described below.
Self-diagnosis data	These are the data which display the reason why a stop occurred when an error display (self-diagnosis display) occurred in an indoor unit. Data are recorded for up to 5 previous occurrences. Data which are older than the 5th previous occurrence are erased. In addition, data on the temperature of each sensor (room temperature, indoor heat exchanger, outdoor heat exchanger, outdoor air temperature, discharge pipe), remote control information (operation switching, fan speed switching) are recorded when trouble occurs, so more detailed information can be checked.
Stop data	These are the data which display the reason by a stop occurred when the air conditioning system performed protective stops, etc. in the past. Even if stop data alone are generated, the system restarts automatically. (After executing the stop mode while the display is normal, the system restarts automatically.) Data for up to 10 previous occasions are stored. Data older than the 10th previous occasion are erased. (Important) In cases where transient stop data only are generated, the air conditioner system may still be normal. However, if the same protective stop occurs frequently (3 or more times), it could lead to customer complaints.

(b) Service mode display procedure

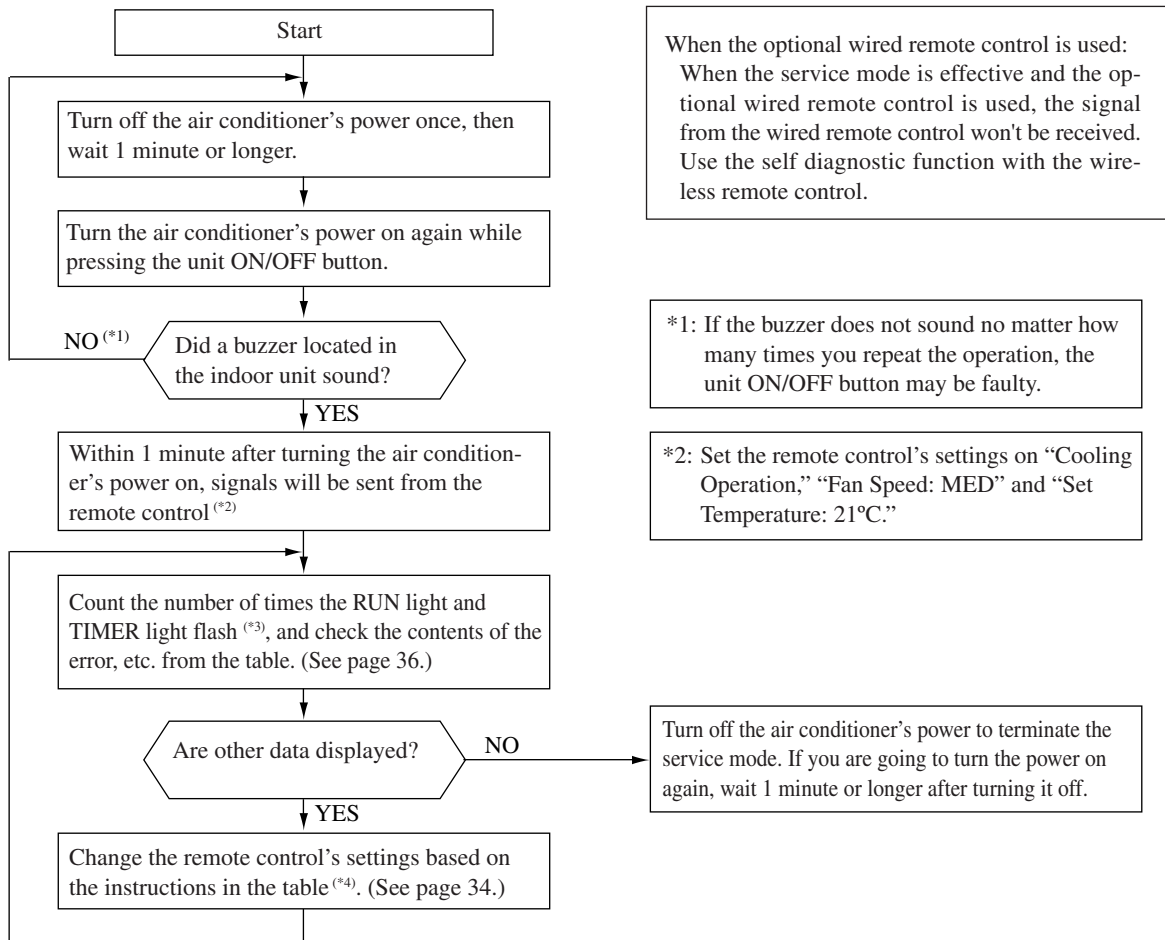

*3: To count the number of flashes in the service mode, count the number of flashes after the light lights up for 1.5 second initially (start signal). (The time that the light lights up for 1.5 second (start signal) is not counted in the number of flashes.)

- In the case of current cut (example: stop code "42")
The RUN light (10's digit) flashes 4 times and the TIMER light (1's digit) flashes 2 times.
 $4 \times 10 + 2 \times 1 = 42 \rightarrow$ From the table, read the instructions for error code 42, "current cut".

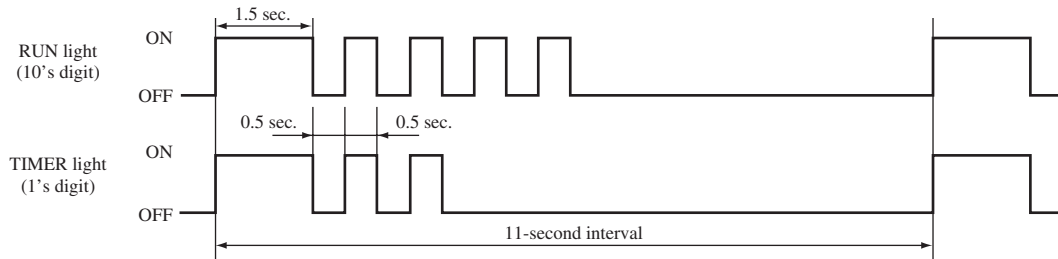

*4: When in the service mode, when the remote control's settings (operation switching, fan speed switching, temperature setting) are set as shown in the following table and sent to the air conditioner unit, the unit switches to display of service data.

① **Self-diagnosis data**

What are Self- These are control data (reasons for stops, temperature at each sensor, remote control information) diagnosis Data? from the time when there were error displays (abnormal stops) in the indoor unit in the past. Data from up to 5 previous occasions are stored in memory. Data older than the 5th previous occasion are erased. The temperature setting indicates how many occasions previous to the present setting the error display data are and the operation switching and fan speed switching data show the type of data.

Remote control setting		Contents of output data
Operation switching	Fan speed switching	
Cooling	MED	Displays the reason for stopping display in the past (error code).
	HI	Displays the room temperature sensor temperature at the time the error code was displayed in the past.
	AUTO	Displays the indoor heat exchanger sensor temperature at the time the error code was displayed in the past.
Heating	LO	Displays the remote control information at the time the error code was displayed in the past.
	MED	Displays the outdoor air temperature sensor temperature at the time the error code was displayed in the past.
	HI	Displays the outdoor heat exchanger sensor temperature at the time the error code was displayed in the past.
	AUTO	Displays the discharge pipe sensor temperature at the time the error code was displayed in the past.

Remote control setting	Indicates the number of occasions previous to the present the error display data are from.
Temperature setting	
21°C	1 time previous (previous time)
22°C	2 times previous
23°C	3 times previous
24°C	4 times previous
25°C	5 times previous

Only for indoor heat exchanger sensor 3

Remote control setting	Indicates the number of occasions previous to the present the error display data are from.
Temperature setting	
26°C	1 time previous (previous time)
27°C	2 times previous
28°C	3 times previous
29°C	4 times previous
30°C	5 times previous

(Example)

Remote control setting			Displayed data
Operation switching	Fan speed switching	Temperature setting	
Cooling	MED	21°C	Displays the reason for the stop (error code) the previous time an error was displayed.
		22°C	Displays the reason for the stop (error code) 2 times previous when an error was displayed.
		23°C	Displays the reason for the stop (error code) 3 times previous when an error was displayed.
		24°C	Displays the reason for the stop (error code) 4 times previous when an error was displayed.
		25°C	Displays the reason for the stop (error code) 5 times previous when an error was displayed.

② Stop data

Remote control setting			Displayed data
Operation switching	Fan speed switching	Temperature setting	
Cooling	LO	21°C	Displays the reason for the stop (stop code) the previous time when the air conditioner was stopped by protective stop control.
		22°C	Displays the reason for the stop (stop code) 2 times previous when the air conditioner was stopped by protective stop control.
		23°C	Displays the reason for the stop (stop code) 3 times previous when the air conditioner was stopped by protective stop control.
		24°C	Displays the reason for the stop (stop code) 4 times previous when the air conditioner was stopped by protective stop control.
		25°C	Displays the reason for the stop (stop code) 5 times previous when the air conditioner was stopped by protective stop control.
		26°C	Displays the reason for the stop (stop code) 6 times previous when the air conditioner was stopped by protective stop control.
		27°C	Displays the reason for the stop (stop code) 7 times previous when the air conditioner was stopped by protective stop control.
		28°C	Displays the reason for the stop (stop code) 8 times previous when the air conditioner was stopped by protective stop control.
		29°C	Displays the reason for the stop (stop code) 9 times previous when the air conditioner was stopped by protective stop control.
		30°C	Displays the reason for the stop (stop code) 10 times previous when the air conditioner was stopped by protective stop control.

(c) **Error code, stop code table** (Assignment of error codes and stop codes is done in common for all models.)

Number of flashes when in service mode		Stop code or Error code	Error content	Cause	Occurrence conditions	Error display	Auto recovery
RUN light (10's digit)	TIMER light (1's digit)						
OFF	OFF	0	Normal	—	—	—	—
	5 time flash	05	Can not receive signals for 35 seconds (if communications have recovered)	Power supply is faulty. Power supply cables and signal lines are improperly wired. Indoor or outdoor unit circuit boards are faulty.	When 35 seconds passes without communications signals from either the outdoor unit or the indoor unit being detected correctly.	○	—
3 time flash	5 time flash	35	Cooling high pressure control	Cooling overload operation. Outdoor unit fan speed drops. Outdoor heat exchanger sensor is short circuit.	When the outdoor heat exchanger sensor's value exceeds the set value.	○ (5 times)	○
	6 time flash	36	Compressor overheat (115°C)	Refrigerant is insufficient. Discharge pipe sensor is faulty. Service valve is closed.	When the discharge pipe sensor's value exceeds the set value.	○ (2 times)	○
	7 time flash	37	Outdoor heat exchanger sensor is abnormal	Outdoor heat exchanger sensor wire is disconnected. Connector connections are poor.	When a temperature of -55°C or lower is sensed continuously for 20 seconds while the power is turned on or after the outdoor unit's speed has continued at 0rps or higher for 2 minutes (the compressor stops).	○ (3 times)	○
	8 time flash	38	Outdoor air temperature sensor is abnormal	Outdoor air temperature sensor wire is disconnected. Connector connections are poor.	When a temperature of -55°C or lower is sensed continuously for 20 seconds while the power is turned on after the outdoor unit's speed has continued at 0rps or higher for 2 minutes (the compressor stops).	○ (3 times)	○
	9 time flash	39	Discharge pipe sensor is abnormal (anomalous stop)	Discharge pipe sensor wire is disconnected. Connector connections are poor.	When a temperature of -25°C or lower is sensed continuously for 20 seconds after the outdoor unit's speed has continued at 0rps or higher for 10 minutes (the compressor stops).	○ (3 times)	○
4 time flash	2 time flash	42	Current cut	Compressor lock. Compressor wiring short circuit. Compressor output is open phase. Outdoor unit's circuit board is faulty. Service valve is closed. Electronic expansion valve is faulty. Compressor is faulty.	Compressor start fails 42 times in succession and the reason for the final failure is current cut.	○ (2 times)	○
	7 time flash	47	Active filter voltage error	Defective active filter.	When the wrong voltage connected for the power supply. When the outdoor control PCB is faulty.	○	—
	8 time flash	48	Outdoor unit's fan motor is abnormal	Outdoor fan motor is faulty. Connector connections are poor. Outdoor unit's circuit board is faulty.	When a fan speed of 75 rpm or lower continues for 30 seconds or longer.	○ (3 times)	○
5 time flash	1 time flash	51	Short circuit in the power transistor (high side) Current cut circuit breakdown	Outdoor unit's circuit board is faulty. Power transistor is damaged.	When it is judged that the power transistor was damaged at the time the compressor started.	○	—
	7 time flash	57	Refrigeration cycle system protective control	Service valve is closed. Refrigerant is insufficient.	When refrigeration cycle system protective control operates.	—	○
	8 time flash	58	Current safe	Refrigerant is overcharge. Compressor lock. Overload operation.	When there is a current safe stop during operation.	—	○
	9 time flash	59	Compressor wiring is unconnection Voltage drop Low speed protective control	Compressor wiring is disconnected. Power transistor is damaged. Power supply construction is defective. Outdoor unit's circuit board is faulty.	When the current is 1A or less at the time the compressor started. When the power supply voltage drops during operation. When the outdoor unit's speed is lower than 26 rps for 60 minutes.	○	○
6 time flash	OFF	60	Rotor lock	Compressor is faulty. Compressor output is open phase. Electronic expansion valve is faulty. Overload operation. Outdoor unit's circuit board is faulty.	After the compressor starts, when the compressor stops due to rotor lock.	○ (2 times)	○
	1 time flash	61	Connection lines between the indoor and outdoor units are faulty	Connection lines are faulty. Indoor or outdoor unit circuit boards are faulty.	When 10 seconds passes after the power is turned on without communications signals from the indoor or outdoor unit being detected correctly.	○	—
	2 time flash	62	Serial transmission error	Indoor or outdoor unit circuit boards are faulty. Noise is causing faulty operation.	When 7 minute 35 seconds passes without communications signals from either the outdoor unit or the indoor unit being detected correctly.	○	—
8 time flash	OFF	80	Indoor unit's fan motor is abnormal	Indoor fan motor is faulty. Connector connections are poor. Indoor unit's circuit board is faulty.	When the indoor unit's fan motor is detected to be running at 300 rpm or lower speed with the fan motor in the ON condition while the air conditioner is running.	○	—
	2 time flash	82	Indoor heat exchanger sensor is abnormal (anomalous stop)	Indoor heat exchanger sensor wire is disconnected. Connector connections are poor.	When a temperature of -28°C or lower is sensed continuously for 40 minutes during heating operation. (the compressor stops).	○	—
	4 time flash	84	Anti-condensation control	High humidity condition. Humidity sensor is faulty.	Anti-condensation prevention control is operating.	—	○
	5 time flash	85	Anti-frost control	Indoor unit fan speed drops. Indoor heat exchanger sensor is broken wire.	When the anti-frost control operates and the compressor stops during cooling operation.	—	○
	6 time flash	86	Heating high pressure control	Heating overload operation. Indoor unit fan speed drops. Indoor heat exchanger sensor is short circuit.	When high pressure control operates during heating operation and the compressor stops.	—	○

Note (1) The number of flashes when in the Service Mode do not include the 1.5 second period when the lights light up at first (starting signal). (See the example shown below.)

- In the case of current cut (example: stop code "42")
The RUN light (10's digit) flashes 4 times and the TIMER light (1's digit) flashes 2 times.
 $4 \times 10 + 2 \times 1 = 42 \rightarrow$ From the table, read the instructions for error code 42, "Current cut".

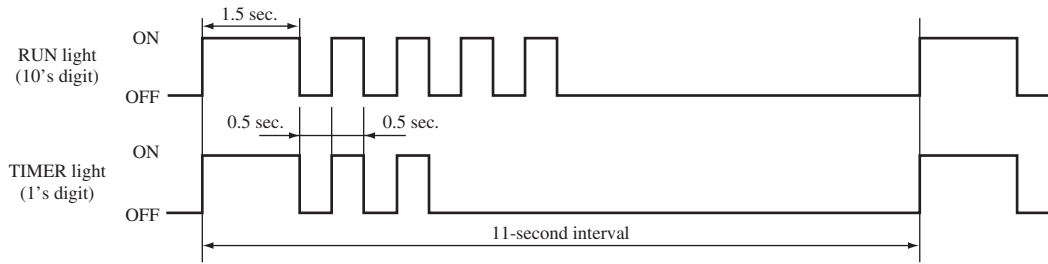

- (2) Error display: – Is not displayed. (automatic recovery only)
 ○ Displayed.
If there is a () displayed, the error display shows the number of times that an auto recovery occurred for the same reason has reached the number of times in ().
If no () is displayed, the error display shows that the trouble has occurred once.
- (3) Auto Recovery: – Does not occur
 ○ Auto recovery occurs.

(d) Remote control information tables

1) Operation switching

Display pattern when in service mode	Operation switching when there is an abnormal stop
RUN light (Operation switching)	
0	AUTO
1	DRY
2	COOL
3	FAN
4	HEAT

2) Fan speed switching

Display pattern when in service mode	Fan speed switching when there is an abnormal stop
TIMER light (Fan speed switching)	
0	AUTO
2	HI
3	MED
4	LO
6	HI POWER
7	ECONO

* If no data are recorded (error code is normal), the information display in the remote control becomes as follows.

Remote control setting	Display when error code is normal.
Operation switching	AUTO
Fan speed switching	AUTO

(Example): Operation switching, fan speed switching, cooling HI

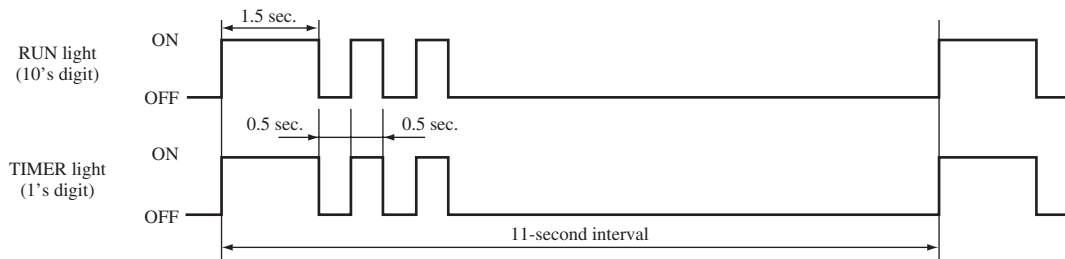

(e) Room temperature sensor temperature, indoor heat exchanger sensor temperature, outdoor air temperature sensor temperature, outdoor heat exchanger sensor temperature table

Units: °C

Buzzer sound (minus)	RUN light (10's digit)	TIMER light (1's digit)									
		0	1	2	3	4	5	6	7	8	9
Yes (sounds for 0.1 second)	6	-60	-61	-62	-63	-64					
	5	-50	-51	-52	-53	-54	-55	-56	-57	-58	-59
	4	-40	-41	-42	-43	-44	-45	-46	-47	-48	-49
	3	-30	-31	-32	-33	-34	-35	-36	-37	-38	-39
	2	-20	-21	-22	-23	-24	-25	-26	-27	-28	-29
	1	-10	-11	-12	-13	-14	-15	-16	-17	-18	-19
	0	/	-1	-2	-3	-4	-5	-6	-7	-8	-9
No (does not sound)	0	0	1	2	3	4	5	6	7	8	9
	1	10	11	12	13	14	15	16	17	18	19
	2	20	21	22	23	24	25	26	27	28	29
	3	30	31	32	33	34	35	36	37	38	39
	4	40	41	42	43	44	45	46	47	48	49
	5	50	51	52	53	54	55	56	57	58	59
	6	60	61	62	63	64	65	66	67	68	69
	7	70	71	72	73	74	75	76	77	78	79
	8	80	81	82	83	84	85	86	87	88	89
	9	90	91	92	93	94	95	96	97	98	99

* If no data are recorded (error code is normal), the display for each sensor becomes as shown below.

Sensor name	Sensor value displayed when the error code is normal
Room temperature sensor temperature	-64°C
Indoor heat exchanger sensor temperature	-64°C
Outdoor air temperature sensor temperature	-64°C
Outdoor heat exchanger sensor temperature	-64°C

(Example) Room temperature, indoor heat exchanger, outdoor air temperature, outdoor heat exchanger: “-9°C”

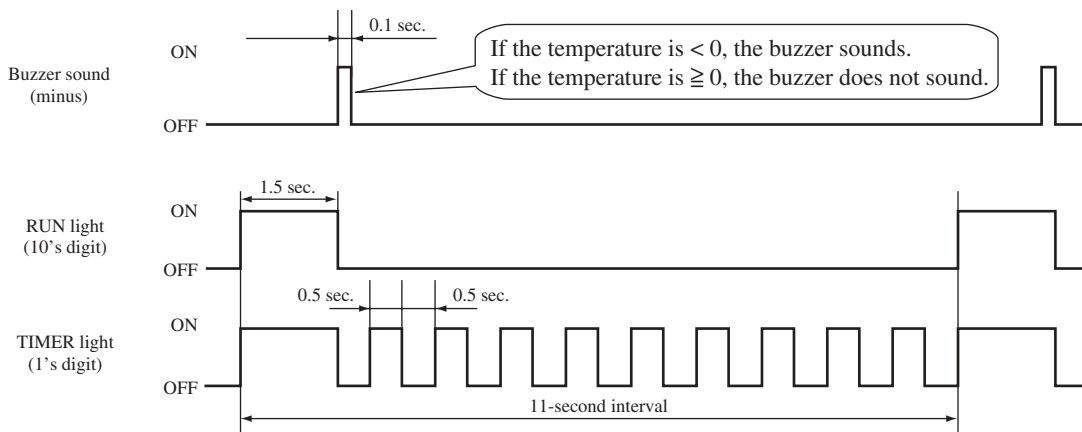

(f) Discharge pipe temperature table

Units: °C

Buzzer sound (minus)	RUN light (10's digit)	TIMER light (1's digit)									
		0	1	2	3	4	5	6	7	8	9
Yes (sounds for 0.1 second)	3	-60	-62	-64							
	2	-40	-42	-44	-46	-48	-50	-52	-54	-56	-58
	1	-20	-22	-24	-26	-28	-30	-32	-34	-36	-38
	0	/	-2	-4	-6	-8	-10	-12	-14	-16	-18
No (does not sound)	0	0	2	4	6	8	10	12	14	16	18
	1	20	22	24	26	28	30	32	34	36	38
	2	40	42	44	46	48	50	52	54	56	58
	3	60	62	64	66	68	70	72	74	76	78
	4	80	82	84	86	88	90	92	94	96	98
	5	100	102	104	106	108	110	112	114	116	118
	6	120	122	124	126	128	130	132	134	136	138
	7	140	142	144	146	148	150				

* If no data are recorded (error code is normal), the display for each sensor becomes as shown below.

Sensor name	Sensor value displayed when the error code is normal
Discharge pipe sensor temperature	-64°C

(Example) Discharge pipe temperature: "122°C"

* In the case of discharge pipe data, multiply the reading value by 2. (Below, 61 x 2 = "122°C")

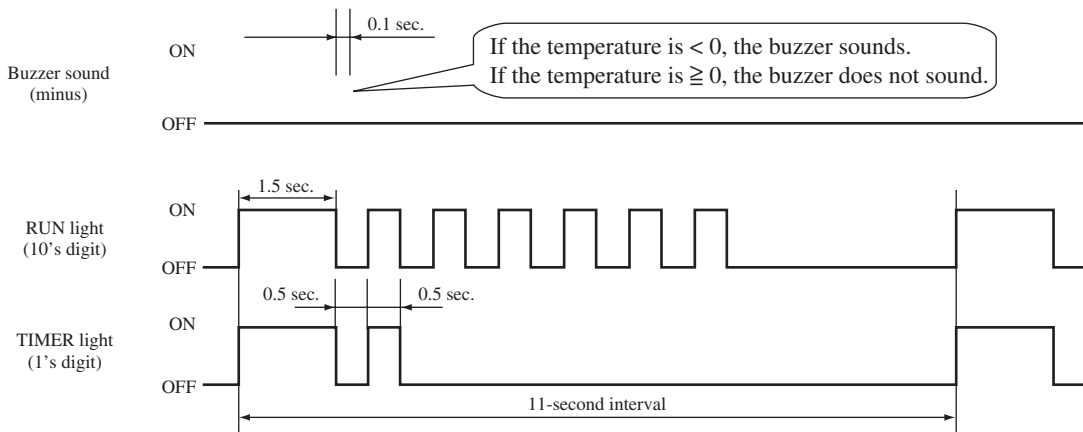

Service data record form

Customer			Model				
Date of investigation							
Machine name							
Content of complaint							
Remote control settings			Content of displayed data	Display results			Display content
Temperature setting	Operation switching	Fan speed switching		Buzzer (Yes/No.)	RUN light (Times)	TIMER light (Times)	
21	Cooling	MED	Error code on previous occasion.	/			
		HI	Room temperature sensor temperature on previous occasion.				
		AUTO	Indoor heat exchanger sensor 1 temperature on previous occasion.				
	Heating	LO	Remote control information on previous occasion.	/			
		MED	Outdoor air temperature sensor temperature on previous occasion.				
		HI	Outdoor heat exchanger sensor temperature on previous occasion.				
26	Cooling	AUTO	Indoor heat exchanger sensor 3 temperature on previous occasion.				
22	Cooling	MED	Error code on second previous occasion.	/			
		HI	Room temperature sensor temperature on second previous occasion.				
		AUTO	Indoor heat exchanger sensor 1 temperature on second previous occasion.				
	Heating	LO	Remote control information on second previous occasion.	/			
		MED	Outdoor air temperature sensor temperature on second previous occasion.				
		HI	Outdoor heat exchanger sensor temperature on second previous occasion.				
27	Cooling	AUTO	Indoor heat exchanger sensor 3 temperature on second occasion.				
23	Cooling	MED	Error code on third previous occasion.	/			
		HI	Room temperature sensor temperature on third previous occasion.				
		AUTO	Indoor heat exchanger sensor 1 temperature on third previous occasion.				
	Heating	LO	Remote control information on third previous occasion.	/			
		MED	Outdoor air temperature sensor temperature on third previous occasion.				
		HI	Outdoor heat exchanger sensor temperature on third previous occasion.				
28	Cooling	AUTO	Indoor heat exchanger sensor 3 temperature on third occasion.				
24	Cooling	MED	Error code on fourth previous occasion.	/			
		HI	Room temperature sensor temperature on fourth previous occasion.				
		AUTO	Indoor heat exchanger sensor 1 temperature on fourth previous occasion.				
	Heating	LO	Remote control information on fourth previous occasion.	/			
		MED	Outdoor air temperature sensor temperature on fourth previous occasion.				
		HI	Outdoor heat exchanger sensor temperature on fourth previous occasion.				
29	Cooling	AUTO	Indoor heat exchanger sensor 3 temperature on fourth occasion.				
25	Cooling	MED	Error code on fifth previous occasion.	/			
		HI	Room temperature sensor temperature on fifth previous occasion.				
		AUTO	Indoor heat exchanger sensor 1 temperature on fifth previous occasion.				
	Heating	LO	Remote control information on fifth previous occasion.	/			
		MED	Outdoor air temperature sensor temperature on fifth previous occasion.				
		HI	Outdoor heat exchanger sensor temperature on fifth previous occasion.				
30	Cooling	AUTO	Indoor heat exchanger sensor 3 temperature on fifth occasion.				
21	Cooling	Lo	Stop code on previous occasion.				
22			Stop code on second previous occasion.				
23			Stop code on third previous occasion.				
24			Stop code on fourth previous occasion.				
25			Stop code on fifth previous occasion.				
26			Stop code on sixth previous occasion.				
27			Stop code on seventh previous occasion.				
28			Stop code on eighth previous occasion.				
29			Stop code on ninth previous occasion.				
30			Stop code on tenth previous occasion.				
Judgment							Examiner
Remarks							

Note (1) In the case of indoor heat exchanger sensor 3, match from 26 to 30 the temperature setting of remote control. (Refer to page 34)

(7) Inspection procedures corresponding to detail of trouble

Sensor error

[Broken sensor wire, connector poor connection]

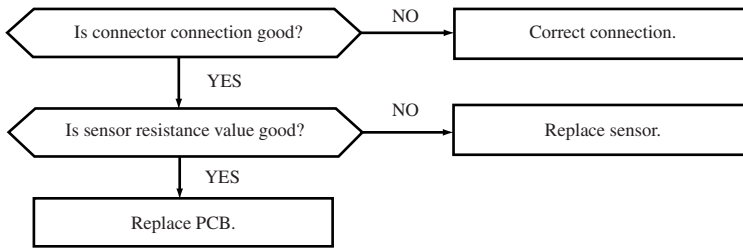

◆ Discharge pipe sensor temperature characteristics

Temperature (°C)	Resistance (kΩ)	Temperature (°C)	Resistance (kΩ)
0	164	70	8.7
5	127	75	7.3
10	99	80	6.2
15	78	85	5.3
20	62	90	4.5
25	50	95	3.9
30	40	100	3.3
35	32	105	2.9
40	26	110	2.5
45	21	115	2.2
50	17	120	1.9
55	14	125	1.6
60	12	130	1.4
65	10	135	1.3

◆ Sensor temperature characteristics (Room temp., indoor unit heat exchanger temp., outdoor unit heat exchanger temp., outdoor air temp.)

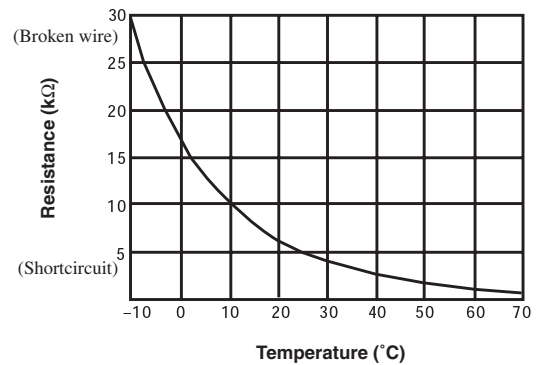

Indoor fan motor error

[Defective fan motor, connector poor connection, defective PCB]

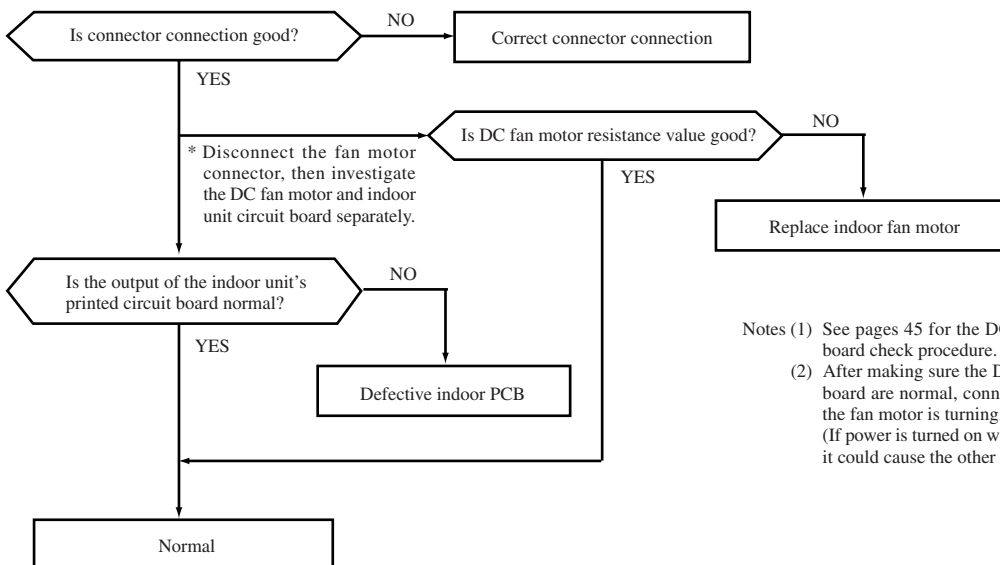

Notes (1) See pages 45 for the DC fan motor and indoor unit circuit board check procedure.
 (2) After making sure the DC fan motor and indoor unit circuit board are normal, connect the connectors and confirm that the fan motor is turning.
 (If power is turned on while one or the other is broken down, it could cause the other to break down also.)

Current cut

[Open phase on compressor output terminal, compressor lock]

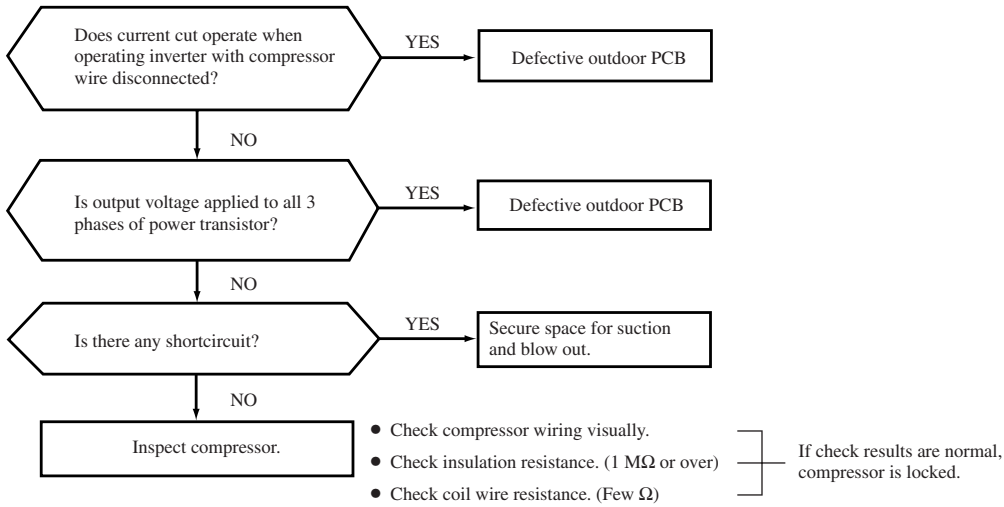

Trouble of outdoor unit

[Compressor malfunction of insufficient gas (refrigerant)]

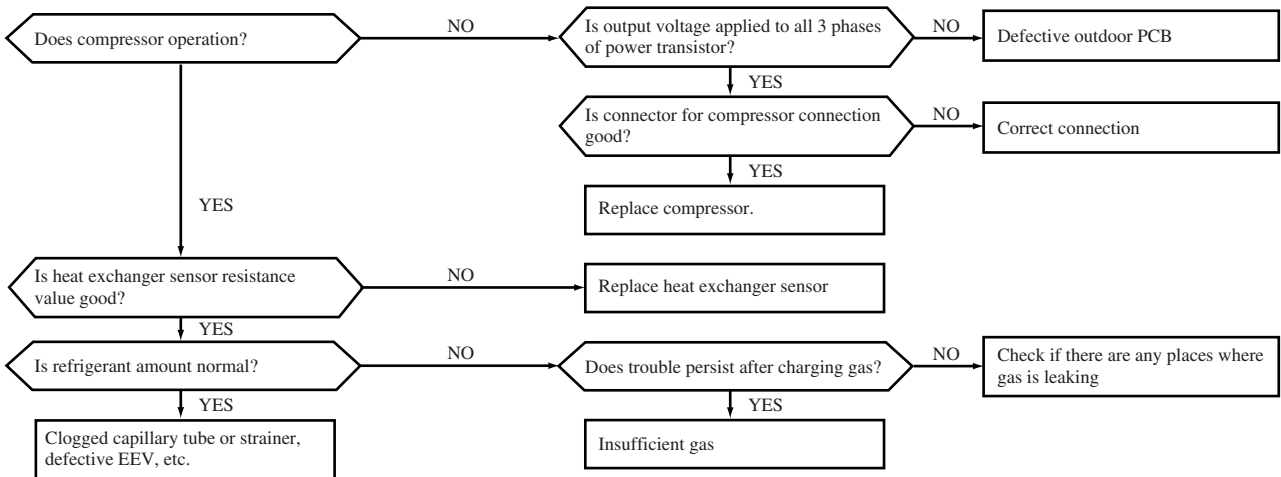

Current safe stop

[Overload operation, compressor lock, overcharge]

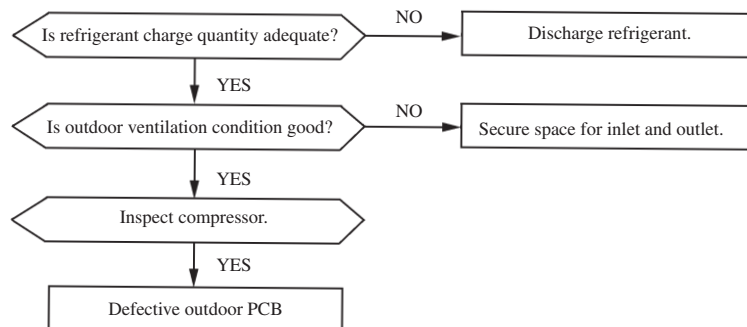

Over heat of compressor

[Gas shortage, defective discharge pipe sensor]

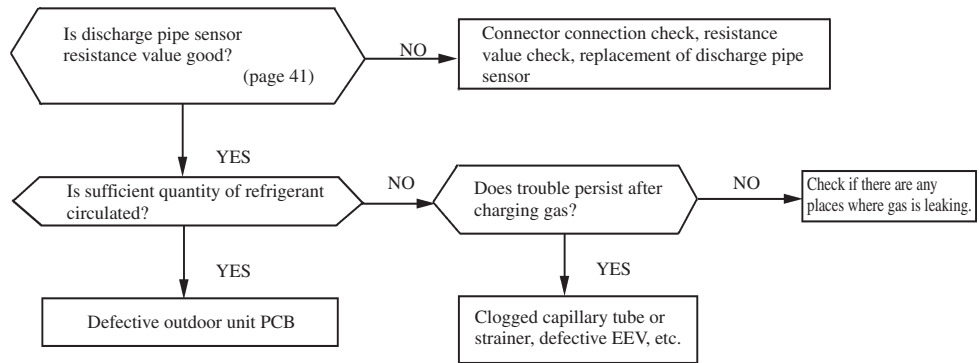

Error of signal transmission

[Wiring error including power cable, defective indoor/outdoor unit PCB]

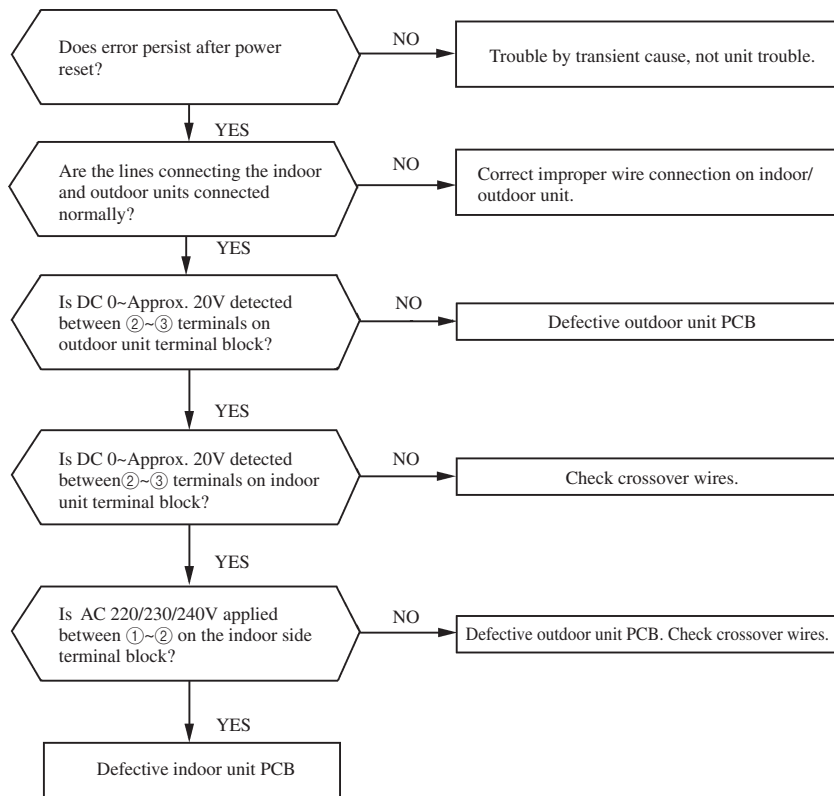

Outdoor fan motor error

[Defective fan motor, connector poor connection, defective PCB]

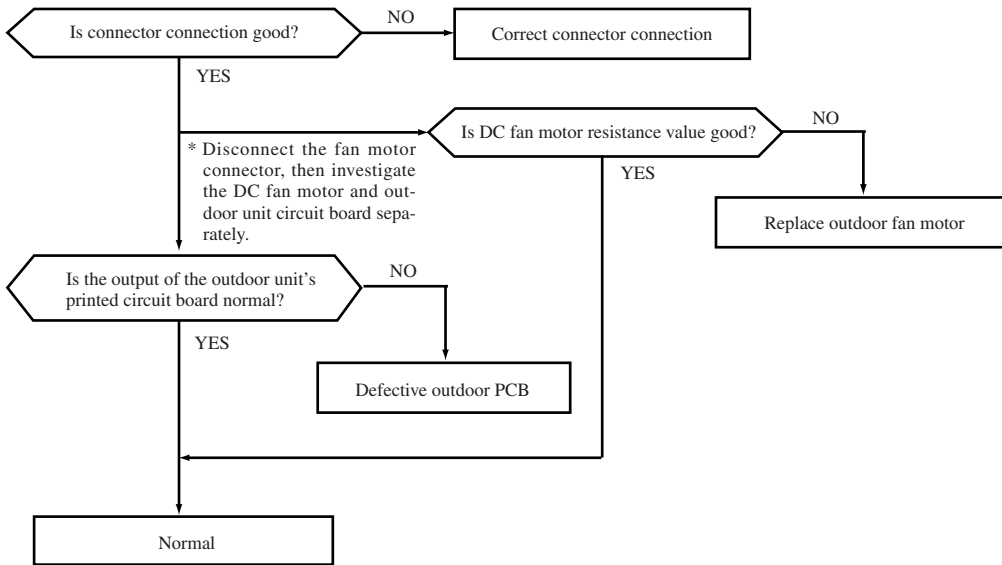

Rotor lock

[Compressor defect, outdoor unit circuit defect]

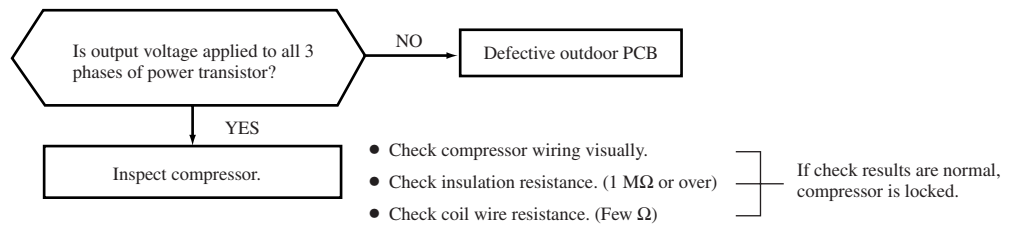

(8) Phenomenon observed after shortcircuit, wire breakage on sensor

(a) Indoor unit

Sensor	Operation mode	Phenomenon	
		Shortcircuit	Disconnected wire
Room temperature sensor	Cooling	Release of continuous compressor operation command	Continuous compressor operation command is not released.
	Heating	Continuous compressor operation command is not released.	Release of continuous compressor operation command
Heat exchanger sensor	Cooling	System can be operated normally.	Continuous compressor operation command is not released. (Anti-frosting)
	Heating	High pressure control mode (Inverter stop command)	Hot keep (Indoor fan stop)
Humidity Sensor	Cooling	① in the table below.	① in the table below.
	Heating	Normal system operation is possible.	

① Humidity sensor operation

Failure mode	Control input circuit reading	Air conditioning system operation
Disconnected wire	① Disconnected wire	Humidity reading is 0%
	② Disconnected wire	
	①② Disconnected wire	
Short Circuit	① and ② are short circuited	Humidity reading is 100%

Remark: Do not perform a continuity check of the humidity sensor with a tester. If DC current is applied, it could damage the sensor.

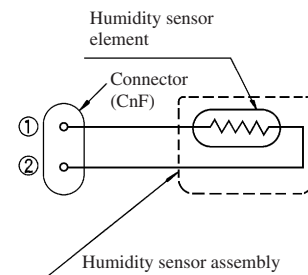

(b) Outdoor unit

Sensor	Operation mode	Phenomenon	
		Shortcircuit	Disconnected wire
Heat exchanger sensor	Cooling	System can be operated normally.	Compressor stop.
	Heating	Defrosting is not performed.	Defrosting is performed for 10 minutes at approx. 35 minutes.
Outdoor air temperature sensor	Cooling	System can be operated normally.	Compressor stop.
	Heating	Defrosting is not operated.	Defrosting is performed for 10 minutes at approx. 35 minutes.
Discharge pipe sensor	All modes	Compressor overload protection is disabled. (Can be operated.)	Compressor stop

(9) Checking the indoor electrical equipment

(a) Indoor unit circuit board check procedure

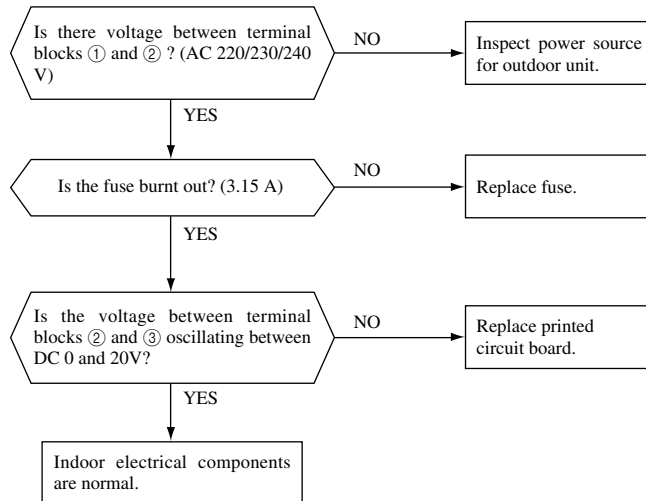

(b) Indoor unit fan motor check procedure

This is a diagnostic procedure for determining if the indoor unit's fan motor or the circuit board is broken down.

1) Indoor unit printed circuit board output check

- Turn off the power.
- Remove the front panel, then disconnect the fan motor lead wire connector.
- Turn on the power. If the unit operates when the ON/OFF button is pressed, if trouble is detected after the voltages in the following figure are output for approximately 30 seconds, it means that the circuit board is normal and the fan motor is broken down.

If the voltages in the following figure are not output at connector pins No. ①, ④ and ⑤, the indoor unit's circuit board has failed and the fan motor is normal.

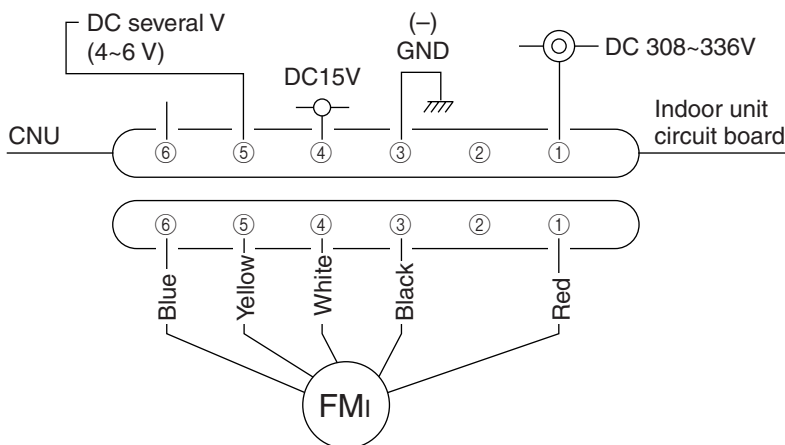

2) DC Fan motor resistance check

Measuring Point	Resistance when Normal
① - ③ (Red - Black)	25 MΩ or higher
④ - ③ (White - Black)	30 kΩ or higher

- Notes (1) Remove the fan motor and measure it without power connected to it.
 (2) If the measured value is below the value when the motor is normal, it means that the fan motor is faulty.

(10) Outdoor unit inspection points

◆ Check point of outdoor unit

⚠ CAUTION – HIGH VOLTAGE

High voltage is produced in the control box. Don't touch electrical parts in the control box for 5 minutes after the unit is stopped.

Color symbol

BK	Black
BR	Brown
OR	Orange
RD	Red
WH	White
YE	Yellow
YG	Yellow/Green

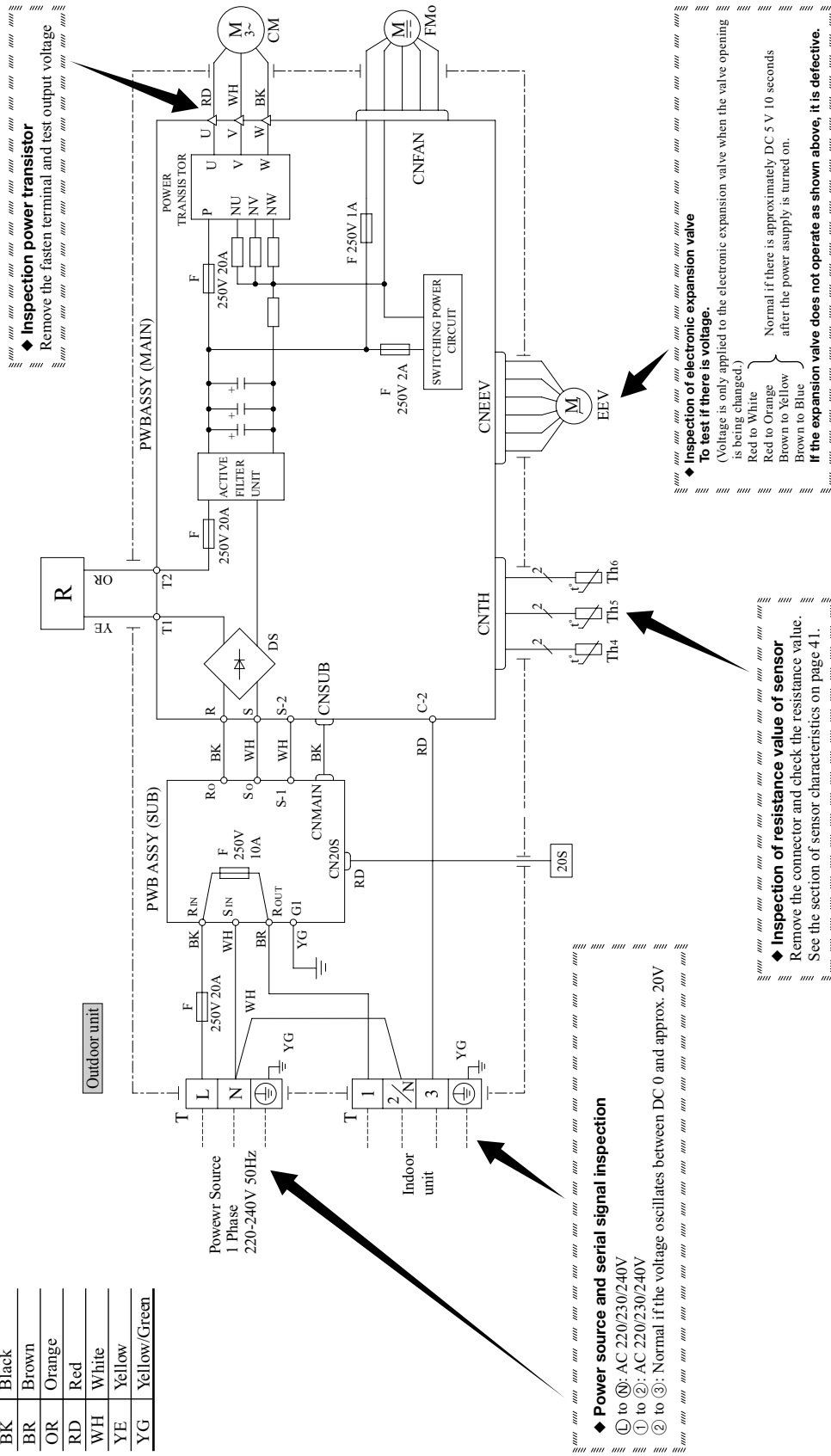

◆ **Power transistor inspection procedure**

[Use a tester with a needle indicator for the inspection. (Do not use a digital tester. Check in the AC 300 volt range.)]

(1) If there is a self-diagnosis display, inspect the compressor system (burns, wiring mistakes, etc.) If no problems are found, check the output of the power transistor.

(2) Output inspection procedure

Disconnect the terminals for the compressor.

If an output such as the one shown in the figure on the below can be measured, the power transistor and the circuit board for the outdoor unit are normal.

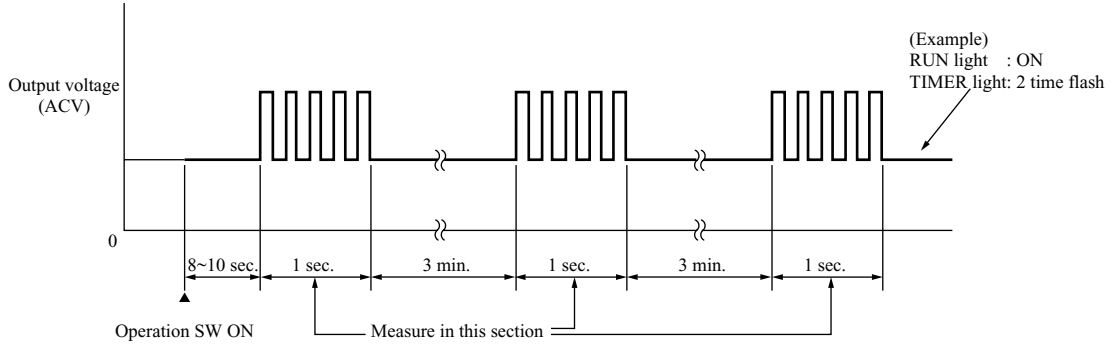

(11) How to make sure of remote control

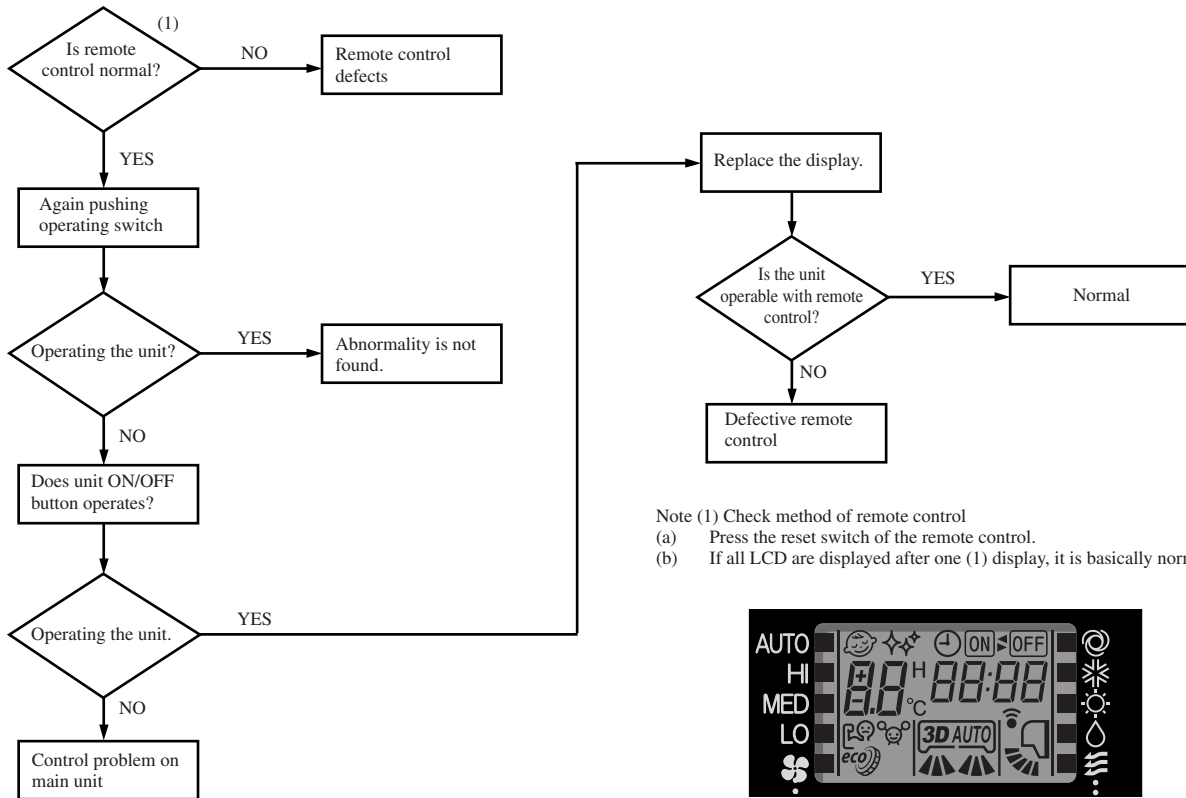

6.2 Servicing

(1) Evacuation

The evacuation is an procedure to purge impurities.....noncondensable gas, air, moisture from the refrigerant equipment by using a vacuum pump. Since the refrigerant R410A is very insoluble in water, even a small amount of moisture left in the refrigerant equipment will freeze, causing what is called water clogging.

- Evacuation procedure

- Check to ensure that there is no internal pressure in the unit. If there is an internal pressure, it should be relieved through the check joint.
- Connect the service hoses of the gauge manifold to the check joint of the gas & liquid piping.
- Connect a vacuum pump to the charge hose (A) . Repeat evacuation in the following sequence.

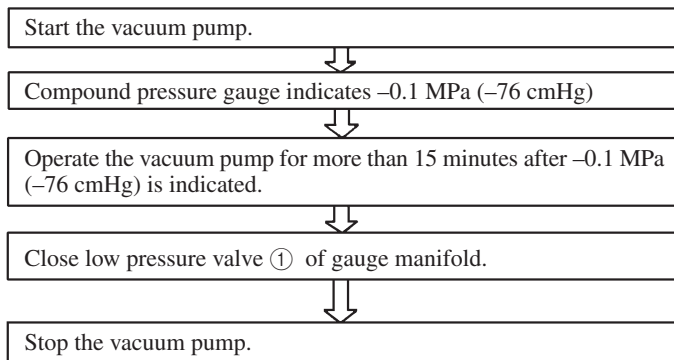

- Notes
- (1) Do not use the refrigerant pressure to expel air.
 - (2) Do not use the compressor for evacuation.
 - (3) Do not operate the compressor in the vacuum condition.

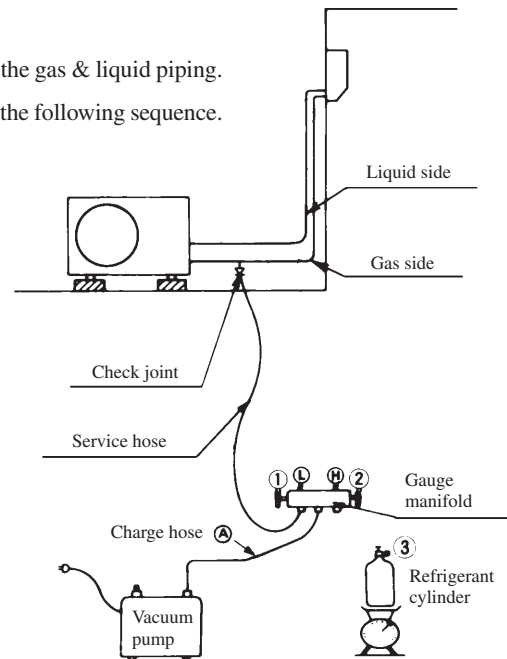

(2) Refrigerant charge

- Discharge refrigerant entirely from the unit and evacuate the unit.
Note: Addition of refrigerant without evacuation is unreasonable, because it will result in low charge or overcharge.
- Keep the gauge manifold and connect a refrigerant cylinder to the unit.
- Record the weight of the refrigerant cylinder on the balance. This is necessary for making sure of the charged refrigerant amount.
- Purge air from the charge hose (A)
Firstly loose the connecting portion of the charge hose (A) at the gauge manifold side and open the valve (3) for a few seconds, and then immediately retighten it after observing that gas is blow out from the loosened portion.
- Open the valve (1) and (3) after discharging air from the charge hose (A), then the liquid refrigerant begins flowing from the cylinder into the unit. Be sure to erect the refrigerant cylinder upright to let liquid refrigerant flow into the unit.
- When refrigerant has been charged into the system to some extent, refrigerant flow becomes stagnant, when that happens, start the compressor in cooling cycle until the unit is filled with refrigerant to the specified weight.
- Making sure of the refrigerant amount, close the valve (3)
- Disconnect the charge hose from the unit. Cover the valve ports of the refrigerant piping with caps and tighten them securely.
- Check for gas leakage applying a gas leak detector along the piping line.
- Start the air conditioner and make sure of its operating condition.....high side and low side pressures and temperature difference between return air and supply air.

7 REFRIGERANT PIPING INSTALLATION/SERVICING MANUAL FOR AIR CONDITIONERS USING R410A

(These materials are extracted from document issued by The Japan Refrigeration and Air Conditioning Industry Association)

7.1 Outline

7.1.1 Refrigerant R410A

(1) Adoption of R410A in air conditioners

In 1974, it was pointed out that the ozone layer in the upper stratosphere (about 20 ~ 40 km above ground) might have been damaged by the ozone depleting substances such as CFC (chlorofluorocarbon) and HCFC (hydrochlorofluorocarbon). Since that time, many countries across the world have endeavored to take countermeasures against the ozone depletion.

As a refrigerant belonging to the HCFCs, the conventional refrigerant (R22) used in air conditioners also tends to deplete the ozone layer. Therefore, complying with the provisions of the international regulations (i.e. Montreal Protocol concerning the Ozone Depleting Substances) and national laws & Regulations concerned, it is necessary to replace R22 with other types of refrigerant which do not deplete the ozone layer.

A refrigerant composed of hydrogen (H), fluorine (F) and carbon (C), is called an HFC and does not deplete the ozone layer. One HFC's is R410A whose pressure is about 1.6 times higher than R22 and whose energy efficiency is almost comparable to that of R22 at the same refrigerant temperature.

(2) Chemical characteristics of R410A

a) Chemical stability

Like R22, R410A is a chemically stable, less toxic and non-flammable refrigerant. However, as in the case of R22, the specific gravity of its vapour is larger than that of air and should it leak in an airtight room it may stay at a low level and cause an oxygen starvation accident. It may also, should it come in direct contact with fire, cause a poisonous gas to occur, so be sure to handle it only in a well ventilated area.

b) Composition changes (Pseudo-azeotropic characteristics)

R410A is a pseudo-azeotropic mixed refrigerant composed of two constituents - R32 and R125. "Quasi-azeotropic" condition refers to a state in which the dew-point curve and boiling-point curve - gas-liquid equilibrium curves (pressure constant) - almost lie on top of each other, and a multi-constituent refrigerant having this chemical characteristic incurs less composition changes even when evaporation (or condensation) as a phase change occurs. Consequently, even when refrigerant leaks from the gas phase somewhere in the piping installation, the composition of circulated refrigerant incurs less changes.

Therefore, R410A can be treated in almost a same manner as a mono-constituent refrigerant like R22 is treated. When actually charging R410A, however, do so from the liquid phase side by taking into account the phenomenon that, when put in a cylinder, the composition changes a little between gas and liquid phases.

c) Pressure characteristics

As shown in Table 2, since R410A's vapor pressure is about 1.6 times higher than that of R22 at the same temperature, perform installation/service with special tools and materials which are exclusive for R410A and can withstand high pressure.

Table 1. Comparison of thermophysical properties of R410A and R22

	R410A	R22
Composition (wt%)	R32/R125 (50/50)	R22 (100)
Molecular weight	72.6	86.5
Boiling point (°C)	-51.4	-40.8
Vapor pressure (25°C, MPa)	1.56	0.94
Saturated vapor density (25°C, kg/m ³)	64.0	44.4
Inflammability	Nonflammable	Nonflammable
Ozone depletion potential (ODP)	0	0.055
Global warming potential (GWP)	1730	1700

Source: List of thermophysical properties compiled by the Japan society of refrigeration and air conditioning, NIST REFPROP V5.10, etc.

Table 2. Comparison of saturated vapor pressure of R410A and R22
unit: MPa

Refrigerant Temperature (°C)	R410A	R22
-20	0.30	0.14
0	0.70	0.40
20	1.35	0.81
40	2.32	1.43
60	3.73	2.33
65	4.15	2.60

Source: List of thermophysical properties compiled by the Japan society of refrigeration and air conditioning, NIST REFPROP V5.10, etc.

(3) Lubricating oils for R410A

As the lubricating oils for R22, mineral oils, alkylbenze synthetic oils, etc. have so far been used. As R410A features less solubility with these conventional lubricating oils such as mineral oils, the lubricating oils tend to stay within the refrigeration cycle. As the lubricating oils highly soluble with R410A, ester, ethereal and other synthetic oils are available. However, as these synthetic oils are very hygroscopic, they must be treated even more carefully than the conventional lubricating oils. Furthermore, if these synthetic oils are mixed with mineral oils, alkylbenzene synthetic oils, etc., they may deteriorate, and block the capillary tubes, or cause the compressor to fail. So, never mix these synthetic oils.

7.1.2 Safety during installation/servicing

As R410A’s pressure is about 1.6 times higher than that of R22, improper installation/servicing may cause a serious trouble. By using tools and materials exclusive for R410A, it is necessary to carry out installation/servicing safely while taking the following precautions into consideration.

- 1) Never use refrigerant other than R410A in an air conditioner which is designed to operate with R410A.
- 2) If a refrigeration gas leakage occurs during installation/servicing, be sure to ventilate fully.
If the refrigerant gas comes into contact with fire, a poisonous gas may occur.
- 3) When installing or removing an air conditioner, do not allow air or moisture to remain in the refrigeration cycle. Otherwise, pressure in the refrigeration cycle may become abnormally high so that a rupture or personal injury may be caused.
- 4) After completion of installation work, check to make sure that there is no refrigeration gas leakage.
If the refrigerant gas leaks into the room, coming into contact with fire in the fan driven heater, space heater, etc., a poisonous gas may occur.
- 5) When an air conditioning system charged with a large volume of refrigerant (e.g. multi type air conditioner) is installed in a small room, it is necessary to exercise care so that, even when refrigerant leaks, its concentration does not exceed the marginal level.
If the refrigerant gas leakage occurs and its concentration exceeds the marginal level, an oxygen starvation accident may result.
- 6) Be sure to carry out installation or removal according to the installation manual.
Improper installation may cause refrigeration trouble, water leakage, electric shock, fire, etc.
- 7) Unauthorized modifications to the air conditioner may be dangerous. If a breakdown occurs please call a qualified air conditioner technician or electrician.
Improper repair’s may result in water leakage, electric shock and fire, etc.

7.2 Refrigerant piping installation

7.2.1 Piping materials and joints used

For the refrigerant piping installation, copper pipes and joints are mainly used. Copper pipes and joints suitable for the refrigerant must be chosen and installed. Furthermore, it is necessary to use clean copper pipes and joints whose interior surfaces are less affected by contaminants.

(1) Copper pipes

It is necessary to use seamless copper pipes which are made of either copper or copper alloy and it is desirable that the amount of residual oil is less than 40 mg/10m. Do not use copper pipes having a collapsed, deformed or discolored portion (especially on the interior surface). Otherwise, the expansion valve or capillary tube may become blocked with contaminants.

As an air conditioner using R410A incurs pressure higher than when using R22, it is necessary to choose adequate materials. Thicknesses of copper pipes used with R410A are as shown in Table 3. Never use copper pipes thinner than 0.8 mm even when it is available on the market.

Table 3. Thicknesses of annealed copper pipes

Nominal diameter	Outer diameter (mm)	Thickness (mm)	
		R410A	[ref.] R22
1/4	6.35	0.80	0.80
3/8	9.52	0.80	0.80
1/2	12.70	0.80	0.80
5/8	15.88	1.00	1.00

(2) Joints

For copper pipes, flare joints or socket joints are used. Prior to use, be sure to remove all contaminants.

a) Flare joints

Flare joints used to connect the copper pipes cannot be used for pipings whose outer diameter exceeds 20 mm. In such a case, socket joints can be used.

Sizes of flare pipe ends, flare joint ends and flare nuts are as shown in Tables 5~8 (see on page 52, 53) below. Also, union, half union, Tee-type union and elbow-type union shapes are generally used (see Fig 1).

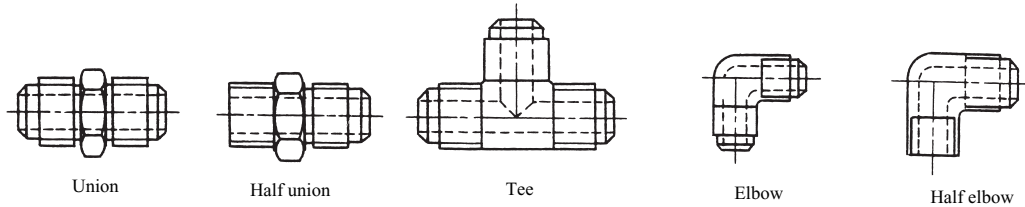

b) Socket joints

Socket joints are such that they are brazed for connections, and used mainly for thick pipings whose diameter is larger than 20 mm. Thicknesses of socket joints are as shown in Table 4. Socket, elbow-type and tee-type shapes are generally used (see Fig. 2).

Table 4. Minimum thicknesses of socket joints

Nominal diameter	Reference outer diameter of copper pipe jointed (mm)	Minimum joint thickness (mm)
1/4	6.35	0.50
3/8	9.52	0.60
1/2	12.70	0.70
5/8	15.88	0.80

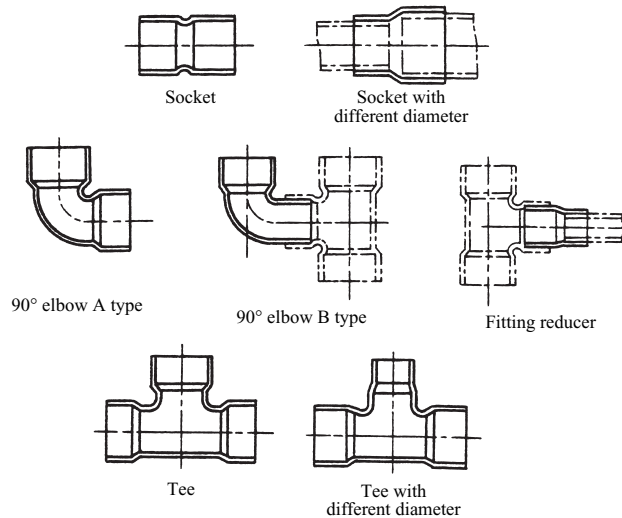

7.2.2 Processing of piping materials

When performing the refrigerant piping installation, care should be taken to ensure that water or dust does not enter the pipe interior, that no other oil other than lubricating oils used in the installed air conditioner is used, and that refrigerant does not leak. When using lubricating oils in the piping processing, use such lubricating oils whose water content has been removed. When stored, be sure to seal the container with an airtight cap or any other cover.

(1) Flare processing procedures and precautions

a) Cutting the pipe

By means of a pipe cutter, slowly cut the pipe so that it is not deformed.

b) Removing burrs and chips

If the flared section has chips or burrs, refrigerant leakage may occur. Carefully remove all burrs and clean the cut surface before installation.

c) Insertion of flare nut

d) Flare processing

Make certain that a clamp bar and copper pipe have been cleaned.

By means of the clamp bar, perform the flare processing correctly.

Use either a flare tool for R410A or conventional flare tool.

Flare processing dimensions differ according to the type of flare tool. Be careful. When using a conventional flare tool, be sure to secure “dimension A” by using a gage for size adjustment.

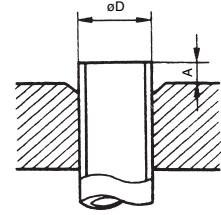

Fig.3 Flare processing dimensions

Table 5. Dimensions related to flare processing for R410A

Nominal diameter	Outer diameter (mm)	Thickness (mm)	A (mm)		
			Flare tool for R410A Clutch type	Conventional flare tool	
				Clutch type	Wing nut type
1/4	6.35	0.8	0~0.5	1.0~1.5	1.5~2.0
3/8	9.52	0.8	0~0.5	1.0~1.5	1.5~2.0
1/2	12.70	0.8	0~0.5	1.0~1.5	2.0~2.5
5/8	15.88	1.0	0~0.5	1.0~1.5	2.0~2.5

Table 6. Dimensions related to flare processing for R22

Nominal diameter	Outer diameter (mm)	Thickness (mm)	A (mm)		
			Flare tool for R410A Clutch type	Conventional flare tool	
				Clutch type	Wing nut type
1/4	6.35	0.8	0~0.5	0.5~1.0	1.0~1.5
3/8	9.52	0.8	0~0.5	0.5~1.0	1.0~1.5
1/2	12.70	0.8	0~0.5	0.5~1.0	1.5~2.0
5/8	15.88	1.0	0~0.5	0.5~1.0	1.5~2.0

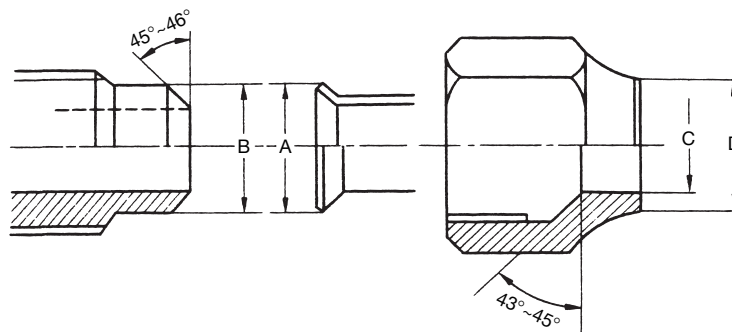

Fig.4 Relations between flare nut and flare seal surface

Table 7. Flare and flare nut dimensions for R410A

[unit: mm]

Nominal diameter	Outer diameter (mm)	Thickness (mm)	Dimension (mm)				Flare nut width
			A	B	C	D	
1/4	6.35	0.8	9.1	9.2	6.5	13	17
3/8	9.52	0.8	13.2	13.5	9.7	20	22
1/2	12.70	0.8	16.6	16.0	12.9	23	26
5/8	15.88	1.0	19.7	19.0	16.0	25	29

Table 8. Flare and flare nut dimensions for R22

[unit: mm]

Nominal diameter	Outer diameter (mm)	Thickness (mm)	Dimension (mm)				Flare nut width
			A	B	C	D	
1/4	6.35	0.8	9.0	9.2	6.5	13	17
3/8	9.52	0.8	13.0	13.5	9.7	20	22
1/2	12.70	0.8	16.2	16.0	12.9	20	24
5/8	15.88	1.0	19.4	19.0	16.0	23	27

(2) Flare connecting procedures and precautions

- a) Make sure that the flare and union portions do not have any scar or dust, etc.
- b) Correctly align the processed flare surface with the union axis.
- c) Tighten the flare with designated torque by means of a torque wrench. The tightening torque for R410A is same as that for conventional R22. Incidentally, when the torque is weak, the gas leakage may occur. When it is strong, the flare nut may crack and may be made nonremovable. When choosing the tightening torque, comply with values designated by manufacturers.

Table 9 shows reference values.

Note : When applying oil to the flare surface, be sure to use oil designated by the manufacturer. If any other oil is used, the lubricating oils may deteriorate and cause the compressor to burn out.

Table 9. Tightening torque of flare for R410A [Reference values]

Nominal diameter	Outer diameter (mm)	Tightening torque N·m (kgf·cm)	Tightening torque of torque wrenches available on the market N·m (kgf·cm)
1/4	6.35	14~18 (140~180)	16 (160), 18 (180)
3/8	9.52	33~42 (330~420)	42 (420)
1/2	12.70	50~62 (500~620)	55 (550)
5/8	15.88	63~77 (630~770)	65 (650)

7.2.3 Storage of piping materials

(1) Types and storage of piping materials

Refrigerant piping materials for air conditioners are broadly classified into the following types.

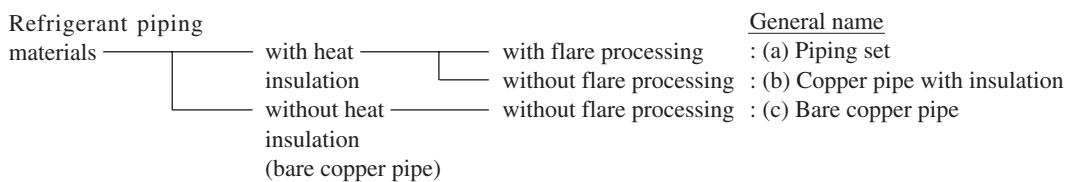

As R410A features pressure about 1.6 times higher than R22, it is necessary to use a copper pipe which has a thickness stated in Table 3 (see on page 50) and which contains less contaminants. It is necessary to carefully treat/store copper pipes so that they are not collapsed, deformed or damaged. Due care must also be exercised so that foreign matters such as dust and water do not enter the pipe interior.

A piping set's open end is sealed with a cap, etc. When storing it, make sure that it is sealed securely. When storing a clad copper pipe or bare copper pipe, securely seal the opening with pinching, taping, etc.

(2) Identification

a) Piping set

A copper pipe as piping set for R410A must have a thickness as stated in Table 3 (see on page 50), and, as shown in Tables 5 and 6 (see on page 52), it also differs from R22 in flare processing and flare nut dimensions. So, it is necessary to choose a piping set suitable for R410A.

b) Copper pipe with insulation

Before using a copper pipe with insulation, make sure that it has a thickness designated for R410A.

c) Bare copper pipe

It is necessary to use a bare copper pipe which has a thickness designated in Table 3 (see on page 50) and contains less contaminants. As the bare copper pipe surface is naked, it is necessary to treat it with exceeding care and adopt a means for identification to prevent improper usage by making it easily discriminable from other piping materials.

(3) Precautions before installation

Observe the following precautions when performing the piping connection at the site.

a) Keep any open ends of pipes be sealed with a cap, etc. until connected with the equipment.

b) Exercise great care when performing piping installation on a rainy day.

When water enters into the piping, the lubricating oil may deteriorate and cause the equipment to fail.

c) Carry out the piping connection in as short a time as possible.

If the piping is left open for a long period, fully purge the interior with nitrogen gas or dry it with a vacuum pump.

7.2.4 Brazing

(1) Processing the connected parts

As brazing is molten between the joined surfaces to yield high adhesive strength, it is necessary to secure a wide enough space to be joined and also an adequate clearance between the joined surfaces. Copper pipe joints' minimum insertion depths, outer pipe diameters and clearances between outer and inner pipe diameters are as shown in Table 10. In the case of bronze brazing filler, when the clearance is about 0.05~0.1mm, the pipes can be connected most strongly.

Table 10. Copper pipe joints' minimum insertion depths and clearances

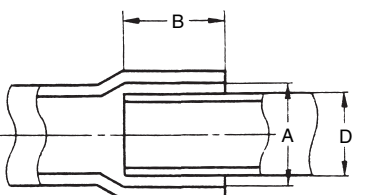

Outer pipe diameter D (mm)	Minimum insertion depth B (mm)	Clearance (A-D) × 1/2 (mm)
5~8	6	0.05~0.35
8~12	7	0.05~0.35
12~16	8	0.05~0.45

* When joining the pipes, either the pipe ends are processed, or pipes are connected by brazing with a socket joint.

(2) Brazing filler metal

a) Alloy brazing filler

An alloy mainly composed of silver and copper is used to join iron, copper or copper alloy. Although it excels in solderability, it is relatively expensive.

b) Phosphor bronze brazing filler

Phosphor bronze brazing filler is generally used to join copper or copper alloy.

c) Low temperature solder

An alloy of tin and lead. An ordinary type of solder. Since it is weak in adhesive strength, it should not be used for refrigerant pipe brazing.

* Cautions:

- 1) BCuP tends to react with sulphur and produce a fragile compound water solution, which may cause a gas leakage. So, use any other type of brazing filler at a hot spring resort, etc., and coat the surface with a paint.
- 2) When performing brazing again at the time of servicing, use the same type of brazing filler.

(3) Flux

a) Reasons for the use of flux

- By removing the oxide film and any foreign matter on the metal surface, it assists the flow of brazing filler.
- In the brazing process, it prevents the metal surface from being oxidized.
- By reducing the brazing filler's surface tension, the brazing filler adheres better to the treated metal.

b) Properties required for flux

- Temperature at which flux is active coincides with the brazing temperature.
- Due to a wide effective temperature range, flux is hard to carbonize.
- It is easy to remove slag after brazing.
- The corrosive action to the treated metal and brazing filler is negligible.
- Excels in coating performance and is harmless to the human body.

As the flux works in a complicated manner as described above, it is necessary to choose an adequate type of flux according to the type and shape of treated metal, type of brazing filler and brazing method, etc.

c) Types of flux

- Incorruptible flux

Generally, it is a compound of borax and boric acid.

Effective in cases where the brazing temperature is higher than 800°C.

- Activated flux

Most of fluxes generally used for silver brazing fall under this type.

It features an increased oxide film removing capability due to the addition of compounds such as potassium fluoride, potassium chloride and sodium fluoride, to the borax-boric acid compound.

* Cautions:

- ① Remove the flux after brazing.
- ② When chlorine contained in the flux stays within the pipe, the lubricating oil deteriorates. So, use a flux which does not contain chlorine.
- ③ When adding water to the flux, use water which does not contain chlorine (e.g. distilled water or ion-exchange water).

(4) Brazing

As brazing requires sophisticated techniques and experiences, it must be performed by a qualified person.

In order to prevent the oxide film from occurring in the pipe interior during brazing, it is effective to proceed with brazing while letting dry nitrogen gas (N₂) flow.

<Brazing method for preventing oxidation>

- a) Attach a reducing valve to the nitrogen gas cylinder
- b) Use a copper pipe to direct the nitrogen gas into the piping, and attach a flowmeter to the nitrogen gas cylinder.
- c) Apply a seal onto the clearance between the piping and inserted pipe for the nitrogen gas in order to prevent the nitrogen gas from flowing backward.
- d) When the nitrogen gas is flowing, be sure to keep the piping end open.
- e) Adjust the flow rate of nitrogen gas so that it is lower than 0.05m³/h, or 0.02MPa (0.2kgf/cm²) by means of the reducing valve.
- f) After taking the steps above, keep the nitrogen gas flowing until the piping cools down to a certain extent (i.e. temperature at which pipes are touchable with finger).
- g) Completely remove the flux after brazing.

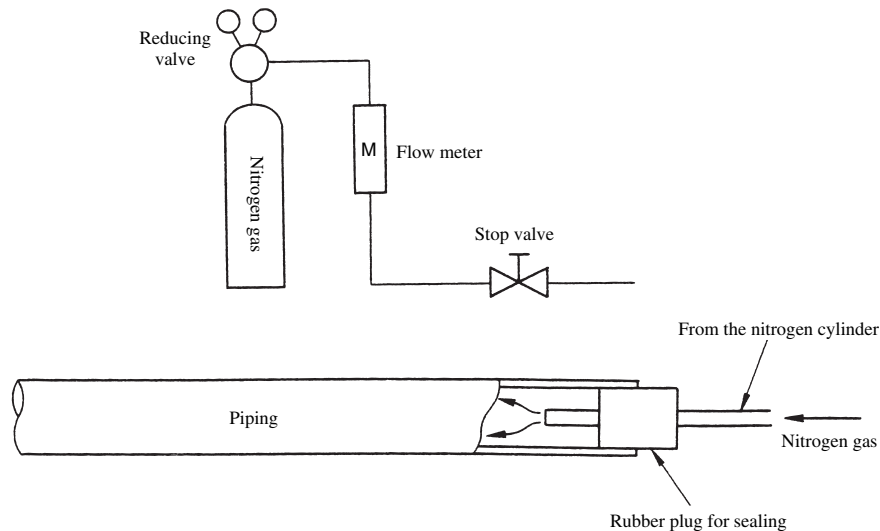

Fig.5 Prevention of oxidation during brazing

* Cautions during brazing

① General cautions

- 1) The brazing strength should be high as required.
- 2) After operation, airtightness should be kept under a pressurized condition.
- 3) During brazing do not allow component materials to become damaged due to overheating.
- 4) The refrigerant pipe work should not be come blocked with scale or flux.
- 5) The brazed part should not restrict the flow in the refrigerant circuit.
- 6) No corrosion should occur from the brazed part.

② Prevention of overheating

Due to heating, the interior and exterior surfaces of treated metal may oxidize. Especially, when the interior of the refrigerant circuit oxidizes due to overheating, scale occurs and stays in the circuit as dust, thus exerting a fatally adverse effect. So, make brazing at adequate brazing temperature and with a minimum of heating area.

③ Overheating protection

In order to prevent components near the brazed part from overheating damage or quality deterioration due to flame or heat, take adequate steps for protection such as (1) by shielding with a metal plate, (2) by using a wet cloth, and (3) by means of heat absorbent.

④ Movement during brazing

Eliminate all vibration during brazing to protect brazed joints from cracking and breakage.

⑤ Oxidation preventive

In order to improve the brazing efficiency, various types of antioxidant are available on the market. However, the constituents of these are widely varied, and some are anticipated to corrode the piping materials, or adversely affect HFC refrigerant, lubricating oil, etc. Exercise care when using an oxidation preventive.

7.3 Installation, removal and servicing

7.3.1 Tools for R410A

In the case of an air conditioner using R410A, in order to prevent any other refrigerant from being charged accidentally, the service port diameter of the outdoor unit control valve (3-way valve) has been changed. Also, to increase the pressure resisting strength, flare processing dimensions and sizes of opposite sides of flare nuts (for copper pipes with nominal diameters 1/2 and 5/8) have been changed. During installation/service, therefore, prepare tools exclusive for R410A shown in (1) on page 57 and general tools shown in (2) on page 58.

(1) Tools exclusive for R410A

a) Gauge manifold

- As R410A is characterized by high pressure, conventional tools cannot be used.

Table 11. Differences between conventional high/low pressure gauges and those for R410A

	Conventional gauges	Gauges exclusive for R410A
High pressure gauge (red)	-0.1~3.5MPa -76 cmHg~35 kgf/cm ²	-0.1~5.3MPa -76 cmHg~53 kgf/cm ²
Compound gauge (blue)	-0.1~1.7MPa -76 cmHg~17 kgf/cm ²	-0.1~3.8MPa -76 cmHg~38 kgf/cm ²

- In order to prevent any other refrigerant from being charged accidentally, each port of the manifold has been changed in shape.

Table 12. Differences in port size between conventional manifold and that for R410A

	Conventional manifold	Manifold for R410A
Port size	7/16 UNF 20 threads per inch	1/2 UNF 20 threads per inch

b) Charge hose

- As R410A is characterized by high pressure, the pressure resistance of the charge hose has been increased. The material has also been changed to an HFC resistant type, and, as in the case of each port of the manifold, the hose cap size has been changed. Furthermore, for prevention of gas pressure reaction, a charge hose with a valve placed near the cap is also available.

Table 13. Differences between conventional charge hose and that for R410A

		Conventional charge hose	Charge hose for R410A
Pressure resistance	Normal pressure	3.4 MPa (34 kgf/cm ²)	5.1 MPa (51 kgf/cm ²)
	Breaking pressure	17.2 MPa (172 kgf/cm ²)	27.4 MPa (274 kgf/cm ²)
Engineering material		NBR rubber	HNBR rubber internally coated with nylon
Cap size		7/16 UNF 20 threads per inch	1/2 UNF 20 threads per inch

c) Electronic balance for refrigerant charging

- As R410A belonging to the HFCs features high pressure and high evaporating speed, when R410A is charged by using a charging cylinder, R410A in the cylinder cannot be kept in a liquefied state and gasified refrigerant bubbles in the charging cylinder, it becomes difficult to read values. Therefore, it is advisable to adequately use an electronic balance for refrigerant charging.
- An electronic balance for refrigerant charging has higher strength due to its structure with four points of support for refrigerant cylinder weight detection. As the charge hose connecting part has two ports-one for R22 (7/16 UNF 20 threads per inch) and the other for R410A (1/2 UNF 20 threads per inch) - it can also be used for charging the conventional refrigerant.
- Two types of electronic balance for refrigerant charging are available - one for 10kg cylinder and the other for 20kg cylinder.
 - Electronic balance for 10kg cylinder precision ± 2g
 - Electronic balance for 20kg cylinder precision ± 5g
- Refrigerant is charged manually by opening/closing the valve.

d) Torque wrench (for nominal diameters 1/2 and 5/8)

- Along with changes in flare nut sizes for enhanced pressure resisting strength, torque wrenches for R410A differ in opposite side size.

Table 14. Differences between conventional wrenches and those for R410A

	Conventional torque wrench	Torque wrench for R410A
For 1/2 (opposite side × torque)	24mm × 55N·m (550 kgf·cm)	26mm × 55N·m (550 kgf·cm)
For 5/8 (opposite side × torque)	27mm × 65N·m (650 kgf·cm)	29mm × 65N·m (650 kgf·cm)

- e) Flare tool (clutch type)
 - A flare tool for R410A is provided with a large clamp bar receiving hole so that the projection of the copper pipe from the clamp bar can be set at 0~0.5 mm in flare processing, and also features higher spring strength for increased expansion pipe torque. This flare tool can also be used for R22 copper pipe.
- f) Gauge for projection adjustment (used when flare processing is made by using conventional flare tool [clutch type])
 - A gauge 1.0 mm in thickness which helps in easily setting the projection of the copper pipe from the clamp bar at 1.0~1.5 mm.
- g) Vacuum pump adapter
 - It is necessary to use an adapter for preventing vacuum pump oil from flowing back to the charge hose. The charge hose connecting part has two ports - one for conventional refrigerant (7/16 UNF 20 threads per inch) and the other for R410A. If the vacuum pump oil (mineral) mixes with R410A, a sludge may occur and damage the equipment.
- h) Refrigerant cylinder
 - A refrigerant cylinder exclusive for R410A comes identified with refrigerant name and is coated with pink paint as designated by the ARI, U.S.A.
- i) Charge port and packing for refrigerant cylinder
 - According to the charge hose's cap size, a charge port with 1/2 UNF 20 threads per inch and corresponding packing are required.
- j) Gas leakage detector
 - A high sensitivity gas leakage detector exclusive for HFC refrigerant is used. In the case of R410A, the detection sensitivity is about 23g per year.

(2) General tools

- a) Vacuum pump
- b) Torque wrench
 - for 1/4: opposite side 17 mm × $\begin{matrix} (16 \text{ N}\cdot\text{m}) \\ (160 \text{ kgf}\cdot\text{cm}) \end{matrix}$
 - for 1/4: opposite side 17 mm × $\begin{matrix} (18 \text{ N}\cdot\text{m}) \\ (180 \text{ kgf}\cdot\text{cm}) \end{matrix}$
 - for 3/8: opposite side 22 mm × $\begin{matrix} (42 \text{ N}\cdot\text{m}) \\ (420 \text{ kgf}\cdot\text{cm}) \end{matrix}$
- c) Pipe cutter
- d) Reamer
- e) Screwdriver (+, -)
- f) Hacksaw
- g) Hole core drill (ø65 or 70)
- h) Hexagonal wrench (opposite side 4 or 5 mm)
- i) Spanner, or monkey wrench
- j) Tape measure
- k) Thermometer
- l) Clamping ampere meter
- m) Insulation resistance tester (mega tester)
- n) Electro circuit tester
- o) Pipe bender

(3) Applicability of R410A tools to R22 model

Table 15. Applicability of R410A tools to R22 model

	Tools for R410A	Applicable to R22 model
a)	Gauge manifold	×
b)	Charge hose	×
c)	Electronic balance for refrigerant charging	○
d)	Torque wrench (nominal diameter 1/2, 5/8)	×
e)	Flare tool (clutch type)	○
f)	Gauge for projection adjustment*	○
g)	Vacuum pump adapter	○
h)	Refrigerant cylinder	×
i)	Charge port and packing for refrigerant cylinder	×
j)	Gas leakage detector	×

* Used when conventional flare tool (clutch type) is used.

Note: For inquiry, contact your agent.

7.3.2 New installation work (when using new refrigerant piping)

- (1) Air purge by vacuum pump and gas leakage inspection (see Fig. 6)
 - a) Connect the charge hose to the outdoor unit. ①
 - b) Connect the charge hose to the vacuum pump adapter. ②
At this time, keep the control valves in the fully closed position. ③ ④
 - c) Place the handle *Lo* in the fully opened position ⑤, and turn on the vacuum pump's power switch.
During this step, perform evacuating (about 10 ~ 15 minutes); for the evacuating time, refer to the equipment manufacturer's manual.
 - d) When the compound gauge's pointer has indicated -0.1 MPa (-76 cmHg) ⑥, place the handle *Lo* in the fully closed position ⑤, and turn OFF the vacuum pump's power switch
Keep this state for 1~2 minutes, and ascertain that the compound gauge's pointer does not return.
 - e) Fully open the control valves. ③ ④
 - f) Detach the charge hoses. ① ②
 - g) Tightly secure the cap on the service port. ⑦
 - h) After securing the caps on the control valves, check the caps' periphery if there is any gas leakage. ③ ④ ⑦

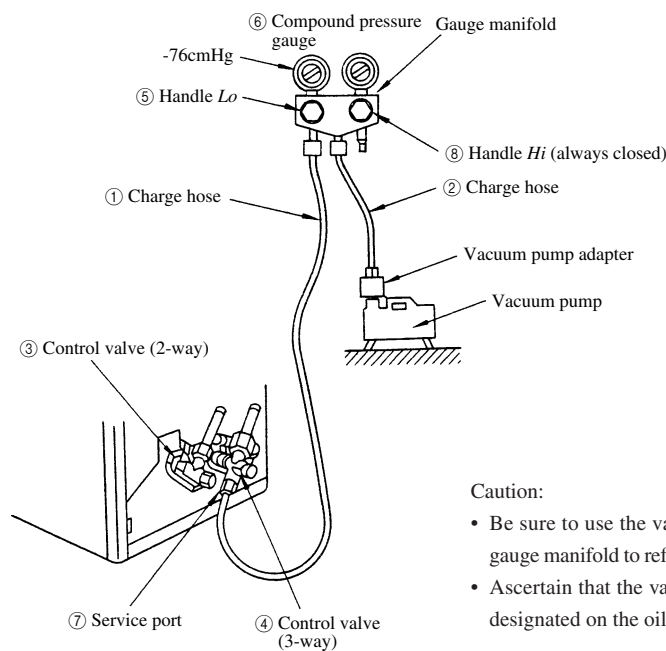

Fig.6 Configuration of air purge by vacuum pump

- (2) Additional refrigerant charging required for refrigerant piping length longer than standard length (The following steps should be taken following the step e) in (1) above. See Fig. 7)
 - a) Set the refrigerant cylinder to the electronic balance, and connect the connecting hoses on the cylinder and electronic balance's connecting port.
* Caution:
Be sure to make setting so that liquid can be charged. When using a cylinder equipped with a siphon, liquid can be charged without turning it upside down.
 - b) Connect the gauge manifold's charge hose to the electronic balance's connecting port. ③ ②
 - c) Open the refrigerant cylinder's valve, and, after opening the charging valve a little, close it. ① ②
 - d) After making zero (0) adjustment, open the charging valve and, by opening the gauge manifold's valve *Lo*, charge the liquid refrigerant. ② ⑤
(Before handling the electronic balance, refer to its instruction manual).
 - e) When the designated amount of refrigerant could not be charged, make additional charging bit by bit by cooling operation (for the amount of each addition, follow the instruction manual prepared by the equipment manufacturer). If the first additional charging was not enough, make the second additional charging after about one minute in the same manner as the first additional charging.
* Caution:
Be sure never to charge a large amount of liquid refrigerant at once to the unit in cooling mode, since liquid is charged from the gas side.

- f) After charging liquid refrigerant into the air conditioner by closing the charging valve, stop operation by fully closing the gauge manifold's valve Lo. ② ⑤
- g) Quickly remove the charge hose from the service port. ⑥
When stopped halfway, refrigerant being cycled will be released.
- h) After securing the caps on the service port and control valve, check the caps' periphery to see if there is any gas leakage. ⑥ ⑦

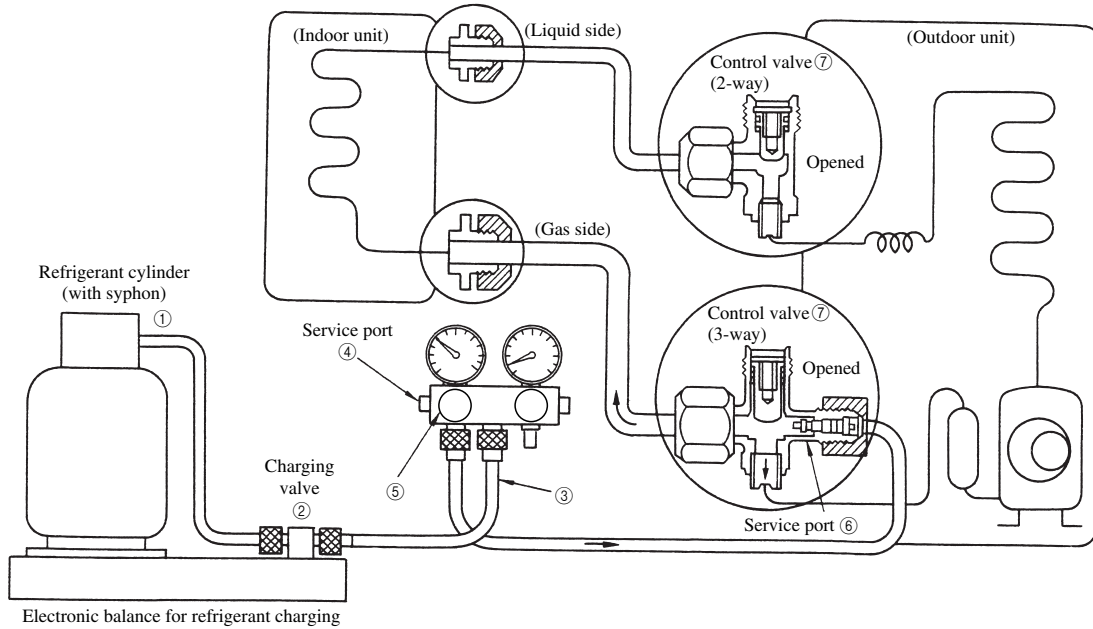

Fig.7 Configuration of additional refrigerant charging

7.3.3 Removal (When using new refrigerant piping)

- (1) Removing the unit
 - a) Recovery of refrigerant from the outdoor unit by pump down
 - At the time of pump down, use a gauge manifold exclusive for R410A.
 - Operating the unit in forced cooling mode, recover refrigerant from the outdoor unit.
(For details of reclaiming steps and precautions, see the instruction manual prepared by the equipment manufacturer)
 - * Caution:
In the case of an outdoor unit which is incapable of pump down, use a refrigerant recovery unit.
 - b) Removing the indoor/outdoor units
 - Remove the piping and wiring between the indoor and outdoor units.
 - Tighten the outdoor unit's control valves and service port with the specified torque.
 - Tighten the capped flare nuts at the indoor/outdoor units connecting part with the specified torque.
 - Remove the indoor/outdoor units.
 - * Caution:
When storing the indoor unit piping in its original position, be careful not to break the piping.
- (2) Installing the unit
 - a) Proceed with the installation following the steps described in "7.3.2 New installation work".

7.3.4 Replacing the unit (Never use the existing refrigerant piping)

Use a brand-new refrigerant piping (1) when replacing the air conditioner using the conventional refrigerant (R22) with an air conditioner using the alternative refrigerant (R410A) or (2) even when replacing the air conditioner using the alternative refrigerant (R410A) with another air conditioner using R410A, as a problem may occur due to differences in pressure characteristics of refrigerant or differences in type of lubricating oil (air conditioners using R410A do not always use the same type of the lubricating oils).

7.3.5 Retrofitting

Do not operate the air conditioner which has used the conventional refrigerant (R22) by charging the alternative refrigerant (R410A). Otherwise, the equipment may cease to function normally and go wrong, or even cause serious problems such as rupture of the refrigeration cycle.

7.3.6 Refrigerant recharging at servicing

When it becomes necessary to recharge refrigerant, charge the specified amount of new refrigerant according to the following steps.

(For details, see the instruction manual prepared by the equipment manufacturer)

- 1) Connect the charge hose to the outdoor unit's service port.
- 2) Connect the charge hose to the vacuum pump adapter. At this time, keep the control valves in the fully opened position.
- 3) Place the handle *Lo* in the fully opened position, and turn ON the vacuum pump's power source. (For the evacuating time, refer to the equipment manufacturer's manual)
- 4) When the compound gauge's pointer has indicated -0.1 MPa (-76 cmHg), place the handle *Lo* in the fully closed position, and turn OFF the vacuum pump's power source. Keep this state for 1 ~ 2 minutes, and ascertain that the compound gauge's pointer does not return.
- 5) Charge liquid refrigerant by using the electronic balance according to the steps described in Section 7.3.2 (2) (pages 59, 60).

7.4 Refrigerant recovery

7.4.1 Recovering procedures

The following procedures for refrigerant recovery represent general procedures, and they may differ between actual cases depending upon the type of refrigerant recovering equipment. The connecting and handling methods for different type of refrigerant recovering equipment may also differ. So, ascertain the details by referring to the respective instruction manuals, etc.

- (1) Checks prior to recovering procedures
 - a) Checking the refrigerant recovering equipment
 - ① Gas leakage [If there is any malfunction, repair it].
 - ② Oil separator [Drain the residual oil].
 - ③ Recovering equipment weighing function, overcharge preventing function (float switch), moisture indicator, drier and other accessory functions [should be adjusted or replaced where necessary].
 - ④ Electrical circuit
 - b) Checking the accessories to the refrigerant recovering equipment
- (2) Preparations for recovering procedures
 - a) Installation of refrigerant recovering equipment
Install the equipment in a place which satisfies the following requirements as much as possible.
 - ① Ambient temperature is higher than 0°C and lower than 40°C.
 - ② A flat and dry floor.
 - ③ A place as close to the air conditioner as possible.
 - b) Preparation of recovering cylinder
A recovering cylinder should be such that it does not go against prohibitions, and is suitable for refrigerant recovered.
 - c) Connect to the power source
 - d) Preparations for air conditioner subjected to refrigerant recovery
 - ① When it is possible to run the air conditioner subjected to refrigerant recovery, perform pump down operation so that refrigerant is contained in the outdoor unit (condenser side).
 - Carry out the pump down operation after confirming the specification of the air conditioner subjected to refrigerant recovery.
 - ② If there is any clogging part (ex. the electronic expansion valve, etc.), fully open such part.

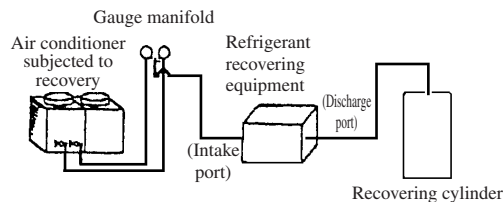

- (3) Connection of refrigerant recovering equipment
 - a) Connect the air conditioner subjected to refrigerant recovery to the refrigerant recovering equipment.
 - ① When there is a service port (port for recovery):
Make connection to the service port (port for recovery) by using a gauge manifold and charge hose.
 - ② When there is no service port (port for recovery):
Make connection in a manner similar to ① above by using a piercing valve.
 - b) Connect the refrigerant recovering equipment to the recovering cylinder.

- (4) Recovering procedures
- According to the instructions for handling the refrigerant recovering equipment (described in the attached instruction manual), operate the equipment to recover refrigerant.
 - During the operation, take care of the following cautions.
 - Ascertain that the refrigerant recovering equipment is running as required and always monitor the state of operation so that adequate steps can be taken in an emergency.
 - During the operation, remain at work site to ensure safety.
 - If you have to leave your work site for any unavoidable reason, stop the operation after ascertaining that the recovering cylinder is not overcharged.
 - During the operation, if the refrigerant recovering equipment's overcharging prevention mechanism operates and the equipment stops automatically, replace the recovering cylinder with an empty one.
 - If the pressure gauge's reading increases after a short time from the accomplishment of recovery and automatic stoppage of the refrigerant recovering equipment, restart the equipment and, if it stops again, finish the recovery.
- (5) Procedures after recovery
- Close the valves on the air conditioner subjected to refrigerant recovery, the refrigerant recovering equipment and the recovering cylinder.
 - Detach the recovering cylinder charged with refrigerant and store it as required by law.

7.4.2 Accessories/tools

In order to carry out R410A recovery, a variety of accessories/tools are required.

Shown below are standard accessories.

(1) Recovering cylinder

- Use a recovering cylinder designated by the equipment manufacturer.
- A detachable cylinder must be such that it complies with the laws and regulations concerned.
- Do not use an ordinary cylinder as a recovering cylinder.

Note 1: A cylinder available when R410A was purchased, is a borrowed one.

Note 2: As a cylinder available when R410A was purchased, is provided with a check valve, it cannot be used as a recovering cylinder.

- Types (by function)

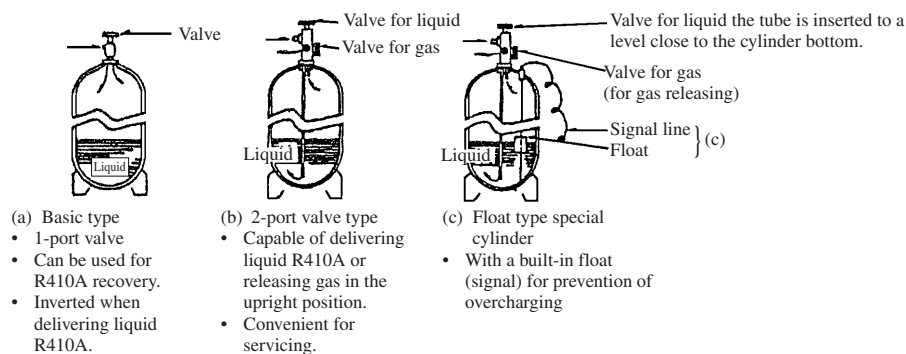

Fig.8 Cylinder types

- Caution

It is prohibited by law to recover R410A into a throw-away service can or one-way cylinder.

(2) Drier

- A desiccant container for removing the water content of R410A.
- A drier should be prepared as expendables.
- Keep the drier sealed just before fitting it.
- Required to protect the R410A recovering equipment.

(3) Connection hose

a) Charge port and charge port packing

- Usually, it is sold independently of a refrigerant cylinder.
- In the case of a two-port cylinder, the diameter may be special. Inquire the manufacture for confirmation.
- A packing is expendables.

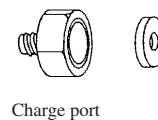

b) Charge hose (pressure resistant hose for fluorocarbon) and packing

- It is 1/4B in thickness and available in various lengths, etc.
- Use a hose whose pressure resisting performance is higher than 5.2 MPa (52 kg/cm²G).
- Generally, a setting fixture is provided only on one end.

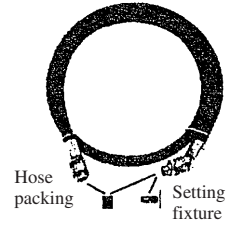

(4) Gauge manifold

- The most important service tool for refrigeration and air conditioner.
- Widely used when charging/recovering R410A while checking gas pressure.

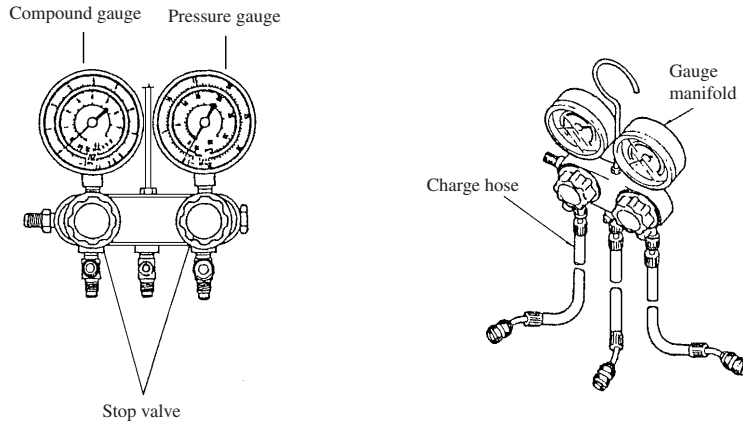

(5) Tube piercing valve

- A tool used to make a hole for recovery in the copper pipe when recovering R410A from equipment which has no port for charging or recovering gas. Various types are available on the market and given various names.
- As the piercing edge tends to wear, it is necessary to treat this valve as semi-expendables.
- As vacuum rises, air tends to be inhaled from the hole. So, care must be exercised.

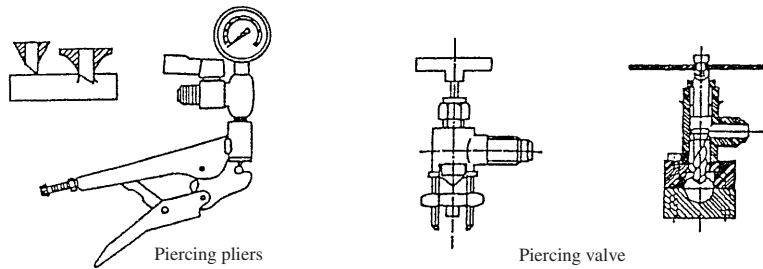

(6) Vacuum pump

Used to evacuate the recovering equipment and recovering cylinder.

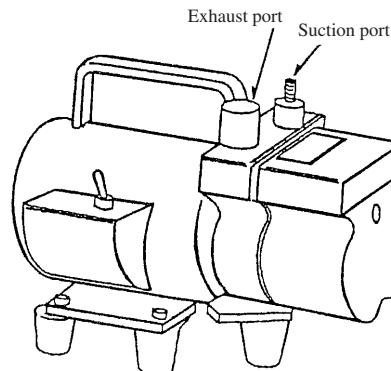

INVERTER WALL MOUNTED TYPE ROOM AIR-CONDITIONER



Air-Conditioning & Refrigeration Systems Headquarters
16-5, 2-chome, Kounan, Minato-ku, Tokyo, 108-8215, Japan
Fax : (03) 6716-5926