

Introduction to Chinese Herbology

Created by

Bob Damone, M.S., L.Ac. and
Todd Luger, B.S., M.Ac.O.M., L.Ac.

acknowledgements

The contents of this reader are based upon the organization of the PCOM syllabus and are derived from both the required and recommended resources listed on this page. The Online Reader has many hot links to other Internet based resources. The reader also has audio files of chinese herb names. To hear the sound with a file, just click on the arrow under the characters, if present (Explorer only). Syllabi, study questions and other materials can be found on the [secure PCOM server](#).

The primary sources for the reader are listed below.

Chinese Herbal Medicine: Materia Medica, Bensky, Clavey and Stoger, Eastland Press, 2004. (BC)

Fundamentals of Chinese Medicine, Wiseman and Ellis, Paradigm Publications. Brookline: 1995. (WE)

Flow Charts - All flow charts and diagrams were produced by Bob Damone

Chinese Herbal Medicine: Formulas and Strategies, Bensky and Barolet, Eastland Press, 1990.

Dui Yao, Sionneau, Blue Poppy Press, 1997

Pao Zhi, Flaws, Blue Poppy Press, 1995

A Practical Dictionary of Chinese Medicine, Wiseman and Ye, Paradigm Publications, 1998

The Illustrated Chinese Materia Medica, Yen, Taipei, 1992 - source for reader photos

[Wenlin Software for Learning Chinese](#) - source for reader sounds

All web authoring was done by Todd Luger

History of Chinese Herbal Medicine

- Chinese medicine has its historical roots in three different traditions
 - Demonology-
 - Disease caused by evil spirits
 - Treatment lies in influencing spirit world through incantations, spells, preparation of charms, dances, etc.
 - Magic Correspondence
 - Disease caused by magical relationships among phenomena
 - Treatment lies in using these magical relationships to one's own advantage
 - Ex: use a venomous animal's natural enemy to counter its poison
 - Systematic Correspondence
 - Disease caused by unhealthy relationship with nature
 - Treatment lies in establishing balance with nature
 - Yin/yang and five phases

History of Chinese Herbal Medicine

- Major texts and their contributions
 - Formulas for Fifty-two Diseases (*Wu Shi Er Bing Fang*, 2nd century B.C.E.)
 - Pharmacy text unearthed at Ma Wang Dui in 1973
 - The text itself dates from before the second century B.C.E
 - Clearly reflects the influence of demonology and magic correspondence on early Chinese medicine
 - Yellow Emperor's Canon of Internal Medicine (*Huang Di Nei Jing*, Later Han 25- 220 C.E.)
 - Based on naturalistic observation rather than shamanism or magic
 - Medicine based on natural rules and relationships of nature
 - The spirit world was stressed less and the readily seen, observed, and understood world stressed more.
 - Philosophy of Chinese medicine laid down
 - Only 12 prescriptions and 28 individual medicinals mentioned; not a major work specific to the field of Herbology
 - However, prescriptions mentioned are based on organization of tastes, mentioned in chapter 22 of the *Su Wen*, (see BG, p. 4, 5 lines from bottom for quote) [more resources](#)

History of Chinese Herbal Medicine

- Shen Nong's Classic of the Materia Medica (*Shen Nong Ben Cao Jing*, Later Han Dynasty, 100 C.E.)
 - Legendary author-*Shen Nong* introduced agriculture, animal husbandry, tasted "the hundred herbs." He is the legendary patron of herbal medicine
 - Edited and reconstructed from several editions by Tao Hong Jing 452-536 CE), somewhere between 492 and 500 CE.
 - Divides herbs into three basic categories, 364 medicinals in total, about 1/2 of which were mentioned in *Wu Shi Er Bing Fang*
 - a. Superior- nourishes life, correspond to heaven, nontoxic
 - b. Neutral- cultivates personality or modifies temperament, may be toxic, may be used to treat disease
 - c. Inferior- specifically treat disease or severe symptoms short term, usually somewhat toxic
 - Mentions taste and temperature for each herb and carefully notes toxicity (Du), and medicinal effects. (Quote BG, p. 5 inset lower page for Ren Shen)
 - Medicinals act because they have certain properties that can be perceived with the normal senses not because they have a particular magical component or spiritual power. Clearly a more rational approach overall. However, about 15% were used for chasing away demons.

History of Chinese Herbal Medicine

- *Shang Han Lun and the Jin Gui Yao Lue* (On Cold Damage and The Classic of Prescriptions from the Golden Chamber, 200 B.C.E.-200 C.E.)
 - Most celebrated classics of medicinal prescriptions (103 Px. in *Shang Han Lun*), authored by Zhang Zhong Jing later edited by Wang Shu He
 - Introduced the six channel pattern identification for the diagnosis and treatment of diseases caused by exterior wind and cold
 - Zhang identified the diagnosis with an herbal formula, i.e., Gui Zhi Tang Pattern
 - Major source of prescriptions. 20% of the prescriptions in Bensky text are from these texts

History of Chinese Herbal Medicine

- Period of great development of the Ben Cao Tradition ensued
- The Grand Materia Medica (*Ben Cao Gang Mu*, 17th century C.E.)
 - The life work of Li Shi Zhen
 - Vast work in many volumes
 - Collected information from all over the empire
- The Great Dictionary of Chinese Medicinals (*Zhong Yao Da Ci Dian*, 1977)
 - Contains entries for 5,767 medicinal substances

Introduction to Chinese Medicinals

■ Nomenclature

- Pinyin
- Latin pharmaceutical - plant parts

■ The Four Temperatures 四气

- Hot, Cold, Warm, Cool, Neutral qualifications used include slightly cold and slightly warm
- Vary somewhat from text
- Opposite temperature is used to treat disease

?

What do Professional Chinese Herbalists Need to Know About Each Herb They Use?

?

1. Temperature
 2. Flavor
 3. Entering Channels
 4. Therapeutic Category
 5. Specific Functions
 6. Specific Signs and Symptoms it Treats
 7. Appropriate Combinations and Formulas
- ...

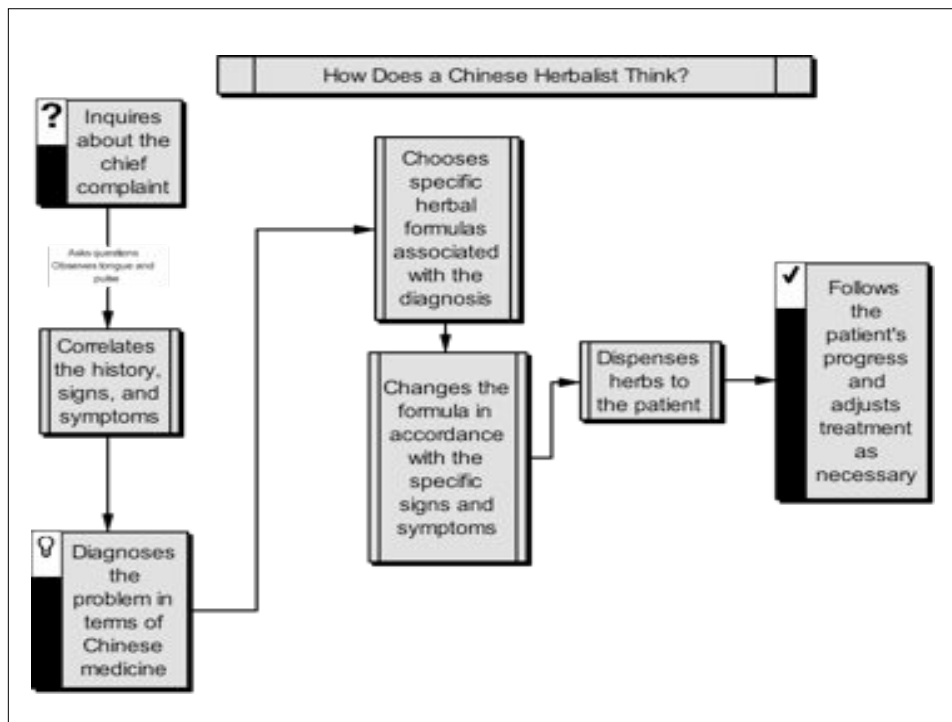

The Five Tastes 五味

- Acrid- scatters, moves Qi and blood, break up accumulations, upbears (Yang). Used for exterior disorders and obstruction of qi and blood
- Sweet- supplements and augments or boosts, harmonizes the middle, relieves pain and spasms, generates fluids. Used for various vacuity conditions
- Sour- astringes, prevents loss of qi and fluids, secures astriction, and stops perspiration. Used for Vacuity perspiration, vacuity diarrhea
- Bitter- draining, drying, opens channels, descends, harmonizing. Used for bound stool due to binding of heat. Damp conditions
- Salty- softens accumulations, purges, and laxative, descends
- *Astringent- similar usage to the sour flavor stores or retains Essence, stops diarrhea, stops hemorrhage
- *Aromatic- disencumbers the spleen and transforms dampness, opens the orifices (not really a taste?)
- *Bland- disinhibits Dampness, percolates dampness, fluids. Used for edema, inhibited urination

- It is important to note that the four temperatures and the five tastes must be integrated in practice; they do not stand alone.
- Examples
 - bitter and cold medicinals
 - bitter and warm medicinals
 - bitter and acrid medicinals
- Medicinals with the combined qi and tastes of sweet and cold and sweet and warm are used for different purposes.

Upbearing, Downbearing, Floating, and Sinking 升降浮沉

- Sheng- upbearing (ascends), often are acrid, sweet, warm, and hot; ex: raise yang
- Jiang- downbearing (descends), often are sour, bitter, salty, cold, and cool; ex: laxative, sedative
- Fu- floats; ex: resolves the exterior (overlaps with upbearing)
- Chen- sinks, drains and disinhibits, ex: diuretic (overlaps with downbearing)

Upbearing, Downbearing, Floating, and Sinking 升降浮沉

- **Examples**
- For vomiting and coughing, dyspnea, etc. we don't use floating medicinals but sinking ones
- For diarrhea, flooding and leaking, center qi fall avoid downbearing too heavily
- For resting perspiration and thief perspiration avoid floating medicinals
- For unresolved exterior diseases avoid sinking
- **Note:** One medicinal may be both upbearing and downbearing

Staying and Moving

- The effects of some medicinals are more static and less dynamic; they remain or “stay” in one region
 - Examples: Gan Jiang (Zingiberis Radix) and Rou Gui (Cinnamomi Cortex)
- The effects of other medicinals are more dynamic and active; they “move” through different regions or activate movement of qi and/or blood and fluids, etc.
 - Examples: Sheng Jiang (Zingiberis Rhizoma recens), Gui Zhi (Cinnamomi Ramulus)

Entering channels

- First applied around 1100 CE
- Further refined to describe substances able to guide other herbs to particular organs and regions of the body
- Refers to either the organ function or the course of the channel
- Represents a link between the herbal tradition and the acumoxa tradition

Functions and Categories

- Developed out of combining a medicinal's qi and taste and empirical clinical experience with TCM theory
- Our focus is mostly in this area.
 - Functions: actions
 - Indications: symptoms/signs
 - Pattern explained by pathomechanisms, etiology
 - Treatment principles derived from patterns
 - Herb categories correlated with treatment principles

Functions and Categories

- Ten major groups with basic qualities (8 classic plus settle and secure)
 - sweating
 - emesis
 - purgation
 - harmonization
 - clearing/cooling
 - warming
 - supplementing
 - reducing/draining
 - settling
 - securing

Pao Zhi 炮制

- Pao Zhi is a general term for defining a group of methods of preparing the medicinals in the Materia Medica. There are two general terms used in Chinese:
 - a.) Sheng (生) - uncooked, but not crude or fresh. May involve special preparation methods that do not involve cooking or heating
 - b.) Shu (熟) - involves cooking or heating
- Objectives of Pao Zhi methods (For specific examples see Sionneau, pp.8-9)
 - a.) Lessening toxicity
 - b.) Modifying the energetic properties (Qi, flavor, action)
 - c.) Reinforcing therapeutic effects
 - d.) Modifying the tropism
 - e.) Dissipating disagreeable odors or flavors
 - f.) Facilitating storage, pharmaceutical production, and assimilation
 - g.) Washing and eliminating foreign, non-medicinal substances

Specific Pao Zhi methods and their purposes

- 1) Mechanical methods- cutting, slicing, scraping, sifting, pulverizing, defatting
- 2) Using water- rinsing and washing, moistening, soaking, Aqueous Triturating
- 3) Using fire- cooking, steaming, baking, steaming, roasting, charring, etc.

Pao Zhi Methods Using Fire

- 1) Chao - Stir - Frying-
 - A) Reinforce inherent actions, lessen toxicity, awakens the spleen
 - B) With or without dry adjuncts- bran, rice, etc.
- 2) Zhi - mix-frying with liquid adjuvants
 - A) Honey- moistening, supplementing
 - B) Wine- clear channels, wind, pain, upbearing
 - C) Vinegar- quickens blood, astringes
 - D) Ginger juice- reduces counterflow-producing tendencies in stomach, floats and disperses
- 3) Duan- calcining or high temperature baking
 - A) Makes it brittle and easier to pulverize, reduces acidity,
 - B) Enhances astringent action
- 4) Pao
 - A) High temperature frying until dark brown can stop bleeding, toxicity, and moderates harshness

Pao Zhi Methods Using both water and fire

- Steaming, Zheng- modifies nature or property, lessens toxicity,
- Scalding (Dan Fa)- eliminates non-medicinal parts, facilitates storage and drying

Contraindications of Medicinals

- According to Traditional Theory and Experience
 - Pregnancy
 - Qi and taste runs counter to therapeutic goals
 - Qi and taste may damage the correct
- Drug/Herb interactions - basic ideas
 - a) don't take any herbs and drugs at the same time
 - b) don't combine herbs and drugs with similar effects
 - c) keep abreast of documented drug/herb interactions via Medline, etc.
- Toxicity – Aristolochic Acid, ban xia, fu zi

Typical Forms of Administration

- Tang 汤
 - a. The most common method today
 - b. Readily absorbed
 - c. Most appropriate to acute disorders
 - d. Most easily tailored to individual
 - e. No aluminum, non-metal best, or coated
 - f. Mention variations on this in modern times as in powder extracts.
 - g. Mention issues with extractable components - re: pharmacognosy
 - h. Discuss drafts (Zhu san) as alternative (see san)
 - i. Cooking times for light and heavy herbs

Typical Forms of Administration

- San 散
 - a. Between tang and wan in terms of strength
 - b. Watch dosage in formula text
- Wan 丸
 - a. Preparation
 - b. Mild in terms of action and speed of effect, for long-term use usually
 - c. Nowadays concentrates are used which change things somewhat
- Jiu 酒
 - a. Steeped in wine, maybe with heat
 - b. Usually for wind-dampness, vacuity conditions, cold
 - c. Tinctures and issues in herb preparation and delivery methods.

Double-click to start, Single click to stop

Herb Forms Movie



Dosage

- Textbook range - daily decoction, if not otherwise indicated
 - For our purposes:
 - Low dosage range: 1-5 grams
 - Medium dosage range: 6-15 grams
 - High dosage range: 15- 30 grams or more
- Traditional formularies may list dosages appropriate for pills or powders
 - Must make adjustments for decoction
- Modern products, pharmacology, active ingredients, comparative analysis, unanswered questions

Principles of Herb Combining;
Polypharmaceutics; Traditional Synergistics

- Chinese herbs mostly used in combination
- There are several methods of combining herbs to produce a desired clinical result.
- These methods of combination were laid out in the Shen Nong Ben Cao Jing.

Principles of Herb Combining;
Polypharmaceutics; Traditional Synergistics

- 1. Mutual Accentuation (xiang xu 相须) two or more herbs with *similar* functions may be used together to achieve a single therapeutic goal, (i.e. Da Huang & Mang Xiao)
- 2. Mutual Enhancement (xiang shi 相使) Two or more herbs with *different* functions may be combined to reach a therapeutic goal, (i.e. Huang Qi & Fu Ling, Huang Qin & Da Huang)
- 3. Mutual Counteraction- (xiang wei 相畏) Reduction of toxicity or side effects of one herb by another; emphasis is on the toxic substance i.e. Sheng Ban Xia is counteracted by Sheng Jiang

Principles of Herb Combining;
Polypharmaceutics; Traditional Synergistics

- 4. Mutual Suppression- (xiang sha 相杀) reverse of mutual counteraction. One substance reduces the undesirable side effects of another, but the emphasis is on the substance that performs the action. For example Sheng Jiang suppresses the toxicity of Ban Xia
- 5. Mutual Antagonism- (xiang e 相恶) Two substances may minimize or reduce each other's original therapeutic effects
- 6. Mutual Incompatibility- (xiang fan 相反) Two substances which, when used together causes side effects produced by neither alone
- 7. Single Effect- (dan xing) Use of a single medicinal substance to treat a patient (i.e. use of Ginseng as a single treating Collapse of Qi

Formula Composition; hierarchy of ingredients

- 1) Chief
- Principal ingredients directed towards the primary disease and or s/s being addressed by the formula. Formula often named after it
 - Examples: Gui Zhi in Gui Zhi Tang, Ma Huang in Ma Huang Tang, Zhi Gan Cao in Zhi Gan Cao Tang, Cang Er Zi and Xin Yi Hua in Cang Er Zi San, Shi Gao in Bai Hu Tang
- 2) Deputy
 - 1) Aids the chief
 - 2) Directed towards coexisting pattern, disease or s/s
 - Examples: Gui Zhi and Xing Ren in Ma Huang Tang, Zhi Mu in Bai Hu Tang,

Formula Composition; hierarchy of ingredients

- 3) Assistant
 - 1) Aids the chief and deputy in treating the primary pattern or disease
 - 2) Moderates or eliminates harmful effects of chief or deputy, e.g. Chai Hu and Bai Shao used together
 - 3) Has effect opposite to the chief ingredient for mixed picture diseases, e.g. Huang Lian and Gan Jiang in Ban Xia Xie Xin Tang, Zuo Jin Wan
- 4) Envoy (AKA messenger, guide, courier)
 - 1) Focuses the action of the formula on a given channel or area of the body
 - 2) Harmonizes and integrates the actions of the other ingredients

Formula Modification

- Very Common
- Example: Gui Zhi Jia Hou Po Xing Zi Tang
- Taking Gui Zhi Tang and adding Fang Feng and Xin Yi Hua for nasal congestion, or adding Qiang Huo and Fang Feng to Bu Zhong Yi Qi Tang for wind damp in the upper body combined with spleen qi deficiency and sinking of qi
- Can also subtract an ingredient, as in Yue Ju Wan where you can remove Zhi Zi if the patient lacks heat s/s and has cold s/s
- Can be loosely based on a traditional Px., using the classical Px. as a template and branching off.
- Add an ingredient to base formula and get a completely different action: Yi Tang in Gui Zhi Tang

Release Exterior Medicinals

Flavors: Acrid
Temp: Cool
Channels: Lung

Introduction to Release Exterior Medicinals

- Define Externally Contracted Diseases
 - Wind Cold- Six Channel Pattern Identification
 - 六经辨证 (*liu4 jing1 bian4 zheng4*)
 - Cold damage: Ephedra Decoction (麻黄汤 *ma2 huang2 tang1*)
 - Wind strike: Cinnamon Twig Decoction (桂枝汤 *gui4 zhi1 tang1*)
 - Wind Heat- Four Aspects
 - Defense (卫 *wei4*) : Lonicera and Forsythia Powder (银翘散 *yin2 qiao4 san3*)
 - Qi (气 *qi4*)
 - Construction (营 *ying2*)
 - Blood (血 *xue4*)
- Signs and Symptoms
- Basic Pathomechanisms
- Treatment Principles and Formulas

麻黄 *ma2 huang2* Ephedrae Herba

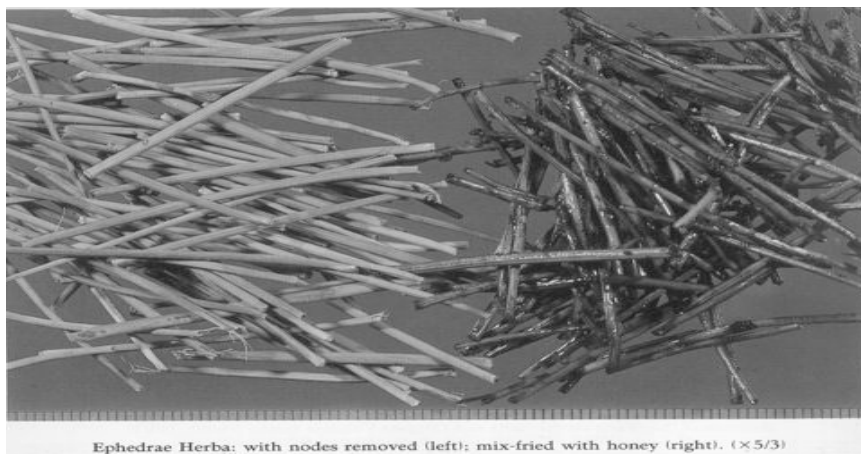

麻黄 *ma2 huang2* Ephedrae Herba

- Induces sweating and releases the exterior - colds
- Disseminates and facilitates lung qi, calms wheezing, stops coughing - asthma
- Promotes urination and reduces edema (due to exterior invasion)
- Warms and disperses cold (wind cold damp) pathogens - bi syndrome
- Cautions and contraindications - hypertension, sweating, vacuity
- Dosage - low to medium

桂枝 *gui4 zhi1*, Cinnamomi Ramulus

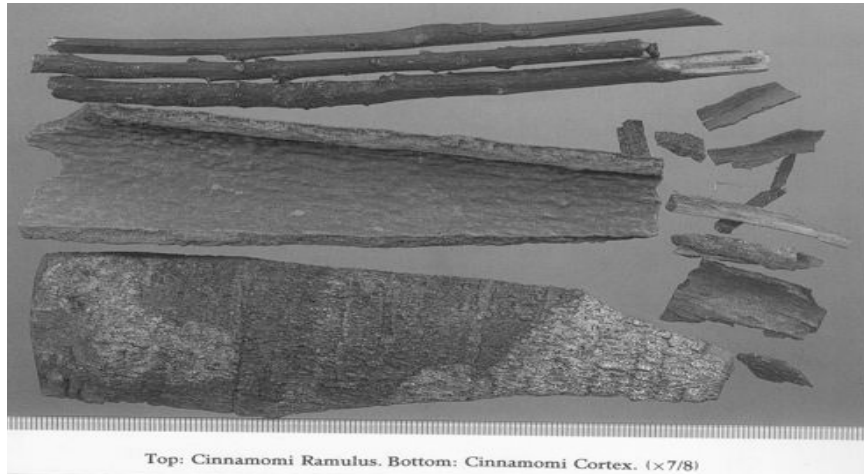

桂枝 *gui4 zhi1*, Cinnamomi Ramulus

- Releases the exterior and assists the yang - wind cold
- Warms and unblocks channels and collaterals - bi syndrome
- Warms yang and transforms thin mucus - edema due to yang vacuity
- Assists heart yang and unblocks yang qi of the chest - chest pain
- Warms the channels, vessels and collaterals - menstrual pain
- Cautions and contraindications - dryness, heat
- Dosage - low to medium

Formula for Cold Damage

- Ephedra Decoction (麻黄汤 *ma2 huang2 tang1*)
- ephedra (麻黄 *ma2 huang2*, Ephedrae Herba)
- cinnamon twig (桂枝 *gui4 zhi1*, Cinnamomi Ramulus)
- apricot kernel (杏仁 *xing4 ren2*, Armeniacae Semen)
- mix-fried licorice (炙甘草 *zhi4 gan1 cao3*, Glycyrrhizae Radix Preparatae)

Formula For Wind Strike

- Cinnamon Twig Decoction (桂枝汤 *gui4 zhi1 tang1*)
- cinnamon twig (桂枝 *gui4 zhi1*, Cinnamomi Ramulus)
- white peony (白芍药 *bai2 shao2 yao4*, Paeoniae Radix Alba)
- fresh ginger (生姜 *sheng1 jiang1*, Zingiberis Rhizoma Recens)
- jujube (大枣 *da4 zao3*, Jujubae Fructus)
- mix-fried licorice (炙甘草 *zhi4 gan1 cao3*, Glycyrrhizae Radix Prep)

薄荷 *bo4 he2*, Menthae Herba



薄荷 *bo4 he2*, Menthae Herba

- Disperses wind heat, clears and benefits the head, eyes and throat
- Vents rashes - unexpressed measles
- Allows constrained liver qi to flow freely
- Cautions and contraindications - sweating, qi vacuity
- Dosage - low

柴胡 *chai2 hu2*, Bupleuri Radix

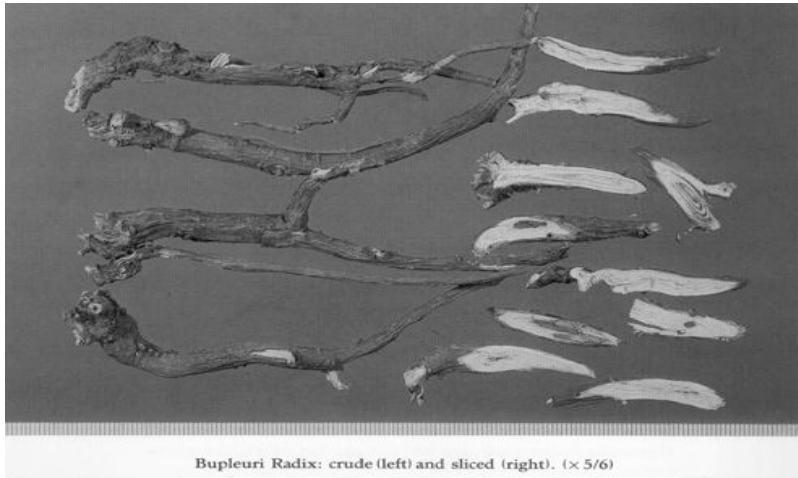

Bupleuri Radix: crude (left) and sliced (right). (× 5/6)

柴胡 *chai2 hu2*, Bupleuri Radix

- Resolves lesser yang disorders and reduces fever - alt chills and fever, ribside pain, nausea, wiry pulse
- Spreads liver qi and relieves constraint - emotions, GI, menses
- Raises the yang qi
- Cautions and contraindications - liver fire or yang rising
- Dosage - low to medium
- Abstracts

Medicinals that Clear Heat and Drain Fire

Flavor: Bitter
Temperature: Cold
Channels: Many

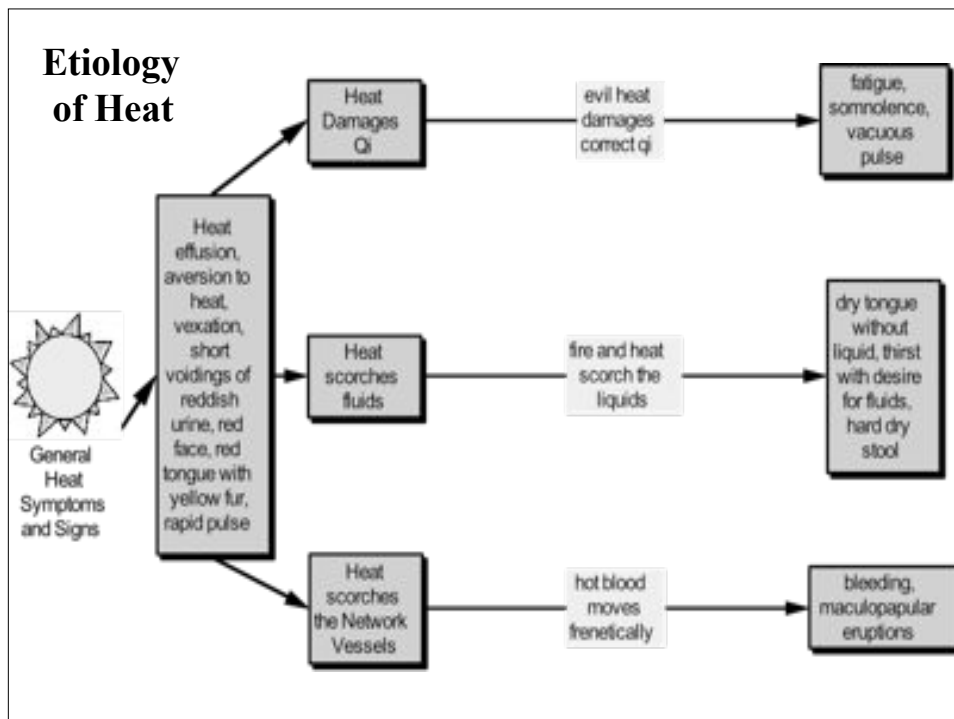

Four Aspects (Wei, Qi, Ying, Xue)

- Review Overall System Briefly
- Establish Basic Definition of Qi4 Aspect Heat
- Formula for Great Heat in the Qi4 Aspect (Not Required)
- White Tiger Decoction (白虎汤 *bái hǔ tāng*)
- gypsum (石膏 *shí gāo*, Gypsum Fibrosum)
- anemarrhena (知母 *zhī mǔ*, Anemarrhenae Rhizoma)
- non-glutinous rice (粳米 *gēng mǐ*, Oryzae Semen)
- mix-fried licorice (炙甘草 *zhì gān cǎo*, Glycyrrhizae Radix Prep)

Qi4 Aspect Heat

- Qi4 Aspect Heat
 - Brief Historical Comments
 - Pathomechanisms
 - Symptoms and Signs: Four Greatnesses 四大 (*sì dà*)
 - heat (fever), thirst, pulse, sweating
 - Medicinals that Clear Heat and Drain Fire
 - 石膏 *shí gāo*, Gypsum Fibrosum
 - 知母 *zhī mǔ*, Anemarrhenae Rhizoma

石膏 *shi2 gao1*, Gypsum Fibrosum

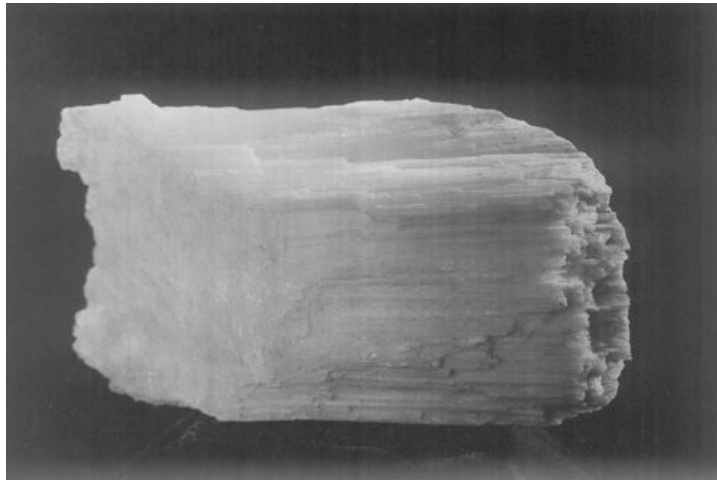

石膏 *shi2 gao1*, Gypsum Fibrosum

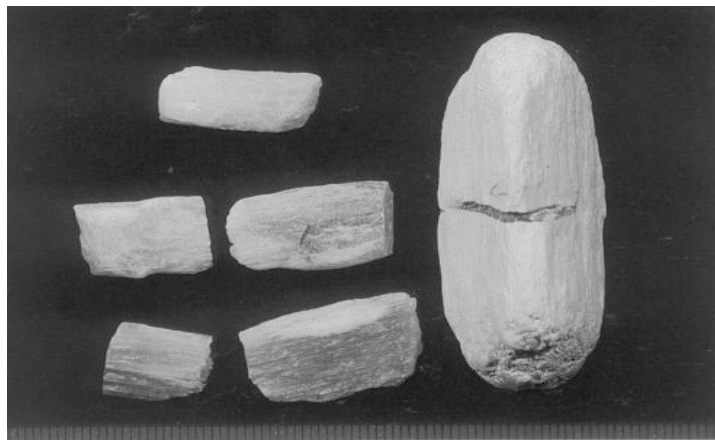

Gypsum Fibrosum: crude (left); calcined (right). (×5/3)

石膏 *shi2 gao1*, Gypsum Fibrosum

- Clears heat and drains fire - qi level heat
- Clears heat from the lungs - cough, sputum
- Clears blazing stomach fire
- Topical use
- Cautions/contraindications: cold vacuity; high dosage

知母 *zhi1 mu3*, Anemarrhenae Rhizoma



知母 *zhi1 mu3*, Anemarrhenae Rhizoma

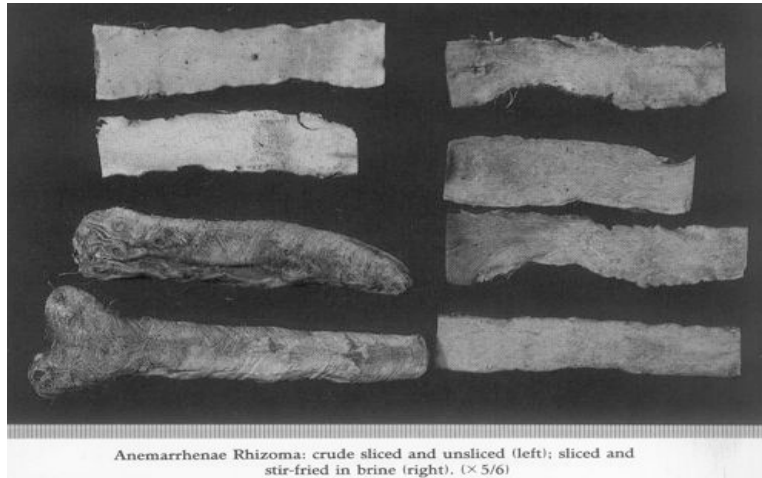

知母 *zhi1 mu3*, Anemarrhenae Rhizoma

- Clears heat and drains fire - qi level heat, lung and stomach heat
- Enriches yin and moistens dryness - heat effusion and nightsweats
- Generates fluids and clears heat - waste and thirsting disease (xiao ke) = late stage type 2 diabetes
- C/C: cold vacuity; medium dosage

Clear Heat and Cool the Blood

Flavor: Bitter

Temperature: cold

Channels: Liver, Heart, Kidney

Four Aspects (Wei, Qi, Ying, Xue)

- Review Overall System Briefly
- Establish Basic Definition of Blood Aspect Heat
- Discuss Blood Aspect Heat as Serious Infectious Disease or Sepsis
- Clinical significance for contemporary practitioner

Blood Aspect Heat

- Blood Aspect Heat
 - Brief Historical References
 - Pathomechanisms
 - Symptoms and Signs

水牛角 *shui3 niu2 jiao3*,



Bubali Cornu

- Clears heat, relieves fire toxin, and cools the blood- heat causes blood to move frenetically
- Clears heat and arrests tremor- extreme heat engenders wind
- Cautions and Contraindications - cold vacuity
- Dosage - high
- The historical species is Endangered! DO NOT USE Use Xi Jiao (Rhinocerotis Cornu)

生地黄 *sheng1 di4 huang2*,
🌀 (Rehmanniae Radix)



生地黄 *sheng1 di4 huang2*,
(Rehmanniae Radix)

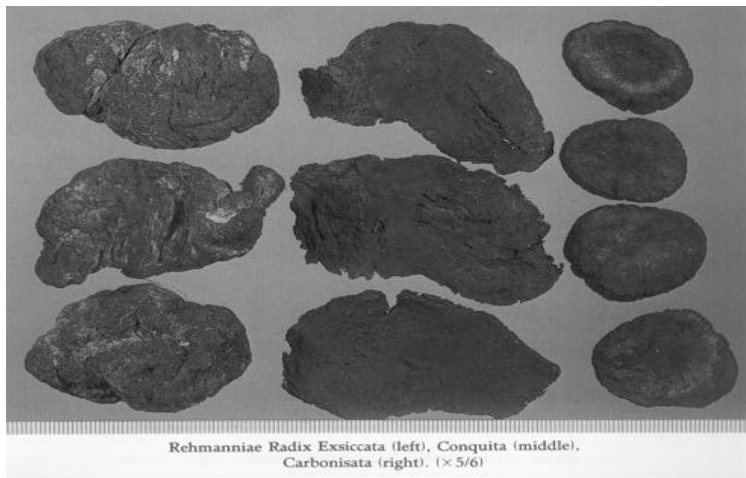

生地黄 *sheng1 di4 huang2*,
Rehmanniae Radix

- Clears heat and cools the blood- heat damages fluids, heat causes blood to move frenetically due to internal or external causes
- Nourishes yin and engenders fluids- fever, waste and thirsting
- Cautions and Contraindications - damp, phlegm
- Dosage- medium

**Medicinals that Clear
Heat and Dry Dampness**

Flavor: bitter

Temperature: cold

Channels: many, esp. yang

Damp Heat Signs and Symptoms

- Etiology
- General signs and symptoms
- Specific Zang Fu Patterns
- Pathomechanisms of Damp Heat Disease
- Treatment Principles

The Three Yellows 三黄

- 黄芩 *huang2 qin2*, Scutellariae Radix
- 黄连 *huang2 lian2*, Coptidis Rhizoma
- 黄柏 *huang2 bai3*, Phellodendri Cortex
- Similarities and differences
- Areas of action
- Cautions and contraindications - spleen/stomach vacuity cold for all

黄芩 *huang2 qin2*, *Scutellariae*
Radix



黄芩 *huang2 qin2*, *Scutellariae*
Radix

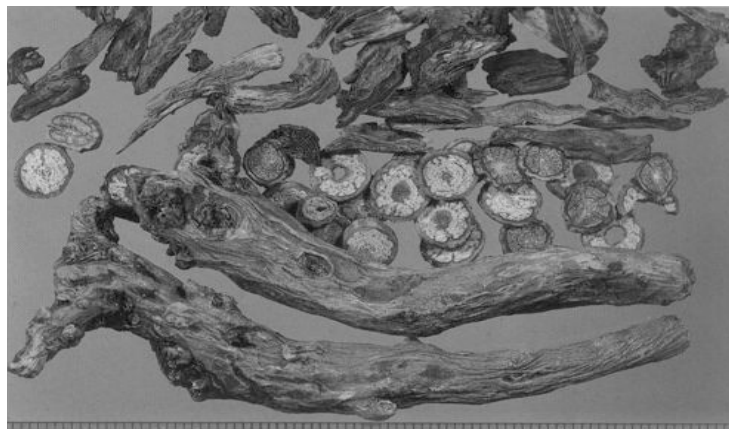

Scutellariae Radix: sliced and stir-fried in wine (top); crude slices (middle);
crude (bottom). (× 5/3)

黄芩 *huang2 qin2*, Scutellariae Radix

- Clears heat and dries dampness - GI diseases
- Clears heat and resolves toxicity - lung infections, skin lesions
- Clears heat and stops bleeding - heat stirs blood
- Clears heat and calms the fetus - heat stirs fetus
- Sedates ascendant liver yang - heat causes yang to rise
- C/C, dosage low to medium, abstracts

黄连 *huang2 lian2*, Coptidis Rhizoma



黄连 *huang2 lian2*, Coptidis Rhizoma

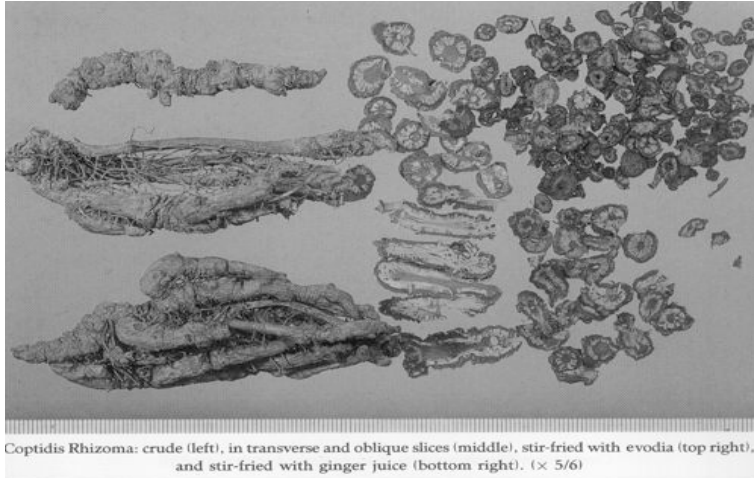

黄连 *huang2 lian2*, Coptidis Rhizoma

- Clears heat and drains dampness - GI disease
- Drains fire and resolves fire toxicity - upper body spirit or mouth symptoms, also skin lesions
- Clears heat and stops bleeding
- Clears heat topically
- Dosage - low to medium



黄柏
huang2 bai3,
Phellodendri
Cortex



黄柏 *huang2 bai3*, Phellodendri Cortex

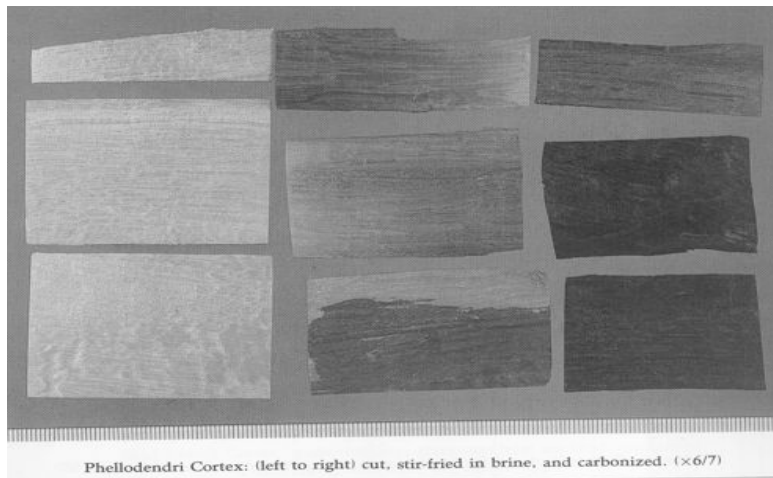

黄柏 *huang2 bai3*, Phellodendri Cortex

- Drains damp heat - lower jiao
- Drains kidney fire - vacuity fire
- Drains fire and resolves fire toxicity - skin
- Cautions/Contra - spleen vacuity
- Dosage - low to medium

**Medicinals that Clear
Heat and Toxin**

Flavor: bitter

Temperature: cold

Channels: many

热毒 *re4 du2*, heat toxin

- Definition in TCM (Wiseman and Ye)
- Pathomechanisms
 - Depressed heat
 - Heat toxin
 - Blood stasis
 - Swelling
 - Rotting of the flesh
- Redness, swelling, pain, pus
 - 痈 *yong1*: welling-abscess
 - 外痈 *wai4 yong1*, external welling-abscess
 - 内痈 *nei4 yong1*, internal welling-abscess

Huang Lian Jie Du Tang

Coptis Decoction to Relieve Toxicity

- 黄芩 *huang2 qin2*, Scutellariae Radix
- 黄连 *huang2 lian2*, Coptidis Rhizoma
- 黄柏 *huang2 bai3*, Phellodendri Cortex
- 山栀子 *shan1 zhi1 zi3*, Gardeniae Fructus

金银花 *jin1 yin2 hua1* 

Lonicerae Flos



金银花 *jin1 yin2 hua1*, **Lonicerae Flos**

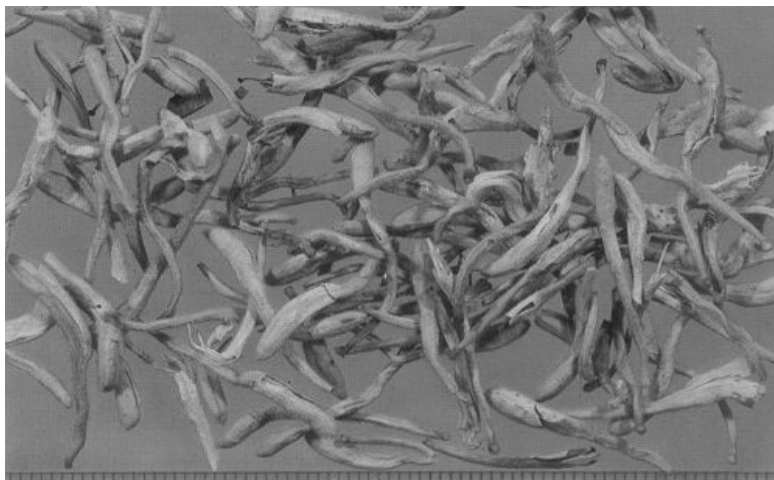

金银花 *jin1 yin2 hua1*, Lonicerae Flos

- Clears heat and resolves fire toxicity - throat, intestines, breast, eyes, skin
- Vents and disperses externally contracted wind heat - sore throat, headache
- Clears damp heat from the lower burner- damp heat dysentery, heat Strangury
- Dosage - medium to high C/C: none

连翘 *lian2 qiao2*, Forsythiae Fructus



连翘 *lian2 qiao2*, **Forsythiae Fructus**

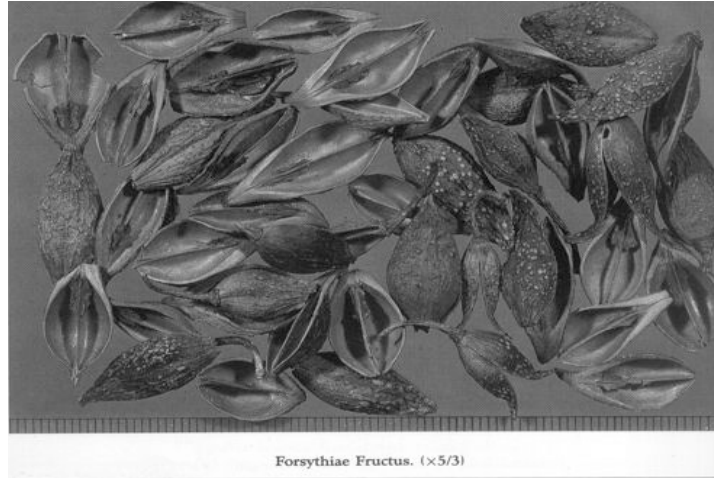

连翘 *lian2 qiao2*, **Forsythiae Fructus**

- Clears heat and resolves toxicity - wind heat and skin lesions
- Reduces abscesses and dissipates clumps
- Cautions and Contraindications
 - None at normal dosage , which is medium

Yin Qiao San 银翘散

- Releases exterior, clears heat
- Used for wind heat
- Esp. in throat conditions and fever
- Includes lian qiao, jin yin hua, bo he and gan cao - all used for sore throat

85

Medicinals that Clear Deficiency Heat

Flavor: bitter

Temperature: cold

Channels: many

Medicinals that Drain Dampness

Flavor: bland, bitter

Temperature: neutral to cold

Channels: spleen, kidney, bladder

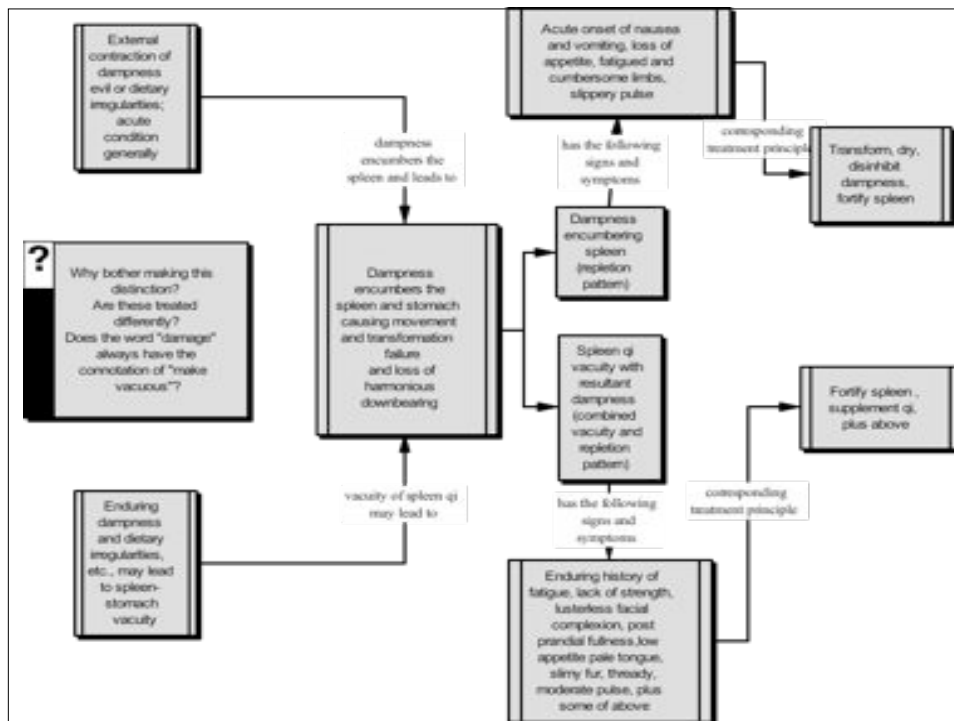

茯苓 *fu2 ling2*, Poria

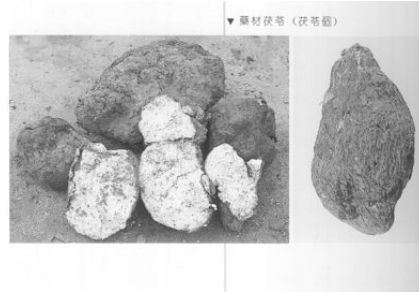

茯苓 *fu2 ling2*, Poria

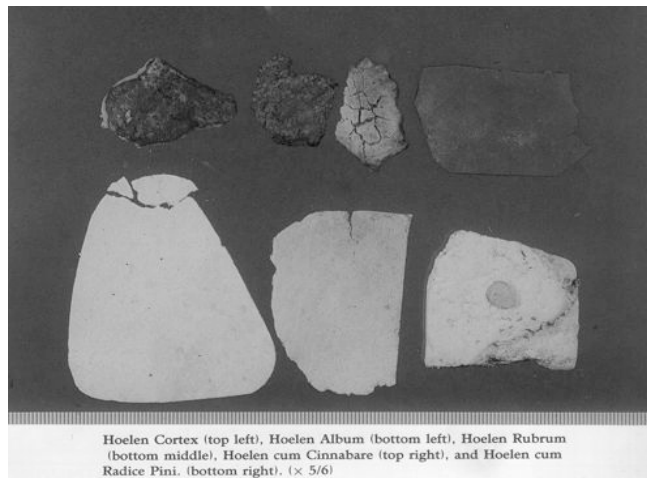

茯苓 *fu2 ling2*, Poria

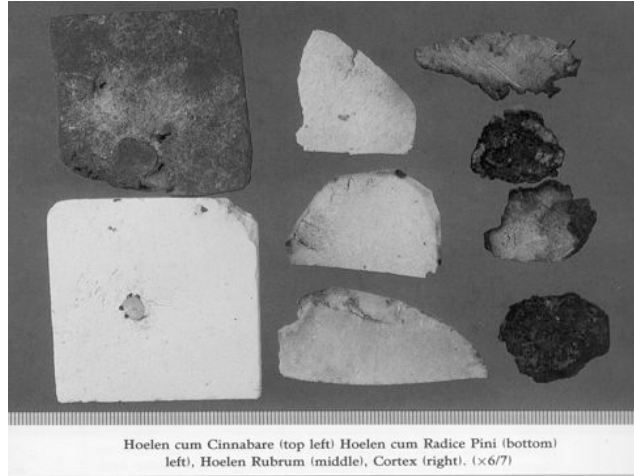

茯苓 *fu2 ling2*, Poria

- Promotes urination and leeches out dampness- external and internal
- Strengthens the spleen and harmonizes the middle burner- splenic TT failure
- Strengthens the spleen and transforms phlegm- lung, stomach
- Quiets the heart and calms the spirit- palpitations, insomnia
- Cautions and contraindications - yin vacuity, sinking qi
- Dosage- medium

Aromatic Medicinals that Transform Dampness

Flavor: acrid, aromatic, bitter
Temperature: warm
Channels: spleen, stomach

厚朴 Hou4 Po4 Magnoliae Officinalis Cx

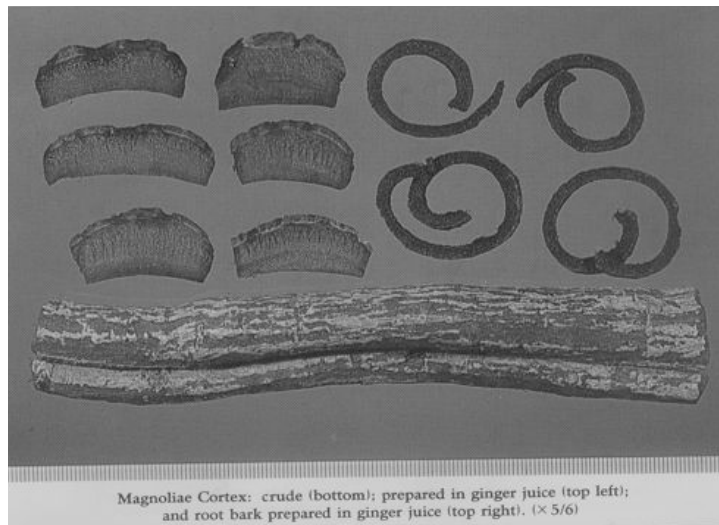

Hou Po
Magnoliae Officinalis Cortex

- Promotes movement of qi in the middle burner, transforms dampness, and resolves stagnation-dampness obstructing Sp/St, food stagnation
- Promotes the movement of Qi downward, dries dampness and transforms phlegm - cough and wheeze, bloating, GI
- Cautions and contraindications- pregnancy
- Dosage- low to medium

Ping Wei San 平胃散

- Hou Po/magnolia officinalis cx
- Cang Zhu/atractylodis rz.
- Chen Pi/citri reticulatae pericarpium
- Gan Cao/glycyrrhizae rx
- Sheng jiang/zingiberis rz recens

- Basic formula for all cold damp diseases

Herbs that Dispel Wind Damp

- Flavor: Acrid
- Temp: Warm
- Channels: many, esp. yang
- C/C: yin xu, qi xu, dryness

97

独活 **Du2 Huo2** **Angelicae Pubescentis Radix**

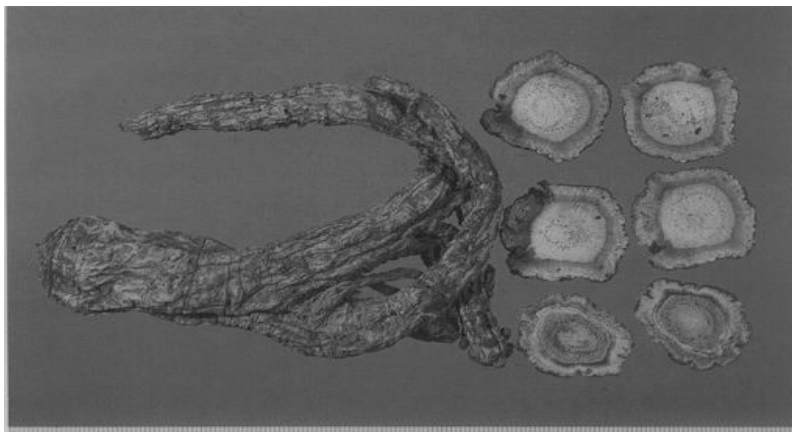

Angelicae Laxiflorae Radix: crude (left) and sliced (right). (× 5/6)

Du Huo
Angelicae Pubescentis Radix

- Dispels wind dampness and alleviates pain-guiding herb for lower back and legs - acrid flavor
- Disperses wind cold dampness and releases the exterior- external contraction with body pain
- Shao Yin channel headache and toothache-channel theory connection to throat and tongue
- Cautions and contraindications- dryness, wind
- Dosage- low to medium

**Herbs and Formulas
that Regulate Qi**

Flavor: acrid

Temperature: warm

Channels: spleen, stomach, lung

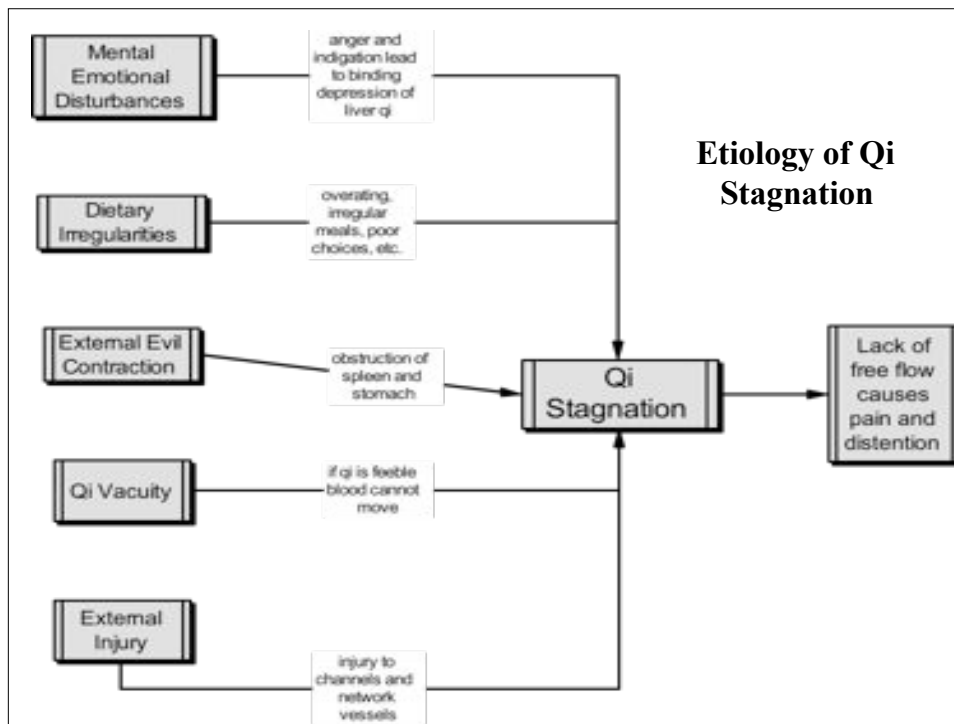

陈皮 **Chen2 Pi2**

Citri Reticulatae Pericarpium

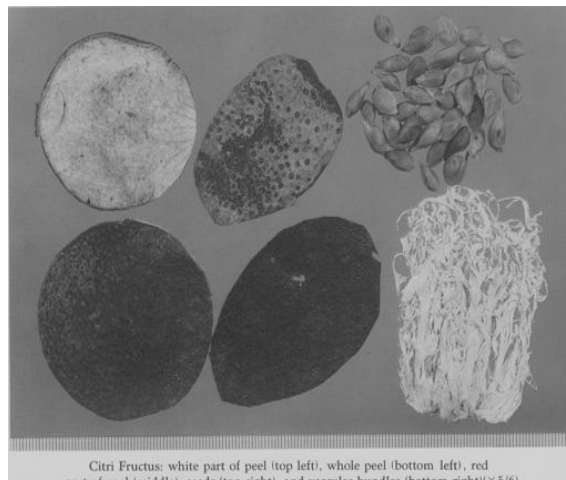

Citri Fructus: white part of peel (top left), whole peel (bottom left), red part of peel (middle), seeds (top right), and vascular bundles (bottom right)(x5/6)

Chen Pi

Citri Reticulatae Pericarpium

- Regulates qi, adjusts the middle, and relieves the diaphragm - digestive sx
- Dries dampness and transforms phlegm - cough and GI sx
- Prevents stagnation - combined with tonics
- Dosage - low to medium
- C/C: qi and yin vacuity, heat repletion

Herbs that Relieve Food Stagnation

- Define Food Stagnation
 - Discuss etiology & Pathomechanisms
- Identify Two Types of Food Stagnation
 - Mild Case- Food Damage
 - Treatment principle- dissolve and conduct out food- Shan Zha
 - Severe Case- GI Accumulation
 - Attack and purge using offensive precipitants- Da Huang
- Flavor: sweet
- Temperature: warm
- Channels: spleen and stomach

山楂 *Shan1 Zha1*
Crataegi Fructus



Crataegi Fructus: crude (left); charred (right). (x 5/3)

Shan Zha
Crataegi Fructus

- Reduces food stagnation and transforms accumulations - meat and greasy foods
- Transforms blood stasis and dissipates clumps - chest and abdominal pain
- Stops diarrhea- when charred
- Empirical use- coronary artery disease, hypercholesterolemia, hypertension

Downward Draining Medicinals

Downward Draining Medicinals

- Three different types under this heading
 - All enter LI channel

 - Attacking and Purging- Da Huang
 - Bitter, cold
 - Draining Fire- GI heat bind, heat toxin, depressed upper body fire

 - Moist lubricants, emollients- Huo Ma Ren
 - Sweet, neutral

 - Cathartics- Gan Sui
 - Bitter, cold - Expelling water rheum, Attacking phlegm

大黄 Da4 Huang2 
Rhei Radix et Rhizoma

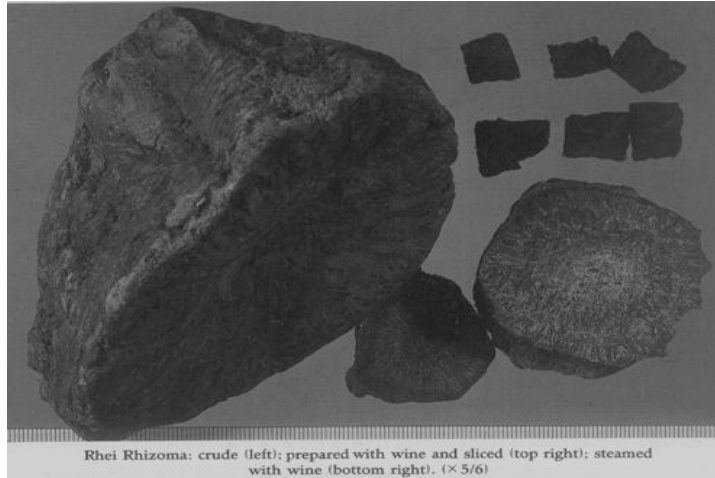

Da Huang (Rhei Radix et Rhizoma)

- Drains heat and purges accumulations-GI heat bind of qi aspect, yang ming bowel fever
- Drains fire - upper body sx
- Clears heat, transforms damp, promotes urination - strangury, dysentery
- Invigorates blood and dispels stasis- trauma,
- Clears heat and reduces fire toxin - skin lesions
- Cautions and Contraindications - qi vacuity, pregnancy
- Dosage and cooking time

火麻仁 **Huo3 Ma2 Ren2**
Cannabis Semen

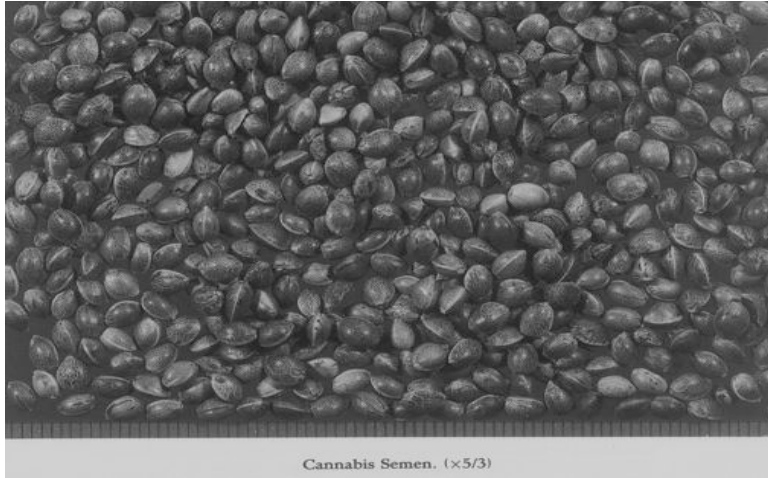

Huo Ma Ren (Cannabis Semen)

- Nourishes and moistens intestines-elderly, post partum women, chronically ill, aftermath of heat disease
- Nourishes yin- Yin vacuity with insufficiency of fluids to moisten intestines
- Clears heat and promotes healing of sores- nourishes the skin
- Cautions and contraindications - n/v, diarrhea due to moistness
- Dosage

甘遂 *Gan1 Sui4*
Kansui Radix

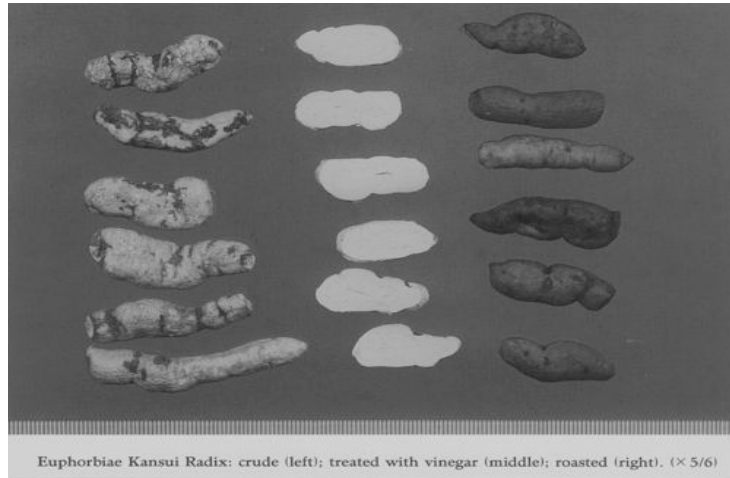

Gan Sui (Kansui Radix)

- Drains water downward and drives out thin mucus - thoracic and abdominal evil water (ascites)
- Drives out phlegm - seizures
- Clears heat and reduces swelling- topical use in dermatology
- Cautions and contraindications

Medicinals that Transform Phlegm

Flavor: acrid

Temperature: warm or cold

Channels: lung

115

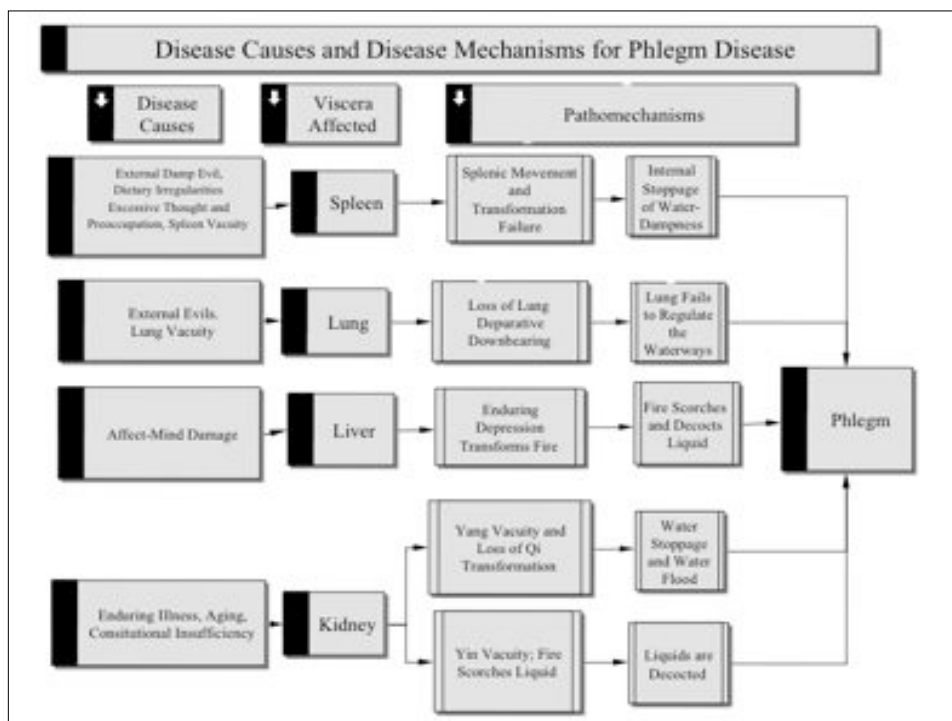

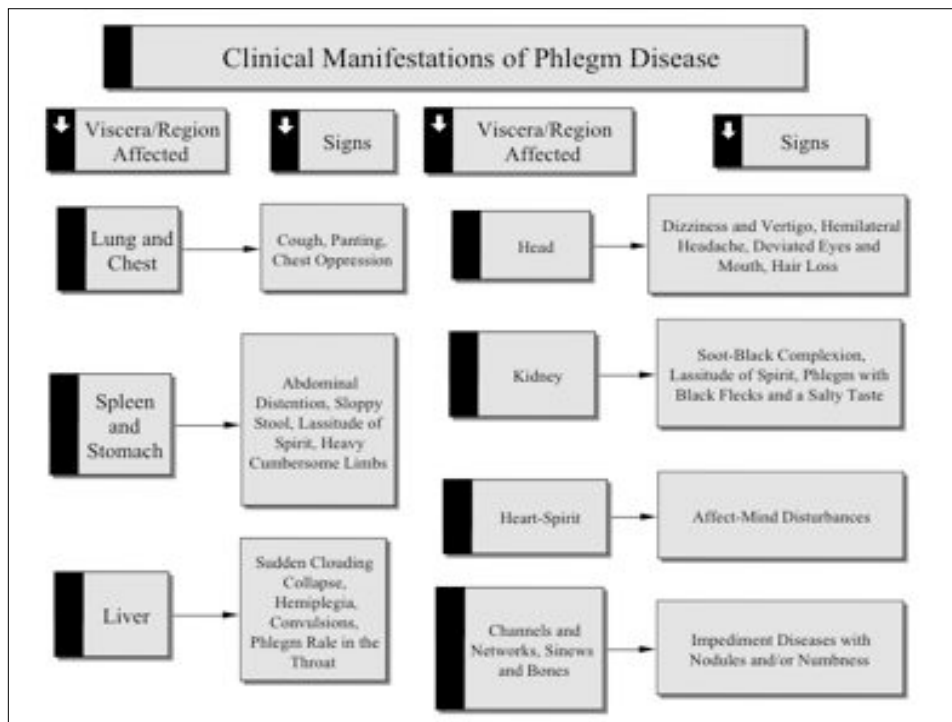

Qian Hu (peucedani rx)

- Directs qi downwards and transforms phlegm - phlegm heat cough
- Disperses and Scatters wind heat - external cough (acidic flavor)
- C/C: yin vacuity, cold damp phlegm
- Dosage - low to medium

Zhi Ban Xia (pinelliae rz prep)

- Dries damp, transforms phlegm, descends rebellious qi - lung dz, spleen damp patterns
- Descends rebellious qi - GI, vomiting
- Dissipates nodules and reduces clumps - phlegm obstruction or lumps anywhere
- C/C: yin vacuity, fire excess, bleeding
- Dosage - low to medium
- Representative Rx: Er Chen Wan

119

Medicinals that Relieve Cough and Wheezing

Flavor: variable

Temperature: variable

Channels: Lung

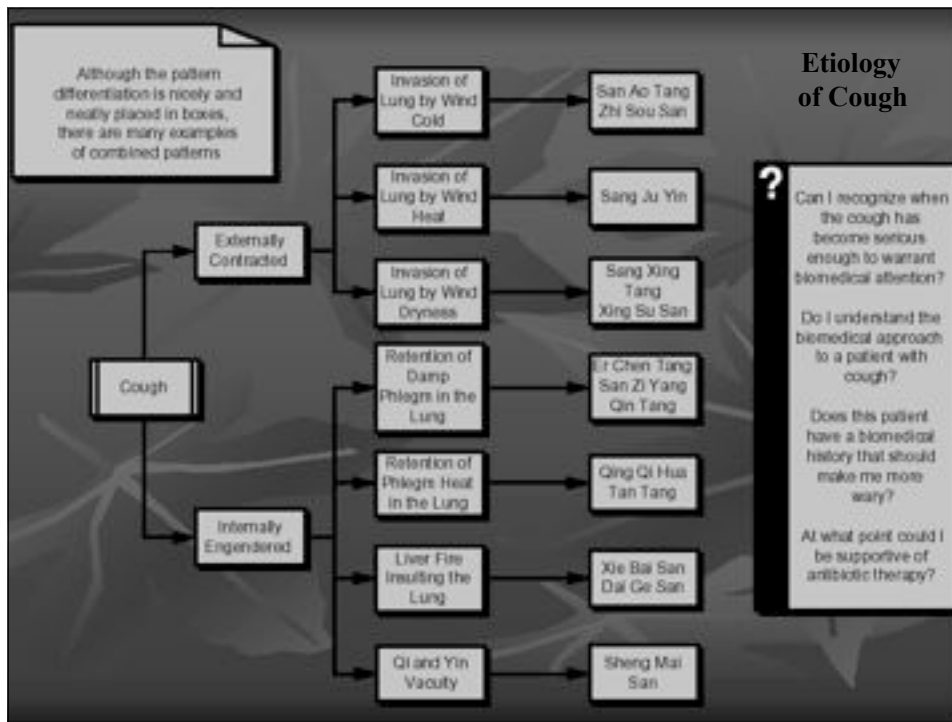

杏仁 Xing4 Ren2 Armeniaca Semen

- Stops coughing and calms wheezing
- Moistens the intestines
- Dosage- low to medium
- C/c: diarrhea, yin vacuity, careful with dose

Four Causes of Bleeding in TCM:

<u>Etiology</u>	<u>Pathomechanism</u>
Heat	Blood moves recklessly
Qi Vacuity	Qi cannot restrain the blood
Stasis	Stasis occupies the network vessels
Trauma	Network vessels are severed

三七 *San1 Qi1*, Notoginseng Radix

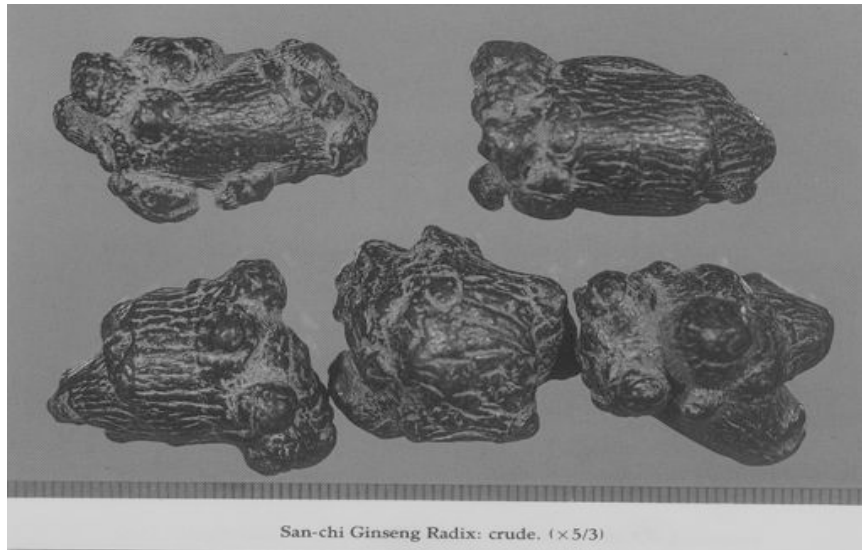

三七

San Qi (Notoginseng Radix)

- **1. Stops bleeding and transforms blood stasis**
- a. Internal bleeding- hematuria, hematemesis, hemafecia, epistaxis
- Also used for bleeding due to blood stasis, since it also quickens the blood
- b. External bleeding- when trauma severs the network vessels and blood escapes
- **2. Reduces swelling and alleviates pain**
- **Dosage - low to medium**
- **C/c: pregnancy**

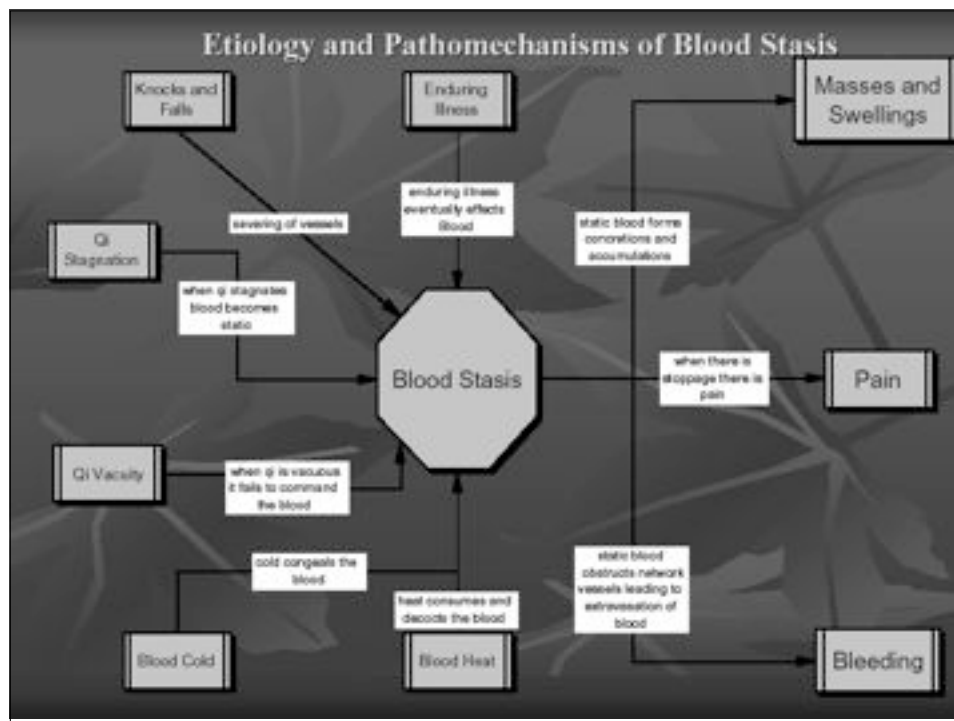

赤芍药 *Chi4 Shao1 Yao4*, *Paeoniae*
Radix Rubra

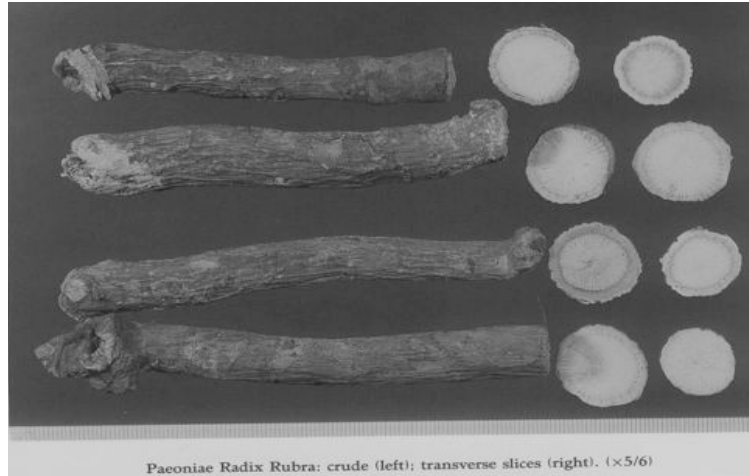

赤芍

Chi Shao (Paeoniae Radix Rubra)

- **1. Invigorates the Blood and Dispels Blood Stasis**
 - a. Gynecological applications
 - b. Traumatic injury
 - c. To help ripen or promote the development of pus
- **2. Clears heat and cools the Blood**
 - a. Blood aspect heat
 - b. Heat induced bleeding
 - c. Gynecological applications- abnormal bleeding disorders when blood moves recklessly due to heat
 - d. Eyes - wind fire eye (conjunctivitis)
- Dosage - medium

川芎 *Chuan1 Xiong1*, *Chuanxiong* Rhizoma

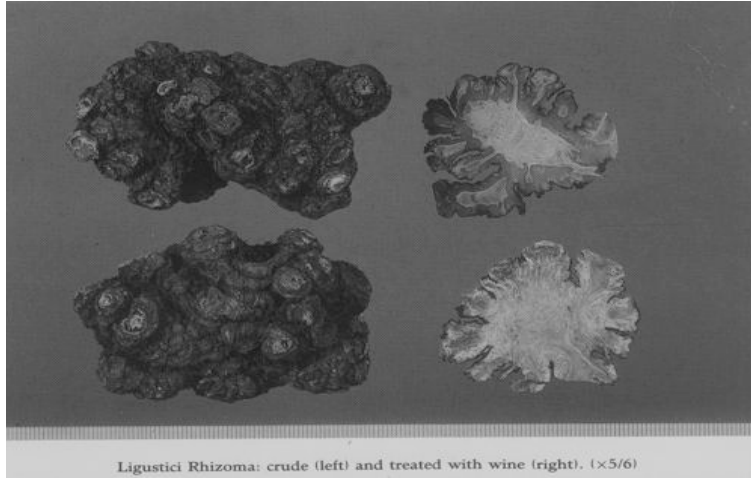

Ligustici Rhizoma: crude (left) and treated with wine (right). (×5/6)

川芎 *Chuan Xiong* (*Chuanxiong* Rhizoma)

- **1. Invigorates blood and promotes movement of qi-**
 - a. Gynecological applications
 - b. Used for combined patterns of qi stagnation and blood stasis
- **2. Expels wind and alleviates pain-**
 - a. Externally contracted wind causing pain-
 - b. Used for impediment (bi zheng)
- Dosage - low to medium
- C/c: liver yang or fire rising

Medicinals that Warm the Interior

Etiology and Pathomechanisms for Cold Disease

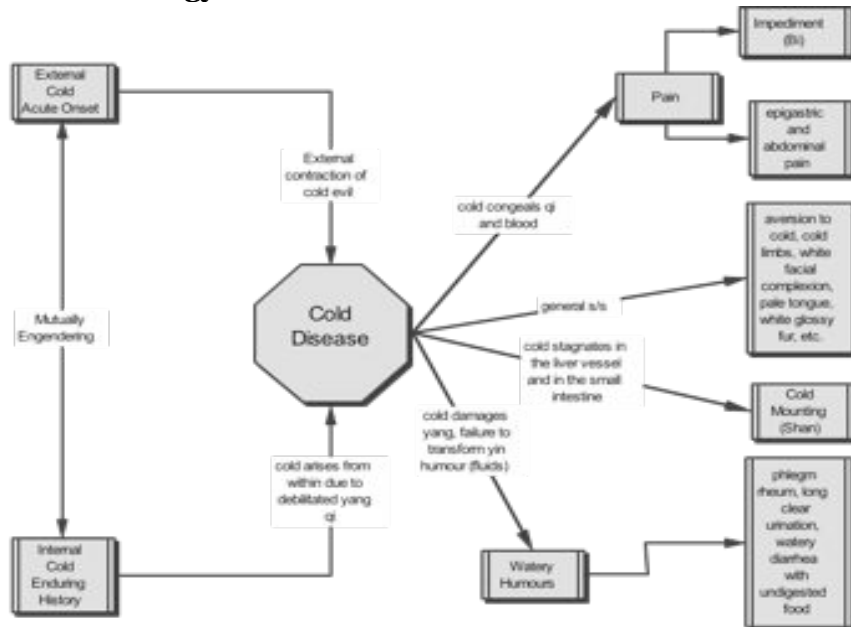

附子 *Zhi Fu Zi*, *Aconiti Radix*
Lateralis Praeparata

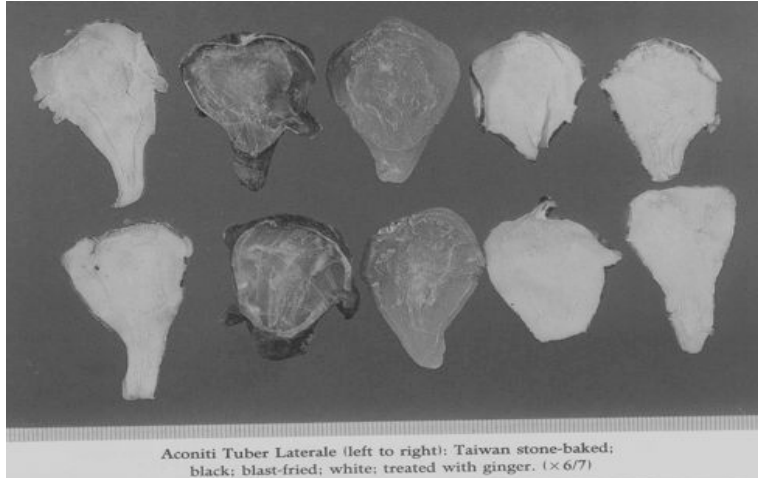

附子 *Zhi Fu Zi*
(*Aconiti Radix Lateralis Praeparata*)

- **Revives the yang and rescues from rebellion**
- Used for devasated yang qi and abundant yin
- **Warms the fire and assists yang**
- Used for yang vacuity patterns in general- Zang Fu involved can be heart, spleen or kidneys
- **Disperses cold, warms the channels, alleviates pain - bi syndrome**
- Dosage - low to medium
- C/c: heat, yin vacuity, pregnancy

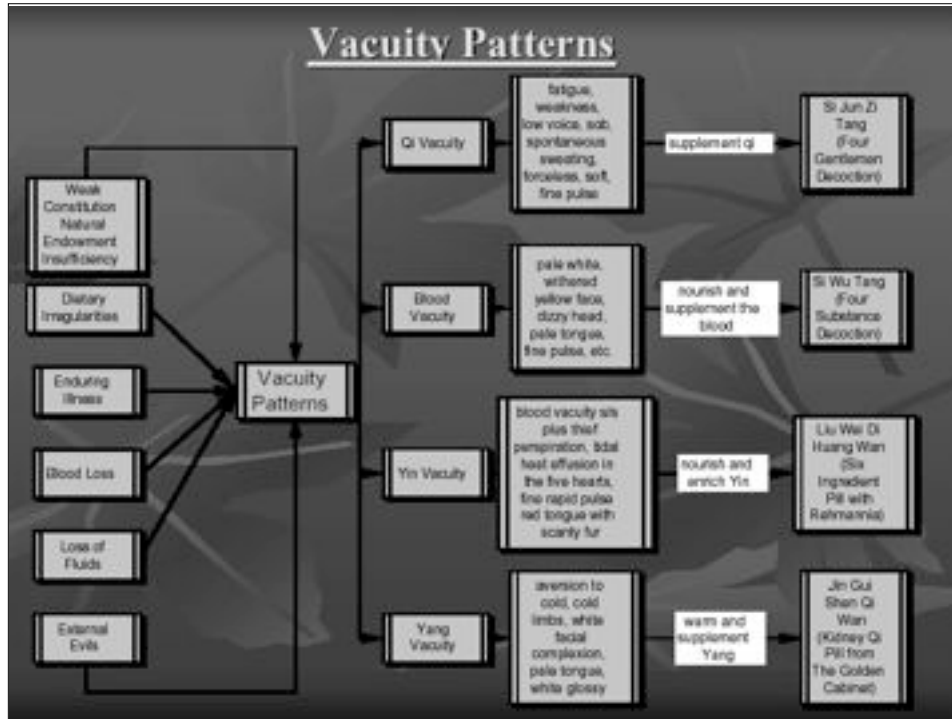

Medicinals that Supplement Qi

人參

Ren Shen (Ginseng Radix)

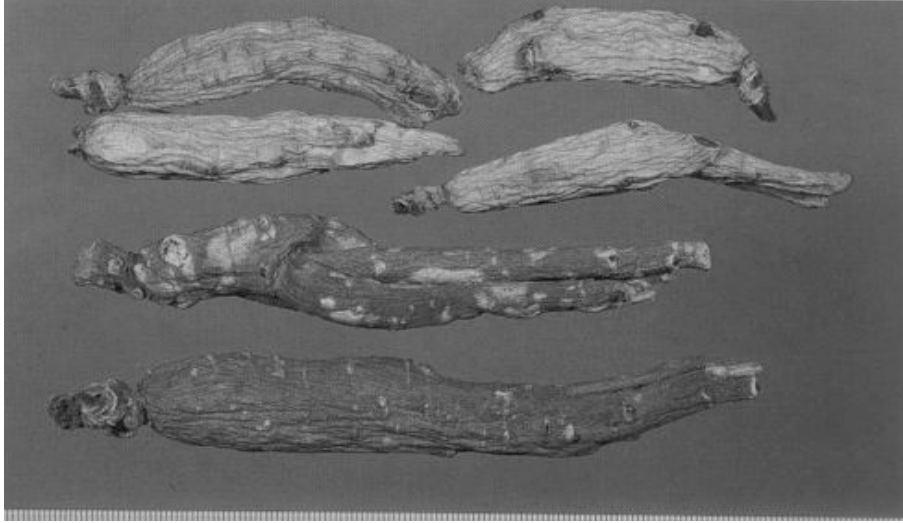

人參

Ren Shen (Ginseng Radix)



人參

Ren Shen (Ginseng Radix)

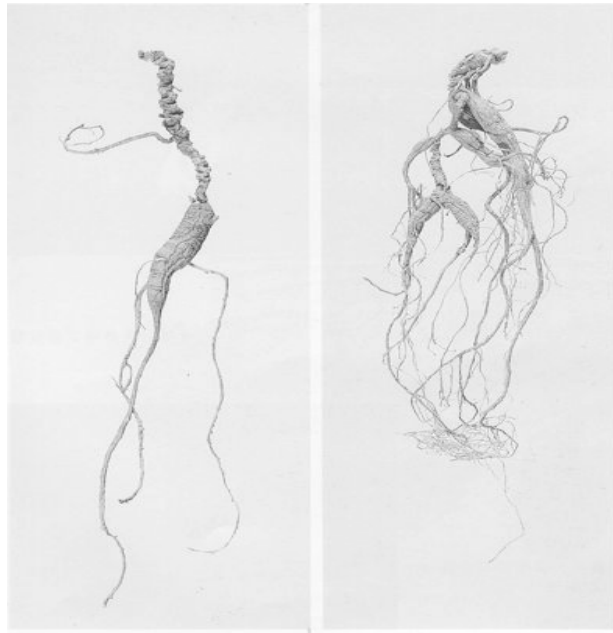

Ren Shen (Ginseng Radix) 人參

- **1. Powerfully tonifies the primal qi (yuan qi)**
 - a. For qi or yang desertion- especially red Korean ginseng. Used in high dosages
- **2. Tonifies and augments lung qi**
 - a. Lung qi vacuity cough, sob, sweating, low voice
- **3. Strengthens spleen and tonifies stomach qi**
 - a. Spleen and stomach vacuity patterns
 - b. Center qi fall
- **4. Generates fluids and alleviates thirst**
 - a. White ginseng is used here
 - b. Xiao ke disease
 - c. When fluids and qi have been injured by heat disease
- **5. Benefits the heart qi and calms spirit**
 - a. Heart qi vacuity patterns with shyness, depression, spiritual fatigue, anxiety with palpitations, etc
- Abstracts

党参Dang Shen (Codonopsis Radix)

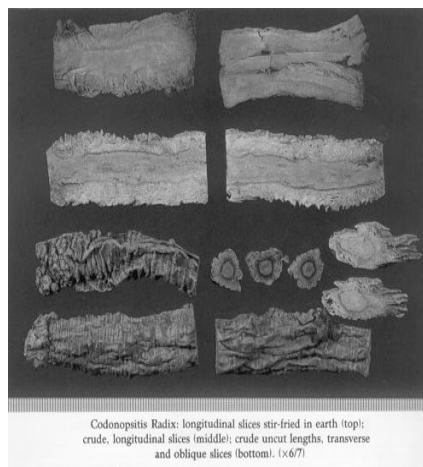

Codonopsis Radix: longitudinal slices stir-fried in earth (top); crude, longitudinal slices (middle); crude uncut lengths, transverse and oblique slices (bottom). (x6/7)

白朮 Bai Zhu
(*Atractylodis Macrocephalae Rhizoma*)

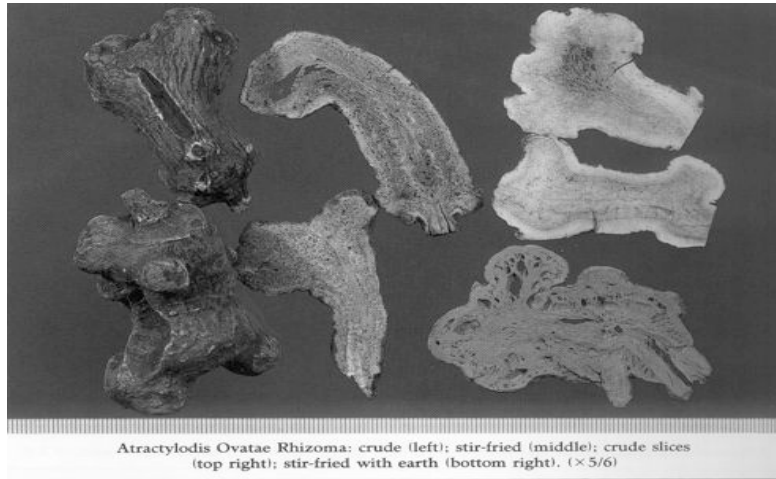

白朮 Bai Zhu (*Atractylodis Macrocephalae Rhizoma*)

- **1. Tonifies spleen and augments the qi**
- a. Spleen vacuity patterns with internally engendered dampness
- **2. Dries dampness and promotes water metabolism**
- a. See above
- **3. Stabilizes the exterior and stops sweating**
- a. Used when there is qi vacuity spontaneous sweating
- **4. Calms fetus**
- a. For threatened miscarriage due to failure of spleen qi to contain the fetus
- **Dosage** - low to medium C/C: yin vacuity, thirst

甘草

Gan Cao (Glycyrrhizae Radix)

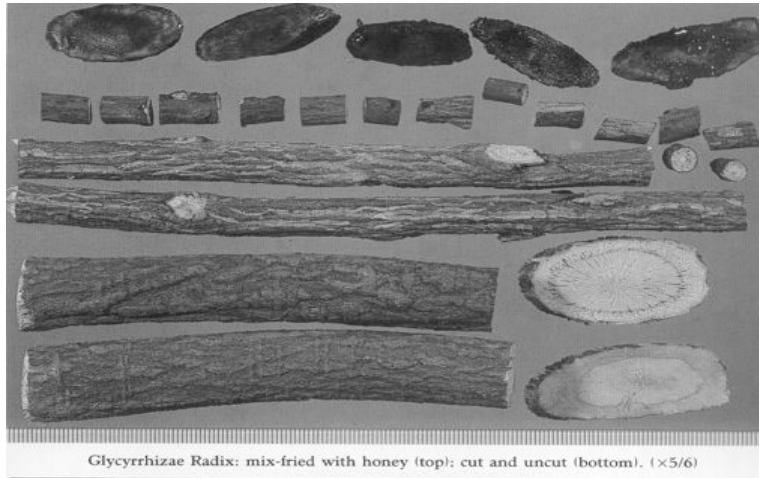

甘草 Gan Cao (Glycyrrhizae Radix)

- **1. Supplements spleen qi**
 - a. Zhi Gan Cao better for this function
- **2. Moistens lung and stops cough**
 - a. Used when dryness consumes lung fluid
- **3. Clears heat and fire toxin**
 - a. Used for swelling abscess and sore throat due to fire toxin
- **4. Moderates spasms and alleviates pain**
 - a. For yin and blood insufficiency failing to nourish the sinews
- **5. Moderates and harmonizes characteristics of other herbs**
- **6. Antidote to toxic substances**
- **Dosage low to medium**
- **C/c: hi BP, bloating, dampness**

Formulas that Supplement Vacuity

■ **I) Qi Vacuity**

■ **Si Jun Zi Tang (Four Gentlemen Decoction)**

- Ren Shen (Ginseng Rx) 6-15g.
- Bai Zhu (Atractylodis Macrocephalae Rz) 6-12
- Fu Ling (Poriae) 6-15
- Zhi Gan Cao (Glycyrrhizae Rx prep) 3-5

Medicinals that Supplement Yang

鹿茸

Lu Rong (Cornu Cervi)



鹿茸

Lu Rong (Cornu Cervi)



鹿茸

Lu Rong (Cornu Cervi)

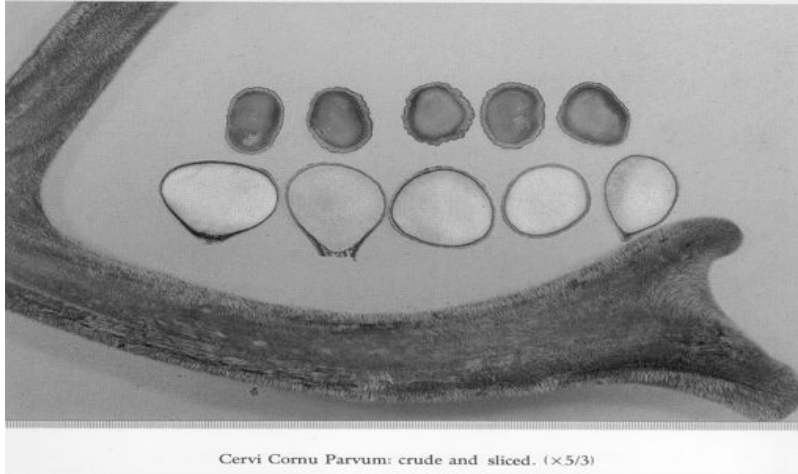

鹿茸 Lu Rong (Cervi Cornu)

- Tonifies kidney and fortifies yang
- Warms the yang, Regulates the chong and ren - discharge, bleeding, infertility
- Tonifies the governing vessel, augments essence and blood, and strengthens the sinews and bones - retardation, failure to thrive
- Tonifies and nourishes qi and blood
- Dosage - low **C/C: yin vacuity, fire , yang rising**
- More Information

152

Medicinals that Supplement Blood

153

熟地黄

Shu Di Huang (Rehmanniae Radix Preparatae)

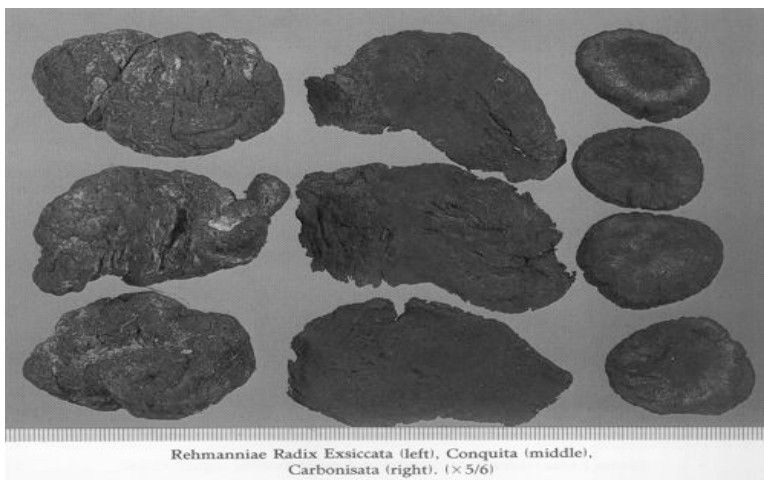

熟地黄

Shu Di Huang (Rehmanniae Radix Preparatae)



熟地黄

Shu Di Huang (Rehmanniae Radix Preparatae)

- Tonifies blood - all blood diseases
- Nourishes yin - nightsweats, vacuity heat
- Strongly enriches yin and relieves wasting and thirsting
- Nourishes blood and tonifies essence
- C/C: dampness and phlegm
- Dosage - medium to high

- Abstracts

當歸 Dang gui
(*Angelicae Sinensis Radix*)

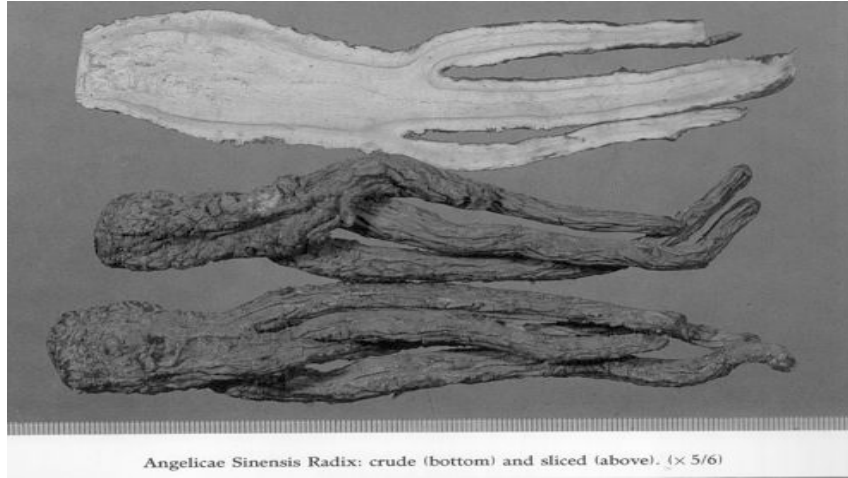

Angelicae Sinensis Radix: crude (bottom) and sliced (above). (× 5/6)

當歸
(*Angelicae Sinensis Radix*)



當歸 Dang Gui (Angelicae Sinensis Radix)

- Tonifies blood and regulates menses
- Invigorates and harmonizes blood and disperses cold
- Moistens intestines and unblocks the bowels
- Reduces swelling, expels pus, generates flesh, and alleviates pain
- Dosage - medium
- C/c: diarrhea, bloating

Formulas that Supplement Vacuity

■ II) Blood Vacuity

■ Si Wu Tang (Four Substance Decoction)

- Dang Gui (Angelicae Sinensis Rx) 6-12g.
- Chuan Xiong (Chuanxiong Rx) 6-10
- Bai Shao (Paeoniae Rx) 6-15
- Shu Di Huang (Rehmanniae Rx Prep) 6-30

Medicinals that Nourish Yin

**麦门冬 Mai Men Dong
(*Ophiopogonis Radix*)**



麦门冬Mai Men Dong (Ophiopogonis Radix)

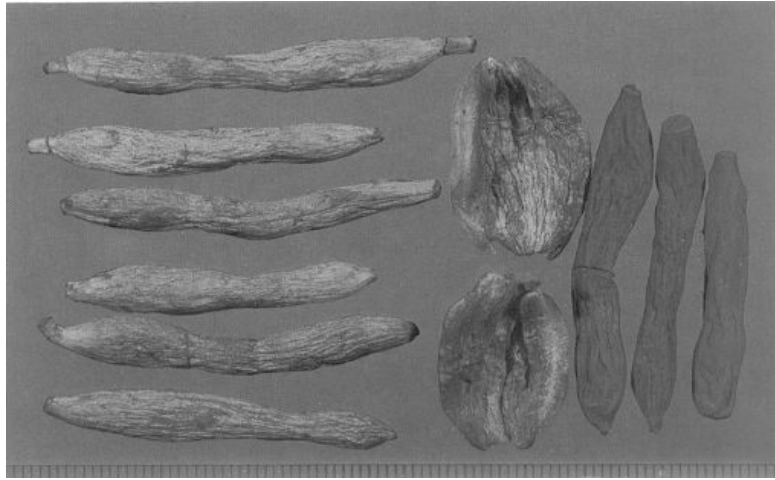

麦门冬Mai Men Dong (Ophiopogonis Radix)

- Moistens the lung and nourishes yin
- Augments stomach yin and generates fluids
- Clears the heart and eliminates irritability
- Moistens the Intestines
- Dosage - medium
- C/c: dampness, loose stool, cold phlegm¹⁶⁴

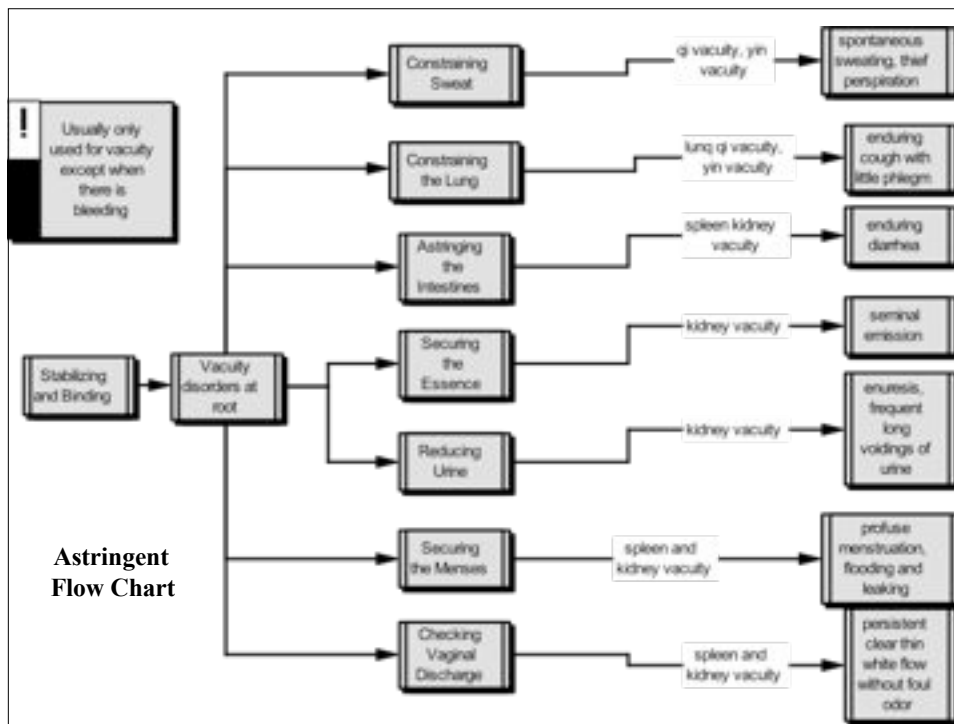

山茱萸 Shan Zhu Yu (Corni Fructus)



山茱萸 Shan Zhu Yu (Corni Fructus)

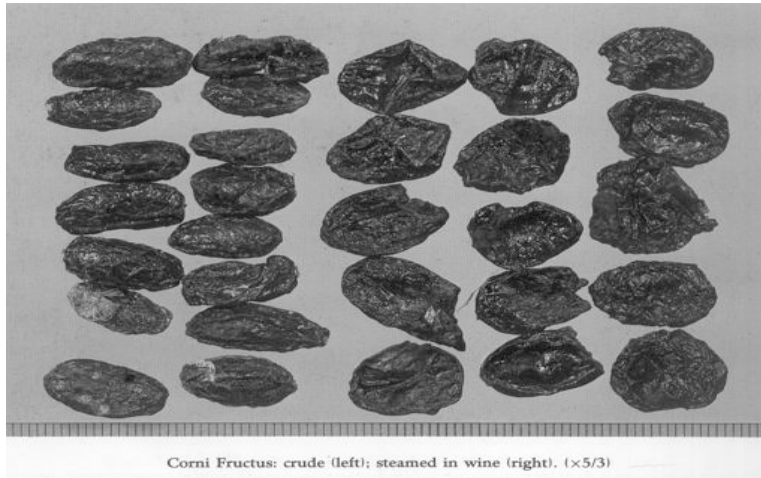

山茱萸 Shan Zhu Yu (Corni Fructus)

- Stabilizes the kidneys and retains essence
- Stops excessive sweating and supports that which has collapsed
- Tonifies liver and kidneys
- Stabilizes menses and stops bleeding
- Dosage - medium
- C/c: dampheat, strangury

Formulas that Supplement Vacuity

- **III) Nourish Yin**
- **Liu Wei Di Huang Wan (Six-Ingredient Pill with Rehmanniae)**
- Shu Di Huang (Rehmanniae Rx. Prep.) 6-30g.
- Shan Zhu Yu (Corni Fr.) 6-10
- Shan Yao (Dioscoreae Rz) 6-15
- Fu Ling (Poriae) 6-15
- Ze Xie (Alismatis Rz.) 6-12
- Mu Dan Pi (Moutan Cx.) 6-12

Etiology and Pathomechanisms of Disturbances of the Spirit

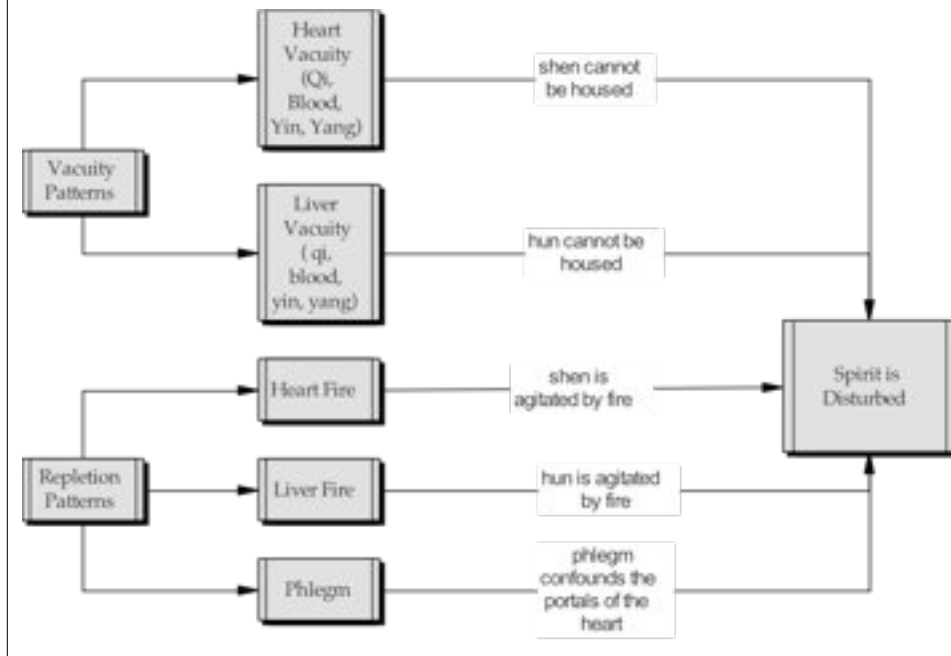

**酸棗仁 Suan Zao Ren
(Zizyphi Spinosae Semen)**



**酸棗仁 Suan Zao Ren
(Zizyphi Spinosae Semen)**

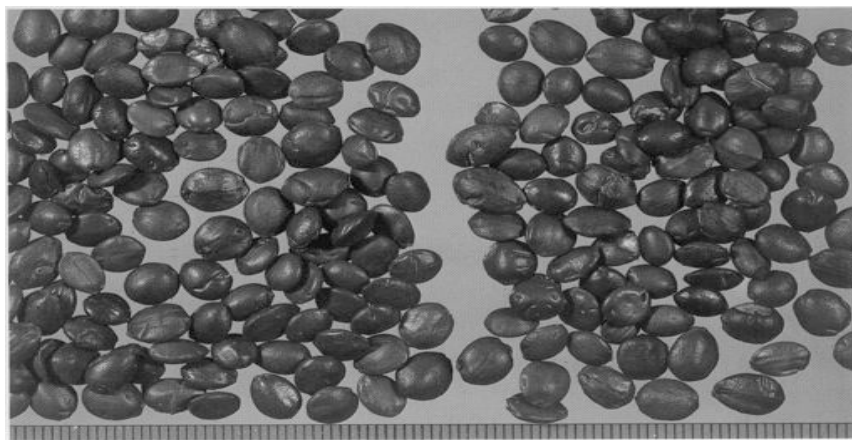

Zizyphi Spinosi Semen: crude (left); stir-fried (right). (× 5/3)

**酸棗仁 Suan Zao Ren
(Zizyphi Spinosae Semen)**

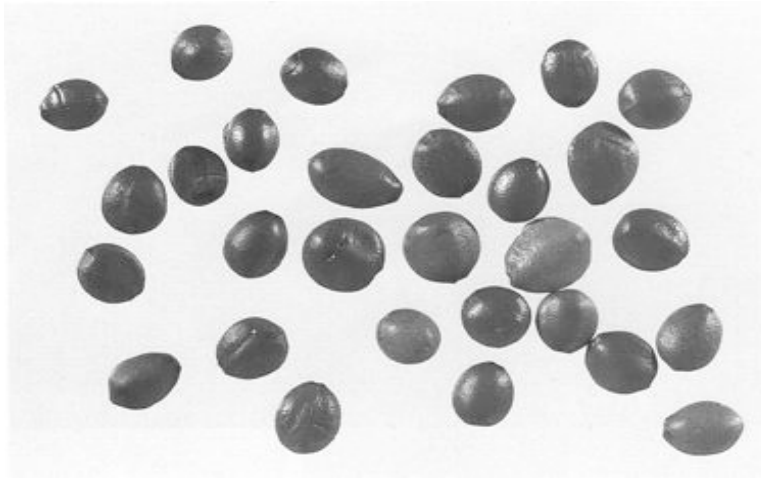

**酸棗仁 Suan Zao Ren
(Zizyphi Spinosae Semen)**

- Nourishes heart yin, augments liver blood, and quiets the spirit
- Prevents abnormal sweating
- Dosage - medium to high
- C/c: diarrhea, heat excess

龍骨 Long Gu (Fossilia Ossis Mastodi)

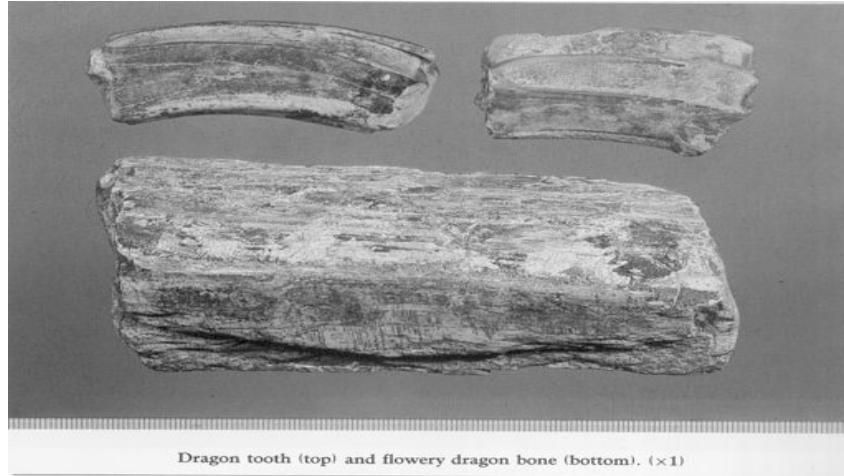

龍骨 Long Gu (Fossilia Ossis Mastodi)

- Settles anxiety and calms the spirit
- Calms the liver and anchors floating yang
- Prevents leakage of fluids
- Used topically for chronic sores
- Dosage - high
- C/c: spleen qi vacuity, dampheat, external illness

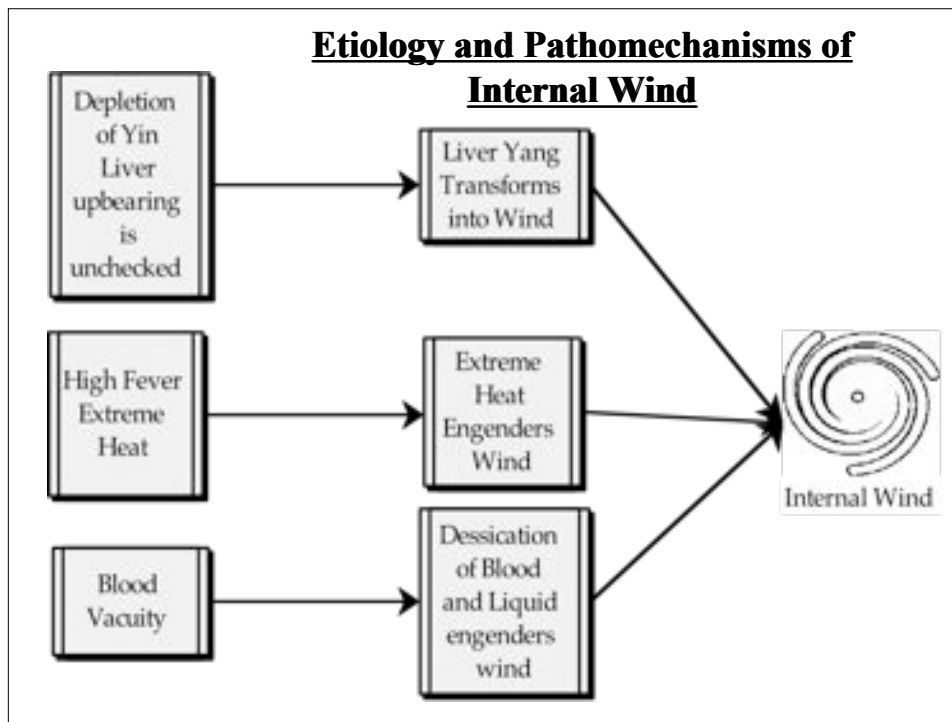

Calming the Liver and Extinguishing Wind

- These medicinals primarily calm the liver and settle yang
 - They are used for:
 - Internal Stirring of Liver Wind – spasms, convulsions, tetany, numbness
 - One must ascertain the underlying cause of the wind and combine these medicinals with those in other categories
 - Hyperactive Ascendancy of Liver Yang- symptoms in the head including dizziness, tinnitus, and vertigo
 - Other categories to combine with depending on the case:
 - Clear heat and drain fire, calm spirit, supplement blood, supplement yin

鈎藤 Gou Teng (Uncariae Ramulus cum Uncis)

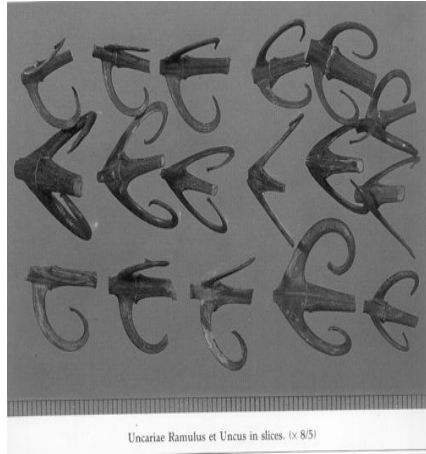

Uncariae Ramulus et Uncus in slices. (x 8/5)



鈎藤 Gou Teng (Uncariae Ramulus cum Uncis)



▲ 草鈎藤

鈎藤 Gou Teng (Uncariae Ramulus cum Uncis)

- Extinguishes wind and alleviates spasms
- Drains liver heat and pacifies yang
- Releases exterior wind-heat
- Dosage - medium to high
- C/c: vacuity

The Method of Opening the Orifices

- This method generally uses pungent, aromatic agents to open the sensory orifices and consciousness
- Primarily used when there is sudden loss of consciousness to resuscitate the patient in conditions such as stroke, seizure, angina pectoris, or cloudiness of the mind from heat disease entering the pericardium
- Also used to eliminate distention and oppression in the chest and abdomen caused by phlegm and dampness
- Mostly used in pill form owing to the urgent need of the substance as well as prohibitive costs in some cases

The Method of Opening the Orifices

- Primarily an emergency symptomatic treatment taking three major forms:
 - 1) Clearing the heart and opening the orifices
 - 2) Transforming phlegm and opening the orifices
 - 3) Expelling dampness and opening the portals
- General Contraindications: pregnancy, desertion of yang

麝香 She Xiang (Moschus)

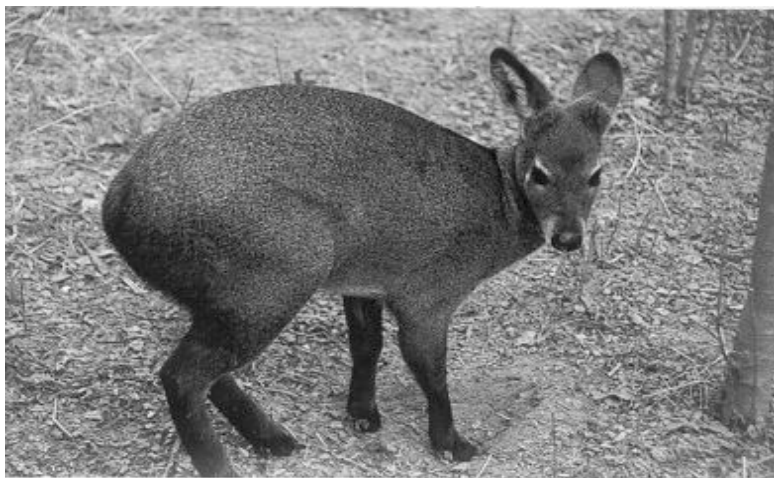

麝香 She Xiang (Moschus)

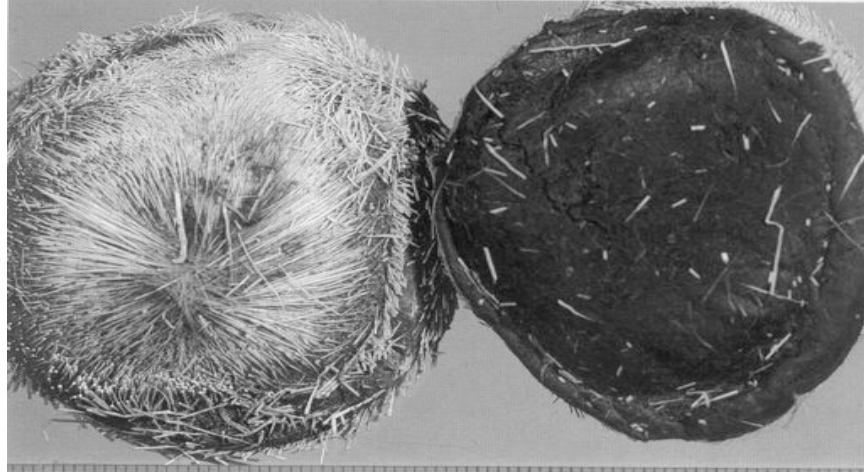

麝香 She Xiang (Moschus)

- Vigorously opens the orifices, revives the spirit, and unblocks closed disorders
- Invigorates blood, dissipates clumps, reduces swelling, and alleviates pain
- Hastens delivery and facilitates the downward passage of stillborns
- Dosage - low
- C/c: yin vacuity heat, pregnancy, allergies, hypertension, renal failure

Medicinals that Expel Parasites

- A basic understanding of parasitic disease was gained early in the history of Chinese medicine
- *“Inch white worm is a result of eating uncooked beef.”*
- *(Zhu Bing Yuan Hou Lun, Chao Yuan Fang 610c.e.)*
- Parasites are now listed as neutral or miscellaneous causes of disease
- In modern CM, the term parasites mostly refers to cases of worms
 - Hookworm, pinworm, roundworm, and tapeworm

Medicinals that Expel Parasites

- Symptoms and signs of parasites
 - Peri-umbilical pain, vomiting, change in appetite or deranged appetite, itching in various locations including the anus and perineum, the nose, and the ears.
 - Enduring cases will present with s/s of qi and blood vacuity
 - In modern times, stool and other lab exams confirm the diagnosis

Medicinals that Expel Parasites

- Choice of medicinal depends on the parasite involved
- Combined with other categories
 - Food stagnation
 - Attacking precipitants (purgatives)
 - Clearing heat
 - Warm supplementation
 - Warm interior
 - Specialized methods exist including taking timing of therapy into consideration
 - i.e., first take strong parasite formula soon followed by purgative formula

大蒜 Da Suan (Alli Sativae bulbus)

- Kills parasites- for most parasites, especially hookworm and pinworm
- Relieves toxicity
- Prevents influenza and food poisoning from shellfish
- Dosage - medium

- C/c: yin vacuity heat

Etiology of Heat

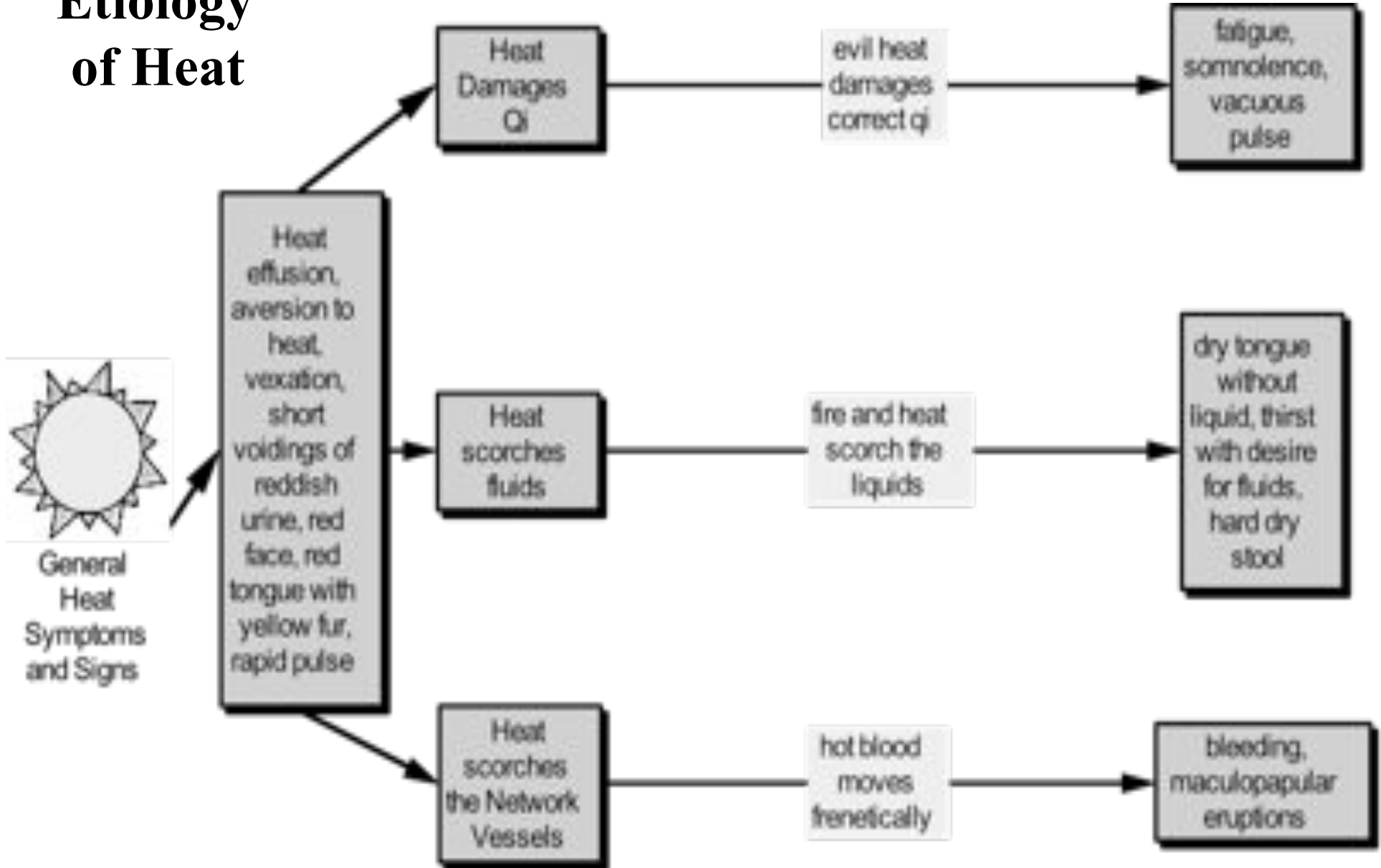

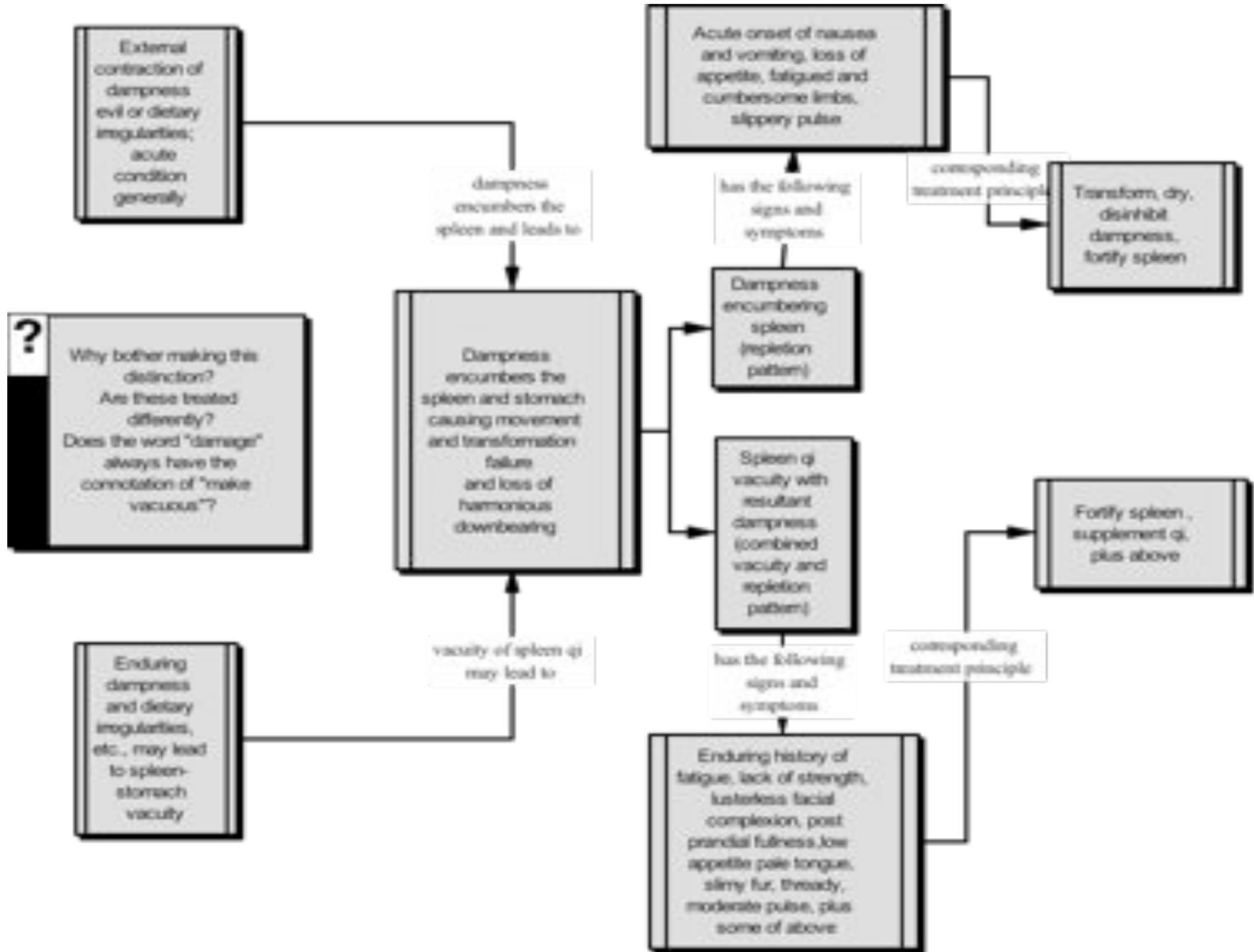

Etiology of Qi Stagnation

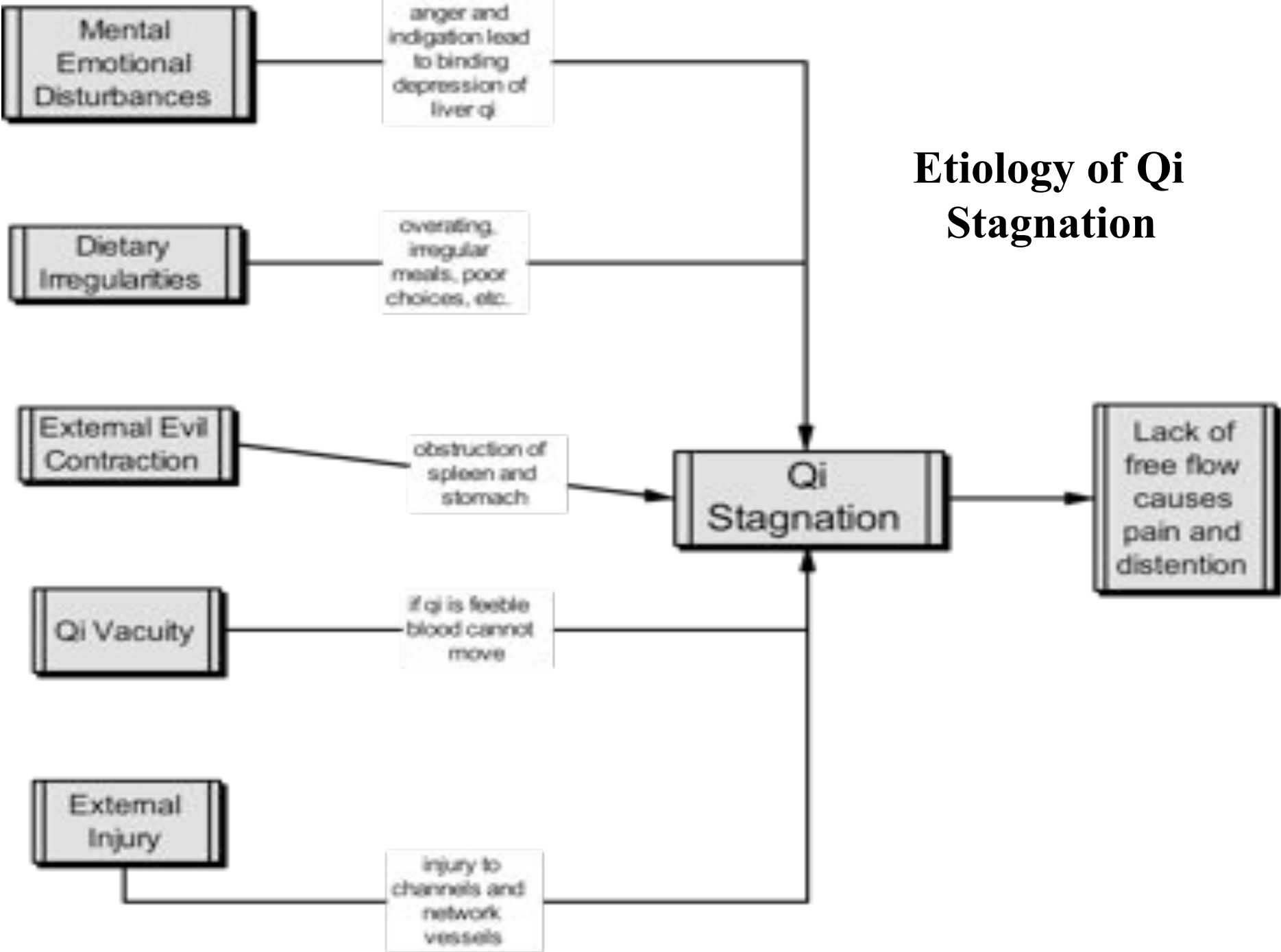

Disease Causes and Disease Mechanisms for Phlegm Disease

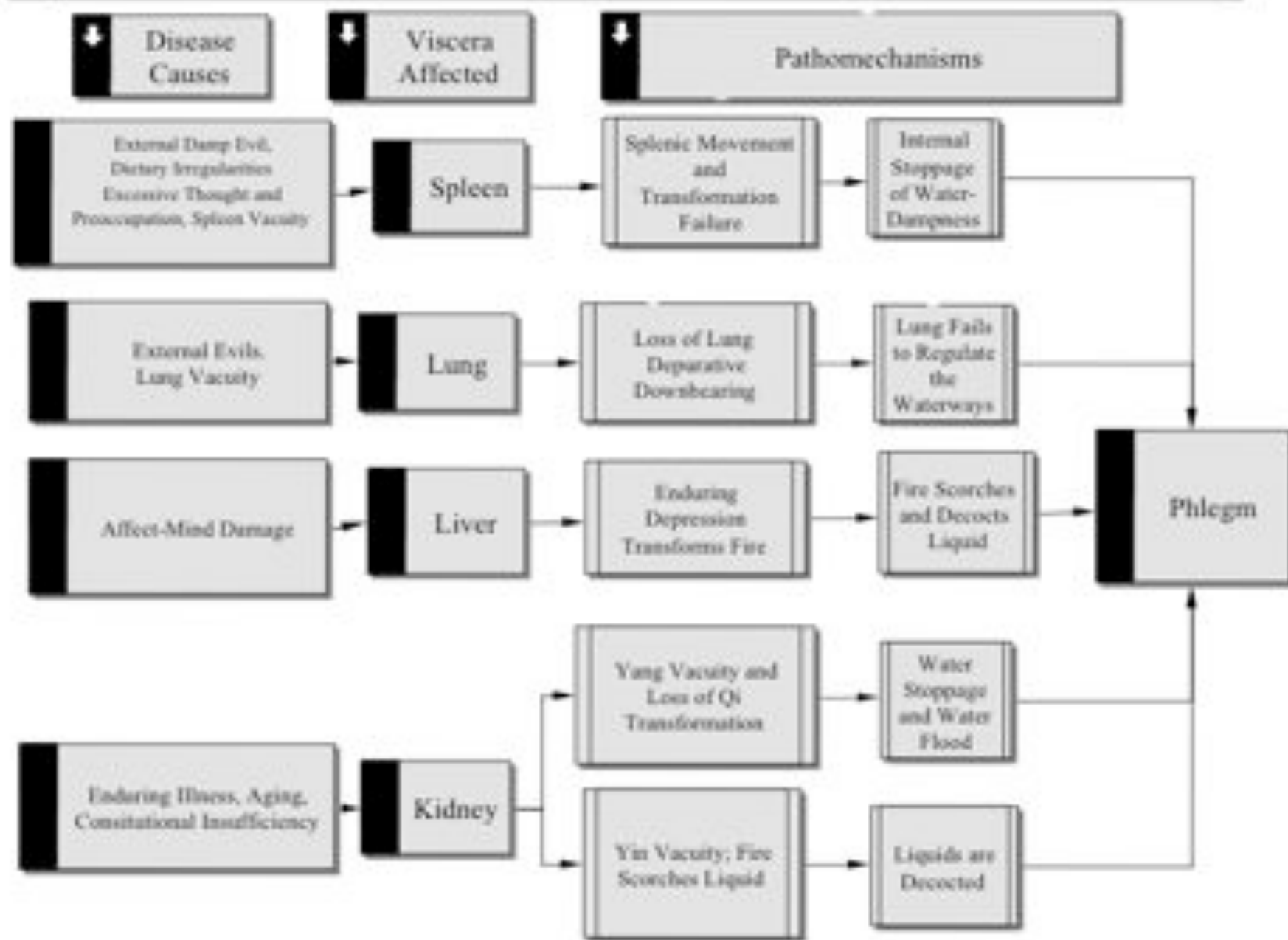

Clinical Manifestations of Phlegm Disease

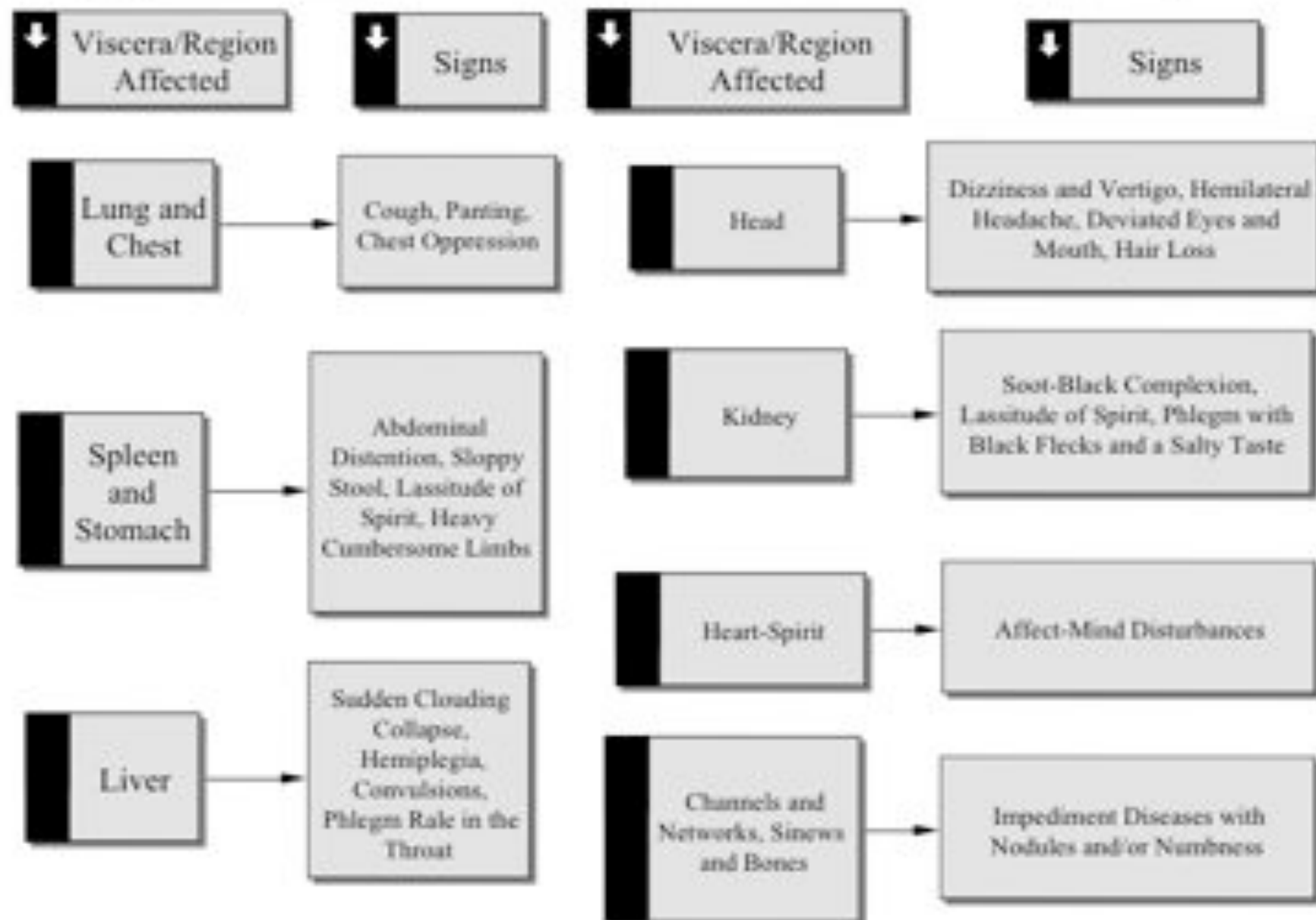

Etiology of Cough

Although the pattern differentiation is nicely and neatly placed in boxes, there are many examples of combined patterns

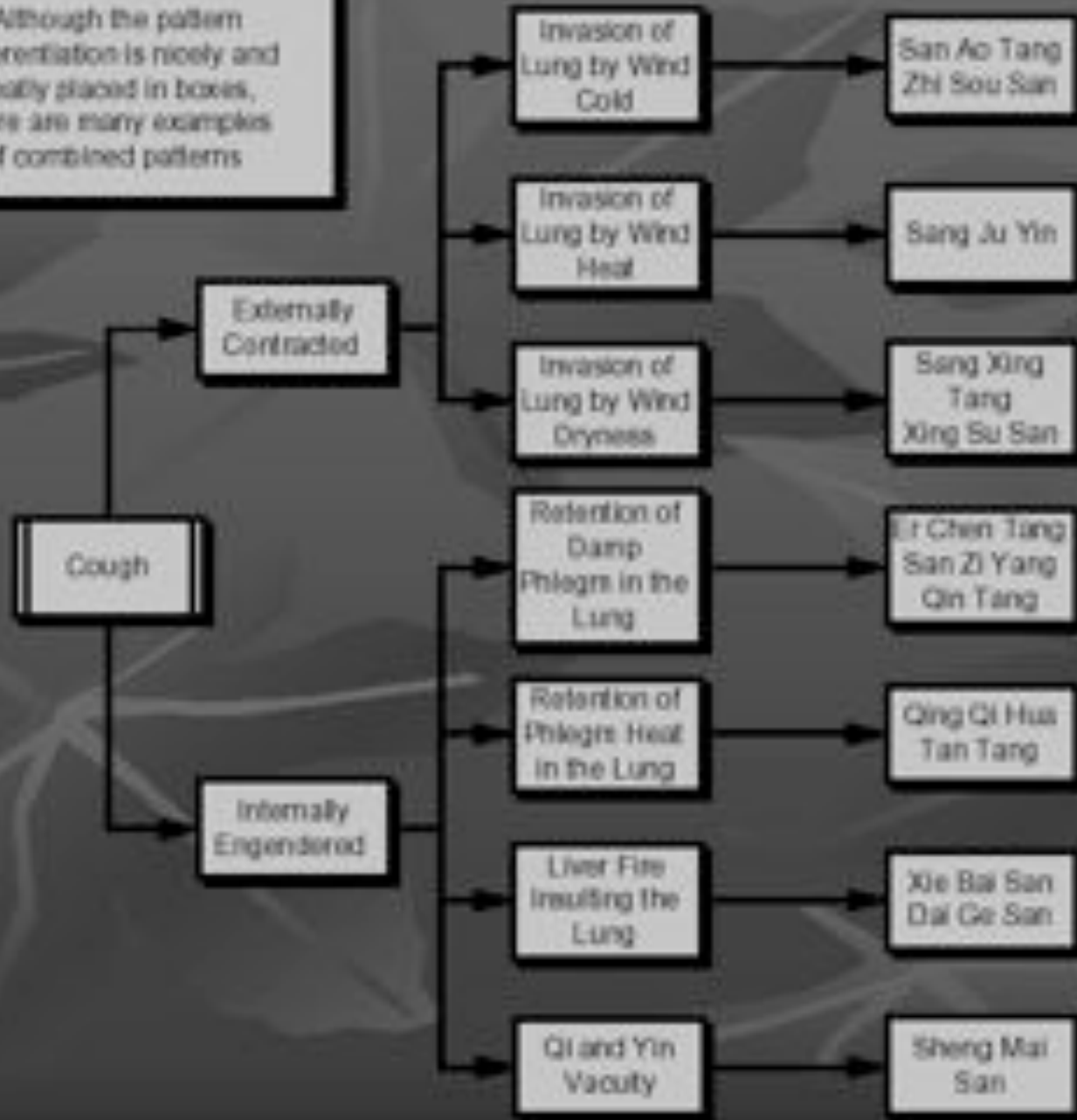

?

Can I recognize when the cough has become serious enough to warrant biomedical attention?

Do I understand the biomedical approach to a patient with cough?

Does this patient have a biomedical history that should make me more wary?

At what point could I be supportive of antibiotic therapy?

Four Causes of Bleeding in TCM:

<u>Etiology</u>	<u>Pathomechanism</u>
Heat	Blood moves recklessly
Qi Vacuity	Qi cannot restrain the blood
Stasis	Stasis occupies the network vessels
Trauma	Network vessels are severed

Etiology and Pathomechanisms of Blood Stasis

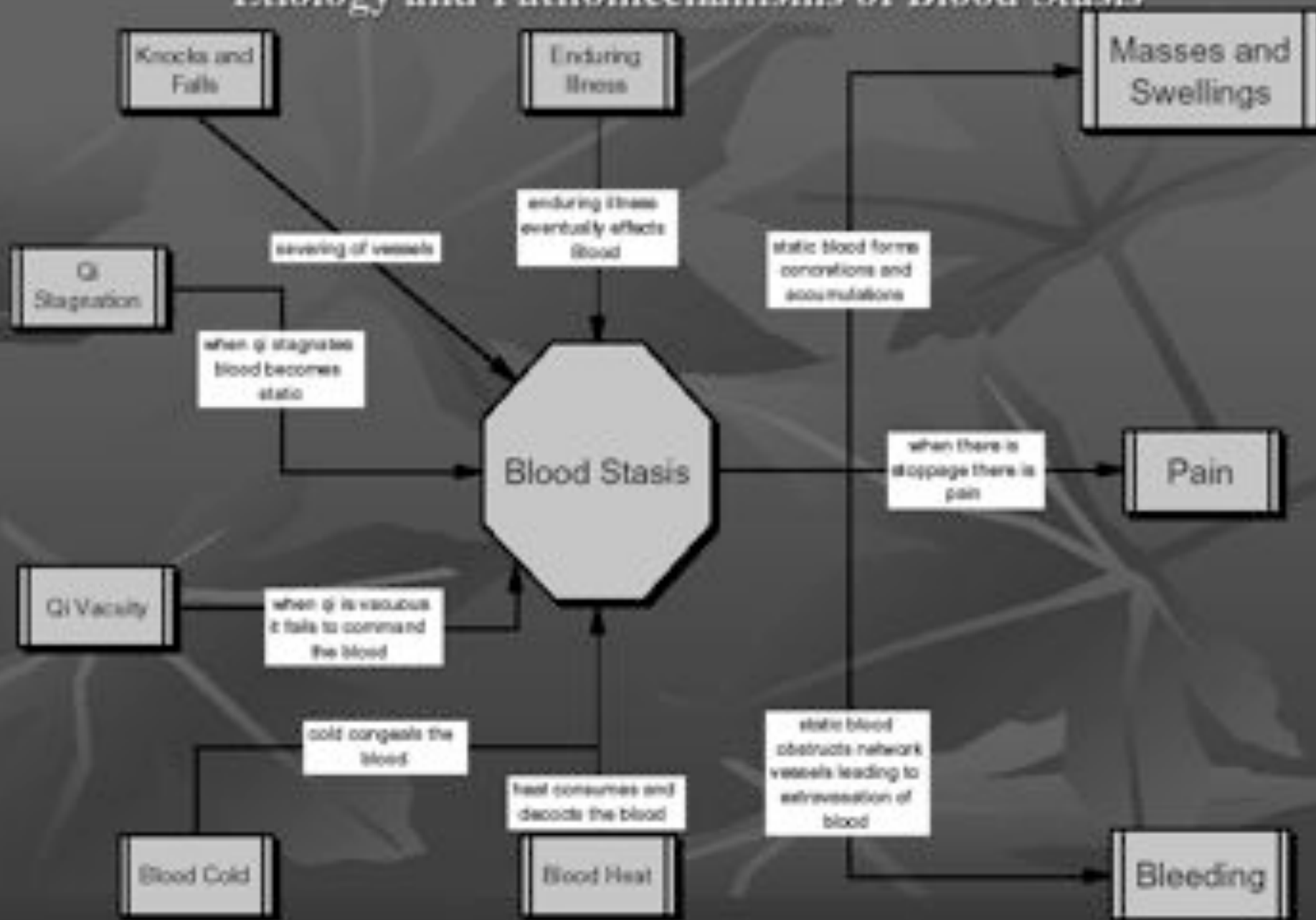

Etiology and Pathomechanisms for Cold Disease

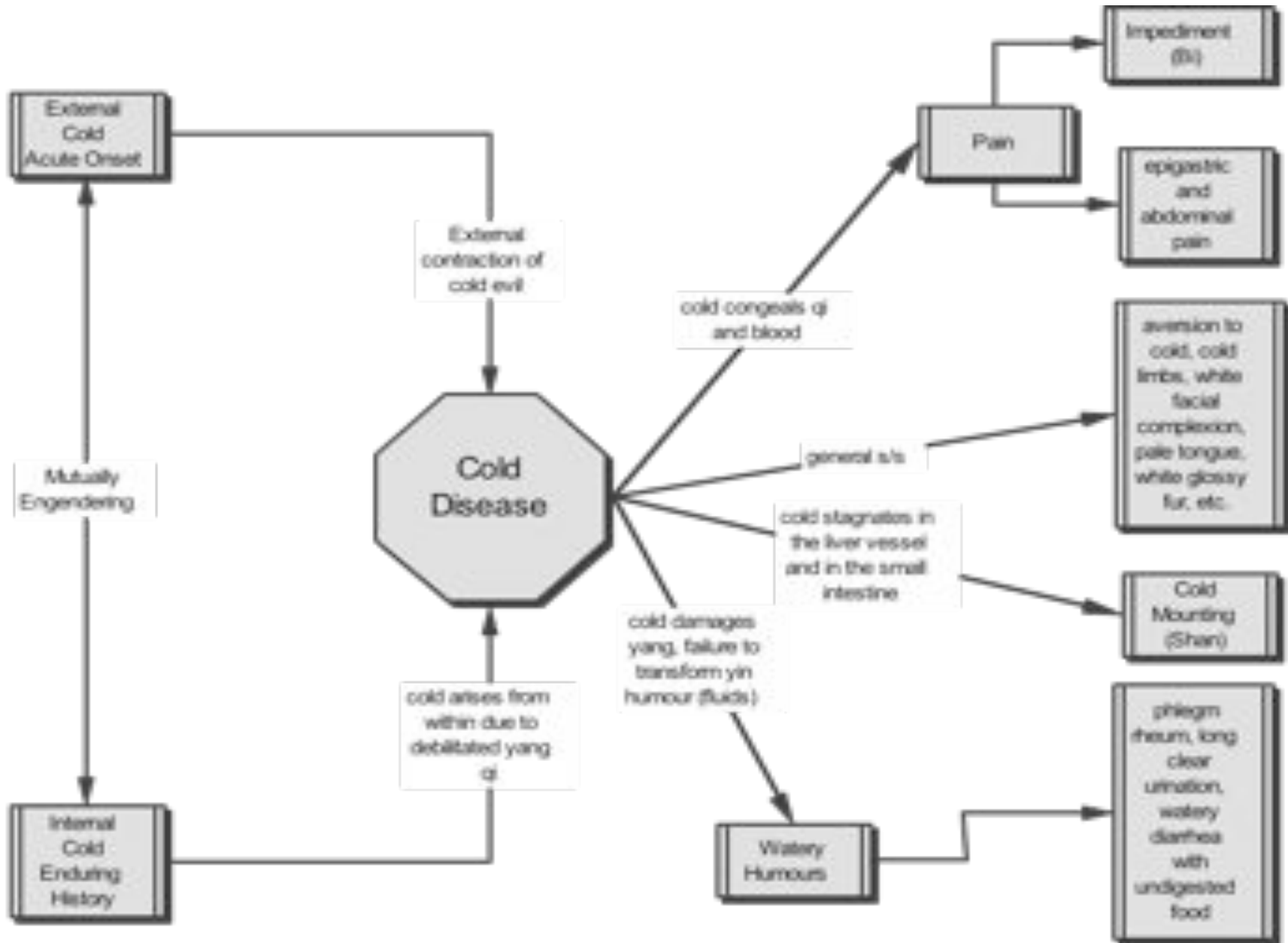

Vacuity Patterns

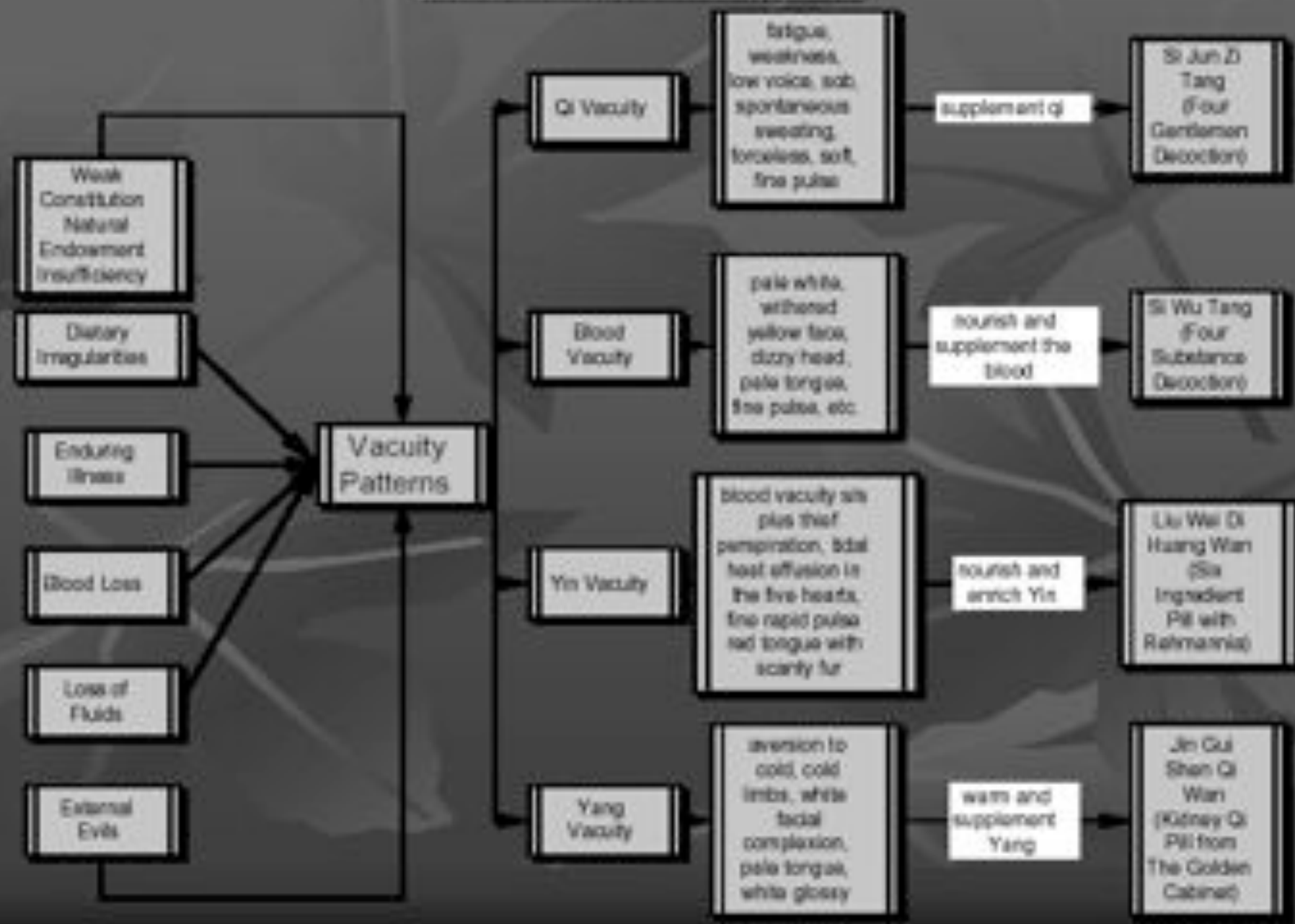

! Usually only used for vacuity except when there is bleeding

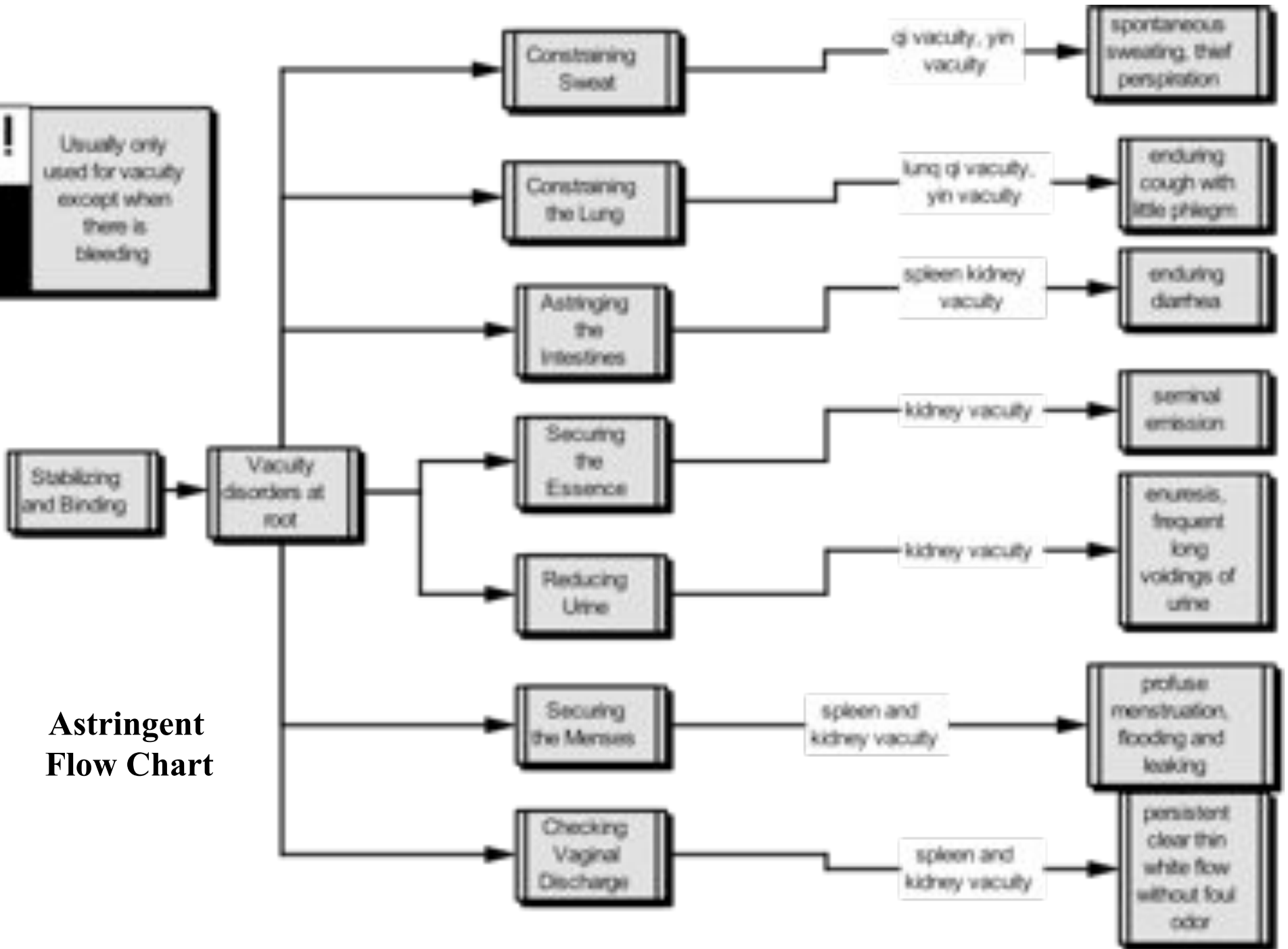

Astringent Flow Chart

Etiology and Pathomechanisms of Disturbances of the Spirit

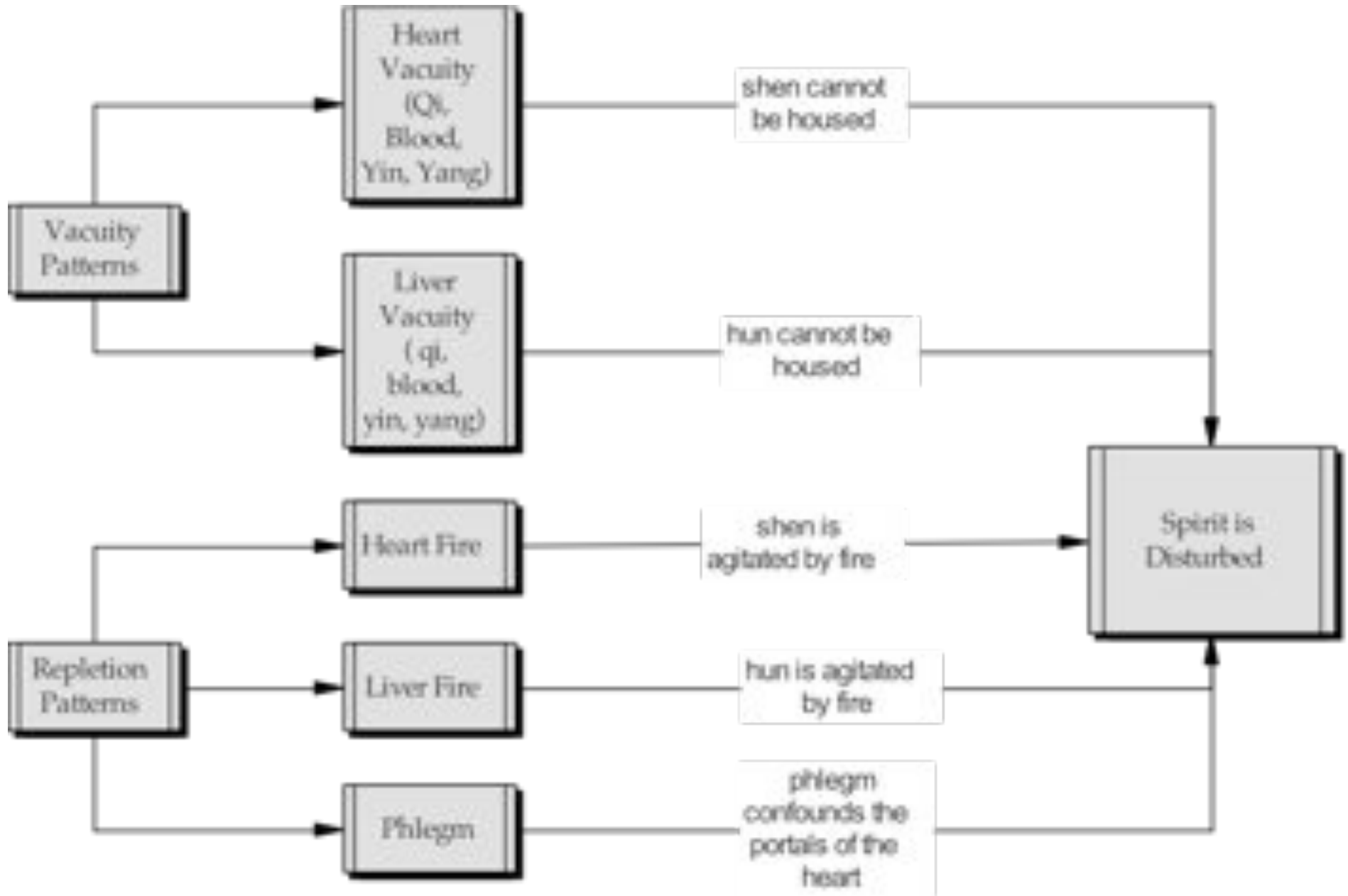

Etiology and Pathomechanisms of Internal Wind

