



INTEGRAL AUDIO

INSTALLATION GUIDE

PHANTOM™ SUBWOOFER SYSTEM

FOR 2014+ BMW 4-SERIES GRAN COUPE (F36) ver. 5/20

SKILL LEVEL REQUIRED

DO-IT-YOURSELF

INSTALLATION DIFFICULTY

2 OUT OF 5

INSTALLATION TIME

1 HOUR

APPLIES TO

2014+ F36 GRAN COUPE



- BEFORE YOU BEGIN** 2
- WHAT'S IN THE BOX**..... 3
- TOOLS YOU WILL NEED**..... 5
- INSTALLATION:**
- A. Prep Vehicle 6
- B. Subwoofer 20
- NOTES & TIPS**..... 28
- TROUBLESHOOTING** 28

IMPORTANT

- Read this Guide completely BEFORE you begin.
- Disconnect the battery negative terminal while working on the vehicle.
- DO NOT PLACE THE KEY FOB in the vehicle with the battery connected and the seat airbag wiring disconnected. Doing so will set off the airbag light, and must be reset by your dealer.
- ALWAYS check behind panels and components before drilling, cutting, or screwing into any part of a vehicle.

I. INTEGRAL AUDIO PHANTOM™ SUBWOOFER

1. Phantom™ Subwoofer Enclosure [F36.SUB10]
2. Integral Audio Soundstage Series 10" Subwoofer [IA26W4558T03]

II. SUBWOOFER HARDWARE

3. Subwoofer Mounting Bracket & Hardware
4. Subwoofer Support Bracket & Hardware
5. Neutrik Quick-connect Subwoofer Terminal & Wiring
6. Subwoofer Cover Grille

I. TOOLS YOU WILL NEED:

1. Wrenches or Socket Driver & Sockets:
 - 10mm deep socket
2. Torx Bits:
 - T40
3. Screwdrivers:
 - Small Slotted & Phillips
4. Plastic Panel Removal Tool(s)
5. 1/8" Allen (Hex) Wrench
6. Magnetic Parts Tray [Optional]



1. REMOVE TRUNK FLOOR PANEL

Remove the trunk floor panel.

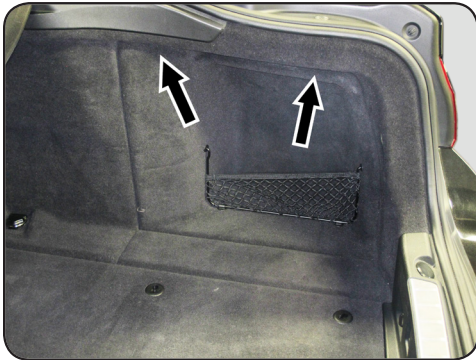

2. REMOVE BATTERY COMPARTMENT COVER

Remove battery cover by turning the locking knob and lifting out the cover.

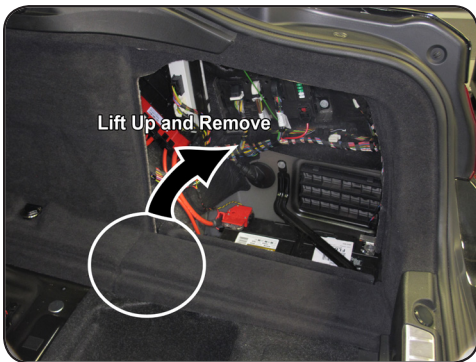

3. REMOVE THE SIDE FLOOR TRIM PANEL

Remove the side floor trim panel by lifting up on the forward portion, lift clear and remove.



4. MOUNT THE SUBWOOFER INTO THE ENCLOSURE

Connect the *Subwoofer Internal Wiring Harness [F30.WH.SUB-INT]* to the *Neutrik terminal* in the enclosure. Note polarity markings on the *Neutrik terminal*! Connect the other end to the subwoofer.

Mount the subwoofer to the enclosure using the eight #10-24 x 1" *Button Head Cap Screws* and tighten with a 1/8" Allen wrench. Insert the speaker grille over and around the subwoofer gasket.

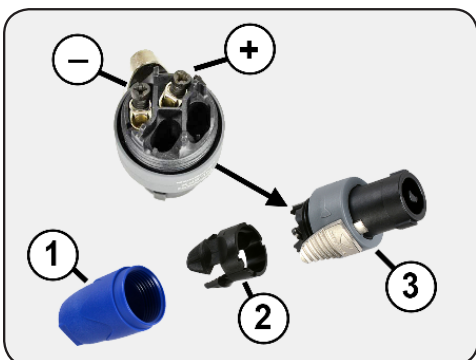

5. SUBWOOFER WIRING (NEUTRIK PLUG)

Select the 3ft long *Subwoofer Wiring Pigtail* from the *Subwoofer Hardware Kit*. Connect the *Neutrik Speak-on Plug* to one end of the subwoofer wire. Slide the blue chuck (1) over the wire, followed by the strain-relief bushing (2). Make the positive & negative connections to the plug as shown, tighten the terminals with a small Phillips screwdriver. Slide the bushing (2) forward and tighten the chuck (3) onto the plug (3).

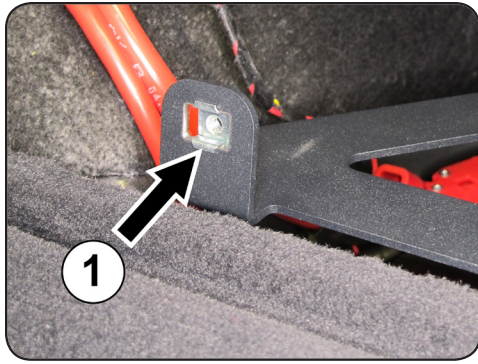

6. SUBWOOFER MOUNTING BRACKET (STEP 1)

Insert the two *Cage Nuts* (1) into the holes in the uprights in the *Subwoofer Mounting Bracket*. Pinch the *Cage Nut* clips with pliers to insert. The *Cage Nuts* insert from the REAR side of the bracket. The bracket holes are slotted to allow for side-to-side adjustment if needed. Start with them centered.

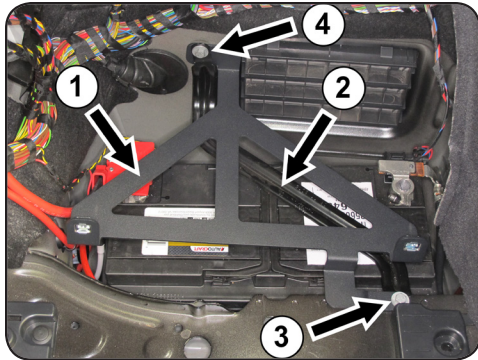

7. SUBWOOFER MOUNTING BRACKET (STEP 2)

The *Subwoofer Mounting Bracket* (1) mounts to the vehicle using the same mounting bolts and points as the battery hold-down bracket (2). Begin by removing both bolts from the hold-down bracket (3) & (4). The rear of the *Subwoofer Mounting Bracket* mounts underneath of the hold-down bracket and the front mounts on top of the sheet metal. See next steps for details.

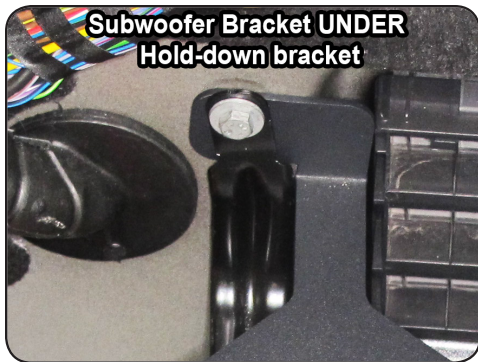

8. SUBWOOFER MOUNTING BRACKET (STEP 3)

The rear attachment point of the *Subwoofer Mounting Bracket* should be underneath the battery hold-down bracket. Use the original bolt to secure both brackets to the vehicle.

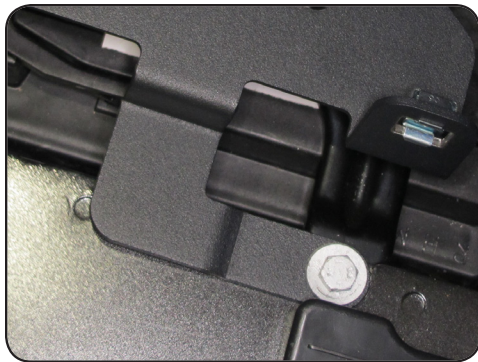

9. SUBWOOFER MOUNTING BRACKET (STEP 4)

The front attachment point of the *Subwoofer Mounting Bracket* mounts on top of the vehicle sheet metal, with the battery hold-down bracket underneath the sheet metal. From top to bottom it should be bolt/washer => *Subwoofer Mounting Bracket* => vehicle sheet metal => battery hold-down bracket. Use the original bolt to secure.

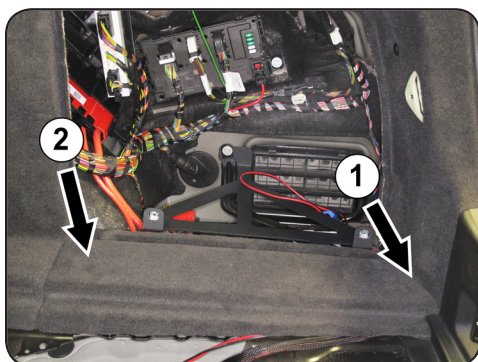

10. ROUTE SUBWOOFER SPEAKER WIRING

Route the subwoofer wire behind the trim (1)

Replace the side floor trim panel (2).



11. INSTALL SUBWOOFER ENCLOSURE

Connect the Neutrik connector.

Install the enclosure by placing the bottom front edge into the slot in the Floor Side Trim Panel with the top of the enclosure leaning forward, then rotate/tilt the top of the enclosure into place.

Affix the *Domed Logo Badge* to the subwoofer grille.

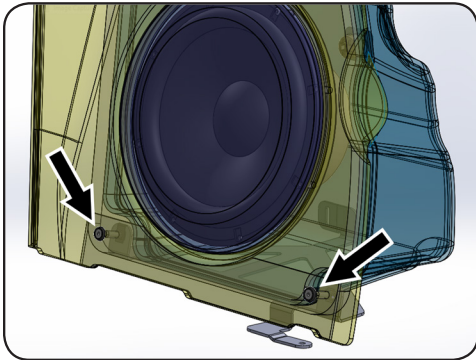

12. FASTEN SUBWOOFER

The CAD image at left has some transparency so you can see how the bolts attach thru the baffle and into the bracket. Use the two *#10-24 x 2.5" Socket Head Cap Bolts* and *Black Flat Washers*. Locate the screw holes in the baffle. Press the bolts through the carpet and into the hole until they make contact with the bracket. Start the threads by hand!

You only need to snug the bolts down, DO NOT OVERTIGHTEN!



13. ROCK. AND ROLL.

Reinstall remaining trim panels, seats, etc, in the reverse order they were removed.

That's it! You should be ready to rock and roll. If you aren't seriously impressed by the sound, something is wrong. Trust us on this. It should be clean, clear, and balanced. If it isn't, revisit the steps above or reach out to us for support at 646-926-0011 or email us at support@integralaudio.com.

B.

SUBWOOFER

- **SIGNAL SOURCE QUALITY:** A poor quality signal will always sound poor no matter how good an audio system is. If you are using MP3s or home-burned CDs it is critical that you understand the limitations and impacts of digital compression methods. MP3s at less than 256kbps will have noticeable loss of quality. Satellite radio is also compressed and will have similar quality issues. Non-commercially obtained music (especially downloaded via P2P file-sharing) recordings are often re-mixed by third parties and will have been compressed in an unknown and uncontrolled manner. If you want good quality sound, use only commercially obtained CDs or MP3s compressed at 256kbps or 320kbps.
- **FACTORY RADIO SETTINGS:** Please note that the settings (Bass, Treble, Fade, Balance, AUX input level, etc.) are stored to each Key FOB & are specific to the Source (Radio, CD, AUX) for many vehicles. You will need to edit and save the settings for each source and each FOB to have consistent sound.
- **PLEASE LISTEN RESPONSIBLY:** Your new Integral Audio system is capable of delivering Sound Pressure Levels that can damage your hearing. It also delivers very clean, low-distortion sound reproduction. Because distortion sounds bad to your ears, and low-distortion sounds good, you are much more likely to listen at high levels with your new system. Please exercise caution - we want you to enjoy a lifetime of great sound!

Having Trouble? The best thing to do is contact us at support@integralaudio.com or via the phone number listed on the receipt that was emailed to you. We'll get you fixed up ASAP!