

CEI 60909-0  
(Première édition – 2001)

**Courants de court-circuit dans les réseaux  
triphases à courant alternatif –**

**Partie 0: Calcul des courants**

IEC 60909-0  
(First edition – 2001)

**Short-circuit currents in three-phase  
a.c. systems –**

**Part 0: Calculation of currents**

## CORRIGENDUM 1

---

Page 10

*Au lieu de:* CEI TR2 60909-1:1991

*lire:* CEI TR 60909-1, —<sup>1</sup>

*Au lieu de:* CEI TR 60909-4:—

*lire:* CEI TR 60909-4:2000

Page 11

*Instead of:* IEC TR2 60909-1:1991

*read:* IEC TR 60909-1, —<sup>1</sup>

*Instead of:* IEC TR 60909-4:—

*read:* IEC TR 60909-4:2000

Page 16

*Au lieu de:* CEI TR2 60909-1, —

*lire:* CEI TR 60909-1, —<sup>1</sup>

*Au lieu de:* CEI 60909-4, —

*lire:* CEI TR 60909-4:2000

Page 17

*Instead of:* IEC TR2 60909-1, —

*read:* IEC TR 60909-1, —<sup>1</sup>

*Instead of:* IEC 60909-4, —

*read:* IEC TR 60909-4:2000

---

<sup>1</sup> A publier.

To be published.

Replace the existing figures 1 and 2 by the following new figures 1 and 2:

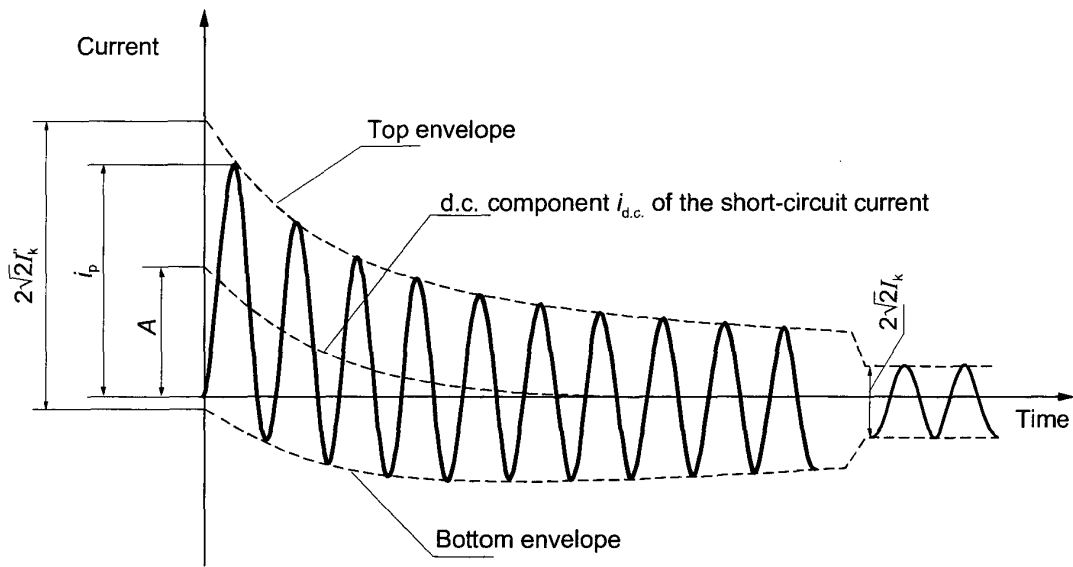
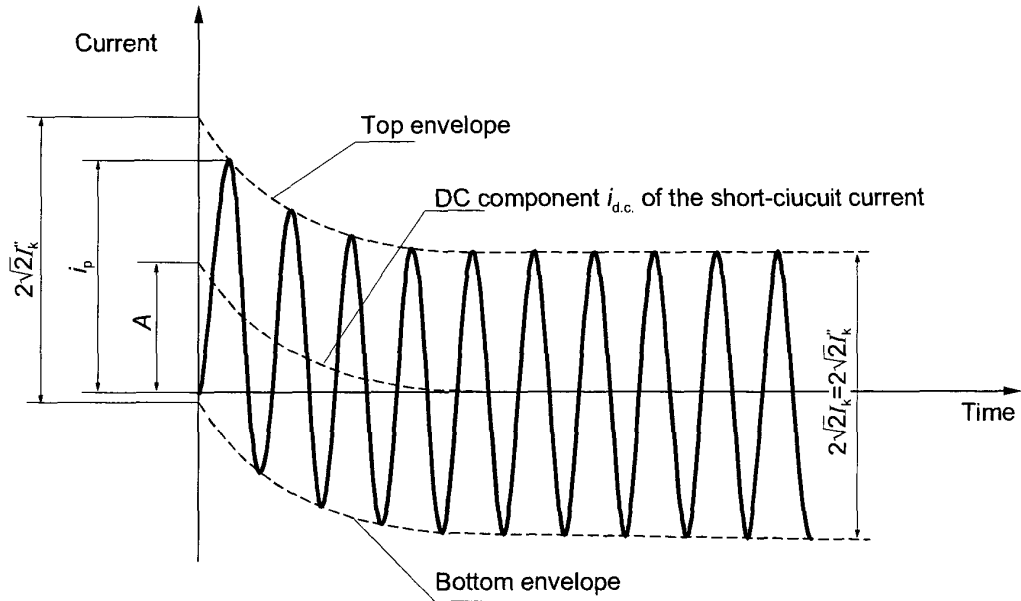

**NORME  
INTERNATIONALE  
INTERNATIONAL  
STANDARD**

**CEI  
IEC  
60909-0**

Première édition  
First edition  
2001-07

---

---

**Courants de court-circuit dans les réseaux  
triphases à courant alternatif –**

**Partie 0:  
Calcul des courants**

**Short-circuit currents in three-phase  
a.c. systems –**

**Part 0:  
Calculation of currents**



Numéro de référence  
Reference number  
CEI/IEC 60909-0:2001

**NORME  
INTERNATIONALE  
INTERNATIONAL  
STANDARD**

**CEI  
IEC  
60909-0**

Première édition  
First edition  
2001-07

---

---

**Courants de court-circuit dans les réseaux  
triphasés à courant alternatif –**

**Partie 0:  
Calcul des courants**

**Short-circuit currents in three-phase  
a.c. systems –**

**Part 0:  
Calculation of currents**

© IEC 2001 Droits de reproduction réservés — Copyright - all rights reserved

Aucune partie de cette publication ne peut être reproduite ni utilisée sous quelque forme que ce soit et par aucun procédé, électronique ou mécanique, y compris la photocopie et les microfilms, sans l'accord écrit de l'éditeur.

No part of this publication may be reproduced or utilized in any form or by any means, electronic or mechanical, including photocopying and microfilm, without permission in writing from the publisher.

International Electrotechnical Commission  
Telefax: +41 22 919 0300

e-mail: [inmail@iec.ch](mailto:inmail@iec.ch)

3, rue de Varembé Geneva, Switzerland  
IEC web site <http://www.iec.ch>



Commission Electrotechnique Internationale  
International Electrotechnical Commission  
Международная Электротехническая Комиссия

CODE PRIX XB  
PRICE CODE

Pour prix, voir catalogue en vigueur  
For price, see current catalogue

## CONTENTS

|  |    |
|--|----|
| FOREWORD.....  | 9  |
| 1 General.....   | 13 |
| 1.1 Scope.....   | 13 |
| 1.2 Normative references.....  | 15 |
| 1.3 Definitions.....   | 17 |
| 1.4 Symbols, subscripts and superscripts.....  | 25 |
| 1.4.1 Symbols.....   | 25 |
| 1.4.2 Subscripts.....  | 29 |
| 1.4.3 Superscripts.....  | 31 |
| 2 Characteristics of short-circuit currents: calculating method.....                       | 31 |
| 2.1 General.....   | 31 |
| 2.2 Calculation assumptions.....   | 35 |
| 2.3 Method of calculation.....   | 35 |
| 2.3.1 Equivalent voltage source at the short-circuit location.....                         | 35 |
| 2.3.2 Application of symmetrical components.....   | 41 |
| 2.4 Maximum short-circuit currents.....  | 45 |
| 2.5 Minimum short-circuit currents.....  | 47 |
| 3 Short-circuit impedances of electrical equipment.....                                    | 47 |
| 3.1 General.....   | 47 |
| 3.2 Network feeders.....   | 49 |
| 3.3 Transformers.....  | 51 |
| 3.3.1 Two-winding transformers.....  | 51 |
| 3.3.2 Three-winding transformers.....  | 53 |
| 3.3.3 Impedance correction factors for two- and three-winding<br>network transformers..... | 57 |
| 3.4 Overhead lines and cables.....   | 59 |
| 3.5 Short-circuit limiting reactors.....   | 61 |
| 3.6 Synchronous machines.....  | 61 |
| 3.6.1 Synchronous generators.....  | 61 |
| 3.6.2 Synchronous compensators and motors.....   | 65 |
| 3.7 Power station unit.....  | 65 |
| 3.7.1 Power station units with on-load tap-changer.....                                    | 65 |
| 3.7.2 Power station units without on-load tap-changer.....                                 | 69 |
| 3.8 Asynchronous motors.....   | 71 |
| 3.8.1 General.....   | 71 |
| 3.8.2 Contribution to short-circuit currents by asynchronous motors.....                   | 73 |
| 3.9 Static converters.....   | 77 |
| 3.10 Capacitors and non-rotating loads.....  | 77 |
| 4 Calculation of short-circuit currents.....   | 79 |
| 4.1 General.....   | 79 |
| 4.2 Initial symmetrical short-circuit current $I_k''$ .....                                | 83 |

|  |  |     |
|--|--|-----|
| 4.2.1  | Three-phase short circuit.....   | 83  |
| 4.2.2  | Line-to-line short circuit.....  | 95  |
| 4.2.3  | Line-to-line short circuit with earth connection.....  | 99  |
| 4.2.4  | Line-to-earth short circuit.....   | 101 |
| 4.3  | Peak short-circuit current $i_p$ .....   | 101 |
| 4.3.1  | Three-phase short circuit.....   | 101 |
| 4.3.2  | Line-to-line short circuit.....  | 105 |
| 4.3.3  | Line-to-line short circuit with earth connection.....  | 105 |
| 4.3.4  | Line-to-earth short circuit.....   | 107 |
| 4.4  | DC component of the short-circuit current.....   | 107 |
| 4.5  | Symmetrical short-circuit breaking current $I_b$ .....   | 107 |
| 4.5.1  | Far-from-generator short circuit.....  | 107 |
| 4.5.2  | Near-to-generator short circuit.....   | 109 |
| 4.6  | Steady-state short-circuit current $I_k$ .....   | 117 |
| 4.6.1  | Three-phase short circuit of one generator or one power station unit.....  | 117 |
| 4.6.2  | Three-phase short circuit in non-meshed networks.....  | 121 |
| 4.6.3  | Three-phase short circuit in meshed networks.....  | 123 |
| 4.6.4  | Unbalanced short circuits.....   | 123 |
| 4.6.5  | Short circuits at the low-voltage side of transformers, if one line conductor is interrupted at the high-voltage side..... | 125 |
| 4.7  | Terminal short circuit of asynchronous motors.....   | 127 |
| 4.8  | Joule integral and thermal equivalent short-circuit current.....   | 129 |
| Annex A (normative) Equations for the calculation of the factors $m$ and $n$ .....   |  | 137 |
| Figure 1 – Short-circuit current of a far-from-generator short circuit with constant a.c. component (schematic diagram).....   |  | 31  |
| Figure 2 – Short-circuit current of a near-to-generator short circuit with decaying a.c. component (schematic diagram).....  |  | 33  |
| Figure 3 – Characterization of short circuits and their currents.....  |  | 37  |
| Figure 4 – Illustration for calculating the initial symmetrical short-circuit current $I_k''$ in compliance with the procedure for the equivalent voltage source.....  |  | 39  |
| Figure 5 – Short-circuit impedances of a three-phase a.c. system at the short-circuit location F.....  |  | 43  |
| Figure 6 – System diagram and equivalent circuit diagram for network feeders.....  |  | 49  |
| Figure 7 – Three-winding transformer (example).....  |  | 55  |
| Figure 8 – Phasor diagram of a synchronous generator at rated conditions.....  |  | 63  |
| Figure 9 – Example for the estimation of the contribution from the asynchronous motors in relation to the total short-circuit current.....   |  | 75  |
| Figure 10 – Diagram to determine the short-circuit type (figure 3) for the highest short-circuit current referred to the symmetrical three-phase short-circuit current at the short-circuit location when the impedance angles of the sequence impedances $Z_{(1)}$ , $Z_{(2)}$ , $Z_{(0)}$ are identical..... |  | 81  |
| Figure 11 – Examples of single-fed short circuits.....   |  | 85  |
| Figure 12 – Example of a non-meshed network.....   |  | 89  |

|  |     |
|--|-----|
| Figure 13 – Short-circuit currents and partial short-circuit currents for three-phase short circuits between generator and unit transformer with or without on-load tap-changer, or at the connection to the auxiliary transformer of a power station unit and at the auxiliary busbar A ..... | 89  |
| Figure 14 – Example of a meshed network fed from several sources.....  | 97  |
| Figure 15 – Factor $\kappa$ for series circuit as a function of ratio $R/X$ or $X/R$ .....   | 101 |
| Figure 16 – Factor $\mu$ for calculation of short-circuit breaking current $I_b$ .....   | 111 |
| Figure 17 – Factor $q$ for the calculation of the symmetrical short-circuit breaking current of asynchronous motors .....  | 113 |
| Figure 18 – $\lambda_{\min}$ and $\lambda_{\max}$ factors for cylindrical rotor generators .....   | 119 |
| Figure 19 – Factors $\lambda_{\min}$ and $\lambda_{\max}$ for salient-pole generators .....  | 119 |
| Figure 20 – Transformer secondary short circuits, if one line (fuse) is opened on the high-voltage side of a transformer Dyn5 .....  | 125 |
| Figure 21 – Factor $m$ for the heat effect of the d.c. component of the short-circuit current (for programming, the equation for $m$ is given in annex A).....   | 131 |
| Figure 22 – Factor $n$ for the heat effect of the a.c. component of the short-circuit current (for programming, the equation for $n$ is given in annex A) .....  | 133 |
| Table 1 – Voltage factor $c$ .....   | 41  |
| Table 2 – Factors $\alpha$ and $\beta$ for the calculation of short-circuit currents with equation (90)<br>Rated transformation ratio $t_r = U_{rTHV}/U_{rTLV}$ .....  | 127 |
| Table 3 – Calculation of short-circuit currents of asynchronous motors in the case of a short circuit at the terminals (see 4.7) .....   | 129 |

## INTERNATIONAL ELECTROTECHNICAL COMMISSION

**SHORT-CIRCUIT CURRENTS IN THREE-PHASE AC SYSTEMS –****Part 0: Calculation of currents**

## FOREWORD

- 1) The IEC (International Electrotechnical Commission) is a worldwide organization for standardization comprising all national electrotechnical committees (IEC National Committees). The object of the IEC is to promote international co-operation on all questions concerning standardization in the electrical and electronic fields. To this end and in addition to other activities, the IEC publishes International Standards. Their preparation is entrusted to technical committees; any IEC National Committee interested in the subject dealt with may participate in this preparatory work. International, governmental and non-governmental organizations liaising with the IEC also participate in this preparation. The IEC collaborates closely with the International Organization for Standardization (ISO) in accordance with conditions determined by agreement between the two organizations.
- 2) The formal decisions or agreements of the IEC on technical matters express, as nearly as possible, an international consensus of opinion on the relevant subjects since each technical committee has representation from all interested National Committees.
- 3) The documents produced have the form of recommendations for international use and are published in the form of standards, technical specifications, technical reports or guides and they are accepted by the National Committees in that sense.
- 4) In order to promote international unification, IEC National Committees undertake to apply IEC International Standards transparently to the maximum extent possible in their national and regional standards. Any divergence between the IEC Standard and the corresponding national or regional standard shall be clearly indicated in the latter.
- 5) The IEC provides no marking procedure to indicate its approval and cannot be rendered responsible for any equipment declared to be in conformity with one of its standards.
- 6) Attention is drawn to the possibility that some of the elements of this International Standard may be the subject of patent rights. The IEC shall not be held responsible for identifying any or all such patent rights.

International Standard IEC 60909-0 has been prepared by IEC technical committee 73: Short-circuit currents.

This first edition cancels and replaces IEC 60909 published in 1988 and constitutes a technical revision.

The text of this standard is based on the following documents:

| FDIS        | Report on voting |
|-------------|------------------|
| 73/119/FDIS | 73/121/RVD       |

Full information on the voting for the approval of this standard can be found in the report on voting indicated in the above table.

Annex A forms an integral part of this standard.



This part of IEC 60909 shall be read in conjunction with the International Standards, Technical Reports and Technical Specifications mentioned below:

- IEC TR2 60909-1:1991, *Short-circuit current calculation in three-phase a.c. systems – Part 1: Factors for the calculation of short-circuit currents in three-phase a.c. systems according to IEC 60909-0*
- IEC TR3 60909-2:1992, *Electrical equipment – Data for short-circuit current calculations in accordance with IEC 60909*
- IEC 60909-3:1995, *Short-circuit current calculation in three-phase a.c. systems – Part 3: Currents during two separate simultaneous single-phase line-to-earth short circuits and partial short-circuit currents following through earth*
- IEC TR 60909-4:—, *Short-circuit current calculation in three-phase a.c. systems – Part 4: Examples for the calculation of short-circuit currents<sup>1)</sup>*

The committee has decided that the contents of this publication will remain unchanged until 2007. At this date, the publication will be

- reconfirmed;
- withdrawn;
- replaced by a revised edition, or
- amended.

---

1) To be published.

## SHORT-CIRCUIT CURRENTS IN THREE-PHASE AC SYSTEMS –

### Part 0: Calculation of currents

#### 1 General

##### 1.1 Scope

This part of IEC 60909 is applicable to the calculation of short-circuit currents:

- in low-voltage three-phase a.c. systems
- in high-voltage three-phase a.c. systems

operating at a nominal frequency of 50 Hz or 60 Hz.

Systems at highest voltages of 550 kV and above with long transmission lines need special consideration.

This part of IEC 60909 establishes a general, practicable and concise procedure leading to results, which are generally of acceptable accuracy. For this calculation method, an equivalent voltage source at the short-circuit location is introduced. This does not exclude the use of special methods, for example the superposition method, adjusted to particular circumstances, if they give at least the same precision. The superposition method gives the short-circuit current related to the one load flow presupposed. This method, therefore, does not necessarily lead to the maximum short-circuit current.

This part of IEC 60909 deals with the calculation of short-circuit currents in the case of balanced or unbalanced short circuits.

In case of an accidental or intentional conductive path between one line conductor and local earth, the following two cases must be clearly distinguished with regard to their different physical properties and effects (resulting in different requirements for their calculation):

- line-to-earth short circuit, occurring in a solidly earthed neutral system or an impedance earthed neutral system;
- a single line-to-earth fault, occurring in an isolated neutral earthed system or a resonance earthed neutral system. This fault is beyond the scope of, and is therefore not dealt with in, this standard.

For currents during two separate simultaneous single-phase line-to-earth short circuits in an isolated neutral system or a resonance earthed neutral system, see IEC 60909-3.

Short-circuit currents and short-circuit impedances may also be determined by system tests, by measurement on a network analyzer, or with a digital computer. In existing low-voltage systems it is possible to determine the short-circuit impedance on the basis of measurements at the location of the prospective short circuit considered.

The calculation of the short-circuit impedance is in general based on the rated data of the electrical equipment and the topological arrangement of the system and has the advantage of being possible both for existing systems and for systems at the planning stage.

In general, two short-circuit currents, which differ in their magnitude, are to be calculated:

- the maximum short-circuit current which determines the capacity or rating of electrical equipment; and
- the minimum short-circuit current which can be a basis, for example, for the selection of fuses, for the setting of protective devices, and for checking the run-up of motors.

NOTE The current in a three-phase short circuit is assumed to be made simultaneously in all poles. Investigations of non-simultaneous short circuits, which may lead to higher aperiodic components of short-circuit current, are beyond the scope of this standard.

This standard does not cover short-circuit currents deliberately created under controlled conditions (short-circuit testing stations).

This part of IEC 60909 does not deal with the calculation of short-circuit currents in installations on board ships and aeroplanes.

## 1.2 Normative references

The following normative documents contain provisions which, through reference in this text, constitute provisions of this part of IEC 60909. For dated references, subsequent amendments to, or revisions of, any of these publications do not apply. However, parties to agreements based on this part of IEC 60909 are encouraged to investigate the possibility of applying the most recent editions of the normative documents indicated below. For undated references, the latest edition of the normative document referred to applies. Members of IEC and ISO maintain registers of currently valid International Standards.

IEC 60038:1983, *IEC standard voltages*

IEC 60050(131):1978, *International Electrotechnical Vocabulary – Chapter 131: Electric and magnetic circuits*

IEC 60050(151):1978, *International Electrotechnical Vocabulary – Chapter 151: Electric and magnetic devices*

IEC 60050-195:1998, *International Electrotechnical Vocabulary – Part 195: Earthing and protection against electric shock*

IEC 60056:1987, *High-voltage alternating-current circuit-breakers*

IEC 60071-1:1993, *Insulation coordination – Part 1: Definitions, principles and rules*

IEC 60781:1989, *Application guide for calculation of short-circuit currents in low-voltage radial systems*

IEC 60865-1:1993, *Short-circuit currents – Calculation of effects – Part 1: Definitions and calculation methods*

IEC TR2 60909-1,— *Short-circuit currents calculation in three-phase a.c. systems – Part 1: Factors for the calculation of short-circuit currents in three-phase a.c. systems according to IEC 60909-0*<sup>1)</sup>

IEC TR3 60909-2:1992, *Electrical equipment – Data for short-circuit current calculations in accordance with IEC 60909*

IEC 60909-3:1995, *Short-circuit current calculation in three-phase a.c. systems – Part 3: Currents during two separate simultaneous single phase line-to-earth short circuits and partial short-circuit currents flowing through earth*

IEC 60909-4,— *Short-circuit current calculation in three-phase a.c. systems – Part 4: Examples for the calculation of short-circuit currents*<sup>1)</sup>

IEC 60949:1988, *Calculation of thermally permissible short-circuit currents, taking into account non-adiabatic heating effects*

IEC 60986:1989, *Guide to the short-circuit temperature limits of electrical cables with a rated voltage from 1,8/3 (3,6) kV to 18/30 (36) kV*

### 1.3 Definitions

For the purposes of this part of IEC 60909, the definitions given in IEC 60050(131) and the following definitions apply.

#### 1.3.1

##### **short circuit**

accidental or intentional conductive path between two or more conductive parts forcing the electric potential differences between these conductive parts to be equal or close to zero

##### 1.3.1.1

##### **line-to-line short circuit**

accidental or intentional conductive path between two or more line conductors with or without earth connection

##### 1.3.1.2

##### **line-to-earth short circuit**

accidental or intentional conductive path in a solidly earthed neutral system or an impedance earthed neutral system between a line conductor and local earth

#### 1.3.2

##### **short-circuit current**

over-current resulting from a short circuit in an electric system

NOTE It is necessary to distinguish between the short-circuit current at the short-circuit location and partial short-circuit currents in the network branches (see figure 3) at any point of the network.

<sup>1)</sup> To be published.

**1.3.3****prospective (available) short-circuit current**

current that would flow if the short circuit were replaced by an ideal connection of negligible impedance without any change of the supply (see note of 1.1)

**1.3.4****symmetrical short-circuit current**

r.m.s. value of the a.c. symmetrical component of a prospective (available) short-circuit current (see 1.3.3), the aperiodic component of current, if any, being neglected

**1.3.5****initial symmetrical short-circuit current  $I_k''$** 

r.m.s. value of the a.c. symmetrical component of a prospective (available) short-circuit current (see 1.3.3), applicable at the instant of short circuit if the impedance remains at zero-time value (see figures 1 and 2)

**1.3.6****initial symmetrical short-circuit power  $S_k''$** 

fictitious value determined as a product of the initial symmetrical short-circuit current  $I_k''$  (see 1.3.5), the nominal system voltage  $U_n$  (see 1.3.13) and the factor  $\sqrt{3}$ :  $S_k'' = \sqrt{3} U_n I_k''$

NOTE The initial symmetrical short-circuit power  $S_k''$  is not used for the calculation procedure in this standard. If  $S_k''$  is used in spite of this in connection with short-circuit calculations, for instance to calculate the internal impedance of a network feeder at the connection point Q, then the definition given should be used in the following form:  $S_{kQ}'' = \sqrt{3} U_{nQ} I_{kQ}''$  or  $Z_Q = cU_{nQ}^2 / S_{kQ}''$ .

**1.3.7****decaying (aperiodic) component  $i_{d.c.}$  of short-circuit current**

mean value between the top and bottom envelope of a short-circuit current decaying from an initial value to zero according to figures 1 and 2

**1.3.8****peak short-circuit current  $i_p$** 

maximum possible instantaneous value of the prospective (available) short-circuit current (see figures 1 and 2)

NOTE The magnitude of the peak short-circuit current varies in accordance with the moment at which the short circuit occurs. The calculation of the three-phase peak short-circuit current  $i_p$  applies to the line conductor and to the instant at which the greatest possible short-circuit current exists. Sequential short circuits are not considered.

**1.3.9****symmetrical short-circuit breaking current  $I_b$** 

r.m.s. value of an integral cycle of the symmetrical a.c. component of the prospective short-circuit current at the instant of contact separation of the first pole to open of a switching device

**1.3.10****steady-state short-circuit current  $I_k$** 

r.m.s. value of the short-circuit current which remains after the decay of the transient phenomena (see figures 1 and 2)

**1.3.11****symmetrical locked-rotor current  $I_{LR}$** 

highest symmetrical r.m.s. current of an asynchronous motor with locked rotor fed with rated voltage  $U_{TM}$  at rated frequency

**1.3.12****equivalent electric circuit**

model to describe the behaviour of a circuit by means of a network of ideal elements [IEV 131-01-33]

**1.3.13****nominal system voltage  $U_n$** 

voltage (line-to-line) by which a system is designated, and to which certain operating characteristics are referred

NOTE Values are given in IEC 60038.

**1.3.14****equivalent voltage source  $cU_n / \sqrt{3}$** 

voltage of an ideal source applied at the short-circuit location in the positive-sequence system for calculating the short-circuit current according to 2.3. This is the only active voltage of the network

**1.3.15****voltage factor  $c$** 

ratio between the equivalent voltage source and the nominal system voltage  $U_n$  divided by  $\sqrt{3}$ . The values are given in table 1

NOTE The introduction of a voltage factor  $c$  is necessary for various reasons. These are:

- voltage variations depending on time and place,
- changing of transformer taps,
- neglecting loads and capacitances by calculations according to 2.3.1,
- the subtransient behaviour of generators and motors.

**1.3.16****subtransient voltage  $E''$  of a synchronous machine**

r.m.s. value of the symmetrical internal voltage of a synchronous machine which is active behind the subtransient reactance  $X_d''$  at the moment of short circuit

**1.3.17****far-from-generator short circuit**

short circuit during which the magnitude of the symmetrical a.c. component of the prospective (available) short-circuit current remains essentially constant (see figure 1)

**1.3.18****near-to-generator short circuit**

short circuit to which at least one synchronous machine contributes a prospective initial symmetrical short-circuit current which is more than twice the machine's rated current, or a short circuit to which asynchronous motors contribute more than 5 % of the initial symmetrical short-circuit current  $I_k''$  without motors (see figure 2)

**1.3.19****short-circuit impedances at the short-circuit location F****1.3.19.1****positive-sequence short-circuit impedance  $\underline{Z}_{(1)}$  of a three-phase a.c. system**

impedance of the positive-sequence system as viewed from the short-circuit location (see 2.3.2 and figure 5a)

**1.3.19.2****negative-sequence short-circuit impedance  $\underline{Z}_{(2)}$  of a three-phase a.c. system**

impedance of the negative-sequence system as viewed from the short-circuit location (see 2.3.2 and figure 5b)

**1.3.19.3****zero-sequence short-circuit impedance  $\underline{Z}_{(0)}$  of a three-phase a.c. system**

impedance of the zero-sequence system as viewed from the short-circuit location (see 2.3.2 and figure 5c). It includes three times the neutral-to-earth impedance  $\underline{Z}_N$

**1.3.19.4****short-circuit impedance  $\underline{Z}_k$  of a three-phase a.c. system**

abbreviated expression for the positive-sequence short-circuit impedance  $\underline{Z}_{(1)}$  according to 1.3.19.1 for the calculation of three-phase short-circuit currents

**1.3.20****short-circuit impedances of electrical equipment****1.3.20.1****positive-sequence short-circuit impedance  $\underline{Z}_{(1)}$  of electrical equipment**

ratio of the line-to-neutral voltage to the short-circuit current of the corresponding line conductor of electrical equipment when fed by a symmetrical positive-sequence system of voltages (see clause 2 and IEC 60909-4)

NOTE The index of symbol  $\underline{Z}_{(1)}$  may be omitted if there is no possibility of confusion with the negative-sequence and the zero-sequence short-circuit impedances.

**1.3.20.2****negative-sequence short-circuit impedance  $\underline{Z}_{(2)}$  of electrical equipment**

ratio of the line-to-neutral voltage to the short-circuit current of the corresponding line conductor of electrical equipment when fed by a symmetrical negative-sequence system of voltages (see clause 2 and IEC 60909-4).

**1.3.20.3****zero-sequence short-circuit impedance  $\underline{Z}_{(0)}$  of electrical equipment**

ratio of the line-to-earth voltage to the short-circuit current of one line conductor of electrical equipment when fed by an a.c. voltage source, if the three paralleled line conductors are used for the outgoing current and a fourth line and/or earth as a joint return (see clause 2 and IEC 60909-4)

**1.3.21****subtransient reactance  $X_d''$  of a synchronous machine**

effective reactance at the moment of short circuit. For the calculation of short-circuit currents the saturated value of  $X_d''$  is taken

NOTE When the reactance  $X_d''$  in ohms is divided by the rated impedance  $Z_{rG} = U_{rG}^2 / S_{rG}$  of the synchronous machine, the result in per unit is represented by a small letter  $x_d'' = X_d'' / Z_{rG}$ .

**1.3.22****minimum time delay  $t_{\min}$** 

shortest time between the beginning of the short-circuit current and the contact separation of the first pole to open of the switching device

NOTE The time  $t_{\min}$  is the sum of the shortest possible operating time of a protective relay and the shortest opening time of a circuit-breaker. It does not take into account adjustable time delays of tripping devices.

**1.3.23****thermal equivalent short-circuit current  $I_{\text{th}}$** 

the r.m.s. value of a current having the same thermal effect and the same duration as the actual short-circuit current, which may contain a d.c. component and may subside in time

**1.4 Symbols, subscripts and superscripts**

The equations given in this standard are written without specifying units. The symbols represent physical quantities possessing both numerical values and dimensions that are independent of units, provided a consistent unit system is chosen, for example the international system of units (SI). Symbols of complex quantities are underlined, for example  $\underline{Z} = R + jX$ .

**1.4.1 Symbols**

|                   |   |
|-------------------|---|
| $A$               | Initial value of the d.c. component $i_{\text{d.c.}}$   |
| $\underline{a}$   | Complex operator  |
| $a$               | A ratio between unbalanced short-circuit current and three phase short-circuit current              |
| $c$               | Voltage factor  |
| $cU_n / \sqrt{3}$ | Equivalent voltage source (r.m.s.)  |
| $E''$             | Subtransient voltage of a synchronous machine   |
| $f$               | Frequency (50 Hz or 60 Hz)  |
| $I_b$             | Symmetrical short-circuit breaking current (r.m.s.)   |
| $I_k$             | Steady-state short-circuit current (r.m.s.)   |
| $I_{kP}$          | Steady-state short-circuit current at the terminals (poles) of a generator with compound excitation |
| $I_k'$            | Initial symmetrical short-circuit current (r.m.s.)  |
| $I_{LR}$          | Symmetrical locked-rotor current of an asynchronous motor   |
| $I_r$             | Rated current of electrical equipment   |
| $I_{\text{th}}$   | Thermal equivalent short-circuit current  |
| $i_{\text{d.c.}}$ | d.c. component of short-circuit current   |
| $i_p$             | Peak short-circuit current  |
| $K$               | Correction factor for impedances  |
| $m$               | Factor for the heat effect of the d.c. component  |
| $n$               | Factor for the heat effect of the a.c. component  |
| $p$               | Pair of poles of an asynchronous motor  |
| $p_G$             | Range of generator voltage regulation   |
| $p_T$             | Range of transformer voltage adjustment   |
| $P_{krT}$         | Total loss in transformer windings at rated current   |
| $P_{rM}$          | Rated active power of an asynchronous motor ( $P_{rM} = S_{rM} \cos \varphi_{rM} \eta_{rM}$ )       |
| $q$               | Factor for the calculation of breaking current of asynchronous motors                               |
| $q_n$             | Nominal cross-section   |



|                             |   |
|-----------------------------|---|
| $R$ resp. $r$               | Resistance, absolute respectively relative value  |
| $R_G$                       | Resistance of a synchronous machine   |
| $R_{Gf}$                    | Fictitious resistance of a synchronous machine when calculating $i_p$   |
| $S_k''$                     | Initial symmetrical short-circuit power (see 1.3.6)   |
| $S_r$                       | Rated apparent power of electrical equipment  |
| $t_{\min}$                  | Minimum time delay  |
| $t_r$                       | Rated transformation ratio (tap-changer in main position); $t_r \geq 1$   |
| $T_k$                       | Duration of the short-circuit current   |
| $U_m$                       | Highest voltage for equipment, line-to-line (r.m.s.)  |
| $U_n$                       | Nominal system voltage, line-to-line (r.m.s.)   |
| $U_r$                       | Rated voltage, line-to-line (r.m.s.)  |
| $u_{kr}$                    | Rated short-circuit voltage of a transformer in per cent  |
| $u_{kR}$                    | Short-circuit voltage of a short-circuit limiting reactor in per cent   |
| $u_{Rr}$                    | Rated resistive component of the short-circuit voltage of a transformer in per cent   |
| $u_{Xr}$                    | Rated reactive component of the short-circuit voltage of a transformer in per cent  |
| $U_{(1)}, U_{(2)}, U_{(0)}$ | Positive-, negative-, zero-sequence voltage   |
| $X$ resp. $x$               | Reactance, absolute respectively relative value   |
| $X_d$ resp. $X_q$           | Synchronous reactance, direct axis respectively quadrature axis   |
| $X_{dP}$                    | Fictitious reactance of a generator with compound excitation in the case of steady-state short circuit at the terminals (poles) |
| $X_d''$ resp. $X_q''$       | Subtransient reactance of a synchronous machine (saturated value), direct axis respectively quadrature axis                     |
| $x_d$                       | Unsaturated synchronous reactance, relative value   |
| $x_{d \text{ sat}}$         | Saturated synchronous reactance, relative value, reciprocal of the saturated no-load short-circuit ratio                        |
| $Z$ resp. $z$               | Impedance, absolute respectively relative value   |
| $Z_k$                       | Short-circuit impedance of a three-phase a.c. system  |
| $Z_{(1)}$                   | Positive-sequence short-circuit impedance   |
| $Z_{(2)}$                   | Negative-sequence short-circuit impedance   |
| $Z_{(0)}$                   | Zero-sequence short-circuit impedance   |
| $\eta$                      | Efficiency of asynchronous motors   |
| $\kappa$                    | Factor for the calculation of the peak short-circuit current  |
| $\lambda$                   | Factor for the calculation of the steady-state short-circuit current  |
| $\mu$                       | Factor for the calculation of the symmetrical short-circuit breaking current  |
| $\mu_0$                     | Absolute permeability of vacuum, $\mu_0 = 4\pi \cdot 10^{-7}$ H/m   |
| $\rho$                      | Resistivity   |
| $\varphi$                   | Phase angle   |
| $\theta_e$                  | Conductor temperature at the end of the short circuit   |
| 01                          | Positive-sequence neutral reference   |
| 02                          | Negative-sequence neutral reference   |
| 00                          | Zero-sequence neutral reference   |

**1.4.2 Subscripts**

|                |  |
|----------------|--|
| (1)            | Positive-sequence component  |
| (2)            | Negative-sequence component  |
| (0)            | Zero-sequence component  |
| a.c            | Alternating current  |
| d.c            | Direct current   |
| f              | Fictitious   |
| k or k3        | Three-phase short circuit (see figure 3a)  |
| k1             | Line-to-earth short circuit, line-to-neutral short circuit (see figure 3d)   |
| k2             | Line-to-line short circuit (see figure 3b)   |
| k2E resp. kE2E | Line-to-line short circuit with earth connection (see figure 3c)   |
| K              | Impedances or reactances calculated with an impedance correction factor $K_T$ , $K_G$ or $K_S$ respectively $K_{SO}$ |
| max            | Maximum  |
| min            | Minimum  |
| n              | Nominal value (IEV 151-04-01)  |
| r              | Rated value (IEV 151-04-03)  |
| rsl            | Resulting  |
| t              | Transferred value  |
| AT             | Auxiliary transformer  |
| B              | Busbar   |
| E              | Earth  |
| F              | Short-circuit location   |
| G              | Generator  |
| HV             | High-voltage, high-voltage side of a transformer   |
| LV             | Low-voltage, low-voltage side of a transformer   |
| L              | Line   |
| LR             | Locked rotor   |
| L1, L2, L3     | Line conductors of a three-phase a.c. system   |
| M              | Asynchronous motor or group of asynchronous motors   |
| <del>M</del>   | Without motor  |
| MV             | Medium-voltage, medium-voltage side of a transformer   |
| N              | Neutral of a three-phase a.c. system, starpoint of a generator or a transformer                                      |
| P              | Terminal, pole   |
| Q              | Feeder connection point  |
| R              | Short-circuit limiting reactor   |
| S              | Power station unit (generator and unit transformer with on-load tap-changer)   |
| SO             | Power station unit (generator and unit transformer with constant transformation ratio or off-load taps)              |
| T              | Transformer  |

### 1.4.3 Superscripts

- " Subtransient (initial) value
- ' Resistance or reactance per unit length
- b Before the short circuit

## 2 Characteristics of short-circuit currents: calculating method

### 2.1 General

A complete calculation of short-circuit currents should give the currents as a function of time at the short-circuit location from the initiation of the short circuit up to its end, corresponding to the instantaneous value of the voltage at the beginning of the short circuit (see figures 1 and 2).

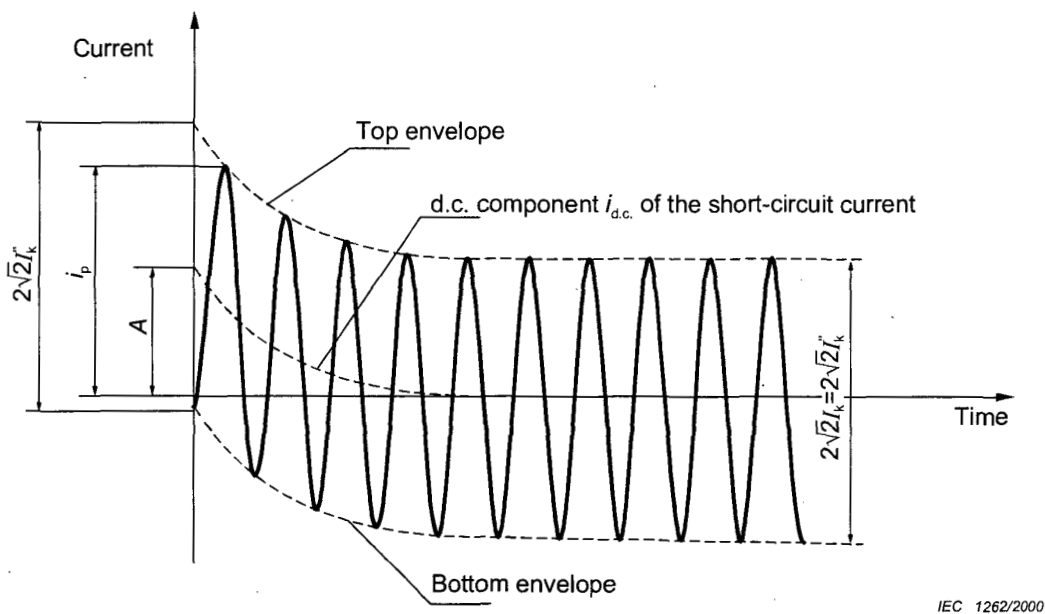

$I_k''$  = initial symmetrical short-circuit current

$i_p$  = peak short-circuit current

$I_k$  = steady-state short-circuit current

$i_{d.c.}$  = d.c. component of short-circuit current

$A$  = initial value of the d.c. component  $i_{d.c.}$

**Figure 1 – Short-circuit current of a far-from-generator short circuit with constant a.c. component (schematic diagram)**

In most practical cases a determination like this is not necessary. Depending on the application of the results, it is of interest to know the r.m.s. value of the symmetrical a.c. component and the peak value  $i_p$  of the short-circuit current following the occurrence of a short circuit. The highest value  $i_p$  depends on the time constant of the decaying aperiodic component and the frequency  $f$ , that is on the ratio  $R/X$  or  $X/R$  of the short-circuit impedance  $Z_k$ , and is reached if the short circuit starts at zero voltage.  $i_p$  also depends on the decay of the symmetrical a.c. component of the short-circuit current.

In meshed networks there are several direct-current time constants. That is why it is not possible to give an easy method of calculating  $i_p$  and  $i_{d.c.}$ . Special methods to calculate  $i_p$  with sufficient accuracy are given in 4.3.

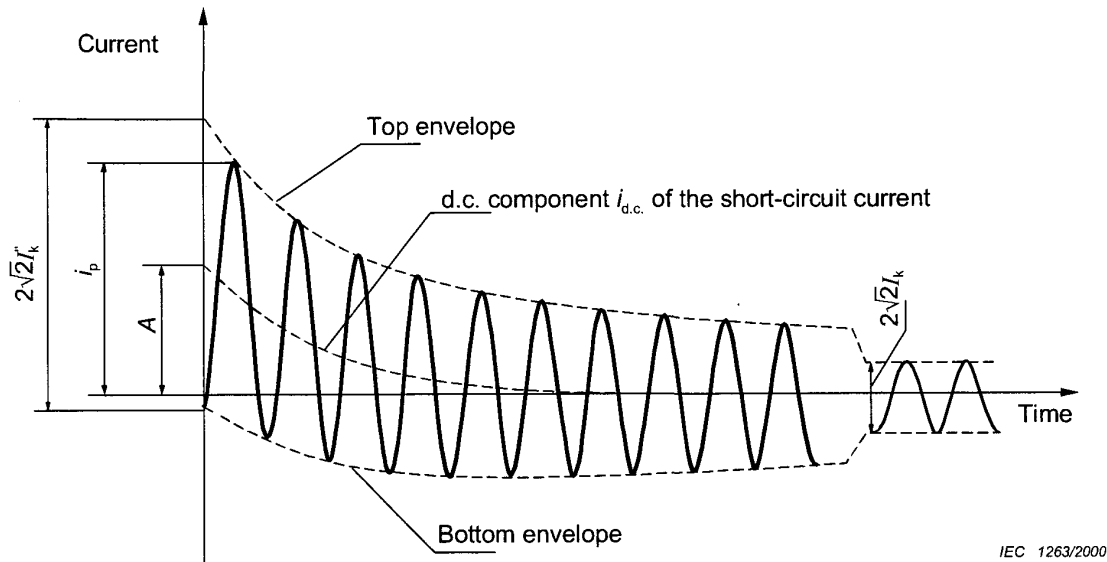

IEC 1263/2000

$I_k''$  = initial symmetrical short-circuit current

$i_p$  = peak short-circuit current

$I_k$  = steady-state short-circuit current

$i_{d.c.}$  = d.c. component of short-circuit current

$A$  = initial value of the d.c. component  $i_{d.c.}$

**Figure 2 – Short-circuit current of a near-to-generator short circuit with decaying a.c. component (schematic diagram)**

## 2.2 Calculation assumptions

The calculation of maximum and minimum short-circuit currents is based on the following simplifications.

- a) For the duration of the short circuit there is no change in the type of short circuit involved, that is, a three-phase short circuit remains three-phase and a line-to-earth short circuit remains line-to-earth during the time of short circuit.
- b) For the duration of the short circuit, there is no change in the network involved.
- c) The impedance of the transformers is referred to the tap-changer in main position. This is admissible, because the impedance correction factor  $K_T$  for network transformers is introduced.
- d) Arc resistances are not taken into account.
- e) All line capacitances and shunt admittances and non-rotating loads, except those of the zero-sequence system, are neglected.

Despite these assumptions being not strictly true for the power systems considered, the result of the calculation does fulfil the objective to give results which are generally of acceptable accuracy.

For balanced and unbalanced short circuits as shown in figure 3, it is useful to calculate the short-circuit currents by application of symmetrical components (see 2.3.2).

When calculating short-circuit currents in systems with different voltage levels, it is necessary to transfer impedance values from one voltage level to another, usually to that voltage level at which the short-circuit current is to be calculated. For per unit or other similar unit systems, no transformation is necessary if these systems are coherent, i.e.  $U_{fTHV}/U_{fTLV} = U_{nHV}/U_{nLV}$  for each transformer in the system with partial short-circuit currents.  $U_{fTHV}/U_{fTLV}$  is normally not equal to  $U_{nHV}/U_{nLV}$  (see IEC 60909-2 and the examples given in IEC 60909-4).

The impedances of the equipment in superimposed or subordinated networks are to be divided or multiplied by the square of the rated transformation ratio  $t_r$ . Voltages and currents are to be converted by the rated transformation ratio  $t_r$ .

## 2.3 Method of calculation

### 2.3.1 Equivalent voltage source at the short-circuit location

The method used for calculation is based on the introduction of an equivalent voltage source at the short-circuit location. The equivalent voltage source is the only active voltage of the system. All network feeders, synchronous and asynchronous machines are replaced by their internal impedances (see clause 3).

In all cases it is possible to determine the short-circuit current at the short-circuit location F with the help of an equivalent voltage source. Operational data and the load of consumers, tap-changer position of transformers, excitation of generators, and so on, are dispensable; additional calculations about all the different possible load flows at the moment of short circuit are superfluous.

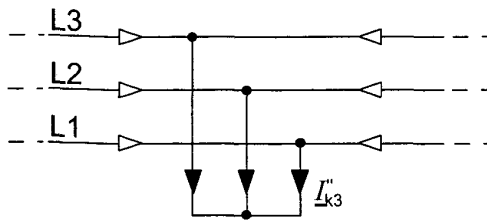

IEC 1264/2000

Figure 3a – Three-phase short circuit

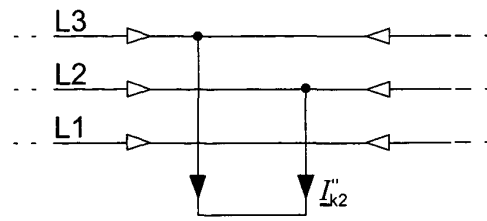

IEC 1265/2000

Figure 3b – Line-to-line short circuit

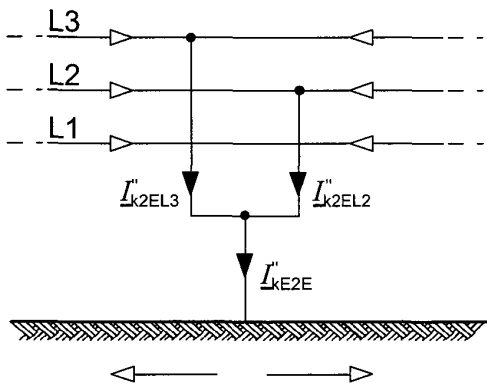

IEC 1266/2000

Figure 3c – Line-to-line short circuit with earth connection

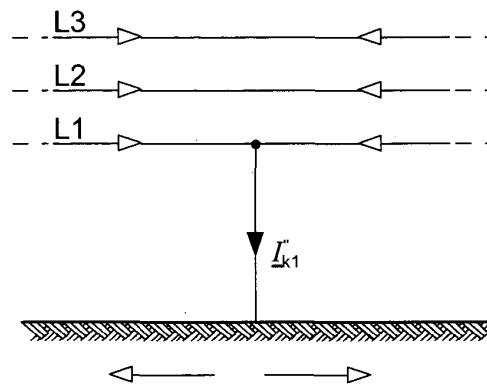

IEC 1267/2000

Figure 3d – Line-to-earth short circuit

NOTE The direction of current arrows is chosen arbitrarily.

**Figure 3 – Characterization of short circuits and their currents**

Figure 4 shows an example of the equivalent voltage source at the short-circuit location F as the only active voltage of the system fed by a transformer without or with on-load tap-changer. All other active voltages in the system are assumed to be zero. Thus the network feeder in figure 4a is represented by its internal impedance  $Z_{Q1}$ , transferred to the LV-side of the transformer (see 3.2) and the transformer by its impedance referred to the LV-side (see 3.3). Shunt admittances (for example, line capacitances and passive loads) are not to be considered when calculating short-circuit currents in accordance with figure 4b.

If there are no national standards, it seems adequate to choose a voltage factor  $c$  according to table 1, considering that the highest voltage in a normal (undisturbed) system does not differ, on average, by more than approximately +5 % (some LV systems) or +10 % (some HV systems) from the nominal system voltage  $U_n$ .

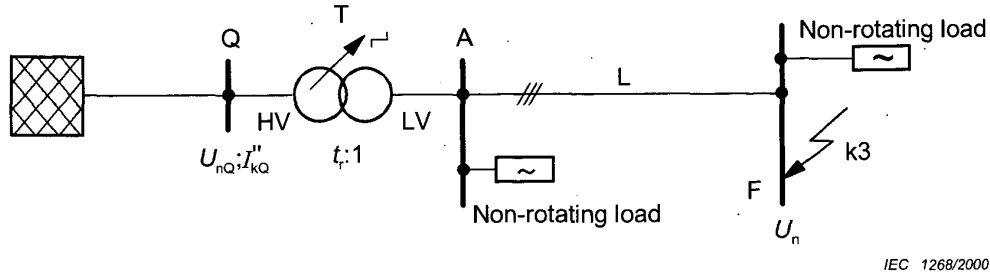

Figure 4a – System diagram

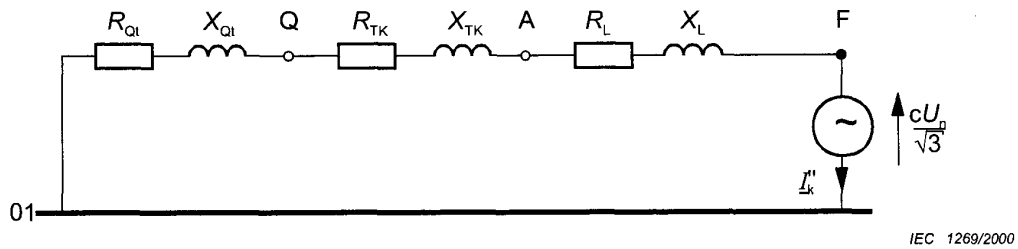

Figure 4b – Equivalent circuit diagram of the positive-sequence system

NOTE The index (1) for the impedances of the positive-sequence system is omitted. 01 marks the positive-sequence neutral reference. The impedance of the network feeder and the transformer are related to the LV-side and the last one is also corrected with  $K_T$  (see 3.3.3).

Figure 4 – Illustration for calculating the initial symmetrical short-circuit current  $I''_k$  in compliance with the procedure for the equivalent voltage source

Table 1 – Voltage factor  $c$ 

| Nominal voltage<br>$U_n$  | Voltage factor $c$ for the calculation of            |   |
|---|--|---|
|   | maximum<br>short-circuit currents<br>$c_{\max}^{1)}$ | minimum<br>short-circuit currents<br>$c_{\min}$ |
| <b>Low voltage</b><br>100 V to 1 000 V<br>(IEC 60038, table I)  | 1,05 <sup>3)</sup><br>1,10 <sup>4)</sup>             | 0,95  |
| <b>Medium voltage</b><br>>1 kV to 35 kV<br>(IEC 60038, table III)   | 1,10   | 1,00  |
| <b>High voltage<sup>2)</sup></b><br>>35 kV<br>(IEC 60038, table IV)   |  |   |
| <sup>1)</sup> $c_{\max}U_n$ should not exceed the highest voltage $U_m$ for equipment of power systems.<br><sup>2)</sup> If no nominal voltage is defined $c_{\max}U_n = U_m$ or $c_{\min}U_n = 0,90 \times U_m$ should be applied.<br><sup>3)</sup> For low-voltage systems with a tolerance of +6 %, for example systems renamed from 380 V to 400 V.<br><sup>4)</sup> For low-voltage systems with a tolerance of +10 %. |  |   |

### 2.3.2 Application of symmetrical components

In three-phase a.c. systems the calculation of the current values resulting from balanced and unbalanced short circuits is simplified by the use of symmetrical components. This postulates that the electrical equipment has a balanced structure, for example in the case of transposed overhead lines. The results of the short-circuit current calculation have an acceptable accuracy also in the case of untransposed overhead lines.

Using this method, the currents in each line conductor are found by superposing the currents of the three symmetrical component systems:

- positive-sequence current  $I_{(1)}$ ;
- negative-sequence current  $I_{(2)}$ ;
- zero-sequence current  $I_{(0)}$ .

Taking the line conductor L1 as reference, the currents  $I_{L1}$ ,  $I_{L2}$ , and  $I_{L3}$  are given by

$$I_{L1} = I_{(1)} + I_{(2)} + I_{(0)} \quad (1a)$$

$$I_{L2} = \underline{a}^2 I_{(1)} + \underline{a} I_{(2)} + I_{(0)} \quad (1b)$$

$$I_{L3} = \underline{a} I_{(1)} + \underline{a}^2 I_{(2)} + I_{(0)} \quad (1c)$$

$$\underline{a} = -\frac{1}{2} + j\frac{1}{2}\sqrt{3}; \quad \underline{a}^2 = -\frac{1}{2} - j\frac{1}{2}\sqrt{3} \quad (2)$$



Figure 5a – Positive-sequence short-circuit impedance  $Z_{(1)}$ Figure 5b – Negative-sequence short-circuit impedance  $Z_{(2)}$ Figure 5c – Zero-sequence short-circuit impedance  $Z_{(0)}$ 

Figure 5 – Short-circuit impedances of a three-phase a.c. system at the short-circuit location F

Each of the three symmetrical component systems has its own impedance.

The following types of unbalanced short circuits are treated in this standard:

- line-to-line short circuit (see figure 3b),
- line-to-line short circuit with earth connection (see figure 3c),
- line-to-earth short circuit (see figure 3d).

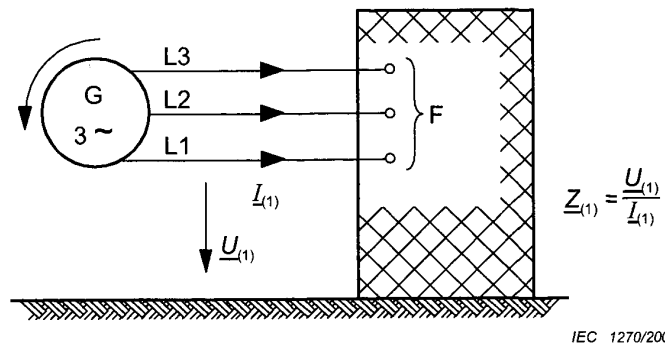
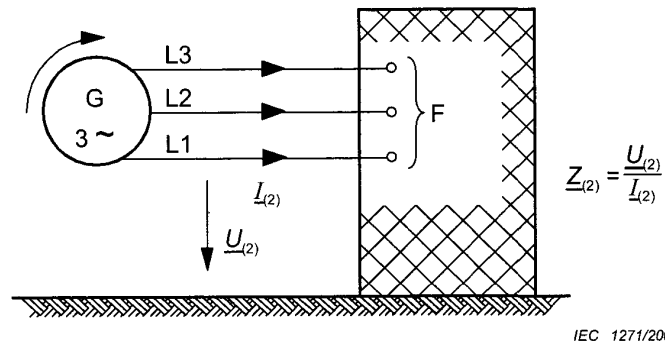
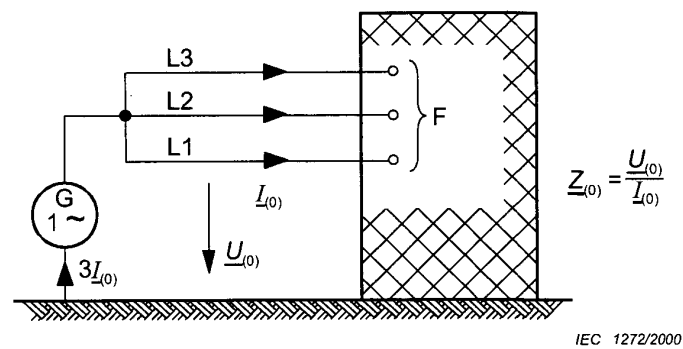
For the purpose of this standard, one has to make a distinction between short-circuit impedances at the short-circuit location F and the short-circuit impedances of individual electrical equipment.

The positive-sequence short-circuit impedance  $Z_{(1)}$  at the short circuit location F is obtained according to figure 5a, when a symmetrical system of voltages of positive-sequence phase order is applied to the short-circuit location F, and all synchronous and asynchronous machines are replaced by their internal impedances.

The negative-sequence short-circuit impedance  $Z_{(2)}$  at the short-circuit location F is obtained according to figure 5b, when a symmetrical system of voltages of negative-sequence phase order is applied to the short-circuit location F.

The values of positive-sequence and negative-sequence impedances can differ from each other only in the case of rotating machines. When far-from-generator short circuits are calculated, it is generally allowed to take  $Z_{(2)} = Z_{(1)}$ .

The zero-sequence short-circuit impedance  $Z_{(0)}$  at the short-circuit location F is obtained according to figure 5c, if an a.c. voltage is applied between the three short-circuited line conductors and the joint return (for example earthing system, neutral conductor, earth wires, cable sheaths, cable armouring).

When calculating unbalanced short-circuit currents in medium- or high-voltage systems and applying an equivalent voltage source at the short-circuit location, the zero-sequence capacitances of lines and the zero-sequence shunt admittances are to be considered for isolated neutral systems, resonant earthed systems and earthed neutral systems with an earth fault factor (see IEC 60071-1) higher than 1,4.

The capacitances of lines (overhead lines and cables) of low-voltage networks may be neglected in the positive-, negative- and zero-sequence system.

Neglecting the zero-sequence capacitances of lines in earthed neutral systems leads to results which are slightly higher than the real values of the short-circuit currents. The deviation depends on the configuration of the network.

Except for special cases, the zero-sequence short-circuit impedances at the short-circuit location differ from the positive-sequence and negative-sequence short-circuit impedances.

## 2.4 Maximum short-circuit currents

When calculating maximum short-circuit currents, it is necessary to introduce the following conditions:

- voltage factor  $c_{\max}$  according to table 1 shall be applied for the calculation of maximum short-circuit currents in the absence of a national standard;

- choose the system configuration and the maximum contribution from power plants and network feeders which lead to the maximum value of short-circuit current at the short-circuit location, or for accepted sectioning of the network to control the short-circuit current;
- when equivalent impedances  $\underline{Z}_Q$  are used to represent external networks, the minimum equivalent short-circuit impedance shall be used which corresponds to the maximum short-circuit current contribution from the network feeders;
- motors shall be included if appropriate in accordance with 3.8 and 3.9;
- resistance  $R_L$  of lines (overhead lines and cables) are to be introduced at a temperature of 20 °C.

## 2.5 Minimum short-circuit currents

When calculating minimum short-circuit currents, it is necessary to introduce the following conditions:

- voltage factor  $c_{min}$  for the calculation of minimum short-circuit currents shall be applied according to table 1;
- choose the system configuration and the minimum contribution from power stations and network feeders which lead to a minimum value of short-circuit current at the short-circuit location;
- motors shall be neglected;
- resistances  $R_L$  of lines (overhead lines and cables, line conductors, and neutral conductors) shall be introduced at a higher temperature:

$$R_L = [1 + \alpha(\theta_e - 20\text{ °C})] \cdot R_{L20} \quad (3)$$

where

$R_{L20}$  is the resistance at a temperature of 20 °C;

$\theta_e$  is the conductor temperature in degrees Celsius at the end of the short-circuit duration;

$\alpha$  is a factor equal to 0,004/K, valid with sufficient accuracy for most practical purposes for copper, aluminium and aluminium alloy.

NOTE For  $\theta_e$ , see for instance IEC 60865-1, IEC 60949 and IEC 60986.

## 3 Short-circuit impedances of electrical equipment

### 3.1 General

In network feeders, transformers, overhead lines, cables, reactors and similar equipment, positive-sequence and negative-sequence short-circuit impedances are equal:  $\underline{Z}_{(1)} = \underline{Z}_{(2)}$ .

The zero-sequence short-circuit impedance  $\underline{Z}_{(0)} = \underline{U}_{(0)} / \underline{I}_{(0)}$  is determined by assuming an a.c. voltage between the three paralleled conductors and the joint return (for example earth, earthing arrangement, neutral conductor, earth wire, cable sheath, and cable armouring). In this case, the three-fold zero-sequence current flows through the joint return.

The impedances of generators (G), network transformers (T) and power station units (S) shall be multiplied with the impedance correction factors  $K_G$ ,  $K_T$  and  $K_S$  or  $K_{S0}$  when calculating short-circuit currents with the equivalent voltage source at the short-circuit location according to this standard.

NOTE Examples for the introduction of impedance correction factors are given in IEC 60909-4.

### 3.2 Network feeders

If a three-phase short circuit in accordance with figure 6a is fed from a network in which only the initial symmetrical short-circuit current  $I''_{kQ}$  at the feeder connection point Q is known, then the equivalent impedance  $Z_Q$  of the network (positive-sequence short-circuit impedance) at the feeder connection point Q should be determined by:

$$Z_Q = \frac{cU_{nQ}}{\sqrt{3} I''_{kQ}} \quad (4)$$

If  $R_Q/X_Q$  is known, then  $X_Q$  shall be calculated as follows:

$$X_Q = \frac{Z_Q}{\sqrt{1 + (R_Q / X_Q)^2}} \quad (5)$$

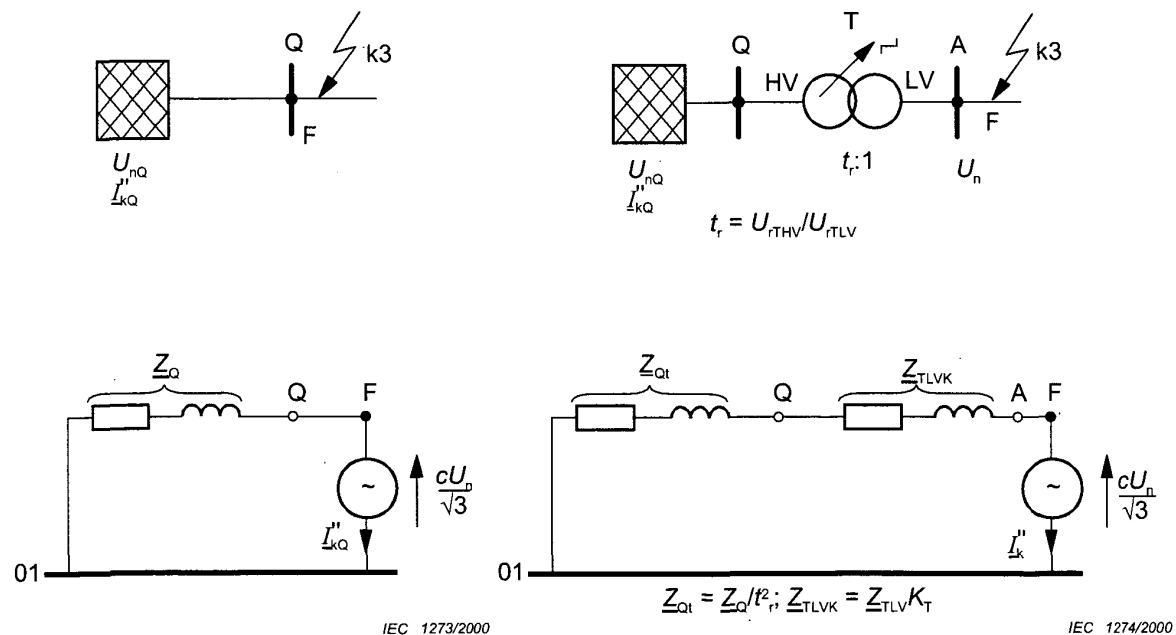

Figure 6a – Without transformer

Figure 6b – With transformer

Figure 6 – System diagram and equivalent circuit diagram for network feeders

If a short circuit in accordance with figure 6b is fed by a transformer from a medium or high-voltage network in which only the initial symmetrical short-circuit current  $I''_{kQ}$  at the feeder connection point Q is known, then the positive-sequence equivalent short-circuit impedance  $Z_{Q1}$  referred to the low-voltage side of the transformer is to be determined by:

$$Z_{Q1} = \frac{cU_{nQ}}{\sqrt{3} I''_{kQ}} \cdot \frac{1}{t_r^2} \quad (6)$$

where

$U_{nQ}$  is the nominal system voltage at the feeder connection point Q;

$I''_{kQ}$  is the initial symmetrical short-circuit current at the feeder connection point Q;

$c$  is the voltage factor (see table 1) for the voltage  $U_{nQ}$ ;

$t_r$  is the rated transformation ratio at which the on-load tap-changer is in the main position.

In the case of high-voltage feeders with nominal voltages above 35 kV fed by overhead lines, the equivalent impedance  $Z_Q$  may in many cases be considered as a reactance, i.e.  $Z_Q = 0 + jX_Q$ . In other cases, if no accurate value is known for the resistance  $R_Q$  of network feeders, one may substitute  $R_Q = 0,1 X_Q$  where  $X_Q = 0,995 Z_Q$ .

The initial symmetrical short-circuit currents  $I''_{kQmax}$  and  $I''_{kQmin}$  on the high-voltage side of the transformer shall be given by the supply company or by an adequate calculation according to this standard.

In special cases the zero-sequence equivalent short-circuit impedance of network feeders may need to be considered, depending on the winding configuration and the starpoint earthing of the transformer.

NOTE See for instance items 6 and 8 in table 1 of IEC 60909-4.

### 3.3 Transformers

#### 3.3.1 Two-winding transformers

The positive-sequence short-circuit impedances of two-winding transformers  $Z_T = R_T + jX_T$  with and without on-load tap-changer can be calculated from the rated transformer data as follows:

$$Z_T = \frac{u_{kr}}{100\%} \cdot \frac{U_{rT}^2}{S_{rT}} \quad (7)$$

$$R_T = \frac{u_{kr}}{100\%} \cdot \frac{U_{rT}^2}{S_{rT}} = \frac{P_{krT}}{3I_{rT}^2} \quad (8)$$

$$X_T = \sqrt{Z_T^2 - R_T^2} \quad (9)$$

where

$U_{rT}$  is the rated voltage of the transformer on the high-voltage or low-voltage side;

$I_{rT}$  is the rated current of the transformer on the high-voltage or low-voltage side;

$S_{rT}$  is the rated apparent power of the transformer;

$P_{krT}$  is the total loss of the transformer in the windings at rated current;

$u_{kr}$  is the short-circuit voltage at rated current in per cent;

$u_{Rr}$  is the rated resistive component of the short-circuit voltage in per cent.

The resistive component  $u_{Rr}$  can be calculated from the total losses  $P_{krT}$  in the windings at the rated current  $I_{rT}$ , both referred to the same transformer side (see equation (8)).

The ratio  $R_T/X_T$  generally decreases with transformer size. For large transformers the resistance is so small that the impedance may be assumed to consist only of reactance when calculating short-circuit currents. The resistance is to be considered if the peak short-circuit current  $i_p$  or the d.c. component  $i_{d.c.}$  is to be calculated.

The necessary data for the calculation of  $\underline{Z}_T = R_T + jX_T = \underline{Z}_{(1)} = \underline{Z}_{(2)}$  may be taken from the rating plate. The zero-sequence short-circuit impedance  $\underline{Z}_{(0)T} = R_{(0)T} + jX_{(0)T}$  may be obtained from the rating plate or from the manufacturer.

NOTE Actual data for two-winding transformers used as network transformers or in power stations are given in IEC 60909-2. Zero-sequence impedance arrangements for the calculation of unbalanced short-circuit currents are given in IEC 60909-4.

### 3.3.2 Three-winding transformers

In the case of three-winding transformers, the positive-sequence short-circuit impedances  $\underline{Z}_A$ ,  $\underline{Z}_B$ , and  $\underline{Z}_C$  referring to figure 7, can be calculated by the three short-circuit impedances (referred to side A of the transformer):

$$\underline{Z}_{AB} = \left( \frac{u_{RrAB}}{100\%} + j \frac{u_{XrAB}}{100\%} \right) \cdot \frac{U_{rTA}^2}{S_{rTAB}} \quad (\text{side C open}) \quad (10a)$$

$$\underline{Z}_{AC} = \left( \frac{u_{RrAC}}{100\%} + j \frac{u_{XrAC}}{100\%} \right) \cdot \frac{U_{rTA}^2}{S_{rTAC}} \quad (\text{side B open}) \quad (10b)$$

$$\underline{Z}_{BC} = \left( \frac{u_{RrBC}}{100\%} + j \frac{u_{XrBC}}{100\%} \right) \cdot \frac{U_{rTA}^2}{S_{rTBC}} \quad (\text{side A open}) \quad (10c)$$

with 
$$u_{Xr} = \sqrt{u_{kr}^2 - u_{Rr}^2} \quad (10d)$$

by the equations

$$\underline{Z}_A = \frac{1}{2} (\underline{Z}_{AB} + \underline{Z}_{AC} - \underline{Z}_{BC}) \quad (11a)$$

$$\underline{Z}_B = \frac{1}{2} (\underline{Z}_{BC} + \underline{Z}_{AB} - \underline{Z}_{AC}) \quad (11b)$$

$$\underline{Z}_C = \frac{1}{2} (\underline{Z}_{AC} + \underline{Z}_{BC} - \underline{Z}_{AB}) \quad (11c)$$

where

$U_{rTA}$  is the rated voltage of side A;

$S_{rTAB}$  is the rated apparent power between sides A and B;

$S_{rTAC}$  is the rated apparent power between sides A and C;

$S_{rTBC}$  is the rated apparent power between sides B and C;

$u_{rTAB}, u_{xTAB}$  are the rated resistive and reactive components of the short-circuit voltage, given in per cent between sides A and B;

$u_{rTAC}, u_{xTAC}$  are the rated resistive and reactive components of the short-circuit voltage, given in per cent between sides A and C;

$u_{rTBC}, u_{xTBC}$  are the rated resistive and reactive components of the short-circuit voltage, given in per cent between sides B and C.

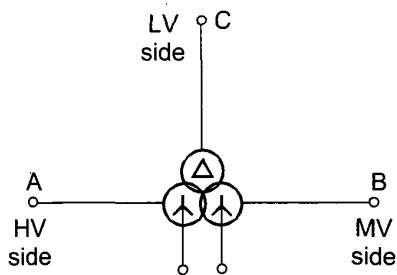

IEC 1275/2000

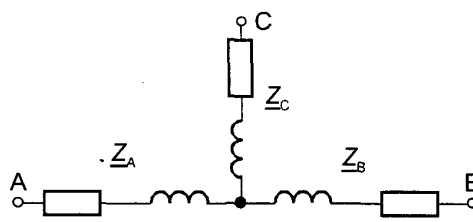

01

IEC 1276/2000

Figure 7a – Denotation of winding connections

Figure 7b – Equivalent circuit diagram  
(positive-sequence system)

Figure 7 – Three-winding transformer (example)

The zero-sequence impedances of three-winding transformers may be obtained from the manufacturer.

NOTE Examples for the impedances of three-winding transformers are given in IEC 60909-2. Additional information may be found in IEC 60909-4.

### 3.3.3 Impedance correction factors for two- and three-winding network transformers

A network transformer is a transformer connecting two or more networks at different voltages. For two-winding transformers with and without on-load tap-changer, an impedance correction factor  $K_T$  is to be introduced in addition to the impedance evaluated according to equations (7) to (9):  $Z_{TK} = K_T Z_T$  where  $Z_T = R_T + jX_T$ .

$$K_T = 0,95 \frac{c_{\max}}{1 + 0,6 x_T} \quad (12a)$$

where  $x_T$  is the relative reactance of the transformer  $x_T = X_T / (U_{rT}^2 / S_{rT})$  and  $c_{\max}$  from table 1 is related to the nominal voltage of the network connected to the low-voltage side of the network transformer. This correction factor shall not be introduced for unit transformers of power station units (see 3.7).

If the long-term operating conditions of network transformers before the short circuit are known for sure, then the following equation (12b) may be used instead of equation (12a).

$$K_T = \frac{U_n}{U^b} \cdot \frac{c_{\max}}{1 + x_T \left( I_T^b / I_{rT} \right) \sin \varphi_T^b} \quad (12b)$$

where

$c_{\max}$  is the voltage factor from table 1, related to the nominal voltage of the network connected to the low-voltage side of the network transformer;

$x_T = X_T / (U_{rT}^2 / S_{rT})$ ;

$U^b$  is the highest operating voltage before short circuit;

$I_T^b$  is the highest operating current before short circuit (this depends on network configuration and relevant reliability philosophy);

$\varphi_T^b$  is the angle of power factor before short circuit.

The impedance correction factor shall be applied also to the negative-sequence and the zero-sequence impedance of the transformer when calculating unbalanced short-circuit currents. Impedances  $Z_N$  between the starpoint of transformers and earth are to be introduced as  $3 Z_N$  into the zero-sequence system without a correction factor.

For three-winding transformers with and without on-load tap-changer, three impedance correction factors can be found using the relative values of the reactances of the transformer (see 3.3.2):

$$K_{TAB} = 0,95 \frac{c_{\max}}{1 + 0,6 x_{TAB}} \quad (13a)$$

$$K_{TAC} = 0,95 \frac{c_{\max}}{1 + 0,6 x_{TAC}} \quad (13b)$$

$$K_{TBC} = 0,95 \frac{c_{\max}}{1 + 0,6 x_{TBC}} \quad (13c)$$



Together with the impedances  $\underline{Z}_{AB}$ ,  $\underline{Z}_{AC}$  and  $\underline{Z}_{BC}$  according to equation (10), the corrected values  $\underline{Z}_{ABK} = K_{TAB} \underline{Z}_{AB}$ ,  $\underline{Z}_{ACK} = K_{TAC} \underline{Z}_{AC}$  and  $\underline{Z}_{BCK} = K_{TBC} \underline{Z}_{BC}$  can be found. With these impedances the corrected equivalent impedances  $\underline{Z}_{AK}$ ,  $\underline{Z}_{BK}$  and  $\underline{Z}_{CK}$  shall be calculated using the procedure given in equation (11).

The three impedance correction factors given in equation (13) shall be introduced also to the negative-sequence and to the zero-sequence systems of the three-winding transformer.

Impedances between a starpoint and earth shall be introduced without correction factor.

NOTE Equivalent circuits of the positive-sequence and the zero-sequence system are given in IEC 60909-4, table 1, item 4 to 7 for different cases of starpoint earthing. In general the impedances  $\underline{Z}_{(0)A}$ ,  $\underline{Z}_{(0)B}$  or  $\underline{Z}_{(0)C}$  are similar to  $\underline{Z}_{(1)A}$ ,  $\underline{Z}_{(1)B}$  or  $\underline{Z}_{(1)C}$ . An example for the introduction of the correction factors of equation (13) to the positive-sequence and the zero-sequence system impedances of the equivalent circuits is given in 2.2 of IEC 60909-4.

If in special cases, for instance in the case of auto-transformers with on-load tap-changer, the short-circuit voltages of transformers  $u_{k+}$  at the position  $+p_T$  and  $u_{k-}$  at the position  $-p_T$  (see IEC 60909-2) both are considerably higher than the value  $u_{kr}$ , it may be unnecessary to introduce impedance correction factors  $K_T$ .

### 3.4 Overhead lines and cables

The positive-sequence short-circuit impedance  $\underline{Z}_L = R_L + jX_L$  may be calculated from the conductor data, such as the cross-sections and the centre-distances of the conductors.

For measurement of the positive-sequence impedance  $\underline{Z}_{(1)} = R_{(1)} + jX_{(1)}$  and the zero-sequence short-circuit impedance  $\underline{Z}_{(0)} = R_{(0)} + jX_{(0)}$ , see IEC 60909-4. Sometimes it is possible to estimate the zero-sequence impedances with the ratios  $R_{(0)L}/R_L$  and  $X_{(0)L}/X_L$  (see IEC 60909-2).

The impedances  $\underline{Z}_{(1)L}$  and  $\underline{Z}_{(0)L}$  of low-voltage and high-voltage cables depend on national techniques and standards and may be taken from IEC 60909-2 or from textbooks or manufacturer's data.

For higher temperatures than 20 °C, see equation (3).

The effective resistance per unit length  $R'_L$  of overhead lines at the conductor temperature 20 °C may be calculated from the nominal cross-section  $q_n$  and the resistivity  $\rho$ :

$$R'_L = \frac{\rho}{q_n} \quad (14)$$

NOTE The following values for resistivity may be used:

|        |  |
|--------|--|
| Copper | $\rho = \frac{1}{54} \frac{\Omega\text{mm}^2}{\text{m}}$ |
|--------|--|

|           |  |
|-----------|--|
| Aluminium | $\rho = \frac{1}{34} \frac{\Omega\text{mm}^2}{\text{m}}$ |
|-----------|--|

|                 |  |
|-----------------|--|
| Aluminium alloy | $\rho = \frac{1}{31} \frac{\Omega\text{mm}^2}{\text{m}}$ |
|-----------------|--|

The reactance per unit length  $X'_L$  for overhead lines may be calculated, assuming transposition, from:

$$X'_L = 2\pi f \frac{\mu_0}{2\pi} \left( \frac{1}{4n} + \ln \frac{d}{r} \right) = f \mu_0 \left( \frac{1}{4n} + \ln \frac{d}{r} \right) \quad (15)$$

where

$d = \sqrt[3]{d_{L1L2} d_{L2L3} d_{L3L1}}$  geometric mean distance between conductors, or the centre of bundles;

$r$  is the radius of a single conductor. In the case of conductor bundles,  $r$  is to be substituted by  $r_B = \sqrt[nrR^{n-1}]$ , where  $R$  is the bundle radius (see IEC 60909-2);

$n$  is the number of bundled conductors; for single conductors  $n = 1$ ;

$\mu_0 = 4\pi \times 10^{-7}$  H/m.

### 3.5 Short-circuit limiting reactors

The positive-sequence, the negative-sequence, and the zero-sequence short-circuit impedances are equal, assuming geometric symmetry. Short-circuit current-limiting reactors shall be treated as a part of the short-circuit impedance.

$$Z_R = \frac{u_{kR}}{100\%} \frac{U_n}{\sqrt{3} I_{rR}} \quad \text{and} \quad R_R \ll X_R \quad (16)$$

where

$u_{kR}$  and  $I_{rR}$  are given on the rating plate;

$U_n$  is the nominal system voltage.

### 3.6 Synchronous machines

#### 3.6.1 Synchronous generators

When calculating initial symmetrical short-circuit currents in systems fed directly from generators without unit transformers, for example in industrial networks or in low-voltage networks, the following impedance has to be used in the positive-sequence system (see also figure 8):

$$\underline{Z}_{GK} = K_G \underline{Z}_G = K_G (R_G + jX'_d) \quad (17)$$

with the correction factor:

$$K_G = \frac{U_n}{U_{rG}} \cdot \frac{c_{\max}}{1 + x'_d \sin \varphi_{rG}} \quad (18)$$

where

$c_{\max}$  is the voltage factor according to table 1;

$U_n$  is the nominal voltage of the system;

$U_{rG}$  is the rated voltage of the generator;

$Z_{GK}$  is the corrected subtransient impedance of the generator;

$Z_G$  is the subtransient impedance of the generator in the positive-sequence system:

$$Z_G = R_G + jX_d'';$$

$\varphi_{rG}$  is the phase angle between  $I_{rG}$  and  $U_{rG}/\sqrt{3}$ ;

$x_d''$  is the relative subtransient reactance of the generator related to the rated impedance:

$$x_d'' = X_d''/Z_{rG} \text{ where } Z_{rG} = U_{rG}^2/S_{rG}$$

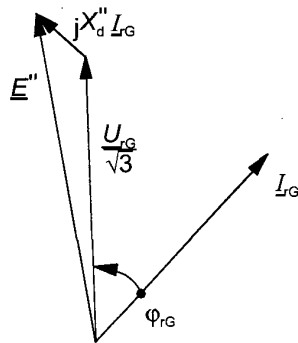

IEC 1277/2000

**Figure 8 – Phasor diagram of a synchronous generator at rated conditions**

The correction factor  $K_G$  (equation (18)) for the calculation of the corrected subtransient impedance  $Z_{GK}$  (equation (17)) has been introduced because the equivalent voltage source  $cU_r/\sqrt{3}$  is used instead of the subtransient voltage  $E''$  behind the subtransient reactance of the synchronous generator (see figure 8).

The following values for the fictitious resistances  $R_{Gf}$  may be used for the calculation of the peak short-circuit current with sufficient accuracy.

$$R_{Gf} = 0,05 X_d'' \text{ for generators with } U_{rG} > 1 \text{ kV and } S_{rG} \geq 100 \text{ MVA}$$

$$R_{Gf} = 0,07 X_d'' \text{ for generators with } U_{rG} > 1 \text{ kV and } S_{rG} < 100 \text{ MVA}$$

$$R_{Gf} = 0,15 X_d'' \text{ for generators with } U_{rG} \leq 1 \text{ 000 V}$$

In addition to the decay of the d.c. component, the factors 0,05, 0,07, and 0,15 also take into account the decay of the a.c. component of the short-circuit current during the first half-cycle after the short circuit took place. The influence of various winding-temperatures on  $R_{Gf}$  is not considered.

NOTE The values  $R_{Gf}$  should be used for the calculation of the peak short-circuit current. These values cannot be used when calculating the aperiodic component  $i_{d.c.}$  of the short-circuit current according to equation (64). The effective resistance of the stator of synchronous machines lies generally much below the given values for  $R_{Gf}$ . In this case the manufacturer's values for  $R_G$  should be used.

If the terminal voltage of the generator is different from  $U_{rG}$ , it may be necessary to introduce  $U_G = U_{rG} (1 + p_G)$  instead of  $U_{rG}$  to equation (18), when calculating three-phase short-circuit currents.

For the short-circuit impedances of synchronous generators in the negative-sequence system, the following applies with  $K_G$  from equation (18):

$$\underline{Z}_{(2)GK} = K_G (R_{(2)G} + jX_{(2)G}) = K_G \underline{Z}_{(2)G} \approx K_G \underline{Z}_G = K_G (R_G + jX_d'') \quad (19)$$

If the values of  $X_d''$  and  $X_q''$  are different, the value  $X_{(2)G} = (X_d'' + X_q'')/2$  can be used.

For the short-circuit impedance of synchronous generators in the zero-sequence system, the following applies with  $K_G$  from equation (18):

$$\underline{Z}_{(0)GK} = K_G (R_{(0)G} + jX_{(0)G}) \quad (20)$$

When an impedance is present between the starpoint of the generator and earth, the correction factor  $K_G$  shall not be applied to this impedance.

The need for the calculation of minimum short-circuit currents may arise because of underexcited operation of generators (low-load condition in cable systems or in systems including long overhead lines, hydro pumping stations). In this case special considerations beyond the scope and procedure given in this standard have to be taken into account (see for instance 2.2.1 of IEC 60909-1).

### 3.6.2 Synchronous compensators and motors

When calculating the initial symmetrical short-circuit current  $I_k''$ , the peak short-circuit current  $i_p$ , the symmetrical short-circuit breaking current  $I_b$ , and the steady-state short-circuit current  $I_k$ , synchronous compensators are treated in the same way as synchronous generators.

If synchronous motors have a voltage regulation, they are treated like synchronous generators. If not, they are subject to additional considerations.

## 3.7 Power station unit

### 3.7.1 Power station units with on-load tap-changer

For the calculation of short-circuit currents of power station units (S) with on-load tap-changer, the following equation for the impedance of the whole power station unit is used for short circuits on the high-voltage side of the unit transformer (see figure 11c):

$$\underline{Z}_S = K_S (t_r^2 \underline{Z}_G + \underline{Z}_{THV}) \quad (21)$$

with the correction factor

$$K_S = \frac{U_{nQ}^2}{U_{rG}^2} \cdot \frac{U_{rTLV}^2}{U_{rTHV}^2} \cdot \frac{c_{\max}}{1 + |x_d'' - x_T| \sin \varphi_{rG}} \quad (22)$$

where

$\underline{Z}_S$  is the corrected impedance of a power station unit with on-load tap-changer referred to the high-voltage side;

$\underline{Z}_G$  is the subtransient impedance of the generator  $\underline{Z}_G = R_G + jX_d''$  (without correction factor  $K_G$ );

$\underline{Z}_{THV}$  is the impedance of the unit transformer related to the high-voltage side (without correction factor  $K_T$ );

$U_{nQ}$  is the nominal system voltage at the feeder connection point Q of the power station unit;

$U_{rG}$  is the rated voltage of the generator;

$\varphi_{rG}$  is the phase angle between  $\underline{I}_{rG}$  and  $\underline{U}_{rG}/\sqrt{3}$ ;

$x_d''$  is the relative subtransient reactance of the generator related to the rated impedance:

$$x_d'' = X_d''/Z_{rG} \text{ where } Z_{rG} = U_{rG}^2/S_{rG};$$

$x_T$  is the relative reactance of the unit transformer at the main position of the on-load tap-changer:  $x_T = X_T/(U_{rT}^2/S_{rT})$ ;

$t_r$  is the rated transformation ratio of the unit transformer:  $t_r = U_{rTHV}/U_{rTLV}$ .

If the minimum operating voltage  $U_{Qmin}^b \geq U_{nQ}$  at the high-voltage side of the unit transformer of the power station unit is well established from long-term operating experience of the system, then it is possible to use the product  $U_{nQ} \cdot U_{Qmin}^b$  instead of  $U_{nQ}^2$  in equation (22). If, on the other hand, the highest partial short-circuit current of a power station unit is searched for, then  $U_{nQ}$  should be used instead of  $U_{Qmin}^b$ , i.e. equation (22) should be chosen.

It is assumed that the operating voltage at the terminals of the generator is equal to  $U_{rG}$ . If the voltage  $U_G$  is permanently higher than  $U_{rG}$ , then  $U_{Gmax} = U_{rG} (1 + p_G)$  should be introduced instead of  $U_{rG}$ , with, for instance,  $p_G = 0,05$ .

If only overexcited operation is expected, then for the calculation of unbalanced short-circuit currents the correction factor  $K_S$  from equation (22) shall be used for both the positive-sequence and the negative-sequence system impedances of the power station unit. The correction factor  $K_S$  shall also be applied to the zero-sequence system impedance of the power station unit, excepting, if present, an impedance component between the star point of the transformer and earth.

If underexcited operation of the power station unit is expected at some time (for instance to a large extent especially in pumped storage plants), then only when calculating unbalanced short-circuit currents with earth connection (see figures 3c and 3d) the application of  $K_S$  according to equation (22) may lead to results at the non-conservative side. Special considerations are necessary in this case, for instance with the superposition method.

When calculating the partial short-circuit current  $I''_{kS}$  at the high-voltage side of the unit transformer or the total short-circuit current at the short-circuit location on the high-voltage side of a power station unit, it is not necessary to take into account the contribution to the short-circuit  $I''_{kS}$  of the motors connected to the auxiliary transformer.

NOTE IEC 60909-4 provides help for users in such cases.

### 3.7.2 Power station units without on-load tap-changer

For the calculation of short-circuit currents of power station units (SO) without on-load tap-changer, the following equation for the impedance of the whole power station unit is used for a short circuit on the high-voltage side of the unit transformer (see figure 11c):

$$\underline{Z}_{SO} = K_{SO} \left( t_r^2 \underline{Z}_G + \underline{Z}_{THV} \right) \quad (23)$$

with the correction factor

$$K_{SO} = \frac{U_{nQ}}{U_{rG} (1 + p_G)} \cdot \frac{U_{rTLV}}{U_{rTHV}} \cdot (1 \pm p_T) \cdot \frac{c_{max}}{1 + x''_d \sin \varphi_{rG}} \quad (24)$$

where

$\underline{Z}_{SO}$  is the corrected impedance of a power station unit without on-load tap-changer, i.e. constant transformation ratio  $t_r$ , related to the high-voltage side;

$\underline{Z}_G$  is the subtransient impedance of the generator  $\underline{Z}_G = R_G + jX''_d$  (without correction factor  $K_G$ );

$\underline{Z}_{THV}$  is the impedance of the unit transformer related to the high-voltage side (without correction factor  $K_T$ );

$U_{nQ}$  is the nominal system voltage at the feeder connection point Q of the power station unit

$U_{rG}$  is the rated voltage of the generator;  $U_{Gmax} = U_{rG} (1 + p_G)$ , with for instance  $p_G = 0,05$  up to  $0,10$ ;

$\varphi_{rG}$  is the phase angle between  $\underline{I}_{rG}$  and  $\underline{U}_{rG}/\sqrt{3}$  (see 3.6.1);

$x''_d$  is the relative subtransient reactance of the generator related to the rated impedance:  
 $x''_d = X''_d/Z_{rG}$  where  $Z_{rG} = U_{rG}^2/S_{rG}$ ;

$t_r$  is the rated transformation ratio of the unit transformer  $t_r = U_{rTHV}/U_{rTLV}$ ;

$1 \pm p_T$  is to be introduced if the unit transformer has off-load taps and if one of these taps is permanently used, if not choose  $1 \pm p_T = 1$ . If the highest partial short-circuit current of the power station unit at the high-voltage side of the unit transformer with off-load taps is searched for, choose  $1 - p_T$ .

In the case of unbalanced short circuits, the impedance correction factor  $K_{SO}$  from equation (24) shall be applied to both the positive-sequence and the negative-sequence system impedances of the power station unit. The correction factor  $K_{SO}$  shall also be applied to the zero-sequence system impedance of the power station unit excepting, if present, an impedance component between the star point of the transformer and earth.

The correction factor is not conditional upon whether the generator was overexcited or underexcited before the short circuit.

When calculating the partial short-circuit current  $I''_{kSO}$  at the high-voltage side of the unit transformer or the total short-circuit current at the short-circuit location on the high-voltage side of a power station unit, it is not necessary to take into account the contribution to the short-circuit current  $I''_{kSO}$  of the motors connected to the auxiliary transformer.

### 3.8 Asynchronous motors

#### 3.8.1 General

Medium-voltage motors and low-voltage motors contribute to the initial symmetrical short-circuit current  $I''_k$ , to the peak short-circuit current  $i_p$ , to the symmetrical short-circuit breaking current  $I_b$  and, for unbalanced short circuits, also to the steady-state short-circuit current  $I_k$ .

Medium-voltage motors have to be considered in the calculation of maximum short-circuit current (see 2.4 and 2.5). Low-voltage motors are to be taken into account in auxiliaries of power stations and in industrial and similar installations, for example in networks of chemical and steel industries and pump-stations.

The contribution of asynchronous motors in low-voltage power supply systems to the short-circuit current  $I''_k$  may be neglected if their contribution is not higher than 5 % of the initial short-circuit current  $I''_{kM}$  calculated without motors.

$$\sum I_{rM} \leq 0,01 I''_{kM} \quad (25)$$

where

$\sum I_{rM}$  is the sum of the rated currents of motors connected directly (without transformers) to the network where the short circuit occurs;

$I''_{kM}$  is the initial symmetrical short-circuit current without influence of motors.

In the calculation of short-circuit currents, those medium-voltage and low-voltage motors may be neglected, provided that, according to the circuit diagram (interlocking) or to the process (reversible drives), they are not switched in at the same time.

The impedance  $\underline{Z}_M = R_M + jX_M$  of asynchronous motors in the positive- and negative-sequence systems can be determined by:

$$Z_M = \frac{1}{I_{LR}/I_{rM}} \cdot \frac{U_{rM}}{\sqrt{3} I_{rM}} = \frac{1}{I_{LR}/I_{rM}} \cdot \frac{U_{rM}^2}{S_{rM}} \quad (26)$$

where

$U_{rM}$  is the rated voltage of the motor;

$I_{rM}$  is the rated current of the motor;

$S_{rM}$  is the rated apparent power of the motor ( $S_{rM} = P_{rM}/(\eta_{rM} \cos \varphi_{rM})$ );

$I_{LR}/I_{rM}$  is the ratio of the locked-rotor current to the rated current of the motor.

If  $R_M/X_M$  is known, then  $X_M$  shall be calculated as follows:

$$X_M = \frac{Z_M}{\sqrt{1 + (R_M/X_M)^2}} \quad (27)$$

The following relations may be used with sufficient accuracy:

$R_M/X_M = 0,10$ , with  $X_M = 0,995 Z_M$  for medium-voltage motors with powers  $P_{rM}$  per pair of poles  $\geq 1$  MW;

$R_M/X_M = 0,15$ , with  $X_M = 0,989 Z_M$  for medium-voltage motors with powers  $P_{rM}$  per pair of poles  $< 1$  MW;

$R_M/X_M = 0,42$ , with  $X_M = 0,922 Z_M$  for low-voltage motor groups with connection cables.

For the calculation of the initial short-circuit currents according to 4.2, asynchronous motors are substituted by their impedances  $Z_M$  according to equation (26) in the positive-sequence and negative-sequence systems. The zero-sequence system impedance  $Z_{(0)M}$  of the motor shall be given by the manufacturer, if needed (see 4.7).

### 3.8.2 Contribution to short-circuit currents by asynchronous motors

Medium- and low-voltage motors, which are connected by two-winding transformers to the network in which the short circuit occurs, may be neglected in the calculation of short-circuit currents for a short circuit at the feeder connection point Q (see figure 9), if:

$$\frac{\sum P_{rM}}{\sum S_{rT}} \leq \frac{0,8}{\left| \frac{c100 \sum S_{rT}}{\sqrt{3} U_{nQ} I''_{kQ}} - 0,3 \right|} \quad (28)$$

where

$\sum P_{rM}$  is the sum of the rated active powers of the medium-voltage and the low-voltage motors which shall be considered;

$\sum S_{rT}$  is the sum of the rated apparent powers of all transformers, through which the motors are directly fed;

$I''_{kQ}$  is the initial symmetrical short-circuit current at the feeder connection point Q without supplement of the motors;

$U_{nQ}$  is the nominal voltage of the system at the feeder connection point Q.



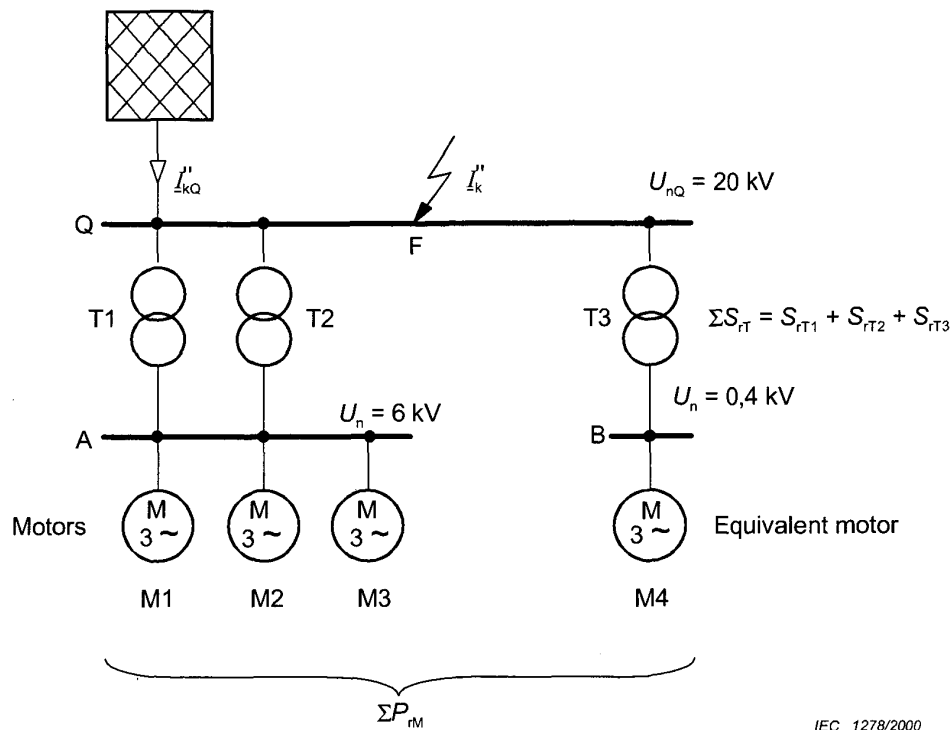

IEC 1278/2000

**Figure 9 – Example for the estimation of the contribution from the asynchronous motors in relation to the total short-circuit current**

Low-voltage motors are usually connected to the busbar by cables with different lengths and cross-sections. For simplification of the calculation, groups of motors including their connection cables may be combined to a single equivalent motor (see motor M4 in figure 9).

For these equivalent asynchronous motors, including their connection cables, the following may be used:

$Z_M$  is the impedance according to equation (26);

$I_{TM}$  is the sum of the rated currents of all motors in a group of motors (equivalent motor);

$$I_{LR}/I_{TM} = 5;$$

$$R_M/X_M = 0,42, \text{ leading to } \kappa_M = 1,3;$$

$$P_{TM}/p = 0,05 \text{ MW if nothing definite is known, where } p \text{ is the number of pairs of poles.}$$

For a short circuit at the busbar B in figure 9, the partial short-circuit current of the low-voltage motor group M4 may be neglected, if the condition  $I_{TM4} \leq 0,01 I''_{kT3}$  holds.  $I_{TM4}$  is the rated current of the equivalent motor M4.  $I''_{kT3}$  is the initial symmetrical short-circuit current at the low-voltage side of the transformer T3 during a short circuit at B without contribution from the equivalent motor M4.

In the case of a short circuit on the medium-voltage side (for example, short-circuit locations Q or A in figure 9), it is possible to simplify the calculation of  $Z_M$  according to equation (26) with, for instance, the rated current of the transformer T3 ( $I_{T3 LV}$ ) in figure 9 instead of the rated current  $I_{M4}$  of the equivalent motor M4.

The estimation according to equation (28) is not allowed in the case of three-winding transformers.

### 3.9 Static converters

Reversible static converter-fed drives (for example, rolling mill drives) are considered for three-phase short circuits only, if the rotational masses of the motors and the static equipment provide reverse transfer of energy for deceleration (a transient inverter operation) at the time of short circuit. Then they contribute only to the initial symmetrical short-circuit current  $I_k''$  and to the peak short-circuit current  $i_p$ . They do not contribute to the symmetrical short-circuit breaking current  $I_b$  and the steady-state short-circuit current  $I_k$ .

As a result, reversible static converter-fed drives are treated for the calculation of short-circuit currents in a similar way as asynchronous motors. The following applies:

$Z_M$  is the impedance according to equation (26);

$U_{TM}$  is the rated voltage of the static converter transformer on the network side or rated voltage of the static converter, if no transformer is present;

$I_{TM}$  is the rated current of the static converter transformer on the network side or rated current of the static converter, if no transformer is present;

$$I_{LR}/I_{TM} = 3;$$

$$R_M/X_M = 0,10 \text{ with } X_M = 0,995 Z_M.$$

All other static converters are disregarded for the short-circuit current calculation according to this standard.

### 3.10 Capacitors and non-rotating loads

The calculation methods given in clause 2 allow for line capacitances, parallel admittances and non-rotating loads as stated in 2.3.2 not to be taken into account, except those of the zero-sequence system.

Regardless of the time of short-circuit occurrence, the discharge current of the shunt capacitors may be neglected for the calculation of the peak short-circuit current.

The effect of series capacitors can be neglected in the calculation of short-circuit currents, if they are equipped with voltage-limiting devices in parallel, acting if a short circuit occurs.

In the case of high-voltage direct-current transmission systems, the capacitor banks and filters need special considerations, when calculating a.c. short-circuit currents.

## 4 Calculation of short-circuit currents

### 4.1 General

In the case of a far-from-generator short circuit, the short-circuit current can be considered as the sum of the following two components:

- the a.c. component with constant amplitude during the whole short circuit,
- the aperiodic d.c. component beginning with an initial value A and decaying to zero.

Figure 1 gives schematically the general course of the short-circuit current in the case of a far-from-generator short circuit. The symmetrical a.c. currents  $I_k''$ ,  $I_b$  and  $I_k$  are r.m.s. values and are nearly equal in magnitude.

Single-fed short circuits supplied by a transformer according to figure 4, may *a priori* be regarded as far-from-generator short circuits if  $X_{TLVK} \geq 2X_{Qt}$  with  $X_{Qt}$  calculated in accordance with 3.2 and  $X_{TLVK} = K_T X_{TLV}$  in accordance with 3.3.

In the case of a near-to-generator short circuit, the short-circuit current can be considered as the sum of the following two components:

- the a.c. component with decaying amplitude during the short circuit,
- the aperiodic d.c. component beginning with an initial value A and decaying to zero.

In the calculation of the short-circuit currents in systems supplied by generators, power-station units and motors (near-to-generator and/or near-to-motor short circuits), it is of interest not only to know the initial symmetrical short-circuit current  $I_k''$  and the peak short-circuit current  $i_p$ , but also the symmetrical short-circuit breaking current  $I_b$  and the steady-state short-circuit current  $I_k$ . In this case, the symmetrical short-circuit breaking current  $I_b$  is smaller than the initial symmetrical short-circuit current  $I_k''$ . Normally, the steady-state short-circuit current  $I_k$  is smaller than the symmetrical short-circuit breaking current  $I_b$ .

In a near-to-generator short circuit, the short-circuit current behaves generally as shown in figure 2. In some special cases, it could happen that the decaying short-circuit current reaches zero for the first time, some cycles after the short circuit took place. This is possible if the d.c. time constant of a synchronous machine is larger than the subtransient time constant. This phenomenon is not dealt with in this standard.

The decaying aperiodic component  $i_{d.c.}$  of the short-circuit current can be calculated according to 4.4.

For the calculation of the initial symmetrical short-circuit current, it is allowed to take  $\underline{Z}_{(2)} = \underline{Z}_{(1)}$ .

The type of short circuit which leads to the highest short-circuit current depends on the values of the positive-sequence, negative-sequence, and zero-sequence short-circuit impedances of the system. figure 10 illustrates this for the special case where  $\underline{Z}_{(0)}$ ,  $\underline{Z}_{(1)}$  and  $\underline{Z}_{(2)}$  have the same impedance angle. This figure is useful for information but should not be used instead of calculation.

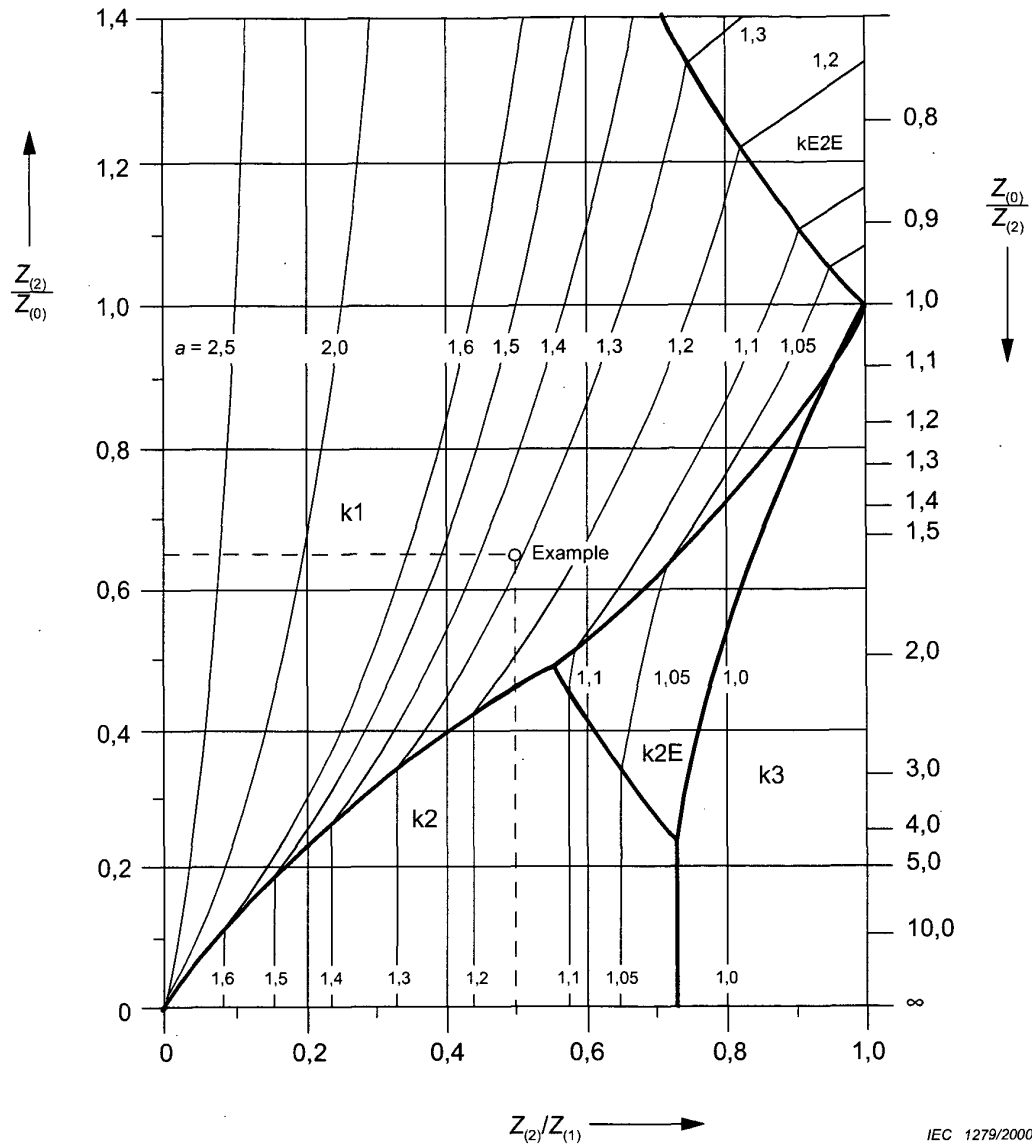

IEC 1279/2000

$$a = \frac{\text{Unbalanced short-circuit current}}{\text{Three-phase short-circuit current}}$$

Example:

$Z_{(2)}/Z_{(1)} = 0,5$   
 $Z_{(2)}/Z_{(0)} = 0,65$ 
} The single line-to-earth short circuit will give the highest short-circuit current

**Figure 10 – Diagram to determine the short-circuit type (figure 3) for the highest short-circuit current referred to the symmetrical three-phase short-circuit current at the short-circuit location when the impedance angles of the sequence impedances  $Z_{(1)}$ ,  $Z_{(2)}$ ,  $Z_{(0)}$  are identical**

For the calculation of the initial symmetrical short-circuit current  $I_k''$ , the symmetrical short-circuit breaking current  $I_b$ , and the steady-state short-circuit current  $I_k$  at the short-circuit location, the system may be converted by network reduction into an equivalent short-circuit impedance  $Z_k$  at the short-circuit location. This procedure is not allowed when calculating the peak short-circuit current  $i_p$ . In this case, it is necessary to distinguish between networks with and without parallel branches (see 4.3.1.1 and 4.3.1.2).

While using fuses or current-limiting circuit-breakers to protect substations, the initial symmetrical short-circuit current is first calculated as if these devices were not available. From the calculated initial symmetrical short-circuit current and characteristic curves of the fuses or current-limiting circuit-breakers, the cut-off current is determined, which is the peak short-circuit current of the downstream substation.

Short circuits may have one or more sources, as shown in figures 11, 12, and 14. Calculations are simplest for balanced short circuits on radial systems, as the individual contributions to a balanced short circuit can be evaluated separately for each source (figures 12 or 13).

When sources are distributed in meshed network as in figure 14, and for all cases of unbalanced short circuits, network reduction is necessary to calculate short-circuit impedances  $Z_{(1)} = Z_{(2)}$  and  $Z_{(0)}$  at the short-circuit location.

## 4.2 Initial symmetrical short-circuit current $I_k''$

For the common case when  $Z_{(0)}$  is larger than  $Z_{(1)} = Z_{(2)}$ , the highest initial short-circuit current will occur for the three-phase short circuit. However, for short circuits near transformers with low zero-sequence impedance,  $Z_{(0)}$  may be smaller than  $Z_{(1)}$ . In that case, the highest initial short-circuit current  $I_{kE2E}''$  will occur for a line-to-line short circuit with earth connection (see figure 11 for  $Z_{(2)}/Z_{(1)} = 1$  and  $Z_{(2)}/Z_{(0)} > 1$  where  $Z_{(2)} = Z_{(1)}$ ).

### 4.2.1 Three-phase short circuit

In general, the initial symmetrical short-circuit current  $I_k''$  shall be calculated using equation (29) with the equivalent voltage source  $cU_n/\sqrt{3}$  at the short-circuit location and the short-circuit impedance  $Z_k = R_k + jX_k$ .

$$I_k'' = \frac{cU_n}{\sqrt{3} Z_k} = \frac{cU_n}{\sqrt{3} \sqrt{R_k^2 + X_k^2}} \quad (29)$$

The equivalent voltage source  $cU_n/\sqrt{3}$  shall be introduced at the short-circuit location (see figure 4) with the factor  $c$  according to table 1.

#### 4.2.1.1 Single-fed short circuits

For a far-from-generator short circuit fed from a single source (see figure 11a), the short-circuit current is calculated using equation (29).

with

$$R_k = R_{Ql} + R_{TK} + R_L \tag{30}$$

$$X_k = X_{Ql} + X_{TK} + X_L \tag{31}$$

where

$R_k$  and  $X_k$  are the sum of the series-connected resistances and reactances of the positive-sequence system respectively, in accordance with figure 11a.  $R_L$  is the line resistance for a conductor temperature of 20 °C, when calculating the maximum short-circuit currents.

The corrected transformer impedance  $Z_{TK} = R_{TK} + jX_{TK} = K_T (R_T + jX_T)$  is found from equations (7) to (9), or (10) to (11) with the correction factor  $K_T$  from equation (12) or (13).

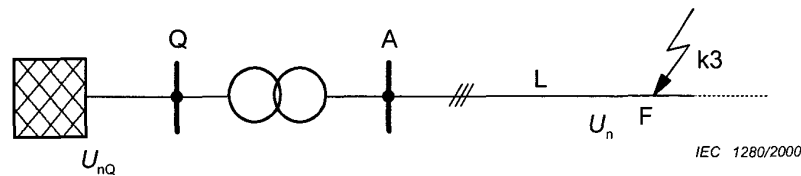

Figure 11a – Short circuit fed from a network feeder via a transformer

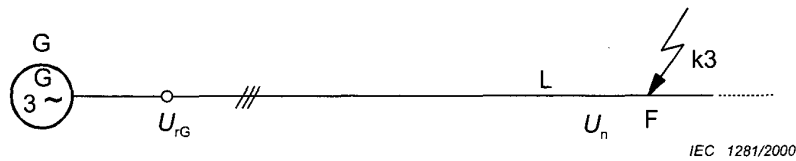

Figure 11b – Short circuit fed from one generator (without unit transformer)

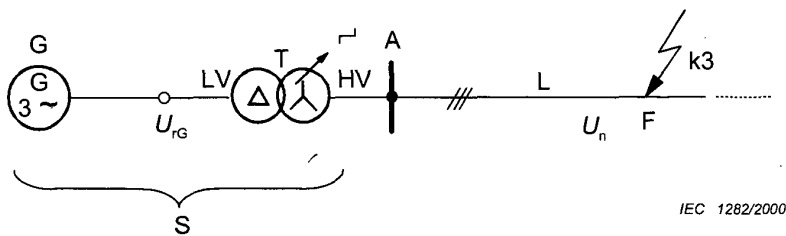

Figure 11c – Short circuit fed from one power station unit (generator and unit transformer with or without on-load tap-changer)

Figure 11 – Examples of single-fed short circuits

Resistances  $R_k$  less than  $0,3 \cdot X_k$  may be neglected. The impedance of the network feeder  $\underline{Z}_{Qt} = R_{Qt} + jX_{Qt}$  is referred to the voltage of the transformer side connected to the short-circuit location. (In the case of figure 4, for instance, to the LV side).

For the examples in figures 11b and 11c, the initial symmetrical short-circuit current is calculated with the corrected impedances of the generator and the power station unit (see 3.6.1 and 3.7) in series with a line impedance  $\underline{Z}_L = R_L + jX_L$ . The short-circuit impedances for the examples in figures 11b and 11c are given by the following equations:

$$\text{Example figure 11b:} \quad \underline{Z}_k = \underline{Z}_{GK} + \underline{Z}_L = K_G (R_G + jX_d'') + \underline{Z}_L \quad (32)$$

$$\text{Example figure 11c:} \quad \underline{Z}_k = \underline{Z}_S + \underline{Z}_L = K_S (t_r^2 \underline{Z}_G + \underline{Z}_{THV}) + \underline{Z}_L \quad (33)$$

$\underline{Z}_{GK}$  shall be determined from equation (17),  $\underline{Z}_S$  from equation (21) or (23) with  $K_S$  or  $K_{SO}$  according to equation (22) or (24). The generator impedance shall be transferred to the high-voltage side using the rated transformation ratio  $t_r$ . The unit transformer impedance  $\underline{Z}_{THV} = R_{THV} + jX_{THV}$  according to equations (7) to (9) without  $K_T$  is referred to the high-voltage side.

#### 4.2.1.2 Short circuits fed from non-meshed networks

When there is more than one source contributing to the short-circuit current, and the sources are unmeshed, as shown for instance in figure 12, the initial symmetrical short-circuit current  $I_k''$  at the short-circuit location F is the sum of the individual branch short-circuit currents. Each branch short-circuit current can be calculated as an independent single-source three-phase short-circuit current in accordance with equation (29) and the information given in 4.2.1.1.

The initial short-circuit current at the short-circuit location F is the phasor sum of the individual partial short-circuit currents (see figure 12):

$$I_k'' = \sum_i I_{ki}'' \quad (34)$$

Within the accuracy of this standard, it is often sufficient to determine the short-circuit current at the short-circuit location F as being the sum of the absolute values of the individual partial short-circuit currents.

In general, the calculation according to 4.2.1.5 for meshed networks is to be preferred, especially if digital programs are used.

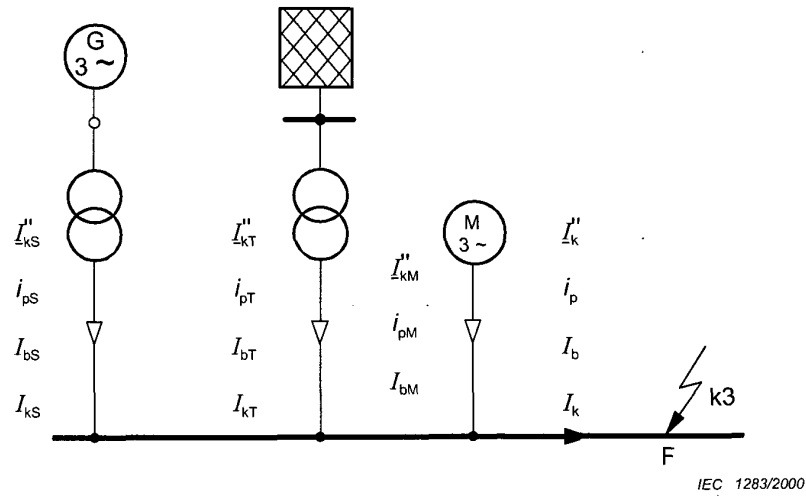

Figure 12 – Example of a non-meshed network

4.2.1.3 Short-circuit currents inside a power station unit with on-load tap-changer

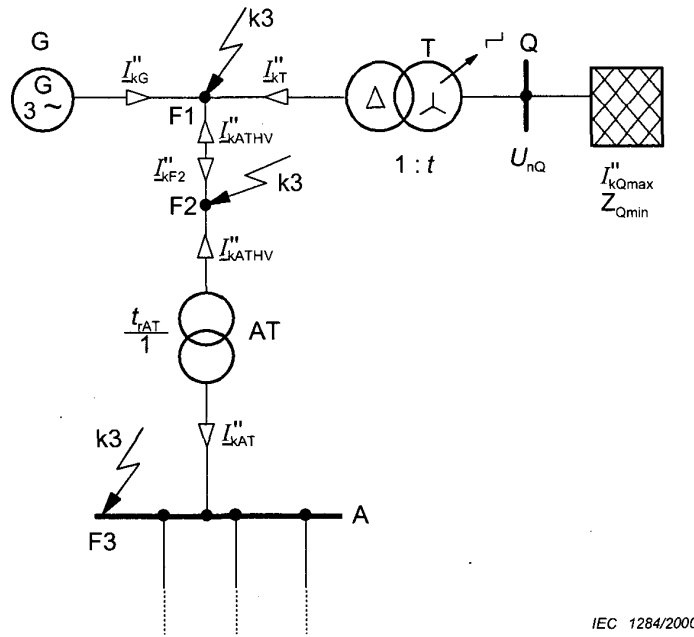

Figure 13 – Short-circuit currents and partial short-circuit currents for three-phase short circuits between generator and unit transformer with or without on-load tap-changer, or at the connection to the auxiliary transformer of a power station unit and at the auxiliary busbar A



For calculating the partial short-circuit currents  $I''_{kG}$  and  $I''_{kT}$  with a short circuit at F1 in figure 13, in the case of a power station unit with on-load tap-changer, the partial initial symmetrical short-circuit currents are given by:

$$I''_{kG} = \frac{cU_{rG}}{\sqrt{3} K_{G,S} Z_G} \quad (35)$$

with

$$K_{G,S} = \frac{c_{\max}}{1 + x''_d \sin \varphi_{rG}} \quad (36)$$

$$I''_{kT} = \frac{cU_{rG}}{\sqrt{3} \left[ Z_{TLV} + \frac{1}{t_r^2} Z_{Qmin} \right]} \quad (37)$$

where

$Z_G$  is the subtransient impedance of the generator  $Z_G = R_G + jX''_d$

$x''_d$  is the subtransient reactance referred to the rated impedance:

$$x''_d = X''_d / Z_{rG} \text{ with } Z_{rG} = U_{rG}^2 / S_{rG};$$

$Z_{TLV}$  is the transformer short-circuit impedance referred to the low-voltage side according to 3.3.1, equations (7) to (9);

$t_r$  is the rated transformation ratio;

$Z_{Qmin}$  is the minimum value of the impedance of the network feeder, corresponding to  $I''_{kQmax}$ .

For  $I''_{kQmax}$  the maximum possible value during the lifetime of the power station unit shall be introduced.

For the calculation of the partial short-circuit current  $I''_{kF2}$  feeding into the short-circuit location F2, for example at the connection to the high-voltage side of the auxiliary transformer AT in figure 13, it is sufficient to take:

$$I''_{kF2} = \frac{cU_{rG}}{\sqrt{3}} \left[ \frac{1}{K_{G,S} Z_G} + \frac{1}{K_{T,S} Z_{TLV} + \frac{1}{t_r^2} Z_{Qmin}} \right] = \frac{cU_{rG}}{\sqrt{3} Z_{rs1}} \quad (38)$$

with

$$K_{T,S} = \frac{c_{\max}}{1 - x_T \sin \varphi_{rG}} \quad (39)$$

and  $K_{G,S}$  according to equation (36).

If the unit transformer has an on-load tap-changer on the high-voltage side, it is assumed that the operating voltage at the terminals of the generator is equal to  $U_{rG}$ . If, even in this case, the voltage region of the generator  $U_G = U_{rG}(1 \pm p_G)$  is used permanently, take equations (40) to (44) instead of (35) to (39).

The total short-circuit current in F1 or F2 (figure 13) is found by adding the partial short-circuit current  $I''_{kATHV}$ , caused by the medium- and low-voltage auxiliary motors of the power station unit.

#### 4.2.1.4 Short-circuit currents inside a power station unit without on-load tap-changer

For a power station unit without on-load tap-changer of the unit transformer, the partial initial symmetrical short-circuit currents in figure 13 are given by:

$$I''_{kG} = \frac{cU_{rG}}{\sqrt{3} K_{G,SO} Z_G} \quad (40)$$

with

$$K_{G,SO} = \frac{1}{1 + p_G} \cdot \frac{c_{\max}}{1 + x_d'' \sin \phi_{rG}} \quad (41)$$

$$I''_{kT} = \frac{cU_{rG}}{\sqrt{3} \left| Z_{TLV} + \frac{1}{t_r^2} Z_{Qmin} \right|} \quad (42)$$

For  $Z_G$ ,  $x_d''$ ,  $Z_{TLV}$ ,  $t_r$  and  $Z_{Qmin}$ , see 4.2.1.3.

The partial short-circuit current  $I''_{kF2}$  in figure 13 can be calculated by:

$$I''_{kF2} = \frac{cU_{rG}}{\sqrt{3}} \left[ \frac{1}{K_{G,SO} Z_G} + \frac{1}{K_{T,SO} Z_{TLV} + \frac{1}{t_r^2} Z_{Qmin}} \right] = \frac{cU_{rG}}{\sqrt{3} Z_{rs1}} \quad (43)$$

with

$$K_{T,SO} = \frac{1}{1 + p_G} \cdot \frac{c_{\max}}{1 - x_T \sin \phi_{rG}} \quad (44)$$

and  $K_{G,SO}$  according to equation (41).

The impedance  $Z_{rs1}$  in equation (38) or (43) is used to determine the partial short-circuit current  $I''_{kAT}$  in figure 13 for the short circuit in F3. The impedance of the auxiliary transformer AT in figure 13 is to be corrected with  $K_T$  from 3.3.3.

The total short-circuit in F1 or F2 (figure 13) is found by adding the partial short-circuit current  $I''_{kATHV}$ , caused by the medium- and low-voltage auxiliary motors of the power station unit.

#### 4.2.1.5 Short circuits in meshed networks

In meshed networks, such as those shown in figure 14, it is generally necessary to determine the short-circuit impedance  $\underline{Z}_k = \underline{Z}_{(1)}$  by network reduction (series connection, parallel connection, and delta-star transformation, for example) using the positive-sequence short-circuit impedances of electrical equipment (see clause 3).

The impedances in systems connected through transformers to the system, in which the short circuit occurs, have to be transferred by the square of the rated transformation ratio. If there are several transformers with slightly differing rated transformation ratios ( $t_{rT1}$   $t_{rT2}$ ...  $t_{rTn}$ ), in between two systems, the arithmetic mean value can be used.

The initial symmetrical short-circuit current shall be calculated with the equivalent voltage source  $cU_n/\sqrt{3}$  at the short-circuit location using equation (29).

#### 4.2.2 Line-to-line short circuit

In the case of a line-to-line short circuit, according to figure 3b, the initial short-circuit current shall be calculated by:

$$I_{k2}'' = \frac{cU_n}{|\underline{Z}_{(1)} + \underline{Z}_{(2)}|} = \frac{cU_n}{2|\underline{Z}_{(1)}|} = \frac{\sqrt{3}}{2} I_k'' \quad (45)$$

During the initial stage of the short circuit, the negative impedance is approximately equal to the positive-sequence impedance, independent of whether the short circuit is a near-to-generator or a far-from-generator short circuit. Therefore in equation (45) it is possible to introduce  $\underline{Z}_{(2)} = \underline{Z}_{(1)}$ .

Only during the transient or the steady-state stage, the short-circuit impedance  $\underline{Z}_{(2)}$  is different from  $\underline{Z}_{(1)}$ , if the short circuit is a near-to-generator short circuit (see figure 10).

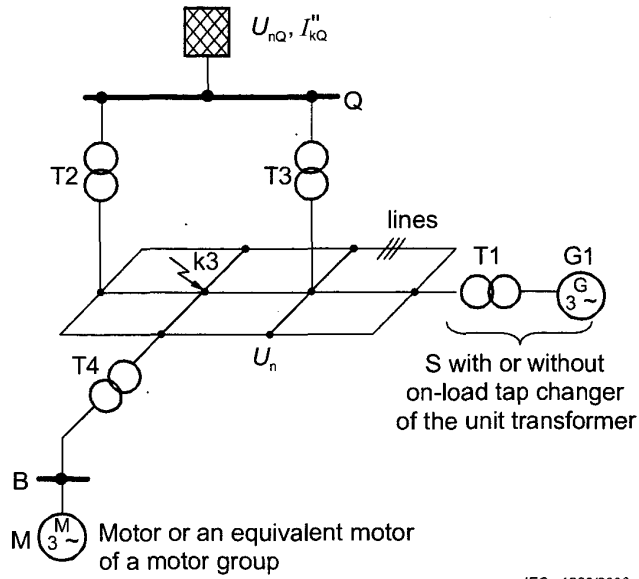

IEC 1285/2000

Figure 14a – System diagram

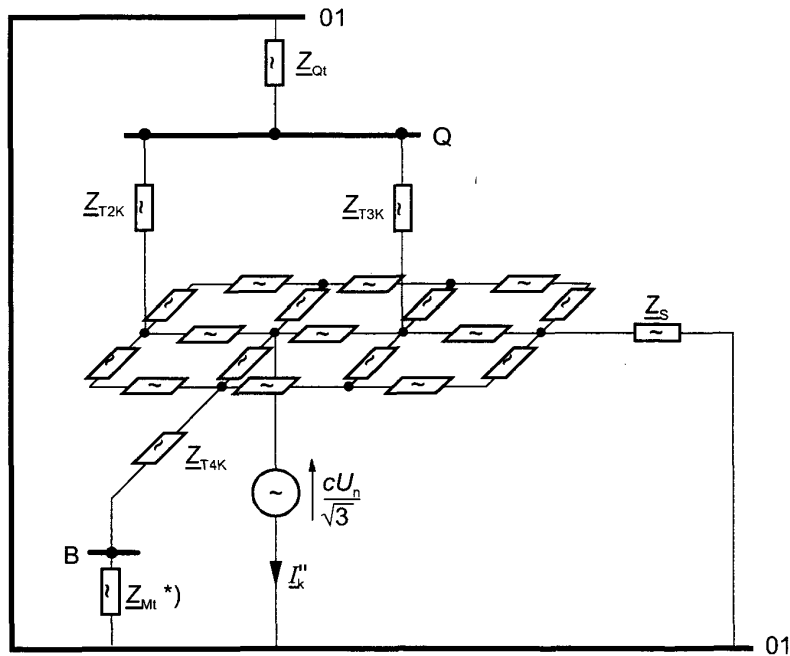

IEC 1286/2000

\*  $Z_{Ml}$  Impedance of a motor or an equivalent motor of a motor group.

Figure 14b – Equivalent circuit diagram for the calculation with the equivalent voltage source  $cU_n/\sqrt{3}$  at the short-circuit location

Figure 14 – Example of a meshed network fed from several sources

### 4.2.3 Line-to-line short circuit with earth connection

To calculate the initial symmetrical short-circuit currents it is necessary to distinguish between the currents  $I''_{k2EL2}$ ,  $I''_{k2EL3}$ , and  $I''_{kE2E}$  (see figure 3c).

For far-from-generator short circuits,  $Z_{(2)}$  is approximately equal to  $Z_{(1)}$ . If in this case  $Z_{(0)}$  is less than  $Z_{(2)}$ , the current  $I''_{kE2E}$  in the line-to-line short circuit with earth connection generally is the largest of all initial symmetrical short-circuit currents  $I''_k$ ,  $I''_{k2}$ ,  $I''_{k2E}$  and  $I''_{k1}$  (see figure 10).

The equations (46) and (47) are given for the calculation of  $I''_{k2EL2}$  and  $I''_{k2EL3}$  in figure 3c:

$$I''_{k2EL2} = -jcU_n \frac{Z_{(0)} - aZ_{(2)}}{Z_{(1)}Z_{(2)} + Z_{(1)}Z_{(0)} + Z_{(2)}Z_{(0)}} \quad (46)$$

$$I''_{k2EL3} = jcU_n \frac{Z_{(0)} - a^2Z_{(2)}}{Z_{(1)}Z_{(2)} + Z_{(1)}Z_{(0)} + Z_{(2)}Z_{(0)}} \quad (47)$$

The initial short-circuit current  $I''_{kE2E}$ , flowing to earth and/or grounded wires, according to figure 3c, is calculated by:

$$I''_{kE2E} = -\frac{\sqrt{3} cU_n Z_{(2)}}{Z_{(1)}Z_{(2)} + Z_{(1)}Z_{(0)} + Z_{(2)}Z_{(0)}} \quad (48)$$

For a far-from-generator short circuit with  $Z_{(2)} = Z_{(1)}$ , these equations lead to the absolute values:

$$I''_{k2EL2} = cU_n \frac{|Z_{(0)} / Z_{(1)} - a|}{|Z_{(1)} + 2Z_{(0)}|} \quad (49)$$

$$I''_{k2EL3} = cU_n \frac{|Z_{(0)} / Z_{(1)} - a^2|}{|Z_{(1)} + 2Z_{(0)}|} \quad (50)$$

$$I''_{kE2E} = \frac{\sqrt{3} cU_n}{|Z_{(1)} + 2Z_{(0)}|} \quad (51)$$

#### 4.2.4 Line-to-earth short circuit

The initial line-to-earth short-circuit current  $I''_{kl}$  in figure 3d shall be calculated by:

$$I''_{kl} = \frac{\sqrt{3} cU_n}{Z_{(1)} + Z_{(2)} + Z_{(0)}} \quad (52)$$

For a far-from-generator short circuit with  $Z_{(2)} = Z_{(1)}$  the absolute value is calculated by:

$$I''_{kl} = \frac{\sqrt{3} cU_n}{2 Z_{(1)} + Z_{(0)}} \quad (53)$$

If  $Z_{(0)}$  is less than  $Z_{(2)} = Z_{(1)}$ , the initial line-to-earth short-circuit current  $I''_{kl}$  is larger than the three-phase short-circuit current  $I''_k$ , but smaller than  $I''_{kE2E}$  (see figure 10). However,  $I''_{kl}$  will be the highest current to be interrupted by a circuit breaker if  $1,0 > Z_{(0)}/Z_{(1)} > 0,23$ .

### 4.3 Peak short-circuit current $i_p$

#### 4.3.1 Three-phase short circuit

##### 4.3.1.1 Short circuits in non-meshed networks

For three-phase short circuits fed from non-meshed networks as in figures 11 and 12, the contribution to the peak short-circuit current from each branch can be expressed by:

$$i_p = \kappa \sqrt{2} I''_k \quad (54)$$

The factor  $\kappa$  for the  $R/X$  or  $X/R$  ratio shall be obtained from figure 15 or calculated by the following expression:

$$\kappa = 1,02 + 0,98e^{-3R/X} \quad (55)$$

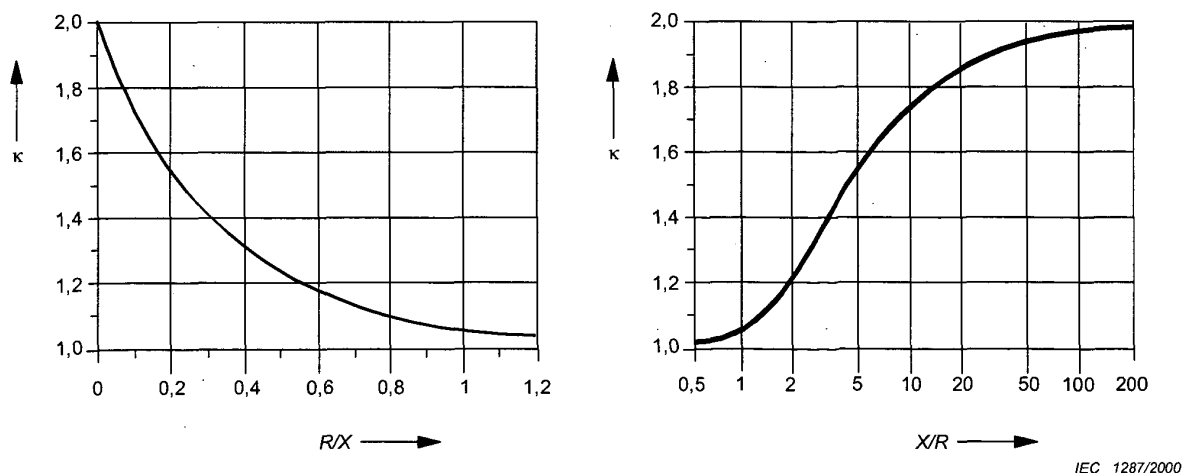

Figure 15 – Factor  $\kappa$  for series circuit as a function of ratio  $R/X$  or  $X/R$

Equations (54) and (55) presume that the short circuit starts at zero voltage, and that  $i_p$  is reached approximately after one half-cycle (see IEC 60909-1, figure 24). For a synchronous generator use  $R_{Gr}$  (see 3.6.1).

The peak short-circuit current  $i_p$  at a short-circuit location F, fed from sources which are not meshed with one another, in accordance with figure 12, is the sum of the partial short-circuit currents:

$$i_p = \sum_i i_{pi} \quad (56)$$

Example figure 12: 
$$i_p = i_{pS} + i_{pT} + i_{pM} \quad (57)$$

#### 4.3.1.2 Short circuits in meshed networks

When calculating the peak short-circuit current  $i_p$  in meshed networks, equation (54) shall be used with  $\kappa$  determined using one of the following methods a), b), or c).

a) *Uniform ratio  $R/X$  or  $X/R$*

For this method the factor  $\kappa$  is determined from figure 15 taking the smallest ratio of  $R/X$  or the largest ratio of  $X/R$  of all branches of the network.

It is only necessary to choose the branches which carry partial short-circuit currents at the nominal voltage corresponding to the short-circuit location and branches with transformers adjacent to the short-circuit location. Any branch may be a series combination of several impedances.

b) *Ratio  $R/X$  or  $X/R$  at the short-circuit location*

For this method the factor  $\kappa$  is multiplied by a factor 1,15 to cover inaccuracies caused by using the ratio  $R_k / X_k$  from a network reduction with complex impedances.

$$i_{p(b)} = 1,15 \kappa_{(b)} \sqrt{2} I_k'' \quad (58)$$

As long as  $R/X$  remains smaller than 0,3 in all branches, it is not necessary to use the factor 1,15. It is not necessary for the product  $1,15 \cdot \kappa_{(b)}$  to exceed 1,8 in low-voltage networks or to exceed 2,0 in medium- and high-voltage networks.

The factor  $\kappa_{(b)}$  is found from figure 15 for the ratio  $R_k/X_k$  given by the short-circuit impedance  $\underline{Z}_k = R_k + jX_k$  at the short-circuit location F, calculated for frequency  $f = 50$  Hz or 60 Hz.

c) *Equivalent frequency  $f_c$*

An equivalent impedance  $\underline{Z}_c$  of the system as seen from the short-circuit location is calculated assuming a frequency  $f_c = 20$  Hz (for a nominal frequency of  $f = 50$  Hz) or  $f_c = 24$  Hz (for a nominal frequency of  $f = 60$  Hz). The  $R/X$  or  $X/R$  ratio is then determined according to equation (59).

$$\frac{R}{X} = \frac{R_c}{X_c} \cdot \frac{f_c}{f} \quad (59a)$$

$$\frac{X}{R} = \frac{X_c}{R_c} \cdot \frac{f}{f_c} \quad (59b)$$

where

$Z_c = R_c + jX_c$  is the equivalent impedance of the system as seen from the short-circuit location for the assumed frequency  $f_c$ ;

$R_c$  is the real part of  $Z_c$  ( $R_c$  is generally not equal to the  $R$  at nominal frequency)

$X_c$  is the imaginary part of  $Z_c$  ( $X_c$  is generally not equal to the  $X$  at nominal frequency).

The factor  $\kappa$  is found from figure 15 using the  $R/X$  or  $X/R$  ratio from equation (59), or with equation (55). Method c) is recommended in meshed networks (see IEC 60909-1).

When using this method in meshed networks with transformers, generators and power station units, the impedance correction factors  $K_T$ ,  $K_G$  and  $K_S$ , respectively  $K_{SO}$ , shall be introduced with the same values as for the 50 Hz or 60 Hz calculations.

#### 4.3.2 Line-to-line short circuit

For a line-to-line short circuit the peak short-circuit current can be expressed by:

$$i_{p2} = \kappa \sqrt{2} I_{k2}'' \quad (60)$$

The factor  $\kappa$  shall be calculated according to 4.3.1.1 or to 4.3.1.2 depending on the system configuration. For simplification, it is permitted to use the same value of  $\kappa$  as for the three-phase short circuit.

When  $Z_{(1)} = Z_{(2)}$ , the line-to-line peak short-circuit current  $i_{p2}$  is smaller than the three-phase peak short-circuit current  $i_p$  as shown in equation (61):

$$i_{p2} = \frac{\sqrt{3}}{2} i_p \quad (61)$$

#### 4.3.3 Line-to-line short circuit with earth connection

For a line-to-line short circuit with earth connection, the peak short-circuit current can be expressed by:

$$i_{p2E} = \kappa \sqrt{2} I_{k2E}'' \quad (62)$$

The factor  $\kappa$  shall be calculated according to 4.3.1.1 or to 4.3.1.2 depending on the system configuration. For simplification, it is permitted to use the same value for  $\kappa$  as for the three-phase short circuit.

It is only necessary to calculate  $i_{p2E}$ , when  $Z_{(0)}$  is much less than  $Z_{(1)}$  (less than about 1/4 of  $Z_{(1)}$ ).



#### 4.3.4 Line-to-earth short circuit

For a line-to-earth short circuit, the peak short-circuit current can be expressed by:

$$i_{pl} = \kappa \sqrt{2} I_{kl}'' \quad (63)$$

The factor  $\kappa$  shall be calculated according to 4.3.1.1 or to 4.3.1.2 depending on the system configuration. For simplification, it is permitted to use the same value for  $\kappa$  as for the three-phase short circuit.

#### 4.4 DC component of the short-circuit current

The maximum d.c. component  $i_{d.c.}$  of the short-circuit current as shown in figures 1 and 2 may be calculated with sufficient accuracy by equation (64).

$$i_{d.c.} = \sqrt{2} I_k'' e^{-2\pi f t R/X} \quad (64)$$

where

$I_k''$  is the initial symmetrical short-circuit current;

$f$  is the nominal frequency;

$t$  is the time;

$R/X$  is the ratio according to 4.3.1.1 or the ratios according to the methods a) and c) in 4.3.1.2 (see also note in 3.6.1).

The correct resistance  $R_G$  of the generator armature should be used and not  $R_{Gf}$ .

For meshed networks, the ratio  $R/X$  or  $X/R$  is to be determined by the method c) in 4.3.1.2. Depending on the product  $f \cdot t$ ; where  $f$  is the frequency and  $t$  is the time, the equivalent frequency  $f_c$  should be used as follows:

|             |      |      |       |       |
|-------------|------|------|-------|-------|
| $f \cdot t$ | <1   | <2,5 | <5    | <12,5 |
| $f_c/f$     | 0,27 | 0,15 | 0,092 | 0,055 |

#### 4.5 Symmetrical short-circuit breaking current $I_b$

The breaking current at the short-circuit location consists in general of a symmetrical current  $I_b$  and a d.c. current  $i_{d.c.}$  at the time  $t_{min}$  according to equation (64).

NOTE For some near-to-generator short circuits the value of  $i_{d.c.}$  at  $t_{min}$  may exceed the peak value of  $I_b$  and this can lead to missing current zeros.

##### 4.5.1 Far-from-generator short circuit

For far-from-generator short circuits, the short-circuit breaking currents are equal to the initial short-circuit currents:

$$I_b = I_k'' \quad (65)$$

$$I_{b2} = I_{k2}'' \quad (66)$$

$$I_{b2E} = I_{k2E}'' \quad (67)$$

$$I_{bl} = I_{kl}'' \quad (68)$$

## 4.5.2 Near-to-generator short circuit

### 4.5.2.1 Single-fed three-phase short circuit

For a near-to-generator short circuit, in the case of a single fed short circuit as in figure 11b and 11c or from non-meshed networks as in figure 12, the decay to the symmetrical short-circuit breaking current is taken into account by the factor  $\mu$  according to equation (70).

$$I_b = \mu I_k'' \quad (69)$$

The factor  $\mu$  depends on the minimum time delay  $t_{\min}$  and the ratio  $I_{kG}''/I_{rG}$ , where  $I_{rG}$  is the rated generator current. The values of  $\mu$  in equation (70) apply if synchronous machines are excited by rotating exciters or by static converter exciters (provided, for static exciters, the minimum time delay  $t_{\min}$  is less than 0,25 s and the maximum excitation voltage is less than 1,6 times rated load excitation-voltage). For all other cases take  $\mu = 1$ , if the exact value is unknown.

When there is a unit transformer between the generator and the short-circuit location, the partial short-circuit current  $I_{kS}''$  at the high-voltage side of the unit transformer (in figure 11c) shall be transferred by the rated transformation ratio to the terminal of the generator  $I_{kG}'' = t_r I_{kS}''$  before calculating  $\mu$ , using the following equations:

$$\begin{aligned} \mu &= 0,84 + 0,26 e^{-0,26 I_{kG}''/I_{rG}} & \text{for } t_{\min} &= 0,02 \text{ s} \\ \mu &= 0,71 + 0,51 e^{-0,30 I_{kG}''/I_{rG}} & \text{for } t_{\min} &= 0,05 \text{ s} \\ \mu &= 0,62 + 0,72 e^{-0,32 I_{kG}''/I_{rG}} & \text{for } t_{\min} &= 0,10 \text{ s} \\ \mu &= 0,56 + 0,94 e^{-0,38 I_{kG}''/I_{rG}} & \text{for } t_{\min} &\geq 0,25 \text{ s} \end{aligned} \quad (70)$$

If  $I_{kG}''/I_{rG}$  is not greater than 2, apply  $\mu = 1$  for all values of the minimum time delay  $t_{\min}$ . The factor  $\mu$  may also be obtained from figure 16. For other values of minimum time delay, linear interpolation between curves is acceptable.

Figure 16 can be used also for compound excited low-voltage generators with a minimum time delay  $t_{\min}$  not greater than 0,1 s. The calculation of low-voltage breaking currents after a time delay  $t_{\min}$  greater than 0,1 s is not included in this standard; generator manufacturers may be able to provide information.

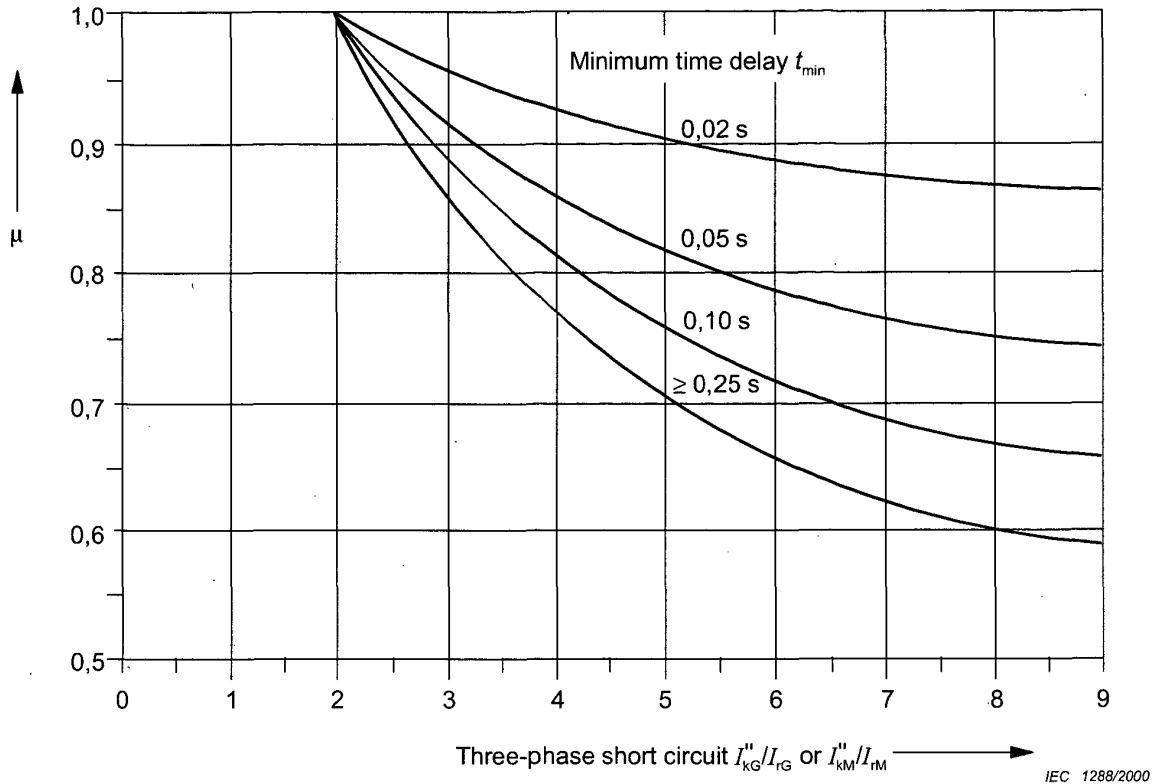

Figure 16 – Factor  $\mu$  for calculation of short-circuit breaking current  $I_b$

#### 4.5.2.2 Three-phase short circuit in non-meshed networks

For three-phase short circuits in non-meshed networks as in figure 12, the symmetrical breaking current at the short-circuit location can be calculated by the summation of the individual breaking current contributions:

$$I_b = \sum_i I_{bi} \quad (71)$$

Example figure 12: 
$$I_b = I_{bS} + I_{bT} + I_{bM} = \mu I_{kS}'' + I_{kT}'' + \mu q I_{kM}'' \quad (72)$$

where

$I_{kS}''$ ,  $I_{kT}''$  and  $I_{kM}''$  are taken as its contributions to  $I_k''$  at the short-circuit location (see figure 12);

$\mu$  is taken from equation (70) or figure 16 for synchronous generators and asynchronous motors.

In case of asynchronous motors, replace  $I_{kG}''/I_{rG}$  by  $I_{kM}''/I_{rM}$  (see table 3).

The factor  $q$  for the calculation of the symmetrical short-circuit breaking current for asynchronous motors may be determined as a function of the minimum time delay  $t_{\min}$ .

$$\begin{aligned}
 q &= 1,03 + 0,12 \ln(P_{\text{rM}}/p) && \text{for } t_{\min} = 0,02 \text{ s} \\
 q &= 0,79 + 0,12 \ln(P_{\text{rM}}/p) && \text{for } t_{\min} = 0,05 \text{ s} \\
 q &= 0,57 + 0,12 \ln(P_{\text{rM}}/p) && \text{for } t_{\min} = 0,10 \text{ s} \\
 q &= 0,26 + 0,10 \ln(P_{\text{rM}}/p) && \text{for } t_{\min} \geq 0,25 \text{ s}
 \end{aligned}
 \tag{73}$$

where

$P_{\text{rM}}$  is the rated active power in MW;

$p$  is the number of pairs of poles of the motor.

If the calculation in equation (73) provides larger values than 1 for  $q$ , assume that  $q = 1$ . Factor  $q$  may also be obtained from figure 17.

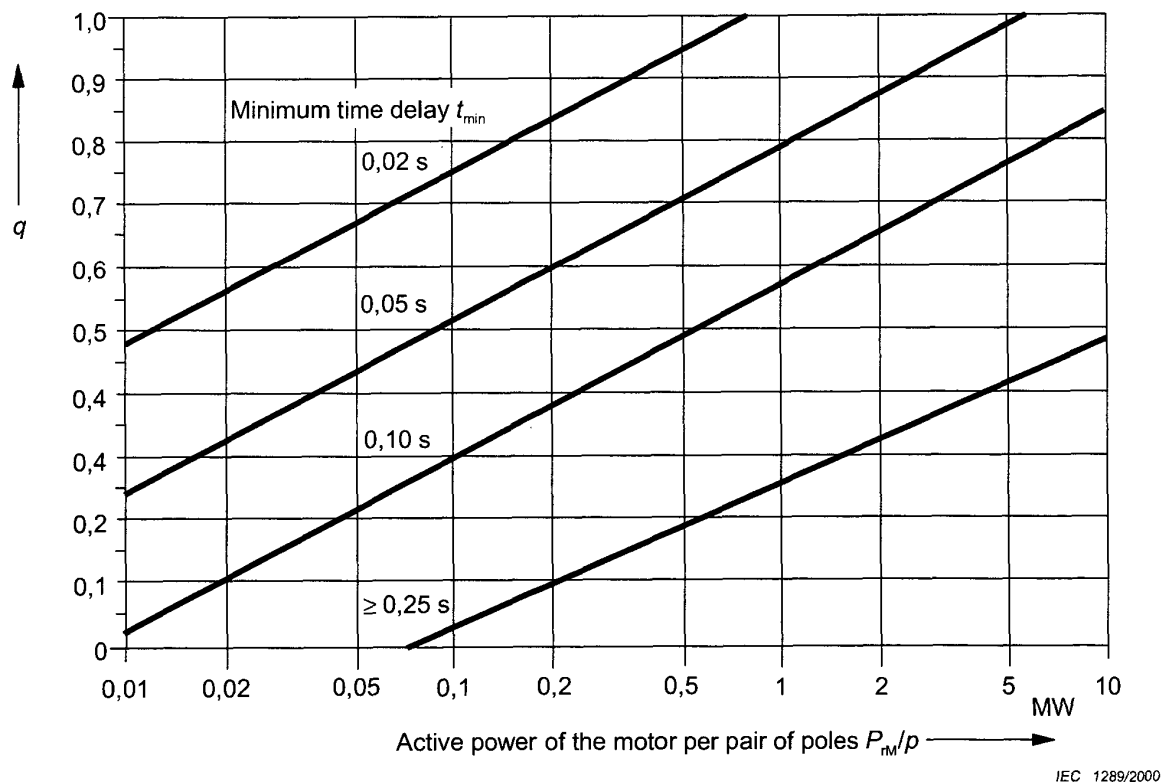

Figure 17 – Factor  $q$  for the calculation of the symmetrical short-circuit breaking current of asynchronous motors

#### 4.5.2.3 Three-phase short circuit in meshed networks

At first the current at the short-circuit location is calculated for the time of breaking, and then the partial currents in the branches where the circuit breakers are located.

The short-circuit breaking current  $I_b$  in meshed networks shall be calculated by:

$$I_b = I_k'' \quad (74)$$

Currents calculated with equation (74) are larger than the real symmetrical short-circuit breaking currents.

For increased accuracy, equations (75), (76), and (77) can be used.

$$I_b = I_k'' - \sum_i \frac{\Delta U_{Gi}''}{cU_n / \sqrt{3}} (1 - \mu_i) I_{kGi}'' - \sum_j \frac{\Delta U_{Mj}''}{cU_n / \sqrt{3}} (1 - \mu_j q_j) I_{kMj}'' \quad (75)$$

$$\Delta U_{Gi}'' = j_j X_{diK}'' I_{kGi}'' \quad (76)$$

$$\Delta U_{Mj}'' = j X_{Mj}'' I_{kMj}'' \quad (77)$$

where

- $\mu_i, \mu_j$  are the values given in equation (70) for both synchronous (i) and asynchronous (j) machines;
- $q_j$  is the value given in equation (73) for asynchronous motors (j);
- $cU_n / \sqrt{3}$  is the equivalent voltage source at the short-circuit location;
- $I_k'', I_b$  are respectively the initial symmetrical short-circuit current and the symmetrical short-circuit breaking current with influence of all network feeders, synchronous machines and asynchronous motors;
- $\Delta U_{Gi}'', \Delta U_{Mj}''$  are the initial voltage drops at the terminals of the synchronous machines (i) and the asynchronous motors (j);
- $X_{diK}''$  is the corrected subtransient reactance of the synchronous machine (i):  
 $X_{diK}'' = K_v X_{di}''$  with  $K_v = K_G, K_S$  or  $K_{SO}$ ;
- $X_{Mj}$  is the reactance for the asynchronous motor (j);
- $I_{kGi}'', I_{kMj}''$  are the contributions to the initial symmetrical short-circuit current from the synchronous machines (i) and the asynchronous motors (j) as measured at the terminals of the machines.

Note that the values  $I''$  and  $\Delta U''$  of equations (76) and (77) are measured at terminals of the machine and that they are related to the same voltage.

If the short circuit is a far-from-motor short circuit i.e.  $\mu_j = 1$ , then take  $1 - \mu_j q_j = 0$ , independent of the value  $q_j$ .

#### 4.5.2.4 Unbalanced short circuits

For unbalanced short-circuit currents, the flux decay in the generator is not taken into account, and equations (66) to (68) apply.

## 4.6 Steady-state short-circuit current $I_k$

The calculation of the steady-state short-circuit current  $I_k$  is less accurate than the calculation of the initial short-circuit current  $I_k''$ .

### 4.6.1 Three-phase short circuit of one generator or one power station unit

For near-to-generator three-phase short circuits fed directly from one synchronous generator or one power station unit only, according to figure 11b or 11c, the steady-state short-circuit current  $I_k$  depends on the excitation system, the voltage regulator action, and saturation influences.

Synchronous machines (generators, motors, or compensators) with terminal-fed static exciters do not contribute to  $I_k$  in the case of a short-circuit at the terminals of the machine, but they contribute to  $I_k$  if there is an impedance between the terminals and the short-circuit location. A contribution is also given if, in case of a power station unit, the short-circuit occurs on the high-voltage side of the unit transformer (see figure 11c).

#### 4.6.1.1 Maximum steady-state short-circuit current

For the calculation of the maximum steady-state short-circuit current, the synchronous generator may be set at the maximum excitation.

$$I_{k\max} = \lambda_{\max} I_{rG} \quad (78)$$

For static excitation systems fed from the generator terminals and a short circuit at the terminals, the field voltage collapses as the terminal voltage collapses, therefore take  $\lambda_{\max} = \lambda_{\min} = 0$  in this case.

$\lambda_{\max}$  may be obtained from figures 18 or 19 for cylindrical rotor generators or salient-pole generators. The saturated reactance  $x_{\text{dsat}}$  is the reciprocal of the saturated no-load short-circuit ratio.

$\lambda_{\max}$ -curves of series 1 are based on the highest possible excitation voltage according to either 1,3 times the rated excitation at rated apparent power and power factor for cylindrical rotor generators (figure 18a) or 1,6 times the rated excitation voltage for salient-pole generators (figure 19a).

$\lambda_{\max}$ -curves of series 2 are based on the highest possible excitation-voltage according to either 1,6 times the rated excitation at rated apparent power and power factor for cylindrical rotor generators (figure 18b), or 2,0 times the rated excitation voltage for salient-pole generators (figure 19b).

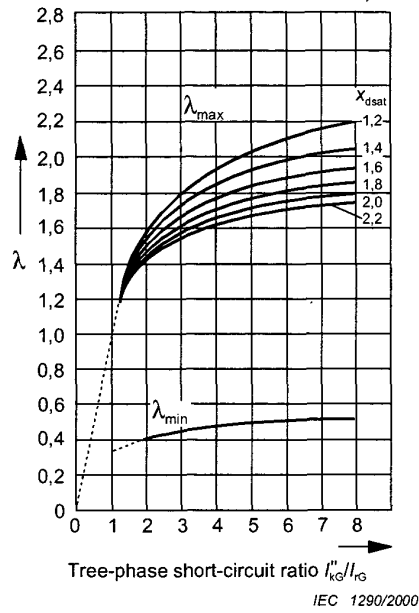

Figure 18a –  $\lambda_{\min}$  and  $\lambda_{\max}$  factors of series 1 (see 4.6.1.1)

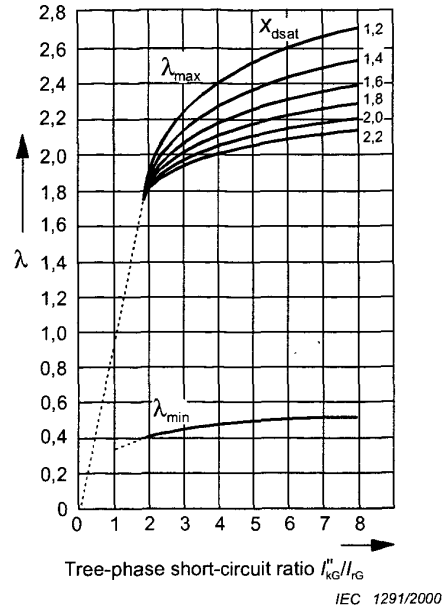

Figure 18b –  $\lambda_{\min}$  and  $\lambda_{\max}$  factors of series 2 (see 4.6.1.1)

Figure 18 –  $\lambda_{\min}$  and  $\lambda_{\max}$  factors for cylindrical rotor generators

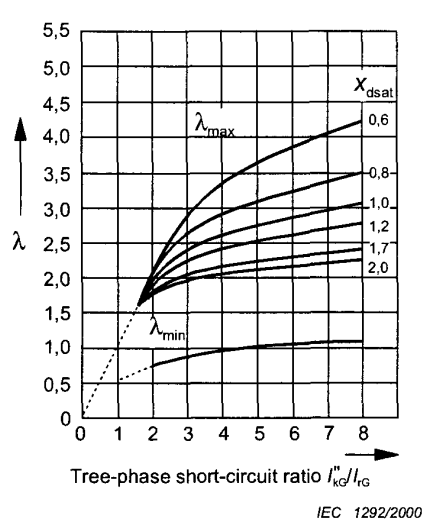

Figure 19a –  $\lambda_{\min}$  and  $\lambda_{\max}$  factors of series 1 (see 4.6.1.1)

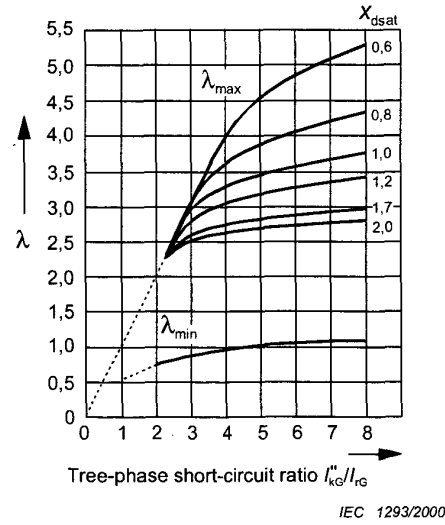

Figure 19b –  $\lambda_{\min}$  and  $\lambda_{\max}$  factors of series 2 (see 4.6.1.1)

Figure 19 – Factors  $\lambda_{\min}$  and  $\lambda_{\max}$  for salient-pole generators

$\lambda_{\max}$ -curves of series 1 or 2 may also be applied in the case of terminal-fed static exciters, if the short circuit is at the high-voltage side of the unit transformer of a power station unit or in the system, and if the maximum excitation voltage is chosen with respect to the partial breakdown of the terminal voltage of the generator during the short circuit.

NOTE The calculation of the  $\lambda_{\max}$ -curves is possible with equation (87) from IEC 60909-1, taking into account that  $I_{kG}''/I_{rG} = \lambda_{\max}$  is valid for ratios  $I_{kG}''/I_{rG} \leq 2$ . This occurs in the case of a far-from-generator short circuit.

#### 4.6.1.2 Minimum steady-state short-circuit current

For the minimum steady-state short-circuit current in the case of a single-fed short circuit from one generator or one power station unit according to figures 11b and 11c, constant no-load excitation (voltage regulator not being effective) of the synchronous machine is assumed:

$$I_{k\min} = \lambda_{\min} I_{rG} \quad (79)$$

$\lambda_{\min}$  may be obtained from figures 18 and 19. In the case of minimum steady-state short circuit introduce  $c = c_{\min}$ , according to table 1.

The calculation of the minimum steady-state short-circuit current in the case of a near-to-generator short circuit, fed by one or several similar and parallel working generators with compound excitation, is made as follows:

$$I_{k\min} = \frac{c_{\min} U_n}{\sqrt{3} \sqrt{R_k^2 + X_k^2}} \quad (80)$$

For the effective reactance of the generators, introduce:

$$X_{dp} = \frac{U_{rG}}{\sqrt{3} I_{kP}} \quad (81)$$

$I_{kP}$  is the steady-state short-circuit current of a generator at a three-phase terminal short-circuit. The value should be obtained from the manufacturer.

#### 4.6.2 Three-phase short circuit in non-meshed networks

In the case of a three-phase short circuit in non-meshed networks, as in figure 12, the steady-state short-circuit current at the short-circuit location can be calculated by the summation of the individual steady-state short-circuit current contributions:

$$I_k = \sum_i I_{ki} \quad (82)$$

Example figure 12: 
$$I_k = I_{kS} + I_{kT} + I_{kM} = \lambda I_{rGt} + I_{kT}'' \quad (83)$$



$\lambda$  ( $\lambda_{\max}$  or  $\lambda_{\min}$ ) is found from figures 18 and 19.  $I_{rG}$  is the rated current of the generator transferred to the high-voltage side (see 4.2.1.2) of the unit transformer in figure 12.

In the case of network feeders or network feeders in series with transformers (see figure 12)  $I_k = I_k''$  is valid (far-from-generator short circuit).

With respect to equation (99) in table 3 the steady-state short-circuit current of asynchronous motors is zero in the case of a three-phase short circuit at the terminals (figure 12 and equation (83)).

When calculating  $I_{k\max}$  or  $I_{k\min}$ , the factor  $c_{\max}$  or  $c_{\min}$  is taken from table 1.

### 4.6.3 Three-phase short circuit in meshed networks

In meshed networks with several sources the steady-state short-circuit current may be calculated approximately by:

$$I_{k\max} = I_{k\max}'' \quad (84)$$

$$I_{k\min} = I_{k\min}'' \quad (85)$$

$I_{k\max}'' = I_k''$  is found according to 2.4 and 4.2.1.5, and  $I_{k\min}''$  according to 2.5 and 4.2.1.5.

Equations (84) and (85) are valid in the case of far-from-generator and in the case of near-to-generator short circuits.

### 4.6.4 Unbalanced short circuits

In all cases for steady-state unbalanced short circuits, the flux decay in the generator is not taken into account and the following equations should be used:

$$I_{k2} = I_{k2}'' \quad (86)$$

$$I_{k2E} = I_{k2E}'' \quad (87)$$

$$I_{kE2E} = I_{kE2E}'' \quad (88)$$

$$I_{k1} = I_{k1}'' \quad (89)$$

In the case of minimum steady-state short circuits introduce  $c = c_{\min}$  according to table 1, see 2.5.

#### 4.6.5 Short circuits at the low-voltage side of transformers, if one line conductor is interrupted at the high-voltage side

When fuses are used as incoming protection at the high-voltage side of network transformers, a short circuit at the secondary side may cause one fuse to clear before the other high-voltage fuses or a circuit-breaker eliminates the short circuit. This can lead to a situation where the partial short-circuit currents are too small to operate any further protection device, particularly in the case of minimum short-circuit currents. Electrical equipment may be overstressed due to the short-circuit duration.

Figure 20 describes this situation with balanced and unbalanced short circuits with earth connection at the short-circuit location F.

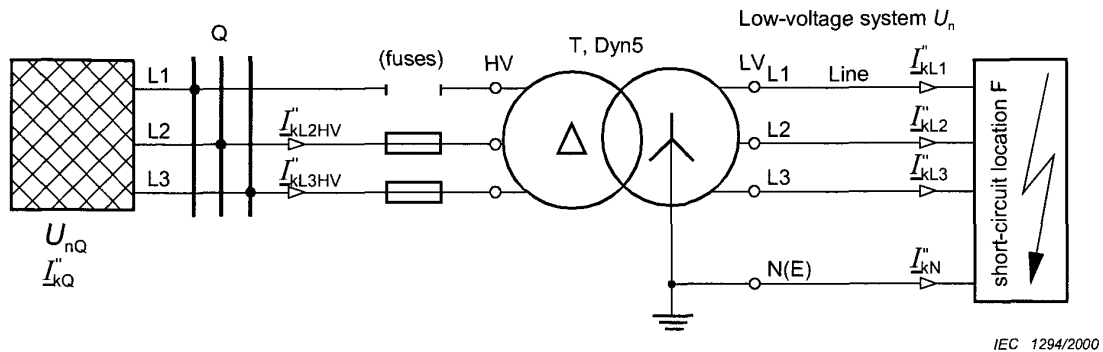

Figure 20 – Transformer secondary short circuits, if one line (fuse) is opened on the high-voltage side of a transformer Dyn5

The short-circuit currents,  $I''_{kL1}$ ,  $I''_{kL2}$ ,  $I''_{kL3}$  and  $I''_{kN}$  at the low-voltage side of the transformer in figure 20 can be calculated using equation (90) with the equivalent voltage source  $cU_n/\sqrt{3}$  at the short-circuit location F. The partial short-circuit currents  $I''_{kL2HV} = I''_{kL3HV}$  at the high-voltage side in figure 20 may also be calculated with equation (90) using appropriate values for the factor  $\alpha$ . In all cases  $I''_{kv}$  is equal to  $I_{kv}$ , because the short circuits are far-from-generator short circuits (see 1.3.17 and figure 1).

$$I''_{kv} = \alpha \frac{cU_n}{\sqrt{3} \left| Z_{Qt} + K_T Z_T + Z_L + \beta (K_T Z_{(0)T} + Z_{(0)L}) \right|} \quad (90)$$

where

- $v$  represents L1, L2, L3, N(E) at the low-voltage side and L2 HV, L3 HV at the high-voltage side;
- $Z_{Qt} + K_T Z_T + Z_L$  is the resultant impedance in the positive-sequence system at the LV-side ( $Z_T = Z_{TLV}$ );
- $K_T Z_{(0)T} + Z_{(0)L}$  is the resultant impedance in the zero-sequence system at the LV-side;
- $\alpha, \beta$  are factors given in table 2.

Any line-to-line short circuits without earth connection cause currents smaller than the rated currents, therefore this case is not taken into account in table 2.

**Table 2 – Factors  $\alpha$  and  $\beta$  for the calculation of short-circuit currents with equation (90)**  
Rated transformation ratio  $t_r = U_{rTHV}/U_{rTLV}$

| Short circuit in F<br>(see figure 20)  | Three-phase<br>short circuit             | Line-to-line short circuit<br>with earth connection |  | Line-to-earth<br>short circuit           |
|--|--|---|--|--|
|  |  | L1, L3, N(E)  | L1, L2, N(E)<br>L2, L3, N(E)             |  |
| Affected lines at<br>the low-voltage side  | L1, L2, L3<br>L1, L2, L3, N(E)           | L1, L3, N(E)  | L1, L2, N(E)<br>L2, L3, N(E)             | L2, N(E) <sup>1)</sup>                   |
| <b>Factor <math>\beta</math></b>   | 0  | 2   | 0,5                                      | 0,5                                      |
| <b>Factor <math>\alpha</math> (LV)</b><br>for the currents   |  |   |  |  |
| $I''_{kL1}$  | 0,5                                      | 1,5   | –  | –  |
| $I''_{kL2}$  | 1,0                                      | –   | 1,5                                      | 1,5                                      |
| $I''_{kL3}$  | 0,5                                      | 1,5   | –  | –  |
| $I''_{kN}$   | –  | 3,0   | 1,5                                      | 1,5                                      |
| <b>Factor <math>\alpha</math> (HV)</b><br>for the currents $I''_{kV}$  | $\frac{1}{t_r} \cdot \frac{\sqrt{3}}{2}$ | $\frac{1}{t_r} \cdot \frac{\sqrt{3}}{2}$            | $\frac{1}{t_r} \cdot \frac{\sqrt{3}}{2}$ | $\frac{1}{t_r} \cdot \frac{\sqrt{3}}{2}$ |
| $I''_{kL2HV} = I''_{kL3HV}$  |  |   |  |  |
| <sup>1)</sup> In the case of line-to-earth short circuits L1, N(E) or L3, N(E), the resulting small currents are stipulated by the transformer open-circuit impedances. They may be neglected. |  |   |  |  |

No short-circuit current on the low-voltage or on the high-voltage side of the transformer in figure 20 is higher than the highest balanced or unbalanced short-circuit current in the case of an intact HV-feeding (see figure 10). Therefore equation (90) is only of interest for the calculation of minimum short-circuit currents (see table 1 for  $c = c_{min}$ , and 2.5).

#### 4.7 Terminal short circuit of asynchronous motors

In the case of three-phase and line-to-line short circuits at the terminals of asynchronous motors, the partial short-circuit currents  $I''_{kM}$ ,  $i_{pM}$ ,  $I_{bM}$ , and  $I_{kM}$  are evaluated as shown in table 3. For grounded systems the influence of motors on the line-to-earth short-circuit current cannot be neglected. Take the impedances of the motors with  $Z_{(1)M} = Z_{(2)M} = \underline{Z}_M$  and  $Z_{(0)M}$ . If the motor is not earthed, the zero-sequence impedance becomes  $Z_{(0)M} = \infty$ .

**Table 3 – Calculation of short-circuit currents of asynchronous motors in the case of a short circuit at the terminals (see 4.7)**

| Short circuit                                     | Three-phase short circuit   | Line-to-line short circuit                                 | Line-to-earth short circuit                        |
|---|---|--|--|
| <b>Initial symmetrical short-circuit current</b>  | $I_{k3M}'' = \frac{cU_n}{\sqrt{3}Z_M} \quad (91)$   | $I_{k2M}'' = \frac{\sqrt{3}}{2} I_{k3M}'' \quad (92)$      | See 4.7  |
| <b>Peak short-circuit current</b>                 | $i_{p3M} = \kappa_M \sqrt{2} I_{k3M}'' \quad (93)$  | $i_{p2M} = \frac{\sqrt{3}}{2} i_{p3M} \quad (94)$          | $i_{p1M} = \kappa_M \sqrt{2} I_{k1M}'' \quad (95)$ |
|   | Medium-voltage motors:<br>$\kappa_M = 1,65$ (corresponding to $R_M/X_M = 0,15$ ) for motor powers per pair of poles <1 MW<br>$\kappa_M = 1,75$ (corresponding to $R_M/X_M = 0,10$ ) for motor powers per pair of poles $\geq 1$ MW<br>Low-voltage motor groups with connection cables: $\kappa_M = 1,3$<br>(corresponding to $R_M/X_M = 0,42$ ) |  |  |
| <b>Symmetrical short-circuit breaking current</b> | $I_{b3M} = \mu q I_{k3M}'' \quad (96)$  | $I_{b2M} = \frac{\sqrt{3}}{2} I_{k3M}'' \quad (97)$        | $I_{b1M} \approx I_{k1M}'' \quad (98)$             |
|   | $\mu$ according to equation (70) or figure 16, with $I_{kM}''/I_{rM}$<br>$q$ according to equation (73) or figure 17.   |  |  |
| <b>Steady-state short-circuit current</b>         | $I_{k3M} = 0 \quad (99)$  | $I_{k2M} \approx \frac{\sqrt{3}}{2} I_{k3M}'' \quad (100)$ | $I_{k1M} \approx I_{k1M}'' \quad (101)$            |

#### 4.8 Joule integral and thermal equivalent short-circuit current

The joule integral  $\int i^2 dt$  is a measure of the energy generated in the resistive element of the system by the short-circuit current. In this standard it is calculated using a factor  $m$  for the time-dependent heat effect of the d.c. component of the short-circuit current and a factor  $n$  for the time-dependent heat effect of the a.c. component of the short-circuit current (see figures 21 and 22)

$$\int_0^{T_k} i^2 dt = I_k''^2 (m+n) T_k = I_{th}^2 T_k \quad (102)$$

The thermal equivalent short-circuit current is:

$$I_{th} = I_k'' \sqrt{m+n} \quad (103)$$

For a series of  $i$  ( $i = 1, 2, \dots, r$ ) three-phase successive individual short-circuit currents, the following equation shall be used for the calculation of the Joule integral or the thermal equivalent short-circuit current.

$$\int i^2 dt = \sum_{i=1}^{i=r} I_{ki}''^2 (m_i + n_i) T_{ki} = I_{th}^2 T_k \quad (104)$$

$$I_{th} = \sqrt{\frac{\int i^2 dt}{T_k}} \quad (105)$$

with

$$T_k = \sum_{i=1}^{i=r} T_{ki} \quad (106)$$

where

$I_{ki}''$  is the initial symmetrical three-phase short-circuit current for each short circuit

$I_{th}$  is the thermal equivalent short-circuit current

$m_i$  is the factor for the heat effect of the d.c. component for each short-circuit current

$n_i$  is the factor for the heat effect of the a.c. component for each short-circuit current

$T_{ki}$  is the duration of the short-circuit current for each short circuit

$T_k$  is the sum of the durations for each short-circuit current (see equation (106))

The Joule integral and the thermal equivalent short-circuit current should always be given with the short-circuit duration with which they are associated.

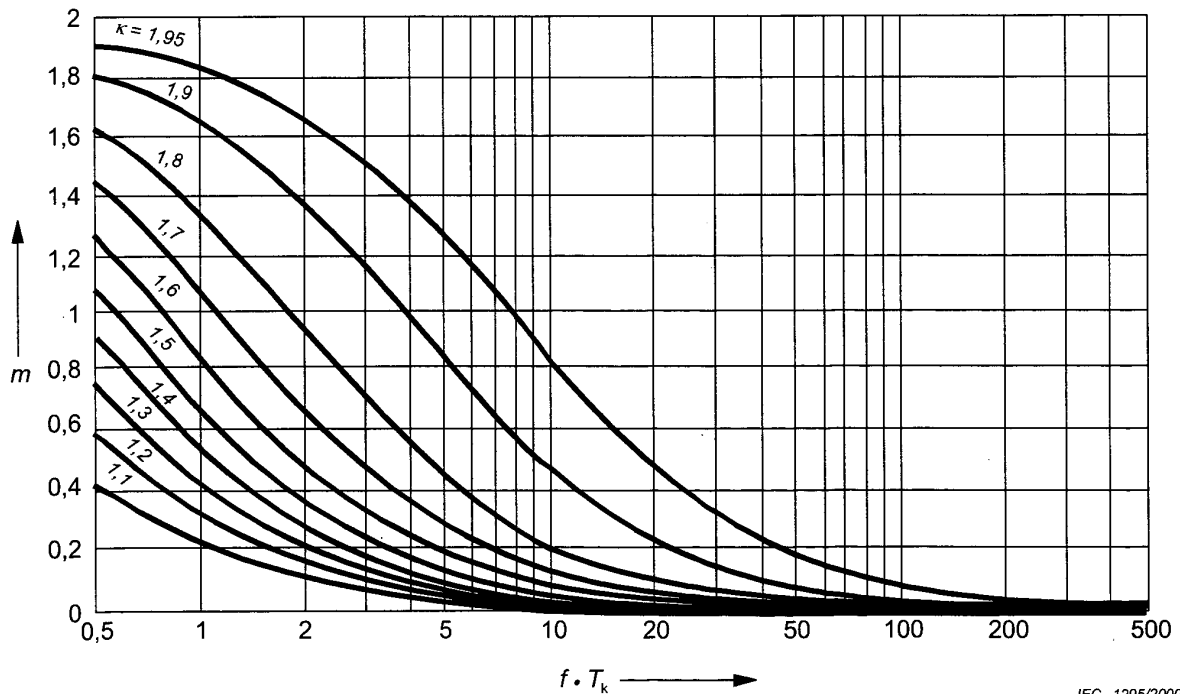

IEC 1295/2000

Figure 21 – Factor  $m$  for the heat effect of the d.c. component of the short-circuit current  
(for programming, the equation for  $m$  is given in annex A)

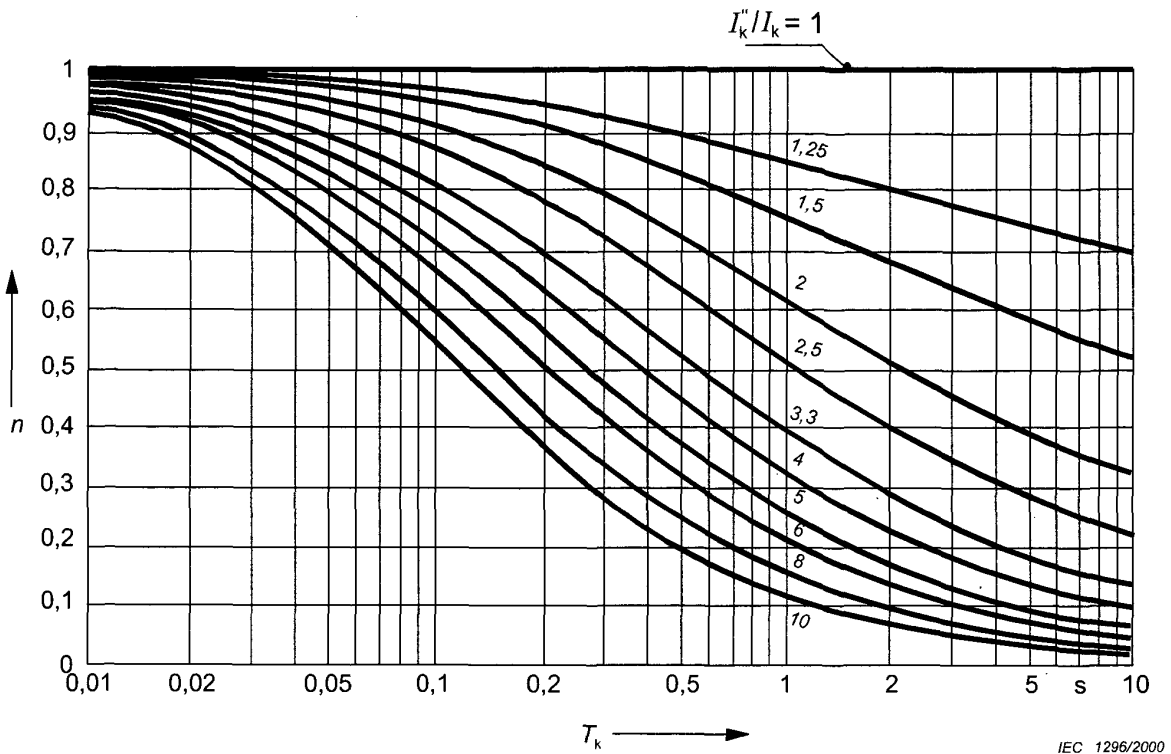

**Figure 22 – Factor  $n$  for the heat effect of the a.c. component of the short-circuit current (for programming, the equation for  $n$  is given in annex A)**

The factors  $m_i$  are obtained from Figure 21 using  $f \cdot T_{ki}$  and the factor  $\kappa$  derived in 4.3. The factors  $n_i$  are obtained from Figure 22 using  $T_{ki}$  and the quotient  $I_{ki}'' / I_{ki}$ , where  $I_{ki}$  is the steady-state short-circuit current for each short circuit.

When a number of short circuits occur with a short time interval in between them, the resulting Joule integral is the sum of the Joule integrals of the individual short-circuit currents, as given in equation (104).

For distribution networks (far-from-generator short circuits) usually  $n=1$  can be used.

For far-from-generator short circuit with the rated short-circuit duration of 0,5 s or more, it is permissible to take  $m + n = 1$ .

If the Joule integral or the thermal equivalent short-circuit current shall be calculated for unbalanced short circuits, replace  $I_{ki}''$  with the appropriate unbalanced short-circuit currents.

**NOTE** For the calculation of the Joule integral or the thermal equivalent short-circuit current in three-phase a.c. systems, the three-phase short-circuit current may be decisive.

When a circuit is protected by fuses or current-limiting circuit-breakers, their Joule integral may limit the value below that calculated in accordance with equation (102) or (104). In this case the Joule integral is determined from the characteristic of the current-limiting device.

NOTE Up to now the thermal equivalent short-time current and the Joule integral are given in IEC 60865-1:1993. The factors  $m$  and  $n$  first appeared as Figures 12a and 12b of IEC 60865-1 and are identical to them.

**Annex A**  
(normative)

**Equations for the calculation of the factors  $m$  and  $n$**

The factor  $m$  in figure 21 is given by:

$$m = \frac{1}{2fT_k \ln(\kappa-1)} \left[ e^{4fT_k \ln(\kappa-1)} - 1 \right]$$

The factor  $n$  in figure 22 is given by:

$$\frac{I_k''}{I_k} = 1: \quad n = 1$$

$$\frac{I_k''}{I_k} \geq 1,25:$$

$$n = \frac{1}{(I_k''/I_k)^2} \left[ 1 + \frac{T_d'}{20T_k} \left( 1 - e^{-20T_k/T_d'} \right) \left( \frac{I_k''}{I_k} - \frac{I_k'}{I_k} \right)^2 + \frac{T_d'}{2T_k} \left( 1 - e^{-2T_k/T_d'} \right) \left( \frac{I_k'}{I_k} - 1 \right)^2 \right. \\ \left. + \frac{T_d'}{5T_k} \left( 1 - e^{-10T_k/T_d'} \right) \left( \frac{I_k''}{I_k} - \frac{I_k'}{I_k} \right) + \frac{2T_d'}{T_k} \left( 1 - e^{-T_k/T_d'} \right) \left( \frac{I_k'}{I_k} - 1 \right) \right. \\ \left. + \frac{T_d'}{5,5T_k} \left( 1 - e^{-11T_k/T_d'} \right) \left( \frac{I_k''}{I_k} - \frac{I_k'}{I_k} \right) \left( \frac{I_k'}{I_k} - 1 \right) \right]$$

where

$$\frac{I_k'}{I_k} = \frac{I_k''/I_k}{0,88 + 0,17I_k''/I_k}$$

$$T_d' = \frac{3,1s}{I_k''/I_k}$$



**Q1** Please report on **ONE STANDARD** and **ONE STANDARD ONLY**. Enter the exact number of the standard: (e.g. 60601-1-1)

.....

**Q2** Please tell us in what capacity(ies) you bought the standard (tick all that apply). I am the/a:

- purchasing agent
- librarian
- researcher
- design engineer
- safety engineer
- testing engineer
- marketing specialist
- other.....

**Q3** I work for/in/as a: (tick all that apply)

- manufacturing
- consultant
- government
- test/certification facility
- public utility
- education
- military
- other.....

**Q4** This standard will be used for: (tick all that apply)

- general reference
- product research
- product design/development
- specifications
- tenders
- quality assessment
- certification
- technical documentation
- thesis
- manufacturing
- other.....

**Q5** This standard meets my needs: (tick one)

- not at all
- nearly
- fairly well
- exactly

**Q6** If you ticked NOT AT ALL in Question 5 the reason is: (tick all that apply)

- standard is out of date
- standard is incomplete
- standard is too academic
- standard is too superficial
- title is misleading
- I made the wrong choice
- other .....

**Q7** Please assess the standard in the following categories, using the numbers:

- (1) unacceptable,
- (2) below average,
- (3) average,
- (4) above average,
- (5) exceptional,
- (6) not applicable

- timeliness.....
- quality of writing.....
- technical contents.....
- logic of arrangement of contents .....
- tables, charts, graphs, figures.....
- other .....

**Q8** I read/use the: (tick one)

- French text only
- English text only
- both English and French texts

**Q9** Please share any comment on any aspect of the IEC that you would like us to know:

.....

.....

.....

.....

.....

.....

.....

.....

.....

.....



**Q1** Veuillez ne mentionner qu'**UNE SEULE NORME** et indiquer son numéro exact: (ex. 60601-1-1)

.....

**Q2** En tant qu'acheteur de cette norme, quelle est votre fonction? (cochez tout ce qui convient)  
Je suis le/un:

- agent d'un service d'achat
- bibliothécaire
- chercheur
- ingénieur concepteur
- ingénieur sécurité
- ingénieur d'essais
- spécialiste en marketing
- autre(s).....

**Q3** Je travaille: (cochez tout ce qui convient)

- dans l'industrie
- comme consultant
- pour un gouvernement
- pour un organisme d'essais/ certification
- dans un service public
- dans l'enseignement
- comme militaire
- autre(s).....

**Q4** Cette norme sera utilisée pour/comme (cochez tout ce qui convient)

- ouvrage de référence
- une recherche de produit
- une étude/développement de produit
- des spécifications
- des soumissions
- une évaluation de la qualité
- une certification
- une documentation technique
- une thèse
- la fabrication
- autre(s).....

**Q5** Cette norme répond-elle à vos besoins: (une seule réponse)

- pas du tout
- à peu près
- assez bien
- parfaitement

**Q6** Si vous avez répondu PAS DU TOUT à Q5, c'est pour la/les raison(s) suivantes: (cochez tout ce qui convient)

- la norme a besoin d'être révisée
- la norme est incomplète
- la norme est trop théorique
- la norme est trop superficielle
- le titre est équivoque
- je n'ai pas fait le bon choix
- autre(s) .....

**Q7** Veuillez évaluer chacun des critères ci-dessous en utilisant les chiffres

- (1) inacceptable,
- (2) au-dessous de la moyenne,
- (3) moyen,
- (4) au-dessus de la moyenne,
- (5) exceptionnel,
- (6) sans objet

- publication en temps opportun .....
- qualité de la rédaction.....
- contenu technique .....
- disposition logique du contenu .....
- tableaux, diagrammes, graphiques, figures .....
- autre(s) .....

**Q8** Je lis/utilise: (une seule réponse)

- uniquement le texte français
- uniquement le texte anglais
- les textes anglais et français

**Q9** Veuillez nous faire part de vos observations éventuelles sur la CEI:

.....

.....

.....

.....

.....

.....

