

Energy Savings from Robust Control of Static Pressure Based upon Zonal Occupancy for Multiple-Zone VAV Systems

Ahmed Tukur, University of Dayton
Kevin P. Hallinan, University of Dayton
Kelly Kissock, University of Dayton

ABSTRACT

The increasing sophistication of Building Automation Systems has enabled the development of more complex control algorithms to increase system energy efficiency. Static pressure reset in Variable Air Volume (VAV) systems has long been used to reduce fan power during low flow requirements in a building, with reported savings from as low as 19% to as high as 60%. In this paper, a new static pressure reset algorithm that dynamically resets the zone minimum airflow set-points to match the required ventilation based on the occupancy of the zone is tested. This algorithm first performs Fault Detection and Diagnostics (FDD) to detect VAV terminal unit failures. Next, the algorithm adjusts the zonal volume air flow based upon known or anticipated occupancy using a trim and respond method. The uniqueness of this approach is the use of FDD to eliminate rogue zones (zones that constantly demand high flow and drive the pressure reset request) and ensure the static pressure reset algorithm works correctly. This algorithm was tested on a building in the Midwest U.S. with moderate occupancy variability. Fan energy savings of 25% compared to fixed static pressure control with constant minimum zonal flows were observed.

1. Introduction

The Department of Energy estimates 19% of primary energy consumption in the US has been in the commercial building sector. Of this 49.2% of all commercial building energy consumption is used for Heating, Ventilation, and Air Conditioning (HVAC) (DOE 2012). Variable Air Volume (VAV) HVAC systems gained popularity in the 1970's and are gradually replacing constant air volume (CAV) systems due to their higher energy efficiency (Smith 2013).

The major advantage of a VAV system is in part-load operation. In CAV systems, supply air fans operate at full design capacity all the time; part-load conditions are accommodated by mixing hot and cold air streams or by reheating cold air. In VAV systems, the cooling/heating air rate in each zone is determined by the deviation of the zone temperature from its setpoint and is usually driven by a PID logic in the VAV controller. VAV boxes that do not require heating or cooling at a given time will close to a minimum position required for ventilation. Supply air fan speed and flow is varied to meet these demands, which results in fan energy savings.

VAV systems also address part-load conditions for ventilation air. Ventilation air in multiple zone recirculating VAV systems is typically made up of fresh outdoor air and recirculated air. Traditionally, the ratio of outdoor and recirculated air was fixed based on design requirements, and in most cases remained the same over the lifetime of the system. Today, two prominent strategies are employed to reduce the ventilation airflow rate of VAV systems. These

are now included in ASHRAE Standard 62.1 - Ventilation for Acceptable Indoor Air Quality, and include: (i) Ventilation Rate Procedure that uses a prescribed zone ventilation rate depending on the type of activities carried out in the zone; and (ii) Indoor Air Quality Procedure. The indoor air quality procedure allows for the use of CO₂ – Demand Controlled Ventilation (DCV). CO₂-DCV is shown to be very effective in flow reduction especially in areas that are seldom occupied and have high people-based airflow rate requirements, e.g., conference rooms, school gymnasiums etc (S. T. Taylor 2006; Ng et al. 2011). Another method to achieve ventilation flow reduction is to set occupancy and standby statuses for each individual VAV box in a system and use occupancy sensors to drive control of the VAV box. A study reported by the PNNL showed on average that 17.8% can be saved nationally by using occupancy sensors to control VAV boxes in office buildings (Zhang et al. 2013).

Reduction of flow via VAV damper manipulation is one way to achieve fan energy savings in a VAV system. Another method is via reduction in total system pressure since the required fan power to move air through a VAV system is

$$Fan\ Power = \frac{\Delta P \times \dot{Q}}{\eta} \quad (1)$$

where ΔP is total system pressure drop, \dot{Q} is system ventilation flow rate, and η is the system ventilation efficiency. Numerous studies have been carried out in the area of VAV system pressure control (Stanke 1991; S. Taylor 2007; EDR 2009; Ma, Tukur, and Kissock 2015). The approach leading to the most energy savings is the critical zone based duct static pressure reset. Critical zone based duct static pressure reset is when the duct static pressure setpoint is changed continuously to meet the flow requirement of the most critical VAV box(es). Static pressure reset, however, suffers from a challenge that is referred to as the rogue zone problem (EDR 2009; S. Taylor 2007). Rogue zones are zones that constantly demand high flow and drive the pressure reset request as a result of failure of a component (VAV Dampers or Thermostat). Taylor (2007) indicated rogue zones must be addressed if static pressure control is to be successful and suggested the use of periodical trend reviews to exclude rogue zones. Another way to eliminate the rogue zone problem is to oversize the VAV boxes in questionable zones (EDR 2009).

A real-time method to address the rogue zone problem as part of the overall duct static pressure reset strategy is to use Fault Detection and Diagnostics (FDD). FDD methods are well established in other fields like Aerospace, Automotive, Manufacturing and Process Control Engineering, but it is still relatively new in HVAC. California's Title 24 (CEC 2013) requires FDD in some HVAC applications. A good review for FDD methods, classification, ease of implementation and applications can be found in (Katipamula and Brambley 2005a; Katipamula and Brambley 2005b). FDD methods can be classified broadly into Quantitative (simple and complex physics and mathematical based models) and Qualitative methods (Expert rules, threshold limit and first principles). Rule-based methods are one type of a Qualitative FDD that uses system knowledge and process history data to derive a set of rules to isolate faulty operation from proper operation (Venkatasubramanian et al. 2003).

In this paper, a coupled CO₂-DCV strategy and a reset algorithm based upon a rule-based FDD method to diagnose faulty thermostats and VAV dampers is used to vary ventilation rates and save energy. The uniqueness of this approach is its exploitation of available BAS data and utilization of real-time feedback from the zones to ensure the proper operation of the duct static pressure reset algorithm.

2. Methodology

The overall objective of this project is to minimize ventilation airflow and implement a duct static pressure reset algorithm with fault detection capabilities to guarantee minimum ventilation power and energy savings. To implement the proposed algorithm, a Building Automation System (BAS) with continuous and automated real-time data collection is necessary. Sensor and control point data used in this study as organized by zone/system include:

Zonal data

- Air volume flow rate (cfm) for each VAV terminal unit
- Damper position on each VAV terminal unit
- Occupancy Status on each VAV terminal unit
- Minimum air volume flow rate setpoint for each VAV terminal unit
- Zone temperature and zone temperature setpoint for each zone

Overall system data

- Duct static pressure sensor for the VAV system
- Power sensor on the VFD
- Duct static pressure set-point

The implementation requires three steps: (i). resetting the minimum zone airflow based on the CO₂ value in the zone; (ii). detecting rogue zones in the system by performing FDD; and (iii). resetting duct static pressure based on the damper positions of the critical zones. These steps are detailed below.

2.1 Resetting the Minimum Zone Airflow Based on CO₂ Value

The first step in this process is to determine the maximum allowable CO₂ value in the zone. This can be calculated from ASHRAE Standard 62.1 using equation (2) below which was derived by Taylor (2006) for steady-state CO₂ production in a zone.

$$C_z = C_{OA} + \frac{8400E_z m}{R_p + \frac{R_a A_z}{P_z}} \quad (2)$$

where C_z is the maximum allowable CO₂ concentration of the zone, C_{OA} is CO₂ concentration of the outdoor air, E_z is the zone air distribution effectiveness, m is the zone activity level, R_p is occupant ventilation rate component, R_a is the area-based ventilation rate component which can be determined from Standard 62.1-2013 (ANSI/ASHRAE 2013). A_z is the floor area of the zone that is occupied, and P_z is the design number of occupants in the zone. The maximum allowable zone CO₂ is then used to drive a simple linear reset algorithm that will linearly change the value for the zone minimum flow from 0 ft³/min to the maximum design value.

The desired minimum flow F_z in the zone at any point in time can then be calculated with the linear reset equation (3) as shown:

$$F_z = (C_c - C_{OA}) \times \frac{F_{Min}}{C_z - C_{OA}} \quad (3)$$

In this equation, C_c is the current CO₂ concentration of the zone and F_{min} is the design minimum airflow. The latter is calculated in the design phase of the VAV system or can be calculated using the prescriptive ventilation rate procedure of standard 62.1 (ANSI/ASHRAE 2013). The reset algorithm runs continuously in a loop with a time delay to avoid excessive changes and slowing

down of the BAS communication lines. The logic in setting the minimum flow rate is shown in the flow chart in Figure (1) below.

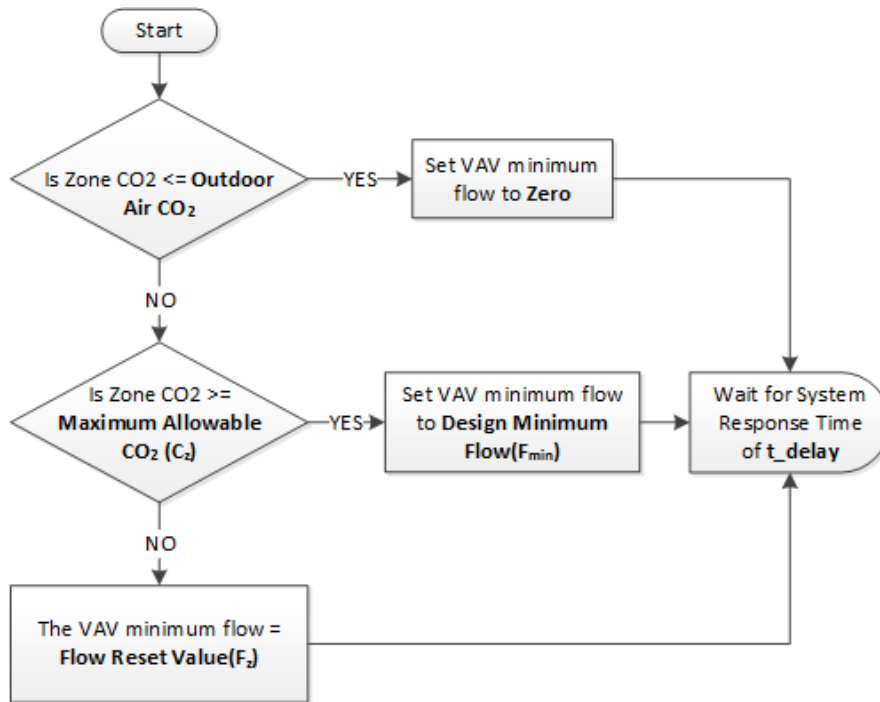

Figure 1. Logic used to reset the zone minimum airflow based on the zonal CO2 concentration

2.2 Rogue Zone Fault Detection and Diagnostics (FDD) Rules

In duct static pressure reset algorithms, the static pressure is reduced until it identifies one or more zones with open terminals. VAV boxes in which the damper is constantly fully open reduce or eliminate the energy saving potential of duct static pressure reset algorithms, thus, it is important to identify these “rogue” zones. A rogue zone may be the result of an undersized VAV box or a failure of one of two sub-systems; namely the zone thermostat or VAV Damper. The zone thermostat can fail to communicate its value to the BAS or it can send a stale value which does not change after a considerable amount of time. An incorrect space temperature value that is not close to the zone setpoint will keep the VAV damper open trying to satisfy the zonal heating and cooling requirements. A VAV box controller can also fail to communicate its damper position to the BAS or a VAV box with a stuck damper will fail to modulate.

An algorithm for fault detection and diagnosis (FDD) was developed to identify each of these failure modes. Any VAV box identified to be in fault is excluded from the static pressure reset algorithm. A number of methods to implement a rule-based FDD in a live site were considered. The main constraint for this approach is that the FDD not affect the normal operation of the HVAC equipment, thereby jeopardizing human comfort. Additionally, implementation of this approach is limited to the sensors already deployed on a site.

2.2.1 Thermostat FDD Rule and VAV Box FDD Rule

The thermostat FDD algorithm uses three rules to detect three identified rogue zone failures.

Rule 1 – Thermostat communication error: If a communication failure between the thermostat and BAS is detected, the duct static pressure reset algorithm will need to be aware in order to exclude that VAV box. This failure mode is only useful for installations where a thermostat communicates directly to a BAS. Many installations will have the thermostat communicating via the VAV box controller.

Rule 2 - Thermostat reporting a continuous zero value: Some battery powered thermostats produce a zero signal when the battery is dead; the BAS receives a continuous value of 0°F/null value. This rule checks for 0°F/null values for a time period greater than the data collection interval $data_int$ of the BAS. This rule checks the occupancy status of the zone (as inferred from the specified occupancy schedule for the zone) to ensure it is occupied in order to prevent wrong diagnosis of thermostats that are actually measuring a 0°F value at a given time.

Rule 3 – Thermostat reporting a stale value: When the value reported from the thermostat does not change after a considerable amount of time, $stale_int$, the value is said to be stale. There can be due to many causes. The scope of this work is to identify stale values and exclude the thermostat and linked VAV box from the duct static pressure reset algorithm.

The thermostat FDD rule is summarized in a flow chart in Figure (2a) below.

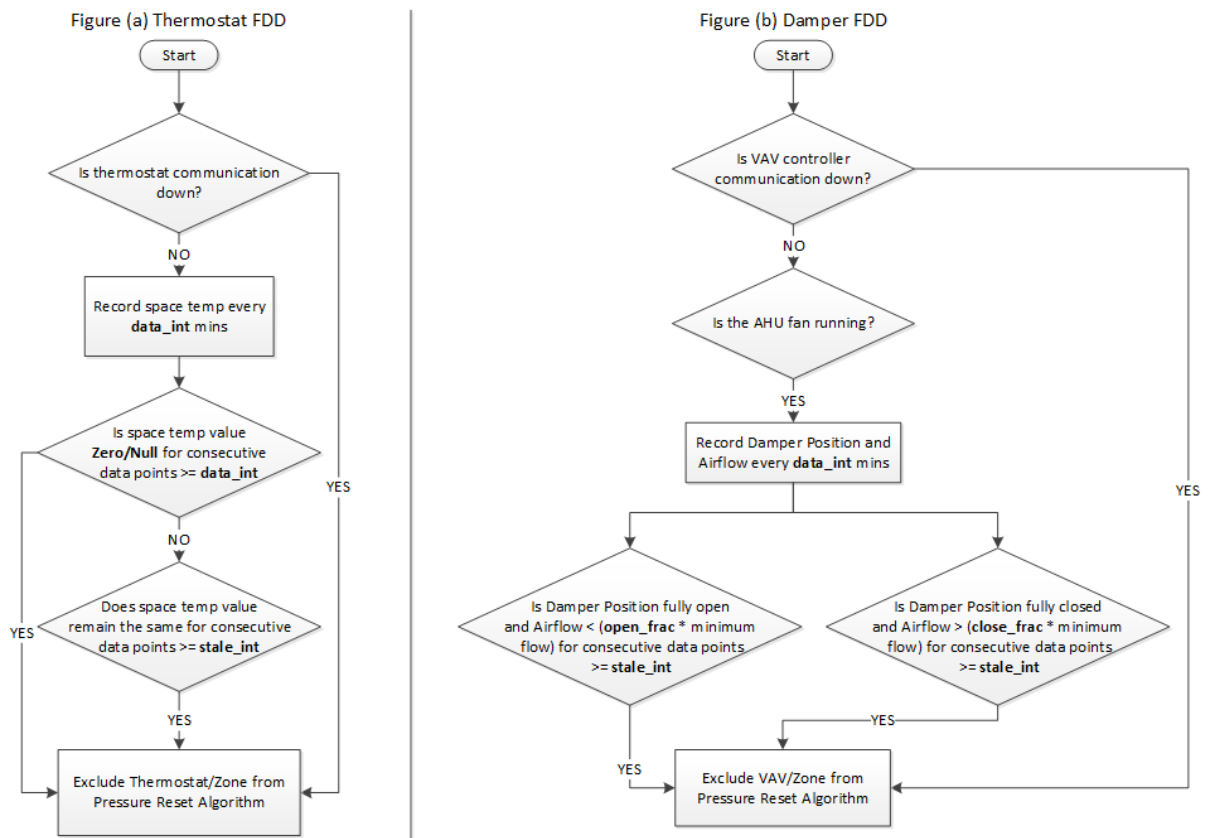

Figure 2. (a) Thermostat failure detection and diagnostic (FDD) (b) VAV damper FDD

The VAV box FDD algorithm uses two rules to detect two important failures.

Rule 1 - VAV box communication error: Most BAS are able to detect a communication error between a controller and the BAS. If a communication failure is detected, the SPR algorithm will need to aware in order to exclude that VAV box.

Rule 2 - Stuck damper position: To identify a stuck damper, the damper position of the VAV box will be compared to the reported airflow value at the two extreme values of the damper (fully closed damper position and fully open damper position).

Fully Closed: VAV damper is reporting a fully closed position and a significant amount of flow.

Fully Opened: VAV damper is reporting fully open and no significant amount of flow can be detected. The VAV box FDD rule is summarized in a flow chart in Figure (2b) above.

2.3 Static Pressure Reset

The duct static pressure reset algorithm used in this study is based on a previous work by the authors and described in detail in (Ma, Tukur, and Kissock 2015). The key logic with this approach is that the static pressure is reduced if the number of zones with open terminals is below a set value, and the static pressure is increased if the number of zones with open terminals is greater than a larger set value. An open control strategy is employed; with the static pressure adjusted incrementally. Time is allotted for the overall system to stabilize and then the process is repeated. The static pressure reset algorithm is shown schematically in Figure 3 below is developed and it executes the following steps in a loop:

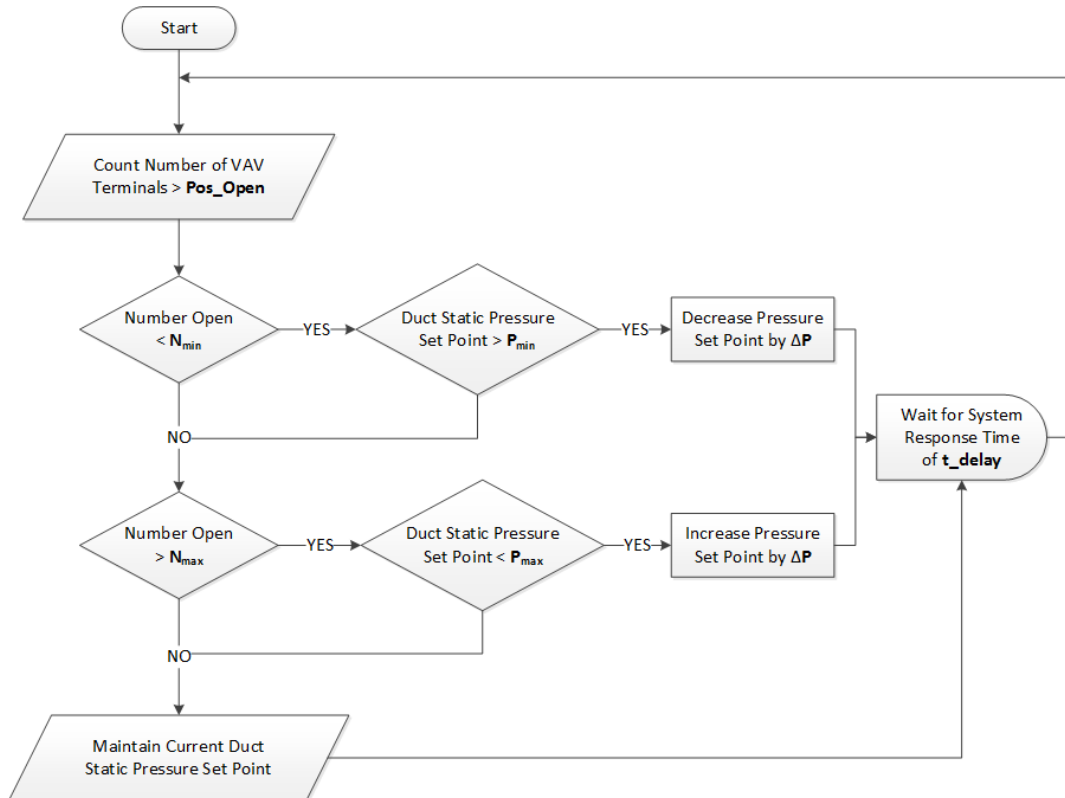

Figure 3. Duct static pressure reset algorithm flow chart

1. Poll through all terminal unit controllers and determine the number of terminals with damper position greater than Pos_{open}.
2. If the number of open terminals is greater than N_{max} and the duct static pressure is less than P_{max}, increase the duct static pressure setpoint by ΔP.
3. Else if the number of open terminals is less than N_{min} and the duct static pressure is greater than P_{min}, decrease the duct static pressure setpoint by ΔP.
4. Else, maintain current duct static pressure setpoint.
5. Delay by an amount of time defined in t_{delay}.

3. Case Study

This study was carried out on a multiple zone recirculating VAV system that includes one AHU and 20 VAV terminal zones and serves 12,000ft² of floor area. The AHU has a forward curved draw-through fan designed for low-pressure applications with a design total static pressure of 2.5 in. w.g. at commissioning. The fan runs at a maximum flow rate of 9,480 ft³/min at 8.87 BHP. The building is occupied from 8 AM to 5 PM weekdays. The AHU controls, VAV terminal controls and sensors are all interconnected using the ASHRAE BACnet protocol. The BAS provides continuous and automated real-time data collection and data was collected for 4 weeks at 5-minute intervals. A high density area with intermittent occupancy is the best zone for CO₂-DCV strategy as reported in (Dougan and Damiano 2004) therefore a CO₂ sensor was installed in the largest zone in the building, which is a training/conference room. The AHU supply fan airflow used in this study is the summation of the VAV airflows measured at each VAV terminal due to a lack of airflow station on the AHU.

Tables 1-3 document respectively the assumptions and parameters used for the case study, for fault detection and diagnostics (FDD), and for static pressure reset. The parameters were obtained from Standard 62.1-2013 using the conditions of the case study building. C_z was calculated from Equation (2) using the values in Table (1) to get 1,546 ppm. However to avoid occupant discomfort, a C_z value of 1,100 ppm was used, which is about 700 ppm above the C_{OA} as recommended in (Dougan and Damiano 2004).

Table 1. Parameters to calculate maximum allowable CO₂ in zone

Parameter	Value	Parameter	Value
R _p	5 cfm/person	m	1.0 activity met
R _a	0.06 cfm/ft ²	A _z	780 ft ²
P _z	50 people	C _{OA}	400 ppm
E _z	0.8	F _{min}	960 cfm

Table 2. Parameters for fault detection and diagnostic (FDD)

Parameter	Value	Parameter	Value
data_int	15 minutes	open_frac	10%
Stale_int	120 minutes	close_frac	50%

Table 3. Parameters for duct static pressure reset algorithm

Parameter	Value	Parameter	Value
Pos_open	90%	P _{max}	1.5 in. w.g.
N _{min}	3	ΔP	0.05 in. w.g.
N _{max}	5	t_delay	10 minutes
P _{min}	0.5 in. w.g.		

4. Results

The CO₂ based DCV developed here was applied to the main conference room of the building described in the case study section. The weather and occupancy conditions in the zone varied for the period of the study because the activities in the office could not be disrupted. The zone CO₂, zone minimum airflow setpoint and zone airflow are plotted against time for a typical day in Figure 4. Figure 4(a) shows the case before the application of the CO₂-DCV strategy; the minimum airflow setpoint is constant at 680 ft³/min, which was the airflow maintained in the zone for most of the day though the zone CO₂ varied from 400 ppm to 1000 ppm for that particular day. Figure 4(b) shows the case after the strategy was applied and the minimum airflow setpoint varied from 20 ft³/min to 350 ft³/min. The zone airflow was high during system startup to get the zone comfortable, but the airflow dropped to minimum airflow at about 10:30am and remained so for the rest of the day. The results clearly show a reduction in the required minimum airflow which will result in a reduction of the ventilation air portion of the VAV system.

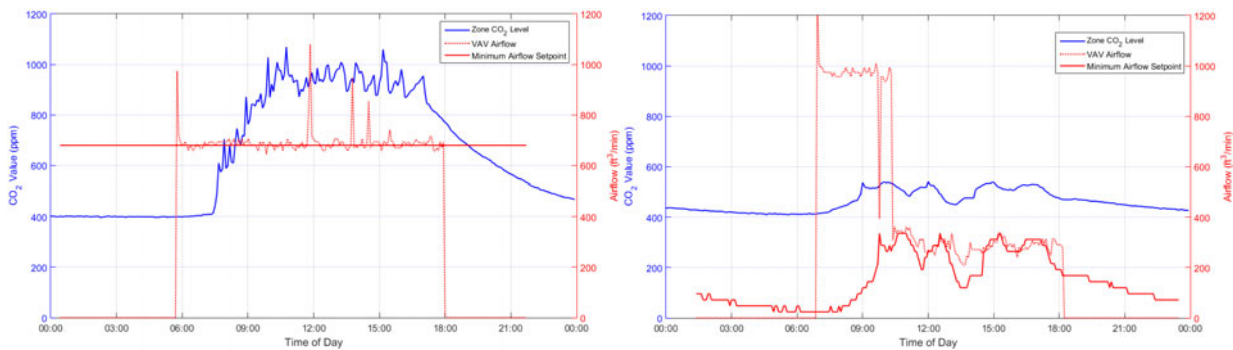

Figure 4. Zone minimum flow and setpoint (a) before CO₂-DCV, (b) after CO₂-DCV

For validation of the duct static pressure algorithm, the strategy was applied to an occupied office building under normal operations with nearly constant daily occupancy and similar weather conditions during the study period. Figure (5) below shows a time plot of duct static pressure and duct static pressure setpoint for a typical day; Figure (5a) without a reset and Figure (5b) with a reset. Without duct static pressure reset, the setpoint is constant (1.5 in. w.g.) and with a reset, the setpoint changes throughout the day (0.5 in. w.g. to 0.8 in. w.g.) depending on the number of open VAV dampers in the system. In both cases, the duct static pressure is tracking the setpoint except when it is unable to keep up e.g. between 4:30am and 8:30am in Figure 5(a).

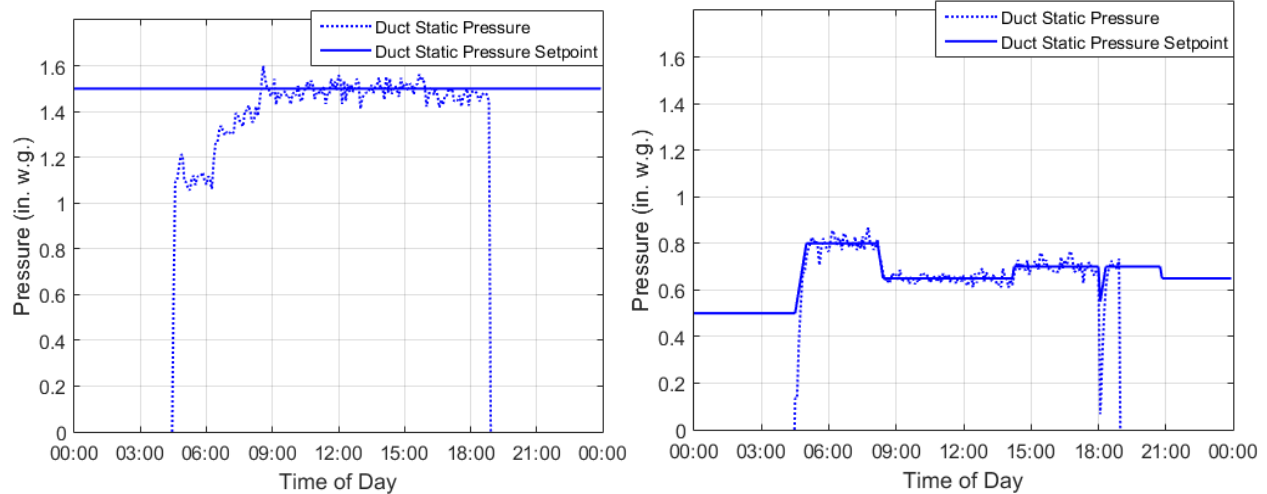

Figure 5. Duct static pressure vs setpoint (a) before DSP reset and (b) after DSP reset

In order to validate the FDD rules, an experiment was conducted to simulate a failure to see if the failure drives the static pressure reset. The static pressure setpoint was reset between 0.5 to 1.0 in. w.g. Figures (6) and (7) show time plots of the results of the test. In each case, the test was conducted over a period of three days:

- Day 1 shows the system operation without the failure and no FDD
- Day 2 shows the system operation with failure introduced but no FDD
- Day 3 shows the system operation with failure and FDD

Figure (6) shows the case of a zone thermostat failure. The first day shows a functioning thermostat correctly tracking the zone temperature and the static pressure being reset. The second day, a thermostat failure was introduced by taking the battery out of the thermostat; the zone temperature falls to 0°F creating a rogue zone which the static pressure constant. During the final day, the thermostat failure continued, but the thermostat FDD algorithm was introduced which excludes the rogue zone and allows the static pressure reset to function correctly.

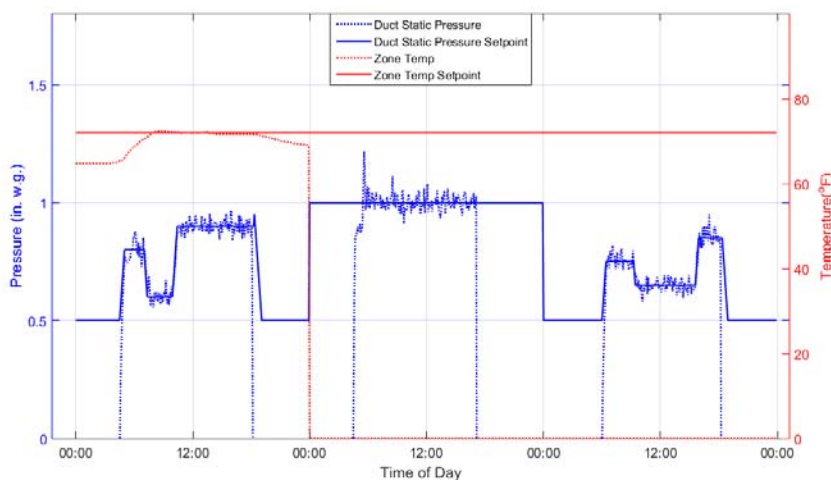

Figure 6. Time plot of duct static pressure vs setpoint and zone temperature vs setpoint depicting thermostat failure rule

A similar scenario with the case of a stuck damper failure is shown in Figure (7). The stuck damper failure was simulated by overriding the damper open to 100% in the second day. The FDD was introduced in third day and the pressure reset functioned correctly.

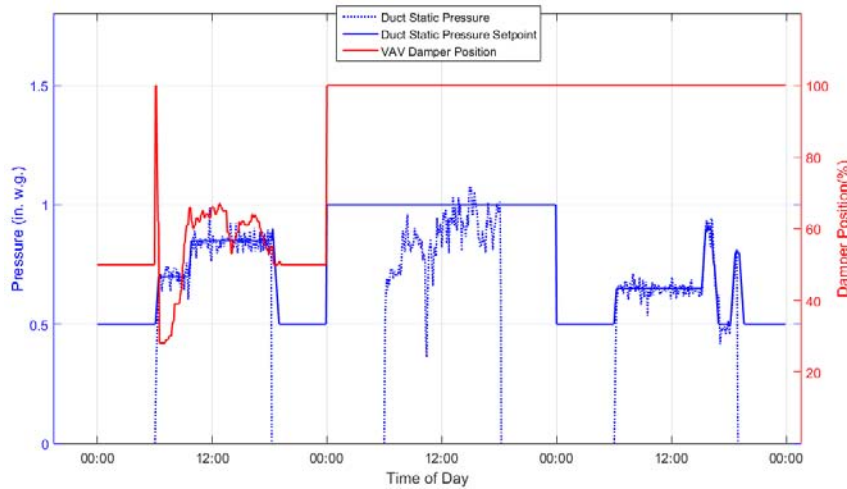

Figure 7. Time plot of duct static pressure vs setpoint and VAV damper position depicting VAV damper failure rule

AHU fan power consumption and system data were collected for 2 weeks before implementing the static pressure reset algorithm and for 2 weeks after implementing the algorithm. It was observed that the average airflow demand during the period after reset was higher than that during the period before reset; this was driven by difference in weather conditions and building load. To compare the energy savings from the reset, it is important to normalize the fan power with airflow. Normalizing the fan power with flow will allow for the calculation of the fan energy consumed before the reset using the airflow conditions after the reset.

The first step is to calculate total system efficiency by dividing the fluid power by the recorded fan power at the baseline condition ($Power_{fan, baseline}$) before implementing the static pressure reset algorithm

$$\eta = \frac{\Delta P_{before} \times \dot{Q}_{before}}{Power_{fan, baseline}} \quad (4)$$

where ΔP is total system pressure drop, \dot{Q} is system flow rate, η is the system efficiency, and Adjusted fan power consumption before the reset is then calculated using the system efficiency, and $Power_{fan, baseline_adjusted}$ is the fan power prior to implementation.

$$Power_{fan, baseline_adjusted} = \frac{\Delta P_{before} \times \dot{Q}_{after}}{\eta} \quad (5)$$

The energy savings from applying the static pressure reset are then calculated by subtracting the recorded fan power after the reset from the adjusted fan power before the reset. The average duct static pressure was reduced from 1.30 in w.g. to 0.77 in w.g. The average power draw from the AHU fan decreased by 20% while the average required airflow to the zones increased by 3%.

For the 2 weeks' period in this study, the fan energy savings were calculated to be 25% as shown in Table 4 below.

Table 4 Parameters for duct static pressure reset algorithm

Parameter	Before Reset (02/02 to 02/13)	After Reset (03/02 to 03/13)
Average Static Pressure (in. w.g.)	1.30	0.77
Average Airflow (ft ³ /min)	6,084	6,291
Average Power Draw (kW)	6.38	5.10
Total Energy Consumption (kWh)	841	672
Adjusted Energy Consumption (kWh)	899	-
Energy Savings Percent (%)	-	25%

5. Summary and Conclusion

One way to maintain sufficient duct static pressure is to determine the required duct static pressure based on design conditions. To reduce fan energy use, the duct static pressure can be dynamically reset based on zone damper position. However, the effectiveness of duct static pressure reset control is often compromised by rogue zones in which the damper position gets stuck at 100% open. This paper describes the implementation of a rule-based FDD that is well within the capabilities of current BAS systems to increase the robustness of duct static pressure reset control. Two FDD algorithms were introduced (i) thermostat failure, (ii) VAV damper failure, and it was demonstrated that simulated failures did not compromise the static pressure reset algorithm.

To meet zone ventilation requirements, a minimum flow rate is generally designated for each zone and corresponding VAV box. Traditionally, this minimum flow rate was determined based on design conditions. However, to improve energy efficiency, the minimum flow rate can be reset based on scheduling for zones with regular hours and using CO₂-DCV for zones with irregular occupancy like conference rooms. This paper describes the implementation of a CO₂-DCV based minimum air flow control algorithm, and demonstrates its effectiveness at varying the minimum air flow to meet occupancy requirements.

Finally, a control scheme with 1) a rule-based FDD to compensate for rogue zones 2) CO₂-DCV based minimum air flow, and 3) an advanced duct static-pressure reset algorithm was introduced into an office building. Fan energy savings of 25% were recorded compared to a system with constant static pressure. The implementation of such advanced algorithms can be done on any system with DDC controls and a BAS, however, execution is currently limited to skilled HVAC control specialists.

This work demonstrates how smart algorithms can be programmed into standard BASs to enhance the energy efficiency of VAV systems while meeting ventilation requirements and handling real-world equipment failures that otherwise compromise the overall performance of VAV systems.

Acknowledgements

The authors wish to thank Waibel Energy Systems for providing the data used in this study.

References

- ANSI/ASHRAE. 2013. *Standard 62.1-2013. Ventilation for Acceptable Indoor Air Quality*. Atlanta, Georgia.
- CEC. 2013. *BUILDING ENERGY EFFICIENCY STANDARDS For Residential and Nonresidential Buildings*. Vol. CEC 400 20. Sacramento: CALIFORNIA ENERGY COMMISSION.
- Cline, Lee, Don Eppelheimer, Ryan Geister, and Mick Schwedler. 2011. "VSDs and Their Effect on System Components." Edited by Trane Engineers Newsletter LIVE! Series. Wisconsin: Trane.
- DOE. 2012. *Buildings Energy Data Book*. Edited by Ltd D&R International. 2011th ed. Washington D.C.: US Department of Energy.
http://buildingsdatabook.eren.doe.gov/docs/DataBooks/2011_BEDB.pdf.
- Dougan, David S., and Len Damiano. 2004. "CO₂-Based Demand Control Ventilation: Do Risks Outweigh Potential Rewards?" *ASHRAE Journal* 46 (10): 47–54.
- EDR. 2009. *Advanced Variable Air Volume VAV System Design Guide*. Edited by Jeff Stein. Vol. Third. California: California Energy Commission.
- Katipamula, Srinivas, and Michael R Brambley. 2005a. "Methods for Fault Detection, Diagnostics, and Prognostics for Building Systems--A Review, Part I." *HVAC&R Research* 11 (1). Taylor & Francis Ltd: 3–25.
<http://search.ebscohost.com/login.aspx?direct=true&db=a9h&AN=16258709&site=ehost-live>.
- . 2005b. "Methods for Fault Detection, Diagnostics, and Prognostics for Building Systems-- A Review, Part II." *HVAC&R Research* 11 (2). Taylor & Francis Ltd: 169–87.
<http://search.ebscohost.com/login.aspx?direct=true&db=a9h&AN=16790962&site=ehost-live>.
- Ma, Yin, Ahmed Tukur, and Kelly Kissock. 2015. "Energy-Efficient Static Pressure Reset in VAV Systems." *ASHRAE Transactions* 121 (1). ASHRAE: 102–9.
<http://libproxy.udayton.edu/login?url=http://search.ebscohost.com/login.aspx?direct=true&db=a9h&AN=108334557&site=ehost-live>.

- Ng, Malcolm Owen, Ming Qu, Pengxuan Zheng, Zhiyuan Li, and Yin Hang. 2011. "CO₂-Based Demand Controlled Ventilation under New ASHRAE Standard 62.1-2010: A Case Study for a Gymnasium of an Elementary School at West Lafayette, Indiana." *Energy and Buildings* 43 (11): 3216–25. doi:10.1016/j.enbuild.2011.08.021.
- Smith, Wade W. 2013. "The New 'New Most Efficient Thing' in Commercial HVAC Systems." *ASHRAE Journal*, February. ASHRAE, 16–20.
<http://search.ebscohost.com/login.aspx?direct=true&db=a9h&AN=90155366&site=ehost-live>.
- Stanke, D. 1991. "VAV System Optimization: Critical Zone Reset." *Trane Engineers Newsletter* 20 (2).
- Taylor, Steven. 2007. "Increasing Efficiency With VAV System VAV System Static Pressure Static Pressure Setpoint Reset." *ASHRAE Journal*.
file:///C:/Users/atukur/Downloads/Taylor-0607--feature.pdf.
- Taylor, Steven T. 2006. "CO₂-Based DCV Using 62.1-2004: Demand-Controlled Ventilation." *ASHRAE Journal* 48 (5): 67–75.
- Venkatasubramanian, Venkat, Raghunathan Rengaswamy, Surya N Kavuri, and Kewen Yin. 2003. "A Review of Process Fault Detection and Diagnosis: Part III: Process History Based Methods." *Computers & Chemical Engineering* 27 (3): 327–46. doi:10.1016/S0098-1354(02)00162-X.
- Zhang, J, G Liu, RG Lutes, and MR Brambley. 2013. *Energy Savings for Occupancy- Based Control (OBC) of Variable- Air-Volume (VAV) Systems*. Richland, Washington.