



# Emergency Lighting Design Guide

**EATON**

*Powering Business Worldwide*

**Doncaster Civic and Cultural Quarter**  
Doncaster



<b>1. Emergency Lighting Regulations</b> .....	<b>4</b>
1. Carry Out Risk Assessment .....	<b>4</b>
2. Know What You Are Buying .....	<b>4</b>
3. Look For Third-Party Certification .....	<b>4</b>
4. Consider The Long-Term Costs .....	<b>5</b>
5. Location, Location, Location .....	<b>6</b>
6. Pay Attention To The Exit .....	<b>6</b>
7. Think About Maintenance and Servicing .....	<b>6</b>
8. Don't Ignore The Signs .....	<b>7</b>
<b>2. The Fire Safety Order 2005</b> .....	<b>9</b>
<b>3. Health and Safety Regulations</b> .....	<b>10</b>
Other Regulations .....	<b>10</b>
<b>4. Emergency Lighting System Design</b> .....	<b>11</b>
Design Objective .....	<b>11</b>
<b>5. Stages of Emergency Lighting Design</b> .....	<b>12</b>
Stage 1 - Mandatory Points of Emphasis .....	<b>12</b>
Stage 2 - Exit Sign Formats .....	<b>14</b>
Stage 3 - Essential Luminaire Areas .....	<b>16</b>
Stage 4 - Escape Route Lighting .....	<b>18</b>
Stage 5 - Open (Anti-Panic) Core Areas .....	<b>21</b>
Stage 6 - High Risk Area .....	<b>21</b>
Stage 7 - Control .....	<b>22</b>
<b>6. Automatic Test Systems</b> .....	<b>24</b>
CGLine+ / Intellem .....	<b>24</b>
<b>7. Example of System Design</b> .....	<b>26</b>
<b>8. Wiring Installation</b> .....	<b>28</b>
<b>9. Spacing Tables</b> .....	<b>30</b>

### Eight ways to ensure compliance with emergency lighting regulations

Emergency lighting can be a lifeline for people trying to find their way out of a building if main lighting fails, and this is particularly important in the event of a fire. To ensure that emergency lighting is fit for purpose, the Regulatory Reform (Fire Safety) Order 2005, which brings all aspects of fire safety under one roof, recommends that the emergency lighting used is covered by the BSI Kitemark scheme. So how can you be sure your emergency lighting is compliant?

#### 1. Carry out a risk assessment

If you have five or more employees, you are required by law, under the Regulatory Reform (Fire Safety) Order, to carry out a fire safety risk assessment and must keep a written record of the assessment. This legislation exists to ensure that the correct emergency lighting is installed to cover any identifiable risks and that it will correctly operate in the event of a failure of the main lighting supply. BS5266 is the code of practice for the emergency lighting of premises, which provides information on the correct emergency lighting for the safety of people. Additionally, the BS5266 code, along with the BSEN1838 code, provides specifiers with information regarding areas that need emergency lighting such as: the minimum levels of illumination, duration, maximum brightness to prevent glare, and any points of emphasis which require particular consideration. Failure to comply with these stipulations not only puts lives at risk and raises the possibility of prosecution, but can also invalidate insurance policies.

#### 2. Know what you are buying

Given that emergency lighting will never be used on an everyday basis, it can be tempting to opt for cheaper luminaires. These are often supplied from distant sources and will pass through numerous intermediaries before installation. This can lead to confusion over the precise specifications and the claims made by manufacturers and sellers, which may not be independently verified. Buying cheaply may also turn out to be a false economy since lower-quality components can shorten the lifespan of batteries and lamps; they may also have inferior optics, resulting in an increased number of fittings being required to meet the minimum emergency lighting levels. As this is a life safety product you do need to consider whether a cheaper option might be more vulnerable to failure.

#### 3. Look for third-party certification

The most reliable way to ensure your emergency lighting is fit for purpose is to buy products approved by third-party certification schemes such as BSI Kitemarking and the Industry Committee for Emergency Lighting (ICEL) registration. The BSI governs the implementation of strict European standards on the design and manufacture of emergency luminaires under regulations including EN60598-1 and EN60598-2-22.



Meanwhile, the manufacturers' trade organisation ICEL provides a product auditing and approval process. If ICEL approved luminaires are installed at the correct location, according to the recommendations of BS5266, using verified spacing data, the emergency lighting system will meet the minimum emergency lighting levels for the safety of people. However, this may need enhancement if specific risks are identified during the risk assessment. Upon meeting these conditions, the installation would then be considered sufficiently safe to protect users of the building and reduce the likelihood of any legal action relating to non-compliance with the Regulatory Reform Order.

**4. Consider the long-term costs** Buying high-quality and industry-approved emergency lighting may initially seem more costly, but consider the bigger picture. For example, good quality products may have a higher output and better spacing performance meaning fewer units are needed to achieve the required level of illumination, which may not only reduce the outlay on products but also the installation cost. It is also worth bearing in mind the total cost of ownership (TCO) as long-term energy costs may be reduced. Additionally, it's worth considering LED-based emergency luminaires. They use less power, therefore reduce running costs and require less maintenance. LED-based emergency luminaires have a working life often greater than 50,000 hours, which is up to 10 times longer than a conventional fluorescent lamp. Furthermore, the latest generation incorporate optic lenses to direct light into a specific pattern. This ensures the light is correctly distributed to maximise the coverage for emergency lighting from the luminaire, which may be needed to cover a larger open area or a specific distribution to maximise the spacing along an escape route.



### 5. Location, location, location

The positioning of emergency lighting is crucial. Some of the key locations where emergency luminaires should be installed are: along escape routes, at every change in direction, adjacent to any step or trip hazard, over every flight of stairs so that each tread receives direct light, close to firefighting equipment, call points and first aid points, outside every final exit to a place of safety or any other location identified by the risk assessment.

Under the regulations, a minimum luminance of 1 lux is required on the centre line of an escape route with a uniformity of at least 40:1. In open areas however, a minimum of 0.5 lux is required. To achieve these minimum levels, refer to the spacing tables that should be provided by your chosen manufacturer.



Higher levels of luminance will also be required for areas identified as having a higher risk. Examples of these areas are described within the BS5266 guidance, along with the recommended higher lux level values.

### 6. Pay attention to the exit

What if a failure of supply occurs in the hours of darkness? Regulation BS5266-1:2011 requires that external lighting must be provided to guide evacuees from the point where they exit a building to a place of safety. This means that many applications will need a weatherproof luminaire operating in maintained or switched maintained mode, controlled by daylight sensors. LED luminaires can be used for this purpose to reduce maintenance and running costs.

### 7. Think about maintenance and servicing

Minimum routine testing schedules are one of the requirements of the regulations and standards. The time this takes can become a significant demand on facilities managers and maintenance teams. One way to avoid the ongoing costs associated with maintenance, servicing, repairs and replacements is to specify quality emergency luminaires in the first place. Another tip is to consider self-testing systems, which reduce the expense, time demands and disruption associated with manual testing regimes upon individual luminaires. With automatic test systems, results from an entire network are collected and fed back to a central point where the exact location of the fault can be pinpointed. The system will also identify the cause of the fault which might be a failed lamp or module, so that the necessary spare part can be selected and taken to the location to speed up the repair process.

## 8 Don't ignore the signs

In addition to the emergency lighting, it's important to consider signage at the earliest stage. The obligation is to ensure that escape routes are clearly defined and identified with the correct exit signage. When selecting a product, be aware that the viewing distance for an internally-illuminated exit sign is calculated by multiplying the height of the illuminated element by a factor of 200. This information will normally be available from reputable manufacturers. For externally illuminated signs, the multiplication factor is only 100, but it must have at least 5 lux at any point of the sign in emergency conditions.

An alternative option is the photoluminescent exit sign. However, it is important to remember that these rely on ambient light to charge their photoluminescent membrane. Additionally, EN1838 states that under emergency lighting conditions the sign shall be sufficiently illuminated to be visible. The safety colour must remain green and the contrast colour must remain white within the colour boundaries specified in ISO3864-4. This usually means that general lighting must be permanently switched on in order for the exit light to self-illuminate in the event of a power failure.

### Main points are:

- That the law now covers all premises that have employees or are visited by members of the public. (Previously, fire certificates did not cover small premises).
- Emergency lighting should be upgraded to meet the current standards. (Previously premises did not have to be upgraded when standards improved, now those engineered to previous issues need to be brought up to date).

The building regulations detail the design and construction characteristics of a building. Approved documents details the fire safety requirements for new buildings and the major refurbishment of existing premises. These documents shows the locations that must be provided with emergency lighting. This list should be used as a starting point and BS5266-1:2011 should be referred to as the main source of information. This provides information for areas requiring emergency lighting but also best practice for the lighting of a selection of high risk tasks. It also clarifies that emergency lighting is needed for all parts of schools that either do not have natural light or are used outside normal school hours. The regulations require that systems comply with BS 5266-1:2011 the code of practice for emergency lighting.



# Huddersfield Leisure Centre

Huddersfield

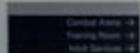



### The Fire Safety Order 2005

The Government has produced 11 guides for individual applications to help employers to conduct their assessments and gives guidance on the safety equipment required.

The guides make it clear that occupants have to be protected from risks in the event of the normal supply failing. To assist users they advise that:

- Emergency lighting is likely to be required where any escape routes are internal and without windows or if the premises are used during darkness (including early darkness in winter).
- The assessment should cover the location of employees and any visitors (including information on those persons with disabilities) to the site to assist in determining the areas requiring emergency lighting.
- The guidance gives detailed requirements for the suitability of escape routes and calls for the installation of emergency lighting to be in accordance with BS 5266-1.
- The risk assessment should identify any areas that require additional emergency lighting provision. BS5266-1:2011 lists examples of these areas detailing the required levels, duration, and the plane to be illuminated, as examples, a school chemical laboratory which may be smaller than 60m<sup>2</sup> but still need emergency lighting, as combustible materials and sources of ignition would be present, or commercial kitchens.
- It recommends that advice on the installation should be given by a competent person who specialises in emergency lighting systems.
- Continued maintenance and testing must be correctly carried out to comply with the directive.
- One way of ensuring the competence of your provider would be registration of a reputable scheme such as the BAFE (British Approvals for Fire Equipment) SP203-4 scheme.
- The equipment used must be capable of being demonstrated as of adequate quality. Compliance with the appropriate British Standard, or other approved third party scheme, gives evidence of this. The standard for luminaires is BS EN 60598-2-22. ICEL 1001 registration endorses the spacing data of these luminaires. The standard for central battery systems is BS EN 50171.

**Note:** When the premises are being assessed for risk, shortcomings in other areas of fire protection can be compensated for by improved levels of emergency lighting and fire alarms.

### The Health and Safety (Safety Signs and Signals) Regulations 1996

These regulations bring into force the EC Safety Signs Directive (92/58/EEC) on the provision and use of safety signs at work. From 2012 the new ISO 7010 Pictogram signs will also be legal but should not be mixed with other formats on an installation.

These regulations apply to all safety signs including those which provide directional signage for escape routes.

### Other Regulations

In addition to fire safety legislation, some workplaces require a licence from the Local Authority, including theatres and cinemas, sport stadiums and premises for public entertainment, music, dancing, gambling and the sale of alcohol. Other premises must be registered with the Local Authority and be inspected by the Fire Authority, including nursing homes, children's homes, residential care homes and independent schools. Both licensed and registered premises have to pass a fire inspection to confirm that they have systems complying with BS 5266-1 for the emergency lighting and BS 5839 for fire equipment. Records of a system are now essential to maintain the validity of approvals and licences.



### Emergency Lighting - System Design

This section provides guidance on system design to meet BS 5266 Parts 1 and EN1838 and so achieve compliance with legislation.

#### Design Objective

BS 5266-1:2011 gives recommendations and guidance on the factors that need to be considered in the design of, and the installation and wiring of, electrical emergency escape lighting systems. This provides the lighting performance needed for safe movement of people in the event of the supply to normal lighting failing. It also gives recommendations for lighting in areas with fixed seating. From this it can be seen that you should ensure the following provisions are fulfilled.

- a) Indicate clearly and unambiguously the escape routes.
- b) Provide illumination along such routes to allow safe movement towards and through the exits provided.
- c) Ensure that fire alarm call points and fire fighting equipment, provided along escape routes can be readily located.
- d) To ensure that any area requiring special consideration as identified by the risk assessment have the necessary level of emergency illumination.
- e) To permit operations concerned with safety measures.

BS 5266-1 recommends that discussions should be held prior to commencing the design, to establish the areas to be covered, the method of operation, the testing regime and the most suitable type of system. These discussions should include the owner or occupier of the premises, the system designer, the installer and the supplier of the equipment.

At this stage the provision of plans should be made available to identify:

- a) escape routes
- b) open areas
- c) high risk task areas
- d) safety equipment, including fire safety equipment, safety signs and any other aspects identified by risk assessment
- e) details of normal lighting and its control system

**Note:** BS 5266 was revised in 2011. For up to date information visit our website at [www.eaton.eu](http://www.eaton.eu). Alternatively visit the British Standards Institute website, at [www.bsi-global.com](http://www.bsi-global.com)

### Stage 1

#### Locate luminaires at mandatory “Points of Emphasis”

Initial design is conducted by situating luminaires to reveal specific hazards and highlight safety equipment and signs, care should be taken to ensure the correct illumination level is achieved, in addition to providing illumination to assist safe travel along the escape route. This should be performed regardless of whether it is an emergency escape route or an open (anti-panic) area. Only when this is accomplished should the type of luminaire or its light output be considered. BS EN 1838: 2013 requires that the luminaires sited at points of emphasis must comply with BS EN 60 598-2-22.

Specific locations where a luminaire must be provided are:



At each exit door

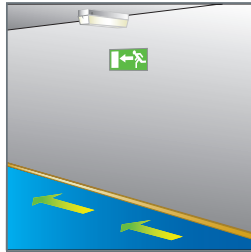

All safety exit signs

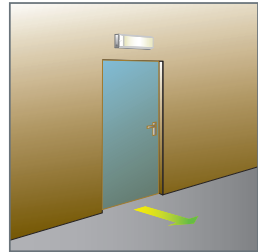

Outside the final exits and to a place of safety

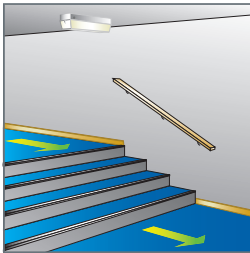

Near stairs so that each tread receives direct light

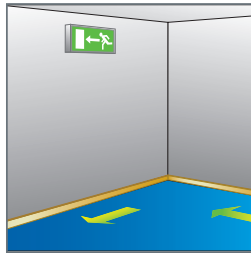

At each change of direction

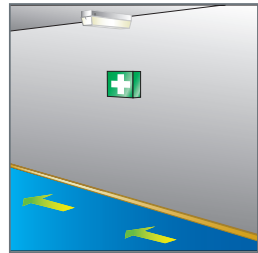

Near each first aid post

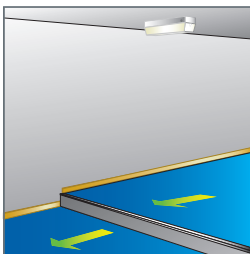

Near any other change of floor level

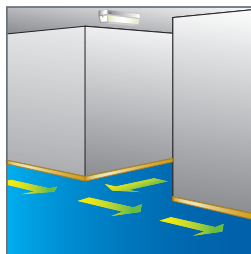

At each intersection of corridors

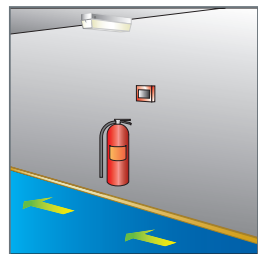

Near each piece of fire fighting equipment and call point



### Stage 2

#### Ensure the exit signs are of correct format and size

Section 4.1 of BS EN 1838: 2013 states that "Signs which are provided at all exits intended to be used in an emergency and along escape routes shall be illuminated to indicate unambiguously the route of escape to a point of safety". Where direct sight of an emergency exit is not possible, an illuminated directional sign (or series of signs) shall be provided to assist progression towards the emergency exit.

#### Sign formats should not be mixed



##### BS 2560: 197

Old-style signs now obsolete. Should have been replaced by December 1998.



##### BS 5499 Pt 1

Signs are still acceptable, if they are already in the building.



##### European Signs Directive Format

This came into force on 1st April 1996, under The Signs Directive.



##### ISO 7010

In 2011, it was decided by many of the National Standards bodies to consider adoption of a single pictogram format as detailed in ISO 7010. This format was adopted by BSI in the latest edition of BS5266-1: 2011 which is considered to be the 'de-facto' emergency lighting standard in the UK - BS 5499 has also adopted this format.

BS5499 has been recently updated and now follows the ISO format and allows the addition of text to the sign.

### Maximum Viewing Distances

For all formats of safety signs, the maximum viewing distances and luminance conditions are given in EN 1838: 2013. Signs can be either internally illuminated, such as exit boxes or edge lit emergency luminaires with a screened sign that have a controlled illuminance, or painted signs. These include photoluminescent signs, but to be acceptable they must have an external light illuminating them in normal condition to 100 lux and 5 lux on any part of the face under mains failure condition.

### Maximum viewing distances are:

Internally illuminated signs - 200 x the panel height

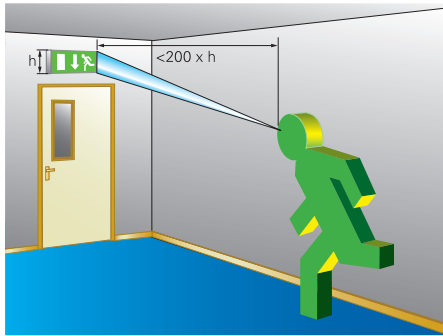

Externally illuminated signs - 100 x the panel height

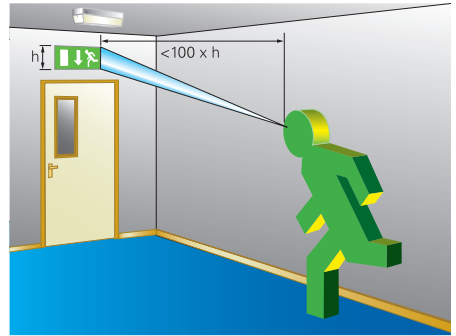

### Illumination Requirements

The sign must conform to the colours of ISO 3864, which defines that exit and first aid signs must be white with green as the contrast colour. The ratio of luminance of the white colour to the green colour must be between 5:1 and 15:1. The minimum luminance of any 10mm patch area on the sign must be greater than  $2\text{cd/m}^2$  and the ratio of maximum to minimum luminance shall be less than 10:1 for either colour.

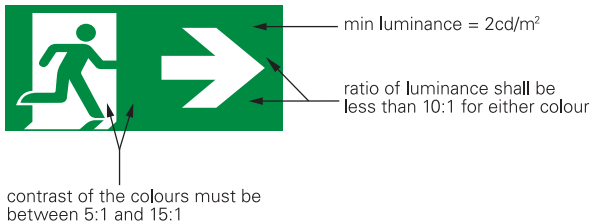

**Note:** Internally illuminated exit signs are pre-tested to ensure they meet these requirements, provided that they comply with EN 60598-2-22. If the sign is designed to be externally illuminated, considerable care must be taken by the system designer to see that these conditions are met. Even though an emergency luminaire must be sited within 2 metres from the sign (see stage 1) calculations should still be made to check that the sign is illuminated to 5 lux on any part of the face in emergency conditions.

### Stage 3

#### Locate luminaires at the following essential areas in the buildings

These locations are not part of the escape route but because of their risk they require protection by emergency lighting. Some of these areas are specifically defined in BS 5266-1:2011. Others are likely to be hazard areas defined by the risk assessment.

a) Lift cars - although only in exceptional circumstances will they be part of the escape route, they do present a problem in that the public may be trapped in them in the event of a supply failure.



b) Toilets - all toilets for the disabled and facilities exceeding 8m<sup>2</sup> floor area or without borrowed lights. Note the current issue of BS 5266-1: 2011 now excludes the en-suite facilities in hotels.

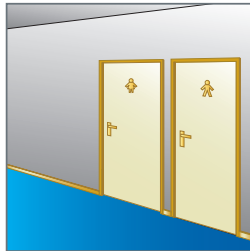

c) Escalators - to enable users to get off them safely.

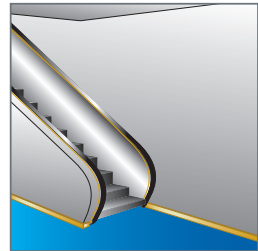

Some high risk areas, requiring a higher lux level, are also stated in BS 5266-1:2011, including:

#### Corridor and refuge area

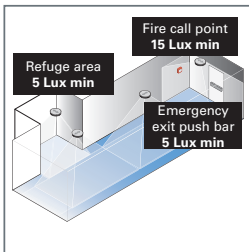

#### Plant room

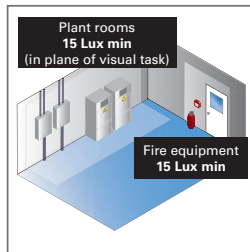

#### Kitchen

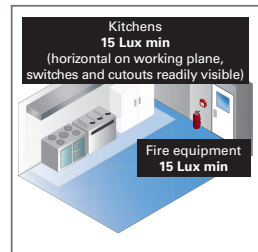

#### Reception areas

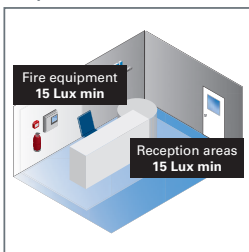

#### First aid rooms

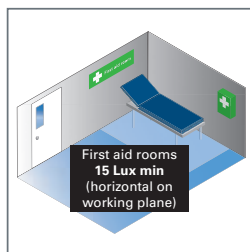

#### Treatment rooms

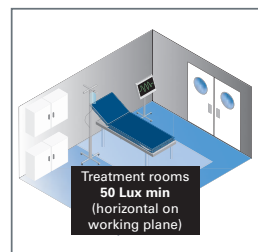



**These areas may also be considered as high risk and covered in stage 6**

**Kitchens** - Sudden failure of lighting while staff are cooking hot food is potentially dangerous. Currently these areas would need an emergency light over the extinguisher but emergency lighting is also needed over the area for hot food preparation. Employees need to be able to locate and turn off machinery/ovens/hobs etc. to ensure that they do not turn on once the supply is re-instated and cause a possible unsafe condition.

**First aid and treatment rooms** - Currently the requirement is for the light level needed for the safety of the individual, however system designers need to consider the light level response and duration times of emergency lighting of first aid rooms where treatment is to be given.

**Refuge areas for disabled people** - In these areas fire wardens will now have to go and collect disabled persons, often transferring them into rescue sleds to enable them to be safely taken downstairs. Consideration should be given to the light level response and duration times of emergency lighting in refuges.

**Fire equipment** - In a fire condition, users must inspect and act on the condition of fire alarm panels and repeaters. The light must be of a sufficient level to the correct plane of visual task to enable displays to be read accurately. The staff will also have to contact the fire brigade so they must have sufficient illumination for the number to be dialled correctly in the emergency condition.

**Panic bars and pads** - The emergency lighting must provide adequate direct illumination on crash bars on exit doors to enable them to be easily seen and operated, consider using exit signs above with downward light panels.

**Motor generator, control or plant rooms**

- Require battery supplied emergency lighting to assist any maintenance or operating personnel in the event of failure.

**Covered car parks** - The normal pedestrian routes should be provided with non-maintained luminaires of at least 1 hour duration.

Further information regarding duration and emergency illumination levels are shown in BS5266-1: 2011.

## Stage 4

### Escape Route Lighting

When the points of emphasis have been covered, it is essential to provide any additional luminaires to ensure that minimum illuminance levels are met to enable the routes to be used safely. In addition, every compartment on the escape route must have at least two luminaires, to provide some light in the event of luminaire failure.

- **Lighting Level Requirements**

BS EN 1838: 2013 4.2 calls for a minimum of 1 lux anywhere on the centre line of the escape route for normal risks. A uniformity ratio of 40:1 maximum to minimum must not be exceeded. This illuminance must be provided for the full duration and life of the system. 50% of the illuminance must be available within 5 seconds and the full value within 60 seconds of supply failure.

**Note:** The UK had an “a deviation” which allowed a 0.2 lux minimum value for routes that will be permanently unobstructed. This has now been removed and any existing escape routes illuminated to this level must be upgraded to the current 1 lux value.

- **Photometric Design**

#### Emergency Escape Routes

The use of authenticated spacing tables or a suitable computer program provides the information to determine whether luminaires are needed in addition to those for the points of emphasis (see data section), to provide the minimum required level of illumination on the escape routes. To ensure that the design will meet the required levels at all times the data is de-rated, as required by the standard, to cover the following factors:

- Reduction in light as the battery voltage reduces during discharge
- Ageing of lamps in maintained circuits
- The effects of dirt



### Photometric Data

Mode	Mounting height (m)	Lux level directly under	Escape route 2m wide 1 lux min				Open (anti-panic) area 0.5 lux min			
			⌈	⌈	⌈	⌈	⌈ <sub>0.5L</sub>	⌈ <sub>0.5L</sub>	⌈ <sub>0.5L</sub>	⌈ <sub>0.5L</sub>
Self-contained										
NM	2.5	3.28	3.9	11.3	4.0	2.0	4.0	12.0	6.0	1.9
	4.0	1.28	2.1	9.6	5.6	1.2	3.3	14.8	7.2	1.9
	6.0	0.57	-	-	-	-	1.6	12.4	7.4	0.8
M	2.5	2.75	3.3	10.7	5.2	1.8	3.7	11.7	5.8	1.8
	4.0	1.07	1.5	8.0	5.0	0.7	3.5	14.2	7.0	1.7
	6.0	0.48	-	-	-	-	-	-	-	-

Example - luminaire spacing along escape route

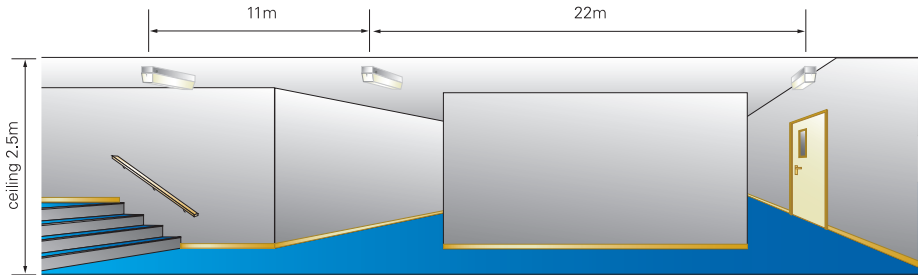

Locate luminaires at mandatory "Points of emphasis"

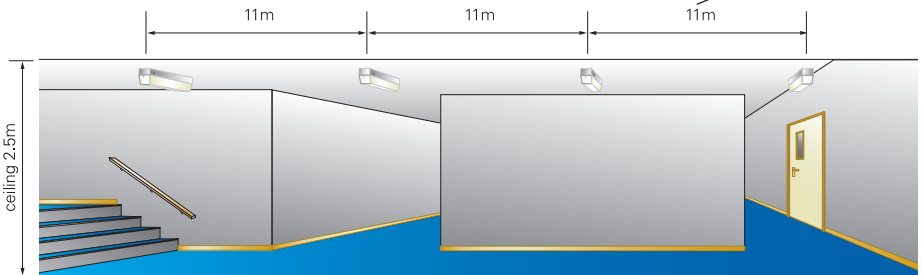

Add additional luminaire to achieve 1 lux minimum

Luminaire spacing in open (anti-panic) core areas

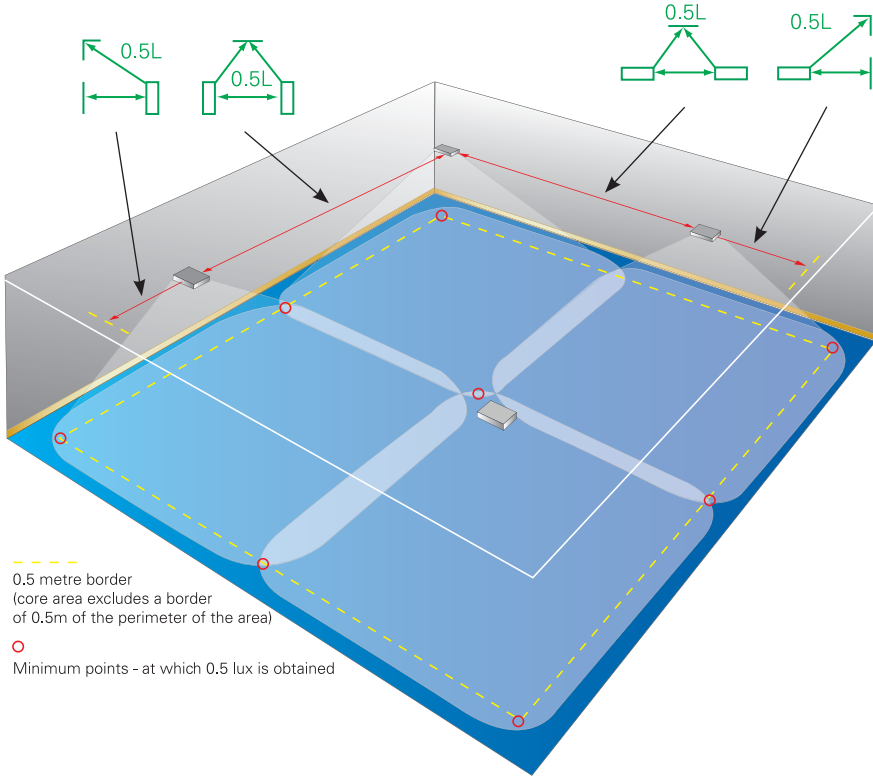

## Stage 5

### Open (Anti-Panic) Core Areas

Areas larger than 60m<sup>2</sup>, open areas with an escape route passing through them, or **hazards identified by the building risk assessment** all require emergency lighting. The current standard is easy to design for and to verify, promoting systems that provide good uniformity rather than ones that use a few large output luminaires.

- **Light Level Requirements**

BS EN 1838:2013 - 4.3 calls for 0.5 lux minimum of the empty core area, which excludes a border of 0.5m of the perimeter of the area. Spacing tables or a suitable computer program provide simple and accurate data that can easily be used. The spacing tables for 0.5 lux are de-rated on the same basis as those for escape routes. They can also be used as a guide for initial selection of the location of luminaires when using a computer program.

- **Spacing Data**

Specific data is available for self-contained dedicated emergency luminaires. This can be found on each of the individual product entries in this catalogue.

If using standard mains luminaires fitted with an emergency conversion kit, you should use one of the available computer programs to calculate the layout of converted luminaires. Using the actual distribution of the luminaire ensures that the correct emergency lumen value is used with the relevant depreciation factors.

## Stage 6

### High Risk Task Area Lighting

The risk assessment carried out will have identified a number of locations needing special consideration. These may be areas in which plant and production lines are deemed to have a high risk or control rooms managing dangerous processes. In addition to these identified areas a selection of other typical areas are detailed in BS5266-1: 2011.

BS EN 1838: 2013 defines that in areas of high risk the maintained illuminance on the reference plane shall be not less than 10% of the required maintained illuminance for that task, however it shall not be less than 15 lux. Additional information is available in BS 5266 table D1.

### Design Procedures

In order to reach this enhanced level of emergency illumination it is important to consider all options, which may include converted luminaires, either operated from integral batteries or the use of luminaires supplied from a central emergency unit. These versions in most instances would have higher Ballast Lumen Factors (BLF). It is also important to consider the emergency response time which may require that the emergency luminaires are operated in maintained mode, or possibly require the use of tungsten projector units. If these are used it is important to maintain a reasonable level of uniformity.

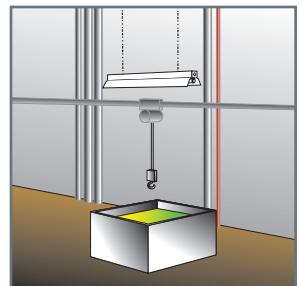

### Stage 7 Control

Non-maintained luminaires must be activated by failure of supply to the normal lighting. They must therefore be connected to an un-switched live taken from the local normal lighting final circuit.

It is important at this stage to ensure that the luminaires used in the design process are not changed without a full assessment of the lumen output and distribution of any alternative proposal. Failure to validate the performance could lead to a non-compliant installation.

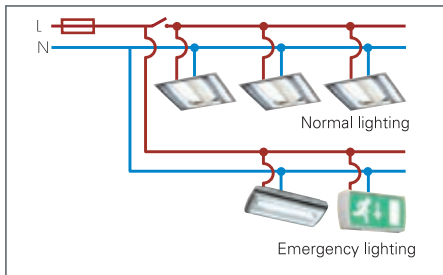

### Testing and Log Book

The Fire Safety Order requires that appropriate testing is performed to maintain compliance of the system. The system should include adequate facilities for testing and recording the system condition. These need to be appropriate for the specific site and should be considered as part of the system design. Discussions with the user or system designer should identify:

- The calibre and reliability of staff available to do the testing
- The level of difficulty in performing the test
- If discharge tests need to be done outside normal working hours, or phased so only alternate luminaires are tested in buildings that are permanently occupied

The testing requirements in the code of practice are:

#### • Function Test

All emergency luminaires should be tested by breaking the supply to them and checking that they operate satisfactorily. The supply must then be restored and the charging indicators must be seen to be operating correctly. This test must be performed at least once per month and the results logged.

#### • Discharge Test

The luminaires must be tested for their full rated duration period and checked for satisfactory operation. The supply must then be restored and the charging indicators rechecked. This test must be performed at least annually and the results logged.

If manual testing is utilised, the following points should be considered:

- Is a single switch to be used? Unless the whole building is to be switched off, a separate switch should be used for each final circuit. As the feed to non-maintained circuits must be taken from the switch, this will probably mean that the building will have to be walked around twice, once to check the luminaires and once to check that they are recharging.
- With manual testing it is difficult to correctly validate that the emergency luminaires illuminated within the specified time and at the correct level. Validation is also required that all emergency luminaires meet the minimum duration. Again, this would be difficult to validate for all locations.
- Are luminaires to be individually switched? In practice, only a single walk around the building will be needed. However, the test switches could spoil the décor of the

building and they must be of a type that is tamper proof.

- After the tests, the performance of the luminaires must be logged.

### **Commissioning Certificate**

BS 5266 Pt 1: 2011 and the European Standard both require written declarations of compliance to be available on site for inspection. These consist of:

#### **1. Installation quality**

IEE regulations must have been conformed with and non-maintained fittings fed from the final circuit of the normal lighting in each, as required in BS 5266 Pt 1: 2011.

#### **2. Photometric performance**

Evidence of compliance with light levels has to be supplied by the system designer. Photometric tests for Eaton's luminaires are normally performed at BSI and spacing data is registered by the ICEL scheme. Therefore copies of the spacing data in this catalogue provides the verification required.

#### **3. Declaration of a satisfactory test of operation**

A log of all system tests and results must be maintained. System log books, with commissioning forms, testing forms and instructions are available from Eaton.

### **Maintenance**

Finally, to ensure that the system remains at full operational status, essential servicing should be defined. This normally would be performed as part of the testing routine, but in the case of consumable items such as replacement lamps, spares should be provided for immediate use.

Eaton can provide a full maintenance service for your emergency lighting system by fully qualified BAFe registered engineers. For more information, call our service team on 01302 303349.

### Automatic Test Systems

Legislation demands that emergency lighting systems are regularly tested and maintained in full working order. To avoid the cost and disruption of manual testing, automatic test systems should be considered. Eaton offer alternative testing systems, each optimised for different building types:

- **CGLine+**

CGLine+ is an automatic testing and monitoring device for up to 800 self-contained luminaires, giving information regarding their functionality and status. There are many ways in which you can monitor the status and event information of the system. Each CGLine+ controller has an inbuilt web browser which can be accessed to view the status of the luminaires and system events, there are a number of LEDs used to signal system status and multiple controllers can be connected in a network allowing the monitoring of up to 25,600 emergency luminaires on one system. If site IT infrastructure allows, the system can be accessed remotely and can be configured to distribute email alerts from selectable alarm conditions. Alternatively a USB stick can be used to upload the event log and luminaires configuration and status. CGLine+, simply the most flexible single screen system, offers enhanced safety by providing reliable efficient monitoring of your emergency evacuation lighting.

- **Intellem**

Designed for use with self-contained emergency luminaires, Intellem is a stand alone self-test system for small to medium sized installations. The testing module self calibrates and carries out testing at predetermined intervals. Faults are precisely reported by an audible alarm and the flashing sequence of the LED indicator. For applications where an audible alarm would be inappropriate, this feature can be disabled during installation. Intellem has a function which enables tests of adjacent luminaires to be staggered to avoid complete loss of emergency cover during the recharge period after a full discharge test.



CGLine+ web controller





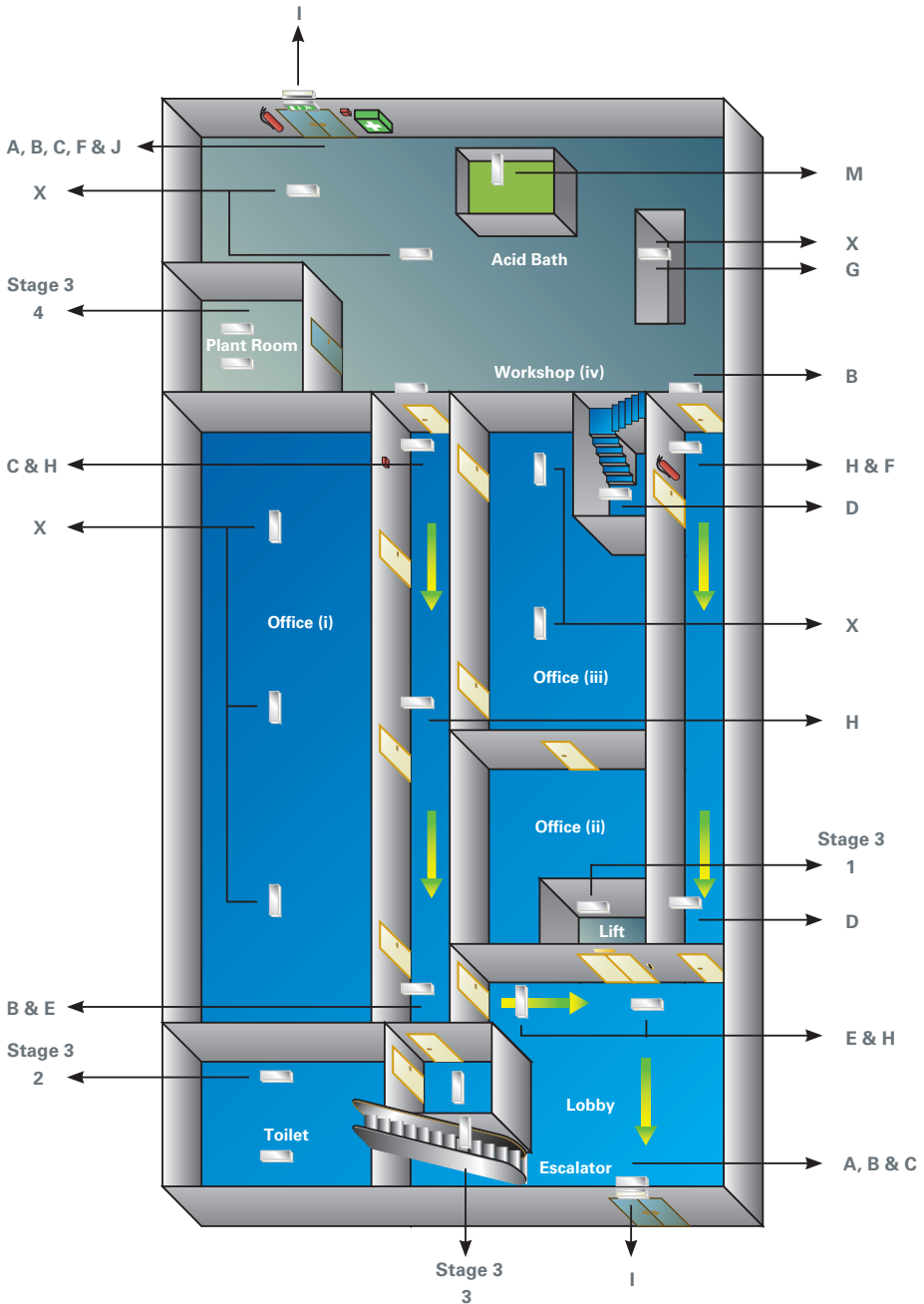

## Example of System Design

### Stage 1

Locate luminaires at points of emphasis on escape route.

- A At each exit door
- B To illuminate exit and safety signs
- C Near call points (some covered by a.)
- D Near each staircase
- E Change of direction (some covered by b.)
- F Near fire fighting equipment (some covered by a.)
- G Change of floor level
- H Near intersection of escape routes
- I Outside final exits
- J Near first aid points

Following this, ensure that the escape route also meets the 1 lux minimum.

### Stage 2

Exit sign location is covered by Stage 1, but it is important to check that maximum viewing distances are not exceeded and that if the normal lighting is dimmed, e.g. in cinemas, the exit signs must be permanently illuminated while the building is occupied (maintained lighting).

### Stage 3

Other areas, which require emergency lighting but are not on the escape route area.

- 1 Lift car
- 2 Toilet (above 8m<sup>2</sup> floor area)
- 3 Escalators
- 4 Plant room

### Stage 4

Check minimum illuminance levels on the escape routes. After selecting a suitable luminaire, consulting the spacing table shows the number of fittings needed to provide a minimum of 1 lux on the centre line of the escape routes.

### Stage 5

Anti-panic open areas (X) apply to any areas over 60m<sup>2</sup> floor area, or that have an escape route passing through them.

- (i) Office over 60m<sup>2</sup>
  - 3 x Micropoint 2
- (ii) Office under 60m<sup>2</sup>
  - no requirement
- (iii) Under 60m<sup>2</sup>, but part of escape route from office
  - 2 x Micropoint 2 fittings, either as compartment of escape route or an open anti-panic area
- (iv) Workshop 4m high
  - 3 x i-P65 + maintained Alfalux High-bay LED unit for high risk (m)

### Stage 6

High risk lighting requirement for an acid bath (M) is included in the design for stage 6.

### Wiring Installation

The wiring of emergency luminaires should generally be in accordance with normal wiring practice (I.E.E. Wiring Regulations), statutory requirements applicable to the type of building, local by-laws and regulations. The supply for self-contained luminaires should be taken from the unswitched local light source.

Cabling used when installing self-contained emergency luminaires should be of a similar type to that used for the normal mains light. In the event of a fire, if the cabling used for the emergency luminaires has greater protection, there may be a chance of the normal lighting failing and the emergency lighting remaining in the normal mode (i.e. inoperative). Hence it is recommended that self-contained emergency luminaires are wired in PVC insulated cable.

The supply to self-contained luminaires should be such as to prevent unauthorised disconnection, but should incorporate suitable means for simulating a mains failure for test purposes. The source of supply should be from the same local fuse as the normal lighting, so that in the event of a fuse failure causing the normal lighting to be extinguished, the emergency lighting is brought into operation in the same locality.

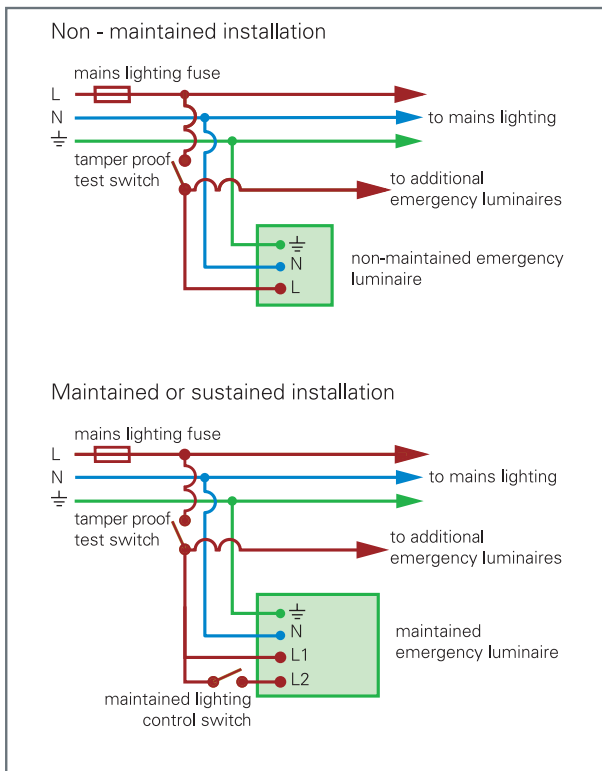

Wiring details

**1 and 2 New Ludgate**  
London



To enable photometric designs to be performed as required by BS 5266 pts 1 and BS EN 1838, the following factors need to be used to ensure that the worst case conditions are designed for.

Initial lamp lumens of the lamp must be de-rated by:

- Ballast lumen factor (for emergency circuits, these are independently tested and their % value is shown)
- K Factor for the effect of reduction in supply voltage as the battery discharges, and of cable voltage drop on central systems

- S Factor to compensate for the ageing of lamps during service life

The effect of dirt on the diffuser must also be allowed for, so an allowance for 20% as recommended by ICEL has been built into these spacing tables. If the design is being produced on a computer, similar allowance should be made.

System lumen reduction factors used in the following lumens chart are:

<b>System Type</b>	<b>Self-Contained</b>	<b>24 Volt Slave</b>	<b>50 &amp; 110 Volt Slave</b>	<b>230 Volt Inverter Slave</b>
K Factor	0.85	0.65	0.7	0.95
S Factor	0.85	0.85	0.85	0.85

When applied with the appropriate K Factors the following Emergency Lighting Design Lumens (ELDL) for typical fluorescent lamps which can be used for calculations:

Note that lamp lumen depreciation (S factor and factors for Luminaire Maintenance Factor LMF should be applied to the calculation)

Watt	Lumen	Type	QX Range		50 and 110 Volt Slave		230 Volt Inverter Slave
			BLF	ELDL	BLF	ELDL	ELDL
<b>Linear Lamps</b>							
14	1200	BQX14	0.14	142	0.43	516	1140
21	1900	HC1	0.10	161	0.43	817	1805
24	1750	HE1	0.08	119	0.30	525	1662
28	2600	HD2	0.08	178	0.41	1066	2470
35	3300	HE1	0.10	280	0.38	1254	3135
49	4300	HE1	0.07	255	0.28	1204	4085
54	4450	HE1	0.05	189	0.23	1023	4227
80	6550	-	0.04	222	0.18	1179	6222
18	1350	BQX	0.10	115	0.44	504	1282
36	3350	BQX	0.09	256	0.33	939	3182
58	5200	CQX	0.06	265	0.24	1060	4940
70	6550	DQX	0.05	278	0.18	1002	6222
<b>Compact Lamps</b>							
16-2D	1050	BQX	0.13	100	0.65	892	997
28-D	2050	-	-	-	0.4	1742	1947
38-2D	2850	-	-	-	0.33	2422	2070
13-TCD	900	BQX	0.14	107	0.63	567	855
18-TCD	1200	BQX	0.07	71	0.37	1020	1140
26-TCD	1800	HD1	0.06	91	0.42	756	1710
32-TCD	2200	HD1	0.06	112	0.45	990	2090
42-TCD	3200	HD1	0.06	163	0.41	1312	3040
40-TCL	3500	EH	0.05	149	0.25	875	3325
55-TCL	4800	EH	0.04	151	0.21	1008	4560

### Design procedure for Converted Mains Lighting Luminaires

When normal mains luminaires are converted and utilised for emergency use, the procedure below should be followed:

1. The table of emergency lighting design lumens (above), should be consulted to determine the minimum emergency lamp output for the particular lamp/circuit required, for use with either spacing tables or a computer design program.

### Use of Spacing Tables with Computer Programs

Computer programs can provide accurate values for specific applications, using data for the exact luminaire, at the precise mounting height and with the actual emergency lamp output, for any luminaire configuration a design can be carried out or validated against BS5266-1: 2011 and EN1838: 2013.

**Eaton**  
Electrical Sector EMEA  
Route de la Longeraie 7  
1110 Morges, Switzerland  
**Eaton.eu**

**Eaton**  
Eaton Electrical Systems Ltd  
Wheatley Hall Road  
Doncaster  
South Yorkshire  
DN2 4NB

**Tel:** +44 (0)1302 303303  
**Fax:** +44 (0)1302 367155  
**Web:** [www.Eaton.eu](http://www.Eaton.eu)  
**Email:** [SalesUK@Eaton.com](mailto:SalesUK@Eaton.com)

© 2016 Eaton  
All Rights Reserved  
Printed in UK  
Article No. CLS-CC3095  
February 2016

Eaton is a registered trademark  
of Eaton Corporation.

All other trademarks are property  
of their respective owners.



*Powering Business Worldwide*