

EE462L, Power Electronics, Triac Light Dimmer

Version Aug. 29, 2011

Wear safety glasses when soldering or viewing an energized power circuit from a close distance. Remove watches, bracelets, rings, and dangling neckchains when performing this experiment. Do not energize your circuit without the assistance of Dr. Grady or one of the TAs. Do not mount the steel corner brackets so that they touch each other. Do not attempt to use this circuit at home with 120Vac because a serious shock may result.

All oscilloscope screen snapshots in this document serve as checkpoints – do not pass a checkpoint until your circuit has approximately the same waveform shown. Snapshots designated by the following boxes:

Save screen
snapshot #N

should be saved for your report.

Overview

A light dimmer regulates power flow to a resistive load, such as an incandescent light bulb, in an efficient way by allowing only a portion of the 60Hz current to pass through. Thus, this method is known as “subcycle” control. Example current (and voltage) waveforms to a resistive load are shown in Figure 1 for firing angles $\alpha = 30^\circ$, 90° , and 150° . Firing angle is controlled by a potentiometer, RC circuit, and diac. The variation of load power with α is shown in Figure 2.

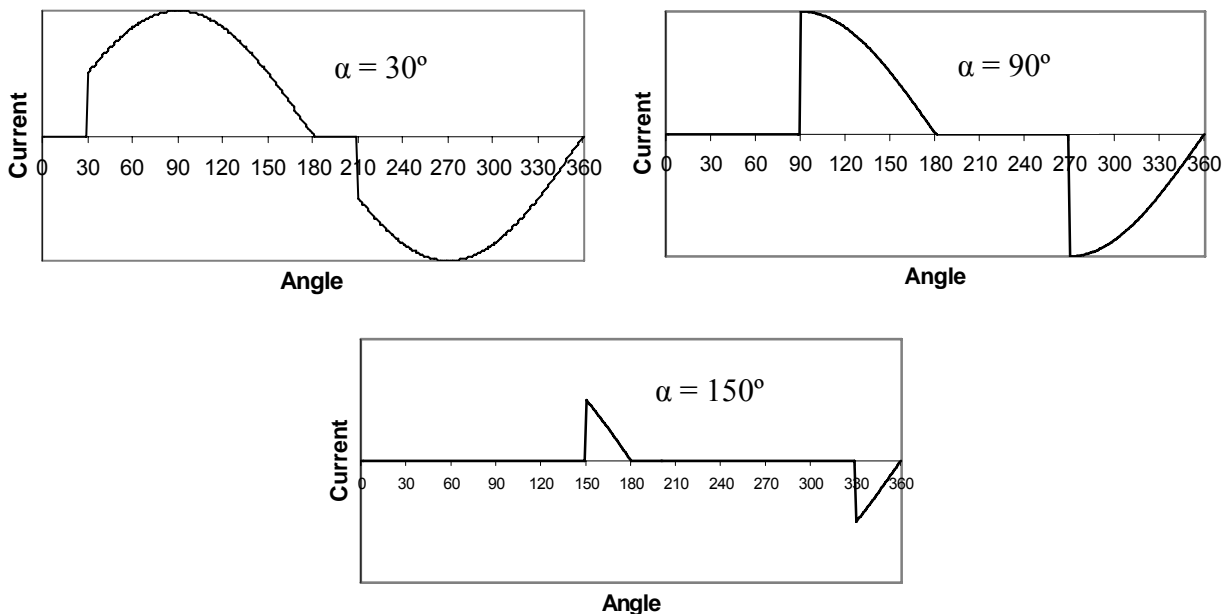

Figure 1. Resistive load current (and voltage) waveforms for firing angles $\alpha = 30^\circ$, 90° , and 150°

EE462L, Power Electronics, Triac Light Dimmer

Version Aug. 29, 2011

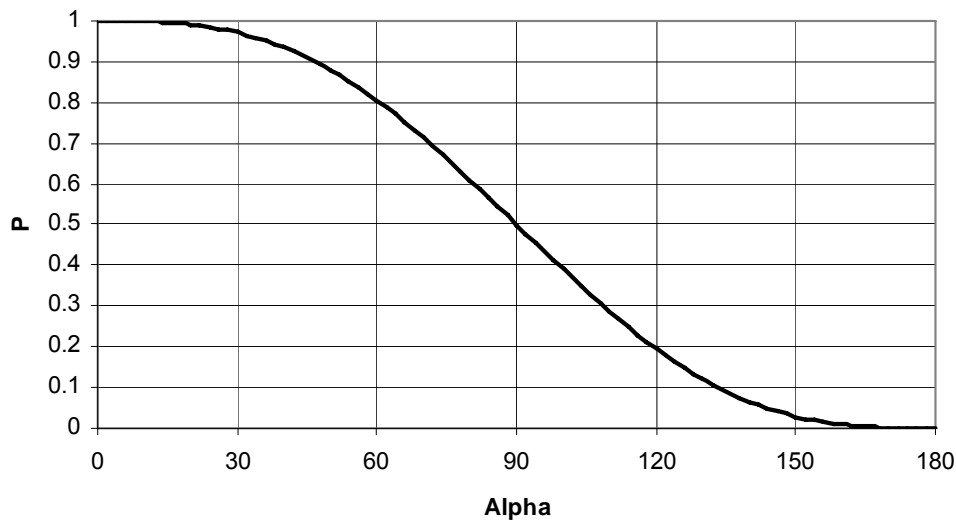

Figure 2. Normalized power delivered to resistive load versus firing angle (this is a normalized plot of Equation (1) in the *Lab Report* section)

Two important characteristics of the light dimmer current are that 1. it has zero average value (i.e., no DC, which minimizes corrosion of power grounds), and 2. it has half-wave symmetry (i.e., has no even-ordered harmonics).

The light dimmer circuit that you will build is designed for use at 120Vrms. However, you will perform your experiment with using an isolation transformer and variac set at 70Vrms.

Light dimmer circuit and operation

The light dimmer circuit is shown in Figure 3. During each half-cycle, when the voltage across the capacitor (either positive or negative) exceeds the breakover voltage of the diac and “fires” the triac, current then flows through the load. The RC time constant of the series $3.3\text{k}\Omega + 250\text{k}\Omega$ linear potentiometer and $0.1\mu\text{F}$ capacitor determines the phase delay and magnitude of the sinusoidal capacitor voltage with respect to the source voltage. Once firing occurs, the voltage across the triac collapses, the capacitor voltage goes to nearly zero, and the entire process resets at the beginning of the next half-cycle. For the circuit to work properly, a small current must flow through the load before firing occurs, but this current is miniscule with respect to full load current.

EE462L, Power Electronics, Triac Light Dimmer

Version Aug. 29, 2011

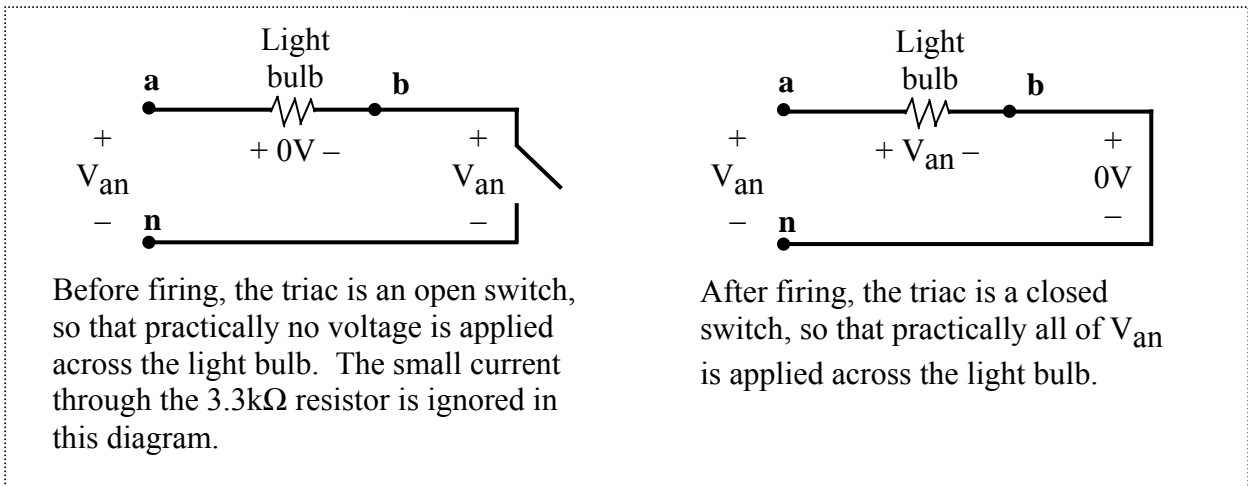
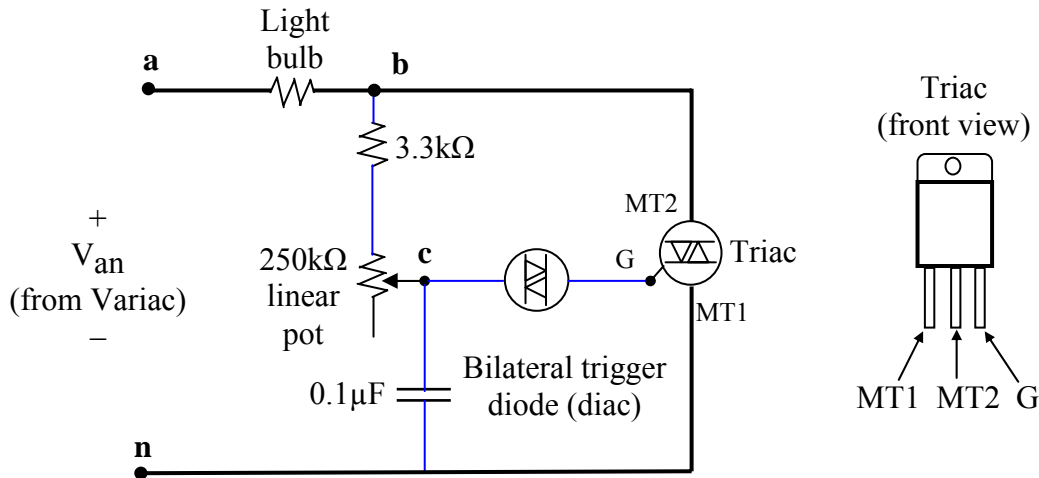

Note - when the potentiometer is adjusted to 0Ω , the time constant of the RC circuit (ignoring load resistance) is $3300 \cdot 0.1 \cdot 10^{-6} = 0.330\text{msec}$, which is small compared to one-half period of 60Hz (i.e., 8.33msec). When the potentiometer is at $250k\Omega$, the time constant is 25.3msec , which is relatively large.

Figure 3. Light dimmer circuit with triac

(Use blue #22 solid wire for control electronics when the leads of small electronic components are not long enough to make connections. Current-carrying wires should be #16 stranded.)

EE462L, Power Electronics, Triac Light Dimmer Version Aug. 29, 2011

Oscilloscope probes

Before using a probe, you should

1. calibrate it, and
2. check the integrity of its ground.

Calibration is performed by connecting the probe to the calibration terminals on the oscilloscope, and then selecting “Auto Scale.” Use a trimmer potentiometer adjustment tool to turn the screw on the probe’s plug until the wave is square.

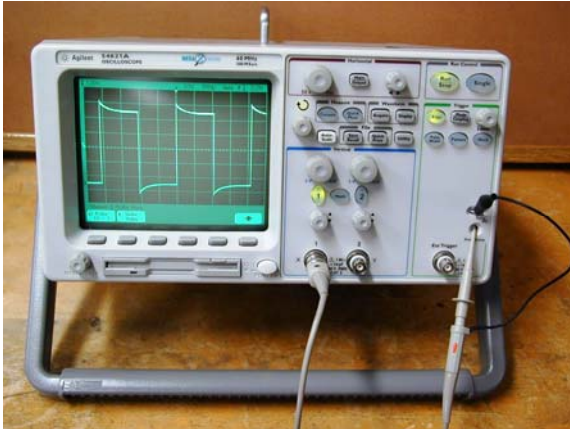

If the alligator ground clip is loose or broken, the oscilloscope trace that you see for a signal whose ground is not the same as the oscilloscope chassis will be either false or “shaky.” You can prevent this problem by either checking the resistance between the alligator clip and the outside of the BNC connector, or by viewing the waveform of an ungrounded source (such as from a 25V transformer). If a probe is defective, report it to the checkout counter.

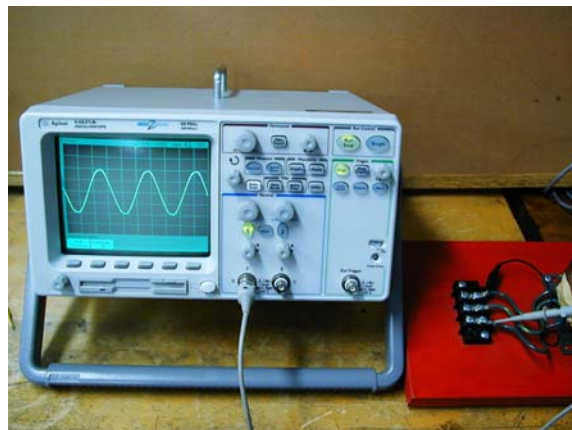

EE462L, Power Electronics, Triac Light Dimmer

Version Aug. 29, 2011

The experiment

Work at either a lab bench, or on top of one of the black cabinet tops. Never place the hot tip of a soldering iron on the surface of a lab bench or table. Instead, use the coiled wire holster. Do you soldering on a wood piece, or using a Panavise. Remember to use safety glasses.

Use #16 stranded wire for your power connections, and #22 solid wire for the control connections (i.e., potentiometer, diac, capacitor, and Triac gate wire).

Make two sets of jumper cables that you will use all semester. Cut two 3" pieces of #14 stranded copper wire from the large spools (one red piece, and one black piece), and two 6" pieces (again, one red, and one black). Crimp and solder spade connectors to both ends of each wire.

A. Using the parts provided, build the light dimmer circuit shown in Figure 3.

Note - to avoid screwing all the way through your wood piece, use #8 x $\frac{3}{4}$ " self-tapping screws for the terminal block, and #8 x $\frac{1}{2}$ " self-tapping screws for the steel corner brackets.

An example circuit is provided in the glass case outside Dr. Grady's office for your inspection. Use #16 black stranded wire for power connections, and #22 blue solid wire for connecting the control electronics. Minimize your use of #22 solid wire by using the leads of the devices as much as possible. **Do not use heat shrink** in your circuit (because it tends to hide the quality of your soldering!). Mount your triac so that the leads point downward. Mount your potentiometer so that turning the shaft clockwise increases light intensity. Mount the porcelain light bulb holder using a rubber washer between each #8 x 1" self-tapping screw head and the porcelain to prevent the porcelain from cracking. **After your circuit is built, write your names on the top surface of the wood.**

EE462L, Power Electronics, Triac Light Dimmer

Version Aug. 29, 2011

B. As shown in the photograph below, connect your light dimmer circuit with bulb to the isolation transformer and variac (but do not yet energize)

1. Make sure that your variac switch is “off” and that its output voltage control knob is **fully counterclockwise** (to the 0V position).
2. With the variac “off,” connect your light bulb and light dimmer circuit in series with the output of the variac as shown in Figure 3. **The variac black post is “hot,” and the white post is “neutral.” Do not use the green post (i.e., “ground”).**
3. **Plug the variac into an isolation transformer, and the isolation transformer into a wall outlet.** The isolation transformer removes the ground reference from the variac output, adding a degree of safety. **Important – do not leave the isolation transformer plugged into the wall outlet after you are finished because it will get hot!**

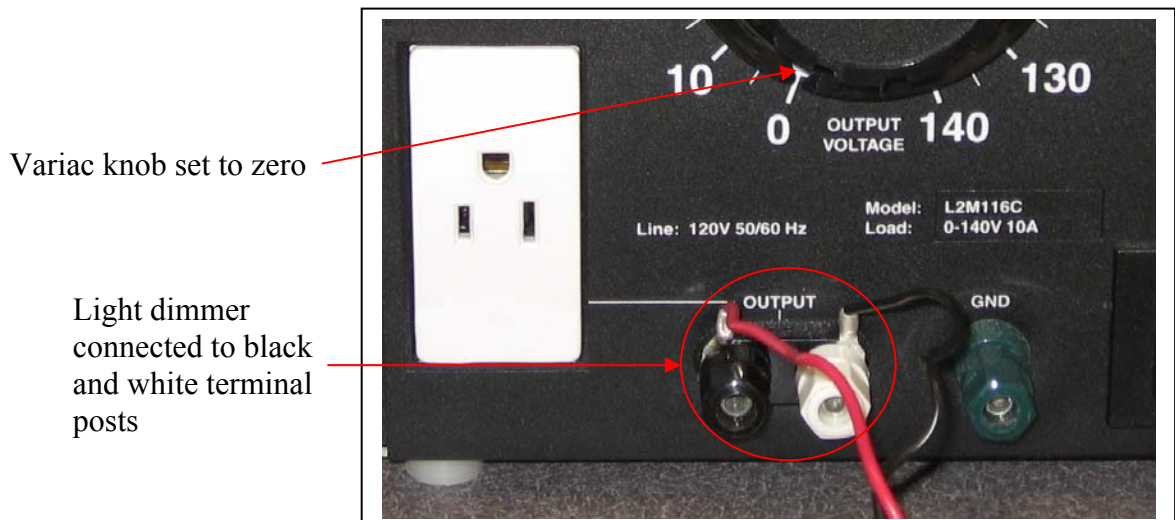
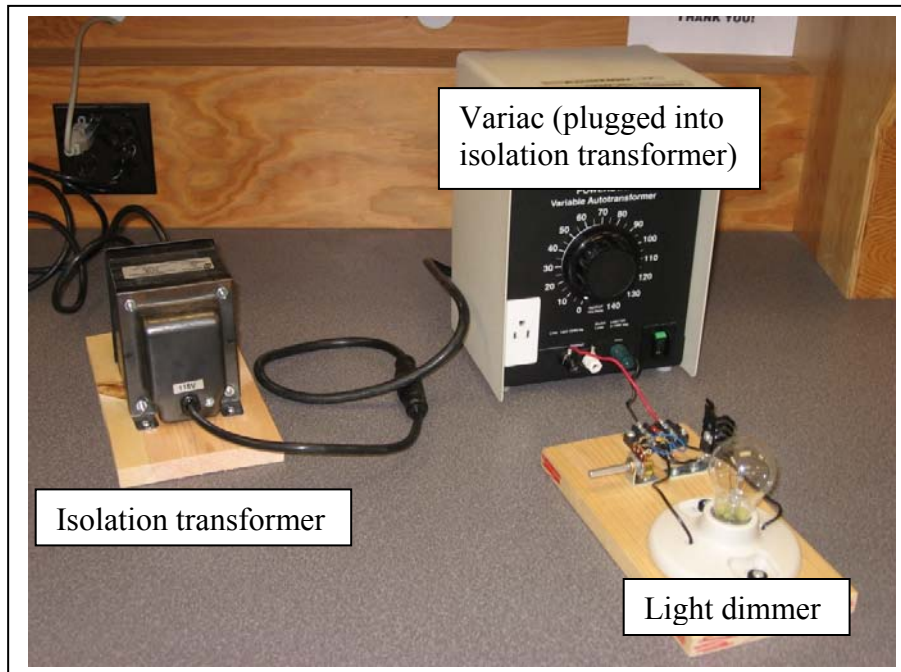

C. Test your circuit with $V_{an} = 70V_{rms}$ and a 120V, 60W incandescent light bulb load

1. Make sure that your variac switch is “off” and that its output voltage control knob is **fully counterclockwise** (to the 0V position).
2. With the variac “off,” connect your light bulb and light dimmer circuit in series with the output of the variac as shown in Figure 3. **The variac black post is “hot,” and the white post is “neutral.” Do not use the green post (i.e., “ground”).**
3. **Plug the variac into an isolation transformer, and the isolation transformer into a wall outlet.** The isolation transformer removes the ground reference from the variac output, adding a degree of safety. **Important – do not leave the isolation transformer plugged into the wall outlet after you are finished because it will get hot!**
4. Turn your light dimmer potentiometer to the full clockwise position.
5. Turn on the variac, and slowly raise the output voltage knob to 70Vrms. The bulb should light up. Use a handheld multimeter across the black and white posts and adjust for $V_{an} = 70 \pm 1 V_{rms}$.
6. Vary your light dimmer potentiometer across its full range and observe the light bulb to verify that your circuit is controlling light bulb brightness properly.
7. Turn the variac output voltage knob to zero, and then turn off the variac switch.
8. **Remember – you must always de-energize 120V circuits before making connections or attaching oscilloscope probes!**
9. Connect an oscilloscope probe to monitor light bulb voltage V_{ab} .
10. Re-energize your circuit with $V_{an} = 70V_{rms}$, and set the potentiometer for full brightness. Display one or two cycles of V_{ab} on the oscilloscope. Use the time cursors to measure firing angle α in milliseconds, and waveform period (or half-period) in milliseconds. Convert α to degrees. Measure $V_{ab,rms}$ with a multimeter **and** with the oscilloscope. (Note – not all multimeters compute true rms for nonsinusoidal waveforms - see Step 11.) When using an oscilloscope to measure rms, be sure to adjust the time resolution so that **at least six periods of the waveform** are visible on the screen. Record $V_{ab,rms}$ (multimeter and oscilloscope), and α .

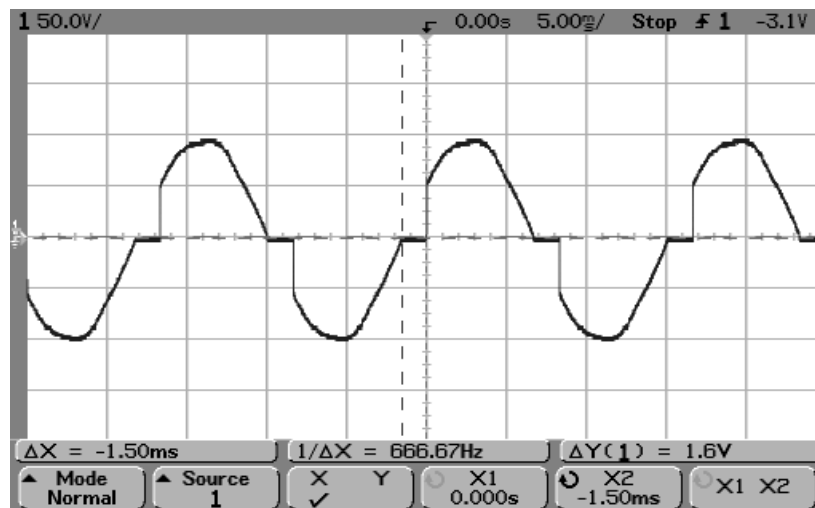

EE462L, Power Electronics, Triac Light Dimmer

Version Aug. 29, 2011

11. While viewing the oscilloscope screen, visually set $\alpha \approx 90^\circ$ (i.e., the firing point is midway between the zero crossings of V_{ab}). Measure $V_{ab,rms}$ using both multimeter and oscilloscope. Record both $V_{ab,rms}$ readings, and α . Since the circuit is energized with $V_{an} = 70V_{rms}$, the value of $V_{ab,rms}$ for $\alpha \approx 90^\circ$ should be approximately $\frac{70}{\sqrt{2}} = 49V$. By comparing your oscilloscope and multimeter readings, can you tell if your multimeter reads true rms, or if it simply averages the rectified wave and makes a sinewave assumption?

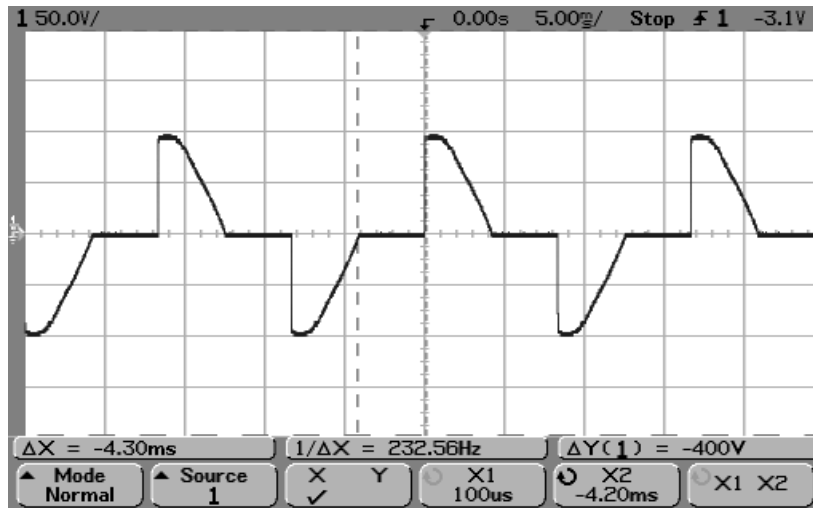

12. Set α to the maximum value that still has conduction. Use time cursors and determine α in degrees. Measure $V_{ab,rms}$, and record $V_{ab,rms}$ and α .

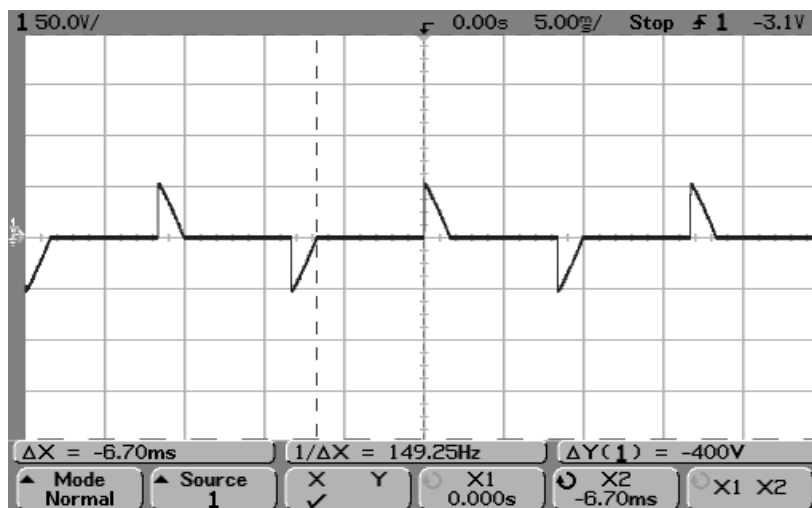

EE462L, Power Electronics, Triac Light Dimmer

Version Aug. 29, 2011

13. Turn the variac output voltage knob to zero, and then turn off the variac switch.
14. **Careful – when using two oscilloscope probes, remember the black alligator clips (i.e., “grounds”) on these probes are connected together at the scope’s BNC terminals.** Therefore, when using two probes, do not use the ground clip of the second probe. Instead, clip it onto itself so that it does not accidentally touch part of the dimmer circuit, establishing a short circuit through the BNC terminals. For example, connecting one probe across V_{ab} , and the other probe across V_{cn} will establish a short circuit from point b to point n.
15. Connect one oscilloscope probe to view variac output V_{an} , and a second probe to view capacitor voltage V_{cn} .
16. Re-energize your circuit with $V_{an} = 70V_{rms}$. Observe the variation of capacitor voltage V_{cn} (magnitude and phase with respect to variac output V_{an}) with α .

EE462L, Power Electronics, Triac Light Dimmer
Version Aug. 29, 2011

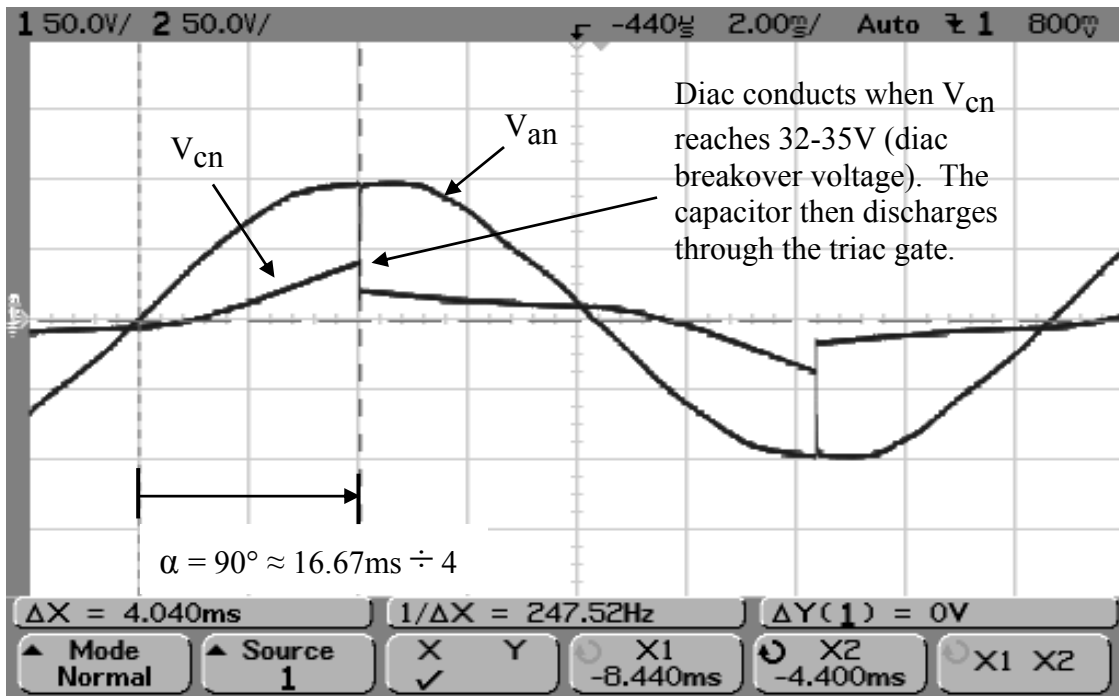

Save screen snapshot #2

In the above screen snapshot, the time period corresponding to α is $\Delta X = 4.040\text{ms}$

Source	Freq	Fixed R	Potentiometer	C	Diac breakover	Diac on volts
Vrms	Hz	kohm	kohm	uF	V	V
70	60	3.3	49	0.1	35	5

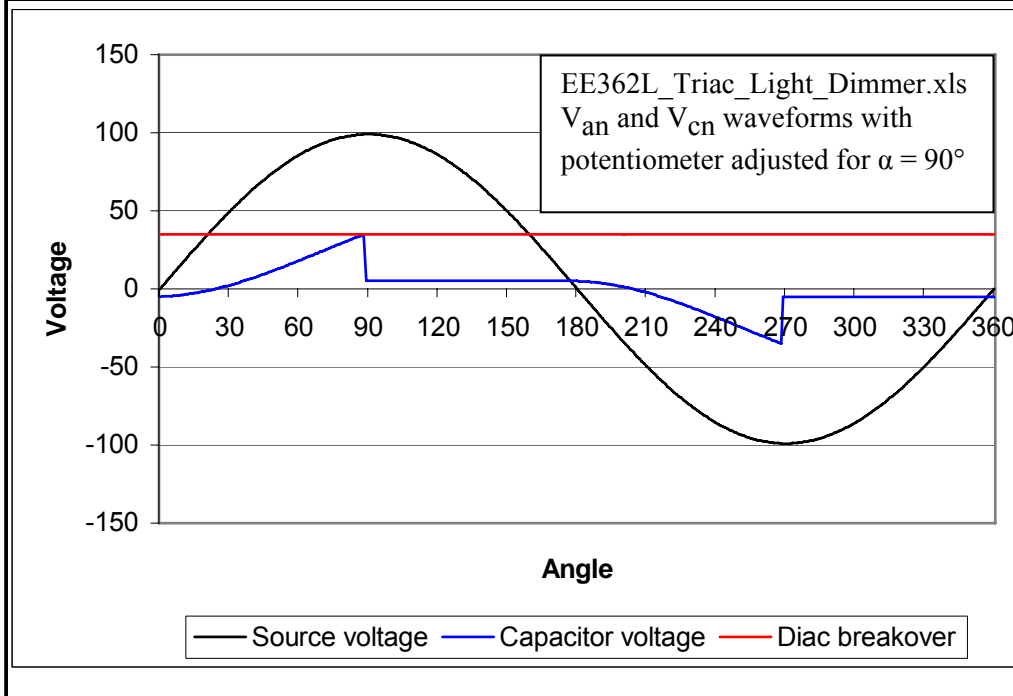

EE462L, Power Electronics, Triac Light Dimmer

Version Aug. 29, 2011

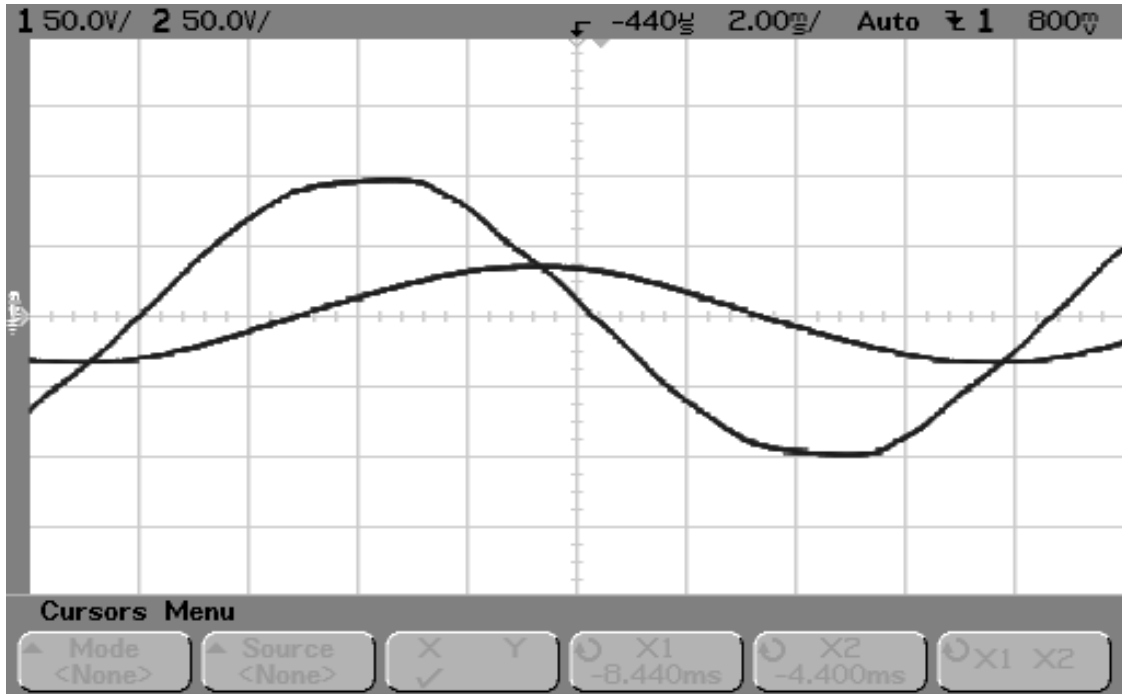

As potentiometer resistance increases, firing stops because V_{cn} never exceeds the diac breakover voltage. In that case, V_{cn} has a steady-state phasor solution. The above screen snapshot shows V_{an} and V_{cn} after transition into the no-firing regime.

Source	Freq	Fixed R	Potentiometer	C	Diac breakover	Diac on volts
Vrms	Hz	kohm	kohm	uF	V	V
70	60	3.3	96	0.1	35	5

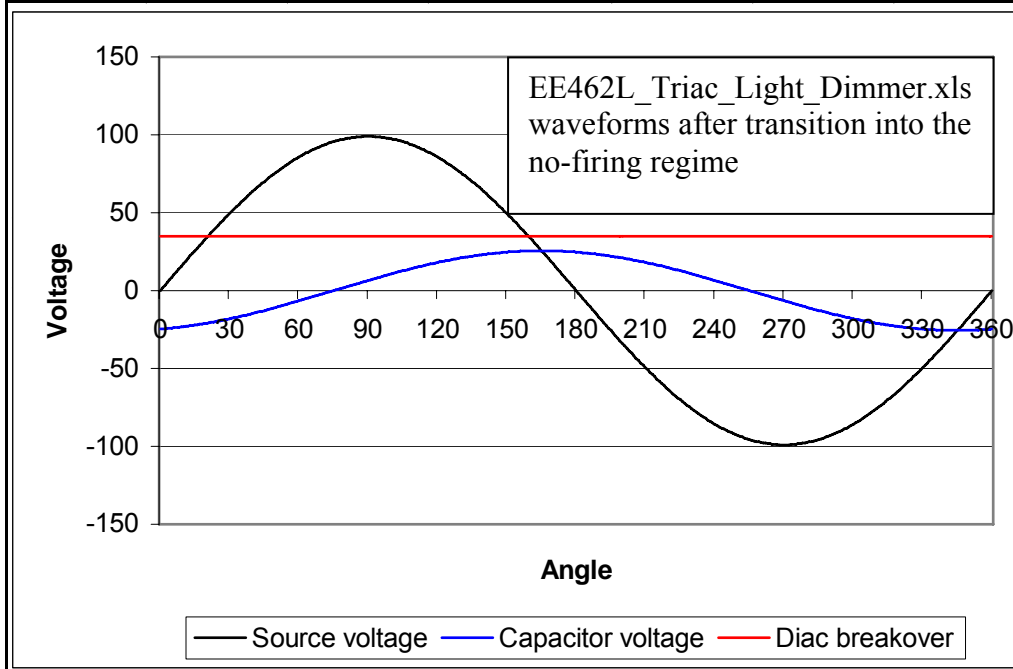

EE462L, Power Electronics, Triac Light Dimmer

Version Aug. 29, 2011

When there is no firing, the steady-state phasor solution for the capacitor voltage (ignoring the light bulb resistance) is

$$V_{cn} = V_{an} \left[\frac{\frac{1}{j\omega C}}{R + \frac{1}{j\omega C}} \right] = V_{an} \left[\frac{1}{1 + j\omega RC} \right],$$

where R is the series combination of the fixed and variable resistances. For small R , $V_{cn} \approx V_{an}$. As R increases, the $j\omega RC$ term begins to dominate, causing the magnitude of V_{cn} to decrease and lag V_{an} . As a result, values of α greater than 90° are possible.

D. Measure magnitudes of harmonic components of V_{ab}

1. Using only one scope probe, with $V_{an} = 70\text{V}_{\text{rms}}$, view V_{ab} on the scope and set $\alpha \approx 90^\circ$.

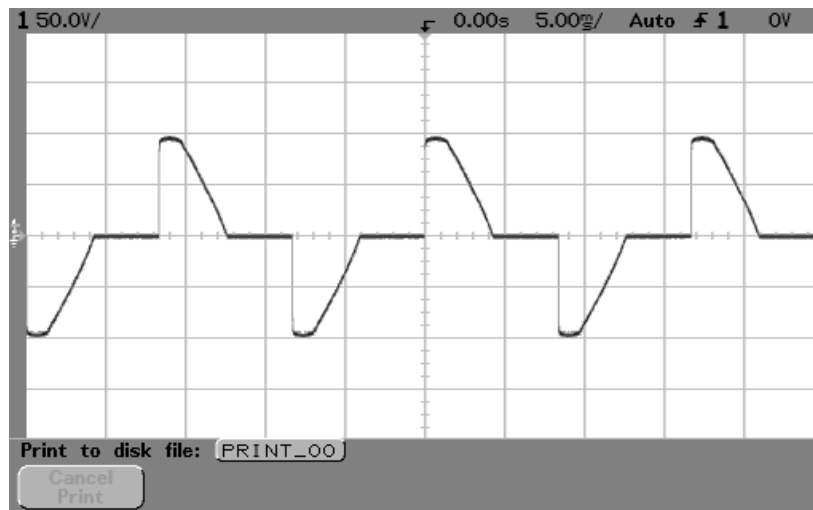

V_{ab} time trace, with $V_{an} \approx 70\text{V}_{\text{rms}}$, and $\alpha \approx 90^\circ$

2. Set the horizontal scale so that at least three cycles of the waveform as shown.
3. Press the “Math” button, then “FFT,” then “Settings.”
4. Adjust “Span” to 1kHz, and “Center” to 500Hz.

EE462L, Power Electronics, Triac Light Dimmer

Version Aug. 29, 2011

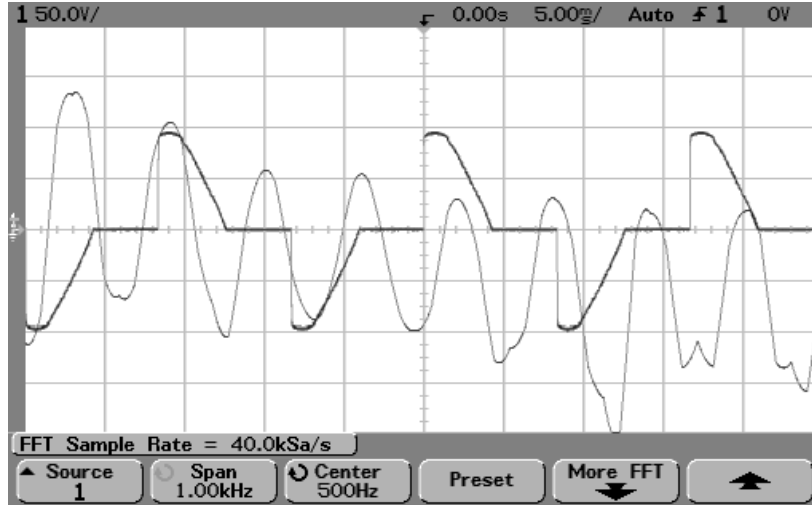

Spectral content of V_{ab} , superimposed on time trace (note – spacing between vertical lines corresponds to 100Hz)

5. Press “More FFT” to see the dB per division scale.
6. Press “Math” to return.
7. Press the “1” button to turn off the time trace.
8. Press the “Cursors” button.
9. Adjust Y1 to the top of the 60Hz component, and Y2 to the top of the 180Hz component.
10. Measure the dB values of the 60Hz and 180Hz components. These values are with respect to a 1Vrms reference.

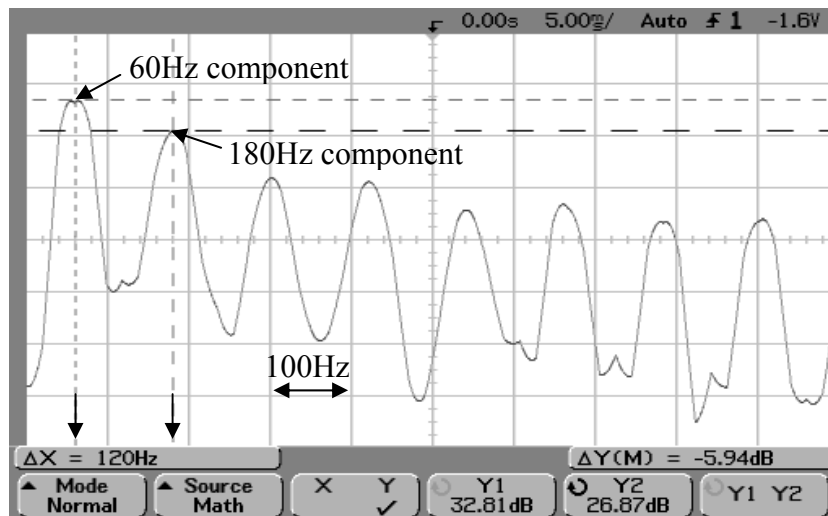

Save screen snapshot #3

Measuring the dB difference between 60Hz and 180Hz components of V_{ab}

EE462L, Power Electronics, Triac Light Dimmer

Version Aug. 29, 2011

11. Compute the ratio of V_{180}/V_{60} and compare the ratio to that predicted in Excel program EE462L_Triac_Light_Dimmer_Fourier_Waveform.xls.

Example calculations:

$$32.81\text{db} = 20 \log_{10} \left(\frac{V_{60\text{Hz}}}{1\text{Vrms}} \right), \text{ so } V_{60\text{Hz}} = 1\text{Vrms} \cdot 10^{\left(\frac{32.81}{20} \right)} = 43.7\text{Vrms}$$

$$26.87\text{db} = 20 \log_{10} \left(\frac{V_{180\text{Hz}}}{1\text{Vrms}} \right), \text{ so } V_{180\text{Hz}} = 1\text{Vrms} \cdot 10^{\left(\frac{26.87}{20} \right)} = 22.1\text{Vrms}$$

$$-5.94\text{db} = 20 \log_{10} \left(\frac{V_{180\text{Hz}}}{V_{60\text{Hz}}} \right), \text{ so } \frac{V_{180\text{Hz}}}{V_{60\text{Hz}}} = 10^{\left(\frac{-5.94}{20} \right)} = 0.505.$$

F. 120Vac operation

Careful! Slowly raise the variac output voltage to 120Vrms, observe V_{ab} on the oscilloscope as you vary the firing angle from minimum to maximum, and verify that the circuit is working properly. The smooth operation should make it obvious that the circuit components have been optimized to work best at full 120Vrms input voltage. You may also be interested in powering up to 1kW of lights.

Lab report

Document your experiment, addressing the steps in parts B through D as needed. Many students include a digital photo of their circuit in their report. “Paste in” the requested screen snapshots. Use Excel, **with scatter plot option**, to plot your three oscilloscope-measured $V_{ab,rms}$ data points from Steps B10, B11, and B12 versus α in degrees, along with calculations using the theoretical formula below.

$$V_{ab,rms}^2 = V_{an,rms}^2 \left[1 - \frac{\alpha}{\pi} + \frac{\sin 2\alpha}{2\pi} \right], \alpha \text{ in radians.} \quad (1)$$

Optional – using the definition of rms, can you derive the above theoretical formula?

Parts list

- Isolated case triac, 200V, 15A Littlefuse Q2015L5, (Mouser #576-Q2015L5)
- Heat sink for triac, approx. 1.5” x 1.75” for TO-220 case style, 9.6°C/W (Aavid Thermalloy, Mouser #532-507222B00)
- 32V trigger diode (diacs), STMicroelectronics DB3 or DB3TG, on-state voltage = 5V, (Mouser #511-DB3 or #511-DB3TG)
- 0.1 μ F, 100V axial lead ceramic capacitor (Kemet, Mouser #80-C430C104K1R) (in student parts bin)
- 250k Ω , ½W potentiometer with linear taper (Alpha/Xicon, Mouser #31VC503-F)
- 3.3k Ω , ¼W resistor (in student parts bin)

EE462L, Power Electronics, Triac Light Dimmer

Version Aug. 29, 2011

- One 3-terminal, 20A terminal block (Molex, Mouser #538-38780-0103). One of the center screws is removed and the hole marked with paint to indicate “don’t use.”
- 1” steel corner bracket for mounting the potentiometer (Stanley 30-3010, Home Depot, or Grainger 4PB60). Hole in 1” bracket enlarged with 5/16” drill bit to fit the potentiometer.
- 1½” steel corner bracket for mounting the triac (Stanley 30-3170, Home Depot, or Grainger 4PB61).
- 1” x 6” wood (approx. 10” long piece)
- Porcelain 120V light bulb holder
- 60W clear-glass bulb
- Two 9/16” or ½” outer diameter flat rubber water-faucet washers for the porcelain light bulb holder. A rubber washer goes between the screw head of the 1” screw and the porcelain to prevent the porcelain from cracking.

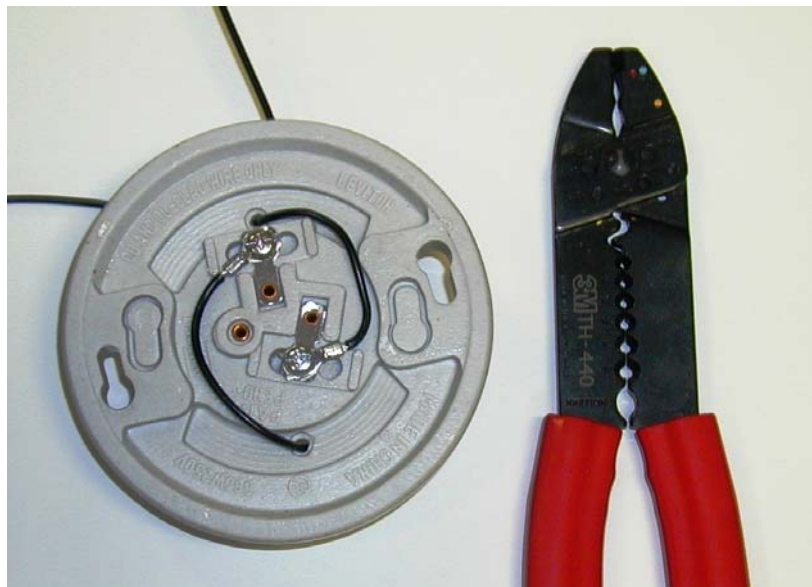

EE462L, Power Electronics, Triac Light Dimmer
Version Aug. 29, 2011

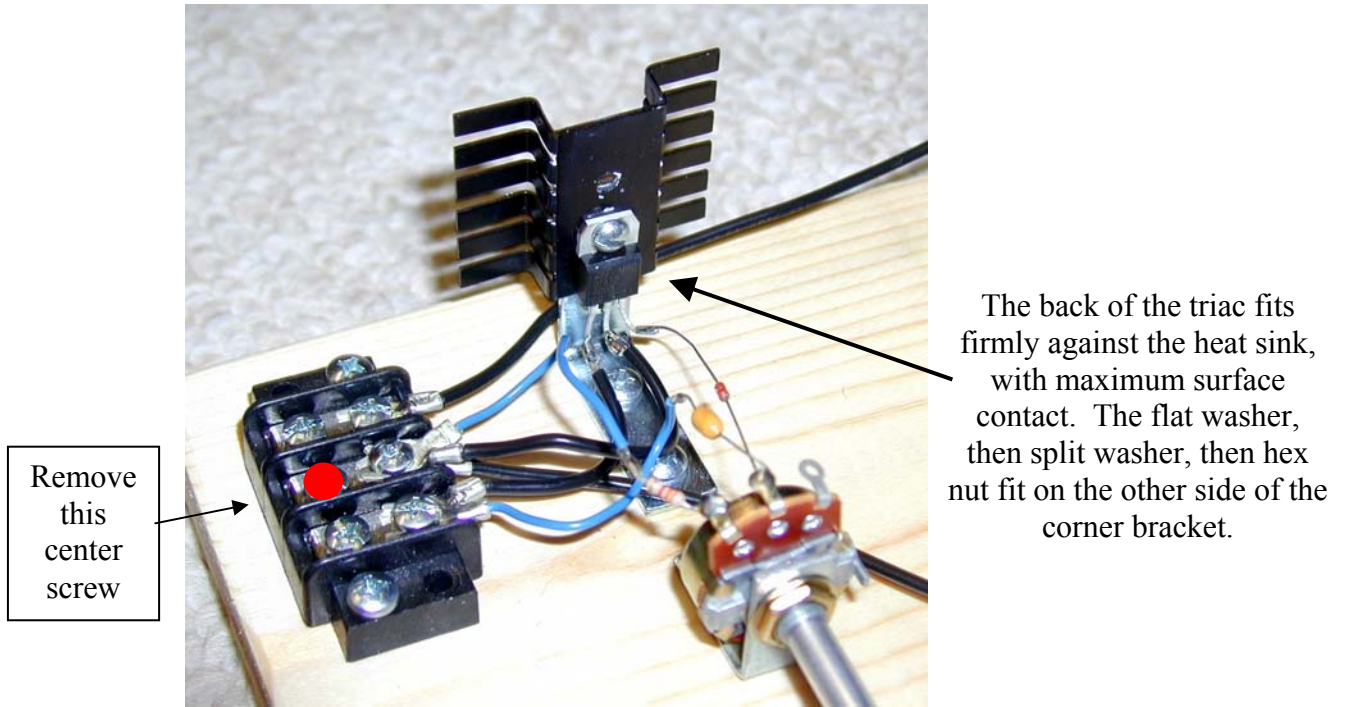
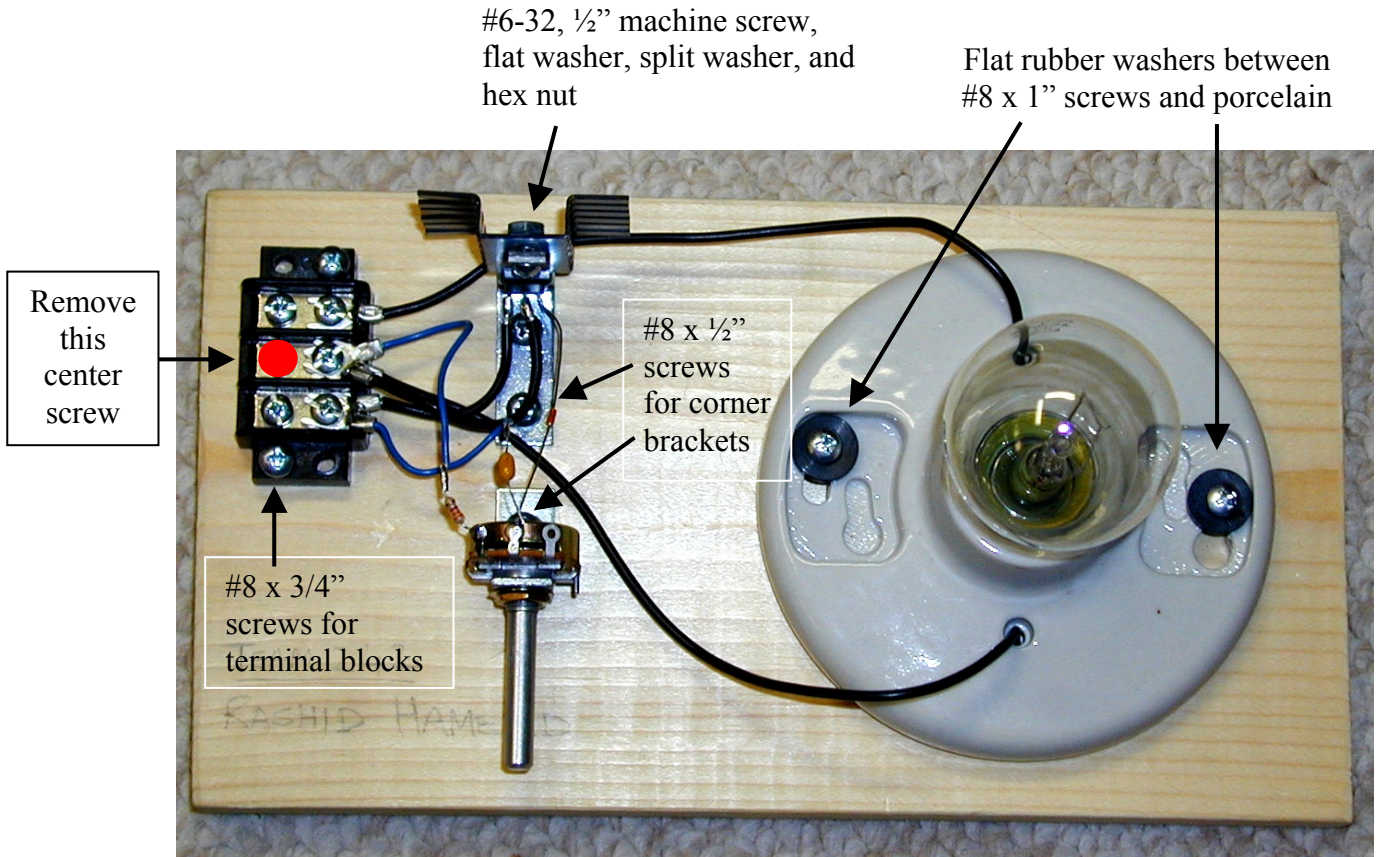

Appendix**RMS**

The rms value of a periodic current (or voltage) waveform is defined as

$$I_{rms} = \sqrt{I_{rms}^2}, \text{ where } I_{rms}^2 = \frac{1}{T} \int_t^{t+T} i^2(t) dt.$$

Evaluating the integral for the special case of a sine wave of current shows that the rms value is the peak current divided by $\sqrt{2}$.

Fourier Series

Any physically realizable periodic waveform can be decomposed into a Fourier series of average (i.e., DC), fundamental frequency, and harmonic terms. In sine form, the Fourier series in polar form is

$$i(t) = I_{avg} + \sum_{k=1}^{\infty} I_k \sin(k\omega_o t + \theta_k) = I_{avg} + \sum_{k=1}^{\infty} I_k \cos(k\omega_o t + \theta_k - 90^\circ),$$

where I_{avg} is the average value, I_k are peak magnitudes of the individual harmonics, ω_o is the fundamental frequency (in radians per second), and θ_k are the harmonic phase angles. The time period of the waveform is

$$T = \frac{2\pi}{\omega_o} = \frac{2\pi}{2\pi f_o} = \frac{1}{f_o}.$$

The formulas for computing I_{avg} , I_k , θ_k are well known and can be found in any undergraduate electrical engineering textbook on circuit analysis. These are described in a following section.

Figure A.1 shows a desktop computer (i.e., PC) current waveform. The figure illustrates how the actual waveform can be approximated by summing only the fundamental, 3rd, and 5th harmonic components. If higher-order terms are included (i.e., 7th, 9th, 11th, and so on), then the original PC current waveform will be perfectly reconstructed. A truncated Fourier series is actually a least-squared error curve fit. As higher frequency terms are added, the error is reduced.

Fortunately, a special property known as half-wave symmetry exists for most power electronic loads. Half-wave symmetry exists when the positive and negative halves of a waveform are identical but opposite, i.e.,

$$i(t) = -i\left(t \pm \frac{T}{2}\right),$$

EE462L, Power Electronics, Triac Light Dimmer
Version Aug. 29, 2011

where T is the period. Waveforms with half-wave symmetry have no even-ordered harmonics. It is obvious that the PC current waveform is half-wave symmetric. Televisions and other home entertainment equipment have the same waveform.

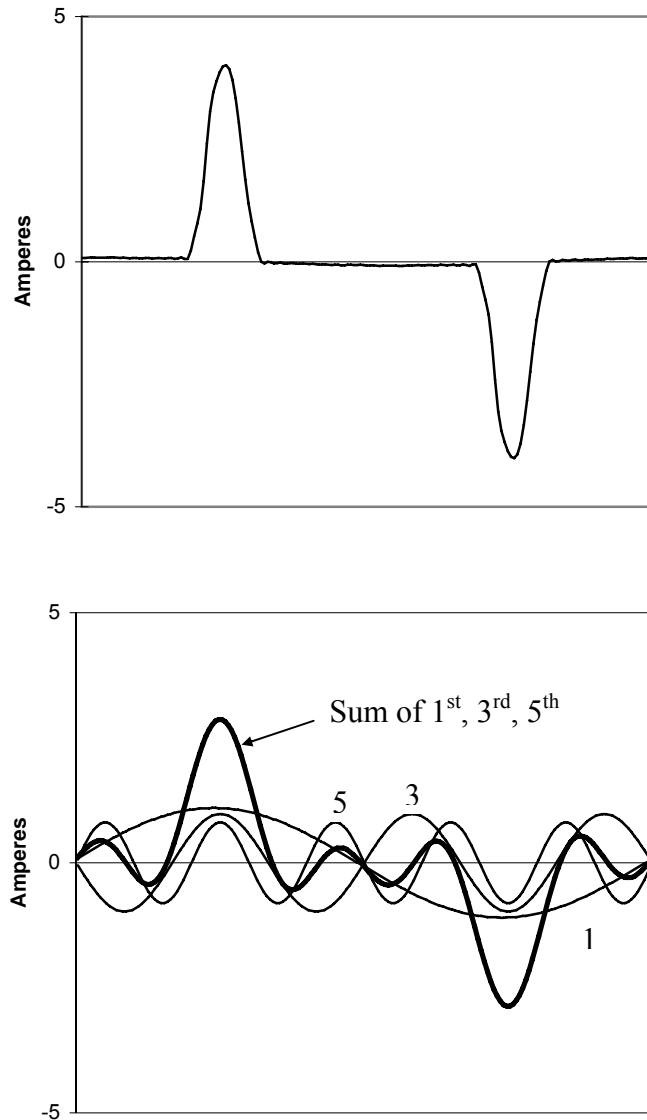

Figure A.1. PC Current Waveform, and its 1st, 3rd, and 5th Harmonic Components

Fourier Coefficients

If function $i(t)$ is periodic with an identifiable period T (i.e., $i(t) = i(t \pm NT)$), then $i(t)$ can be written in rectangular form as

$$i(t) = I_{avg} + \sum_{k=1}^{\infty} [a_k \cos(k\omega_o t) + b_k \sin(k\omega_o t)], \quad \omega_o = \frac{2\pi}{T},$$

where

$$I_{avg} = \frac{1}{T} \int_{t_o}^{t_o+T} i(t) dt,$$

$$a_k = \frac{2}{T} \int_0^T i(t) \cos(k\omega_o t) dt,$$

$$b_k = \frac{2}{T} \int_0^T i(t) \sin(k\omega_o t) dt.$$

The sine and cosine terms above can be converted to the convenient polar form by using trigonometry as follows:

$$\begin{aligned} & a_k \cos(k\omega_o t) + b_k \sin(k\omega_o t) \\ &= \sqrt{a_k^2 + b_k^2} \cdot \frac{a_k \cos(k\omega_o t) + b_k \sin(k\omega_o t)}{\sqrt{a_k^2 + b_k^2}} \\ &= \sqrt{a_k^2 + b_k^2} \cdot \left[\frac{a_k}{\sqrt{a_k^2 + b_k^2}} \cos(k\omega_o t) + \frac{b_k}{\sqrt{a_k^2 + b_k^2}} \sin(k\omega_o t) \right] \\ &= \sqrt{a_k^2 + b_k^2} \cdot [\sin(\theta_k) \cos(k\omega_o t) + \cos(\theta_k) \sin(k\omega_o t)], \end{aligned}$$

where

$$\sin(\theta_k) = \frac{a_k}{\sqrt{a_k^2 + b_k^2}}, \quad \cos(\theta_k) = \frac{b_k}{\sqrt{a_k^2 + b_k^2}}.$$

Applying trigonometric identity

$$\sin(A + B) = \sin(A) \cos(B) + \cos(A) \sin(B),$$

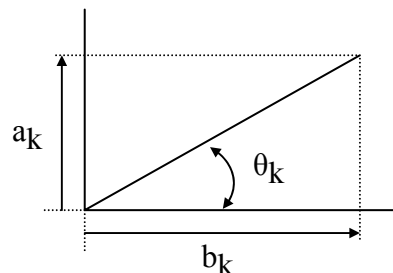

yields polar form

$$\sqrt{a_k^2 + b_k^2} \bullet \sin(k\omega_o t + \theta_k),$$

where

$$\tan(\theta_k) = \frac{\sin(\theta_k)}{\cos(\theta_k)} = \frac{a_k}{b_k}.$$

Phase Shift

If the PC waveform in Figure A.2 is delayed by ΔT seconds, the modified current is

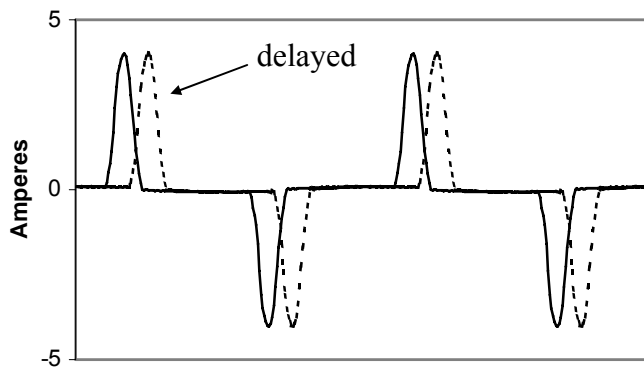

Figure A.2. PC Current Waveform Delayed in Time

$$\begin{aligned} i(t - \Delta T) &= \sum_{k=1}^{\infty} I_k \sin(k\omega_o(t - \Delta T) + \theta_k) = \sum_{k=1}^{\infty} I_k \sin(k\omega_o t - k\omega_o \Delta T + \theta_k) \\ &= \sum_{k=1}^{\infty} I_k \sin(k\omega_o t + (\theta_k - k\omega_o \Delta T)) = \sum_{k=1}^{\infty} I_k \sin(k\omega_o t + \theta_k - k\theta_o), \end{aligned}$$

where θ_o is the phase lag of the fundamental current corresponding to ΔT . The last term above shows that individual harmonics are delayed by $k\theta_o$ of their own degrees.

Symmetry Simplifications

Waveform symmetry greatly simplifies the effort in developing Fourier coefficients. Symmetry arguments should be applied to the waveform **after the average value has been removed**. The most important cases are

Odd Symmetry, i.e., $i(t) = -i(-t)$,

then the corresponding Fourier series has **no cosine terms**,

$$a_k = 0,$$

and b_k can be found by integrating over the **first half-period** and **doubling** the results,

$$b_k = \frac{4}{T} \int_0^{T/2} i(t) \sin(k\omega_o t) dt.$$

Even Symmetry, i.e., $i(t) = i(-t)$,

then the corresponding Fourier series has **no sine terms**,

$$b_k = 0,$$

and a_k can be found by integrating over the **first half-period** and **doubling** the results,

$$a_k = \frac{4}{T} \int_0^{T/2} i(t) \cos(k\omega_o t) dt.$$

Important note – even and odd symmetry can sometimes be obtained by time-shifting the waveform. In this case, solve for the Fourier coefficients using the time-shifted waveform, and then phase-shift the Fourier coefficient angles according to (A.6).

Half-Wave Symmetry, i.e., $i(t \pm \frac{T}{2}) = -i(t)$,

then the corresponding Fourier series has **no even harmonics**, and a_k and b_k can be found by integrating over **any half-period** and **doubling** the results,

$$a_k = \frac{4}{T} \int_{t_o}^{t_o + T/2} i(t) \cos(k\omega_o t) dt, \quad k \text{ odd},$$

$$b_k = \frac{4}{T} \int_{t_o}^{t_o + T/2} i(t) \sin(k\omega_o t) dt, \quad k \text{ odd}.$$

Half-wave symmetry is common in power systems.

Examples

Square Wave

By inspection, the average value is zero, and the waveform has both odd symmetry and half-wave symmetry. Thus, $a_k = 0$, and

$$b_k = \frac{4}{T} \int_{t_0}^{t_0+T/2} v(t) \sin(k\omega_0 t) dt, \quad k \text{ odd.}$$

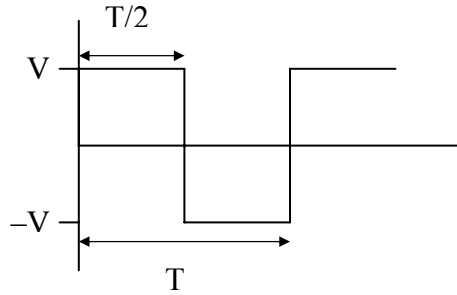

Solving for b_k ,

$$b_k = \frac{4}{T} \int_0^{T/2} V \sin(k\omega_0 t) dt = \frac{-4V}{k\omega_0 T} \cos(k\omega_0 t) \Big|_{t=0}^{t=T/2} = \frac{-4V}{k\omega_0 T} \left(\cos\left(\frac{k\omega_0 T}{2}\right) - \cos(0) \right)$$

Since $\omega_0 = \frac{2\pi}{T}$, then

$$b_k = \frac{-4V}{2k\pi} (\cos(k\pi) - 1) = \frac{2V}{k\pi} (1 - \cos(k\pi)), \text{ yielding}$$

$$b_k = \frac{4V}{k\pi}, \quad k \text{ odd.}$$

The Fourier series is then

$$v(t) = \frac{4V}{\pi} \sum_{k=1, k \text{ odd}}^{\infty} \frac{1}{k} \sin(k\omega_0 t) = \frac{4V}{\pi} \left[\sin(1\omega_0 t) + \frac{1}{3} \sin(3\omega_0 t) + \frac{1}{5} \sin(5\omega_0 t) + \dots \right].$$

Note that the **harmonic magnitudes decrease according to** $\frac{1}{k}$.

Triangle Wave

By inspection, the average value is zero, and the waveform has both even symmetry and half-wave symmetry. Thus, $b_k = 0$, and

$$a_k = \frac{4}{T} \int_{t_0}^{t_0+T/2} v(t) \cos(k\omega_0 t) dt, \quad k \text{ odd.}$$

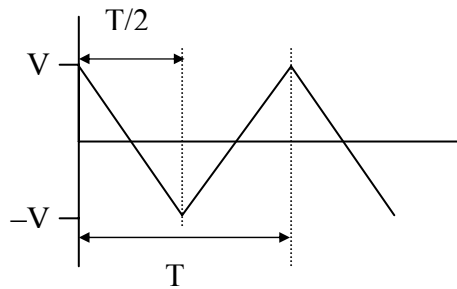

Solving for a_k ,

EE462L, Power Electronics, Triac Light Dimmer

Version Aug. 29, 2011

$$\begin{aligned}
 a_k &= \frac{4}{T} \int_0^{T/2} V \left(1 - \frac{4t}{T}\right) \cos(k\omega_o t) dt = \frac{4V}{T} \int_0^{T/2} \cos(k\omega_o t) dt - \frac{16V}{T^2} \int_0^{T/2} t \cos(k\omega_o t) dt \\
 &= \frac{4V}{k\omega_o T} \left(\sin\left(\frac{k\omega_o T}{2}\right) - \sin(0) \right) - \frac{16V}{T^2} \left. \frac{t \sin(k\omega_o t)}{k\omega_o} \right|_{t=0}^{t=T/2} + \frac{16V}{T^2} \int_0^{T/2} \frac{\sin(k\omega_o t)}{k\omega_o} dt \\
 &= \frac{2V}{k\pi} \sin(k\pi) - \frac{4V}{k\pi} \sin(k\pi) + \frac{4V}{k^2 \pi^2} (1 - \cos(k\pi)), \quad k \text{ odd.}
 \end{aligned}$$

Continuing,

$$a_k = \frac{8V}{k^2 \pi^2}, \quad k \text{ odd}$$

The Fourier series is then

$$\begin{aligned}
 v(t) &= \frac{8V}{\pi^2} \sum_{k=1, k \text{ odd}}^{\infty} \frac{1}{k^2} \cos(k\omega_o t) \\
 &= \frac{8V}{\pi^2} \left[\cos(1\omega_o t) + \frac{1}{9} \cos(3\omega_o t) + \frac{1}{25} \cos(5\omega_o t) + \dots \right],
 \end{aligned}$$

where it is seen that the **harmonic magnitudes decrease according to** $\frac{1}{k^2}$.

To convert to a sine series, recall that $\cos(\theta) = \sin(\theta + 90^\circ)$, so that the series becomes

$$v(t) = \frac{8V}{\pi^2} \left[\sin(1\omega_o t + 90^\circ) + \frac{1}{9} \sin(3\omega_o t + 90^\circ) + \frac{1}{25} \sin(5\omega_o t + 90^\circ) + \dots \right].$$

To time delay (i.e., move to the right) the waveform by $\frac{T}{4}$ (i.e., 90° of fundamental),

subtract $(k \cdot 90^\circ)$ from each harmonic angle. Then, the above series becomes

$$\begin{aligned}
 v(t) &= \frac{8V}{\pi^2} \left[\sin(1\omega_o t + 90^\circ - 1 \cdot 90^\circ) + \frac{1}{9} \sin(3\omega_o t + 90^\circ - 3 \cdot 90^\circ) \right] \\
 &\quad + \frac{1}{25} \sin(5\omega_o t + 90^\circ - 5 \cdot 90^\circ) + \dots,
 \end{aligned}$$

or

$$v(t) = \frac{8V}{\pi^2} \left[\sin(1\omega_o t) - \frac{1}{9} \sin(3\omega_o t) + \frac{1}{25} \sin(5\omega_o t) - \frac{1}{49} \sin(7\omega_o t) \dots \right].$$

Half-Wave Rectified Cosine Wave

The waveform has an average value and even symmetry. Thus, $b_k = 0$, and

$$a_k = \frac{4}{T} \int_0^{T/2} i(t) \cos(k\omega_o t) dt, \quad k \text{ odd.}$$

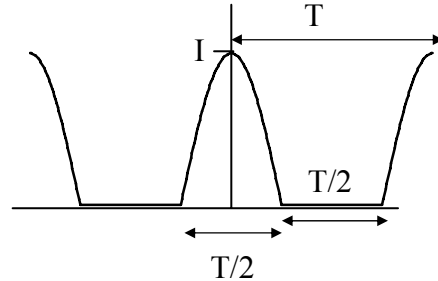

Solving for the average value,

$$\begin{aligned} I_{avg} &= \frac{1}{T} \int_{t_o}^{t_o+T} i(t) dt = \frac{1}{T} \int_{-T/4}^{T/4} I \cos(\omega_o t) dt = \frac{I}{\omega_o T} \sin(\omega_o t) \Big|_{t=-T/4}^{t=T/4} \\ &= \frac{I}{2\pi} \left(\sin \frac{\omega_o T}{4} - \sin \frac{-\omega_o T}{4} \right) = \frac{I}{\pi} \sin \frac{\omega_o T}{4} = \frac{1}{\pi} \sin \frac{\pi}{2}. \end{aligned}$$

$$I_{avg} = \frac{I}{\pi}.$$

Solving for a_k ,

$$\begin{aligned} a_k &= \frac{4}{T} \int_0^{T/4} I \cos(\omega_o t) \cos(k\omega_o t) dt = \frac{2I}{T} \int_0^{T/4} (\cos(1-k)\omega_o t + \cos(1+k)\omega_o t) dt \\ &= \frac{2I}{T} \left(\frac{\sin(1-k)\omega_o t}{(1-k)\omega_o} + \frac{\sin(1+k)\omega_o t}{(1+k)\omega_o} \right) \Big|_{t=0}^{t=T/4}. \end{aligned}$$

For $k = 1$, taking the limits of the above expression when needed yields

$$\begin{aligned} a_1 &= \frac{2I}{T} \cdot \lim_{(1-k)\omega_o \rightarrow 0} \left(\frac{\sin(1-k)\omega_o \frac{T}{4}}{(1-k)\omega_o} \right) + \frac{I}{\pi} \frac{\sin(1+1)\frac{\pi}{2}}{(1+1)\omega_o} \\ &\quad - \frac{2I}{T} \cdot \lim_{(1-k)\omega_o \rightarrow 0} \frac{\sin(1-k)\omega_o \cdot 0}{(1-k)\omega_o} - \frac{I}{\pi} \frac{\sin(0)}{(1+1)\omega_o} \end{aligned}$$

$$a_1 = \frac{2I}{T} \frac{T}{4} + \frac{I}{2\omega_o\pi} \sin(\pi) - 0 - 0 = \frac{I}{2}.$$

For $k > 1$,

$$a_k = \frac{I}{\pi} \left(\frac{\sin(1-k)\frac{\pi}{2}}{(1-k)} + \frac{\sin(1+k)\frac{\pi}{2}}{(1+k)} \right).$$

All odd k terms above are zero. For the even terms, it is helpful to find a common denominator and express the above equation as

$$a_k = \frac{I}{\pi} \left(\frac{(1+k)\sin(1-k)\frac{\pi}{2} + (1-k)\sin(1+k)\frac{\pi}{2}}{1-k^2} \right), \quad k > 1, \quad k \text{ even.}$$

Evaluating the above equation shows an alternating sign pattern that can be expressed as

$$a_k = \frac{2I}{\pi} \sum_{k=2,4,6,\dots}^{\infty} (-1)^{\frac{k+2}{2}} \frac{1}{k^2 - 1}, \quad k > 1, \quad k \text{ even.}$$

The final expression becomes

$$\begin{aligned} i(t) &= \frac{I}{\pi} + \frac{I}{2} \cos(\omega_o t) + \frac{2I}{\pi} \sum_{k=2,4,6,\dots}^{\infty} (-1)^{k/2+1} \frac{1}{k^2 - 1} \cos(k\omega_o t) \\ &= \frac{I}{\pi} + \frac{I}{2} \cos(\omega_o t) + \frac{2I}{\pi} \left[\frac{1}{3} \cos(2\omega_o t) - \frac{1}{15} \cos(4\omega_o t) + \frac{1}{35} \cos(6\omega_o t) - \dots \right]. \end{aligned}$$

Light Dimmer Current

The Fourier coefficients of the waveform in Figure 1 can be shown to be the following:

For the fundamental,

$$a_1 = \frac{-V_p}{\pi} \sin^2 \alpha, \quad b_1 = V_p \left[1 - \frac{\alpha}{\pi} + \frac{1}{2\pi} \sin 2\alpha \right],$$

where V_p is the peak value of the underlying AC waveform, and α is in radians.

EE462L, Power Electronics, Triac Light Dimmer

Version Aug. 29, 2011

For harmonic multiples above the fundamental (i.e., $k = 3, 5, 7, \dots$),

$$a_k = \frac{V_p}{\pi} \left[\frac{1}{1-k} (\cos(1-k)\alpha - \cos(1-k)\pi) + \frac{1}{1+k} (\cos(1+k)\alpha - \cos(1+k)\pi) \right],$$

$$b_k = \frac{V_p}{\pi} \left[\frac{1}{1-k} (\sin(1-k)\pi - \sin(1-k)\alpha) + \frac{1}{1+k} (\sin(1+k)\alpha - \sin(1+k)\pi) \right].$$

The waveform has zero average, and it has no even harmonics because of half-wave symmetry.

The magnitude of any harmonic k , including $k = 1$, is $V_k = \sqrt{a_k^2 + b_k^2}$. Performing the calculations with $\alpha = \frac{\pi}{2}$ radians (i.e., 90°) yields

$$V_1 = \frac{V_p}{\pi} \sqrt{1 + \frac{\pi^2}{4}} = 0.593 V_p, \text{ and } V_3 = \frac{V_p}{\pi} = 0.318 V_p,$$

so that

$$\frac{V_3}{V_1} = \frac{1}{\sqrt{1 + \frac{\pi^2}{4}}} = 0.537.$$

The above case is illustrated in the following Excel spreadsheet.

EE462L, Power Electronics, Triac Light Dimmer

Version Aug. 29, 2011

Excel Program EE462L_Triac_Light_Dimmer_Fourier_Waveform.xls

Triac_Light_Dimmer_Fourier_Waveform.xls. Light Dimmer Voltage Waveform (normalized to peak value of underlying sine wave)

Enter
Alpha = 1.570796

k	Fourier ak	Fourier bk	Ratio Magk/Mag1
1	-0.31831	0.5	0.592724
3	0.31831	-3.9E-17	0.31831
5	-0.106103	3.9E-17	0.106103
7	0.106103	-3.9E-17	0.106103
9	-0.063662	3.9E-17	0.063662
11	0.063662	-3.9E-17	0.063662
13	-0.045473	3.9E-17	0.045473
15	0.045473	-3.9E-17	0.045473
17	-0.035368	3.9E-17	0.035368
19	0.035368	-3.9E-17	0.035368
21	-0.028937	1.93E-16	0.028937
23	0.028937	-1.93E-16	0.028937
25	-0.024485	9.15E-17	0.024485
27	0.024485	9.15E-17	0.024485
29	-0.021221	1.52E-16	0.021221
31	0.021221	-1.52E-16	0.021221
33	-0.018724	6.08E-17	0.018724
35	0.018724	6.08E-17	0.018724
37	-0.016753	1.28E-16	0.016753
39	0.016753	-1.28E-16	0.016753
41	-0.015158	4.18E-17	0.015158
43	0.015158	9.32E-17	0.015158
45	-0.01384	6.13E-17	0.01384
47	0.01384	-1.13E-16	0.01384
49	-0.012732	2.89E-17	0.012732

Note – the magnitude of the fundamental is computed to be 0.593 times the magnitude of the underlying sine wave (see Magk column). If the underlying sine wave is 70Vrms, this corresponds to 41.5Vrms, which is close to the Section D calculation. The ratio of the 3rd harmonic voltage magnitude to the fundamental is computed to be 0.537, which also compares favorably with Section D. Differences are most likely the fact that the wall outlet voltage is not an ideal sine wave, and also to errors in measuring α .

Triac Light Dimmer Modified to Serve as a Voltage Clamp

This circuit helps prevent voltage runaway on the output of a DC-DC boost or buck/boost converter. When the voltage across the diac reaches its 35V trigger level, the triac and 150W light bulb turn on, thus loading down the converter significantly, which helps to limit the converter's output voltage.

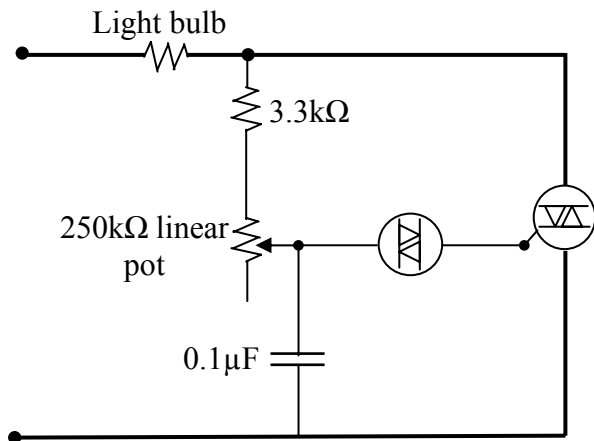

Original Triac Light Dimmer Circuit

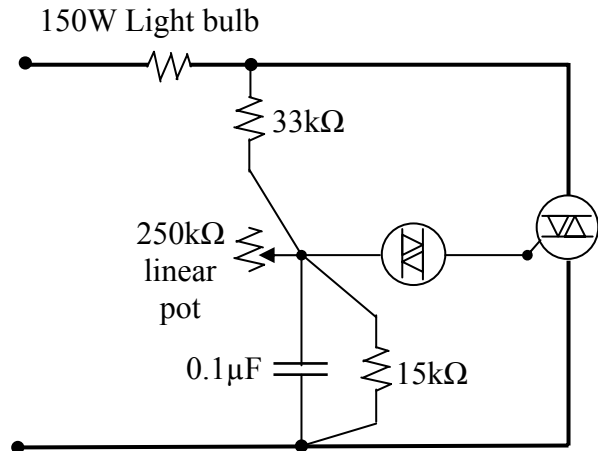

Modified Circuit that Turns On at Approximately 120V

Steps:

- Remove the 3.3kΩ resistor, and replace it with a 33kΩ, ½W resistor (in student parts bin). Solder the 33kΩ resistor to the diac/capacitor terminal of the 250kΩ potentiometer
- Solder a 15kΩ resistor (in student parts bin) across the 0.1μF capacitor
- Replace the 60W light bulb with a 150W light bulb

Note: After completing the above steps, the potentiometer of the original triac light dimmer is effectively disabled, but it is still useful as a soldering terminal.