

# DOLOMITE® Legacy™

en **Rollator**  
User Manual

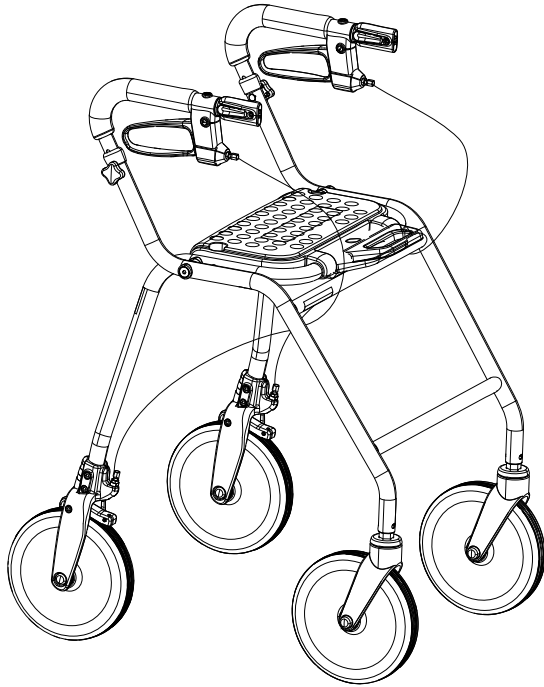

This manual **MUST** be given to the user of the product.  
**BEFORE** using this product, read this manual and save for future reference.



**Yes, you can.®**

© 2015 Invacare® Corporation

All rights reserved. Republication, duplication or modification in whole or in part is prohibited without prior written permission from Invacare. Trademarks are identified by ™ and ®. All trademarks are owned by or licensed to Invacare Corporation or its subsidiaries unless otherwise noted.

---

# Contents

---

<b>I General</b> .....	<b>4</b>
1.1 About this manual .....	4
1.2 Intended use .....	4
1.3 Service Life .....	5
1.4 Scope of delivery .....	5
1.5 Warranty .....	5
<b>2 Safety</b> .....	<b>6</b>
2.1 General Warnings .....	6
2.2 Labels and symbols on the product .....	6
<b>3 Usage</b> .....	<b>8</b>
3.1 Before use .....	8
3.2 Folding and unfolding the walking aid .....	8
3.3 Adjusting the handle height .....	9
3.4 Using the brakes .....	10
3.5 Adjusting the brakes .....	10
3.6 Flip up seat plate .....	11
3.7 Walking .....	11
3.8 Sitting down on a chair .....	12
3.9 Rising to a standing position .....	12
3.10 Sitting on the walking aid .....	13
3.11 Accessories .....	13
3.11.1 Padded backrest strap .....	13
3.11.2 Padded seat .....	13
3.11.3 Basket .....	14
3.11.4 Tray .....	15
<b>4 Maintenance and care</b> .....	<b>16</b>
4.1 Maintenance .....	16
4.2 Care .....	16

<b>5 After Use</b> .....	<b>17</b>
5.1 Disposal .....	17
5.2 Re-use .....	17
<b>6 Technical data</b> .....	<b>18</b>
6.1 Dimensions and weight .....	18
6.2 Material .....	19

# I General

## I.1 About this manual

This User Manual contains important information about your product. In order to ensure safety when using the product, read the User Manual carefully and follow the safety instructions.

The person who prescribes the product or who is otherwise responsible for the user must ensure that the product is suitable for the user. The user shall be instructed how to use the product. This includes the use of the features and the restrictions in use. The user shall also be notified of the warnings for use given in the user manual.

### Symbols in this manual

In this User Manual warnings are indicated by symbols. The warning symbols are accompanied by a heading that indicates the severity of the danger.



#### WARNING

Indicates a hazardous situation that could result in serious injury or death if it is not avoided.



#### CAUTION

Indicates a hazardous situation that could result in minor or slight injury if it is not avoided.



#### IMPORTANT

Indicates a hazardous situation that could result in damage to property if it is not avoided.



#### Tips and Recommendations

Gives useful tips, recommendations and information for efficient, trouble-free use.



This product complies with Directive 93/42/EEC concerning medical devices. The launch date of this product is stated in the CE declaration of conformity.

## I.2 Intended use



### WARNING!

#### Incorrect use could lead to hazardous situations

– Invacare accepts no responsibility for use, change or assembly of the product, other than stated in this user manual.



### IMPORTANT!

– For max user weight see table in section Technical data.

## Indications

- The walking aid is intended for support and improvement of a restricted walking ability.
- The user's remaining walking ability needs to be sufficient for leaving the home, for usual daily activities and for participating in social life without endangering themselves or others.
- The walking aid is intended to support a person during walking and may also serve as a resting seat.
- The walking aid can carry a load either in a specially designed basket or on a tray.
- The walking aid is suitable for use both indoors and outdoors.

## Contraindications

The walking aid is not intended for use by persons with severe equilibrium disorders or functional perceptual disorders.

## Permissible operating conditions and locations

The walking aid is not to be used under water in e.g. pools or open-air bath, neither in hot areas as e.g. saunas.

## 1.3 Service Life

The expected service life of this product is five years when used in accordance with safety instructions, maintenance intervals and correct use, stated in this manual. The effective product life cycle can vary according to frequency and intensity of use.

## 1.4 Scope of delivery

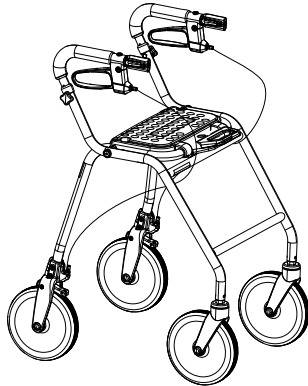

- Walking aid, fully assembled.
- User manual

Accessories assembled to your walking aid, are depending on the configuration and might differ per region.

## 1.5 Warranty

We supply a two year warranty from the date of delivery. Deviations may occur due to local agreements. Damage caused by normal wear to e.g. wheels, handles and brakes or damage caused by abnormal use (e.g. exceeded max. user weight) is not covered by the warranty. Maintenance and operating instructions must be followed for the warranty to be valid.

## 2 Safety

### 2.1 General Warnings



#### **WARNING!**

##### **Risk of falling**

- Exercise caution when walking on sloping / slippery ground and on uneven surfaces.
- Do not use the rollator as a wheelchair.
- Be careful when walking rearwards over obstacles.
- Never sit and push with your feet.
- Do not go up or down stairs with the rollator.
- Do not use the rollator on escalators.
- Do not under any circumstances stand on the rollator.
- Be careful when using long skirts, the clothes might get stuck in the wheels.
- Loads must only be transported in the basket or on the tray. Be careful when there is a heavy load in the basket (for the max. load in the basket refer to chapter 6 Technical data, page 18).



#### **WARNING!**

##### **Risk of injury**

- Do not let children play with the rollator.
- If the push handles or the seat are exposed to extreme temperature (above 41°C) there might be risk for first degree burns.



#### **IMPORTANT!**

##### **Risk of corrosion**

- The rollator must not be stored outside in wet climate or in humid environments for a long period of time.

### 2.2 Labels and symbols on the product

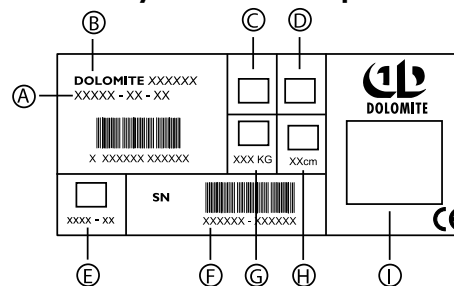



The label contains all important technical information regarding your product.

- |                              |                    |
|------------------------------|--------------------|
| Ⓐ Article number             | Ⓕ Serial number    |
| Ⓑ Product name               | Ⓖ Max. user weight |
| Ⓒ Reference to user's manual | Ⓗ Max. width       |
| Ⓓ Only for indoor use        | Ⓖ Manufacturer     |
| Ⓔ Date of production         |                    |

#### **Other symbols on the product**



All symbols might not be present on all products.

	Refer to the user manual.
	This product complies with Directive 93/42/EEC concerning medical devices. The launch date of this product is stated in the CE declaration of conformity.

## 3 Usage

### 3.1 Before use

We do not recommend that the product is issued to anyone without first carrying out a full assessment of their specific needs. It is important that the user is given the necessary support by the product as prescribed by a qualified professional. This is both for the safety of the user and also their recovery pattern.

### 3.2 Folding and unfolding the walking aid



#### **WARNING!**

**Risk of injury**

– Never lift the rollator in the folding handle.

#### Unfolding to operating position

1.

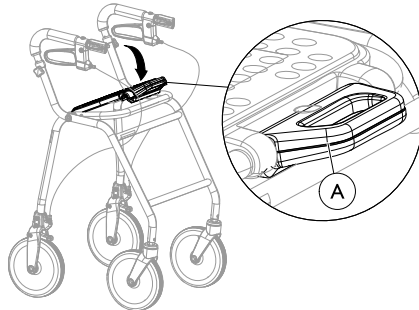

Hold one push handle, and, with the other hand; push the folding handle (A) down, until the walking aid is fully unfolded with all four wheels steady on the ground.

2.

8

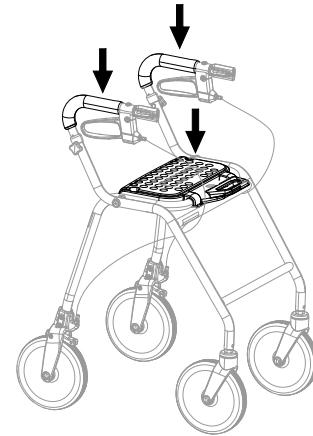

Press the seat or handles firmly downwards until a clicking sound is heard.



#### **IMPORTANT!**

The walking aid must be fully unfolded and seat locked with the locking handle (A) before using the product.

– The seat locks when a clicking sounds is heard.



## Folding

1.

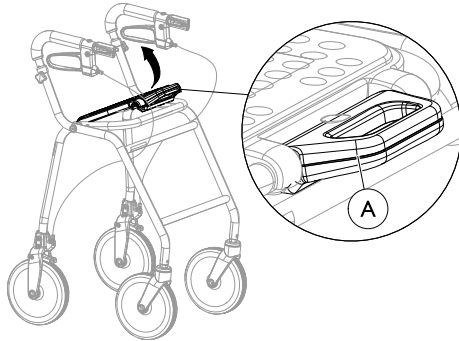

Hold one push handle, and, with the other hand; pull the folding handle (A) up.

2.

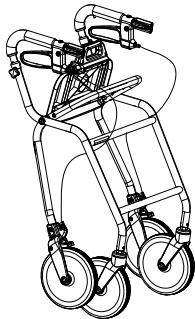

Lift the locking handle until it comes to a stop.

## 3.3 Adjusting the handle height



Adjust one side at a time.

1.

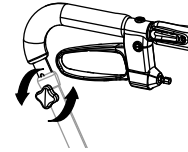

- a. Turn the finger knob anti-clockwise and remove it.
- b. Remove the screw.

2. Stand behind the walking aid with flat shoulders.

3.

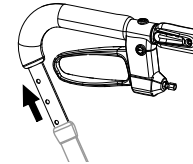

Adjust the handle to suitable height.



If a specific height has been recommended by a therapist, this should be followed. Otherwise the handles should be positioned at wrist height (user standing with a straight posture).

4.

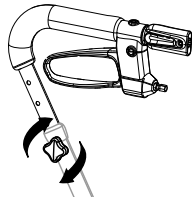

- a. Insert the screw and mount the finger knob.
- b. Turn the finger knob clockwise to tighten.



**WARNING!**

**Risk of falling**

- Make sure that the handles are securely fixed after each adjustment.

5. Repeat the procedure on the other side.

### 3.4 Using the brakes

#### Using the hand brakes

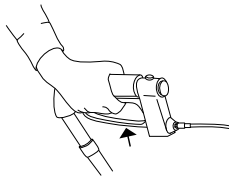

1. Pull both brakes upwards to brake.

### Using the parking brake



**IMPORTANT!**

- Make sure to engage both brakes when using the parking brakes.

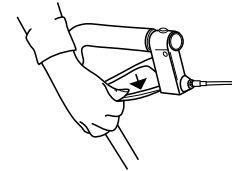

#### Lock the brakes (parking position):

1. Press the brake handles downwards until a clicking sound is heard.

#### Unlock the brakes:

1. Pull the brake handles upwards.

### 3.5 Adjusting the brakes



**WARNING!**

**Risk of personal injuries.**

- If the adjustment is not done properly, the braking effect might not be the expected.
- Make sure the locknuts are properly tightened after adjustment.
  - Check the braking effect by engaging the parking brake and check that the wheel can't rotate.

#### Adjusting the braking effect

For desirable braking effect, adjust the brake wire.

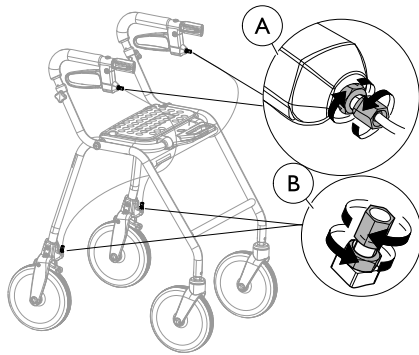

- The wire can be adjusted in two places - above under the brake handle **A** or below above the brake clamp **B**.
- The brake handle must be in neutral position, when adjusting.



8 mm and 10 mm spanner (not included).

### 3.6 Flip up seat plate Flip up the seat plate

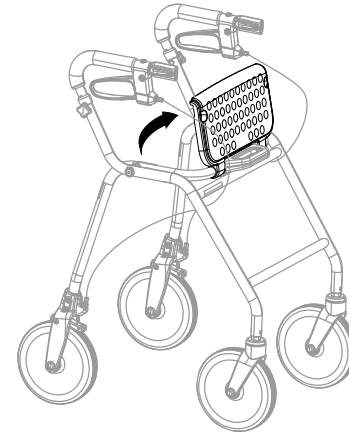

For increased accessibility, the seat can be folded up to provide a larger walking space area.

### 3.7 Walking



#### **WARNING!**

#### **Risk of falling**

– Be careful if the wheels stop against an obstacle.

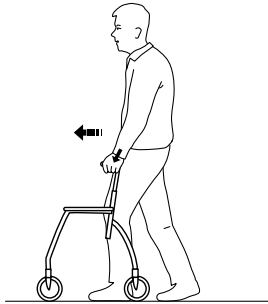

1. Place the walking aid a bit in front of you and take a step towards it whilst using the hand grips for support.

### 3.8 Sitting down on a chair

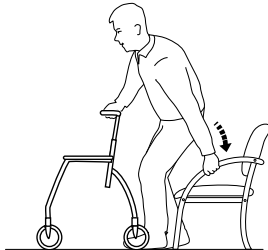

1. Stand in front of the chair with the walking aid, the back of the legs should touch the chair.
2. Place the hands on the arms of the chair, lean forward slightly and sit down carefully.

### 3.9 Rising to a standing position



#### **WARNING!**

#### **Risk of tipping**

- Never use the walking aid to pull yourself up from a sitting position.
- The parking brakes must be in braked position when the walking aid is used as a support when sitting down or getting up, from a chair for example.

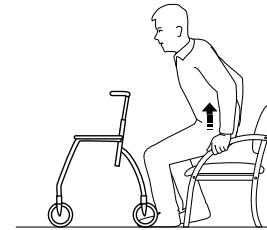

1. Place the walking aid in front of you, use the armrests of the chair as support and rise carefully to a standing position.
2. Once steady in a standing position, transfer hands to the hand grips of the walking aid.

### 3.10 Sitting on the walking aid



**WARNING!**  
**Risk of falling**

Use the walking aid for stationary seating only. Both brakes must be in parking position when the walking aid is used as a seat.

- Never sit and push with your feet.
- Never sit on the walking aid on sloping ground.

### 3.11 Accessories

Accessories are not standard on all models. For a list of available accessories, contact your authorized dealer or the Invacare representative (see rear page of this manual).

#### 3.11.1 Padded backrest strap

##### Mounting the padded backrest strap

1.

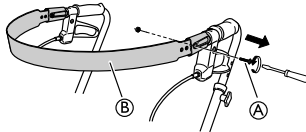

Loosen and remove the screw and the nut (A)

2.

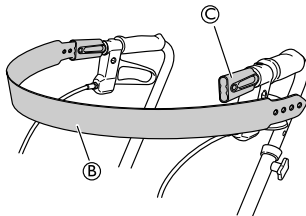

Loosen the backrest strap (B) from the attachment (C) on one side.

3.

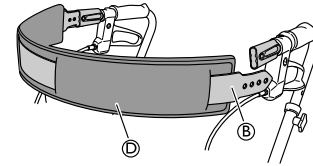

Thread the padded backrest strap (D) on the backrest strap (B).

4.

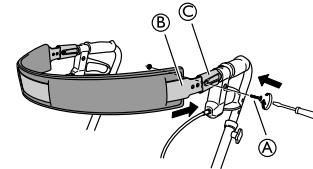

Re-mount the backrest strap (B) in the attachment (C) and tighten the screw and nut (A).



Screwdriver

#### 3.11.2 Padded seat

##### Mounting the padded seat

1.

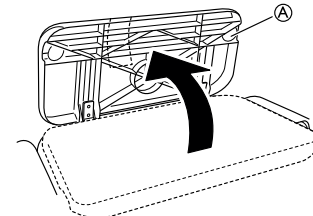

Fold up the seat plate (A).

2.

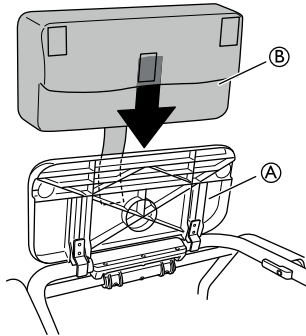

Mount the padded seat (B) on the seat plate (A).

3.

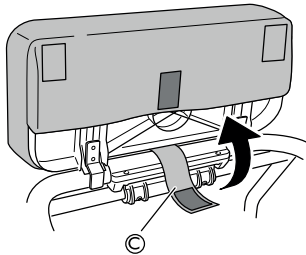

Thread the attachment strap (C) between the seat and the folding handle.

4.

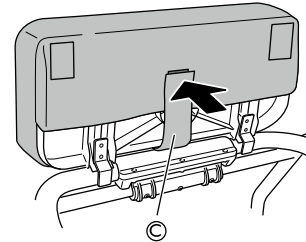

Secure the padded seat with the attachment strap (C).

5.

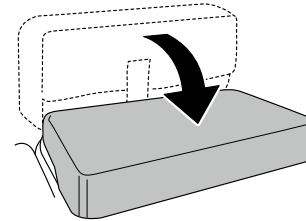

Fold down the seat.

### 3.11.3 Basket



#### **IMPORTANT!**

Do not exceed the maximum allowed load that can be transported in the basket.

– See chapter *Technical data* for maximum load.

### Mounting basket

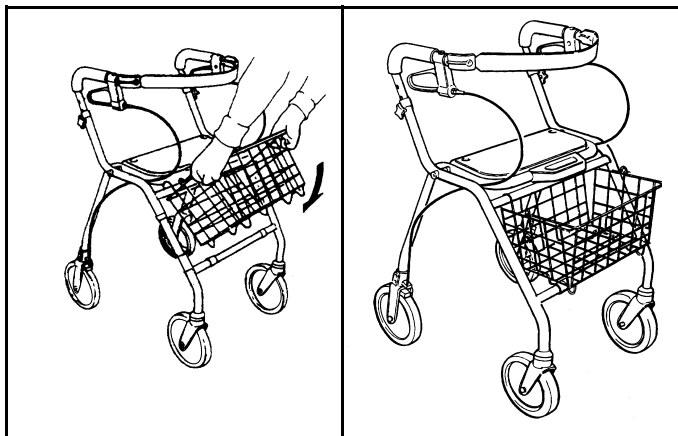

1. Hook the basket onto the frame.
2. Fold it down and make sure it is properly attached.

### 3.11.4 Tray

#### Mounting tray

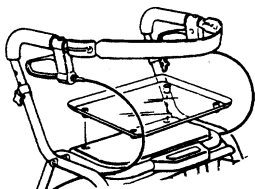

1. Fit the plugs on the downside of the tray into the holes on the seat.
2. Press down the tray.

## 4 Maintenance and care

### 4.1 Maintenance



Maintenance should be done at least once a year.

To ensure good performance and safety you should regularly check that the following is carried out:

- Ensure that screws and adjustments are properly tightened.
- Never use a defective walking aid. Do not attempt repairs yourself!
- If hand grips are loose do not use the walking aid. Change hand grips according to the service instructions which can be obtained from your Invacare representative.
- Verify brake operation. If brake adjustment is required, see chapter 3 Usage, page 8 in this user manual.
- Periodically inspect the castors tightness, wear and damage.
- Make sure that the wheels are free of hair, lint and other debris.

### 4.2 Care

The product can be cleaned and disinfected using commercially available agents.

#### Cleaning



#### **IMPORTANT!**

- Do not use an abrasive detergent, cleaner or cloth to clean or dry the product.
- Do not use high pressure cleaner or steam cleaner.

- Clean the walking aid with solvent-free household cleaner.
- Clean the frame with damp cloth and mild detergent.
- Clean the wheels with a brush (no wire brush!).

- Clean the backrest, seat and basket with mild detergent.

#### **Disinfection**

Disinfect the product by wiping down all generally accessible surfaces with disinfectant.



---

## 5 After Use

---

### 5.1 Disposal

When the product can no longer be used, it and its accessories as well as the packaging material should be sorted in the correct way.

The individual parts can be separated and handled according to their material.

Please be environmentally responsible and recycle this product through your recycling facility at its end of life.

### 5.2 Re-use

This product is suitable for re-use after the following has been performed:

- Inspection
- Cleaning

For details, see chapter 4 Maintenance and care, page 16.

**WARNING!****Risk of injury**

- Always inspect the product according to the service instructions before transferring the product to a different user.
- If any damage is found do not use the product.



The user manual belongs to the product. Make sure that the user manual will be handed over with the product.

## 6 Technical data

### 6.1 Dimensions and weight

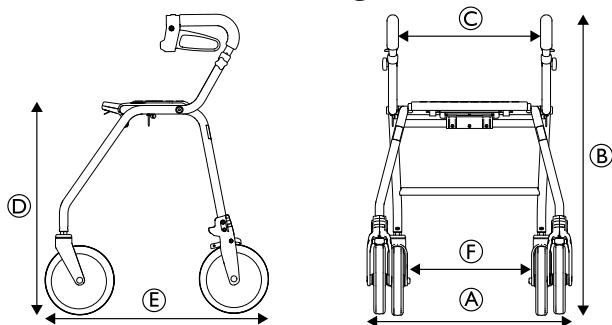

	<b>Legacy 600</b>
Total width <b>A</b>	600 mm
Total height <b>B</b>	835–920 mm
Seat width <b>C</b>	420 mm
Seat height <b>D</b>	620 mm
Total length <b>E</b>	720 mm
Distance between rear wheels <b>F</b>	455 mm
Front/rear wheel <sup>1)</sup> diameter	200 mm

<sup>1)</sup> Front wheels are steering wheels. Rear wheels are provided with a brake system for dosed breaking and for locking the wheel.

## Weights

	<b>Legacy 600</b>
Total weight <sup>2)</sup>	7,6 kg
Max. user weight <sup>3)</sup>	150 kg (330 lbs, 23 stones)
Max load in basket	9 kg (20 lbs)
Max load on tray	5 kg (11 lbs)

<sup>2)</sup> Total weight excluding equipment.

<sup>3)</sup> This weight limitation includes the weight of the user whether standing or sitting.

## 6.2 Material

	<b>Legacy</b>
Frame	Polyester (PES) powder coated steel
Handle bars	Chrome plated steel
Hand grips	Rubber foam
Wheels	Polypropylene (PP) with treads of Thermoplastic Elastomers (TPE)
Plastic parts	Material according to marking; Polyamide (PA), Polypropylene (PP), Polyethylene (PE)
Screws	Steel, rust protected (zinc plated)

**USA and Canada:**

Clarke Health Care Products  
7830 Steubenville Pike  
Oakdale, PA 15071, USA  
Toll Free: (888) 347-4537  
Phone: (724) 695-2122  
email: [info@clarkehealthcare.com](mailto:info@clarkehealthcare.com)  
[www.clarkehealthcare.com](http://www.clarkehealthcare.com)



**Manufacturer:**

Invacare Dolomite AB  
c/o Invacare Rea AB  
Växjövägen 303  
SE-343 71 DIÖ  
[www.dolomite.biz](http://www.dolomite.biz)

1583083-A 2015-05-01



**Making Life's Experiences Possible™**



**Yes, you can.®**