

Panasonic®



Operating Instructions Digital Camera

Model No. **DMC-ZS3**
DMC-ZS1



Before connecting, operating or adjusting this product, please read the instructions completely.



All descriptions and logos pertaining to HDMI, VIERA Link, AVCHD Lite, and Dolby pertain to DMC-ZS3 only.

For USA and Puerto Rico assistance, please call: 1-800-211-PANA(7262) or, contact us via the web at: <http://www.panasonic.com/contactinfo>

For Canadian assistance, please call: 1-800-99-LUMIX (1-800-995-8649) or send e-mail to: lumixconclerge@ca.panasonic.com



VQT1Z82-1

Dear Customer,

Thank you for choosing Panasonic!

You have purchased one of the most sophisticated and reliable products on the market today. Used properly, we're sure it will bring you and your family years of enjoyment. Please take the time to fill in the information below.

The serial number is on the tag located on the underside of your Camera. Be sure to **retain this manual** as your convenient Camera information source.

Model No. _____

Serial No. _____

Information for Your Safety

WARNING:

TO REDUCE THE RISK OF FIRE, ELECTRIC SHOCK OR PRODUCT DAMAGE,

- DO NOT EXPOSE THIS APPARATUS TO RAIN, MOISTURE, DRIPPING OR SPLASHING AND THAT NO OBJECTS FILLED WITH LIQUIDS, SUCH AS VASES, SHALL BE PLACED ON THE APPARATUS.
- USE ONLY THE RECOMMENDED ACCESSORIES.
- DO NOT REMOVE THE COVER (OR BACK); THERE ARE NO USER SERVICEABLE PARTS INSIDE. REFER SERVICING TO QUALIFIED SERVICE PERSONNEL.

THE SOCKET OUTLET SHALL BE INSTALLED NEAR THE EQUIPMENT AND SHALL BE EASILY ACCESSIBLE.

CAUTION

Danger of explosion if battery is incorrectly replaced. Replace only with the same or equivalent type recommended by the manufacturer. Dispose of used batteries according to the manufacturer's instructions.

Warning

Risk of fire, explosion and burns. Do not disassemble, heat above 60 °C (140 °F) or incinerate.

Product Identification Marking is located on the bottom of units.

Carefully observe copyright laws.

Recording of pre-recorded tapes or discs or other published or broadcast material for purposes other than your own private use may infringe copyright laws. Even for the purpose of private use, recording of certain material may be restricted.

- Please note that the actual controls and components, menu items, etc. of your Digital Camera may look somewhat different from those shown in the illustrations in these Operating Instructions.
- HDMI, the HDMI Logo and the High-Definition Multimedia Interface are the registered trademarks or trademarks of HDMI Licensing LLC.
- VIERA Link™ is a trademark of Panasonic Corporation.
- EZ Sync™ is a trademark of Panasonic Corporation.
- HDAVI Control™ is a trademark of Panasonic Corporation.
- SDHC Logo is a trademark.
- Other names, company names, and product names printed in these instructions are trademarks or registered trademarks of the companies concerned.

THE FOLLOWING APPLIES ONLY IN THE U.S.A.

FCC Note:

This equipment has been tested and found to comply with the limits for a Class B digital device, pursuant to Part 15 of the FCC Rules. These limits are designed to provide reasonable protection against harmful interference in a residential installation. This equipment generates, uses, and can radiate radio frequency energy and, if not installed and used in accordance with the instructions, may cause harmful interference to radio communications. However, there is no guarantee that interference will not occur in a particular installation. If this equipment does cause harmful interference to radio or television reception, which can be determined by turning the equipment off and on, the user is encouraged to try to correct the interference by one or more of the following measures:

- Reorient or relocate the receiving antenna.
- Increase the separation between the equipment and receiver.
- Connect the equipment into an outlet on a circuit different from that to which the receiver is connected.
- Consult the dealer or an experienced radio/TV technician for help.

FCC Caution: To assure continued compliance, follow the attached installation instructions and use only shielded interface cables with ferrite core when connecting to computer or peripheral devices.

Any changes or modifications not expressly approved by the party responsible for compliance could void the user's authority to operate this equipment.

Declaration of Conformity

Trade Name: Panasonic
Model No.: DMC-ZS3
DMC-ZS1

Responsible party: Panasonic Corporation of North America
One Panasonic Way,
Secaucus, NJ 07094
Support Contact: Panasonic Consumer Electronics Company
1-800-211-PANA (7262)

This device complies with Part 15 of the FCC Rules. Operation is subject to the following two conditions: (1) This device may not cause harmful interference, and (2) this device must accept any interference received, including interference that may cause undesired operation.



THE FOLLOWING APPLIES ONLY IN CANADA.

This Class B digital apparatus complies with Canadian ICES-003.



A lithium ion battery that is recyclable powers the product you have purchased. Please call 1-800-8-BATTERY for information on how to recycle this battery.

-If you see this symbol-

Information on Disposal in other Countries outside the European Union

This symbol is only valid in the European Union. If you wish to discard this product, please contact your local authorities or dealer and ask for the correct method of disposal.



About the battery pack

CAUTION

Battery pack (Lithium ion battery pack)
• Use the specified unit to recharge the battery pack.

- Do not use the battery pack with equipment other than the specified unit.
- Do not get dirt, sand, liquids, or other foreign matter on the terminals.
- Do not touch the plug terminals (+ and -) with metal objects.
- Do not disassemble, remodel, heat or throw into fire.

If any electrolyte should come into contact with your hands or clothes, wash it off thoroughly with water.

If any electrolyte should come into contact with your eyes, never rub the eyes. Rinse eyes thoroughly with water, and then consult a doctor.

- Do not heat or expose to flame.
- Do not leave the battery(ies) in an automobile exposed to direct sunlight for a long period of time with doors and windows closed.

This manual provides operating instructions for the DMC-ZS3/DMC-ZS1. The appearance, specifications, and screen display vary depending on the model that is used. The descriptions in this manual are primarily based on the DMC-ZS3. Details about functions specific to each model are indicated by symbols added to headings or at the end of descriptions, etc.

(Example)

Functions available in the DMC-ZS3 only:

Functions available in the DMC-ZS1 only:

About the battery charger

CAUTION!

DO NOT INSTALL OR PLACE THIS UNIT IN A BOOKCASE, BUILT-IN CABINET OR IN ANOTHER CONFINED SPACE. ENSURE THE UNIT IS WELL VENTILATED. TO PREVENT RISK OF ELECTRIC SHOCK OR FIRE HAZARD DUE TO OVERHEATING, ENSURE THAT CURTAINS AND ANY OTHER MATERIALS DO NOT OBSTRUCT THE VENTILATION VENTS.

Battery charger

This battery charger operates on AC between 110 V and 240 V.

But

- In the U.S.A. and Canada, the battery charger must be connected to a 120 V AC power supply only.
- When connecting to an AC supply outside of the U.S.A. or Canada, use a plug adaptor to suit the AC outlet configuration.

Quick start guide

The battery is not charged when the camera is shipped. Charge the battery and set the clock before use.

When you do not use the card (sold separately), you can record or play back pictures on the built-in memory (P.16).

1 Charge the battery

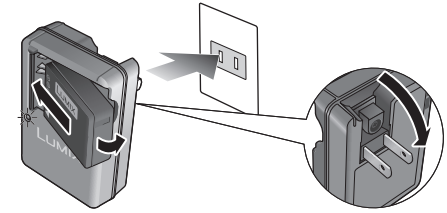

2 Insert the battery and the card

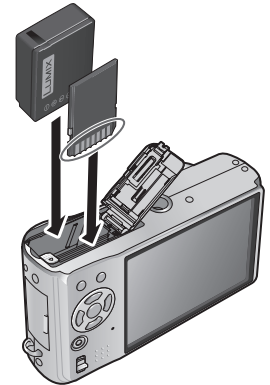

3 Turn on the power

4 Set REC/PLAY switch to



5 Set the mode dial to



6 Press the shutter button and take pictures



■ To play back the pictures

1. Set REC/PLAY switch to
2. Select the picture you want to view.



Previous Next

Record, view, save those

Record P.28

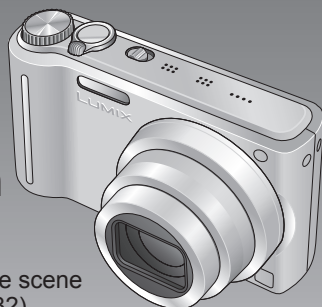

Taking picture with automatic settings

- Camera automatically detects the scene 'INTELLIGENT AUTO' Mode (P.32)
- Automatically adjusts the optimum focus and brightness settings based on the movement of the subject 'AF TRACKING' (P.34)
- Recognizes faces and brings them into sharp focus 'Face detection' (P.34, 73)



Wide Angle

- Everyone can fit into a group photo '25 mm wide angle lens'



Zoom Shooting (P.37)

- 'Optical 12x zoom' ('21.4x zoom' with Extended optical zoom) for close-up pictures of people at a distance



Taking Motion Pictures (P.61, 64)

- Quick switching to motion picture recording at the touch of a button [ZS3] 'Motion picture Button'
- High-definition motion picture recording over extended durations [ZS3] 'AVCHD Lite' (1280 x 720p)
- Zoom functions available even during motion picture recording



Face recognition function [ZS3] (P.65)

- Detect faces close to those that have been registered for priority focus and exposure adjustment. 'Face recognition'

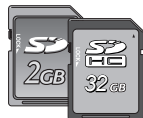

Cards may be inserted directly into devices with SD memory card slots.

- SD memory card/SDHC memory card*2 (sold separately)

precious moments.



View P.107

- Enjoy crisp pictures on large screens!

AV cable

HDMI mini cable (sold separately) [ZS3]

- Easy operation with VIERA remote control [ZS3] 'VIERA Link' support



Print P.104

- With your printer Connect directly to easily print pictures at home. Use a PictBridge-compatible printer.

USB connection cable

- At digital photo center Give card to shop assistant to print pictures.

SD memory card

Save and enjoy your pictures! P.99



Use the bundled software

'PHOTOfunSTUDIO'*3 for

- Saving, retouching, and managing your images
- Creating DVD discs (AVCHD/DVD-Video) from recorded motion pictures [ZS3]

SD memory card

USB connection cable



With DVD recorder*1

Save to DVD or hard disk

SD memory card

AV cable

*1 See respective products' instruction manuals for details.

*2 Can be used on SDHC memory card-compatible devices.

*3 'PHOTOfunSTUDIO 3.0 HD Edition' is included with the DMC-ZS3 model. 'PHOTOfunSTUDIO 3.0' is included with the DMC-ZS1 model. In this manual, 'PHOTOfunSTUDIO' refers to either version of the software.

Contents

Before use

Before use	10
Read first	10
To prevent damage, malfunctions, and faults	10
Standard Accessories	11
Names of parts	12
Cursor button	12

Preparations

Charging battery	13
Inserting battery and card	15
Picture save destination	
(cards and built-in memory)	16
Remaining battery and memory capacity	16
Setting the clock	17
Using menus	18
Menu type	19
Using Quick menu	20
Using SETUP menu	21
CLOCK SET/ WORLD TIME/	
TRAVEL DATE/ BEEP/	
VOLUME/ MONITOR	21
LCD MODE/ ADISPLAY SIZE/	
GUIDE LINE/ HISTOGRAM/	
REC AREA [ZS3]	22
ECO ECONOMY/ AUTO REVIEW	23
ZOOM RESUME/ NO.RESET/	
RESET/ USB MODE	24
TV ASPECT/ HDMI HDMI MODE [ZS3]	25
VIERA Link VIERA Link [ZS3] / VERSION DISP./	
LINK [ZS3] / LANGUAGE	26
FORMAT/ LANGUAGE	26
DEMO DEMO MODE	27

Basics

Basic shooting operation [ZS3]	28
Holding the camera/Direction detection function	29
Mode dial	29
Basic shooting operation [ZS1]	30
Holding the camera/Direction detection function	31
Mode dial	31
Taking picture with automatic settings... 32	

Face Detection and Face Recognition	34
AF TRACKING	34
Taking pictures with your own settings ... 35	
Align focus for desired composition	36
Taking pictures/motion pictures with zoom... 37	
DIGITAL ZOOM	39
Viewing your pictures (NORMAL PLAY) ... 40	
Deleting pictures	41
To delete multiple (up to 50) or all pictures... 41	

Application (Record)

Changing recording information display ... 42	
Taking pictures with flash	43
Taking close-up pictures/motion pictures ... 45	
TELE MACRO	45
MACRO ZOOM	46
Positioning camera and subject within accessible range for focus alignment ... 47	
Taking images with self-timer	48
Taking pictures/motion pictures with exposure compensation	49
EXPOSURE/	
AUTO BRACKET (Pictures only)	49
Taking pictures by automatically changing the aspect ratio [ZS3]	50
SCN Taking pictures according to the scene ... 51	
PORTRAIT/ SOFT SKIN/	
TRANSFORM/ SELF PORTRAIT	52
SCENERY/ PANORAMA ASSIST/	
SPORTS	53
NIGHT PORTRAIT/	
NIGHT SCENERY/ FOOD/	
PARTY/ CANDLE LIGHT	54
BABY/ PET/ SUNSET	55
HIGH SENS./ HI-SPEED BURST	56
FLASH BURST/ STARRY SKY	57
FIREWORKS/ BEACH/ SNOW/	
AERIAL PHOTO/ PIN HOLE	58
FILM GRAIN/ UNDERWATER	59
MS Setting frequently-used scene modes on the mode dial	60
Taking motion pictures [ZS3]	61
Taking motion pictures [ZS1]	64

Taking pictures with the face recognition function [ZS3]

Face Recognition function	65
Face registration	65
Useful features for travel	67
TRAVEL DATE	67
WORLD TIME	68
Using REC/MOTION PICTURE menu ... 69	
PICTURE SIZE	69
QUALITY/ ASPECT RATIO/	
INTELLIGENT ISO	70
ISO SENSITIVITY	71
WB WHITE BALANCE	72
FACE RECOG. [ZS3] / AF MODE	73
PRE AF/ METERING MODE	75
I.EXPOSURE/ BURST	76
DIGITAL ZOOM/ COLOR MODE/	
STABILIZER	77
MIN. SHTR SPEED/ AUDIO REC/	
AF* AF ASSIST LAMP	78
CLOCK SET/ REC MODE [ZS3]	79
REC QUALITY/ CONTINUOUS AF/	
WIND CUT [ZS3]	80
Taking/viewing clipboard pictures... 81	
Taking clipboard pictures/	
Viewing clipboard pictures	81
Zoom mark/CLIPBOARD menu	82
Application (View)	
Viewing as list	
(Multi playback/Calendar playback)... 83	
Viewing motion pictures/pictures with audio.... 84	
Different playback methods	85
SLIDE SHOW	86
MODE PLAY [ZS3]	87
CATEGORY PLAY/ FAVORITE PLAY	88
Using PLAYBACK menu	89
CALENDAR/ TITLE EDIT	89
Text input method	89
TEXT STAMP	90
RESIZE	91
TRIMMING	92
LEVELING/ FACE RECOG. [ZS3]	93
ASPECT CONV. [ZS3] / ROTATE DISP	94

★ FAVORITE	95
PRINT SET	96
PROTECT/ AUDIO DUB.	97
COPY	98

Connecting with other devices

Copying recorded pictures	99
Dubbing playback images via AV cables	99
Copying to computers	99
Using with your PC	100
Copying still pictures and motion pictures ... 101	
Using the Multi Conversion Adaptor (sold separately)	103
Printing	104
Printing multiple pictures/	
Print with date and text	105
Making print settings on camera	106
Viewing on TV screen	107
Viewing on a TV with HDMI Socket [ZS3] ... 108	
VIERA Link (HDMI) (HDAVI Control™) [ZS3] ... 109	

Others

List of LCD monitor displays	112
In recording	112
In playback	113
Message displays	114
Q&A Troubleshooting	116
Usage cautions and notes	122
Recording picture/time capacity	124
Specifications	128
Optional accessories	132
Digital Camera Accessory Order Form (For USA and Puerto Rico Customers) ... 133	
Request for Service Notice (For USA and Puerto Rico Only)	134
Limited Warranty (For USA and Puerto Rico Only)	135
Customer Services Directory (United States and Puerto Rico)	137
Index	140

Before use

Read first

■ Do a test shot first!

Check first to see if you can take pictures and record sounds (motion pictures/pictures with audio) successfully.

■ We will not compensate for failed/lost recording or for direct/indirect damage.

Panasonic will not provide compensation for video or image damage caused by faults with camera or card.

■ Certain pictures cannot be played back

- Pictures edited on a computer
- Pictures taken or edited on a different camera (Pictures taken or edited on this camera may also not be able to be played back on other cameras)

■ Software on the CD-ROM supplied

- The following actions are prohibited:
- Making duplicates (copying) for sale or rent
 - Copying onto networks

LCD monitor characteristics

Extremely high precision technology is employed to produce the LCD monitor screen. However there may be some dark or bright spots (red, blue or green) on the screen. This is not a malfunction.

The LCD monitor screen has more than 99.99% effective pixels with a mere 0.01% of the pixels inactive or always lit. The spots will not be recorded on pictures on the built-in memory or a card.

Unit temperature

The camera may become warm during use. (Especially grip area, etc.) This does not cause a problem with the performance or quality of the camera.



Grip area

To prevent damage, malfunctions, and faults

■ Avoid shocks, vibration, and pressure

- Avoid exposing the camera to strong vibration or shock; e.g. dropping or hitting the camera, or sitting down with the camera in your pocket. (Attach hand strap to avoid dropping camera. Hanging any items other than the supplied hand strap from the camera can apply pressure against it.)
- Do not press the lens or the LCD monitor.

■ Do not get the camera wet or insert foreign objects This camera is not waterproof.

- Do not expose the camera to water, rain, or seawater. (If camera gets wet, wipe with a soft, dry cloth. Wring cloth thoroughly first if wet with seawater, etc.)
- Avoid exposing lens and socket to dust or sand, and do not allow liquids to leak into gaps around buttons.

■ Avoid condensation caused by sudden changes in temperature and humidity

- When moving between places of different temperature or humidity, place camera into a plastic bag and allow to adjust to conditions before use.
- If the lens clouds up, switch off the power and leave for about two hours to allow camera to adjust to conditions.
- If the LCD monitor clouds up, wipe with a soft, dry cloth.

■ Lens

- If lens is dirty: Images may appear slightly white if lens is dirty (fingerprints, etc.). Turn the power on, hold the extracted lens barrel with your fingers, and gently wipe the lens surface with a soft, dry cloth.
- Do not leave in direct sunlight.

Camera ON/OFF switch

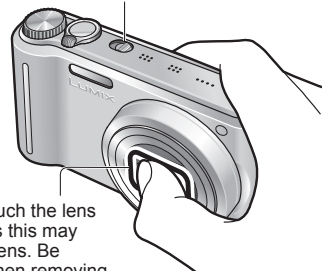

Do not touch the lens barrier, as this may damage lens. Be careful when removing camera from bag, etc.

■ When using tripod

- Do not apply excessive force or tighten screws at an angle (may damage camera, screw hole, or label.)
- Ensure that the tripod is stable. (Read the tripod's instruction manual.)

■ When transporting

Switch off power.
We recommend using a genuine leather case (DMW-CT3, sold separately).

Standard Accessories

Part numbers are as of February 2009

□ Battery Pack

DMW-BCG10PP

- Charge the battery before use. (referred to in this manual as 'battery')



□ Battery Charger

DE-A65B

(referred to in this manual as 'charger')



□ Battery Carrying Case

VGQ0E45



□ Hand Strap

VFC4297



□ USB Connection Cable

K1HA14AD0001



□ AV Cable

K1HA14CD0001



□ CD-ROM

- Install software on your computer to use it.



- Please dispose of all packaging appropriately.

■ Optional accessories (P.132)

- Cards are optional. You can record or play back pictures on the built-in memory when you are not using a card. (P.16)
- If any accessories are lost, customers in the USA and Puerto Rico should contact Panasonic's parts department at 1 800 833-9626 and customers in Canada should contact 1 800 99-LUMIX (1-800-995-8649) for further information about obtaining replacement parts.

Please also refer to 'Usage cautions and notes' (P.122).

Names of parts

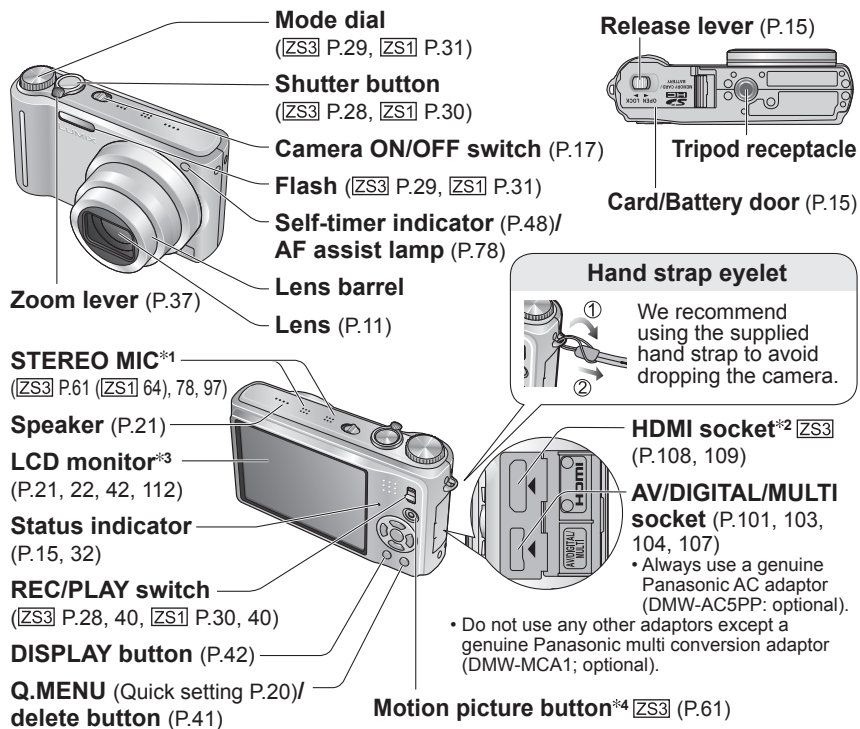

Hand strap eyelet

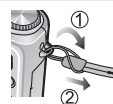

We recommend using the supplied hand strap to avoid dropping the camera.

HDMI socket*2 ZS3 (P.108, 109)

AV/DIGITAL/MULTI socket (P.101, 103, 104, 107)

• Always use a genuine Panasonic AC adaptor (DMW-AC5PP: optional).

• Do not use any other adaptors except a genuine Panasonic multi conversion adaptor (DMW-MCA1; optional).

Cursor button

MENU/SET

(menu display/set/finish) (P.18)

Left cursor button (◀)

• Self-timer (P.48)

Down cursor button (▼)

• Macro mode (P.45)

• AF Lock (AF tracking) (P.34, 73)

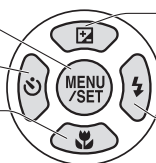

Up cursor button (▲)

• Exposure compensation (P.49)

• Auto bracket (P.49)

• Multi aspect*2 ZS3 (P.50)

• White balance fine adjustment (P.72)

Right cursor button (▶)

• Flash (P.43)

● In this manual, the button that is used is shaded or indicated by ▲ ▼ ▲▶ ◀▶.

● The appearance, specifications, and screen display vary depending on the model that is used. The descriptions in this manual are primarily based on the DMC-ZS3.

*1 DMC-ZS1 has only one microphone (Monaural).

*2 This is not available in the DMC-ZS1.

*3 The size in the DMC-ZS1 is different. *4 DMC-ZS1 does not have this button.

Charging battery

Always charge before first use! (not sold pre-charged)

■ About batteries that you can use with this unit (as of February 2009)

The battery that can be used with this unit is DMW-BCG10PP.

It has been found that counterfeit battery packs which look very similar to the genuine product are made available to purchase in some markets. Some of these battery packs are not adequately protected with internal protection to meet the requirements of appropriate safety standards. There is a possibility that these battery packs may lead to fire or explosion. Please be advised that we are not liable for any accident or failure occurring as a result of use of a counterfeit battery pack. To ensure that safe products are used we would recommend that a genuine Panasonic battery pack is used.

- Use the dedicated charger and battery.
- Use of third party aftermarket batteries is not recommended. Such batteries may not include internal safety design features that can protect the camera should the battery fail. Damage resulting from the use of non-Panasonic batteries is not covered under the warranty.
- This camera has a function identifying batteries that can be used, and this function is compatible with the dedicated battery (DMW-BCG10PP).

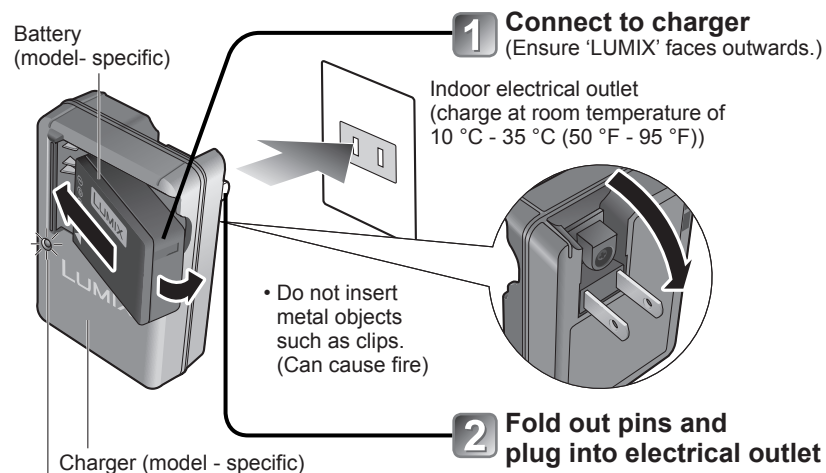

1 Connect to charger

(Ensure 'LUMIX' faces outwards.)

Indoor electrical outlet
(charge at room temperature of
10 °C - 35 °C (50 °F - 95 °F))

- Do not insert metal objects such as clips. (Can cause fire)

2 Fold out pins and plug into electrical outlet

Charging light (CHARGE)

On: Charging in progress, approx. 130 min. (Max.)

Off: Charging complete (Disconnect charger and battery when charging is complete.)

If light is flashing:

- Charging may take longer than normal if battery temperature is too high or too low (charging may not be completed).
- Battery/charger connector is dirty. Clean with a dry cloth.

Charging battery (Continued)

■ The battery life

Figures may be reduced if intervals between recordings are longer; if flash, zoom, or LCD MODE are used frequently; or in colder climates (depends on actual usage).

Number of recordable pictures	Approx. 300 pictures [ZS3] Approx. 320 pictures [ZS1]	By CIPA standard in normal picture mode
Recording time	Approx. 150 min [ZS3] Approx. 160 min [ZS1]	

● Recording conditions by CIPA* standard

*CIPA is an abbreviation of [Camera & Imaging Products Association].

- Temperature 23 °C (73.4 °F), humidity 50 %
- LCD monitor ON (The number of recordable pictures decreases in AUTO POWER LCD, POWER LCD, and HIGH ANGLE [ZS1] Mode)
- Using Panasonic SD memory card (32 MB)
- Using the supplied battery
- NORMAL PICTURE Mode
- First picture taken 30 sec. after power turned on (STABILIZER 'AUTO')
- 1 picture taken per 30 sec.
- Full flash used for every other picture
- Zoom operation for each picture (max. W → max. T, or max. T → max. W)
- Power turned off after each 10 pictures, battery allowed to cool

Number reduced if intervals longer – e.g. to approx. one quarter (75 pictures [ZS3] / 80 pictures [ZS1]) for 2-minute intervals under the above conditions.

Playback time	Approx. 300 min
----------------------	-----------------

The number of recordable pictures or available recording time may vary slightly according to battery and usage conditions.

Recording time capacity (motion pictures)	Approx. 90 min [ZS3]
--	----------------------

- Continuous recording with 'REC MODE' set to 'AVCHD Lite' and 'REC QUALITY' to 'SH' Available recording time varies according to usage conditions and intervals between recording.*
- * Available recording time will be reduced when the camera is switched 'ON'/'OFF', recording is stopped/started, or zoom operations are used frequently.

- Battery will be warm during charging and for some time thereafter.
- Battery will run out if not used for long periods of time, even after being charged.
- Frequently charging up battery is not recommended. (Frequently charging battery reduces maximum usage time and can cause battery to expand.)
- Do not disassemble or modify the charger.
- If available battery power is significantly reduced, battery is reaching end of lifespan. Please purchase a new battery.
- For your safety and to prevent damage to this camera, do not attempt to operate this camera with any non-Panasonic "after-market" brand battery.
- When charging:
 - Remove any dirt on connectors of charger and battery with dry cloth.
 - Keep at least 1 m (3.28 feet) away from AM radio (may cause radio interference).
 - Noises may be emitted from inside of charger, but this is not a fault.
 - Always remove from main socket after charging (up to 0.1 W consumed if left in place).
- Store battery in battery carrying case after use.
- Do not use if damaged or dented (especially connectors), e.g. by dropping (can cause faults).
- The unusable battery should be discarded in accordance with battery recycling laws. Call the RBRC hotline at 1-800-822-8837 for information.

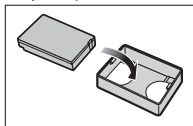

Inserting battery and card

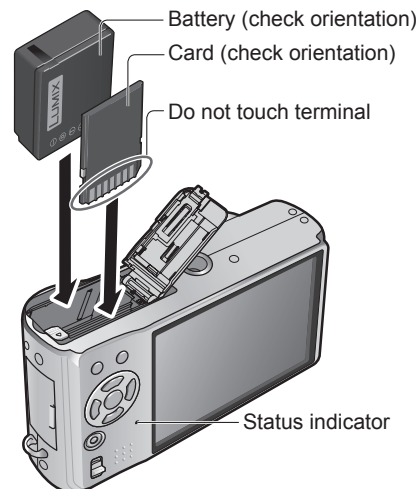

- 1** Set the camera ON/OFF switch to OFF
Slide to the 'OPEN' position and open the lid

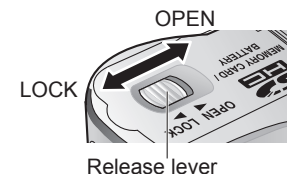

- 2** **Completely insert battery and card**
(both click into place)

- 3** **Close lid**
Slide to the 'LOCK' position.

■ To remove

• To remove battery:

move lever in direction of arrow.

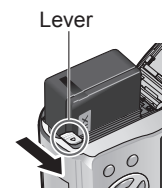

• To remove card:

press down in center.

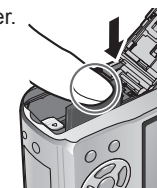

- Always use genuine Panasonic batteries (DMW-BCG10PP).
- If you use other batteries, we cannot guarantee the quality of this product.
- Do not remove card or battery while power is 'ON' or while status indicator is on (Camera may cease operating correctly, or card/recorded contents may be damaged).
- The reading/writing speed of a MultiMediaCard is slower than an SD memory card. When a MultiMediaCard is used, the performance of certain features may be slightly slower than advertised.
- Keep the Memory Card out of reach of children to prevent swallowing.

Inserting battery and card (Continued)

Picture save destination (cards and built-in memory)

Pictures will be saved to a card if one is inserted, or to the built-in memory  if not.

Compatible memory cards (sold separately)

The following SD standard-based cards (Panasonic brand recommended)

- SD memory cards (8 MB - 2 GB)
- SDHC memory cards (4 GB - 32 GB)

Can only be used with devices compatible with SDHC memory cards. (Always read your device's operating instructions before proceeding)

- Cards of over 4 GB may only be used if they have the SDHC logo.
- Please reformat the card with this camera if it has already been formatted with a computer or another device. (P.26)
- If the switch on the card is set to 'LOCK', operations such as formatting, recording, and deleting cannot be performed.
- MultiMediaCards may also be used (for pictures only)

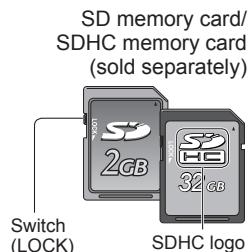

Built-in memory (approx. 40 MB)

- Built-in memory is slower than SD memory card.
- 'QVGA' in 'REC QUALITY' (P.80) only can be available to record motion pictures in the built-in memory.
- Clipboard pictures (P.81) are saved to built-in memory.
- Pictures may be copied between cards and the built-in memory (P.98).

Remaining battery and memory capacity



Remaining battery (only when using battery)



If the battery mark flashes red (or status indicator flashed when LCD monitor is off), recharge or replace battery. (P.13)

Displayed when no card inserted (pictures will be saved to built-in memory)

Pictures remaining ( P.124  P.126)

When in operation

 (Card) or  (Built-in memory) are illuminated red.

This means that an operation is in progress, such as the recording, reading, deleting, or formatting of pictures. Do not turn off the power or remove the battery, card, or AC adaptor (DMW-AC5PP, sold separately) (this may cause damage to or loss of data). Do not subject the camera to vibrations, impact, or static electricity. Should any of these cause camera operation to be terminated, attempt to perform the operation again.

- It is recommended that you copy important pictures to your computer (as electromagnetic waves, static electricity, or faults may cause data to be damaged).
- For model numbers and types, see <http://panasonic.co.jp/pavc/global/cs> (This Site is English only.)

Setting the clock

(The clock is not set when the camera is shipped.)

Set REC/PLAY switch to  before turning on power.

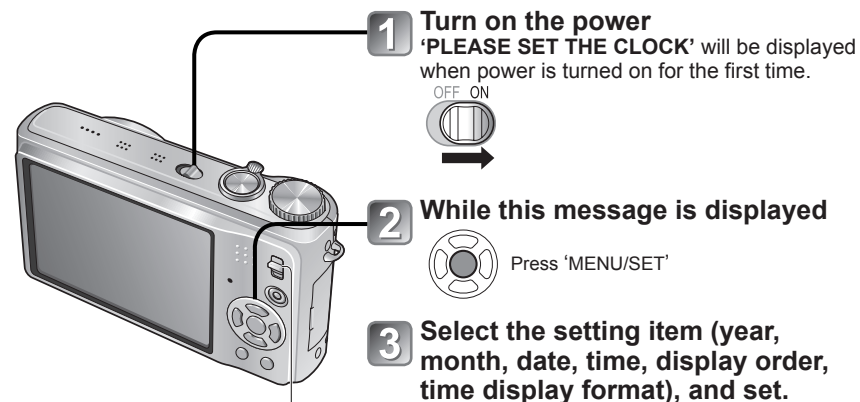

1 Turn on the power
'PLEASE SET THE CLOCK' will be displayed when power is turned on for the first time.



2 While this message is displayed



Press 'MENU/SET'

3 Select the setting item (year, month, date, time, display order, time display format), and set.



Select the setting item

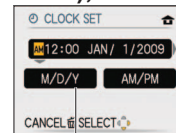

Set the date, time, or display.

Select the display format

- To cancel → Press .
- Setting example of display order and time display format*
[M/D/Y] [24HRS]: 12:34 APR.15.2009
[D/M/Y] [AM/PM]: PM 12:34 15.APR.2009
[Y/M/D] [24HRS]: 2009.4.15 12:34
* When set to [AM/PM], 0:00 midnight is AM 12:00, and 0:00 noon is PM 12:00.

To change time setting

Select 'CLOCK SET' from SETUP menu (P.21), perform **3** and **4**.

- Clock settings will be saved for approx. 3 months even after battery is removed, provided a fully-charged battery was installed in camera for the 24 hours beforehand.

To set local time at travel destination

➔ 'WORLD TIME' (P.68)

4 Set



Press 'MENU/SET'

- Turn on power again and check time display. (Time and date can be displayed by pressing 'DISPLAY' several times.)

- Failure to set the date and time will cause the date/time to be improperly printed when printing pictures in digital photo center or when using 'TEXT STAMP' (P.90).
- Year can be set between 2000 and 2099.
- After the time has been set, the date can be printed correctly even if the date is not displayed on the camera screen.

Using menus

To enable optimum usage of the camera, various functions can be activated and setting can be changed from the menus.

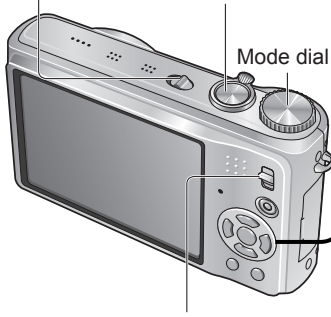

(Example) Change 'VOLUME' in SETUP menu when in NORMAL PICTURE Mode.
(REC/PLAY switch , Mode dial )



1 Bring up the menu

The selected item is displayed with an orange background.

2 Select SETUP menu

① Highlight  ② Select  and return to menu items

Turns orange

3 Select the item

Page (Zoom lever can be used to switch to next screen.)

Item

4 Select the setting

Settings

Selected setting













5 Finish

• When the REC/PLAY switch is set to , menu can be closed with a half-press of the shutter button.

■ To restore default settings
➔ 'RESET' (P.24)

● Settings display may vary according to items.

Menu type

<p>REC menu</p> <p>MOTION PICTURE menu </p> <p>Changing image preferences (P.69 - 80)</p> <ul style="list-style-type: none"> Displays settings such as white balance, sensitivity, aspect ratio, and picture size. 	<p> REC menu</p> <p> REC menu</p> <p> MOTION PICTURE menu</p>	<p> REC menu</p> <p> MOTION PICTURE menu</p>
<p>SETUP menu</p> <p>Making the camera more convenient to use (P.21 - 27)</p> <ul style="list-style-type: none"> Displays settings for ease of use such as adjusting the clock and changing the beep sounds. 	<p> SETUP menu</p>	<p> SETUP menu</p>
<p>MODE PLAYBACK MODE menu</p> <p>Viewing recorded pictures (P.85 - 88)</p> <ul style="list-style-type: none"> Choose a playback type to see slideshows or just your favorite pictures. 	<p> PLAYBACK MODE menu</p>	<p> PLAYBACK MODE menu</p>
<p>PLAYBACK menu</p> <p>Using your pictures (P.89 - 98)</p> <ul style="list-style-type: none"> Displays settings for using the images you have taken, including protecting, trimming, and handy settings for printing your pictures (DPOF). 	<p> PLAYBACK menu</p>	<p> PLAYBACK menu</p>

* REC/PLAY switch

● Menu items displayed vary according to mode dial setting.

Using menus (Continued)

Using Quick menu

Recording menu items can be called up easily.

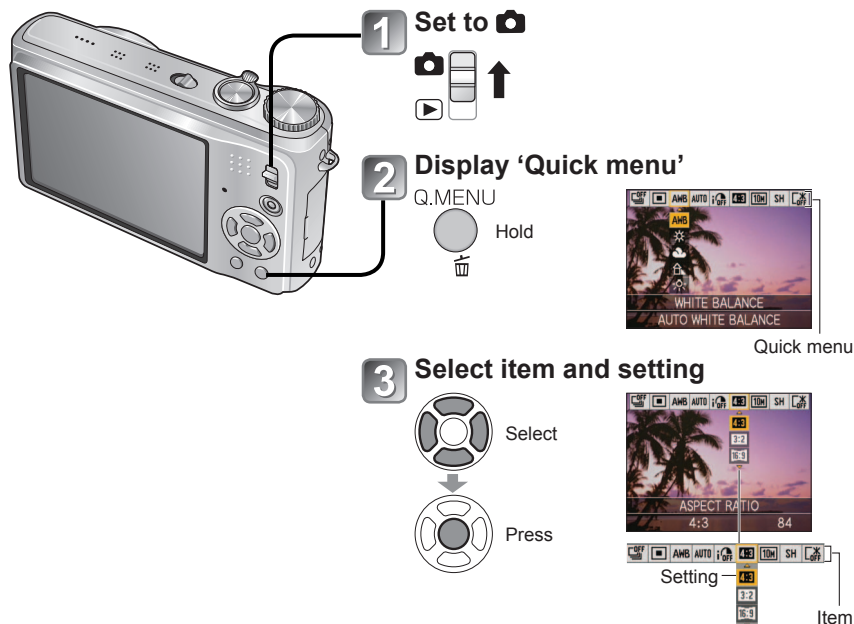



● Settings items displayed vary depending on recording mode.

Using SETUP menu







Make general camera settings such as adjusting the clock, extending the battery life, and changing the beep sounds.

'CLOCK SET', 'AUTO REVIEW' and 'ECONOMY' are important for clock setting and battery life. Be sure to check these before use. (Setting method : P.18)

Item	Settings, notes
CLOCK SET Set the date and time. (P.17)	Set time, date, and display format.
WORLD TIME Set the local time at travel destination. (P.68)	DESTINATION: Set the local time at travel destination. HOME: Set date and time at home area.
TRAVEL DATE Record the number of days elapsed in your travels. (P.67)	TRAVEL SETUP OFF/SET (Register departure and return dates) LOCATION OFF/SET (Input name of destination.) (P.89)
BEEP Change or mute the beep/shutter sounds.	BEEP LEVEL : Mute/Low/High BEEP TONE : Change beep tone. SHUTTER VOL. : Mute/Low/High SHUTTER TONE : Change shutter tone.
VOLUME Adjust volume of sound from speakers (7 levels).	0 •• LEVEL3 •• LEVEL6 • Cannot be used to adjust TV speaker volume when connected to TV. (We recommend setting camera volume to 0)
MONITOR Adjust the brightness of the LCD monitor (7 levels).	+1 - +3: Brighter ±0: Standard -1 - -3: Darker





Item	Settings, notes
LCD LCD MODE Make LCD monitor easier to see.	OFF: Normal (cancel setting) [A] AUTO POWER LCD: The brightness is adjusted automatically depending on how bright it is around the camera. [X] POWER LCD: Makes screen brighter than normal (for outdoor use). [Q] HIGH ANGLE: [ZS1] Makes screen easier to see when taking pictures from high positions. (becomes harder to see from the front) <ul style="list-style-type: none"> • 'HIGH ANGLE' will be canceled when power is turned off (including POWER SAVE). • Block out sunlight (with hand, etc.) if reflection makes screen difficult to see. • 'AUTO POWER LCD' or 'HIGH ANGLE' cannot be used in the following cases. During playback mode or menu screen display, or when connected to computer/printer. • 'POWER LCD' will be deactivated if no operations are performed for 30 seconds while recording. (Brightness can be restored by pressing any button) • Brightness/color of screen in 'LCD MODE' has no effect on pictures recorded. • 'AUTO POWER LCD' cannot be set in playback mode. • The number of recordable pictures and the recording time are reduced when using 'AUTO POWER LCD' or 'POWER LCD'.
A DISPLAY SIZE Change the display size of the menu.	STANDARD/LARGE
GUIDE LINE Select recording information display and types of guidelines. (P.42)	REC. INFO. OFF/ON (Display recording information with guide lines.) PATTERN  : Change the patterns of guide lines.
HISTOGRAM Check subject brightness on graph. (P.42)	OFF/ON
REC AREA [ZS3] Enables verification of the recordable area for a motion picture before recording.	OFF/ON <ul style="list-style-type: none"> • Recordable area displayed for motion pictures should be interpreted as a guideline. • When using extended optical zoom, the recordable area may not always be displayed for certain zoom ratios. • This setting cannot be used with Intelligent Auto Mode. This section is not recorded. 

Item	Settings, notes
ECO ECONOMY Turn off LCD monitor and power while not in use to save battery consumption.	POWER SAVE OFF/2MIN./5 MIN./10MIN. : Automatically shut off power while not in use. <ul style="list-style-type: none"> • To restore → Press the shutter button halfway, or turn on the power again. • Cannot be used in the following cases: When using AC adaptor (DMW-AC5PP, sold separately), when connected to computer/printer, during motion picture recording/playback, during slideshows • Settings fixed to '2 MIN.' in 'AUTO LCD OFF' (below), '5 MIN.' in INTELLIGENT AUTO Mode or CLIPBOARD Mode, or '10 MIN.' while slideshow is paused.
	AUTO LCD OFF OFF/15SEC./30SEC. : LCD monitor is shut off if no operations are performed for a set period while recording. (Status indicator is illuminated while monitor is off.) <ul style="list-style-type: none"> • Cannot be used in the following cases: When using INTELLIGENT AUTO Mode, CLIPBOARD Mode, or AC adaptor (DMW-AC5PP, sold separately), when menu screen is displayed, when using self-timer setting or during motion picture recording. • To restore → Press any button.
AUTO REVIEW Automatically display pictures immediately after taking them.	OFF: No auto review 1 SEC./2 SEC. : Automatically display for 1 or 2 seconds. HOLD: Auto review screen remains until a button (other than the display button) is pressed ZOOM: Displays for 1 second, then at 4x zoom for 1 second <ul style="list-style-type: none"> • Fixed to '2 SEC.' in INTELLIGENT AUTO Mode. • In 'SELF PORTRAIT', 'PANORAMA ASSIST', 'HI-SPEED BURST', and 'FLASH BURST' scene modes, 'AUTO BRACKET', 'MULTI ASPECT [ZS3]', 'BURST' Mode, or pictures with audio, auto review performed regardless of setting. • Motion pictures cannot be automatically reviewed.

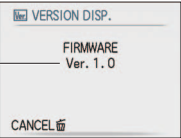
Item	Settings, notes
 ZOOM RESUME Remember the zoom ratio when turning power off.	OFF/ON <ul style="list-style-type: none"> Cannot be set when using 'SELF PORTRAIT' scene mode.
 NO.RESET Reset image file numbers.	YES/NO <ul style="list-style-type: none"> The folder number is updated and the file number starts from 0001. A folder number between 100 and 999 can be assigned. Numbers cannot be reset once folder number reaches 999. In this case, save all necessary pictures to your computer, and format the built-in memory/card (P.26). To reset folder number to 100: First, format the built-in memory or card, and reset the file numbers using 'NO. RESET'. Then, select 'YES' on the folder number reset screen. File numbers and folder numbers. (P.102, 121)
 RESET Reset to the default settings.	RESET REC. SETTINGS? YES/NO RESET SETUP PARAMETERS? YES/NO <ul style="list-style-type: none"> Information registered in 'FACE RECOG.' [ZS3] is reset if recording settings are reset. Resetting SETUP parameters causes the following to be reset: Birthdays and names in 'BABY' and 'PET' scene modes, 'TRAVEL DATE', 'WORLD TIME', 'ZOOM RESUME', 'FAVORITE' in PLAYBACK menu (set to 'OFF'), 'ROTATE DISP.' (set to 'ON'). Folder numbers and clock settings will not be reset. Camera movement may be audible as the lens function is reset. This is not a fault.
 USB MODE Select communication method for when connecting camera to a computer or printer with USB connection cable.	SELECT ON CONNECTION: Select 'PC' or 'PictBridge(PTP)' each time you connect to a computer or PictBridge-compatible printer.  PictBridge (PTP) : Select when connecting to a PictBridge-compatible printer  PC : Select when connecting to a computer

Item	Settings, notes
 TV ASPECT Change the aspect ratio when connected to a TV, etc. (PLAYBACK mode only).	16:9 / 4:3 <ul style="list-style-type: none"> When set to 16:9, pictures will be displayed vertically long on LCD monitor. (Operates when AV cable is connected.)
HDMI HDMI MODE [ZS3] Set the output resolution when connected to a high-definition TV with an HDMI mini cable (sold separately). (P.108)	AUTO: The output resolution is automatically determined based on information from the connected TV. 1080i: Outputs 1080 effective scanning lines in interlaced format. 720p: Outputs 720 effective scanning lines in progressive format. 480p: Outputs 480 effective scanning lines in progressive format.
	Interlaced and Progressive Formats In 'i' = interlaced format (interlaced scanning), half of the effective scanning lines are displayed alternately every 1/60 second. In 'p' = progressive format (progressive scanning), high-density video signals are sent simultaneously for all effective scanning lines every 1/60 second. The HDMI socket of this camera supports '1080i' high definition video output. To enjoy progressive video or high definition video, a TV compatible with these formats is required.
	<ul style="list-style-type: none"> Even if '1080i' is set, the motion picture is output at 720p during playback. If no video appears on the TV even though 'AUTO' is set, try switching to '1080i', '720p', or '480p' to adjust to a video format that can be displayed on your TV. (See the manual for your TV.) This is activated when an HDMI mini cable (sold separately) is connected. For further details, see P.108.

Item	Settings, notes
VIERA Link VIERA Link [ZS3] Enable automatic linking with other VIERA Link-compatible devices, and operability with a VIERA remote control when connecting via an HDMI mini cable (sold separately) (P.109).	<p>OFF: Operations must be performed via the camera's own buttons.</p> <p>ON: Operations may be performed via the remote control of the VIERA Link-compatible device. (Not all operations will be available.) Operability of the camera's own buttons will be limited.</p> <ul style="list-style-type: none"> • Works when connected via an HDMI mini cable (sold separately).
Ver. VERSION DISP. Check the version of the camera firmware.	<p>Current version is displayed.</p> 
FORMAT Use when 'BUILT-IN MEMORY ERROR' or 'MEMORY CARD ERROR' appears, or when formatting the built-in memory or card. When a card/built-in memory is formatted, the data cannot be restored. Check the content of the card/built-in memory carefully before formatting.	<p>YES/NO</p> <ul style="list-style-type: none"> • This requires a sufficiently charged battery (P.13) or AC adaptor (DMW-AC5PP, sold separately). (Only inserted card will be formatted if present; built-in memory will be formatted if no card is inserted.) • Always format cards with this camera. • All picture data including protected pictures will be deleted. (P.97) • Do not turn off power or perform other operations during formatting. • Consult your nearest Service Center if format cannot be successfully completed. • Formatting the built-in memory may take several minutes.
LANGUAGE Change display language.	<p>ENGLISH / DEUTSCH* (German) / FRANÇAIS* (French) / ESPAÑOL (Spanish) / ITALIANO* (Italian) / 中文* (Chinese) / 日本語* (Japanese)</p> <p>* Not displayed on DMC-ZS3P/DMC-ZS1P.</p>

Item	Settings, notes
DEMO DEMO MODE View demonstration of functions.	<p>JITTER, SUBJ. MOVE DEMO.: (Only during recording) Extent of jitter and of subject movement are shown on graph. (Estimate)</p> <p>Large ← Small → Large</p>  Jitter  Movement detection
	<ul style="list-style-type: none"> • When the REC/PLAY switch is , a guidance message is displayed that asks the user to switch to . • To stop → Press display button (P.12). • Recording and zoom cannot be performed during demo. • Use the movement detection demo with objects with contrasting coloring.
	<p>AUTO DEMO: View introductory slideshow</p> <p>OFF/ON</p> <ul style="list-style-type: none"> • To close → Press 'MENU/SET' • If the camera is left switched on while connected to the AC adaptor (DMW-AC5PP, sold separately) and with no card inserted, the demo will automatically begin whenever no operations are performed for approx. 2 minutes.

Basic shooting operation ZS3

Please set the clock before shooting (P.17).

1 Turn on the power
 OFF ON
 Status indicator illuminated for approx. 1 second.

2 Set to
 : Pictures and motion pictures can be taken.
 : The captured pictures and motion pictures can be played back.

3 Set to the desired recording mode

4 Aim the camera and shoot

Motion picture button
 • Motion pictures can be recorded immediately by pressing the motion picture button.

■ Taking still pictures Press the shutter button

① Gently press the shutter button

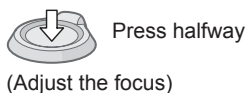

② Press and hold the shutter button to take picture



■ Recording motion pictures Press the motion picture button

① Press the motion picture button to start recording



② Press the motion picture button again to finish recording



• Motion pictures cannot be recorded in (CLIPBOARD Mode). (P.61)

Holding the camera/Direction detection function

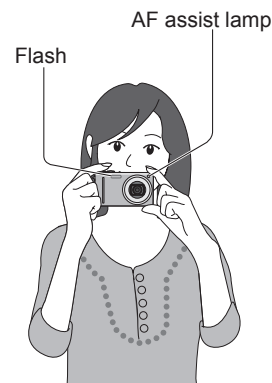

- Stand with your arms close to your body and with your legs apart.
- Do not touch the lens.
- Do not block the microphone when recording audio. (P.12)
- Do not block the flash or the lamp. Do not look at it from close range.
- Pictures taken with camera held vertically can automatically be displayed vertically in playback. (Only when 'ROTATE DISP.' (P.94) is 'ON') Pictures may not be able to be displayed vertically if taken with camera facing upwards or downwards. Motion pictures cannot be displayed vertically during playback.

Mode dial

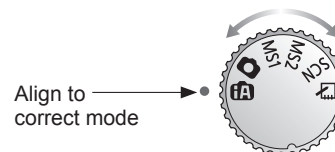

The current mode will be displayed on the LCD monitor when the mode dial is turned.

	INTELLIGENT AUTO Mode	Take images with automatic settings (P.32).
	NORMAL PICTURE Mode	Take images with customized settings (P.35).
MS1 MS2	MY SCN MODE	Taking images in frequently-used scene modes (P.60).
SCN	SCENE MODE	Take images according to scene (P.51).
	CLIPBOARD Mode	Take pictures as memos (P.81).

Basic shooting operation ZS1

Please set the clock before shooting (P.17).

1 Turn on the power
 OFF ON
 Status indicator illuminated for approx. 1 second.

2 Set to
 : Pictures and motion pictures can be taken.
 : The captured pictures and motion pictures can be played back.

3 Set to the desired recording mode
 INTELLECTUAL AUTO

4 Aim the camera and shoot
 (Press the shutter button)

① Press halfway
 (Adjust the focus)

② Press fully
 When recording motion pictures, fully press the shutter button one more time to end recording.

Holding the camera/Direction detection function

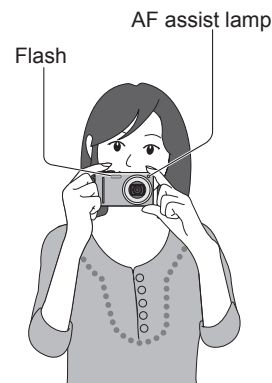

- Stand with your arms close to your body and with your legs apart.
- Do not touch the lens.
- Do not block the microphone when recording audio. (P.12)
- Do not block the flash or the lamp. Do not look at it from close range.
- Pictures taken with camera held vertically can automatically be displayed vertically in playback. (Only when 'ROTATE DISP.' (P.94) is 'ON') Pictures may not be able to be displayed vertically if taken with camera facing upwards or downwards. Motion pictures cannot be displayed vertically during playback.

Mode dial

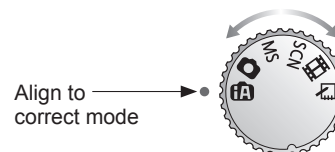

The current mode will be displayed on the LCD monitor when the mode dial is turned.

INTELLIGENT AUTO Mode	Take pictures with automatic settings (P.32).
NORMAL PICTURE Mode	Take pictures with customized settings (P.35).
MS MY SCENE MODE	Taking pictures in frequently-used scene modes (P.60).
SCN SCENE MODE	Take pictures according to scene (P.51).
MOTION PICTURE Mode	Take motion pictures (P.64).
CLIPBOARD Mode	Take pictures as memos (P.81).

Taking picture with automatic settings

'INTELLIGENT AUTO Mode'

Mode: **iA**

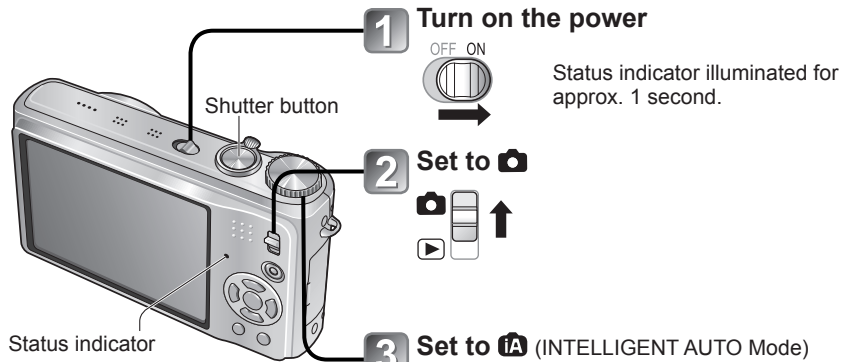

Status indicator

Automatic scene detection

Camera reads scene when pointed at subject, and makes optimum settings automatically.

- During AF tracking (P.34), the optimum scene is automatically selected for the subject where the focus was locked (AF Lock).

Recognizes 'i PORTRAIT'
 Follows face to take clear, bright pictures.

Recognizes 'i SCENERY'
 Takes sharp pictures of near and far landscapes.

Recognizes 'i MACRO'
 Reads distance to take sharp pictures of close subjects

Recognizes 'i NIGHT PORTRAIT'
 Takes bright, natural pictures of people and night scenery. (Only with **SA**)

Recognizes 'i NIGHT SCENERY'
 Uses slow shutter speed to achieve natural coloring. (Only with **SB**)

Recognizes 'i BABY'
 (P.34)

Recognizes movement
 Reads subject movement to avoid blurring when scene does not correspond to any of the above.

4 Take a picture

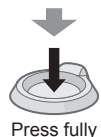

Recognized scene icon displayed in blue for 2 sec.

■ To take motion pictures **ZS3** → (P.61)

Optimum settings are made automatically from information such as 'face', 'movement', 'brightness', and 'distance' just by pointing the camera at the subject, meaning that clear pictures can be taken without the need to make settings manually.

■ Backlight compensation

Backlight refers to the light that shines from behind the subject. When this occurs, the subject appears darker, and so backlighting is automatically corrected by increasing the brightness of the entire image.

■ To use flash



Select either **SA** (Auto) or **SB** (forced flash off).

When using **SA**, **iSA** (AUTO), **iSA** (Auto/red-eye reduction) and **iSB** (Slow sync./red-eye reduction) will be switched between automatically (see P.43 for details). A second flash will be emitted in **iSA** and **iSB** for red-eye reduction.

● Focus range → (P.47).

● In addition to automatic scene detection, 'INTELLIGENT ISO **ISO MAX 1600**', '1.EXPOSURE', and 'BACKLIGHT COMPENSATION' will operate automatically.

● The following menu items may be set in INTELLIGENT AUTO Mode.

- **iA** (REC menu): 'PICTURE SIZE*1', 'BURST', 'COLOR MODE*1', 'FACE RECOG.*1' **ZS3**
- **MOTION PICTURE** menu **ZS3**: 'REC MODE', 'REC QUALITY*1', 'COLOR MODE*1'
- **SETUP** menu*2: 'CLOCK SET', 'WORLD TIME', 'BEEP*1', 'LANGUAGE'

*1 Items that may be set differ from other recording modes.

*2 Other items in the SETUP menu will reflect settings made in other recording modes.

● According to the following conditions, different scene types may be determined for the same subject.

- Face contrast, conditions of subject (size, distance, coloring, movement), zoom ratio, sunset, sunrise, low brightness, jitter

● If desired scene type is not selected, we recommend manually selecting the appropriate recording mode. (Scene Mode: P.51)

● We recommend using a tripod and the self-timer with 'i NIGHT SCENERY' and 'i NIGHT PORTRAIT'.

● When jitter is small (e.g. using tripod) with 'i NIGHT SCENERY', shutter speed can reach a maximum of 8 seconds. Do not move the camera.

● The settings for the following functions are fixed.

- AUTO REVIEW: 2 SEC. • POWER SAVE: 5 MIN. • GUIDE LINE:
- WHITE BALANCE: AWB • QUALITY: (Fine) • STABILIZER: AUTO
- AF MODE: (Face detection)*1 • AF ASSIST LAMP: ON
- METERING MODE: (Multiple) • PRE AF: Q-AF

*1 (11-area-focusing) when face cannot be recognized

● The following functions cannot be used.

- 'HISTOGRAM', 'EXPOSURE', 'AUTO BRACKET', 'MULTI ASPECT' **ZS3**, 'WB ADJUST.', 'DIGITAL ZOOM', 'MIN. SHTR SPEED', 'AUDIO REC.'



e.g. Face too large – 'i PORTRAIT' becomes 'i MACRO'

Taking picture with automatic settings

'INTELLIGENT AUTO Mode' (Continued)

Mode: **IA**

Face Detection and Face Recognition

If the camera automatically identifies the scene and determines that people appear as subjects in the image (**IA** or **IA**), Face Detection is activated, and the focus and exposure are adjusted for the recognized faces. (P.73)

Face Recognition **ZS3**

The faces of people who are taken frequently can be registered together with their names, ages, and other information.

If pictures are taken with 'FACE RECOG.' (P.65) set to 'ON', priority is given to the focus and exposure adjustments of the faces close to those that have been registered. Also, the camera memorizes detected faces during Face Detection, automatically recognizes faces which are taken frequently, and displays them on the face registration screen.

- Face Recognition searches for faces close to those that have been registered. Correct recognition of faces cannot be guaranteed.
- In some cases, the camera may be unable to correctly distinguish between people with similar facial characteristics, such as parents and children and brothers and sisters.
- When using Face Recognition, the facial characteristics are extracted for performing recognition, and so this process takes longer than regular Face Detection.
- For subjects registered as newborns and infants (people with birthdays set to less than 3 years), **IA** is displayed, and the picture will be taken to give the skin a more healthy appearance.

AF TRACKING

Even if a subject where the focus was locked (AF Lock) moves, the camera can continue to keep it in focus.

1 Set AF MODE to AF tracking

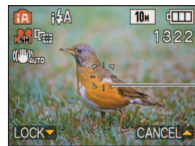

- To cancel AF tracking → Press **▲** again.

AF tracking frame

2 Align the AF tracking frame with the subject, and then lock.

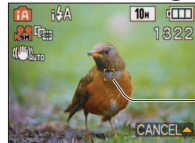

- To cancel AF Lock → Press **▲**.
- The optimum scene is detected for the subject where the focus was locked (AF Lock).

AF Lock successful: Yellow
AF Lock failed: Red (flash)

- Face recognition will be inactive while using AF tracking.
- Please refer to P.73 if AF Lock is not successful for certain objects.

Taking pictures with your own settings

'NORMAL PICTURE Mode'

Mode: **CA**

Using REC menu (P.69) to change settings and set up your own recording environment.

1 Turn on the power
OFF ON
Status indicator illuminated for approx. 1 second.

2 Set to **CA**

3 Set to **CA (NORMAL PICTURE Mode)**

Shutter button
Zoom lever
Status indicator

■ To take motion pictures **ZS3**
→ (P.61)

■ To use zoom
→ (P.37)

■ To use flash
→ (P.43)

■ To adjust image brightness
→ (P.49)

■ To take close-up pictures
→ (P.45)

■ To adjust coloring
→ (P.72)

4 Take a picture

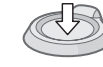

Press halfway
(Adjust the focus)



Focus display
(when focus aligned: flashing
→ illuminated)



Press fully

AF area
(Aligns focus with subject; when
complete: red/white → green)

- When (jitter alert) is displayed, use the optical image stabilizer (P.77), a tripod, or the self-timer (P.48).
- If aperture value or shutter speed is displayed in red, correct exposure has not been achieved. Use flash or change 'SENSITIVITY' (P.71) settings.

Jitter alert display

Aperture value Shutter speed

Taking pictures with your own settings

'NORMAL PICTURE Mode' (Continued)

Mode:

Align focus for desired composition

Useful when subject is not in center of picture.

1 First adjust focus according to subject



Hold down halfway



AF area

- Subjects/environments which may make focusing difficult:
 - Fast-moving or extremely bright objects, or objects with no color contrast.
 - Taking pictures through glass or near objects emitting light. In dark, or with significant jitter.
 - When too close to object or when taking pictures of both distant and close objects together in the same picture.
- We recommend using the 'Face detection' function when taking pictures of people (P.73).

2 Return to desired composition



Press fully



AF area

- The focus display flashes and beep sounds when focus is not aligned. Use the focus range displayed in red (P.47) as a reference. Even if the focus display is lit, the camera may be unable to bring the subject into focus if it is out of range.
- AF area is displayed larger in dark conditions or when using digital zoom.
- Most displays are temporarily cleared from screen when the shutter button is pressed halfway.



Focus display
Focus range
(DMC-ZS3PC/DMC-ZS1PC:
Display in meters)

Taking pictures/motion pictures with zoom

Mode:

You can zoom in up to 12 times with 'optical zoom', and up to 21.4 times with 'Extended optical zoom' (pictures only) with lower picture quality. You can also use 'digital zoom' to zoom in even further.

Do not block the lens barrel movement while zooming.



1 Zoom In/Out

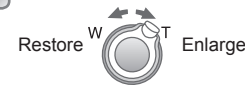

Turn to W side



Turn to T side

Focus range (P.47)
Zoom ratio (approx.)

- Zoom speed can be adjusted. Zoom slowly → turn slightly
Zoom quickly → turn completely
- Adjust the focus after adjusting the zoom.

Optical zoom and extended optical zoom (EZ)

Automatically switches to 'optical zoom' when using maximum picture size (P.69), and to 'extended optical zoom' (for further zooming) otherwise. (EZ is short for 'extended optical zoom'.)

- Optical zoom



Max. enlargement: 12 x

- Extended optical zoom



Max. enlargement: 14.3 x - 21.4 x
(Varies according to picture size.)

Taking pictures/motion pictures with zoom

(Continued)

Mode:

- Maximum zoom ratios by picture size

PICTURE SIZE	Optical zoom			Extended optical zoom		
	10 M	7 M EZ	5 M EZ	3 M EZ	2 M EZ	0.3 M EZ
4:3	10 M	7 M EZ	5 M EZ	3 M EZ	2 M EZ	0.3 M EZ
3:2	9.5 M	6.5 M EZ	4.5 M EZ	3 M EZ	2.5 M EZ	
ZS3	9 M	6 M EZ	4.5 M EZ	2.5 M EZ	2 M EZ	
Max. enlargement	12 x	14.3 x	17.1 x		21.4 x	
PICTURE SIZE	10 M	7 M EZ	5 M EZ	3 M EZ	2 M EZ	0.3 M EZ
3:2	9 M	6 M EZ	4.5 M EZ		2.5 M EZ	
ZS1	7.5 M	5.5 M EZ	3.5 M EZ		2 M EZ	
Max. enlargement	12 x	14.3 x	17.1 x		21.4 x	

- What is Extended optical zoom (EZ)?

If, for example, set to '3M EZ' (equivalent to 3 million pixels), a picture will only be taken of a 3M-sized central part of a 10 M (equivalent to 10.1 million pixels) area, meaning that the picture can be enlarged further.

- The enlargement ratio displayed in the bar on screen is an estimate.
- In certain recording modes, TELE MACRO function (P.45) is activated when maximum zoom ratio is reached.
- A greater degree of distortion may be generated by taking wider-angled pictures of close objects, while using more telescopic zoom may result in more coloring appearing around the outlines of objects.
- The camera may make a rattling noise and vibrate when the zoom lever is operated – this is not a fault.
- When using extended optical zoom, zoom movement may stop momentarily near maximum W (1x), but this is not a fault.
- Extended optical zoom cannot be used in the following cases: 'MACRO ZOOM', motion picture, 'TRANSFORM', 'HIGH SENS.', 'HI-SPEED BURST', 'FLASH BURST', 'PIN HOLE', and 'FILM GRAIN' scene modes
- 'ZOOM RESUME' (P.24) allows zoom ratio to be memorized even if power is turned off.

Enlarging further 'DIGITAL ZOOM'

Zoom 4 times further than optical/extended optical zoom (maximum 48 x – 85.5 x). (Note that, with digital zoom, enlarging will lessen picture quality.)

- 1 Display REC menu

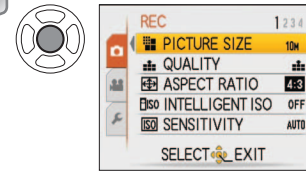

- 3 Select 'ON'

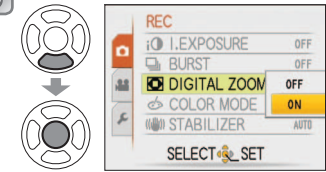

- 2 Select 'DIGITAL ZOOM'

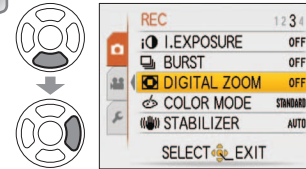

- 4 Finish



Digital zoom area is displayed within zoom bar on screen.

e.g. With 48x

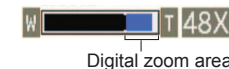

- Zoom motion stops momentarily when entering digital zoom range.
- Within digital zoom range, AF area is displayed larger when the shutter button is pressed halfway.
- We recommend using a tripod and the self-timer (P.48).

- Digital zoom cannot be used in the following modes:

iA (INTELLIGENT AUTO Mode), (CLIPBOARD Mode), Scene Modes ('SPORTS', 'BABY', 'PET', 'HIGH SENS.', 'HI-SPEED BURST', 'FLASH BURST', 'PIN HOLE', and 'FILM GRAIN'), when 'INTELLIGENT ISO' is not set to 'OFF'

Viewing your pictures (NORMAL PLAY)

REC/PLAY switch:

When there is no card inserted, the pictures played back from the built-in memory. (Clipboard pictures can only be played back in CLIPBOARD Mode (P.81).)

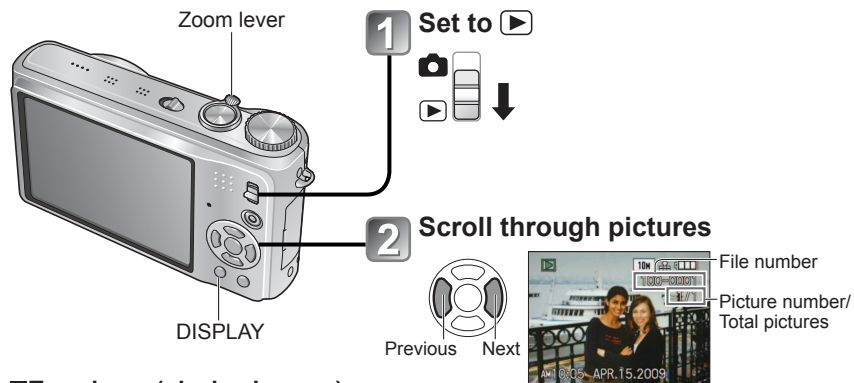

To enlarge (playback zoom)



Current zoom position (displayed for 1 sec.)

- Zoom ratio: 1x/2x/4x/8x/16x
- To reduce zoom → Turn lever towards W side
- Move zoom position → ▲ ▼ ◀ ▶

To playback as list

➔ (P.83)

To view with different playback modes (slideshow, etc.)

➔ (P.85)

To playback motion pictures

➔ (P.84)

- Hold down to quickly scroll forwards/backwards. (Only file numbers change while held down; picture is displayed when released) Scroll speed increases the longer you press. (Speed may vary according to playback conditions)
- If file number is not displayed, press display button.
- After the final picture, display returns to the first picture.
- Some pictures edited on computer may not be able to be viewed on this camera.
- If the REC/PLAY switch is moved from to while the power is on, the lens barrel will be retracted after approx. 15 seconds.
- This camera is compliant with the unified DCF (Design rule for Camera File system) standard formulated by the Japan Electronics and Information Technology Industries Association (JEITA), and with Exif (Exchangeable image file format). Files that are not DCF-compliant cannot be played back.

Deleting pictures

REC/PLAY switch:

Pictures deleted will be from card if card is inserted, or from built-in memory if the card is not inserted. Deleted pictures cannot be recovered.

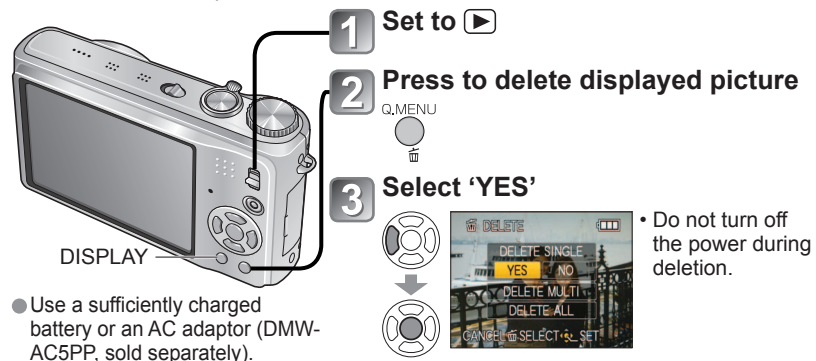

- Use a sufficiently charged battery or an AC adaptor (DMW-AC5PP, sold separately).

• Do not turn off the power during deletion.

To delete multiple (up to 50) or all pictures

(after step 2)

3 Select type of deletion



- To use 'DELETE ALL' → go to step 6

4 Select the pictures to delete (Repeat)

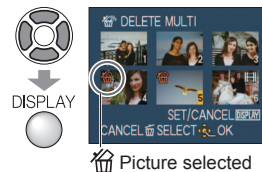

- To release → Press DISPLAY again

5 Delete



6 Select 'YES'

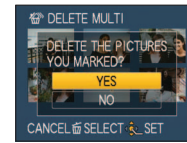

- To cancel → press 'MENU/SET'.
- May take time depending on number of pictures deleted.
- 'ALL DELETE EXCEPT ★ (FAVORITE)' may be selected in 'DELETE ALL' when 'FAVORITE' is set to 'ON' (P.95) and pictures have been registered.

- Pictures cannot be deleted in the following cases:
 - Protected pictures (P.97)
 - Card switch is in 'LOCK' position. • Pictures not of DCF standard (P.40)
- Motion pictures can also be deleted.
- To delete clipboard pictures, set mode dial to .
- To delete all data including protected images, perform FORMAT. (P.26)

Changing recording information display

Change between different LCD monitor displays, such as histograms.

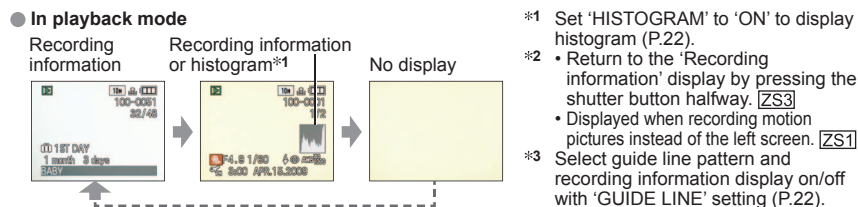
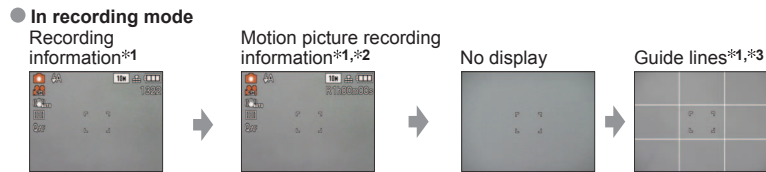

Histogram

Displays distribution of brightness in picture – e.g. if the graph peaks at the right, this means there are several bright areas in the picture. (Guide) A peak in the center represents correct brightness (correct exposure). This can be used as a reference for exposure correction (P.49), etc.

- Histogram from time of recording is different to histogram in playback and displayed in orange, when recording with flash or in dark locations. Also, histogram may differ from histograms made with image editing software.
- Histograms cannot be displayed in [IA] (INTELLIGENT AUTO Mode), [C] (CLIPBOARD Mode), MULTI ASPECT [ZS3], or during playback zoom.
- This is not displayed during motion picture recording.

Guide lines

- Reference for composition (e.g. balance) when recording.
- INTELLIGENT AUTO Mode and CLIPBOARD Mode display [] only.
- This is not displayed in 'MULTI ASPECT' Mode. [ZS3]



- During playback zoom, motion picture playback, slideshow: Display on/off
- During menu display, multi playback or calendar playback: Display cannot be changed.

Taking pictures with flash

Mode: [ZS3] [IA] [MS1MS2 SCN] [ZS1] [IA] [MS SCN]

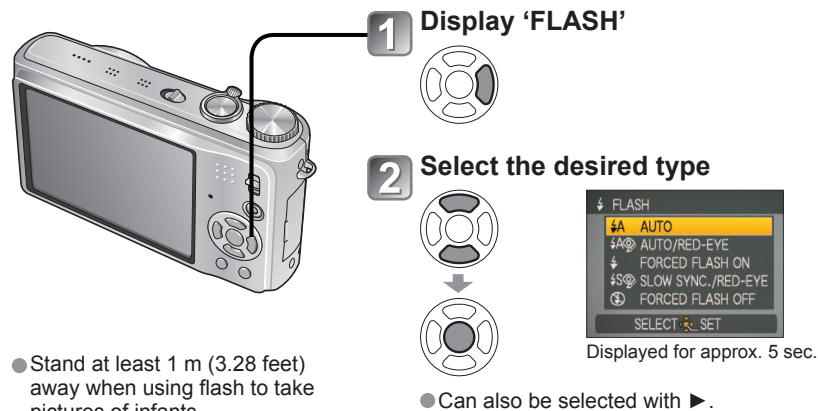

- Stand at least 1 m (3.28 feet) away when using flash to take pictures of infants.

Type, operations	Uses
[IA] AUTO • Automatically judges whether or not to flash	Normal use
[IA] [A] AUTO/RED-EYE reduction*<!--1</b--> • Automatically judges whether or not to flash (reduce red-eye)	Taking pictures of subjects in dark places
[IA] [F] FORCED FLASH ON • Always flash	Taking pictures with backlight or under bright lighting (e.g. fluorescent)
[IA] [F] [E] FORCED ON/RED-EYE reduction*<!--1</b--> (For 'PARTY' and 'CANDLE LIGHT' scene modes only (P.54)) • Always flash (reduce red-eye)	Taking pictures of subjects against a nightscape (tripod recommended)
[IA] [S] [E] SLOW SYNC./RED-EYE reduction*<!--1</b--> • Automatically judges whether or not to flash (reduce red eye; slow shutter speed to take brighter pictures)	Taking pictures of subjects against a nightscape (tripod recommended)
[IA] [F] [O] FORCED FLASH OFF • Never flash	Places where flash use is prohibited

*1 When **digital red-eye correction** function operates, red-eye will be detected and corrected automatically when the flash is emitted. As two flashes will be emitted, do not move until after the second flash (correction effect may vary according to person). Interval between flashes varies according to brightness of subject.

- Shutter speeds are as follows:
 - [IA], [IA] [A], [F], [F] [E]: 1/30*2 - 1/2000th
 - [S] [E], [S] [E] [O]: 1/8*2,*3 - 1/2000th

*2 Varies according to 'MIN. SHTR SPEED' setting.
 *3 Max. 1/4 sec. when 'INTELLIGENT ISO' in use; max. 1 sec. when 'STABILIZER' set to 'OFF' or when blur is insignificant. Also varies according to 'INTELLIGENT AUTO' Mode, 'SCENE MODE', zoom position.

Taking pictures with flash (Continued)

Mode: **ZS3** **iA** **MS1MS2 SCN**

Available types in each mode (□: default setting)

	SCENE MODE															
	□	□	□	□	□	□	□	□	□	□	□	□	□	□	□	□
iA	○	○*	○	○	○	○	○	○	○	○	○	○	○	○	○	○
iA	○	—	—	○	○	○	○	○	○	○	○	○	○	○	○	○
⚡	○	—	○	○	○	○	○	○	○	○	○	○	○	○	○	○
⚡	—	—	—	—	—	—	—	—	—	—	—	—	—	—	—	—
iS	○	—	—	—	—	—	—	—	—	—	—	—	—	—	—	—
⌚	○	○	○	○	○	○	○	○	○	○	○	○	○	○	○	○

* Set to **iA** (AUTO), **iA** (AUTO/RED-EYE reduction), or **iS** (SLOW SYNC./RED-EYE reduction) according to subject and brightness.

The flash cannot be used when recording motion pictures, scene mode, **⌚**, **⌚**, **⌚**, **⌚** or **⌚**.

Focus range according to ISO sensitivity and zoom

		Focus range	
		Max. W	Max. T
SENSITIVITY (P.71)	AUTO	Approx. 0.6-5.3 m (1.97-17.4 feet)	Approx. 1.0-3.6 m (3.28-11.8 feet)
	ISO80	Approx. 0.6-1.5 m (1.97-4.92 feet)	Approx. 1.0m (3.28 feet)
	ISO100	Approx. 0.6-1.6 m (1.97-5.25 feet)	Approx. 1.0-1.1 m (3.28-3.61 feet)
	ISO200	Approx. 0.6-2.3 m (1.97-7.55 feet)	Approx. 1.0-1.6 m (3.28-5.25 feet)
	ISO400	Approx. 0.6-3.3 m (1.97-10.8 feet)	Approx. 1.0-2.2 m (3.28-7.22 feet)
	ISO800	Approx. 0.8-4.7 m (2.62-15.4 feet)	Approx. 1.0-3.2 m (3.28-10.5 feet)
INTELLIGENT ISO (P.70)	ISO1600	Approx. 1.15-6.7 m (3.77-22.0 feet)	Approx. 1.0-4.5 m (3.28-14.8 feet)
	ISOMAX400	Approx. 0.6-3.3 m (1.97-10.8 feet)	Approx. 1.0-2.2 m (3.28-7.22 feet)
	ISOMAX800	Approx. 0.8-4.7 m (2.62-15.4 feet)	Approx. 1.0-3.2 m (3.28-10.5 feet)
ISOMAX1600	Approx. 1.15-6.7 m (3.77-22.0 feet)	Approx. 1.0-4.5 m (3.28-14.8 feet)	
'HIGH SENS.' in SCENE MODE (P.56)	ISO1600-ISO6400	Approx. 1.15-13.5 m (3.77-44.3 feet)	Approx. 1.0-9.1 m (3.28-29.9 feet)
'FLASH BURST' in SCENE MODE (P.57)	ISO100-ISO3200	Approx. 0.6-3.4 m (1.97-11.2 feet)	Approx. 1.0-2.3 m (3.28-7.55 feet)

- Do not touch or look at the flash (P.12) from close distances (i.e. a few cm). Do not use the flash at close distances to other subjects (heat/light may damage subject).
- Flash settings may be changed when changing recording mode.
- Scene mode flash settings are restored to default when scene mode is changed.
- Edges of picture may become slightly dark if using flash at short distances without using zoom (close to max. W). This may be remedied by using a little zoom.
- If flash is to be emitted, flash type marks (e.g. **⚡**) will turn red when shutter button is pressed halfway.
- No pictures may be taken if these marks (e.g. **⚡**) are flashing (flash is charging).
- Insufficient flash reach may be due to inadequately set exposure or white balance.
- Flash effect may not be fully achieved with high shutter speeds.
- Flash charging may take time if battery is low, or if using flash repeatedly.

Taking close-up pictures/motion pictures

Mode: **ZS3** **⌚** **ZS1**

When you want to enlarge the subject, setting to 'AF MACRO (AF)' enables you to take images at an even closer distance than the normal focus range (up to 3 cm (0.10 feet) for max. W).

- Display 'MACRO MODE'
- Select 'AF MACRO'
- Take an image

Displayed for approx. 5 sec.

AF tracking display

- Focus may take time to align for subjects over 50 cm (1.64 feet) away.
- When using **iA** (INTELLIGENT AUTO Mode), macro recording can be activated by just pointing the camera at subject. (⌚ display)
- AF MACRO automatically activates when AF MODE is set to **⌚** (AF tracking). (AF is not displayed.)

Taking close-up images without standing close to subject

TELE MACRO function

Useful for taking close-up pictures of, for example, birds that may fly away if approached, or to blur background and emphasize subject.

'TELE MACRO' operates automatically when optical or extended zoom optical ratios are close to the maximum T setting (10x or above for optical zoom). The focus can be aligned for distances as close as 1m.

Turn to max. T

AF changes to TELE

- Digital zoom may also be used.
- This function also operates when taking pictures in the following scene modes: 'FOOD', 'CANDLE LIGHT', 'BABY', 'HIGH SENS.', 'UNDERWATER', 'PET', 'HI-SPEED BURST', 'FLASH BURST', 'PIN HOLE', 'FILM GRAIN'

Taking close-up pictures/motion pictures

(Continued)

Mode:

Taking images at even closer range 'MACRO ZOOM'

To take even larger images of the subject, setting to 'MACRO ZOOM' enables the subject to appear even larger than when using AF MACRO.

- 1 Display 'MACRO MODE'**

Zoom lever
- 2 Select 'MACRO ZOOM'**

Displayed for approx. 5 sec.
- 3 Adjust the digital zoom magnification with the zoom lever**

The zoom position is fixed at the Wide end.
Focus range is 3 cm (0.10 feet) - ∞.

Digital zoom magnification (1x to 3x)
- 4 Take an image**

- In MACRO ZOOM, higher magnification results in lower picture quality.
- When set to MACRO ZOOM, extended optical zoom is canceled.
- MACRO ZOOM setting cannot be used while recording in 'MULTI ASPECT' mode.
- We recommend using a tripod, the self-timer (P.48), and flash 'FORCED FLASH OFF' (P.43).
- Moving the camera after aligning the focus is likely to result in poorly focused pictures if subject is close to camera, due to margin for focus alignment being severely reduced.
- Resolution may be reduced around the edges of the picture.

Positioning camera and subject within accessible range for focus alignment

■ Focus range for (NORMAL PICTURE Mode)

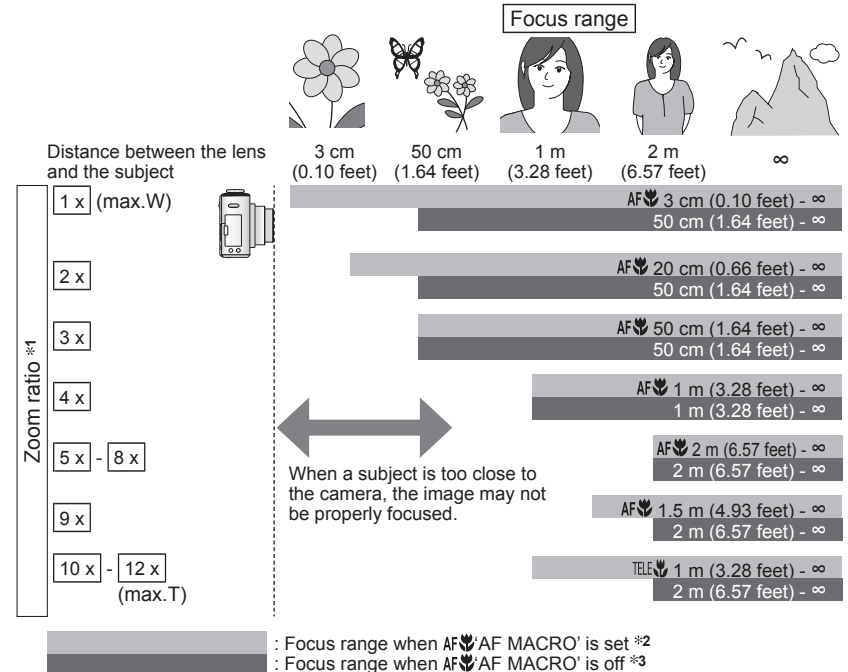

- *1 Focus range varies depending on the zoom ratio.
- *2 The focus range is identical under the following settings.
 - (INTELLIGENT AUTO Mode) • (CLIPBOARD Mode)
 - FOOD, CANDLE LIGHT, BABY, HIGH SENS., UNDERWATER, PET, HI-SPEED BURST, PIN HOLE, FILM GRAIN in Scene Mode
 - When set to AF (AF MACRO) in (MOTION PICTURE Mode)
- *3 The focus range is identical under the following settings.
 - PORTRAIT, SOFT SKIN, TRANSFORM, PANORAMA ASSIST, SPORTS, PARTY, SUNSET, STARRY SKY, BEACH, SNOW in Scene Mode
 - When not set to AF (AF MACRO) in (MOTION PICTURE Mode)

- Zoom ratios are approximate.
- Ranges for focus alignment differ for scene modes.
- Zoom ratios shown above vary when extended optical zoom is used.
- Max. W: Zoom lever turned as far as possible to W side (no zoom)
Max. T: Zoom lever turned as far as possible to T side (maximum zoom ratio)

Taking images with self-timer

Mode:

We recommend using a tripod. This is also effective for correcting jitter when pressing the shutter button, by setting the self timer to 2 seconds.

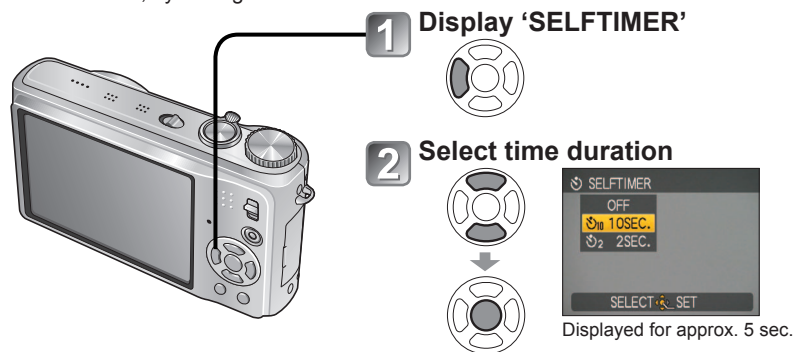

1 Display 'SELFTIMER'

2 Select time duration

Displayed for approx. 5 sec.

● Can also be selected with ◀.

3 Take an image

Press fully the shutter button to start recording after the preset time.



• To cancel while in operation
→ Press 'MENU/SET'



Self-timer indicator
(Flashes for set duration)

- When set to BURST, three pictures are taken. When set to the 'FLASH BURST' scene mode, five pictures are taken.
- Focus will be automatically adjusted immediately before recording if shutter button is pressed fully here.
- After self-timer lamp stops flashing, it may then be lit for AF assist lamp.
- This function cannot be used in the 'UNDERWATER' and 'HI-SPEED BURST' scene modes, or in (MOTION PICTURE Mode) .
- In some modes, only '2SEC.' or only '10SEC.' may be selected.
INTELLIGENT AUTO Mode: '10SEC.'
CLIPBOARD Mode, 'SELF PORTRAIT' scene mode: '2SEC.'

Taking pictures/motion pictures with exposure compensation

Mode:

* EXPOSURE only

Corrects exposure when adequate exposure cannot be obtained (if difference between brightness of object and background, etc.). Depending on the brightness, this may not be possible in some cases.

EXPOSURE

1 Display 'EXPOSURE'

2 Select a value

'0' (no compensation)

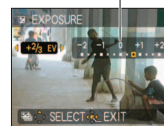

● Example of exposure compensation



Over-exposed

↓ Minus direction



Optimum exposure

↑ Plus direction



Under-exposed

AUTO BRACKET (Pictures only)

Takes 3 pictures in succession, changing the exposure. After exposure compensation, the compensation value is as standard.

1 Display 'AUTO BRACKET'

Press ▲ twice to switch 'EXPOSURE' to 'AUTO BRACKET'.

2 Select a value

'0' (no compensation)

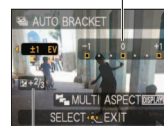

Value displayed after exposure compensation set

● e.g. AUTO BRACKET with ±1EV



First picture
0EV
(Standard)



Second picture
-1EV
(Darker)



Third picture
+1EV
(Brighter)

- Cannot be used with flash or when there is remaining capacity for only 2 more pictures.
- When 'AUTO BRACKET' is set, is displayed on the left of the screen.
- Canceled when the power is turned off.
- When AUTO BRACKET is set, 'MULTI ASPECT' and 'BURST' are canceled.
- AUTO BRACKET cannot be set in 'TRANSFORM', 'PANORAMA ASSIST', 'HI-SPEED BURST', 'FLASH BURST', 'STARRY SKY', 'PIN HOLE', and 'FILM GRAIN' scene modes.
- Exposure compensation cannot be used with the 'STARRY SKY' scene mode.

Taking pictures by automatically changing the aspect ratio 'MULTI ASPECT' [ZS3]

Mode: MS1MS2 SCN

In this mode, pressing the shutter button once automatically takes three pictures in each of three aspect ratios: 4:3, 3:2, and 16:9. (The shutter sound is made only once.)

1 Display 'AUTO BRACKET'



Press twice to switch 'EXPOSURE' to 'AUTO BRACKET'.

2 Display 'MULTI ASPECT'



Each time 'DISPLAY' is pressed, the displayed indicator switches between 'AUTO BRACKET' and 'MULTI ASPECT'.

3 Select 'ON' and set.

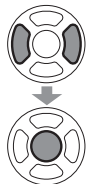

display

Picture size combinations

4:3	3:2	16:9
10M	9.5M	9M
7M	6.5M	6M
5M	4.5M	4.5M
3M*	3M*	2.5M*

(Example)
when **3:2** is set to 6.5M, the image sizes and corresponding resolutions are **4:3** with 7M, **3:2** with 6.5M, and **16:9** with 6M.

*If a smaller picture size is set, the resolution is temporarily set to this value.

- After MULTI ASPECT is set, is displayed on the left side of the screen.
- Shutter speed, aperture, focus, 'EXPOSURE', 'WHITE BALANCE', and 'SENSITIVITY' settings will be constant for all three pictures.
- MULTI ASPECT is disabled when the number of recordable pictures is two or less. It is also canceled when the power is turned off.
- When MULTI ASPECT is set, AUTO BRACKET and BURST are canceled.
- MULTI ASPECT cannot be set in the 'TRANSFORM', 'PANORAMA ASSIST', 'HIGH SENS.', 'HI-SPEED BURST', 'FLASH BURST', 'STARRY SKY', 'PIN HOLE', and 'FILM GRAIN' scene modes.

Taking pictures according to the scene 'SCENE MODE'

Mode: [ZS3] MS1MS2 SCN [ZS1] MS SCN

Using SCENE MODE enables you to take pictures with optimum settings (exposure, coloring, etc.) for given scenes.

- 1 Set to**
- 2 Set to 'SCN' (SCENE MODE)**
- 3 Select scene**
(Press 'MENU/SET' and then press , if scene menu is not displayed)

Zoom lever

DISPLAY

MENU/SET

SCENE MENU

Zoom lever can also be used to switch to next screen.

To see description of each scene:
Select scene, and press display button.

To take motion pictures [ZS3]

➔ (P.61)

Setting frequently-used scenes to the mode dial

➔ MY SCN MODE [ZS3] (P.60)

➔ MY SCENE MODE [ZS1] (P.60)

- Selecting a scene mode inappropriate for the actual scene may affect the coloring of your picture.
- Following REC menu settings will be automatically adjusted and cannot be selected manually (available settings vary according to scene setting).
'INTELLIGENT ISO', 'SENSITIVITY', 'METERING MODE', 'I.EXPOSURE', 'COLOR MODE', 'MIN. SHTR SPEED'
- 'I.EXPOSURE' is operated automatically in the following scene modes, according to picture conditions.
'PORTRAIT', 'SOFT SKIN', 'TRANSFORM', 'SELF PORTRAIT', 'SCENERY', 'SPORTS', 'NIGHT PORTRAIT', 'PARTY', 'CANDLE LIGHT', 'BABY', 'SUNSET', 'HIGH SENS.', 'FLASH BURST', 'BEACH'
- 'WHITE BALANCE' can be set to the following.
'PORTRAIT', 'SOFT SKIN', 'TRANSFORM', 'SELF PORTRAIT', 'PANORAMA ASSIST (First picture only)', 'SPORTS', 'BABY', 'PET', 'HIGH SENS.', 'HI-SPEED BURST', 'PIN HOLE' (Setting is restored to 'AWB' when scene is changed.)
- The types of flash available (P.44) vary according to the scene.
The scene mode flash setting is reset to the default setting when the scene mode is changed.
- Guidelines displayed in gray in 'NIGHT PORTRAIT', 'NIGHT SCENERY', 'STARRY SKY', and 'FIREWORKS' scene modes.











Taking pictures according to the scene







'SCENE MODE' (Continued)

Mode: **ZS3** MS1MS2 SCN **ZS1** MS SCN

How to select a scene (P.51)

Using flash in scene modes (P.44)

Scene	Uses, Tips	Notes
 PORTRAIT	<p>Improves the skin tone of subjects for a healthier appearance in bright daylight conditions.</p> <p>Tips</p> <ul style="list-style-type: none"> Stand as close as possible to subject. Zoom: As telescopic as possible (T side) 	<ul style="list-style-type: none"> 'AF MODE' default setting is  (face detection).
 SOFT SKIN	<p>Smooths skin colors in bright, outdoor daylight conditions (portraits from chest upwards).</p> <p>Tips</p> <ul style="list-style-type: none"> Stand as close as possible to subject. Zoom: As telescopic as possible (T side) 	<ul style="list-style-type: none"> Clarity of effect may vary depending on brightness. 'AF MODE' default setting is  (face detection).
 TRANSFORM	<p>Changes the subject to a slim-looking or glamorous appearance.</p> <p>① Use ▲▼ to select the transform level, and press 'MENU/SET' to set.</p>  <p>② Take the picture.</p> <p>Notes</p> <ul style="list-style-type: none"> This function can be used for personal use only, and is not to be used for unauthorized commercial purposes or commercial gain, which would represent a copyright. Do not use in ways that violate public order and decency or defame or slander others. Do not use in ways that harm the subject. 	<ul style="list-style-type: none"> When taking a picture, a process is performed that improves the skin appearance. The picture quality becomes slightly lower. 'PICTURE SIZE' will be fixed according to the 'ASPECT RATIO' setting, as detailed below. 4:3 : 3 M 3:2 : 2.5 M 16:9 : 2 M The following function is fixed. QUALITY:  (Standard) 'AF MODE' default setting is  (face detection). Face recognition may not work as effectively when using 'SLIM HIGH' or 'STRETCH HIGH'. The following functions cannot be used. Extended optical zoom/Digital zoom/AUTO BRACKET/MULTI ASPECT ZS3 /BURST
 SELF PORTRAIT	<p>Take pictures of yourself.</p>  <p>Tips</p> <ul style="list-style-type: none"> Press shutter button halfway → self-timer indicator illuminates → press shutter button fully → review (if self-timer indicator flashes, focus is not correctly aligned) Focus: 30 cm - 1.2 m (0.98 - 3.94 feet) (Max. W) Do not use zoom (harder to focus). (Zoom moved to max. W automatically) 2-second self-timer (P.48) recommended. 	<ul style="list-style-type: none"> To take pictures with audio (P.78) (self-timer indicator illuminated during recording) Main fixed settings STABILIZER: MODE2 AF ASSIST LAMP: OFF SELFTIMER: OFF/2SEC. ZOOM RESUME: OFF 'AF MODE' default setting is  (face detection).

Scene	Uses, Tips	Notes
 SCENERY	<p>Takes clear pictures of wide, distant subjects.</p> <p>Tips</p> <ul style="list-style-type: none"> Stand at least 5 m (16.4 feet) away. <p>Use the supplied software to join multiple pictures into a single panorama photograph.</p> <p>① Use ▲▼ to select the recording direction, and press 'MENU/SET' to set. Special panorama guidelines will be displayed.</p> <p>② Take the picture.</p> <p>③ Select 'NEXT', and press 'MENU/SET' to set.</p>  <ul style="list-style-type: none"> Alternatively, press the shutter button. You can take pictures again by selecting 'RETAKE'. <p>④ Change the composition and take the picture so that a part of the picture overlaps with the previous picture.</p>  <p>Section of picture that was taken last time</p> <p>⑤ After you finish taking pictures, select 'EXIT', and press 'MENU/SET' to set.</p> <p>Tips</p> <ul style="list-style-type: none"> Do not change your recording location. Use a tripod. 	<ul style="list-style-type: none"> Main fixed settings FLASH:  FORCED FLASH OFF AF ASSIST LAMP: OFF The focus, zoom, exposure compensation, white balance, shutter speed, and ISO sensitivity are all fixed at the setting for the first picture. Interference may be noticeable with dark scenes. Shutter may remain closed for up to 8 seconds after taking picture. Main fixed settings FLASH:  FORCED FLASH OFF SENSITIVITY: ISO80 - 800 Panorama photo stitching cannot be performed by this camera. The pictures that are taken are made into a panorama photo on your computer using the software on the supplied CD-ROM (ArcSoft Panorama Maker). The following functions cannot be used. AUTO BRACKET/MULTI ASPECT ZS3 /AUDIO REC./BURST
 PANORAMA ASSIST	<p>Takes pictures of scenes with fast movement, e.g. sports.</p> <p>Tips</p> <ul style="list-style-type: none"> Stand at least 5 m (16.4 feet) away. 	<ul style="list-style-type: none"> Main fixed setting INTELLIGENT ISO: ISOMAX1600 Digital zoom: Cannot be set

Taking pictures according to the scene

'SCENE MODE' (Continued)

Mode: MS1MS2 SCN MS SCN

How to select a scene (P.51)

Using flash in scene modes (P.44)

Scene	Uses, Tips	Notes
NIGHT PORTRAIT	<p>Takes pictures of people and nightscapes with close to actual brightness.</p> <p>Tips</p> <ul style="list-style-type: none"> Use flash. Subject should not move. Tripod, self-timer recommended. Stand at least 1.5 m (4.93 feet) away at the Wide end (wide-angle) Focus: Max. W: 80 cm (2.63 feet) Max. T: 1.2 m (3.94 feet) - 5 m (16.4 feet) 	<ul style="list-style-type: none"> Interference may be noticeable with dark scenes. Shutter may remain closed for 8 second after taking picture. Main fixed setting PRE AF: OFF 'AF MODE' default setting is (face detection).
NIGHT SCENERY	<p>Takes clear pictures of night scenes.</p> <p>Tips</p> <ul style="list-style-type: none"> Stand at least 5 m (16.4 feet) away. Do not move for 8 seconds. (Shutter speed: max. 8 sec. if there is a little jitter, or using tripod, or optical image stabilizer is 'OFF') Tripod, self-timer recommended 	<ul style="list-style-type: none"> Interference may be noticeable with dark scenes. Shutter may remain closed for up to 8 seconds after taking picture. Main fixed settings FLASH: FORCED FLASH OFF PRE AF: OFF AF ASSIST LAMP: OFF SENSITIVITY: ISO80 - 800
FOOD	<p>Takes natural-looking pictures of food.</p> <p>Tips</p> <ul style="list-style-type: none"> Focus: Max. W: 3 cm (0.10 feet) and above Max. T: 1 m (3.28 feet) and above (2 m (6.57 feet) and above unless max.T) 	-
PARTY	<p>Brighten subjects and background in pictures of indoor events, such as weddings.</p> <p>Tips</p> <ul style="list-style-type: none"> Stand approx. 1.5 m (4.93 feet) away. Zoom: Wide (W side) Use flash. Tripod, self-timer recommended. 	<ul style="list-style-type: none"> 'AF MODE' default setting is (face detection).
CANDLE LIGHT	<p>Brings out the atmosphere of a candlelit room.</p> <p>Tips</p> <ul style="list-style-type: none"> Focus: Max. W: 3 cm (0.10 feet) and above Max. T: 1 m (3.28 feet) and above (2 m (6.57 feet) and above unless max.T) Do not use flash. Tripod, self-timer recommended. (Shutter speed: max. 1 sec.) 	<ul style="list-style-type: none"> 'AF MODE' default setting is (face detection).

Scene	Uses, Tips	Notes
BABY	<p>Uses weak flash to bring out skin colors.</p> <ul style="list-style-type: none"> To record age and name ('BABY1' and 'BABY2' can be set separately.)  <p>Tips</p> <ul style="list-style-type: none"> Make sure 'AGE' and 'NAME' are 'ON' before taking a picture. To reset: Select 'RESET' from SETUP menu. Focus: Max. W: 3 cm (0.10 feet) and above Max. T: 1 m (3.28 feet) and above (2 m (6.57 feet) and above unless max.T) 	<ul style="list-style-type: none"> Age and name will be displayed for approx. 5 seconds after setting this mode. Age display format depends on LANGUAGE setting. 'AGE' and 'NAME' print setting can be made on your computer using the supplied CD-ROM (PHOTOfunSTUDIO). Text may also be stamped onto the picture using 'TEXT STAMP' (P.90). Date of birth will be displayed as '0 month 0 day'. Main fixed setting INTELLIGENT ISO: ISOMAX1600 'AF MODE' default setting is (face detection). Digital zoom: Cannot be set Name cannot be recorded when 'LOCATION' is set in 'TRAVEL DATE'.
PET	<p>Records pet's age and name when taking pictures.</p> <p>Tips</p> <ul style="list-style-type: none"> Same as for 'BABY' 	<ul style="list-style-type: none"> Main fixed setting INTELLIGENT ISO: ISOMAX1600 Default settings are as follows. AF MODE: (AF tracking) AF ASSIST LAMP: OFF Refer to 'BABY' (above) for other notes and fixed functions.
SUNSET	<p>Takes clear pictures of scenes such as sunsets.</p>	<ul style="list-style-type: none"> Main fixed settings FLASH: FORCED FLASH OFF AF ASSIST LAMP: OFF





Taking pictures according to the scene





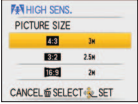

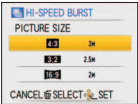

'SCENE MODE' (Continued)

Mode: **ZS3** MS1MS2 SCN **ZS1** MS SCN

How to select a scene (P.51)

Using flash in scene modes (P.44)

Scene	Uses, Tips	Notes										
 HIGH SENS.	<p>Prevents blurring of subject in dark, indoor conditions.</p> <p>Select the aspect ratio and the picture size with ▲▼ and press 'MENU/SET'.</p>  <p>Tips</p> <ul style="list-style-type: none"> Focus: Max. W: 3 cm (0.10 feet) and above Max. T : 1 m (3.28 feet) and above (2 m (6.57 feet) and above unless max.T) 	<ul style="list-style-type: none"> Pictures may appear slightly grainy due to high sensitivity. Main fixed settings QUALITY:  (Standard) SENSITIVITY: ISO1600 - 6400 The following functions cannot be used. Extended optical zoom/DIGITAL ZOOM/AUTO BRACKET/MULTI ASPECT ZS3 										
 HI-SPEED BURST	<p>Takes pictures of rapid movement or a decisive moment.</p> <ol style="list-style-type: none"> Use ▲▼ to select 'SPEED PRIORITY' or 'IMAGE PRIORITY', and press 'MENU/SET' to set. Select the aspect ratio and the picture size with ▲▼ and press 'MENU/SET'.  <ol style="list-style-type: none"> Take pictures. (Hold shutter button) Still pictures are taken continuously while the shutter button is pressed fully. <table border="1"> <tr> <td rowspan="2">Maximum speed*</td> <td>Speed priority</td> <td>Approx. 10 pictures/sec</td> </tr> <tr> <td>Image priority</td> <td>Approx. 6 pictures/sec ZS3 Approx. 7 pictures/sec ZS1</td> </tr> <tr> <td rowspan="2">Number of recordable pictures*</td> <td>Built-in memory</td> <td>Approx. 15 or more</td> </tr> <tr> <td>Card</td> <td>Approx. 15 to 100 (The maximum is 100).</td> </tr> </table> <p>* The burst speed and number of recordable pictures change according to the recording conditions or types of cards.</p> <p>Tips</p> <ul style="list-style-type: none"> Focus: Max. W: 3 cm (0.10 feet) and above Max. T : 1 m (3.28 feet) and above (2 m (6.57 feet) and above unless max.T) 	Maximum speed*	Speed priority	Approx. 10 pictures/sec	Image priority	Approx. 6 pictures/sec ZS3 Approx. 7 pictures/sec ZS1	Number of recordable pictures*	Built-in memory	Approx. 15 or more	Card	Approx. 15 to 100 (The maximum is 100).	<ul style="list-style-type: none"> The number of burst recording pictures increases immediately after formatting. The recorded pictures become slightly grainy. Main fixed settings FLASH:  FORCED FLASH OFF QUALITY:  (Standard) SENSITIVITY: Speed priority ISO200 - 1600 Image priority ISO500 - 800 The focus, zoom, exposure, white balance, shutter speed and ISO sensitivity are fixed to the settings for the first picture. The following functions cannot be used. Extended optical zoom/ Digital zoom/ AUTO BRACKET/ MULTI ASPECT ZS3 / SELF TIMER/ AUDIO REC./ BURST If recording is repeated, depending on the usage conditions, there may be a delay before the camera takes pictures again.
Maximum speed*	Speed priority		Approx. 10 pictures/sec									
	Image priority	Approx. 6 pictures/sec ZS3 Approx. 7 pictures/sec ZS1										
Number of recordable pictures*	Built-in memory	Approx. 15 or more										
	Card	Approx. 15 to 100 (The maximum is 100).										

Scene	Uses, Tips	Notes
 FLASH BURST	<p>Enables continuous recording in dim locations.</p> <ol style="list-style-type: none"> Use ▲▼ to select the picture size and aspect ratio, and press 'MENU/SET' to set.  <ol style="list-style-type: none"> Take pictures (Hold shutter button). Pictures are taken continuously while the shutter button is held down. Number of continuous shots: Max. 5 <p>Tips</p> <ul style="list-style-type: none"> Use within the effective range of the flash. (P.44) 	<ul style="list-style-type: none"> The picture quality slightly decreases. The following functions are fixed. FLASH:  (FORCED FLASH ON) QUALITY:  (Standard) INTELLIGENT ISO: ISOMAX 3200 The focus, zoom, exposure compensation, shutter speed, and ISO sensitivity are all fixed at the setting for the first picture. The following functions cannot be used. Extended optical zoom/Digital zoom/AUTO BRACKET/MULTI ASPECT ZS3/AUDIO REC./ BURST See also P.44.
 STARRY SKY	<p>Takes clear pictures of starry skies or dark subjects.</p> <ul style="list-style-type: none"> Shutter speed settings <ol style="list-style-type: none"> Select with ▲▼, and press 'MENU/SET'.  <ul style="list-style-type: none"> The number of seconds can be changed with Quick menu. (P.20) Press shutter button.  <p>Countdown begins</p> <p>Tips</p> <ul style="list-style-type: none"> Set longer shutter speeds for darker conditions. Always use a tripod. Self-timer recommended. Do not move the camera until the countdown (above) has ended. (Countdown for processing is redisplayed afterwards) 	<ul style="list-style-type: none"> Main fixed settings FLASH:  FORCED FLASH OFF AUDIO REC.: OFF PRE AF: OFF STABILIZER: OFF SENSITIVITY: ISO80 The following functions cannot be used. BURST/EXPOSURE/AUTO BRACKET/MULTI ASPECT ZS3/ AUDIO REC.





Taking pictures according to the scene



'SCENE MODE' (Continued)

Mode: **[ZS3]** MS1MS2 SCN **[ZS1]** MS SCN

How to select a scene (P.51)

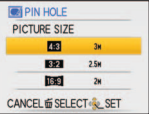
Using flash in scene modes (P.44)

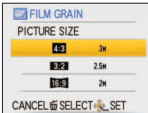
Scene	Uses, Tips	Notes
 FIREWORKS	<p>Takes clear pictures of fireworks in the night sky.</p> <p>Tips</p> <ul style="list-style-type: none"> Stand at least 10 m (32.8 feet) away. Tripod recommended. 	<ul style="list-style-type: none"> Shutter speed can be set to 1/4 second or 2 seconds (if there is a little jitter or if optical image stabilizer is 'OFF'). (when not using exposure compensation) Main fixed settings FLASH: [ZS] FORCED FLASH OFF SENSITIVITY: ISO80 PRE AF: OFF AF ASSIST LAMP: OFF
 BEACH	<p>Brings out the clear blues of the sky and the sea without darkening subject.</p>	<ul style="list-style-type: none"> 'AF MODE' default setting is [AF] (face detection). Do not touch camera with wet hands. Beware of sand and sea water.
 SNOW	<p>Brings out the natural color of snow in ski slope and mountain scenes.</p>	<ul style="list-style-type: none"> Battery life is reduced in lower air temperatures.
 AERIAL PHOTO	<p>Takes pictures of the view from aircraft windows.</p> <p>Tips</p> <ul style="list-style-type: none"> Angle the camera towards areas of contrasting colors when aligning the focus. Check that the interior of the aircraft is not reflected in the window. 	<ul style="list-style-type: none"> Main fixed settings FLASH: [ZS] FORCED FLASH OFF AF ASSIST LAMP: OFF Turn the camera off when taking off or landing. When using the camera, follow all instructions from the cabin crew.
 PIN HOLE	<p>Darkens the area around the screen for a retro effect.</p> <p>Use ▲ ▼ to select the picture size and aspect ratio, and press 'MENU/SET' to set.</p>  <p>Tips</p> <ul style="list-style-type: none"> Focus: Max. W: 3 cm (0.10 feet) and above Max. T: 1 m (3.28 feet) and above (2 m (6.57 feet) and above unless max.T) 	<ul style="list-style-type: none"> The picture quality slightly decreases. The following functions are fixed. QUALITY: [S] (Standard) The Face detection function (P.73) may not work properly in the darkened area around the screen. The following functions cannot be used. Extended optical zoom/DIGITAL ZOOM/AUTO BRACKET/MULTI ASPECT [ZS3]

Scene	Uses, Tips	Notes
 FILM GRAIN	<p>Produces black and white pictures with a grainy texture.</p> <p>Use ▲ ▼ to select the picture size and aspect ratio, and press 'MENU/SET' to set.</p>  <p>Tips</p> <ul style="list-style-type: none"> Focus: Max. W: 3 cm (0.10 feet) and above Max. T: 1 m (3.28 feet) and above (2 m (6.57 feet) and above unless max.T) 	<ul style="list-style-type: none"> The picture quality slightly decreases. The following functions are fixed. QUALITY: [S] (Standard) SENSITIVITY: ISO1600 The following functions cannot be used. Extended optical zoom/DIGITAL ZOOM/AUTO BRACKET/MULTI ASPECT [ZS3]
 UNDERWATER	<p>Achieve natural colors under water.</p> <p>Tips</p> <ul style="list-style-type: none"> For fast moving subjects, align with the AF area and press ◀ (AF Lock). (Press ◀ again to release.) If the zoom is operated after AF Lock is set, the AF Lock setting will be cancelled and must be set again. AF Lock cannot be set if AF MODE is set to [AF]. Adjust red and blue levels with 'white balance fine adjustment' (P.72). Focus: Max. W: 3 cm (0.10 feet) and above Max. T: 1 m (3.28 feet) and above (2 m (6.57 feet) and above unless max.T) 	<ul style="list-style-type: none"> Always use marine case (DMW-MCTZ7, sold separately). Self-timer: Cannot be used 

Setting frequently-used scene modes on the mode dial 'MY SCN MODE/MY SCENE MODE'

Mode: **ZS3** MS1MS2 **ZS1** MS

Frequently-used scene modes can be preset to MS1MS2 (MS for **ZS1**) on the mode dial. After the settings are made, pictures can be taken in the preset scene mode by simply setting the mode dial to MY SCN MODE/MY SCENE MODE.

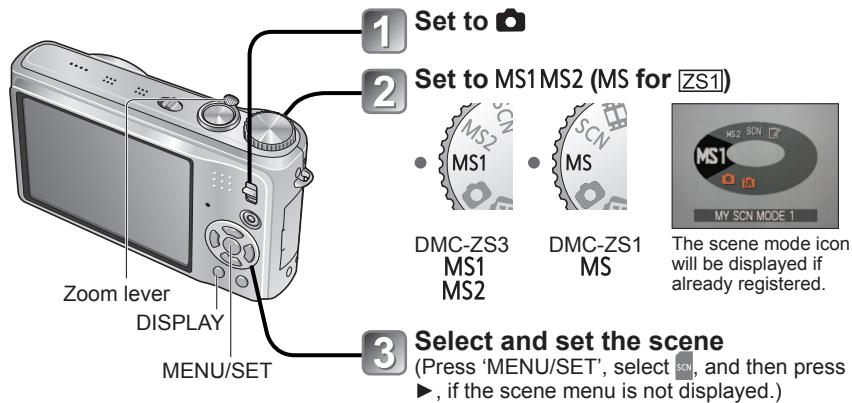

Take a picture in the preset scene.

- ➔ Set the mode dial to MY SCN MODE/MY SCENE MODE, and take an image.
- Functions, tips for each scene (P.52 - 59)

Changing the registered scene mode

- ➔ Perform the registration operation again

Taking motion pictures **ZS3**

- ➔ (P.61)

MS1 and MS2 **ZS3**

Both represent the same function. Frequently-used scenes can be preset to each position so that you can quickly and easily switch to the desired scene mode.

- For details on the preset scenes, see the page on scene modes. (P.51)
- If recording settings are reset by 'RESET' in the SETUP menu, the preset scene modes are cleared.

Taking motion pictures **ZS3**

Mode: **IA** MS1MS2 SCN

Enables motion pictures to be recorded with (stereo) audio. (Recording with muted sound is not possible.) Zoom can also be used during recording.

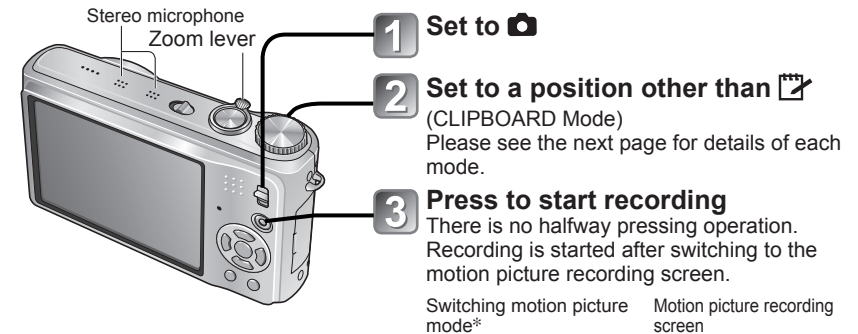

Playing back motion pictures

- ➔ (P.84)

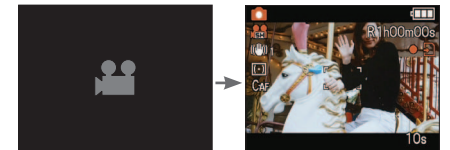

Press the motion picture button again to end recording

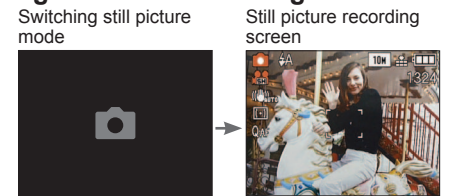

Remaining recording time (approx.)
REC MODE (P.79)/REC QUALITY (P.80)

REC MODE	AVCHD Lite			MOTION JPEG			
REC QUALITY	SH	H	L	HD	WVGA	VGA	QVGA
Icon							

CONTINUOUS AF (P.80)

Elapsed recording time (approx.)

Taking motion pictures ZS3 (Continued)

Mode: MS1MS2 SCN

(INTELLIGENT AUTO Mode)

The camera automatically detects the scene to record motion pictures with optimal settings.

When scene does not correspond to any on the right.	(i PORTRAIT)	(i LOW LIGHT)
	(i SCENERY)	(i MACRO)

- If brightness or other conditions change during recording, the scene mode will be changed automatically.
 - In (i PORTRAIT) Mode, focus and exposure will be set according to the face detected.
 - (i Low light) will be selected for nightscapes and other dark scenes. Flash cannot be used with this mode.
 - Please refer to P.33 if conditions do not allow scenes to be detected easily.
 - If the camera does not select your desired scene mode, choosing an appropriate mode manually is recommended.
 - The following menu options in the MOTION PICTURE menu can be set.
 - REC MODE • REC QUALITY • COLOR MODE*
 - *: 'STANDARD', 'B/W', and 'SEPIA' only
 - The following functions are fixed.
 - DIGITAL ZOOM: OFF • WIND CUT: OFF • CONTINUOUS AF: ON
 - WHITE BALANCE: AWB • AF MODE: (Face Detection)*
 - * 1-area-focusing turns on when faces cannot be detected.
 - I.EXPOSURE is activated automatically based on the conditions.
- See P.32 for details.

(NORMAL PICTURE Mode)

Records a motion picture at your preferred settings.
See P.35 for details.

MS1 MS2 (MY SCN MODE/MY SCENE MODE)/ SCN (SCENE MODE)

Records a motion picture at the optimum settings for the selected scene.
Some scenes are switched to the following scenes.

Selected scene	Scenes for motion picture
BABY	(PORTRAIT motion picture)
NIGHT PORTRAIT, NIGHT SCENERY, STARRY SKY	(Low light motion picture)
PANORAMA ASSIST, SPORTS, PET, HI-SPEED BURST, FLASH BURST, FIREWORKS	Normal motion picture

- I.EXPOSURE is activated automatically, based on conditions depending on the scene mode.
 - The following items cannot be set in some scene modes.
 - WHITE BALANCE • DIGITAL ZOOM
- See P.51 (Scene Mode) or P.60 (My Scene Mode) for details.

- Using a card of SD speed 'Class 6'* or above is recommended for recording motion pictures.
 - * The SD speed class is a speed rating for continuous writing.
- Using a high-speed card with a specified speed (e.g. on packaging) of at least 10 MB/s is recommended when 'REC QUALITY' is set to 'HD', 'WVGA', or 'VGA'.
- A maximum of approx. 2 GB of continuous motion pictures can be recorded in MOTION JPEG format. (Even if there is more than 2 GB of available space on the card, the available recording time will be calculated for a maximum of 2 GB.) To record more than 2 GB, press the motion picture button again. In AVCHD Lite format, recording may be continued until the card is full.
- If data is repeatedly recorded and deleted, the total available recording time on the SD card may be reduced. To restore the original capacity, use the camera to format the SD card. Be sure to save all important data to your computer or other media before formatting, as all data saved to the card will be erased.
- Do not block the microphone with your fingers.
- Immediately release the motion picture button after pressing it. No audio will be recorded for a few seconds after recording is started if the button is held down.
- Sounds of camera operations, such as zoom movement and beeps may be recorded.
- The zoom speed is slower than normal.
- STABILIZER is fixed at 'MODE1' regardless of the setting before motion picture recording.
- To fix the focus setting, set 'CONTINUOUS AF' to 'OFF'.
- The following functions are not available.
 - Extended optical zoom, flash, FACE RECOG., 'NATURAL' and 'VIVID' in 'COLOR MODE', ROTATE DISP. for pictures taken vertically
- Recording automatically ends when there is no more available space. For certain memory cards, recording may end while in progress.
- MultiMediaCards are not supported.
- The screen can become narrower in motion pictures compared to pictures. The recordable area is displayed by setting 'REC AREA' (P.22) to 'ON'.
- If extended optical zoom was used before pressing the motion picture button, these settings will be cleared, and the recordable area will be larger.
- 'QVGA' in 'REC QUALITY' (P.80) only can be recorded to the built-in memory.
- If power is lost while using the AC adaptor to record a motion picture (e.g. power failure, cable disconnection, etc), the motion picture being recorded will be lost. Using a sufficiently-charged battery in conjunction with the AC adapter is recommended.
- Fast-moving objects in motion pictures may appear blurred during playback.

Taking motion pictures ZS1

'MOTION PICTURE Mode'

Mode: 

This enables recording of (monaural) audio motion pictures. (Recording with muted sound is not possible.) Zoom can also be used during recording. If the motion picture is recorded on a memory card, one that is marked as '10 MB/s' or faster on the package is recommended.

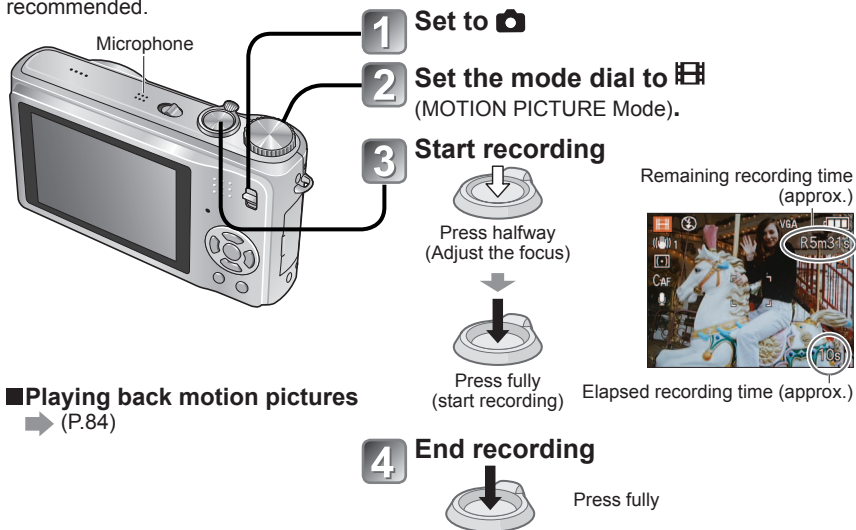

■ Playing back motion pictures

➔ (P.84)

- A maximum of approx. 2 GB of continuous motion pictures can be recorded. (Even if there is more than 2 GB of available space on the card, the available recording time will be calculated for a maximum of 2 GB.) To record more than 2 GB, press the shutter button again.
- Do not block the microphone with your fingers.
- Immediately release the shutter button after pressing it. No audio will be recorded for a few seconds after recording is started if the button is held down.
- Camera operation sounds, such as zoom movement and beeps may be recorded.
- The zoom speed is slower than normal.
- AF MODE is fixed at 1-area-focusing, and stabilizer is fixed at 'MODE1'.
- To fix the focus setting, set 'CONTINUOUS AF' to 'OFF'.
- Extended optical zoom and ROTATE DISP. for pictures taken vertically are not available.
- 'NATURAL' and 'VIVID' cannot be set for motion picture recording.
- Recording automatically ends when there is no more available space. For certain memory cards, recording may end while in progress.
- MultiMediaCards are not supported.
- 'QVGA' in 'REC QUALITY' (P.80) only can be recorded to the built-in memory.

Taking pictures with the face recognition function ZS3

Mode:   MS1MS2SCN

Face Recognition function

Set 'FACE RECOG.' in the REC menu to 'ON' to use the following face recognition functions when taking pictures.

- Detect faces close to those that have been registered for priority focus and exposure adjustment.
- Set names for registered faces, which will then be displayed when the camera recognizes a registered face.
- Set 'AUTO REGISTRATION' to 'ON' to have the camera remember the faces it recognizes, automatically detect faces that appear frequently, and display these faces on the face registration screen.
- Names can be displayed during playback, and only pictures featuring certain names can be displayed with 'CATEGORY PLAY' (P.88).



Face registration

Up to 6 faces can be registered with information such as names and birthdays. This allows for easier recognition of people who frequently appear in your pictures.

■ Registering from REC menu

- 1 Select 'FACE RECOG.' from the REC menu (P.18)
- 2 Select 'SET' with ▲▼, and press 'MENU/SET'
- 3 Select 'MEMORY' with ▲▼, and press 'MENU/SET'

- A list will be displayed if 6 people have already been registered. Select a person to be replaced. This person's information will be deleted.
- To change previously registered faces, select 'EDIT', choose the person to edit, and perform steps 6 and 7.
- To delete registrations, select 'DELETE', and choose the person to be deleted.

- 4 Use the guidelines to take a picture

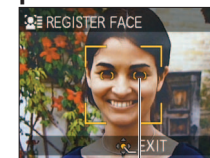

Align eye positions to the guidelines

- Non-human faces (i.e. pets, etc.) cannot be registered.
- Ensure that the person is facing the camera directly.

- 5 Select 'YES' with ▲▼, and press 'MENU/SET'
- 6 Register name and birthday on the editing screen (see next page)
- 7 Press 'MENU/SET' to close the window

Taking pictures with the face recognition function [ZS3] (Continued)

Mode: [IA] [MS1MS2SCN]

Face recognition editing screen

Select items with ▲▼, and press ► to set.

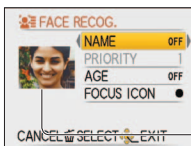

- NAME: Register names (text input method: P.89)
- PRIORITY: Set priority order for focus and exposure adjustment
Changing priority order: Select new registration number with ▲▼◀▶, and press 'MENU/SET'.
- AGE: Input birthday with ▲▼◀▶, and press 'MENU/SET'
- FOCUS ICON: Select with ▲▼, and press 'MENU/SET'.
- Face picture: Press ◀ to select the picture, and press 'MENU/SET' to take another face picture (step 4) on previous page).

Registering from automatic registration screen

If 'AUTO REGISTRATION' is set to 'ON' in step 3 of 'Face registration', the registration screen will be automatically displayed after taking a picture of someone who appears frequently in your pictures. (The screen will appear after the same person is taken about 5 times – not including pictures taken with BURST, AUDIO REC., AUTO BRACKET, or MULTI ASPECT settings.)

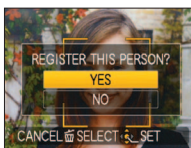

- 1 Select 'YES' with ▲, and press 'MENU/SET'
 - If 'NO' is selected, another screen will be displayed, where 'AUTO REGISTRATION' can be set to 'OFF' by pressing ▲ to select 'YES'.
- 2 Follow steps 6 and 7 in 'Face registration'
 - The automatic registration screen will not be displayed if 6 people have already been registered.

● Face Recognition may not be possible or may not correctly recognize people in the following cases due to their expressions or recording environment even if they are registered people.

- Faces that are not facing forward, are tilted, appear extremely bright or dark, are obscured by sunglasses, light reflected by eyeglasses, hair, hats, or other objects, or appear small.
- The entire face does not fit into the screen
- Facial features changed due to age
- Significantly different expressions
- Few amounts of face shading
- Fast movements
- The camera is shaking
- Digital zoom is used

- AF MODE is fixed to [] (Face detection).
- If the camera is aimed at a different subject after pressing the shutter button halfway when taking a picture, recording information for the different subject may be added.
- Please re-register any faces that are not correctly recognized.
- Face Recognition does not work with CLIPBOARD mode, motion picture recording, BURST (for second and subsequent pictures), and the 'PANORAMA ASSIST', 'TRANSFORM', 'NIGHT SCENERY', 'FOOD', 'HI-SPEED BURST', 'FLASH BURST', 'STARRY SKY', 'FIREWORKS', 'AERIAL PHOTO', 'FILM GRAIN', and 'UNDERWATER' scene modes.
- Names registered with 'FACE RECOG.' will not be displayed for pictures where text has already been registered for names in 'BABY' or 'PET' scene modes, for 'LOCATION' in 'TRAVEL DATE', or in 'TITLE EDIT'.
- Information for up to three registered people can be viewed when using the 'PHOTOfunSTUDIO' on the CD-ROM (supplied).

Useful features for travel

Mode: [ZS3] [IA] [MS1MS2SCN] [ZS1] [IA] [MS SCN]

* Recording only. (Cannot set.)

TRAVEL DATE (Record travel date and destination)

Record information as to what day and where pictures were taken by setting departure dates and destinations.

Set-up: • Clock must be set in advance (P.17).

• Press 'MENU/SET' → 'SETUP MENU' → Select 'TRAVEL DATE'

1 Select 'TRAVEL SETUP'

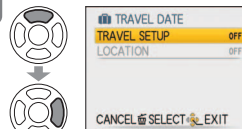

2 Select 'SET'

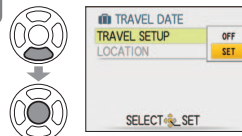

3 Set departure date

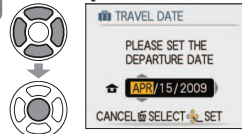

4 Set return date with ▲▼◀▶

Exit without entering if you do not wish to set a return date.

5 Select 'LOCATION'

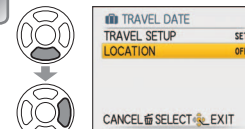

6 Select 'SET'

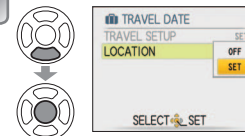

7 Enter destination

- Text input method (P.89)
- Press 'MENU/SET' twice after inputting text to complete.

To release

Setting is released automatically once return date has passed. To release before this date, select 'OFF' in step 2, and press 'MENU/SET' 3 times.

- The number of days elapsed is displayed for approx. 5 sec. when switching from playback to recording mode or when power is turned on. ([] displayed at bottom-right of screen)
- When destination is set in 'WORLD TIME' (next page), days elapsed are calculated based on local destination time.
- If settings are made before departure date, number of days to departure are displayed in orange with a minus sign (but not recorded).
- When 'TRAVEL DATE' is displayed in white with a minus sign, the 'HOME' date is one day in advance of the 'DESTINATION' date (this is recorded).
- Text in 'LOCATION' can be edited after recording with 'TITLE EDIT' (P.89).
- To print travel date or destination → Use 'TEXT STAMP' (P.90), or print using supplied CD-ROM (PHOTOfunSTUDIO).
- Names in 'BABY' and 'PET' scene modes cannot be recorded when 'LOCATION' is set.
- 'TRAVEL DATE' can be recorded during motion picture recording (Motion JPEG only), but 'LOCATION' cannot.

Useful features for travel (Continued)

Mode:

* Recording only. (Cannot set.)

WORLD TIME

(Registering local time at your travel destination)

Set-up: • Clock must be set in advance (P.17).

• Press 'MENU/SET' → 'SETUP MENU' → Select 'WORLD TIME'

'PLEASE SET THE HOME AREA' will be displayed when setting for the first time. In this case, press 'MENU/SET' and skip to step 2.

■ Set home area

1 Select 'HOME'

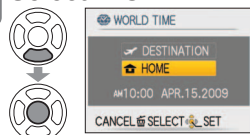

2 Set your home area

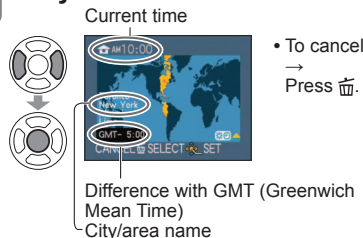

Screen from step 1 will then be displayed only when camera is used for the first time (or has been reset).

To close menu, press 'MENU/SET' 3 times.

3 Finish



■ Upon your return → Go through steps 1, 2 and 3 on the upper left, and return to the original time.

■ To set/release summer time



Press ▲ in step 2. (Press again to release)

• When summer time is set in 'DESTINATION', the current time is advanced by 1 hour. If the setting is canceled, the time automatically returns to the current time. Even if you set summer time in 'HOME', current time will not be changed. Please advance the current time by 1 hour in 'CLOCK SET' (P.17).

• Pictures and motion pictures in Motion JPEG recorded when set to a destination are indicated by (DESTINATION) in playback mode.

■ Set destination area

1 Select 'DESTINATION'



2 Set destination area

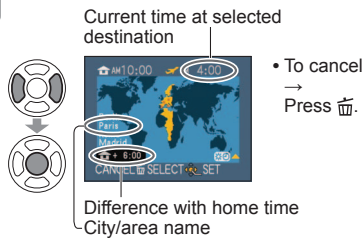

If actual destination is unavailable, select based on 'difference with home time'.

3 Finish



Using REC/MOTION PICTURE menu

REC/PLAY switch:

• See P.18 for menu setting procedure.

• 'Quick menu' (P.20) is useful to easily call up frequently-used menus.

• REC menu items will be synchronized with items of the same names in the MOTION PICTURE menu (i.e. settings changes in one will be reflected in the other). Settings selected in the REC menu that are not available in the MOTION PICTURE menu will be set as follows.

• AF MODE: (1-area-focusing)

• COLOR MODE: STANDARD

PICTURE SIZE

Set size of picture. Number of pictures which can be recorded depends on this setting and on 'QUALITY' (P.70).

■ MODE: → REC menu

→ REC menu

■ Settings:

Recording picture capacity (P.124)

ASPECT RATIO	Picture size					
		10 M 3648×2736	7M * 3072×2304	5M 2560×1920	3M 2048×1536	2M * 1600×1200
	9.5 M 3776×2520	6.5M * 3168×2112	4.5M * 2656×1768	3M * 2112×1408	2.5M * 2048×1360	—
	9 M* 3968×2232	6M * 3328×1872	4.5M * 2784×1568	2.5M * 2208×1248	2M 1920×1080	—

Recording picture capacity (P.126)

ASPECT RATIO	Picture size					
		10 M 3648×2736	7M * 3072×2304	5M 2560×1920	3M 2048×1536	2M * 1600×1200
	9 M 3648×2432	6M * 3072×2048	4.5M * 2560×1712	2.5M * 2048×1360	—	—
	7.5 M* 3648×2056	5.5M * 3072×1728	3.5M * 2560×1440	2M 1920×1080	—	—

* This setting is not available in (INTELLIGENT AUTO Mode).

• Extended optical zoom can be used for picture sizes indicated with .

• Mosaic effect may appear depending on subject and recording conditions.

Setting guide

Larger picture size	↔	Smaller picture size*
Crisper picture		Coarser picture
lower recording capacity		higher recording capacity

* For example, '0.3 M ' is suitable for e-mail attachments or longer recording.

Using REC/MOTION PICTURE menu

(Continued)

REC/PLAY switch:

See P.18 for menu setting procedure.

QUALITY

Set quality of picture.

■ **MODE:** MS1 MS2 SCN → REC menu
 MS SCN → REC menu

■ **Settings:** Fine (High quality, priority to picture quality)
 Standard (Standard quality, priority to the number of pictures)

ASPECT RATIO

Aspect ratio of picture can be changed according to printing or playback format.

■ **MODE:** MS1 MS2 SCN → REC menu
 MS SCN → REC menu

■ **Settings:**



Same as 4:3 TV or computer

Same as normal film camera

For playback on widescreen/
high definition TV

- Edges may be cut off when printing – be sure to check in advance.
- In **IA** (INTELLIGENT AUTO Mode), **3:2** (9.5M) and **16:9** (2M) may be selected by changing the 'PICTURE SIZE'.

ISO INTELLIGENT ISO

Camera automatically adjusts ISO sensitivity and shutter speed according to movement of subject to avoid blur. Higher ISO sensitivity reduces subject blur and jitter but can increase interference. Please select maximum ISO sensitivity according to table below.

■ **MODE:** → REC menu

■ **Settings:** OFF / / /

Setting guide

Movement of subject	Slow	↔	Fast
ISO sensitivity	Low		High
Shutter speed	Slow		Fast
Interference	Low		High

● Slow-moving subject



ISO sensitivity 200
(Shutter speed 1/30)

● Fast-moving subject



ISO sensitivity 800
(Shutter speed 1/125)

- Shutter speed and ISO sensitivity are displayed in the screen for a few seconds after recording.
- If interference becomes noticeable, we recommend reducing the setting, or selecting 'NATURAL' in the 'COLOR MODE' (P.77).
- Blurring may occur depending on brightness, and size, position, and speed of movement of the subject (e.g. if subject is too small, is on edge of picture, or starts moving as soon as shutter button is pressed).
- Scope of flash recording (P.44)

ISO SENSITIVITY

Set ISO sensitivity (sensitivity to lighting) manually.

We recommend higher settings to take clear pictures in darker locations.

■ **MODE:** → REC menu

■ **Settings:** AUTO / 80 / 100 / 200 / 400 / 800 / 1600

Setting guide

SENSITIVITY	80	↔	1600
Location (recommended)	Bright (outdoors)		Dark
Shutter speed	Slow		Fast
Interference	Low		High

- AUTO: Automatically set with range up to 400 (1000 when using flash) according to brightness.
- Scope of flash recording (P.44)
- Cannot be set when 'INTELLIGENT ISO' is used (is displayed)
- If interference becomes noticeable, we recommend reducing the setting, or selecting 'NATURAL' in the 'COLOR MODE' (P.77).

Using REC/MOTION PICTURE menu

(Continued)

REC/PLAY switch:

WB WHITE BALANCE

Adjust coloring to suit light source if colors otherwise appear unnatural.

■ **MODE:** MS1MS2 SCN → REC/MOTION PICTURE menu
 MS SCN → REC menu

■ **Settings:** AWB (automatic) / (outdoor, clear sky) / (outdoor, cloudy sky) / (outdoor, shade) / (halogen lighting) / (uses value set in SET) / SET (set manually)

● 'AWB' operational range:

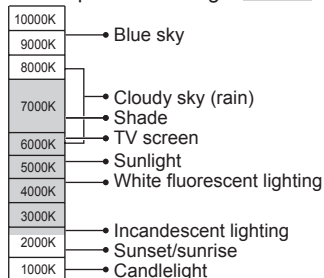

- Image may appear red or blue if out of range. This function may also not work correctly even within range if there are many light sources present.
- We recommend setting to 'AWB' or ' SET' when under fluorescent lighting.

White balance fine adjustment (excluding 'AWB')

White balance settings can be individually fine tuned if colors still do not appear as anticipated.

① Press several times until 'WB ADJUST.' is displayed.

② Adjust with if reds are strong, adjust with if blues are strong.

③ Press 'MENU/SET'.

• Settings are remembered even if power is turned off.

• Settings remain applied when using flash.

• Even though the 'AWB' setting is fixed in 'UNDERWATER' scene mode, fine adjustments may still be made.

• Fine adjustments cannot be made when 'COLOR MODE' (P.77) is set to 'B/W', 'SEPIA', 'COOL', or 'WARM'.

Changes to red (blue) when making fine adjustment

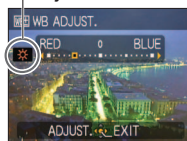

Setting white balance manually (SET)

① Select SET and press 'MENU/SET'.

② Point the camera towards a white object (e.g. paper) and press 'MENU/SET'.

③ Press 'MENU/SET'.

White balance is set to .

• Making this setting will reset white balance fine adjustment.

Only takes image of white objects within frame (step ②)



See P.18 for menu setting procedure.

FACE RECOG.

Registering people that appear frequently in your pictures allows them to be given priority when aligning focus, and allows all pictures featuring them to be viewed collectively. For details, please refer to P.65.

AF MODE

Method of aligning focus can be changed according to position and number of subjects.

■ **MODE:** MS1MS2 SCN → REC/MOTION PICTURE menu
 MS SCN → REC menu

■ **Settings:** / / / / / (H: High-speed focus)

Taking front-on pictures of people

Face detection

Recognizes faces (up to 15 people) and adjusts exposure and focus accordingly. (When METERING MODE (P.75) is set to 'Multiple')

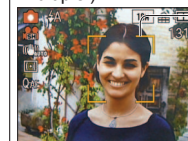

AF area

Yellow: When the shutter button is pressed halfway, the frame turns green when the camera is focused.

White: Displayed when more than one face is detected. Other faces that are the same distance away as faces within the yellow AF area are also focused.

• If 'FACE RECOG.' is set to 'ON', when taking pictures with Face detection, priority is given to adjusting the focus and exposure of the faces of registered people. (P.65)

Automatically locking the focus on a moving subject

AF tracking

Align the AF tracking frame with the subject, and then press .



AF tracking frame

When the subject is recognized, the AF tracking frame changes from white to yellow, and the subject is automatically kept in focus. If AF Lock fails, a red frame flashes.

- To clear AF Lock, press .
- Focus: Max. W: 3 cm (0.10 feet) and above
Max. T: 1 m (3.28 feet) and above
(2 m (6.57 feet) and above unless max.T)

Subject not in center of picture (AF area displayed after focuses completely aligned)

11-area-focusing

Automatically focuses on any of 11 points.

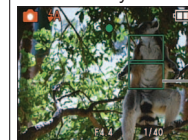

AF area

Using REC/MOTION PICTURE menu

(Continued)

REC/PLAY switch:

See P.18 for menu setting procedure.

Determined position for focus

- 1-area-focusing (High speed)
- 1-area-focusing
- Spot-focusing

1-area-focusing (High speed)/
1-area-focusing:
Focuses on AF area in center of picture. (Recommended when focus is difficult to align)

Spot-focusing:
Focuses on smaller, limited area.

AF area

Spot AF area

- When using , picture may freeze momentarily before focus is aligned.
- AF area becomes larger in dark locations or when using digital zoom or macro zoom, etc.
- Use or if focus is difficult to align with .
- Cannot set to 'Face detection' in the following cases: 'PANORAMA ASSIST', 'NIGHT SCENERY', 'FOOD', 'STARRY SKY', 'FIREWORKS', 'AERIAL PHOTO', 'UNDERWATER' scene modes
- If the camera detects subjects other than a person as the face even though 'Face detection' is set, switch the AF mode setting to any other modes.
- The face detection function may fail to work under the following conditions. (AF mode setting is switched to)
 - When the face is not facing the camera
 - When the face is at an angle
 - When the facial features are hidden behind sunglasses, etc.
 - When the face is extremely bright or dark
 - When the face appears small on the screen
 - When there is rapid movement
 - When the camera is shaking
 - When the subject is other than a human being such as pets
 - When digital zoom is used
- In AF tracking, the AF lock can fail, lose the subject, or track another subject or following conditions.
 - The subject is too small
 - There is rapid movement
 - The camera is shaking
 - The location is too bright or dark
 - A similarly-colored subject or background
 - Zoom is used
- Cannot set to (AF tracking) in the following cases.
 - 'STARRY SKY', 'FIREWORKS', 'PIN HOLE', 'FILM GRAIN', or 'PANORAMA ASSIST' scene modes.
 - 'B/W', 'SEPIA', 'COOL', and 'WARM' in COLOR MODE
- Can be set to 'Face Detection' and '1-area-focusing' for motion picture recording.

PRE AF

Focus is continually aligned according to movement of subject even when shutter button is not pressed. (Increases battery consumption)

- **MODE:** MS1MS2 SCN → REC menu
 MS SCN → REC menu

■ Settings:

Setting	Effect
OFF	Focus is not adjusted until the shutter button is pressed halfway.
Q.AF	The focus is automatically adjusted when camera blurring is small even when the shutter button is not pressed.
C.AF	The focus is adjusted continuously based on subject movement, even when the shutter button is not pressed.

- Focus alignment may take time if zoom is suddenly changed from max. W to max. T, or if suddenly moving closer to subject.
- Press shutter button halfway if focus is difficult to align.
- When using , , or in AF MODE, focus will be aligned quickly when shutter button is pressed halfway.

METERING MODE

You can change the position for measuring brightness when correcting exposure.

- **MODE:** → REC menu

■ Settings:

	Brightness measurement position	Conditions
Multiple	Whole screen	Normal usage (produces balanced pictures)
Center weighted	Center and surrounding area	Subject in center
Spot	Center and close surrounding area Spot metering target	Great difference between brightness of subject and background (e.g. person in spotlight on stage, backlighting)

Using REC/MOTION PICTURE menu

(Continued)

REC/PLAY switch:

See P.18 for menu setting procedure.

I.EXPOSURE

Automatically adjusts contrast and exposure to give more lifelike colors when there is significant contrast between background and subject.

■ **MODE:** → REC/MOTION PICTURE menu
 → REC menu

■ **Settings:** OFF/ON (displayed on screen)

- Even if 'SENSITIVITY' is set to '80' or '100', when I.EXPOSURE is activated, images may be taken at a higher sensitivity than the setting.
- Correction effects may not be achieved under certain conditions.

BURST

Enables a rapid succession of photographs to be taken. Succession of photographs taken while shutter button is held down.

■ **MODE:** MS1MS2 SCN → REC menu
 MS SCN → REC menu

■ **Settings:**

BURST setting	Speed	No. of pictures *1
OFF		No burst
(Burst)	2.3 pictures/sec. () 2.5 pictures/sec. ()	Fine: Max. 3 Standard: Max. 5
(Free)	Approx. 1.8 pictures/sec *2 () Approx. 2.0 pictures/sec *2 ()	Until card/built-in memory is full

*1 : When using self-timer: Fixed at 3 pictures

*2 : **Becomes progressively slower.** (Delayed timing depends on card type, PICTURE SIZE, and QUALITY.)

- Focus is fixed from first picture.
- When is selected, the exposure and white balance are fixed to the settings for the first picture.
- When is selected, exposure and white balance is adjusted for each picture.
- Burst speed may be reduced if SENSITIVITY is set to high, or if shutter speed is reduced in darker locations.
- When burst setting is used, flash is set to 'FORCED FLASH OFF', and AUTO BRACKET, MULTI ASPECT , and AUDIO REC. settings are canceled.
- Settings will be stored even if power is turned off.
- When using while following a moving subject in locations with major differences in brightness, optimal exposure may not be achieved.
- Auto review performed regardless of AUTO REVIEW setting.
- Cannot set to BURST in TRANSFORM, PANORAMA ASSIST, HI-SPEED BURST, FLASH BURST, STARRY SKY, PIN HOLE, and FILM GRAIN scene modes.
- Using the 'HI-SPEED BURST' scene mode allows a faster succession of photographs to be taken. FLASH BURST is convenient to take continuous still pictures using flash in dark places. (P.56)

DIGITAL ZOOM

Multiplies effect of optical zoom or extended optical zoom by up to 4 times. (See P.39 for details)

■ **MODE:** MS1MS2 SCN → REC/MOTION PICTURE menu
 MS SCN → REC menu

■ **Settings:** OFF/ON

- This is fixed at 'ON' when MACRO ZOOM is set.

COLOR MODE

Set color effects.

■ **MODE:** → REC/MOTION PICTURE menu
 → REC menu

■ **Settings:** STANDARD / NATURAL (soft) / VIVID (sharp) / B/W / SEPIA / COOL (more blue) / WARM (more red)

- If interference is noticeable in dark locations: Set to 'NATURAL'.
- In (INTELLIGENT AUTO Mode), 'STANDARD', 'B/W', and 'SEPIA' only can be set.
- 'NATURAL' and 'VIVID' cannot be set for motion picture recording.

STABILIZER

Automatically detects and prevents jitter.

■ **MODE:** MS1MS2 SCN → REC menu
 MS SCN → REC menu

■ **Settings:**

Settings	Effect
OFF	Pictures deliberately taken with no jitter correction
AUTO	The optimum image stabilizer is performed automatically based on the recording conditions.
1 MODE1	Constant correction (Monitor image stable, composition easy to determine)
2 MODE2	Correction at moment shutter button is pressed (More effective than MODE1)

- Setting fixed to 'MODE2' in 'SELF PORTRAIT' and 'OFF' in 'STARRY SKY' scene modes.
- Cases where optical image stabilizer may be ineffective: Heavy jitter, high zoom ratio (including digital zoom range), fast-moving objects, indoors or in dark locations (due to low shutter speed)
- This is fixed at 'MODE1' during motion picture recording.

Using REC/MOTION PICTURE menu

(Continued)



REC/PLAY switch: 

MIN. SHTR SPEED

Sets shutter speed to minimum. We recommend using slower shutter speeds to take brighter pictures in dark locations.

■ **MODE:**  → REC menu



■ **Settings:** 1/250 1/125 1/60 1/30 1/15 1/8 1/4 1/2 1

- Slower shutter speeds allow for brighter pictures but increase risk of jitter, so we recommend using a tripod and the self-timer.
- As pictures may become dark when using faster values such as '1/250', we recommend that pictures are taken in bright locations ( flashes red when shutter button is half-pressed if picture will be dark).
-  displayed on screen for settings other than '1/8'.
- Cannot be set when INTELLIGENT ISO is used. (P.70)



AUDIO REC.

Sounds can also be recorded with pictures. This is useful for conversation or memo recording.

■ **MODE:**   MS1MS2 SCN → REC menu

  MS SCN → REC menu



■ **Settings:** OFF/ON (Record approx. 5 seconds of sound ( displayed on screen))

- To cancel recording → Press 'MENU/SET'.
- To play audio → (P.84)
- Recording is not possible in BURST, AUTO BRACKET, MULTI ASPECT , and the 'PANORAMA ASSIST', 'STARRY SKY', 'HI-SPEED BURST', and 'FLASH BURST' scene modes.
- TEXT STAMP, RESIZE, TRIMMING, LEVELING, and ASPECT CONV.  cannot be used with pictures with audio.
- Separate setting to AUDIO REC. in CLIPBOARD menu (P.82).
- **Do not block microphone (P.12) with fingers.**

AF* AF ASSIST LAMP

Illuminates lamp when dark to facilitate focus alignment.

■ **MODE:**   MS1MS2 SCN → REC menu

  MS SCN → REC menu

■ **Settings:** OFF: Lamp off (taking pictures of animals in dark, etc.)

ON: Lamp illuminated with halfway press of shutter button ( and larger AF area displayed)

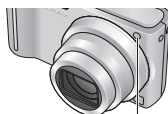

Lamp: Effective distance: 1.5 m (4.93 feet) (Do not cover or look at lamp from close range)

See P.18 for menu setting procedure.

CLOCK SET



Set the clock. Same function as that in SETUP menu (P.17).

REC MODE

Sets the data format of the motion picture that is recorded.

■ **MODE:**   MS1MS2 SCN → MOTION PICTURE menu

■ **Settings:**

Recording format	Effect
 AVCHD Lite	This is a data format suitable for playback on high-definition TVs. This format enables an extended recording time in high-resolution compared to motion pictures recorded in Motion JPEG at the same picture size.
 MOTION JPEG	This is a data format suitable for playback on computers that allows even small picture sizes to be recorded. The data format is useful when there is little space left on a memory card or when the motion picture file will be attached to an e-mail from a computer.

- The 'REC QUALITY' options vary based on the setting.
- If a card is not loaded in the camera, the motion picture is automatically recorded in 'MOTION JPEG' (REC QUALITY: QVGA).
- Motion pictures recorded in 'AVCHD Lite' can be played back in AVCHD-compliant equipment only. Playback is not possible in equipment that does not support the AVCHD standard (such as conventional DVD recorders), and so check the compatibility in your equipment's operation manual. Please confirm the detailed information on the following website.
<http://panasonic.co.jp/pavc/global/cs>
(This Site is English only.)
- Motion pictures recorded in 'AVCHD Lite' format cannot be played back on non-AVCHD-compatible devices (standard DVD players, etc).
- In some cases, motion pictures recorded in 'AVCHD Lite' and 'MOTION JPEG' may have poor image quality or sound quality during playback or may not be able to be played back even when using equipment supporting these standards. The recording information also may not be displayed correctly. If this happens, play the motion pictures back using the camera.
- Motion pictures recorded in 'AVCHD Lite' are not compliant with DCF and Exif, and so some information (such as the picture number and white balance) are not displayed during playback.
- Using a card of SD speed 'Class 6*' or above is recommended for recording motion pictures.
* The SD speed class is a speed rating for continuous writing.
- Using a high-speed card with a specified speed (e.g. on packaging) of at least 10 MB/s is recommended when 'REC QUALITY' is set to 'HD', 'WVGA', or 'VGA'.
- Motion pictures cannot be recorded to MultiMediaCards.
- To play back motion pictures recorded in 'AVCHD Lite' format using a computer, please use the 'PHOTOfunSTUDIO' software on the CD-ROM supplied.

REC MODE is not available in the DMC-ZS1.

Using REC/MOTION PICTURE menu

(Continued)

REC/PLAY switch:

See P.18 for menu setting procedure.

REC QUALITY

Sets the picture quality of the motion picture that is recorded.

■ **MODE:** → **MOTION PICTURE menu**
 → **REC menu**

Settings:

'AVCHD Lite' in REC MODE

Setting	Resolution	Bit rate*1	Aspect ratio
SH	1280 x 720	17 Mbps	16:9
H	1280 x 720	13 Mbps	
L	1280 x 720	9 Mbps	

'MOTION JPEG' in REC MODE /

Setting	Resolution	Frame rate*2	Aspect ratio
HD	1280 x 720	30 fps	16:9
WVGA	848 x 480	30 fps	
VGA	640 x 480	30 fps	
QVGA	320 x 240	30 fps	4:3

*1 The bit rate is the amount of data per unit time. A higher value translates into a higher image quality. This camera uses the VBR (Variable Bit Rate) recording system and the available recording time is shorter when recording a subject with rapid movements.

*2 The frame rate is the number of frames per second.

- 'WVGA' cannot be set in INTELLIGENT AUTO Mode.
- 'QVGA' only can be recorded to the built-in memory.

CAAF CONTINUOUS AF

Either allow the focus to be constantly adjusted during motion picture recording, or fix the focus position at the start of recording.

■ **MODE:** → **MOTION PICTURE menu**
 → **REC menu**

■ **Settings: ON:** Adjust focus according to movement of subject during motion picture recording. (CAAF appears on the screen.)

OFF: Fix focus position at the start of motion picture recording.

Use this setting to keep the same focus position for subjects with little forward/backward movement.

WIND CUT

Reduces recording of wind sounds (wind noise) when recording in a strong wind

■ **MODE:** → **MOTION PICTURE menu**

■ **Settings: OFF/ON** (appears on the screen.)

- When WIND CUT is set to 'ON', lower sounds will be eliminated and the sound quality will differ from that of normal recordings.

Taking/viewing clipboard pictures

'CLIPBOARD Mode'

Mode:

Useful for taking pictures of timetables and maps instead of taking memos. Regardless of presence of card, pictures will always be saved to clipboard folder of built-in memory, so that they can be distinguished from normal pictures and viewed immediately. **Beware of copyrights, etc. (P.2)**

Taking clipboard pictures

- 1 Set to
- 2 Set to (CLIPBOARD Mode)
- 3 Take a clipboard picture

● Represents built-in memory used entirely for clipboard pictures (approx.)

Picture size	2 M	1 M
Pictures	84	124

Press halfway (align focus) → Press fully (take picture)

Viewing clipboard pictures

- 1 Set REC/PLAY switch to
- 2 Set mode dial to (CLIPBOARD Mode)
 - Can be viewed with same operations as with pictures taken in other modes (P.40). (30-picture and calendar displays cannot be used.)

■ **To delete clipboard pictures** → Press (delete) in step 2 above. (P.41)

■ **If built-in memory is full** →

Non-clipboard pictures can be deleted from the built-in memory by removing card from camera, setting mode dial to a setting other than (CLIPBOARD Mode), and pressing (delete).

- Copy clipboard pictures onto memory cards in order to print (next page).
- Playback mode functions cannot be used.
- 'STABILIZER' setting made in REC menu will be reflected in Clipboard Mode.
- Functions unavailable: INTELLIGENT ISO, I.EXPOSURE, FACE RECOG , MIN. SHTR SPEED BURST, DIGITAL ZOOM, AUTO BRACKET, MULTI ASPECT , WB ADJUST., PRE AF, COLOR MODE, AUTO LCD OFF, HISTOGRAM
- The settings for the following functions are fixed.
 - QUALITY: (Standard)
 - ASPECT RATIO:
 - SENSITIVITY: AUTO
 - WHITE BALANCE: AWB
 - AF MODE: (1-area-focusing)
 - AF ASSIST LAMP: ON
 - GUIDE LINE:
 - POWER SAVE: 5MIN.
 - METERING MODE: (Multiple)

Taking/viewing clipboard pictures

'CLIPBOARD Mode' (Continued)

Mode:

Zoom mark

Useful for enlarging and saving parts of maps, etc.

■ To register zoom enlarged size and position

① Enlarge with zoom lever and select position with ▲▼◀▶

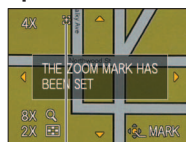

- To change zoom and position: Repeat the left
- To finish zoom mark setting: Restore zoom to original (1 x) ratio

Zoom mark
Displayed on registered pictures

■ To view registered ratio and position:

① Display picture with

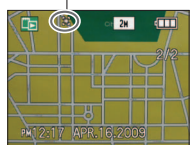

② Turn to T side (No need to manually enlarge or move)



Immediately displayed at registered ratio and position



- To cancel zoom mark → 'CANCEL MARK' (below)

- When a picture with a zoom mark is deleted, both original picture and picture with zoom mark will be deleted.
- Picture can be deleted even while zoomed in.

CLIPBOARD menu

A special menu is used in CLIPBOARD Mode.

REC ON CLIPBOARD menu (REC/PLAY switch: Mode dial:)

PICTURE SIZE	2 M (Priority to picture quality) / 1 M (Priority to the number of pictures)
AUDIO REC.	Record sound (5 seconds) simultaneously. OFF / ON
LCD MODE	OFF / AUTO POWER LCD / POWER LCD / HIGH ANGLE (P.22)
CLOCK SET	(P.17)

PLAY ON CLIPBOARD menu (REC/PLAY switch: Mode dial:)

CANCEL MARK	① Select marked clipboard picture with ◀▶. ② Cancel with 'MENU/SET'.
AUDIO DUB.	Add sound to previously-taken clipboard picture. ① Select clipboard picture with ◀▶. ② Record/stop with 'MENU/SET'. (P.97)
COPY	Copy single pictures from clipboard to card. (Zoom mark will not be copied.) ① Select clipboard picture with ◀▶ and press 'MENU/SET' ② Select 'YES' with ▲▼ and press 'MENU/SET'.
LCD MODE	OFF / POWER LCD (P.22)

- Other items in the SETUP menu will reflect settings made in other recording modes.

Viewing as list (Multi playback/Calendar playback)

REC/PLAY switch:

You can view 12 (or 30) pictures at once (multi playback), or view all pictures taken on a certain date (calendar playback).

1 Set to

2 Set to multiple screen display

• To view pictures: press ◀▶

Date recorded Picture no.

Total no.

Scroll bar

Picture type

- FAVORITE ★
- AVCHD Lite
- Motion JPEG
- BABY
- PET
- TRAVEL DATE
- WORLD TIME
- TITLE EDIT
- TEXT STAMP

(12 screens)

(30 screens)

Selected date (First picture from date)

• Select month with ▲▼ and date with ◀▶, and press 'MENU/SET' to display that date's pictures on a 12-screen display.

(Calendar screen)

■ To restore →
Turn to T side

■ To change from 12/30-screen display to single-screen display →
Select picture with ▲▼◀▶ and press 'MENU/SET'

Viewing motion pictures/pictures with audio

REC/PLAY switch: ▶

Motion pictures and pictures with audio can be played back in the same way as pictures.

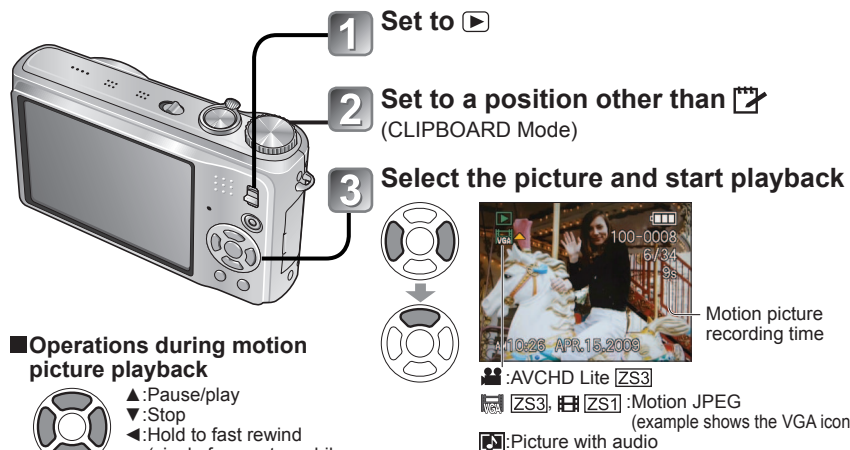

Operations during motion picture playback



- ▲:Pause/play
- ▼:Stop
- ◀:Hold to fast rewind (single frame step while paused)
- ▶:Hold to fast forward (single frame step while paused)

• Volume can be adjusted with zoom lever (motion picture only).

Deleting

➡ (P.41)

- The volume for pictures with audio can be adjusted by the speaker volume (P.21).
- Motion pictures and pictures with audio recorded by other cameras may not play back correctly on this camera.
- When using a large-volume memory card, the rewind function may take some time.
- Some information are not displayed for motion pictures recorded in 'AVCHD Lite'. [ZS3]
- Motion pictures recorded with 'AVCHD Lite' (P.79) can be viewed on your computer using 'PHOTOfunSTUDIO' on the supplied CD-ROM. [ZS3]
- Motion pictures recorded in Motion JPEG and pictures with added audio recordings can be played back on your computer using 'QuickTime' on the supplied CD-ROM.

Different playback methods 'PLAYBACK MODE'

REC/PLAY switch: ▶

Recorded pictures can be played back in a variety of ways.

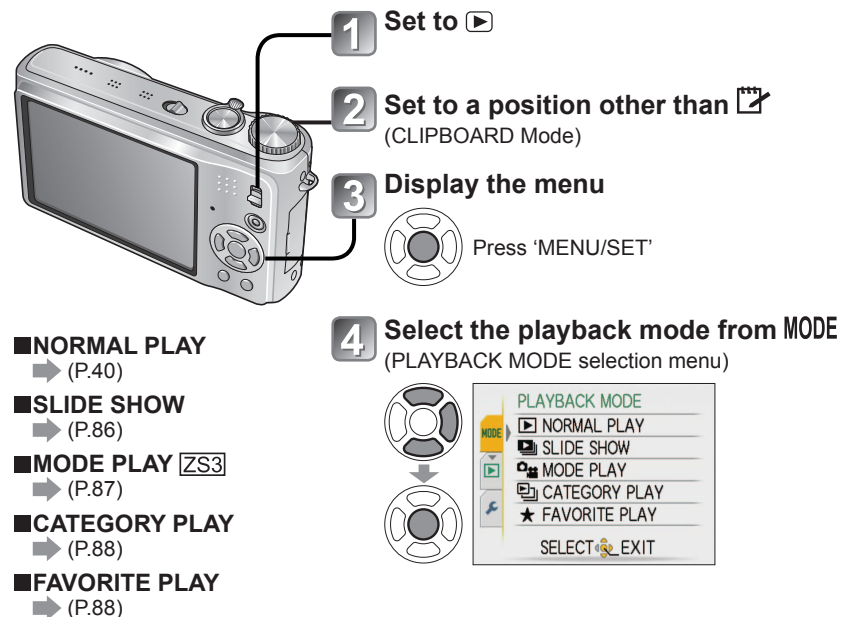

- When no card is inserted, pictures (except CLIPBOARD pictures) are played back from the built-in memory.
- The PLAYBACK MODE automatically becomes 'NORMAL PLAY' when the REC/PLAY switch is set to ▶ and the power is turned on, or when switching from recording mode to playback mode.

Different playback methods 'PLAYBACK MODE'

(Continued)

REC/PLAY switch:

See P.85 for switching PLAYBACK MODE procedure.

SLIDE SHOW

Automatically play images in order and to music. Recommended when viewing on TV screen.

1 Select playback method

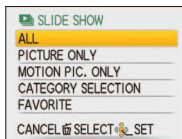
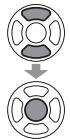

- **ALL** : Play all
- **PICTURE ONLY**: Playback of pictures only
- **MOTION PIC. ONLY**: Playback of motion pictures only
- **CATEGORY SELECTION** : Playback of pictures only
Select category, and playback slideshow. (Select category with and press 'MENU/SET'.) (P.88)
- **FAVORITE**: Play pictures set as FAVORITE (P.95) (displayed only when 'FAVORITE' pictures present and setting set to 'ON').

2 Set playback effects

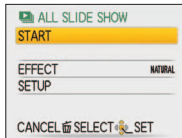
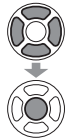

EFFECT (Select music and effects according to picture atmosphere)	
AUTO	Camera selects optimum effect from NATURAL, SLOW, SWING, and URBAN (only available with 'CATEGORY SELECTION' setting)
NATURAL	Play with relaxed music and screen transition effects
SLOW	Play with livelier music and screen transition effects
SWING	Play with livelier music and screen transition effects
URBAN	Play with livelier music and screen transition effects
OFF*1	No effects

*1 If 'MOTION PIC. ONLY' was selected in step 1, EFFECT is fixed at 'OFF'. Also, the duration cannot be set.

*2 Item name changes to 'AUDIO' when 'EFFECT' is 'OFF'.

SETUP	
DURATION*1	1 SEC. / 2 SEC. / 3 SEC. / 5 SEC. (Only available when 'EFFECT' is 'OFF')
REPEAT	OFF/ON (Repeat)
MUSIC (AUDIO)*2	OFF/ON (Play MUSIC (AUDIO)) • When EFFECT is not set to 'OFF' ON: Music is played. OFF: No music (audio) is played back. • When EFFECT is set to 'OFF' ON: Audio is played from motion pictures or pictures with audio. OFF: Audio is not played from motion pictures or pictures with audio.

3 Select 'START'

- Press to return to menu screen during slide show.

■ Operations during slide show

During motion picture playback

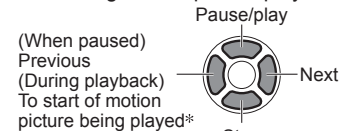

During picture playback

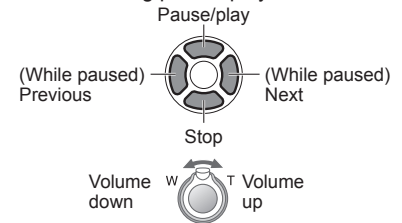

* The previous picture is displayed if less than 3 seconds of the motion picture has been played.

- When 'URBAN' has been selected, the picture may appear in black and white as a screen effect.
- Certain playback effects cannot be used when displaying images on television using HDMI mini cables. [ZS3](#)
- Music effects cannot be added.
- The duration setting is disabled during motion picture playback.
- Pictures with different aspect ratios have their edges cut so they can be displayed on the entire screen.

MODE PLAY [ZS3](#)

This playback mode is useful for playing back pictures only or only motion pictures recorded in 'AVCHD Lite' (or 'MOTION JPEG').

1 Select the type of data

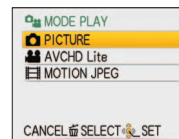

2 View images



- To delete the image → Press (Delete).

Previous Next

- To exit 'MODE PLAY', set to 'NORMAL PLAY'.

Using PLAYBACK menu (Continued)

REC/PLAY switch: (Set mode dial to any except)

■ **To edit** → select 'SINGLE' in step 1 → select picture with , and press 'MENU/SET' → correct text and select 'EXIT' → press to return to the menu.

- Cannot be set in 'CATEGORY PLAY', or 'FAVORITE PLAY' Playback Mode.
- Cannot be used with pictures taken on other devices, protected pictures, or motion pictures.
- To print text, use 'TEXT STAMP' (below) or the supplied CD-ROM (PHOTOfunSTUDIO).

TEXT STAMP

Stamp recording date or text registered in the 'BABY' and 'PET' scene modes, 'TRAVEL DATE', or 'TITLE EDIT' into your pictures. Ideal for regular size printing.

Set-up: Press 'MENU/SET' → ' PLAYBACK menu' → Select 'TEXT STAMP'

1 Select 'SINGLE' or 'MULTI' and set

2 Select picture

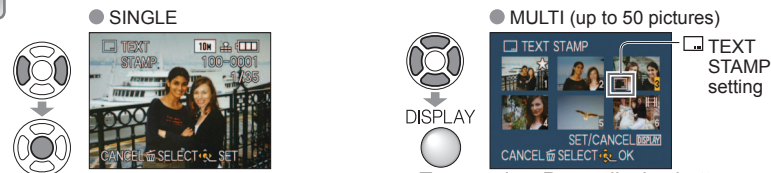

- To cancel → Press display button again.
- To execute → Press 'MENU/SET'.

3 Select items and make settings for each

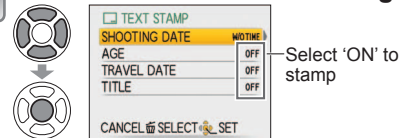

- Set the 'TITLE' setting to 'ON' to stamp entered text such as names in 'FACE RECOG.' , names in 'BABY' and 'PET' scene modes, destinations in 'TRAVEL DATE', or titles in 'TITLE EDIT'.

4 Select 'YES'



- Stamped text cannot be deleted.
- After confirmation, press to return to the menu screen in 'SINGLE' setting.

For the PLAYBACK menu setting procedure, see P.18.

■ To check stamped text → 'playback zoom' (P.40)

- Picture size will be reduced if greater than 3M. Picture will become slightly grainier.
- Cannot be used with pictures taken on other devices, pictures taken without setting clock, motion pictures, or pictures with audio.
- After TEXT STAMP is applied, pictures cannot be resized or trimmed, and 'ASPECT CONV.' , 'TEXT STAMP' and DPOF date printing settings cannot be changed on pictures.
- Characters may be cut off on certain printers.
- Cannot be set in 'CATEGORY PLAY', or 'FAVORITE PLAY' Playback Mode.
- Do not make date printing settings in shop or on printer for pictures with date stamps. (Date printing may be overlapping.)

ASPECT RATIO	After TEXT STAMP
4 : 3	3 M
3 : 2	2.5 M
16 : 9	2 M

RESIZE

Picture size can be reduced to facilitate e-mail attachment and use in homepages, etc. (Picture of minimum picture size for each aspect setting cannot be resized.)

Set-up: Press 'MENU/SET' → ' PLAYBACK menu' → Select 'RESIZE'

■ SINGLE

1 Select 'SINGLE'

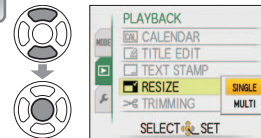

2 Select picture



3 Select size

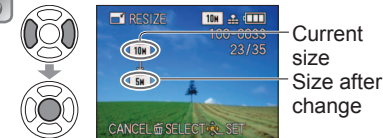

4 Select 'YES'

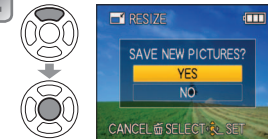

- After confirmation, press to return to the menu screen.

Using PLAYBACK menu (Continued)

REC/PLAY switch: (Set mode dial to any except)

MULTI

- 1 Select 'MULTI' in step 1 on the previous page**
- 2 Select size**

 To see description of resize: Press display button
 Select number of pixels after resizing
- 3 Select picture** (up to 50 pictures)

 DISPLAY
 Number of pixels before/after resizing
 • To cancel → Press display button again.
 • To execute → Press 'MENU/SET'.
- 4 Select 'YES' and set**

- Picture quality is reduced after resizing.
- Cannot be set in 'CATEGORY PLAY' or 'FAVORITE PLAY' Playback Mode.
- Cannot be used with motion pictures, pictures with audio, or pictures with text stamp. May not be compatible with pictures taken on other devices.

TRIMMING

Enlarge your pictures and trim unwanted areas.

Set-up: Press 'MENU/SET' → 'PLAYBACK menu' → Select 'TRIMMING'

- 1 Select picture with and and set**
- 2 Select area to trim**

 Expand → Change position → Trim
- 3 Select 'YES' and set**
 • After confirmation, press to return to the menu screen.

- Picture quality is reduced after trimming.
- Cannot be set in 'MODE PLAY' , 'CATEGORY PLAY', or 'FAVORITE PLAY' Playback Mode.
- Cannot be used with motion pictures, pictures with audio, or pictures with text stamp. May not be compatible with pictures taken on other devices.
- Original face recognition information will not be copied when pictures are trimmed.

For the PLAYBACK menu setting procedure, see P.18.

LEVELING

Slight slanting in the picture can be corrected.

Set-up: Press 'MENU/SET' → 'PLAYBACK menu' → Select 'LEVELING'

- 1 Select picture**
 - 2 Adjust the slant**
 - 3 Select 'YES'**

 • After confirmation, press to return to the menu screen.
- Picture quality is reduced when leveling is performed.
 - The resulting picture may have fewer recording pixels than the original picture when leveling is performed.
 - Cannot be used with motion pictures, pictures with audio, or pictures with text stamp. May not be compatible with pictures taken on other devices.
 - Original face recognition information will not be copied when pictures are leveled.

FACE RECOG.

Delete all face recognition information from selected pictures. This function is useful for deleting information registered accidentally with FACE RECOG. in recording mode.

Set-up: Press 'MENU/SET' → 'PLAYBACK menu' → Select 'FACE RECOG.'

- 1 Select picture with and and set**
 - 2 Select 'YES'**

 • After confirmation, press to return to the menu screen.
- Face recognition information cannot be recovered once it is deleted.
 - Pictures whose information has been deleted will not be included in 'CATEGORY PLAY' selections for recognized faces.
 - Information cannot be deleted for protected pictures.

Using PLAYBACK menu (Continued)

REC/PLAY switch: (Set mode dial to any except)

ASPECT CONV.

Convert pictures taken in **16:9** to **3:2** or **4:3** for printing.

Set-up: Press 'MENU/SET' → ' PLAYBACK menu' → Select 'ASPECT CONV.'

- 1 Select 3:2 or 4:3**
- 2 Select picture taken in 16:9**
- 3 Select horizontal position and convert**
 (Move portrait pictures using)
 Changes to outlined size
- 4 Select 'YES' and set**
 • After confirmation, press to return to the menu screen.

- Picture size may be increased after aspect ratio is changed.
- Cannot be set in 'MODE PLAY', 'CATEGORY PLAY', or 'FAVORITE PLAY' Playback Mode.
- Cannot be used with motion pictures, pictures with audio, pictures with text stamp, or non-DCF files (P.40). May not be compatible with pictures taken on other devices.
- Original face recognition information will not be copied when aspect ratios are converted.

ROTATE DISP.

Automatically rotate portrait pictures.

Set-up: Press 'MENU/SET' → ' PLAYBACK menu' → Select 'ROTATE DISP.'

- 1 Select 'ON'**
- ON

OFF

- 'ROTATE DISP.' cannot be used with motion pictures.
- Some pictures taken facing up or facing down may not be rotated automatically. It may not be possible to rotate pictures taken with certain other devices.
- Pictures cannot be rotated during multi playback and calendar playback.
- Will only be displayed rotated on computer if in Exif-compatible (P.40) environment (OS, software).

For the PLAYBACK menu setting procedure, see P.18.

★ FAVORITE

Mark your favorite pictures and enable the following functions.

- Favorites-only slide show (P.86)
- Delete all except favorites (useful for when printing in shop, etc.)

Set-up: Press 'MENU/SET' → ' PLAYBACK menu' → Select 'FAVORITE'

- 1 Select 'ON'**
- 2 Close menu**
- 3 Select picture (repeat)**
 - Displayed when set (not displayed when 'OFF').
 - Up to 999 pictures can be selected.
 - To release → Press again.

■ To release all → Select 'CANCEL' in step **1** and select 'YES'.

- Cannot be set in 'FAVORITE PLAY' Playback Mode.
- It may not be possible to set pictures taken with certain other devices as favorites.
- Setting/release can also be made with supplied software (PHOTOfunSTUDIO).
- Motion pictures recorded in 'AVCHD Lite' format cannot be set.

Using PLAYBACK menu (Continued)

REC/PLAY switch: (Set mode dial to any except)

PRINT SET

Picture/picture no./date printing settings can be made for when printing with DPOF print-compatible shops or printers. (Ask at shop to check compatibility)

For more information visit:

http://panasonic.jp/dc/dpof_110/white_e.htm

Set-up: Press 'MENU/SET' → 'PLAYBACK menu' → Select 'PRINT SET'

1 Select 'SINGLE' or 'MULTI'

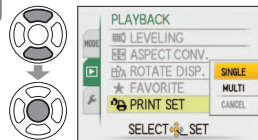

2 Select picture

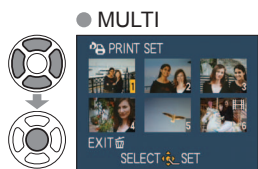

3 Set number of pictures

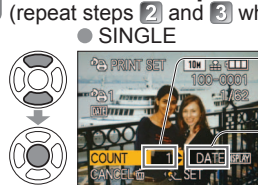

No. to print

Date print set

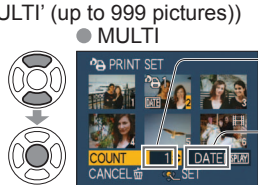

No. to print

Date print set

- Date print setting/release → Press display button.
- After confirmation, press to return to the menu screen.

■ **To release all** → Select 'CANCEL' in step 1 and select 'YES'.

- When using PictBridge-compatible printers, check settings on actual printer as these may take priority over camera settings.
- To print from built-in memory at a shop, first copy pictures to card (P.98) before making settings.
- DPOF print settings may not be made to non-DCF (P.40) files.
- Some DPOF information set by other equipment cannot be used. In such cases, delete all of the DPOF information and then set it again with this camera.
- Date printing settings cannot be made for pictures with a 'TEXT STAMP' applied. These settings will also be canceled if a 'TEXT STAMP' is applied later.
- Motion pictures recorded in 'AVCHD Lite' format cannot be set.

PROTECT

For the PLAYBACK menu setting procedure, see P.18.

Set protection to disable picture deletion. Prevents deletion of important pictures.

Set-up: Press 'MENU/SET' → 'PLAYBACK menu' → Select 'PROTECT'

1 Select 'SINGLE' or 'MULTI'

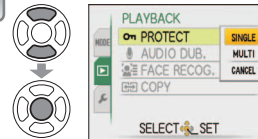

2 Select picture and make setting



Picture protected



Picture protected

- To cancel → Press 'MENU/SET' again.
- After confirmation, press to return to the menu screen.

■ **To release all** → Select 'CANCEL' in step 1 and select 'YES'.

■ **To cancel while releasing all** → Press 'MENU/SET'.

- May not be effective when using other devices.
- Formatting will cause even protected files to be deleted.

AUDIO DUB.

Add audio to previously taken pictures.

Set-up: Press 'MENU/SET' → 'PLAYBACK menu' → Select 'AUDIO DUB.'

1 Select image and start recording



For files already containing audio, select whether or not to overwrite existing audio with , and press 'MENU/SET'.

- To cancel → Press

Do not block microphone with fingers.



2 Stop recording (Recording will automatically end after 10 seconds.)



- After confirmation, press to return to the menu screen.

- Cannot be used with motion pictures or protected pictures. May not be compatible with pictures taken on other devices.

Using PLAYBACK menu (Continued)

REC/PLAY switch: (Set mode dial to any except)
For the PLAYBACK menu setting procedure, see P.18.

COPY

Copy between built-in memory and memory card, or from memory card to clipboard folder.

Set-up: Press 'MENU/SET' → ' PLAYBACK menu' → Select 'COPY'

1 Select copy method (direction)

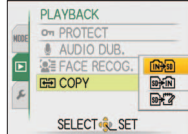
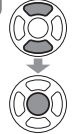

: Copy all pictures from built-in memory to card (go to step 3)

(Clipboard pictures cannot be copied. Use 'COPY' in the clipboard menu (P.82).)

: Copy 1 picture at a time from card to built-in memory.

: Copy 1 picture at a time from card to clipboard folder (in built-in memory) (not motion pictures).

2 Select picture with and set (for and)

3 Select 'YES'

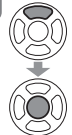

- To cancel → Press 'MENU/SET'
- After confirmation, press to return to the menu screen.

(Screen shown is example)

- If there is not enough space on the built-in memory for copying to be performed, turn off the power, remove the card, and delete pictures from the built-in memory (to delete clipboard pictures, set the mode dial to Clipboard Mode).
- Copying of image data from the built-in memory to memory cards will be terminated midway if there is insufficient space on the card. Using memory cards with higher capacities than the built-in memory (approx. 40 MB) is recommended.
- Copying pictures may take several minutes. Do not turn off power or perform other operations during copying.
- If identical names (folder/file numbers) are present in the copy destination, a new folder for copying will be created when copying from built-in memory to card (). Identically-named files will not be copied from card to built-in memory ().
- DPOF settings will not be copied.
- Only pictures from Panasonic digital cameras (LUMIX) may be copied.
- Original pictures will not be deleted after copying (to delete pictures → P.41).
- This setting can only be made when the Playback Mode is 'NORMAL PLAY' (P.40).
- Motion pictures recorded in 'AVCHD Lite' format cannot be set. [ZS3](#)

Copying recorded pictures

The methods for copying still and motion pictures recorded with this camera to other devices vary according to the file format (JPEG, AVCHD Lite*, Motion JPEG). Follow the correct method for your device.
* [ZS3](#) only

Dubbing playback images via AV cables

Available file types: [Motion](#) AVCHD Lite*, Motion JPEG

Motion pictures recorded with this camera can be dubbed onto DVD or video cassette with a DVD or video recorder. This method is useful as it allows dubbing to be performed even with devices that are not compatible with high definition (AVCHD) images. Picture quality will be reduced from high definition to standard definition.

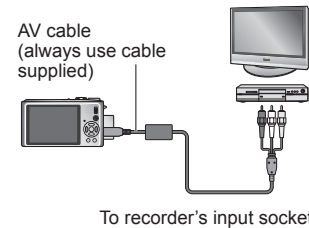

1 Connect camera to recorder

2 Start playback on camera

3 Start recording on recorder

- To stop recording (dubbing), stop the recording on your recorder first before stopping the playback on the camera.

- Do not use any other AV cables except the supplied one.
- When using a TV with a 4:3 aspect ratio, always change the camera's 'TV ASPECT' setting (P.25) to '4:3' before dubbing. Motion pictures copied in the '16:9' setting will appear vertically stretched when viewed on a 4:3 TV screen.
- Pressing the camera's 'DISPLAY' button and turning the LCD display off is recommended during dubbing operations. (P.42)
- For details on dubbing and playback methods, refer to your recorder's operating instructions.

Copying to computers (P.100)

Available file types: [Still](#) JPEG/ [Motion](#) AVCHD Lite*, Motion JPEG

[ZS3](#)

- The 'PHOTOfunSTUDIO' software on the CD-ROM (supplied) can be used to copy still pictures and motion pictures recorded in 'AVCHD Lite*' or Motion JPEG format to your computer, or to create DVD videos from motion pictures recorded in AVCHD Lite format.
- Files and folders containing copied 'AVCHD Lite' motion pictures cannot be played back or edited if they have been deleted, modified, or moved using Windows Explorer or similar methods. Always use 'PHOTOfunSTUDIO' when handling 'AVCHD Lite' motion pictures.

[ZS1](#)

The 'PHOTOfunSTUDIO' software on the CD-ROM (supplied) can be used to copy still pictures and motion pictures to your computer and to play them back.

Using with your PC

Some computers can read directly from the camera's memory card. For details, see the manual for your computer.

Still/motion pictures can be copied from the camera to your computer by connecting the two together.

- Copied pictures can then be printed out or sent by e-mail using the 'PHOTOfunSTUDIO' software on the CD-ROM (supplied).

■ Computer specifications

	Windows			Macintosh
	98/98SE	Me	2000/XP/Vista	OS 9/OS X
Can I use PHOTOfunSTUDIO?	No		Yes*1	No
Can I copy AVCHD Lite motion pictures to my computer? [ZS3]	No		Yes*2	No
Can I copy still pictures and Motion JPEG motion pictures from my camera to my computer via USB cable?	Yes			Yes OS 9.2.2 OS X (10.1 - 10.5)
Do I need to install USB drivers?	Yes		No	-

- USB connection cables cannot be used with Windows 95, Mac OS 8.x, or older versions of either, but still/motion pictures may still be copied with compatible SD memory card reader/writers.

*1 Internet Explorer 6.0 or above must be installed.

Correct playback and operation depends on your computer's environment and cannot always be guaranteed.

*2 Always use 'PHOTOfunSTUDIO' when copying AVCHD Lite motion pictures. [ZS3]

Copying still pictures and motion pictures

Set-up:

- Use a fully charged battery, or connect the AC adaptor (DMW-AC5PP, sold separately) and Multi Conversion Adaptor (DMW-MCA1, sold separately). (P.103)
- Card : Insert card and set mode dial to any except 
- Built-in memory: Remove card

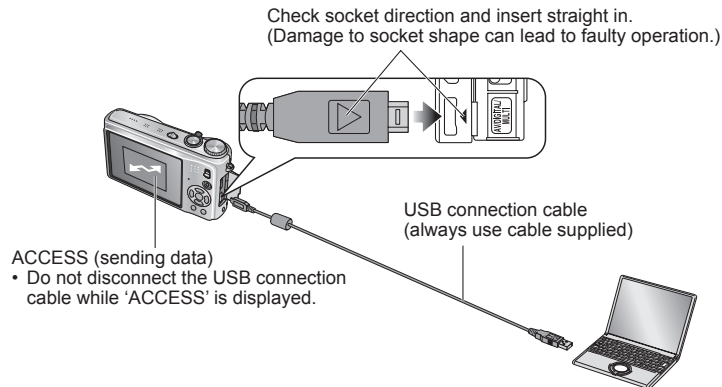

1 Turn on power of both camera and computer

2 Connect camera to computer

Please make sure you use the supplied USB connection cable. Use of cables other than the supplied USB connection cable may cause malfunction.

3 Select 'PC' on the camera

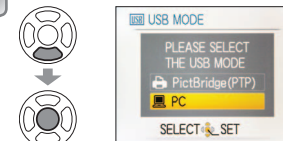

A message may be displayed on screen if 'USB MODE' (P.24) is set to 'PictBridge (PTP)'. Select 'CANCEL' to close the screen, and set 'USB MODE' to 'PC'.

4 Operate with your computer

- **To cancel connection** → Click 'Safely Remove Hardware' in the Windows System Tray → disconnect USB connection cable → turn off camera power → disconnect AC adaptor

Using with your PC (Continued)

You can save images to use on your computer by dragging and dropping folders and files into separate folders on your computer.

Folder and file names on computer

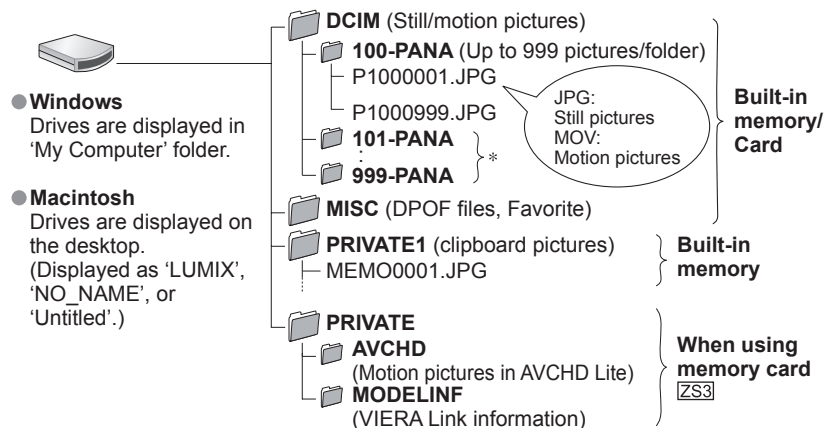

Windows

Drives are displayed in 'My Computer' folder.

Macintosh

Drives are displayed on the desktop. (Displayed as 'LUMIX', 'NO_NAME', or 'Untitled'.)

* New folders are created in the following cases:

- When pictures are taken to folders containing files numbered 999.
- When using cards already containing the same folder number (including pictures taken with other cameras, etc.)
- When recording after performing 'NO. RESET' (P.24)
- File may not be able to be played back on camera after changing file name.
- If mode dial is set to , built-in memory data (including clipboard pictures) are displayed even when card is inserted. Data in card is not displayed.
- **Do not delete or modify folders or data in the AVCHD folder using Windows Explorer or other tools. The camera may be unable to play back the motion pictures correctly if any of these files are deleted or modified. For data management and editing of motion pictures recorded in 'AVCHD Lite', use the 'PHOTOfunSTUDIO' software on the supplied CD-ROM. [ZS3]**

If using Windows XP, Windows Vista, or Mac OS X

The camera can be connected to your computer even if 'USB MODE' (P.24) is set to 'PictBridge (PTP)'.

- Only picture reading operations can be performed via the camera (picture deletion also possible with Windows Vista).
- It may not be possible to read if there are 1000 or more pictures on the card.
- Motion pictures recorded in 'AVCHD Lite' format cannot be read. [ZS3]

Playing motion pictures recorded in 'AVCHD Lite' on your computer [ZS3]

- ① Use the 'PHOTOfunSTUDIO' software on the supplied CD-ROM.
- ② Save the motion picture to your computer, and play it back.

Playing motion pictures recorded in Motion JPEG on your computer

- ① Use the 'QuickTime' software on the supplied CD-ROM.
 - Installed as standard on Macintosh
- ② Save motion pictures to your computer before viewing.

- Do not use any other USB connection cables except the supplied one.
- Turn off power before inserting or removing memory cards.
- If using Windows 98/98SE, install USB driver software when connecting for first time.
- When the battery begins to run out during communication, the status indicator flashes and a warning beep sounds. Cancel communication via your computer immediately (recharge the battery before reconnecting).
- Setting the 'USB MODE' (P.24) to 'PC' remove the need to make the setting each time the camera is connected to the computer.
- For more details, consult your computer operating manual.

Using the Multi Conversion Adaptor (sold separately)

The Multi Conversion Adaptor (DMW-MCA1, optional) enables connection to your computer or printer and to a TV for picture playback with your camera connected to the AC adaptor (DMW-AC5PP, optional) so that you do not have to worry about the battery power level.

Connection example

Check socket direction and insert straight in. (Damage to socket shape can lead to faulty operation.)

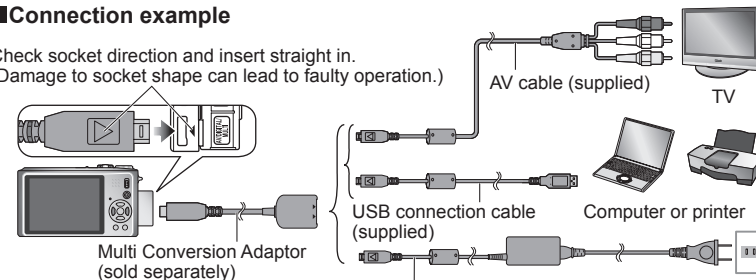

AC adaptor (sold separately)

- Do not connect and disconnect the camera while the power is set to ON.

- Always use a genuine Panasonic AC adaptor (DMW-AC5PP; optional).
- Do not use any other AV cables except the supplied one.
- Do not use any other adaptors except a genuine Panasonic multi conversion adaptor (DMW-MCA1; optional).

Printing

You can connect directly to a PictBridge-compatible printer for printing.

Set-up:

- Use a fully charged battery, or connect the AC adaptor (DMW-AC5PP, sold separately) and Multi Conversion Adaptor (DMW-MCA1, sold separately). (P.103)
- Card : Insert card
- Built-in memory: Remove card (Copy clipboard pictures to the card (P.82))
- Adjust settings on your printer (print quality, etc.) as required.
- Set mode dial to any setting other than CLIPBOARD.
- Do not disconnect the USB connection cable when the cable disconnection icon  is displayed (may not be displayed with some printers).

Check socket direction and insert straight in. (Damage to socket shape can lead to faulty operation.)

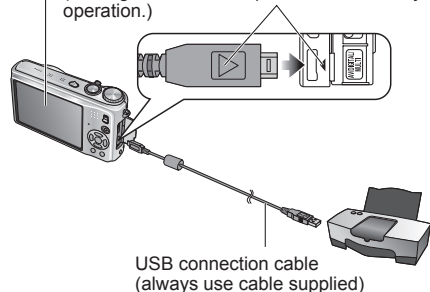

USB connection cable (always use cable supplied)

■ To cancel print → Press 'MENU/SET'

- Do not use any other USB connection cables except the supplied one.
- Disconnect USB connection cable after printing.
- Turn off power before inserting or removing memory cards.
- When the battery begins to run out during communication, the status indicator flashes and a warning beep sounds. Cancel printing and disconnect USB connection cable (recharge the battery before reconnecting).
- Setting the 'USB MODE' (P.24) to 'PictBridge (PTP)' removes the need to make the setting each time the camera is connected to the printer.
- Motion pictures recorded in 'AVCHD Lite' format cannot be printed. [ZS3](#)

1 Turn on power of both camera and printer

2 Connect camera to printer

Please make sure you use the supplied USB connection cable. Use of cables other than the supplied USB connection cable may cause malfunction.

3 Select 'PictBridge (PTP)' on the camera

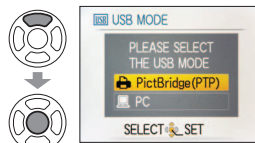

When 'CONNECTING TO PC...' is displayed, cancel the connection and set 'USB MODE' to either 'SELECT ON CONNECTION' or 'PictBridge(PTP)' (P.24).

4 Select picture to print with ◀▶ and set

5 Select 'PRINT START'

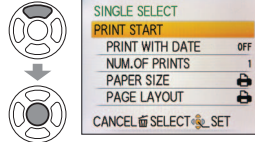

(Print settings → P.106)

Some printers can print directly from the camera's memory card. For details, see the manual for your printer.

Printing multiple pictures

- 1 Select 'MULTI PRINT' in step 4 on the previous page
- 2 Select item (See below for details)
- 3 Select 'PRINT START'

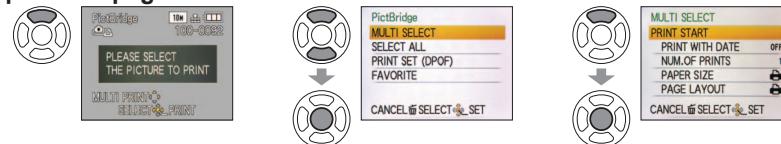

• To cancel → Press 'MENU/SET'

- **MULTI SELECT** : ① Scroll between pictures with ▲▼◀▶, select pictures with display button to print. (Press display button again to release selection.)
② Press 'MENU/SET' when selection is complete.
- **SELECT ALL** : Print all pictures.
- **PRINT SET (DPOF)** : Print pictures selected in 'PRINT SET' (P.96).
- **FAVORITE** : Print pictures selected as 'FAVORITE' (P.95). (displayed only when 'FAVORITE' pictures present and setting set to 'ON').
- Select 'YES' if print confirmation screen is displayed.
- An orange ● displayed during printing indicates an error message.
- Print may be divided into different stints if printing several pictures. (Remaining sheets display may differ from set number.)

Print with date and text

■ With 'TEXT STAMP'

Recording date and following information can be embedded into photographs (P.90).

- Recording date
- NAME and AGE from 'BABY' and 'PET' scene modes
- 'TRAVEL DATE' elapsed days and destination
- Text registered in 'TITLE EDIT'
- Names registered in 'FACE RECOG.' [ZS3](#)
 - Do not add date printing in stores or with printers to pictures where 'TEXT STAMP' is applied (text may overlap).

■ Printing date without 'TEXT STAMP'

- Printing in store: Only recording date can be printed. Request date printing in store.
 - Making 'PRINT SET' (P.96) settings on the camera in advance allows settings for numbers of copies and date printing to be designated before giving the card to the store.
 - When printing pictures of 16:9 aspect ratio, check in advance that the store can accept this size.
- Using computer : Print settings for recording date and text information can be made using the supplied CD-ROM (PHOTOfunSTUDIO).
- Using printer : Recording date can be printed by setting 'PRINT SET' on the camera, or by setting 'PRINT WITH DATE' (P.106) to 'ON' when connecting to a printer compatible with date printing.

Printing (Continued)

Making print settings on camera

(Make settings before selecting 'PRINT START')

① Select item

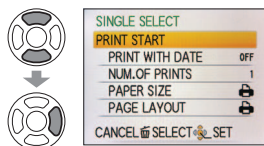

② Select setting

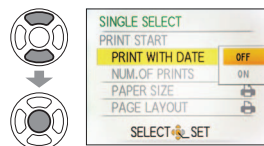

Item	Settings
PRINT WITH DATE	OFF/ON
NUM. OF PRINTS	Set number of pictures (up to 999 pictures)
PAPER SIZE	<div style="display: flex; justify-content: space-between;"> <div style="width: 45%;"> <p> (printer takes priority)</p> <p>L/3.5"×5" (89×127 mm)</p> <p>2L/5"×7" (127×178 mm)</p> <p>POSTCARD (100×148 mm)</p> <p>16:9 (101.6×180.6 mm)</p> <p>A4 (210×297 mm)</p> </div> <div style="width: 45%;"> <p>A3 (297×420 mm)</p> <p>10×15 cm (100×150 mm)</p> <p>4"×6" (101.6×152.4 mm)</p> <p>8"×10" (203.2×254 mm)</p> <p>LETTER (216×279.4 mm)</p> <p>CARD SIZE (54×85.6 mm)</p> </div> </div>
PAGE LAYOUT	(printer takes priority) / (1 picture, no border) / (1 picture, with border) / (2 pictures) / (4 pictures)

- Items may not be displayed if incompatible with printer.
- To arrange '2 pictures' or '4 pictures' in the same picture, set the number of prints for the picture to 2 or 4.
- To print to paper sizes/layouts not supported by this camera, set to and make settings on the printer. (Consult your printer's operating manual.)
- 'PRINT WITH DATE' and 'NUM. OF PRINTS' items are not shown when print settings (DPOF) have been made.
- Even if print settings (DPOF) are made, dates may not be printed with some shops or printers.
- When setting 'PRINT WITH DATE' to 'ON', check the date printing settings on the printer (printer settings may be prioritized).

Viewing on TV screen

You can view pictures on a TV screen by connecting your camera to your TV with the AV cable (supplied) or HDMI mini cable (sold separately [ZS3]).

● Also consult TV operating manual.

1 Connect camera to TV

2 Turn on TV

● Set to auxiliary input.

3 Turn on camera

- Set-up:**
- Set 'TV ASPECT'. (P.25)
 - Turn off both camera and TV.

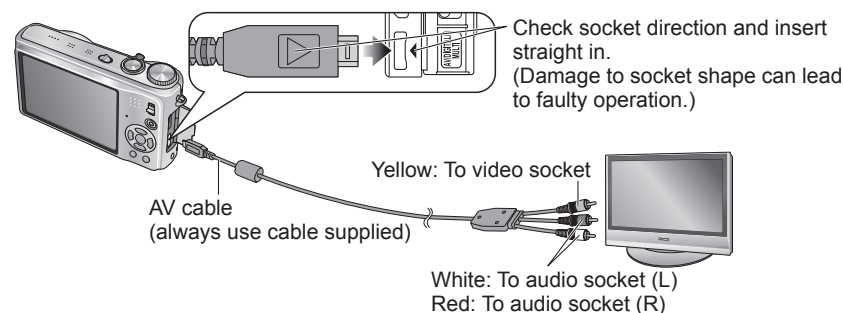

■ When TVs or DVD recorders have an SD card slot

- ➡ Insert the SD memory card into the SD card slot
 - Pictures only can be played back.
 - Motion pictures recorded in 'AVCHD Lite' may be played on Panasonic televisions (VIERA) displaying the AVCHD logo. [ZS3] To play motion pictures on other televisions, please connect the camera to the television with the AV cable (supplied).
 - When using an SDHC memory card, play back in the SD card slot of the SDHC-compatible device.
 - Multimedia cards may not always be compatible.

- Do not use any other AV cables except the supplied one.
- When connected with AV cable, image will not be displayed on TV in following cases.
 - During recording motion pictures
 - BURST recording
 - 'HI-SPEED BURST' or 'FLASH BURST' scene modes recording.
- 'LCD MODE' setting is not reflected on TV.
- Some televisions may cut off the edges of pictures, or not display them full screen. Pictures rotated to portrait may be blurred slightly.
- Change picture mode settings on TV if aspect ratios are not displayed correctly on widescreen or high-definition televisions.

Viewing on TV screen (Continued)

Viewing on a TV with HDMI Socket ZS3

An HDMI mini cable (sold separately) can be used to enable enjoyment of pictures and motion pictures in high resolution.

What is HDMI?

High-Definition Multimedia Interface (HDMI) is an interface for digital video devices. Digital video and audio signals can be outputted by connecting the camera to an HDMI-compatible device. This camera can be connected to a High-definition TV compatible with HDMI to enjoy recorded pictures and motion pictures at high resolution. Connecting the camera to a Panasonic TV (VIERA) compatible with VIERA Link (HDMI) enables linked operation (VIERA Link). (P.109)

Preparation:

- Check the 'HDMI MODE'. (P.25)
- Turn off the camera and TV.

Check the socket direction and insert straight in. (Damage to socket can lead to faulty operation.)



- Do not use any other cables except a genuine Panasonic HDMI mini cable (RP-CDHM15/RP-CDHM30; optional).
- Playback cannot be performed in CLIPBOARD Mode.
- Blank stripes may appear at the sides or at the top and bottom of the screen, depending on aspect ratio setting.
- Cables that do not comply with HDMI standards will not work.
- Pictures cannot be simultaneously displayed on the LCD monitor.
- We recommend taking pictures with a 'PICTURE SIZE' (P.69) setting of at least 2 M and recording motion pictures with 'REC QUALITY' (P.80) set to 'SH', 'H', 'L', or 'HD'.
- Following functions cannot be set in Playback Mode: TITLE EDIT, TEXT STAMP, RESIZE, TRIMMING, LEVELING, ASPECT CONV., AUDIO DUB., FACE RECOG., COPY, multiple selection (delete, etc.), etc.
- HDMI output will be canceled if a USB connection cable is connected simultaneously.
- No picture output will occur through AV cables connected.
- When playing motion pictures/pictures with audio recorded with other devices, video/audio may not always be played back correctly.
- Images may be momentarily distorted immediately after commencing playback or pausing on certain televisions.
- Always read your television's operating instructions.
- 'HDMI MODE' (P.25) '1080i' is only effective in the following cases:
 - MODE PLAY 'PICTURE' is selected
 - SLIDESHOW 'PICTURE ONLY' is selected
 - SLIDESHOW 'CATEGORY SELECTION' is selected (except for Travel date)
- In all other cases, images will be outputted as '720p'.
- Audio output is stereo.

VIERA Link (HDMI) (HDAVI Control™) ZS3

What is VIERA Link (HDMI)?

- VIERA Link™ is a new name for EZ Sync™.
- VIERA Link is a function that automatically links this camera to VIERA Link-compatible devices by connecting HDMI mini cables (sold separately) for enabling easy operation with the VIERA remote control. (Some operations are not available.)
- VIERA Link (HDMI) is an exclusive Panasonic function added to the industry-standard HDMI control functions known as HDMI CEC (Consumer Electronics Control). Operation is not guaranteed when connecting with non-Panasonic HDMI CEC-compatible devices. Refer to your product manual to verify compatibility with VIERA Link (HDMI).
- This camera supports VIERA Link (HDMI) Version 4. This is the latest Panasonic standard that also supports previous Panasonic VIERA Link devices. (As of December 2008)

Preparation: • Set 'VIERA Link' to 'ON'. (P.26)

- 1 Connect the camera to a VIERA Link (HDMI)-compatible Panasonic television (VIERA) with an HDMI mini cable (sold separately) (P.108).
- 2 Use the VIERA remote control to perform the desired operations.

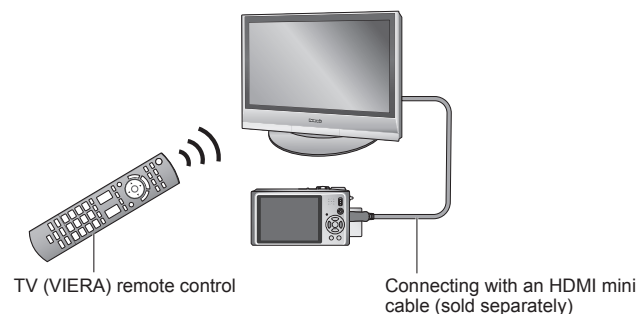

- Do not use any other cables except a genuine Panasonic HDMI mini cable (RP-CDHM15/RP-CDHM30; optional).
- The shape of remote control will differ depending on the country or area where the TV was purchased.

Viewing on TV screen (Continued)

Available functions

Use your television's remote control to operate the camera.

(1) Multiple playback

Press the red button on your television's remote control to switch between the types of data to be played.

• Playback data type options can be scrolled as follows:
'ALL' → → → → 'ALL'

Use to select image, and press 'OK' to display as single image.

Slideshow settings and other options can be accessed by pressing the 'SUBMENU' button.

(2) Single image display

Press to scroll between images.

Press to display recording information.

Press to return to (1) multiple playback.

● If single image display has been accessed from 'ALL' or

Press 'OK' to start (3) slideshow.

● If single image display has been accessed from or

Press 'OK' to start motion picture playback.

Press to rewind/fast forward, or to stop playback.

(3) Slideshow

Press 'OK' to start/pause the slideshow.

Press while paused to scroll between motion pictures.

Press to stop slideshow and return to (2) single image display.

● **To play motion picture audio during slideshows:**

To play motion picture audio during slideshows when 'ALL' has been selected, press 'SUBMENU', and in the 'Slideshow' settings, set 'Effect' to off and 'Audio' to on.

● **Display/hide operation icons**

Operation icons can be hidden by pressing 'RETURN'. When operations are hidden, they can be re-displayed by pressing 'SUBMENU'.



Operation icons



Operation icons

Other related operations

● Power OFF

The camera's power can also be switched off when switching the television's power off with the remote control.

● Automatic input select

• This function automatically switches the television input to the camera screen whenever the camera's power is switched on while it is connected via the HDMI mini cable. The television can also be switched on via the camera from standby mode (if 'Power on link' on the television is set to 'ON').

• The input setting may not be able to be changed automatically with certain television HDMI sockets. In this case, please change the input setting with your television's remote control (consult your television's operating instructions for details).

• Refer to P.120 if VIERA Link (HDMI) does not function correctly.

● If you are unsure whether or not the TV you are using are compatible with VIERA Link, read the operating instructions for the devices.

● If the 'VIERA Link' setting on the camera (P.26) is 'ON', operations via the camera buttons will be limited.

● Ensure that the television you are connecting to has been set up to enable VIERA Link (HDMI) (consult your television's operating instructions for details).

● If you do not wish to use VIERA Link (HDMI), turn the camera's 'VIERA Link' setting (P.26) 'OFF'.

● 'HDMI MODE' (P.25) '1080i' is only effective in the following cases:

- The tab on the TV screen is selected
 - SLIDESHOW 'PICTURE ONLY' is selected
 - SLIDESHOW 'CATEGORY SELECTION' is selected (except for Travel date)
- In all other cases, images will be outputted as '720p'.

● If the tab on the TV screen is selected while 'HDMI MODE' (P.25) is set to 'AUTO' or '1080i', the screen will go back before the single picture playback display resumes. This is not a fault.

● If the tab on the TV screen is selected, it will not be possible to select either (Travel date), (AVCHD Lite), or (MOTION JPEG) in SLIDESHOW 'CATEGORY SELECTION'.

List of LCD monitor displays

Press the display button to change display (P.12, 42).

In recording

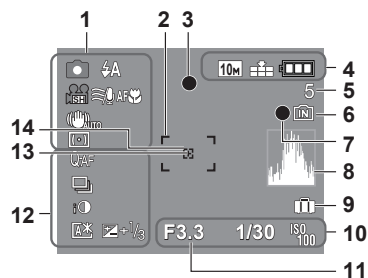

- 1 Recording mode*
([ZS3] P.29, [ZS1] P.31)
- Recording quality [ZS3] (P.80)
- Flash mode (P.43)
- Optical image stabilizer (P.77)
- Jitter alert (P.35)
- Metering mode (P.75)
- Wind cut [ZS3] (P.80)
- AF tracking (P.34)
- Macro recording (P.45)
- Tele macro (P.45)
- 2 AF area (P.35)
- 3 Focus (P.35)
- 4 Picture size (P.69)
- Recording quality [ZS1] (P.80)
- Quality (P.70)
- Battery capacity (P.16)

- 5 Number of recordable pictures
([ZS3] P.124, [ZS1] P.126)
 - 6 Save destination (P.16)
 - 7 Recording state
 - 8 Histogram (P.42)
 - 9 Travel date (P.67)
 - 10 **F3.3** Aperture value (P.35)
 - 1/30** Shutter speed (P.35)
 - ISO 100** ISO sensitivity (P.71)
 - i ISO** Intelligent ISO (P.70)
 - 11 Focus range (P.47)
 - Zoom (P.37)
 - Macro zoom (P.46)
 - W** Pre AF (P.75)
 - 12 **CAF** Pre AF (P.75)
 - CAF** CONTINUOUS AF (P.80)
 - B** Burst mode (P.76)
 - AB** Auto bracket (P.49)
 - MA** Multi aspect [ZS3] (P.50)
 - IE** Intelligent exposure (P.76)
 - HA** High angle mode [ZS1] (P.22)
 - AP** Auto power LCD (P.22)
 - PL** Power LCD (P.22)
 - +1/3** Exposure compensation (P.49)
 - 13 Spot metering target (P.75)
 - 14 Spot AF area (P.74)
- CLIPBOARD Mode (P.81)
 - * Clipboard recording mode

In playback

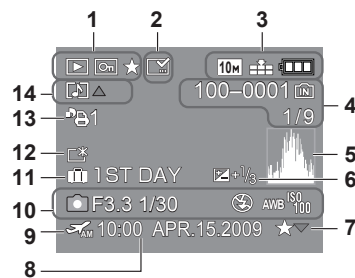

- 1 PLAYBACK mode*1 (P.40)
- Protected picture (P.97)
- Favorites*2 (P.95)
- 2 Text stamped display (P.90)
- 3 Picture size*3 (P.69)
- Quality (P.70)
- Battery capacity (P.16)
- 4 **100-0001** Folder/File number*4
(P.24, 40, 102)
- Save destination (P.16)
- 1/9** Picture number/Total pictures
- 5 Histogram*5 (P.42)

- 6 Exposure compensation (P.49)
 - 7 Favorites settings (P.95)
 - 8 Recorded date and time
Travel destination setting (P.67)/Name (P.55)/
Title (P.89)
 - 9 Destination settings (P.68)
 - 10 Recording information
1 month 10 days Age in years/months (P.55)
 - 11 Travel elapsed days (P.67)
 - 12 Power LCD (P.22)
 - 13 Number of DPOF prints (P.96)
 - 14 Motion pictures
([ZS3] P.61, [ZS1] P.64)
 - Picture with audio (P.84)
 - Cable disconnection warning icon (P.104)
- CLIPBOARD Mode (P.81)
 - *1 Clipboard playing mode
 - *2 Zoom mark
 - MOTION PICTURE (P.84)
 - *3 **VGA WVGA QVGA** (DMC-ZS1 only)
 - *4 Elapsed playback time **XXhXXmXXs**
 - *5 Motion picture recording time
 - *6 Recording mode

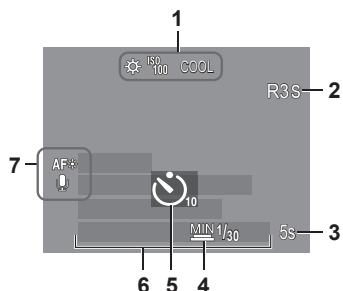

- 1 White balance (P.72)
- ISO 100** ISO sensitivity (P.71)
- ISO MAX 400 / ISO MAX 800 / ISO MAX 1600** ISO LIMIT (P.70)
- COOL** Color mode (P.77)
- 2 Available recording time ([ZS3] P.61, [ZS1] P.64)
- 3 **5s** Elapsed recording time ([ZS3] P.61, [ZS1] P.64)
- 4 **MIN 1/30** Minimum shutter speed (P.78)
- 5 Self-timer mode (P.48)
- 6 Travel elapsed days (P.67)
- Name (P.55)/Travel Location (P.67)
- Age in years/months (P.55)
- Current date/time
- 7 AF assist lamp (P.78)
- Audio recording (P.78)

The appearance, specifications, and screen display vary depending on the model that is used.

Message displays

Meanings of and required responses to major messages displayed on LCD monitor.

THIS MEMORY CARD IS LOCKED

- Release using the write-protect switch on the SD memory card or SDHC memory card. (P.16)

NO VALID PICTURE TO PLAY

- Take pictures, or insert a different card already containing pictures.

THIS PICTURE IS PROTECTED

- Release the protection before deleting, etc. (P.97)

SOME PICTURES CANNOT BE DELETED/THIS PICTURE CANNOT BE DELETED

- Non-DCF images (P.40) cannot be deleted.
→ Save all necessary data to computer (or other device), and 'FORMAT' (P.26) card to delete.

NO ADDITIONAL SELECTIONS CAN BE MADE

- The number of pictures that can be deleted at once has been exceeded.
- More than 999 pictures have been set as 'FAVORITE'.
- The number of pictures that can be set at once in 'RESIZE (MULTI)', 'TEXT STAMP', or 'TITLE EDIT' has been exceeded.

CANNOT BE SET ON THIS PICTURE

- DPOF settings, 'TITLE EDIT', or 'TEXT STAMP' cannot be made for non-DCF images (P.40).

PLEASE TURN CAMERA OFF AND THEN ON AGAIN

- Force has been applied to lens (or other component) and camera could not operate correctly.
→ Turn on power again.
(Consult the dealer or your nearest Service Center if display still remains)

SOME PICTURES CANNOT BE COPIED/COPY COULD NOT BE COMPLETED

- Pictures cannot be copied in following cases.
 - Picture of same name already exists in built-in memory when copying from card.
 - File is not of DCF standard (P.40).
 - Picture taken or edited on a different device.

NOT ENOUGH SPACE ON BUILT-IN MEMORY/NOT ENOUGH MEMORY ON THE CARD

- There is no space left on the built-in memory or the card.
→ When you copy images from the built-in memory to the card (batch copy), the images are copied until the capacity of the card becomes full.

BUILT-IN MEMORY ERROR FORMAT BUILT-IN MEMORY?

- Displayed when formatting built-in memory via computer, etc.
→ Reformat directly using camera (P.26). Data will be deleted.

MEMORY CARD ERROR FORMAT THIS CARD?

- Card cannot be recognized on this camera.
→ Save all necessary data to computer (or other device), and 'FORMAT' (P.26).

MEMORY CARD ERROR PLEASE CHECK THE CARD

- Access to card has failed.
→ Insert card again.
- Try with a different card.

MEMORY CARD ERROR MEMORY CARD PARAMETER ERROR

- Card is not of SD standard. Only SDHC memory cards can be used for capacities of 4 GB or greater.

READ ERROR/WRITE ERROR PLEASE CHECK THE CARD

- Data read has failed.
→ Check whether card has been inserted correctly (P.15).
- Data write has failed.
→ Turn off power and remove card, before re-inserting and turning on power again.
- Card may possibly be damaged.
- Try with a different card.

MOTION RECORDING WAS CANCELLED DUE TO THE LIMITATION OF THE WRITING SPEED OF THE CARD

- Using a card of SD speed 'Class 6*' or above is recommended for recording motion pictures.
* The SD speed class is a speed rating for continuous writing.
- Using a high-speed card with a specified speed (e.g. on packaging) of at least 10 MB/s is recommended when 'REC QUALITY' is set to 'HD', 'WVGA', or 'VGA'.
- If recording stops even when using a 'Class 6' card or card with speed of '10 MB/s' or faster, the data writing speed is low. We recommend backing up the data on the memory card and reformatting it (P.26).
- Motion picture recording may be automatically terminated with certain cards.

A FOLDER CANNOT BE CREATED

- Folder numbers in use have reached 999.
→ Save all necessary data to computer (or other device), and 'FORMAT' (P.26).
Folder number is reset to 100 when performing 'NO.RESET' (P.24).

PICTURE IS DISPLAYED FOR 4:3 TV/PICTURE IS DISPLAYED FOR 16:9 TV

- AV cable is connected to camera.
 - To remove message immediately → Press 'MENU/SET'.
 - To change aspect ratio → Change 'TV ASPECT' (P.25).
- USB connection cable is only connected to camera.
→ Message disappears when cable is also connected to another device.

THIS BATTERY CANNOT BE USED

- Use a genuine Panasonic battery (DMW-BCG10PP).
- Battery cannot be recognized as terminal is dirty.
→ Wipe any dirt away from the battery terminal.

NO BATTERY POWER REMAINS

- The battery level is low.
→ Charge the battery before use. (P.13)

Try checking these items (P.116 - 121) first.
(Restoring menu settings to default values may solve certain problems.
Try using 'RESET' in SETUP menu in recording mode (P.24).)

Battery, power

Camera does not work even if power is turned on.

- Battery is not inserted correctly (P.15), or needs recharging (P.13).

LCD monitor shuts off even if power is turned on.

- Camera is set to 'POWER SAVE' or 'AUTO LCD OFF' (P.23).
→ Press shutter button halfway to release.
- Battery needs recharging.

Camera switches off as soon as power is turned on.

- Battery needs recharging.
- Camera is set to 'POWER SAVE'. (P.23)
→ Press shutter button halfway to release.

This unit is turned off automatically. [ZS3]

- If you connect to a TV compatible with VIERA Link with an HDMI mini cable (optional) and turn off the power on the TV with the remote control for the TV, the power on this unit also turns off.
→ If you are not using VIERA Link, set 'VIERA Link' to 'OFF'. (P.26)

Recording

Cannot record pictures.

- REC/PLAY switch is not set to  (record).
- Built-in memory/card is full. → Free space by deleting unwanted pictures (P.41).

Cannot record to cards.

- Do not format cards on other equipment.
→ Please format cards with this camera. (P.26)
- For details about compatible cards, see P.16.

Recording capacity is low.

- Battery needs recharging.
→ Use a fully charged battery (not sold pre-charged). (P.13)
→ If you leave the camera on, the battery will be exhausted. Turn the camera off frequently by using 'POWER SAVE' or 'AUTO LCD OFF' (P.23) etc.
- Please check the recording picture capacity for cards and built-in memory. ([ZS3] P.124, [ZS1] P.126)

Recorded pictures look white.

- Lens is dirty (fingerprints, etc.).
→ Turn on power to extract lens barrel, and clean lens surface with a soft, dry cloth.
- Lens is foggy (P.10).

Recorded pictures are too bright/too dark.

- Pictures taken in dark locations, or bright subjects (snow, bright conditions, etc.) occupy most of the screen. (Brightness of LCD monitor may differ from that of actual picture) → Adjust the exposure (P.49).
- 'MIN. SHTR SPEED' is set to fast speeds, e.g. '1/250' (P.78).

2-3 pictures are taken when I press the shutter button just once.

- Camera set to use 'AUTO BRACKET' (P.49), 'MULTI ASPECT [ZS3]' (P.50), 'BURST' (P.76), or the 'HI-SPEED BURST' (P.56) or 'FLASH BURST' (P.57) scene modes.

Recording (continued)

Focus not aligned correctly.

- Not set to mode appropriate for distance to subject. (Focus range varies according to recording mode.)
- Subject outside of focus range.
- Caused by jitter or subject movement (P.70, 77).

Recorded pictures are blurred. Optical image stabilizer ineffective.

- Shutter speed is slower in dark locations and Optical image stabilizer is less effective.
→ Hold camera firmly with both hands, keeping arms close to body.
- Use a tripod and the self-timer (P.48) when using slower shutter speed with 'MIN. SHTR SPEED'.

Cannot use 'AUTO BRACKET' or 'MULTI ASPECT [ZS3]'.

- Only enough memory for 2 pictures or fewer.

Recorded pictures appear coarse, or there is interference.

- ISO sensitivity is high, or shutter speed is low. (Default SENSITIVITY setting is 'AUTO' – interference may appear with indoor pictures.)
→ Lower 'SENSITIVITY' (P.71).
→ Set 'COLOR MODE' to 'NATURAL' (P.77)
→ Take pictures in brighter locations.
- Camera set to 'HIGH SENS.' or 'HI-SPEED BURST' scene modes. (Picture becomes slightly coarser in response to high sensitivity)

Pictures appear dark or have poor coloring.

- Colors may appear unnatural due to the effects of light source.
→ Use WHITE BALANCE to adjust the coloring. (P.72)

Brightness or coloring of recorded picture different from real life.

- Taking pictures under fluorescent lighting may require a faster shutter speed and result in slightly changed brightness or coloring, but this is not a fault.

Reddish vertical line (smear) appears during recording.

- This is a characteristic of CCD and may appear if subject contains brighter areas. Some blurring may occur around these areas, but this is not a fault. This will be recorded in motion pictures, but not in still pictures.
- We recommend keeping the screen away from strong light sources such as sunlight when taking pictures.



Motion picture recording stops midway.

- Using MultiMediaCard (not compatible with motion picture recording).
- Using a card of SD speed 'Class 6'* or above is recommended for recording motion pictures.
* The SD speed class is a speed rating for continuous writing.
- Using a high-speed card with a specified speed (e.g. on packaging) of at least 10 MB/s is recommended when 'REC QUALITY' is set to 'HD', 'WVGA', or 'VGA'.
- If recording stops even when using a 'Class 6' card or card with speed of '10 MB/s' or faster, the data writing speed is low. We recommend backing up the data on the memory card and reformatting it (P.26).
- With some cards, access display may appear briefly after recording, and recording may end midway.

The subject cannot be locked. (AF track fails)

- If the subject has different colors as the periphery, set the AF area to those colors specific to the subject by aligning that area with the AF area. (P.73)

LCD monitor

LCD monitor dims during motion picture recording.

- LCD monitor may dim if continuing motion picture recording for long periods.

Monitor sometimes shuts off even though power is on.

- Camera set to 'AUTO LCD OFF' (P.23).
- After recording, monitor shuts off until next picture can be recorded. (Approx. 6 seconds (Max.) when recording to the built-in memory)

Brightness is unstable.

- Aperture value is set while shutter button is pressed halfway. (Does not affect recorded picture.)

Monitor flickers indoors.

- Monitor may flicker after turning on (prevents influence from fluorescent lighting).

Monitor is too bright/too dark.

- Adjust 'MONITOR' setting (P.21).
- Camera set to 'LCD MODE' (P.22).

Black/blue/red/green dots or interference appears. Monitor looks distorted when touched.

- This is not a fault, and will not be recorded on the actual pictures, so there is no need to worry.

Date/age is not displayed.

- Current date, 'TRAVEL DATE' (P.67), and ages in 'BABY' and 'PET' (P.55) scene modes are only displayed for approx. 5 sec. after start-up, setting changes, or mode changes. They cannot be always displayed.

Flash

No flash emitted.

- Flash set to 'FORCED FLASH OFF' (P.43).
- When set to 'AUTO' (P.43), flash may not be emitted in certain conditions.
- Flash cannot be emitted in the 'SCENERY', 'PANORAMA ASSIST', 'NIGHT SCENERY', 'SUNSET', 'HI-SPEED BURST', 'FIREWORKS', 'STARRY SKY', and 'AERIAL PHOTO' scene modes, or when using 'AUTO BRACKET' or 'BURST'.
- No flash is emitted when recording a motion picture.

Multiple flashes are emitted.

- Red-eye reduction is active (P.43). (Flashes twice to prevent eyes appearing red.)
- The scene mode is set to 'FLASH BURST'.

Playback

Pictures have been rotated.

- 'ROTATE DISP.' is set to 'ON'. (Automatically rotates pictures from portrait to landscape. Some pictures taken facing up or facing down may be interpreted as being portrait.)
→ Set 'ROTATE DISP.' to 'OFF'.

Playback (continued)

Cannot view pictures.

- REC/PLAY switch is not set to (▶) (play).
- No pictures in built-in memory or card (pictures played from card if inserted, from built-in memory if not).
- Camera set to 'CATEGORY PLAY' or 'FAVORITE PLAY'.
→ Set playback mode to 'NORMAL PLAY' (P.85).

Folder/file number displayed as '?'. Picture is black.

- Picture edited on computer or taken on different device.
- Battery removed immediately after picture taken, or picture taken with low battery.
→ Use 'FORMAT' to delete (P.26).

Incorrect date displayed in calendar playback.

- Picture edited on computer or taken on different device.
- 'CLOCK SET' is incorrect (P.17).
(Incorrect date may be displayed in calendar playback on pictures copied to computer and then back to camera, if computer and camera dates differ.)

Depending on the subject, an interference fringe may appear on the screen.

- This is called moire. This is not a malfunction.

White round spots like soap bubbles appear on the recorded picture.

- If you take a picture with the flash in a dark place or indoors, white round spots may appear on the picture caused by the flash reflecting particles of dust in the air. This is not a fault. A characteristic of this is that the number of round spots and their position differ in every picture.



Blacken red areas of recorded pictures.

- If subjects in pictures taken with RED-EYE reduction flash settings (P.43) contain patterns where areas of red are surrounded by colors close to skin colors, the digital red-eye correction function may cause these red areas to be blackened.
→ In such cases, using (P.43) or (P.43) flash modes is recommended.

Sounds of camera operations will be recorded in motion pictures.

- Camera operation sounds may be recorded as camera automatically adjusts lens aperture during motion picture recording; this is not a fault.

Motion pictures and pictures with audio taken by this camera cannot be played in other cameras.

- Motion pictures and pictures with audio taken with this camera may not always be able to be played back with cameras by other manufacturers. Playback may also not be possible with certain Panasonic digital cameras (LUMIX).* (ZS3)
* Cameras launched before December 2008, and some cameras launched in 2009 (FS, LS Series).
- In some cases, motion pictures and pictures with audio taken by this camera cannot be played back by digital cameras from other companies, and they also cannot be played in Panasonic digital cameras (LUMIX) that were sold before July 2008. (ZS1)
- Motion pictures recorded in 'AVCHD Lite' format cannot be played in devices that do not support AVCHD. In some cases, motion pictures cannot be played back correctly in AVCHD-compatible devices. (ZS3)

TV, computer, printer

No image appears on TV. Image blurred or not colored.

- Not connected correctly (P.107, 108).
- TV input setting not set to auxiliary input.
- TV is not compatible with SDHC memory card. (When using SDHC memory card)

TV screen display different to LCD monitor.

- Aspect ratio may be incorrect or edges may be cut off with certain televisions.

Cannot play motion pictures on TV.

- Card is inserted into TV.
 - Connect with AV cable (supplied) or HDMI mini cable (RP-CDHM15 (1.5 m, 4.9 feet) or RP-CDHM30 (3.0 m, 9.8 feet), sold separately) [ZS3] and play on camera (P.107, 108).

Picture is not displayed on full TV screen.

- Check 'TV ASPECT' settings (P.25).

VIERA Link (HDMI) is not working. [ZS3]

- Is the HDMI mini cable (sold separately) connected correctly? (P.108)
 - Check that the HDMI mini cable (sold separately) is fully inserted.
- Is the camera's 'VIERA Link' setting set to 'ON'? (P.26)
 - The input setting may not be able to be changed automatically with certain television HDMI sockets. In this case, please change the input setting with your television's remote control (consult your television's operating instructions for details).
 - Check the VIERA Link (HDMI) settings on the device you are connecting to.
 - Turn the camera's power off and on again.
 - Turn the 'VIERA Link control (HDMI device control)' setting on your television (VIERA) to 'OFF', and then to 'ON' again. (Consult your VIERA's operating instructions for details.)

Cannot send pictures to computer.

- Not connected correctly (P.101).
- Check whether computer has recognized camera.
- Set 'USB MODE' to 'PC' (P.24).

Computer does not recognize card (only reads built-in memory).

- Disconnect USB connection cable and reconnect with card in place.
- Set mode dial to any except [P].

I want to play computer pictures on my camera.

- Use the supplied software PHOTOfunSTUDIO to copy pictures from computer to camera. To save to clipboard, use software to copy from computer to card, then copy to clipboard folder with 'COPY' (P.98) in PLAYBACK menu.

Cannot print when connecting to printer.

- Printer not compatible with PictBridge.
- Set 'USB MODE' to 'PictBridge (PTP)' (P.24).

Cannot get the date printing.

- Make date printing settings before printing.
 - In shop: Make PRINT SET settings (P.96), and request printing 'with dates'.
 - With printer: Make PRINT SET settings, and use a printer compatible with date printing.
 - With supplied software: Select 'with dates' within print settings.
- Use 'TEXT STAMP' before printing (P.90).

TV, computer, printer (continued)

Edges cut off pictures when printing.

- Release any trimming or edgeless printing settings on printer before printing. (Consult printer operating manual.)
- Pictures taken on [16:9] 'ASPECT RATIO'.
 - If printing in shop, check if 16:9 sizes can be printed.

Others

Menu not displayed in desired language.

- Change 'LANGUAGE' setting (P.26).

Camera rattles if shaken.

- This sound is made by the lens movement and is not a fault.

Cannot set 'AUTO REVIEW'.

- Cannot be set when any of the following are in use: 'AUTO BRACKET', 'MULTI ASPECT [ZS3]', 'BURST', 'SELF PORTRAIT', 'HI-SPEED BURST', and 'FLASH BURST' scene modes, and 'AUDIO REC.'.

Red lamp illuminated when pressing shutter halfway in dark locations.

- 'AF ASSIST LAMP' set to 'ON' (P.78).

AF ASSIST LAMP is not illuminated.

- 'AF ASSIST LAMP' is set to 'OFF'.
- Not illuminated in bright locations or when using 'SCENERY', 'NIGHT SCENERY', 'SELF PORTRAIT', 'FIREWORKS', 'AERIAL PHOTO', or 'SUNSET' scene modes.

Camera is hot.

- Camera may become a little warm during use, but this does not affect performance or quality.

Lens makes a clicking noise.

- When brightness changes, the lens may make a clicking noise and the monitor brightness may also change, but this is due to aperture settings being made. (Does not affect recording.)

Clock is incorrect.

- Camera has been left for a long period.
 - Reset the clock (P.17).
 - (Date will be set to '0:00 0. 0. 0' for pictures if clock is not set.)
- Long time was taken to set clock (clock behind by this amount).

When using zoom, picture becomes slightly warped and the edges of the subject become colored.

- Pictures may be slightly warped or colored around the edges, depending on the zoom ratio, but this is not a fault.

File numbers are not recorded in sequence.

- File numbers are reset when new folders are created (P.102).

File numbers have jumped backwards.

- Battery was removed/inserted with power on. (Numbers may jump backwards if folder/file numbers are not correctly recorded.)

Usage cautions and notes

When in use

Camera may become warm if used for long periods of time, but this is not a fault.

- To avoid jitter, use a tripod and place in a stable location. (Especially when using telescopic zoom, lower shutter speeds, or self-timer)
- **Keep the camera as far away as possible from electromagnetic equipment (such as microwave ovens, TVs, video games etc.).**
 - If you use the camera on top of or near a TV, the pictures and sound on the camera may be disrupted by electromagnetic wave radiation.
 - Do not use the camera near cell phones because doing so may result in noise adversely affecting the pictures and sound.
 - Recorded data may be damaged, or pictures may be distorted, by strong magnetic fields created by speakers or large motors.
 - Electromagnetic wave radiation generated by microprocessors may adversely affect the camera, disturbing the pictures and sound.
 - If the camera is adversely affected by electromagnetic equipment and stops functioning properly, turn the camera off and remove the battery or disconnect AC adaptor (DMW-AC5PP; optional). Then reinsert the battery or reconnect AC adaptor and turn the camera on.
- **Do not use the camera near radio transmitters or high-voltage lines.**
 - If you record near radio transmitters or high-voltage lines, the recorded pictures and sound may be adversely affected.
- Do not extend the supplied cord or cable.
- Do not allow camera to come into contact with pesticides or volatile substances (can cause surface damage or coating to peel).
- Never leave the camera and the battery in a car or on a car bonnet in the summer. It may cause leakage of the battery electrolyte, a generation of heat, and may cause a fire and the battery to burst due to the high temperature.

Caring for your camera

To clean your camera, remove the battery or disconnect power plug, and wipe with a soft, dry cloth.

- Use a well-wrung wet cloth to remove stubborn stains, before wiping again with a dry cloth.
- Do not use benzene, thinners, alcohol, or kitchen detergent, as these may damage the outer casing and finish of the camera.
- If using a chemically-treated cloth, read the supplied instructions carefully.
- Do not touch the lens barrier (P.11).

When not using for a while

- Turn off camera power before removing battery and card (ensure that battery is removed to prevent damage through over-discharge).
- Do not leave in contact with rubber or plastic bags.
- Store together with a drying agent (silica gel) if leaving in drawer, etc. Store batteries in cool (15 °C-25 °C (59 °F-77 °F)) places with low humidity (40% - 60%) and no major temperature changes.
- Charge battery once per year and use completely before storing again.

Memory cards

- To prevent damage to cards and data
 - Avoid high temperatures, direct sunlight, electromagnetic waves, and static electricity.
 - Do not bend, drop, or expose to strong impacts.
 - Do not touch connectors on reverse of card or allow them to become dirty or wet.
- When disposing of/transferring memory cards
 - If using the 'format' or 'delete' functions on your camera or computer, this only changes the file management information, and does not completely delete the data from within the memory card. When disposing of or transferring your memory cards, we recommend physically destroying the memory card itself, or using commercially available computer data erasing software to completely delete the data from the card. Data within memory cards should be managed responsibly.

Personal Information

If names or birthdays are set in BABY mode or in the FACE RECOG. function [ZS3], personal information will be included in the camera and the pictures that have been taken.

- Disclaimer
 - Data containing personal information can be altered or lost due to malfunction, static electricity, accidents, breakdowns, repairs, or other operations. Panasonic will not be liable for any damage that occurs, direct or indirect, as a result of the alteration or loss of data containing personal information.
- When ordering repairs or transferring/disposing of the camera
 - To protect your personal information, please reset the settings. (P.24)
 - If any pictures are contained in the built-in memory, copy (P.98) them to a memory card if necessary, and then format (P.26) the built-in memory.
 - Remove the memory card from the camera.
 - When ordering repairs, the built-in memory and other settings may be returned to the initial purchase state.
 - If the above operations cannot be performed because of a camera malfunction, consult with the dealer or nearest Service Center.

When transferring or disposing of your memory card, see 'When disposing of/transferring memory cards' in the previous section.

For DMC-ZS3 users

This product is licensed under the AVC patent portfolio license for the personal and noncommercial use of a consumer to (i) encode video in compliance with the AVC Standard ("AVC Video") and/or (ii) decode AVC Video that was encoded by a consumer engaged in a personal and non-commercial activity and/or was obtained from a video provider licensed to provide AVC Video. No license is granted or shall be implied for any other use. Additional information may be obtained from MPEG LA, LLC. See <http://www.mpegla.com>.

Recording picture/time capacity ZS3

- Figures given are estimates. May vary according to conditions, card type, and subject.
- Recording capacities/times displayed on LCD monitor may not be reduced regularly.

Recording picture capacity (still pictures)

- Varies according to 'ASPECT RATIO' (P.70), 'PICTURE SIZE' (P.69), or 'QUALITY' (P.70) settings.

- When the number of recordable pictures exceeds 99,999, '+99999' is displayed.

ASPECT RATIO	4:3												3:2					16:9															
	10 M (3648×2736)		7 M EZ (3072×2304)		5 M EZ (2560×1920)		3 M EZ (2048×1536)		2 M EZ (1600×1200)		0.3 M EZ (640×480)		9.5 M (3776×2520)	6.5 M EZ (3168×2112)	4.5 M EZ (2656×1768)	3 M EZ (2112×1408)	2.5 M EZ (2048×1360)	9 M (3968×2232)	6 M EZ (3328×1872)	4.5 M EZ (2784×1568)	2.5 M EZ (2208×1248)	2 M EZ (1920×1080)											
QUALITY																																	
Built-in memory	7	14	9	19	13	26	28	54	45	84	200	320	7	15	10	20	18	37	29	57	31	60	7	15	10	20	20	39	32	62	41	79	
Memory card	32 MB	4	9	6	12	8	16	18	35	29	54	130	200	4	9	6	13	11	24	19	36	20	39	4	10	6	13	12	25	20	40	26	51
	64 MB	9	20	13	26	18	35	37	73	60	110	270	420	10	20	13	27	25	50	39	76	42	81	10	21	14	27	27	53	43	83	56	105
	128 MB	20	41	28	55	37	72	77	145	120	220	550	860	21	42	28	56	52	100	81	155	87	165	22	43	29	57	55	105	88	165	110	210
	256 MB	41	82	55	105	73	140	150	290	240	440	1080	1690	42	83	56	110	100	195	155	300	170	320	43	86	57	110	105	210	170	330	220	420
	512 MB	83	160	110	210	145	280	300	580	470	880	2150	3350	85	165	110	210	200	390	310	600	330	640	87	170	110	220	210	420	340	650	440	830
	1 GB	165	320	220	430	290	560	600	1160	950	1770	4310	6710	170	330	220	440	400	790	630	1200	670	1280	175	340	220	440	430	850	680	1310	880	1670
	2 GB	340	660	450	870	590	1130	1220	2360	1910	3610	8770	12290	340	680	460	890	820	1610	1270	2450	1360	2560	350	690	460	900	890	1700	1390	2670	1800	3410
	4 GB	660	1310	880	1720	1170	2230	2410	4640	3770	7090	17240	24130	680	1340	900	1740	1630	3170	2510	4820	2680	5020	700	1370	920	1770	1740	3350	2740	5240	3540	6700
	6 GB	1010	1990	1340	2620	1780	3390	3660	7050	5730	10790	26210	36700	1040	2030	1370	2650	2470	4820	3820	7330	4070	7640	1070	2080	1400	2690	2650	5090	4160	7970	5390	10190
	8 GB	1360	2660	1800	3500	2380	4540	4910	9440	7670	14440	35080	49120	1390	2720	1840	3550	3310	6460	5110	9820	5450	10230	1430	2790	1870	3610	3550	6820	5580	10670	7220	13640
12 GB	2050	4020	2720	5290	3590	6860	7400	14240	11570	21790	52920	74090	2100	4110	2780	5360	5000	9740	7710	14810	8230	15430	2160	4200	2820	5440	5360	10290	8410	16100	10890	20580	
16 GB	2740	5370	3630	7050	4790	9150	9880	19000	15440	29060	70590	98830	2800	5490	3710	7160	6670	13000	10290	19780	10980	20590	2880	5610	3770	7260	7160	13720	11230	21480	14530	27450	
32 GB	5500	10770	7280	14160	9620	18350	19820	38120	30970	58310	141620	198260	5630	11010	7450	14360	13390	26080	20650	39650	22020	41300	5790	11260	7560	14570	14360	27530	22520	43100	29150	55070	

Recording time capacity (motion pictures)

- Varies according to 'REC MODE' (P.79), or 'REC QUALITY' (P.80) settings.

REC MODE	AVCHD Lite				MOTION JPEG			
	REC QUALITY	SH	H	L	HD	WVGA	VGA	QVGA
Built-in memory		—	—	—	—	—	—	1 min 22 s
Memory card	32 MB	—	—	—	4 s	16 s	17 s	52 s
	64 MB	—	—	—	12 s	36 s	38 s	1 min 50 s
	128 MB	—	—	—	29 s	1 min 17 s	1 min 20 s	3 min 45 s
	256 MB	—	—	—	59 s	2 min 30 s	2 min 35 s	7 min 20 s
	512 MB	3 min	4 min	7 min	2 min	5 min	5 min 10 s	14 min 40 s
	1 GB	7 min	9 min	14 min	4 min	10 min 10 s	10 min 40 s	29 min 30 s
	2 GB	15 min	20 min	29 min	8 min 20 s	20 min 50 s	21 min 40 s	1 h
	4 GB	30 min	40 min	1 h	16 min 20 s	41 min	42 min 40 s	1 h 58 min
	6 GB	46 min	1 h	1 h 28 min	25 min	1 h 2 min	1 h 5 min	3 h
	8 GB	1 h	1 h 20 min	1 h 54 min	33 min 30 s	1 h 23 min	1 h 27 min	4 h 1 min
12 GB	1 h 34 min	2 h	2 h 54 min	50 min 30 s	2 h 6 min	2 h 11 min	6 h 4 min	
16 GB	2 h	2 h 40 min	4 h	1 h 7 min	2 h 48 min	2 h 55 min	8 h 5 min	
32 GB	4 h	5 h 20 min	8 h	2 h 15 min	5 h 38 min	5 h 51 min	16 h 14 min	

- A maximum of approx. 2 GB of continuous motion picture can be recorded in MOTION JPEG format. (Even if there is more than 2 GB of available space on the card, the available recording time will be calculated for a maximum of 2 GB.)
- The time displayed on the left is the total time.

Recording picture/time capacity ZS1

- Figures given are estimates. May vary according to conditions, card type, and subject.
- Recording capacities/times displayed on LCD monitor may not be reduced regularly.

Recording picture capacity (still pictures)

- Varies according to 'ASPECT RATIO' (P.70), 'PICTURE SIZE' (P.69), or 'QUALITY' (P.70) settings.

- When the number of recordable pictures exceeds 99,999, '+99999' is displayed.

ASPECT RATIO	4:3												3:2								16:9								
	10 M (3648×2736)		7 M EZ (3072×2304)		5 M EZ (2560×1920)		3 M EZ (2048×1536)		2 M EZ (1600×1200)		0.3 M EZ (640×480)		9 M (3648×2432)		6 M EZ (3072×2048)		4.5 M EZ (2560×1712)		2.5 M EZ (2048×1360)		7.5 M (3648×2056)		5.5 M EZ (3072×1728)		3.5 M EZ (2560×1440)		2 M EZ (1920×1080)		
QUALITY																													
Built-in memory	7	14	9	19	13	26	28	54	45	84	200	320	7	16	10	21	20	39	31	60	8	18	11	23	23	46	41	79	
Memory card	32 MB	4	9	6	12	8	16	18	35	29	55	130	200	4	10	6	13	12	25	20	39	5	11	7	14	15	30	27	51
	64 MB	10	20	13	26	18	35	38	73	60	110	270	420	10	22	14	28	27	53	42	81	12	24	15	31	32	62	56	105
	128 MB	21	41	28	55	37	72	77	145	120	220	550	860	22	45	30	59	56	105	87	165	25	50	32	63	66	125	110	210
	256 MB	41	82	55	105	73	140	150	290	240	440	1080	1690	45	88	59	115	105	210	170	320	50	98	64	125	125	240	220	420
	512 MB	83	160	110	210	145	280	300	580	470	880	2150	3350	90	175	115	220	210	420	330	640	99	195	125	240	250	490	440	830
	1 GB	165	320	220	430	290	560	600	1160	950	1770	4310	6710	180	350	230	460	430	850	670	1280	200	390	250	490	510	990	880	1670
	2 GB	340	660	450	870	590	1130	1220	2360	1920	3610	8780	12290	360	720	480	930	890	1700	1360	2560	400	790	520	1000	1040	1980	1800	3410
	4 GB	660	1310	880	1720	1170	2230	2410	4640	3770	7090	17240	24130	720	1410	940	1820	1740	3350	2680	5020	800	1560	1030	1970	2040	3890	3540	6700
	6 GB	1010	1990	1340	2620	1780	3390	3660	7050	5730	10790	26210	36700	1100	2150	1440	2770	2650	5090	4070	7640	1220	2380	1560	3000	3100	5910	5390	10190
	8 GB	1360	2660	1800	3500	2380	4540	4910	9440	7670	14440	35080	49120	1470	2880	1930	3720	3550	6820	5450	10230	1630	3180	2090	4020	4160	7920	7220	13640
12 GB	2050	4020	2720	5290	3590	6860	7400	14240	11570	21790	52920	74090	2230	4350	2910	5610	5360	10290	8230	15430	2460	4810	3160	6070	6270	11950	10890	20580	
16 GB	2740	5370	3630	7050	4790	9150	9880	19000	15440	29070	70600	98840	2970	5810	3890	7480	7160	13720	10980	20590	3290	6410	4220	8100	8370	15940	14530	27450	
32 GB	5500	10770	7280	14160	9620	18350	19820	38120	30970	58310	141620	198270	5970	11660	7800	15010	14360	27530	22020	41300	6600	12870	8470	16250	16800	31970	29150	55070	

Recording time capacity (motion pictures)

- Varies according to 'REC QUALITY' (P.80) setting.

REC QUALITY	WVGA	VGA	QVGA
Built-in memory	—	—	1 min 27 s
Memory card	32 MB	16 s	17 s
	64 MB	37 s	39 s
	128 MB	1 min 18 s	1 min 22 s
	256 MB	2 min 35 s	2 min 40 s
	512 MB	5 min 10 s	5 min 20 s
	1 GB	10 min 20 s	10 min 50 s
	2 GB	21 min 20 s	22 min 10 s
	4 GB	41 min 50 s	43 min 40 s
	6 GB	1 h 3 min	1 h 6 min
	8 GB	1 h 25 min	1 h 28 min
12 GB	2 h 8 min	2 h 14 min	
16 GB	2 h 52 min	2 h 59 min	
32 GB	5 h 45 min	5 h 59 min	

- A maximum of approx. 2 GB of continuous motion picture can be recorded. (Even if there is more than 2 GB of available space on the card, the available recording time will be calculated for a maximum of 2 GB.)
- The time displayed on the left is the total time.

Specifications DMC-ZS3

Digital Camera: Information for your safety

Power Source	DC 5.1 V
Power Consumption	When recording: 1.3 W When playing back: 0.6 W
Camera effective pixels	10,100,000 pixels
Image sensor	1/2.33" CCD, total pixel number 12,700,000 pixels Primary color filter
Lens	Optical 12 x zoom f=4.1 mm to 49.2 mm (35 mm film camera equivalent: 25 mm to 300 mm)/ F3.3 to F4.9
Digital zoom	Max.4 x
Extended optical zoom	Max. 21.4 x
Focus	Normal/AF Macro/Macro zoom Face detection/AF tracking/11-area-focusing/ 1-area-focusing (High speed)/1-area-focusing/Spot-focusing
Focus range	
Normal/Motion picture	50 cm (1.64 feet) (Wide)/2 m (6.57 feet) (Tele) to ∞
Macro/Intelligent Auto/Clipboard	3 cm (0.1 feet) (Wide)/1 m (3.28 feet) (Tele) to ∞ (2 m (6.57 feet) unless max.T)
Scene mode	There may be difference in above settings.
Shutter system	Electronic shutter + Mechanical shutter
Motion picture recording	<ul style="list-style-type: none"> ● AVCHD Lite 1280 x 720 pixels 60p recordings* (Only when using an SD Memory Card) * CCD output is at 30fps Approx. 17 Mbps/Approx. 13 Mbps/Approx. 9 Mbps (VBR), with stereo audio ● Motion JPEG 1280 x 720 pixels* / 848 x 480 pixels* / 640x480 pixels* / 320x240 pixels (* Only when using an SD Memory Card) 30 frames/second with stereo audio
Burst recording	
Burst speed	2.3 pictures/second (Burst), Approx. 1.8 pictures/second (Unlimited)
Number of recordable pictures	Max. 5 pictures (Standard), max. 3 pictures (Fine), Depends on the remaining capacity of the built-in memory or the card (Unlimited).
Hi-speed burst	
Burst speed	Approx. 10 pictures/second (Speed priority) Approx. 6 pictures/second (Image priority)
Number of recordable pictures	Approx. 15 pictures (When using the built-in memory, immediately after formatting) Max. 100 pictures (When using a card, it may differ depending on the type of card and the recording conditions)
ISO sensitivity	AUTO/80/100/200/400/800/1600 [HIGH SENS.] mode: 1600 - 6400
Shutter speed	8 to 1/2000 th [STARRY SKY] mode: 15 seconds, 30 seconds, 60 seconds
White balance	AUTO/Daylight/Cloudy/Shade/Halogen/White set
Exposure (AE)	AUTO (Program AE) Exposure compensation (1/3 EV Step, -2 EV to +2 EV)
Metering mode	Multiple/Center weighted/Spot
LCD monitor	3.0" low-temperature polycrystalline TFT LCD (Approx. 460,800 dots) (field of view ratio about 100 %)

Flash	Flash range: (ISO AUTO) Approx. 60 cm (1.97 feet) to 5.3 m (17.4 feet) (Wide) AUTO, AUTO/Red-eye reduction, Forced flash ON (Forced flash ON/Red-eye reduction), Slow sync./Red-eye reduction, Forced flash OFF
Microphone	Stereo
Speaker	Monaural
Recording media	Built-in Memory (Approx. 40 MB)/SD Memory Card/SDHC Memory Card/MultiMediaCard (Still pictures only)
Picture size	
Still picture	When the aspect ratio setting is [4:3] 3648 x 2736 pixels / 3072 x 2304 pixels / 2560x1920 pixels / 2048x1536 pixels / 1600 x 1200 pixels / 640 x 480 pixels
	When the aspect ratio setting is [3:2] 3776 x 2520 pixels / 3168 x 2112 pixels / 2656 x 1768 pixels / 2112 x 1408 pixels / 2048 x 1360 pixels
	When the aspect ratio setting is [16:9] 3968 x 2232 pixels / 3328 x 1872 pixels / 2784 x 1568 pixels / 2208 x 1248 pixels / 1920 x 1080 pixels
Motion pictures	1280 x 720 pixels* / 848 x 480 pixels* / 640 x 480 pixels* / 320 x 240 pixels (* Only when using an SD Memory Card)
Quality	Fine/Standard
Recording file format	
Still Picture	JPEG (based on Design rule for Camera File system, based on Exif 2.21 standard)/DPOF corresponding
Still pictures with audio	JPEG (based on Design rule for Camera File system, based on Exif 2.21 standard) + QuickTime
Motion pictures	AVCHD Lite/QuickTime Motion JPEG
Interface	Digital: USB 2.0 (High Speed) Analog video/audio: NTSC Composite, Audio line output (stereo)
Terminal	HDMI: HDMI mini cable (type C) AV/DIGITAL/MULTI: Dedicated jack (14 pin)
Dimensions (excluding the projection part)	Approx. 103.3 mm (W) x 59.6 mm (H) x 32.8 mm (D) [4.07" (W) x 2.35" (H) x 1.29" (D)]
Mass	Excluding card and battery: Approx. 206 g (7.3 oz)/ With card and battery: Approx. 229 g (8.1 oz)
Operating temperature	0 °C to 40 °C (32 °F to 104 °F)
Operating humidity	10 % to 80 %

Battery charger

(Panasonic DE-A65B): Information for your safety

Output	CHARGE 4.2 V --- 0.65 A
Input	110 V to 240 V 50/60Hz, 0.2 A

Equipment mobility: Movable

Battery Pack (lithium-ion)

(Panasonic DMW-BCG10PP): Information for your safety

Voltage/capacity (Minimum)	3.6 V / 895 mAh
-----------------------------------	-----------------

Specifications DMC-ZS1

Digital Camera: Information for your safety

Power Source	DC 5.1 V
Power Consumption	When recording: 1.2 W When playing back: 0.6 W
Camera effective pixels	10,100,000 pixels
Image sensor	1/2.5" CCD, total pixel number 10,300,000 pixels Primary color filter
Lens	Optical 12 x zoom f=4.1 mm to 49.2 mm (35 mm film camera equivalent: 25 mm to 300 mm)/ F3.3 to F4.9
Digital zoom	Max. 4 x
Extended optical zoom	Max. 21.4 x
Focus	Normal/AF Macro/Macro zoom Face detection/AF tracking/11-area-focusing/ 1-area-focusing (High speed)/1-area-focusing/Spot-focusing
Focus range	
Normal/Motion picture	50 cm (1.64 feet) (Wide)/2 m (6.57 feet) (Tele) to ∞
Macro/Intelligent Auto/Clipboard	3 cm (0.1 feet) (Wide)/1 m (3.28 feet) (Tele) to ∞ (2 m (6.57 feet) unless max.T)
Scene mode	There may be difference in above settings.
Shutter system	Electronic shutter + Mechanical shutter
Motion picture recording	848 x 480 pixels* / 640 x 480 pixels* / 320 x 240 pixels (* Only when using an SD Memory Card) 30 frames/second with audio
Burst recording	
Burst speed	2.5 pictures/second (Burst), Approx. 2 pictures/second (Unlimited)
Number of recordable pictures	Max. 5 pictures (Standard), max. 3 pictures (Fine), Depends on the remaining capacity of the built-in memory or the card (Unlimited).
Hi-speed burst	
Burst speed	Approx. 10 pictures/second (Speed priority) Approx. 7 pictures/second (Image priority)
Number of recordable pictures	Approx. 15 pictures (When using the built-in memory, immediately after formatting) Max. 100 pictures (When using a card, it may differ depending on the type of card and the recording conditions)
ISO sensitivity	AUTO/80/100/200/400/800/1600 [HIGH SENS.] mode: 1600 - 6400
Shutter speed	8 to 1/2000 th [STARRY SKY] mode: 15 seconds, 30 seconds, 60 seconds
White balance	AUTO/Daylight/Cloudy/Shade/Halogen/White set
Exposure (AE)	AUTO (Program AE) Exposure compensation (1/3 EV Step, -2 EV to +2 EV)
Metering mode	Multiple/Center weighted/Spot
LCD monitor	2.7" amorphous silicon TFT LCD (Approx. 230,400 dots) (field of view ratio about 100 %)

Flash	Flash range: (ISO AUTO) Approx. 60 cm (1.97 feet) to 5.3 m (17.4 feet) (Wide) AUTO, AUTO/Red-eye reduction, Forced flash ON (Forced flash ON/Red-eye reduction), Slow sync./Red-eye reduction, Forced flash OFF
Microphone	Monaural
Speaker	Monaural
Recording media	Built-in Memory (Approx. 40 MB)/SD Memory Card/SDHC Memory Card/MultiMediaCard (Still pictures only)
Picture size	
Still picture	When the aspect ratio setting is [4:3] 3648 x 2736 pixels / 3072 x 2304 pixels / 2560 x 1920 pixels / 2048 x 1536 pixels / 1600 x 1200 pixels / 640 x 480 pixels When the aspect ratio setting is [3:2] 3648 x 2432 pixels / 3072 x 2048 pixels / 2560 x 1712 pixels / 2048 x 1360 pixels When the aspect ratio setting is [16:9] 3648 x 2056 pixels / 3072 x 1728 pixels / 2560 x 1440 pixels / 1920 x 1080 pixels
Motion pictures	848 x 480 pixels* / 640 x 480 pixels* / 320 x 240 pixels (* Only when using an SD Memory Card)
Quality	Fine/Standard
Recording file format	
Still Picture	JPEG (based on Design rule for Camera File system, based on Exif 2.21 standard)/DPOF corresponding
Still pictures with audio	JPEG (based on Design rule for Camera File system, based on Exif 2.21 standard) + QuickTime
Motion pictures	QuickTime Motion JPEG
Interface	Digital: USB 2.0 (High Speed) Analog video/audio: NTSC Composite, Audio line output (monaural)
Terminal	AV/DIGITAL/MULTI: Dedicated jack (14 pin)
Dimensions (excluding the projection part)	Approx. 103.3 mm (W) × 59.6 mm (H) × 32.8 mm (D) [4.07" (W) × 2.35" (H) × 1.29" (D)]
Mass	Excluding card and battery: Approx. 206 g (7.3 oz) With card and battery: Approx. 229 g (8.1 oz)
Operating temperature	0 °C to 40 °C (32 °F to 104 °F)
Operating humidity	10 % to 80 %

Battery charger (Panasonic DE-A65B): Information for your safety

Output	CHARGE 4.2 V --- 0.65 A
Input	110 V to 240 V 50/60Hz, 0.2 A

Equipment mobility: Movable Battery Pack (lithium-ion) (Panasonic DMW-BCG10PP): Information for your safety

Voltage/capacity (Minimum)	3.6 V / 895 mAh
-----------------------------------	-----------------

Request for Service Notice (For USA and Puerto Rico Only)

Please photocopy this form when making a request for service notice.
In the unlikely event this product needs service.

- Request for Service Notice:** • Please include your **proof of purchase.**
(Failure to do so will delay your repair.)
(USA and Puerto Rico Only) • To further speed your repair, please provide an explanation of what wrong with the unit and any symptom it is exhibiting.

Mail this completed form and your Proof of Purchase along with your unit to:
Panasonic Camera and Digital Service Center
1590 Touhy Ave.
Elk Grove Village, IL 60007

Limited Warranty (For USA and Puerto Rico Only)

PANASONIC CONSUMER ELECTRONICS COMPANY, DIVISION OF
PANASONIC CORPORATION OF NORTH AMERICA
One Panasonic Way, Secaucus, New Jersey 07094

Panasonic Digital Still Camera Limited Warranty

Limited Warranty Coverage

If your product does not work properly because of a defect in materials or workmanship, Panasonic Consumer Electronics Company (referred to as “the warrantor”) will, for the length of the period indicated on the chart below, which starts with the date of original purchase (“warranty period”), at its option either (a) repair your product with new or refurbished parts, or (b) replace it with a new or refurbished product. The decision to repair or replace will be made by the warrantor.

PRODUCT OR PART NAME	PARTS	LABOR
DIGITAL STILL CAMERA (EXCEPT ITEMS LISTED BELOW)	1 (ONE) YEAR	1 (ONE) YEAR
CCD	6 (SIX) MONTHS	90 (NINETY) DAYS
RECHARGEABLE BATTERY PACK (IN EXCHANGE FOR DEFECTIVE BATTERY PACK)	90 (NINETY) DAYS	NOT APPLICABLE
SD MEMORY CARD (IN EXCHANGE FOR DEFECTIVE SD CARD)	90 (NINETY) DAYS	NOT APPLICABLE

During the “Labor” warranty period there will be no charge for labor. During the “Parts” warranty period, there will be no charge for parts. You must carry-in or mail-in your product during the warranty period. If non-rechargeable batteries are included, they are not warranted. This warranty only applies to products purchased and serviced in the United States or Puerto Rico. This warranty is extended only to the original purchaser of a new product which was not sold “as is”. A purchase receipt or other proof of the original purchase date is required for warranty service.

Carry-In or Mail-In Service

For Carry-In or Mail-In Service in the United States and Puerto Rico call
1-800-211-PANA (7262).

This warranty ONLY COVERS failures due to defects in materials or workmanship, and DOES NOT COVER normal wear and tear or cosmetic damage. The warranty ALSO DOES NOT COVER damages which occurred in shipment, or failures which are caused by products not supplied by the warrantor, or failures which result from accidents, misuse, abuse, neglect, mishandling, misapplication, alteration, faulty installation, set-up adjustments, misadjustment of consumer controls, improper maintenance, power line surge, lightning damage, modification, or commercial use (such as in a hotel, office, restaurant, or other business), rental use of the product, service by anyone other than a Factory Service Center or other Authorized Servicer, or damage that is attributable to acts of God.

THERE ARE NO EXPRESS WARRANTIES EXCEPT AS LISTED UNDER "LIMITED WARRANTY COVERAGE". THE WARRANTOR IS NOT LIABLE FOR INCIDENTAL OR CONSEQUENTIAL DAMAGES RESULTING FROM THE USE OF THIS PRODUCT, OR ARISING OUT OF ANY BREACH OF THIS WARRANTY. (As examples, this excludes damages for lost time, travel to and from the servicer, loss of media or images, data or other memory content. The items listed are not exclusive, but are for illustration only.) **ALL EXPRESS AND IMPLIED WARRANTIES, INCLUDING THE WARRANTY OF MERCHANTABILITY, ARE LIMITED TO THE PERIOD OF THE LIMITED WARRANTY.**

Some states do not allow the exclusion or limitation of incidental or consequential damages, or limitations on how long an implied warranty lasts, so the exclusions may not apply to you.

This warranty gives you specific legal rights and you may also have other rights which vary from state to state. If a problem with this product develops during or after the warranty period, you may contact your dealer or Service Center. If the problem is not handled to your satisfaction, then write to the warrantor's Consumer Affairs Department at the addresses listed for the warrantor.

PARTS AND SERVICE WHICH ARE NOT COVERED BY THIS LIMITED WARRANTY ARE YOUR RESPONSIBILITY.

Obtain Product Information and Operating Assistance; locate your nearest Dealer or Service Center; purchase Parts and Accessories; or make Customer Service and Literature requests by visiting our Web Site at:
<http://www.panasonic.com/help>
or, contact us via the web at:
<http://www.panasonic.com/contactinfo>

You may also contact us directly at:
1-800-211-PANA (7262),
Monday-Friday 9 am-9 pm; Saturday-Sunday 10 am-7 pm, EST

For hearing or speech impaired TTY users, TTY :1-877-833-8855

Accessory Purchases (United States and Puerto Rico)

Purchase Parts, Accessories and Instruction Books online for all Panasonic Products by visiting our Web Site at:
<http://www.pstc.panasonic.com>

or, send your request by E-mail to:
npcparts@us.panasonic.com

You may also contact us directly at:
1-800-332-5368 (Phone) 1-800-237-9080 (Fax Only)
(Monday - Friday 9 am to 9 pm, EST.)
PANASONIC SERVICE AND TECHNOLOGY COMPANY
20421 84th Avenue South, Kent, WA 98032
(We Accept Visa, MasterCard, Discover Card, American Express,
and Personal Checks)

For hearing or speech impaired TTY users, TTY :1-866-605-1277

Product Repairs (United States and Puerto Rico)

Centralized Factory Service Center

Panasonic Camera and Digital Service Center
1590 Touhy Ave.
Elk Grove Village, IL 60007

MAIL TO :

Please carefully pack and ship, prepaid and insured, to the Elk Grove Village Centralized Factory Service Center.

As of October 2008

Merci d'avoir choisi Panasonic!

Vous avez acheté l'un des appareils les plus perfectionnés et les plus fiables actuellement sur le marché. Utilisé selon les directives, il vous apportera ainsi qu'à votre famille des années de plaisir. Veuillez prendre le temps de remplir la fiche ci-contre. Le numéro de série se trouve sur l'étiquette située sur le dessous de votre appareil photo. **Conservez le présent manuel** afin de pouvoir le consulter au besoin.

N° de modèle _____

N° de série _____

Précautions à prendre (pour le Canada)

AVERTISSEMENT : POUR RÉDUIRE LES RISQUES D'INCENDIE, DE CHOC ÉLECTRIQUE OU DE DOMMAGES À L'APPAREIL,

- N'EXPOSEZ PAS CET APPAREIL À LA PLUIE, À L'HUMIDITÉ, À L'ÉGOUTTEMENT OU AUX ÉCLABOUSSEMENTS, ET NE PLACEZ SUR L'APPAREIL AUCUN OBJET REMPLI DE LIQUIDE, TEL UN VASE.
- UTILISEZ EXCLUSIVEMENT LES ACCESSOIRES RECOMMANDÉS.
- NE RETIREZ PAS LE COUVERCLE (OU LE PANNEAU ARRIÈRE) ; IL N'Y A AUCUNE PIÈCE RÉPARABLE PAR L'UTILISATEUR À L'INTÉRIEUR. CONFIEZ TOUTE RÉPARATION À UN TECHNICIEN DE SERVICE QUALIFIÉ.

LA PRISE DE COURANT DOIT SE TROUVER À PROXIMITÉ DE L'APPAREIL ET ÊTRE FACILEMENT ACCESSIBLE.



L'appareil que vous vous êtes procuré est alimenté par une batterie au lithium-ion. Pour des renseignements sur le recyclage de la batterie, veuillez composer le 1-800-8-BATTERY.

ATTENTION

Danger d'explosion si la batterie n'est pas remplacée correctement. Remplacez-la uniquement par une batterie identique ou du même type recommandée par le fabricant. Suivez les instructions du fabricant pour jeter les batteries usées.

Avertissement

Risque d'incendie, d'explosion et de brûlures. Ne pas démonter, chauffer à plus de 60 °C (140 °F) ou incinérer.

La plaque signalétique se trouve sur le dessous des appareils.

CE QUI SUIT NE S'APPLIQUE QU'AU CANADA.

Cet appareil numérique de la classe B est conforme à la norme NMB-003 du Canada.

- N'utilisez que l'adaptateur secteur Panasonic DMW-AC5PP (vendu séparément).
- Utilisez toujours une batterie de marque Panasonic (DMW-BCG10PP).
- Si une batterie autre que Panasonic est utilisée, nous ne pouvons garantir le bon fonctionnement de l'appareil.
- N'utilisez pas un câble USB autre que celui fourni.
- N'utilisez pas un câble AV autre que celui fourni.
- Utilisez exclusivement un mini-câble HDMI Panasonic authentique (RP-CDHM15/RP-CDHM30 ; en option).
- Utilisez exclusivement un adaptateur Multi Conversion Panasonic authentique (DMW-MCA1 ; en option).
- Rangez les cartes mémoire hors de la portée des enfants.

Éloignez l'appareil le plus possible de tout dispositif émettant un champ électromagnétique (tel un four à micro-ondes, un téléviseur, une console de jeux vidéo, etc.).

- Si vous utilisez l'appareil sur le dessus ou à proximité d'un téléviseur, les images ou le son pourraient être déformés par son champ électromagnétique.
 - N'utilisez pas l'appareil à proximité d'un téléphone cellulaire car l'interférence pourrait perturber les images et le son.
 - Les puissants champs magnétiques produits par des haut-parleurs ou de gros moteurs électriques peuvent endommager les données ou distordre les images.
 - Le champ électromagnétique créé par un microprocesseur peut nuire à l'appareil et perturber l'image et le son.
 - Dans le cas où l'appareil serait perturbé par un champ électromagnétique et cesserait de fonctionner adéquatement, mettez-le hors marche et retirez-en la batterie ou débranchez l'adaptateur secteur (DMW-AC5PP, vendu séparément). Remettez la batterie en place ou rebranchez l'adaptateur secteur, puis remettez l'appareil en marche.
- #### N'utilisez pas l'appareil à proximité d'un émetteur radio ou de lignes à haute tension.
- Si des prises de vues sont faites à proximité d'un émetteur radio ou de lignes à haute tension, les images et les sons enregistrés pourraient en être affectés.

Chargeur de batterie

Ce chargeur fonctionne sur le secteur entre 110 V et 240 V. Toutefois

- Aux États-Unis et au Canada, le chargeur doit être branché sur une prise secteur de 120 V seulement.
- Lors du branchement à une prise secteur à l'extérieur des États-Unis ou du Canada, utilisez un adaptateur conforme à la configuration de la prise secteur.

À propos du bloc-batterie

Batterie (batterie au lithium-ion)

- Utilisez l'unité spécifiée pour recharger la batterie.
- N'utilisez la batterie avec aucun autre appareil que l'appareil spécifiée.
- Évitez le contact des saletés, du sable, du liquide ou autres corps étrangers avec les bornes.
- Ne touchez pas les bornes des fiches (+ et -) avec des objets métalliques.
- Évitez de démonter, remodeler, chauffer ou jeter au feu.

Si de l'électrolyte entre en contact avec vos mains ou vos vêtements, lavez-les avec beaucoup d'eau.

Si de l'électrolyte pénètre dans vos yeux, ne les frottez pas.

Rincez-vous les yeux avec beaucoup d'eau, puis consultez un médecin.

- N'exposez pas la batterie à la chaleur et tenez-la éloignée de toute flamme.
- Ne laissez pas la ou les batteries dans un véhicule exposé au soleil avec vitres et portes fermées pendant une longue période de temps.

À propos du chargeur de batterie

ATTENTION!

NE PAS INSTALLER CET APPAREIL DANS UNE BIBLIOTHÈQUE, UNE ARMOIRE OU TOUT AUTRE ESPACE CONFINÉ. S'ASSURER QUE LA VENTILATION DE L'APPAREIL EST ADÉQUATE. AFIN D'ÉVITER TOUT RISQUE DE CHOC ÉLECTRIQUE OU D'INCENDIE DÙ À UN SURCHAUFFEMENT, S'ASSURER QUE DES RIDEAUX OU TOUT OBJET QUELCONQUE NE BOUCHENT LES ÉVENTS D'AÉRATION DE L'APPAREIL.

Index

● List of LCD monitor displays (P.112)

A

Aerial Photo Mode	58
AF Assist Lamp	78
AF Lock	34
AF Macro	45
AF Mode	73
AF Tracking	34, 73
Aspect Conversion [ZS3]	94
Aspect Ratio	70
Audio Dubbing	97
Audio Recording	78
Auto Bracket	49
Auto LCD Off	23
Auto Power LCD	22
Auto Review	23
Available Recording Time	124-127
AVCHD Lite [ZS3]	79

B

Baby Mode	55
Backlight Compensation	33
Battery	13, 15, 16
Beach Mode	58
Beep	21
Brightness of the LCD Monitor	21
Built-in Memory	16
Burst Mode	76

C

Calendar	89
Candle Light Mode	54
Card	16
Caring for your camera	122
Category Play	88
Charging	13
Clipboard	81
Clock Set	17
Color Mode	77
Condensation	10
Continuous AF	80
Copy	98

D

Date Printing	90, 96, 105
Deleting Pictures	41
Demo Mode	27
Digital Zoom	39, 77
Direction detection function	29, 31

Display Size	22
--------------	----

E

Economy	23
Exposure Compensation	49
Extended Optical Zoom (EZ)	37

F

Face Detection	34, 73
Face Recognition [ZS3]	34, 65, 93
Favorite	95
Favorite Play	88
Film Grain Mode	59
Fireworks Mode	58
Flash	43
Flash Burst Mode	57
Focus	35, 36
Folder Composition	102
Food Mode	54
Formatting	26

G

Guide Line	22, 42
------------	--------

H

HDMI [ZS3]	25, 108
High Angle Mode [ZS1]	22
High Sensitivity Mode	56
High-Speed Burst Mode	56
Histogram	22, 42

I

Intelligent Auto Mode	32
Intelligent Exposure	76
Intelligent ISO	70

L

Language Setting	26
LCD Mode	22
LCD Monitor	12, 21, 22, 42, 112
Leveling	93

M

Macro Mode	45
Macro Zoom	46
Metering Mode	75
Minimum Shutter Speed	78
Mode Play [ZS3]	87

Motion JPEG	79
Motion picture menu [ZS3]	69
Motion Picture Mode [ZS1]	64
Motion Picture Playback	84
Multi Aspect [ZS3]	50
Multi Playback	83
My Scene Mode	60

N

Night Portrait Mode	54
Night Scenery Mode	54
Normal Play	40
Normal Recording	35
Number of Recordable Pictures	124-127

O

Optical Zoom	37
--------------	----

P

Panorama Assist Mode	53
Party Mode	54
Pet Mode	55
PictBridge	24, 104
Picture Size (Still picture)	69
Pictures with Audio	78, 84, 97
Pin Hole Mode	58
Playback menu	89
Playback mode menu	85
Playback Pictures on TV	107
Playback Zoom	40
Portrait Mode	52
Power LCD	22
Power Save	23
Pre AF	75
Print set	96
Protect	97

Q

Quality (Still picture)	70
Quick setting	20

R

Rec area [ZS3]	22
Rec menu	69
Recording mode (Motion picture) [ZS3]	79
Recording quality (Motion picture)	80
Reset of file No.	24
Reset of Setting	24

Resizing	91
Rotate Display	94

S

Scene Mode	51
Scenery Mode	53
Self Portrait Mode	52
Self-timer	48
Sensitivity	71
Setup Menu	21
Slide Show	86
Snow Mode	58
Soft Skin Mode	52
Sports Mode	53
Stabilizer	77
Starry Sky Mode	57
Sunset Mode	55

T

Tele Macro function	45
Text Stamp	90
Title Edit	89
Transform Mode	52
Travel Date	21, 67
Trimming	92
TV Aspect	25

U

Underwater Mode	59
USB Mode	24

V

Version display	26
VIERA Link [ZS3]	26, 109
Volume of Speakers	21

W

White Balance	72
White Balance Adjust	72
Wind Cut [ZS3]	80
World Time	68

Z

Zoom	37
Zoom Resume	24

MEMO

MEMO



"AVCHD Lite" and "AVCHD Lite" logo are trademarks of Panasonic Corporation and Sony Corporation.



Manufactured under license from Dolby Laboratories. Dolby and the double-D symbol are trademarks of Dolby Laboratories.



QuickTime and the QuickTime logo are trademarks or registered trademarks of Apple Inc., used under license therefrom.

**Panasonic Consumer Electronics Company,
Division of Panasonic Corporation of North America**

One Panasonic Way, Secaucus, NJ 07094

Panasonic Canada Inc.

5770 Ambler Drive, Mississauga, Ontario, L4W 2T3

© Panasonic Corporation 2009



Printed in Japan
VQT1Z82-1
M0209KZ3049

