

DECORATIVE TRIM

Vinyl Carpentry® and Accents

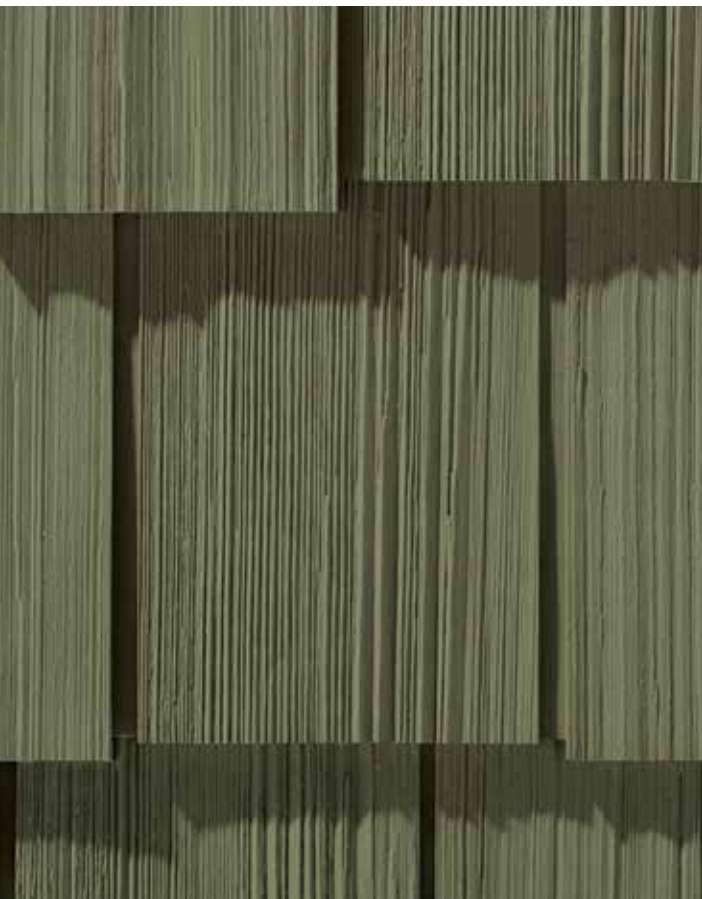

CertainTeed
SAINT-GOBAIN



Certa-Snap® Wrap Post Wrap System



3-1/3" Cornerpost



J-Channel



J-Channel with Aluminum Rake



From Simple...

Siding: CedarBoards™ Single 7" Clapboard in sterling gray.

Trim: Vinyl Carpentry® in colonial white and sterling gray.

Roofing: Landmark® Shingles in georgetown gray.

... to Stunning!



Oxford vinyl railing, white with square balusters



Restoration Millwork Classic Column Wraps



STONEfaçade™ Corners



Vinyl Carpentry Cornice Molding and Restoration Millwork Rake Profile



Restoration Millwork Trimboard with Rams Crown



Restoration Millwork One-Piece Corner with InvisiPro® Hidden Fastening System

Add good taste to your home's exterior with finishing touches that create eye-popping, stop-and-stare curb appeal. CertainTeed Vinyl Carpentry and Restoration Millwork Decorative Trim options, products and ideas make it easy. From unadorned to unbelievable, simple to stunning, drab to distinctive, basic to incredibly beautiful, CertainTeed assures that with the endless style and color possibilities of decorative trim, your home will never be without a personality and style all its own.

Siding: CedarBoards Single 7" Clapboard in sterling gray and Cedar Impressions Double 7" Straight Edge Perfection Shingles in charcoal gray with STONEfaçade LedgeStone in adirondack snowfall.

Trim: Vinyl Carpentry® in colonial white & Restoration Millwork® in natural white.

Roofing: Landmark Shingles in georgetown gray.

CertainTeed has the most complete siding accessory line in the industry. Virtually every installation challenge imaginable can be addressed with CertainTeed's extensive assortment.

Using the proper accessories can make for an ease of installation, but that's not all. Choosing the proper accessories can guarantee optimum performance, design flexibility and aesthetic enhancement. For detailed installation information, please refer to the CertainTeed Vinyl Siding Installation Guide (CTS205).



Accents
Cedar Impressions® and Board & Batten



Triple 5" Straight Edge Sawmill Shingles



Individual 5" Sawmill Shingles



Single 7" Perfection Shingles



Window & Door Trim



3-1/2" Lineal



J-Channel



5" Lineal



Crown Molding



3-1/2" Lineal with foam insert



Crown Molding Cap



2-1/2" Window & Door Casing

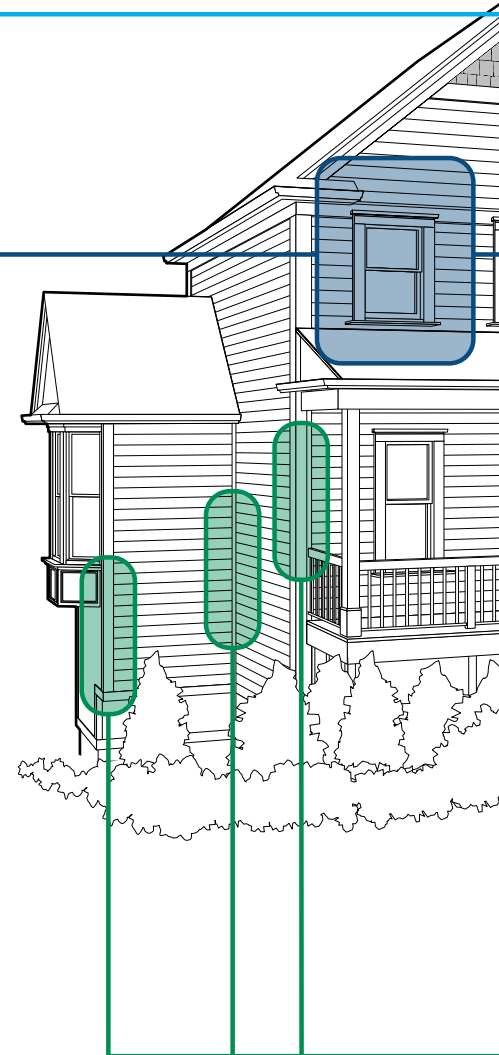



Double 7" Straight Edge Perfection Shingles



Double 7" Staggered Perfection Shingles



Single 6-1/3" Perfection Scallop

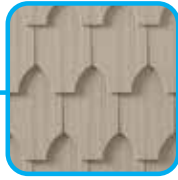

Single 6-1/3" Perfection Half-Cove



Single 6-1/3" Perfection Octagon



Double 7" Straight Edge Rough-Split Shakes



Double 9" Staggered Edge Rough-Split Shakes



Board & Batten



Wall & Soffit Transitions



Cornice Molding



Band Board with foam insert



Finish Board



H-Bars



Double Channel Lineal



Corner Systems

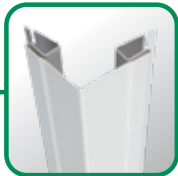

Cornerposts

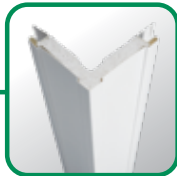

Traditional SuperCorner with foam insert



Fluted SuperCorner with foam insert



Cedar Impressions D7" and D9 Mitered Cornerposts

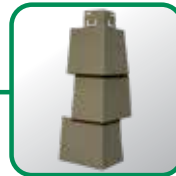

Cedar Impressions T5" Straight Edge Sawmill Offset Mitered Cornerpost



1-1/4" Cornerpost with foam insert



Inside Cornerposts



Bay Window Cornerpost



Cedar Impressions Individual 5" Sawmill Outside Cornerpost



Cedar Impressions 7" 4-piece Offset, Cornerposts



Window & Door Trim 8

- Crown Molding
- J-Channels
- Lineals



Corner Systems 14

- Bay Window Cornerpost
- Inside Cornerposts
- Insulated Cornerposts
- Mitered Cornerposts
- Outside Cornerposts
- SuperCorners™



Accents.....

- Board & Batten
- Cedar Impressions®



..... 24

Wall & Soffit Transitions..... 32

- Band Board
- Cornice Molding
- Double Channel Lineal
- Finish Board
- H-Bars
- Lineals



Color Chart..... 38

Finding Your Color 40

Trim and Color Selector Tools..... 41

CertainTeed has created a variety of user-friendly visualization tools to help you get a better idea of how well different colors and styles work together.

2-1/2" Window & Door Casing



3-1/2" Lineal



3-1/2" Lineal with Crown Molding



2-1/2" Window & Door Casing



Window & Door Trim

5" Lineal



CertainTeed window and door trim puts out the welcome mat to create a lasting first impression. Lineal trim adds a wider face profile that can help unify and accent a home's exterior, adding a design element that can be both subtle and distinctive. For even more personality and charm, add crown molding, above the door or window. It's a look you'll appreciate every time you cross the threshold into your beautiful home.



Explore Your Options

From window and door casing to lineals, CertainTeed offers a complete selection of virtually maintenance-free Vinyl Carpentry® to define your home.

Fast facts:

Crown molding dates back to the time of the ancient Greeks and Romans, used for "crowning" an architectural element.

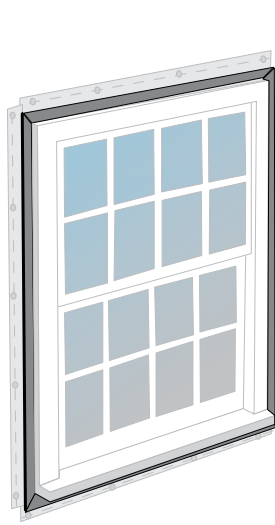

Simple
3/4" pocket J-channel surround.

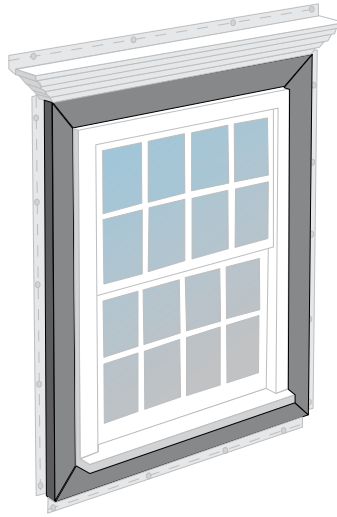

More Definition
Crown molding and crown molding end caps with 3-1/2" lineal header and 3-1/2" lineal surrounds.

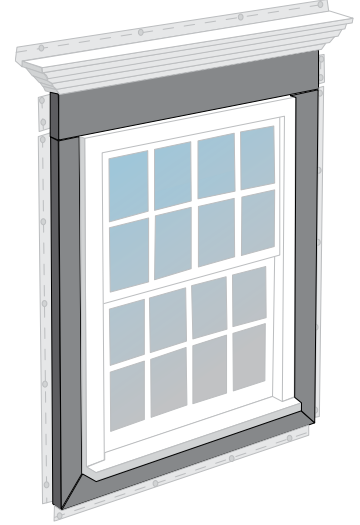

Classic Enhancement
Crown molding and crown molding end caps with 5" lineal header, 5" header end caps* and 3-1/2" lineal surrounds.



J-Channel

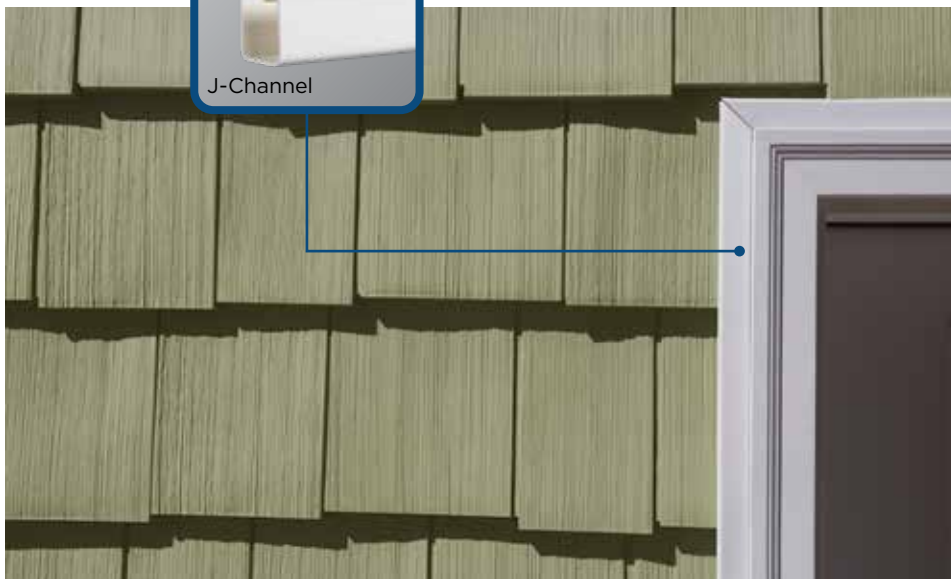

3-1/2" Lineal



5" Lineal

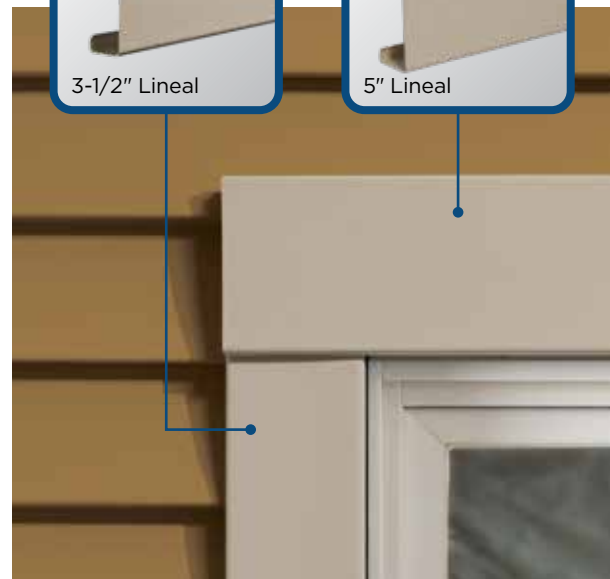

* Fabricated on site. Please refer to install manual CTS205 for complete instructions.



Using combinations of lineals offers that little touch to add personality on any home.

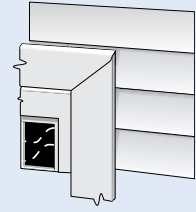

2-1/2" Window and door casing

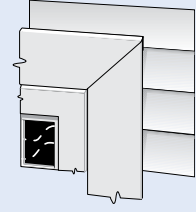

3-1/2" Lineal System

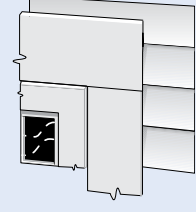

5" Lineal header, 3-1/2" vertical Lineal



Select Your Products

3-1/2" Lineal

For use with a new construction and remodeling window and door starter around windows and doors as a casing. The 3/4" channel receives siding panels. Can also be used to create a corner system.

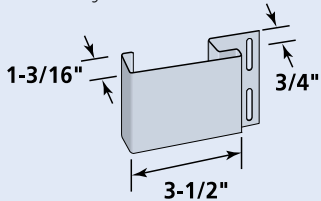

Product Code: 54706

Finish: Matte
 Length: 20'
 Pieces/Ctn: 10
 Lin Ft/Ctn: 200
 Cartons/Pallet: 30
 lbs/Ctn: ≤ 51
 Colors Available:

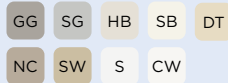

2-1/2" Window & Door Casing

A wide face J-channel with accentuates windows and doors. Designed to accommodate new construction window flanges and fit snugly against window and door frames.

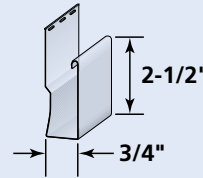

Product Code: 55813

Finish: Matte
 Length: 12' 6"
 Pieces/Ctn: 20
 Lin Ft/Ctn: 250
 Cartons/Pallet: 24
 lbs/Ctn: ≤ 52
 Colors Available:



5" Lineal

Two lineals create a corner system when installed with a Corner Starter and a corner insert. Can also be used with a window starter strip as a window/door casing. The 3/4" channel receives siding panels.

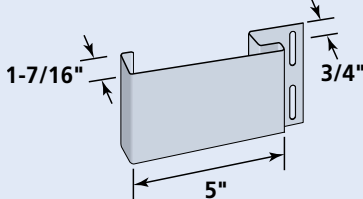

Product Code: 54712

Finish: Matte
 Length: 20'
 Pieces/Ctn: 10
 Lin Ft/Ctn: 200
 Cartons/Pallet: 15
 lbs/Ctn: ≤ 64
 Colors Available:

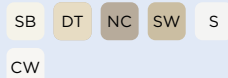

Crown Molding

Used in conjunction with 5" or 3-1/2" lineals and 3/4" J-channel to create a custom molded window or door header.

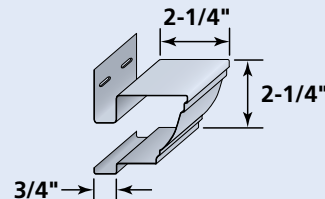

Product Code: 55804

Finish: Matte
 Length: 10'
 Pieces/Ctn: 10
 Lin Ft/Ctn: 100
 Cartons/Pallet: 12
 lbs/Ctn: ≤ 35
 Colors Available:



3-1/2" Lineal with foam insert

For use with CedarBoards™ siding and Cedar Impressions® D9 shakes, D7 Straight Edge Shakes and Northwoods.

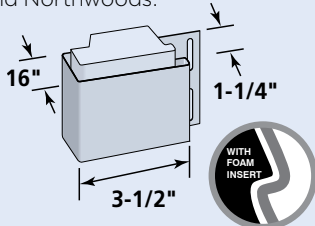

Product Code: 54707

Finish: Matte
 Length: 20'
 Pieces/Ctn: 10
 Lin Ft/Ctn: 200
 Cartons/Pallet: 23
 lbs/Ctn: ≤ 63
 Colors Available:



Undersill Trim

Helps secure trimmed siding panels under windows and eaves. 1/4" (56904), 3/8" for Shake/Shingle (56917).

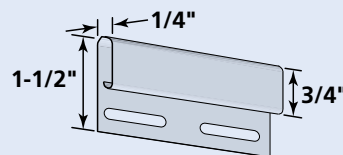

Finish: Matte
 Length: 12' 6"
 Colors Available:
 see page 36



Dual Undersill Trim

Secures trimmed siding panels under windows and eaves regardless of the profile or where in the panel face the panel has been trimmed.

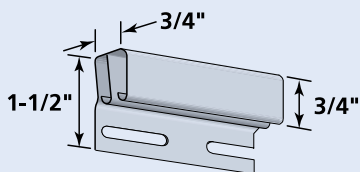

Product Code: 56916

Finish: Matte
 Length: 12' 6"
 Pieces/Ctn: 12
 Lin Ft/Ctn: 150
 Cartons/Pallet: 84
 lbs/Ctn: ≤ 22
 Colors Available:



3/4" Flexible J-Channel

Specialized 3/4" siding receiving trim; particularly useful around curved windows and ventilation treatments.

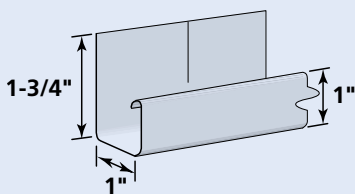

Product Code: 50309

Finish: Matte
 Length: 12' 6"
 Channel: 3/4"
 Pieces/Ctn: 10
 Lin Ft/Ctn: 125
 Cartons/Pallet: 50
 lbs/Ctn: ≤ 20
 Colors Available:



J-Channel

Universal siding and soffit receiving channel for use around utility openings, under eaves, etc. Available in 3/8" (50306), 1/2" (50305), 5/8" (50310), 3/4" (50303), 1" (50302) and 1-1/4" (50301) widths.

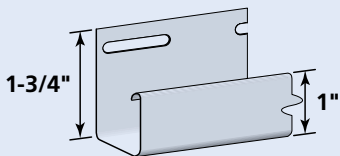

Finish: Matte
 Length: 12' 6"
 Pieces/Ctn: 40-48
 (depending on size)
 Colors Available:
 see page 36

Cedar Impressions T5" Straight Edge Sawmill Offset Mitered Cornerpost



Traditional SuperCorner



Cedar Impressions D9" Mitered Cornerpost



Cedar Impressions 7" 4-piece Offset, Cornerposts

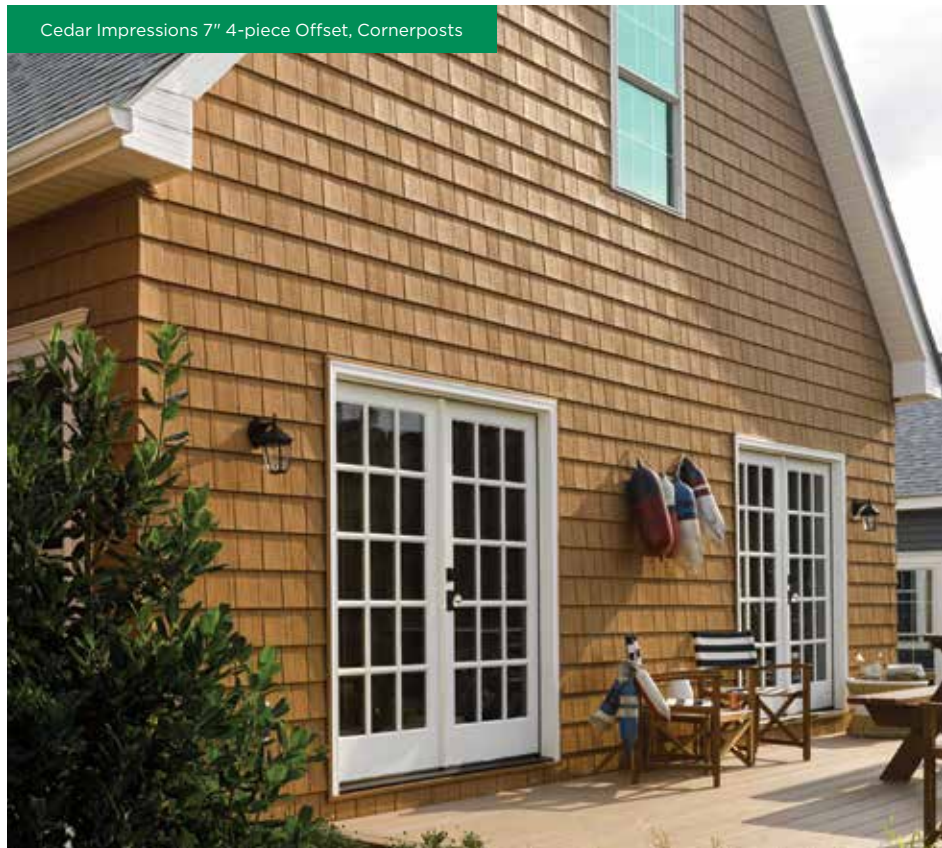



Corner Systems

Cornerpost and Inside Cornerpost



Traditional SuperCorner



Take your home from ordinary to extraordinary. Don't settle for traditional narrow corner trim with no depth. Go for something distinctive and beautifully unique. Blend traditional lap siding seamlessly around every bend with Vinyl Carpentry® Corner Systems or Cedar Impressions® Shakes and Shingles with outside mitered corners. Create elegance with an edge by adding corner systems and treatments that frame your home with distinction.

Corner Systems

Explore Your Options

Fast fact:

The average home has 88 linear feet of corner posts.

linear ft.

From outside corners to inside corners, from subtle to bold, CertainTeed provides the options to define the corners of any house.



Simple

Traditional Cornerpost with matching siding color for less definition.



More Definition

Traditional SuperCorner™ with foam insert creates more definition with a wide 6" face.



1-1/2" Face
Inside Cornerpost

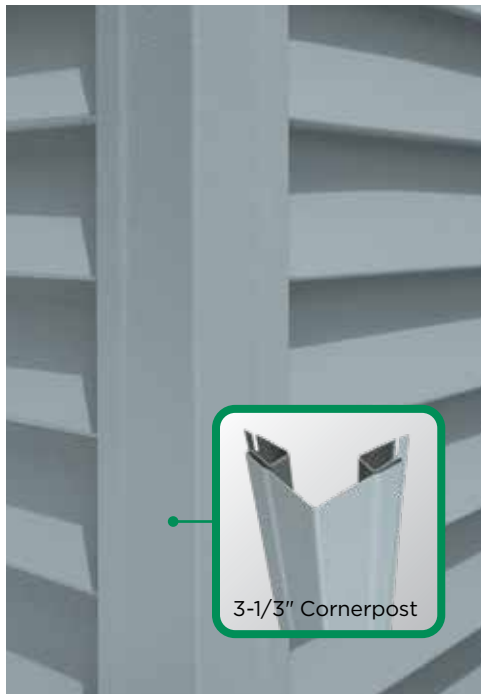
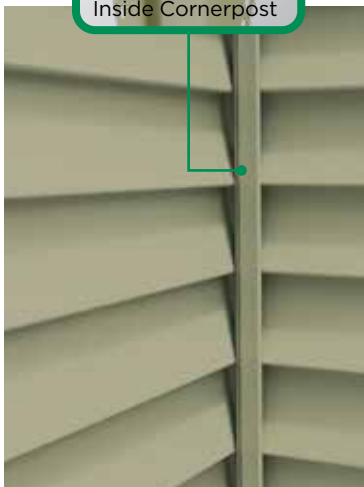

3-1/3" Cornerpost



Fluted SuperCorner
with foam insert

In addition to the traditional one-piece corners, lineals can be combined to create inside and outside corners.

Federal Corner

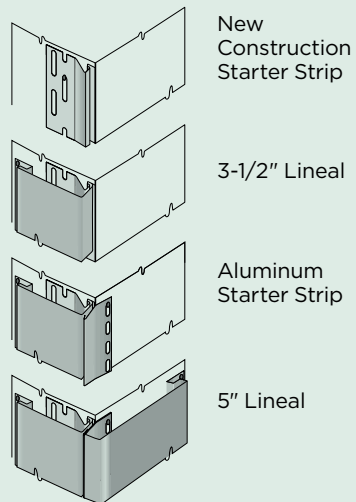

Inside Federal Corner

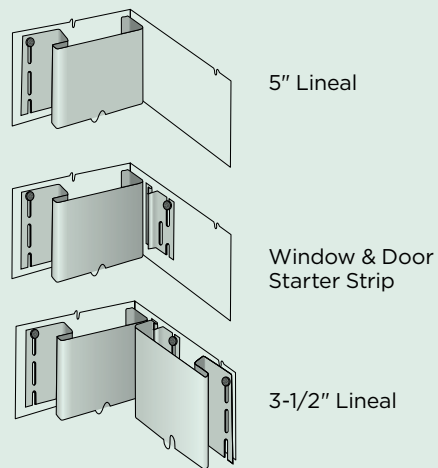

Federal corner

Starter strips are required to build 4 piece corners and federal corners.

Select Your Products

Cornerpost

Standard corner receives siding panels. Available with 3/4" receiving channels (51401 / 51402 / 51458 / 51404) and 1" receiving channel with 3-1/2" flat face (51409).

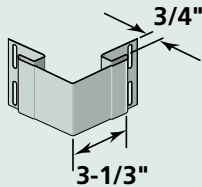

Colors Available:
see page 38

Traditional SuperCorner™ with foam insert

Wide decorative traditional corner treatment with a foam backing.

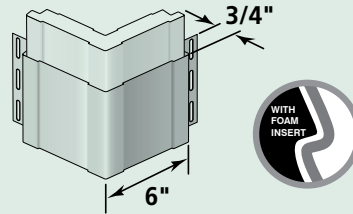

Product Code: 51420

Finish: Matte
Length: 20'
Pieces/Ctn: 6
Lin Ft/Ctn: 120
Cartons/Pallet: 9
lbs/Ctn: ≤ 77
Colors Available:

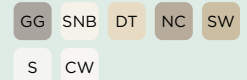

1-1/4" Cornerpost – 10' Woodgrain with foam insert

For use with CedarBoards™ siding and Cedar Impressions® D9 shakes, D7 Straight Edge Shakes and Northwoods.

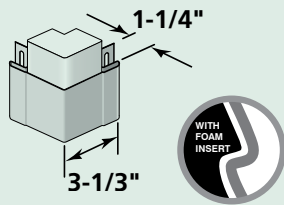

Product Code: 51412

Finish: Woodgrain
Length: 10'
Face: 3-1/3"
Pieces/Ctn: 10
Lin Ft/Ctn: 100
Cartons/Pallet: 12
lbs/Ctn: ≤ 42
Colors Available:



1-1/4" Traditional SuperCorner™ with foam insert

Can be used with CedarBoards siding and Cedar Impressions D9 Shakes, D7 Straight Edge Shakes and Northwoods.

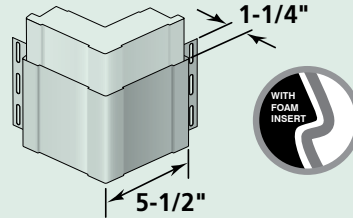

Product Code: 51447

Finish: Matte
Length: 20'
Pieces/Ctn: 6
Lin Ft/Ctn: 120
Cartons/Pallet: 8
lbs/Ctn: ≤ 80
Colors Available:

CW

Inside Cornerpost

Used where siding meets inside corners; provides a finished look. 3/4" channel (51436), 1-1/4" channel (51446).

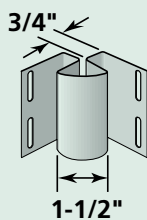

Finish: Matte
Length: 10'
Colors Available:
see page 36

Fluted SuperCorner™ with foam insert

Fluted corner with foam backing.

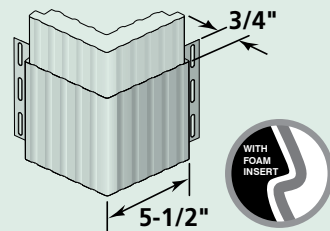

Product Code: 51424

Finish: Matte
Length: 20'
Pieces/Ctn: 6
Lin Ft/Ctn: 120
Cartons/Pallet: 10
lbs/Ctn: ≤ 81
Colors Available:

CW



Bay Window Cornerpost

Adapts to odd angles of bay windows.

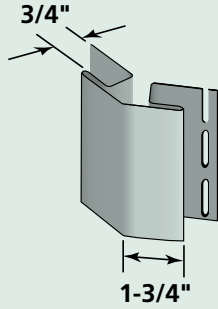

Product Code: 51445

Finish: Matte

Length: 10'

Face: 1-3/4"

Pieces/Ctn: 10

Lin Ft/Ctn: 100

Cartons/Pallet: 21

lbs/Ctn: ≤ 32

Colors Available:



Explore Your Cedar Impressions® Options

CertainTeed provides Vinyl Carpentry® corners, or specially designed Mitered Inside and Mitered Outside cornerposts for Cedar Impressions siding.



T5" Straight Edge
Sawmill Offset
Mitered Cornerpost

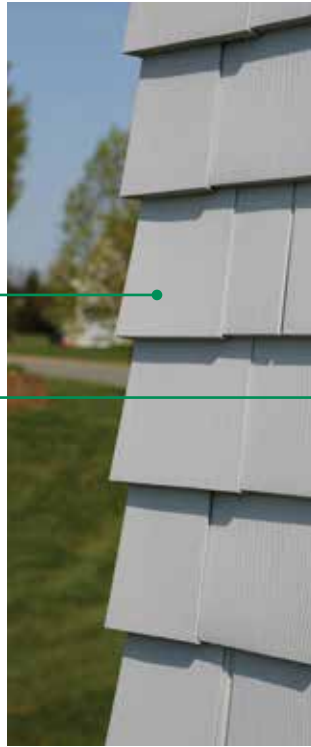

D9" Staggered
Rough-Split
Mitered Cornerpost



D7" Straight Edge
Perfection Mitered
Cornerpost



Cedar Impressions 7" 4-piece Offset, Cornerposts

Corner Systems

Select Your Cedar Impressions® Products

T5" Straight Edge Sawmill Offset Mitered Cornerpost

For use with Cedar Impressions T5" Straight Edge Sawmill Shingles

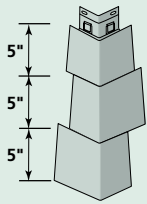

Product Code: 51406

Finish: Sawmill
 Pieces/Ctn: 32
 Lin Ft/Ctn: 40'
 Cartons/Pallet: 12
 lbs/Ctn: ≤ 17
 Colors Available:



D7" Staggered Perfection Mitered Cornerpost

For use with Cedar Impressions D7" Staggered Perfection Shingles

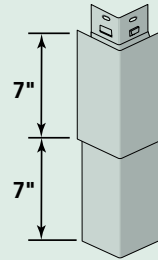

Product Code: 51451

Finish: Perfection
 Length: 14"
 Pieces/Ctn: 20
 Lin Ft/Ctn: 23' 3"
 Cartons/Pallet: 32
 lbs/Ctn: ≤ 14
 Colors Available:



D7" Straight Edge Rough-Split Mitered Cornerpost

For use with Cedar Impressions D7" Straight Edge Rough-Split Shakes

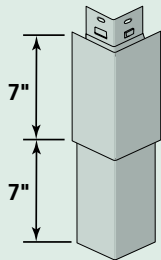

Product Code: 51450

Finish: Rough-Split
 Length: 14"
 Pieces/Ctn: 20
 Lin Ft/Ctn: 23' 4"
 Cartons/Pallet: 24
 lbs/Ctn: ≤ 17
 Colors Available:



D9" Staggered Rough-Split Mitered Cornerpost

For use with Cedar Impressions D9" Staggered Rough-Split Shakes

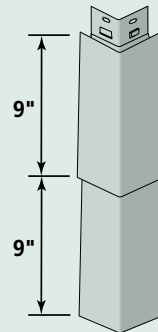

Product Code: 51432

Finish: Rough-Split
 Length: 18-1/2"
 Pieces/Ctn: 20
 Lin Ft/Ctn: 31
 Cartons/Pallet: 18
 lbs/Ctn: ≤ 21
 Colors Available:



7" 4-piece Offset, Outside Corner Posts

For use with Cedar Impressions S7" and D7" Straight Edge Perfection (3G) Shingles

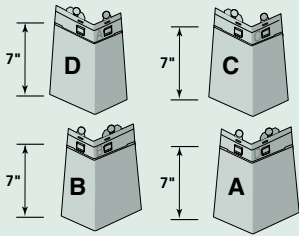

Product Code: 51459

Finish: Perfection
 Length: 4 pieces - 7" ea.
 Pieces/Ctn: 40
 Lin Ft/Ctn: 23' 4"
 Cartons/Pallet: 24
 lbs/Ctn: ≤ 15
 Colors Available:

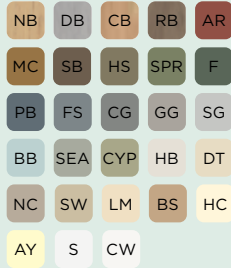

Cedar Impressions Individual 5" Sawmill Cornerpost

For use with Cedar Impressions Individual 5" Sawmill Shingles

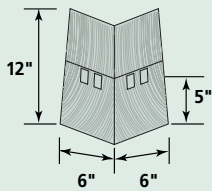

Product Code: 51405

Finish: Sawmill
 Pieces/Ctn: 24
 Lin Ft/Ctn: 10'
 Cartons/Pallet: 45
 lbs/Ctn: ≤ 12
 Colors Available:





Cedar Impressions S6-1/3" Perfection Octagon



When it comes to adding a personal touch to your home's exterior, accents bring out the best in any style of house. Grab attention with subtle or exciting color combinations. Add charm with Board & Batten. Or create a custom-crafted wood look with beautifully textured, Cedar Impressions® shingles and shakes. CertainTeed makes it easy to create a masterpiece you'll enjoy for years to come.

Explore Your Options

CertainTeed's complete selection of exterior product options is tailor-made to take advantage of the exciting mix-and-match trend: combining various materials, textures, styles and colors to create truly unique exterior designs.

With multiple profiles of Cedar Impressions®, Board & Batten and Vertical Siding to choose from, the possible ways to accent your home are endless.

Fast fact:

Are shingles and shakes the same thing?

Usually, a shingle is sawn on both sides and is thinner at the butt than a shake. A shake is typically split on one or both sides. Shakes are generally thicker with more aggressive, rougher texture that is far less precise than that of a shingle.



D7" Straight Edge
Rough-Split Shakes



D7" Staggered
Perfection Shingles



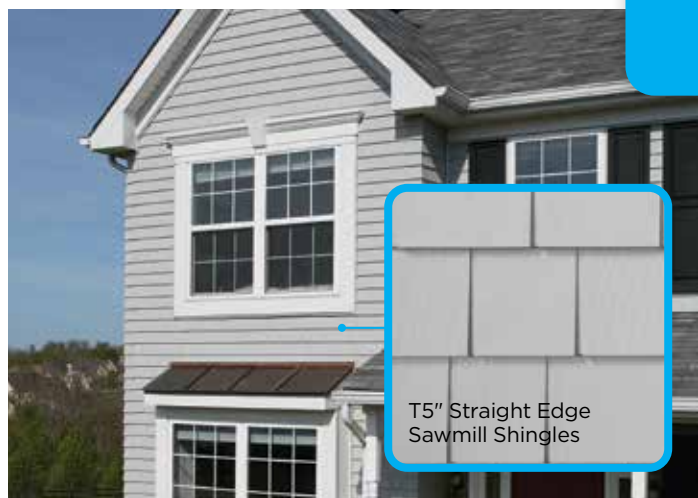
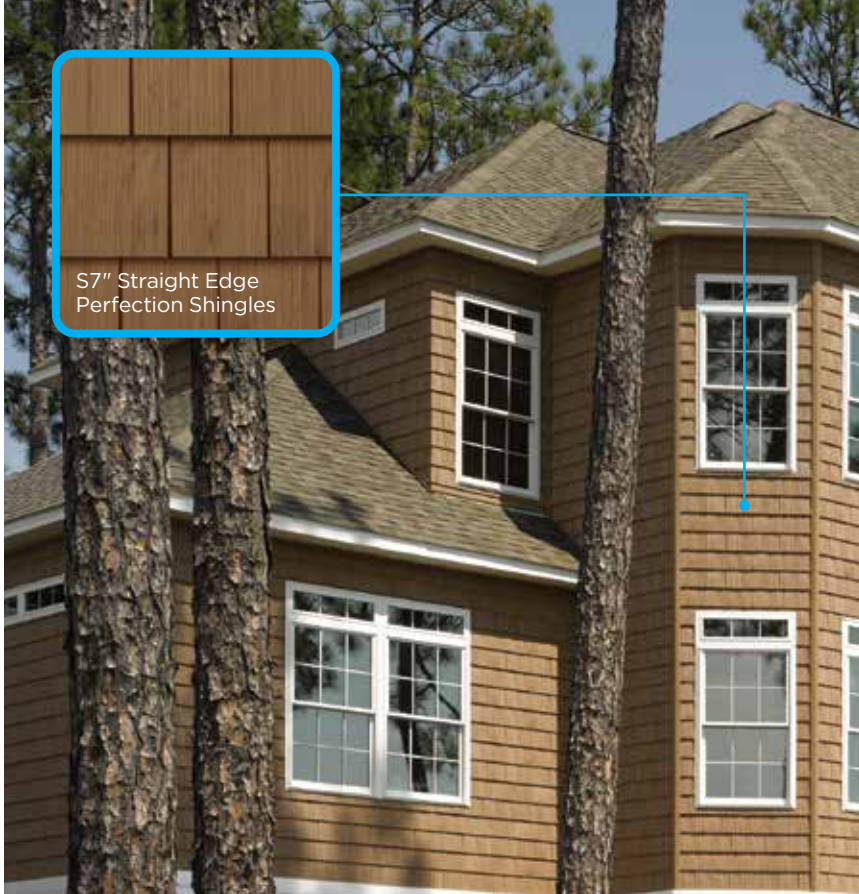
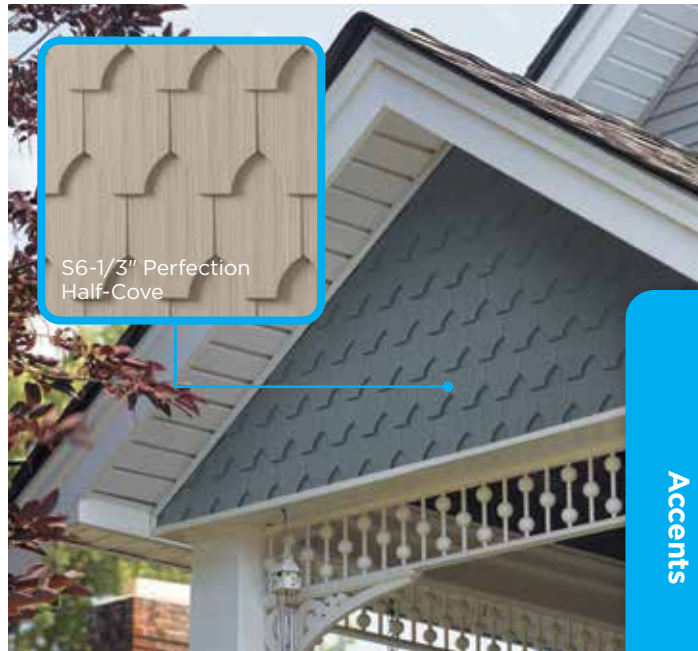
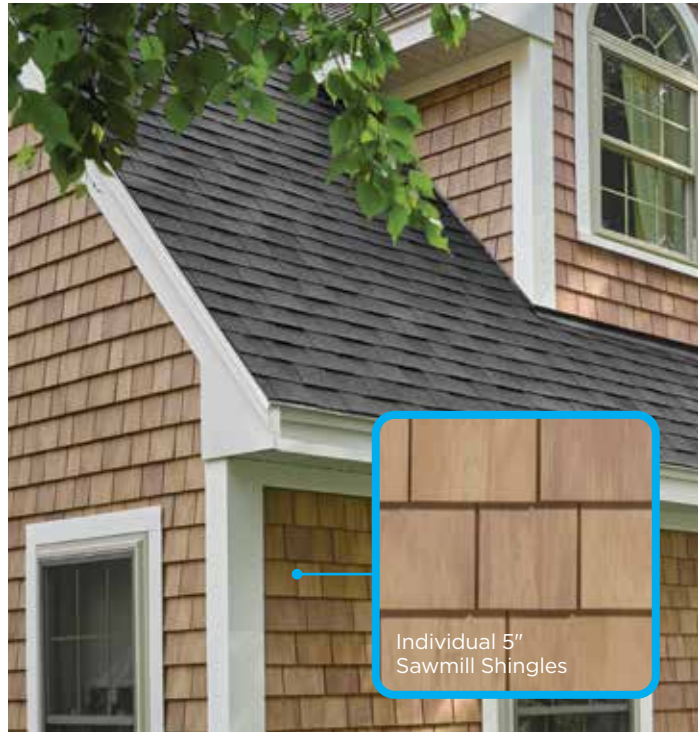
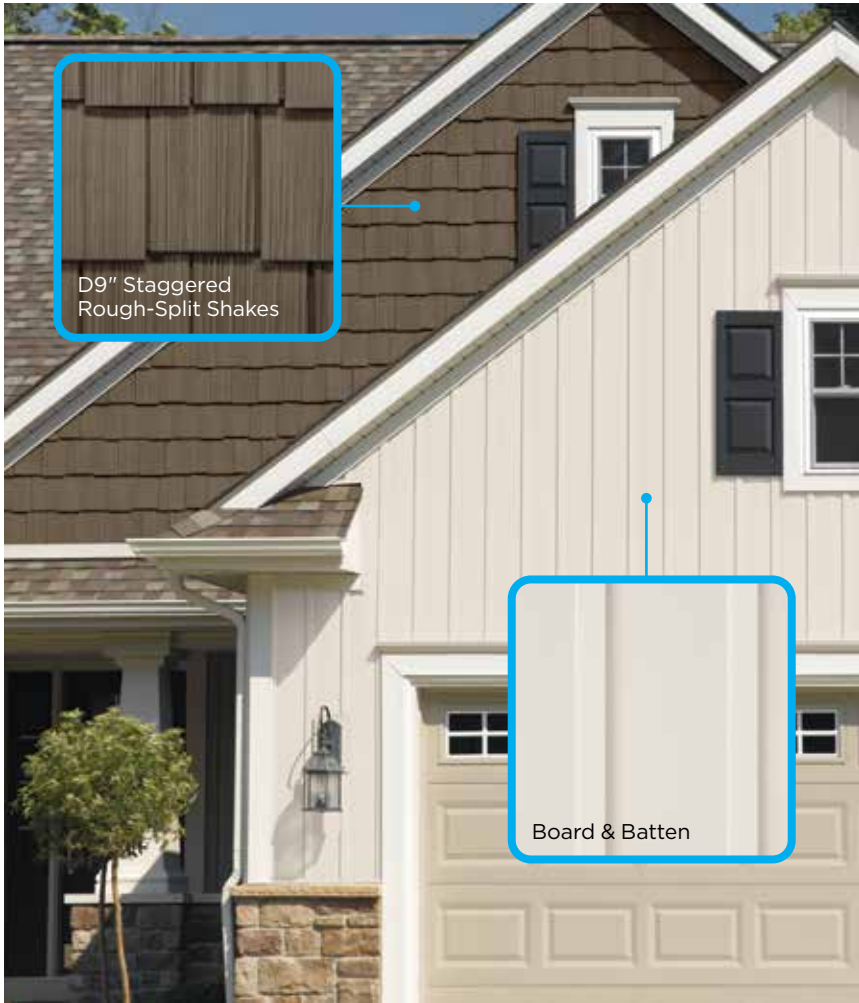

Accents

Select Your Products

Cedar Impressions® Triple 5" Straight Edge Sawmill Shingles

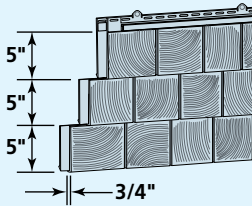

Product Code: 30106

Finish: Sawmill
Length: 60"
Exposure: 15"
Projection: 3/4"
Panels/Ctn: 8
Squares/Ctn: .50
Cartons/Pallet: 20
lbs/Ctn: ≤ 43
Colors Available:



Cedar Impressions® Double 7" Staggered Perfection Shingles

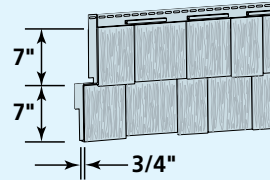

Product Code: 30143

Finish: Perfection
Length: 48"
Exposure: 14"
Projection: 3/4"
Panels/Ctn: 11
Squares/Ctn: .50
Cartons/Pallet: 16
lbs/Ctn: ≤ 44
Colors Available:



CW

Cedar Impressions® Individual 5" Sawmill Shingles

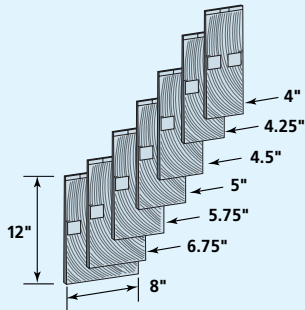

Product Code: 30146

Finish: Sawmill
Length: 7 Sizes: 4", 4.25", 4.5", 5", 5.75", 6.75", 8"
Exposure: 5"
Projection: Shingle is 1/2", installs in 1" accessory
Panels/Ctn: 168
Squares/Ctn: .33
Cartons/Pallet: 18
lbs/Ctn: ≤ 44
Colors Available:



Cedar Impressions® Single 7" Straight Edge Perfection Shingles

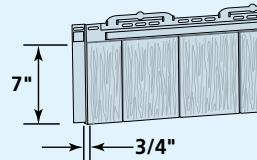

Product Code: 30137

Finish: Perfection
Length: 73.5"
Exposure: 7"
Projection: 3/4"
Panels/Ctn: 14
Squares/Ctn: .50
Cartons/Pallet: 32
lbs/Ctn: ≤ 43
Colors Available:



CW

Cedar Impressions® Double 7" Straight Edge Perfection Shingles 3G

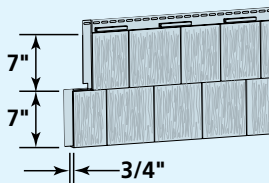

Product Code: 30144

Finish: Perfection
Length: 48"
Thickness: .100"
Exposure: 14"
Projection: 3/4"
Panels/Ctn: 11
Squares/Ctn: .50
Cartons/Pallet: 16
lbs/Ctn: ≤ 42
Colors Available:



**Cedar Impressions®
Double 7" Straight Edge
Rough-Split Shakes**

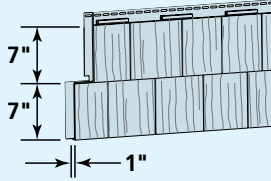

Product Code: 30141

Finish: Rough-Split
Length: 57"
Exposure: 14"
Projection: 1"
Panels/Ctn: 9
Squares/Ctn: .50
Cartons/Pallet: 16
lbs/Ctn: ≤ 47
Colors Available:



**Cedar Impressions®
Single 6-1/3" Perfection
Shapes - Octagon**

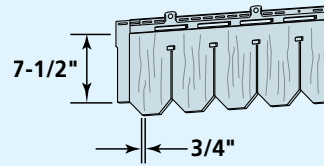

Product Code: 30148

Finish: Perfection
Length: 42"
Exposure: 6-1/3"
Projection: 3/4"
Panels/Ctn: 18
Squares/Ctn: .33
Cartons/Pallet: 15
lbs/Ctn: ≤ 35
Colors Available:

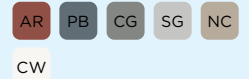

**Cedar Impressions®
Double 9" Staggered
Rough-Split Shakes**

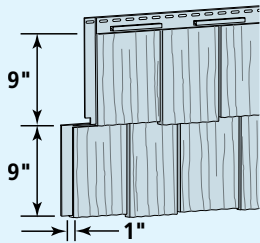

Product Code: 30136

Finish: Rough-Split
Length: 57"
Exposure: 18"
Projection: 1"
Panels/Ctn: 7
Squares/Ctn: .50
Cartons/Pallet: 16
lbs/Ctn: ≤ 50
Colors Available:



**Cedar Impressions®
Single 6-1/3" Perfection
Shapes - Half-Cove**

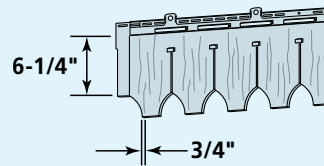

Product Code: 30149

Finish: Perfection
Length: 42"
Exposure: 6-1/3"
Projection: 3/4"
Panels/Ctn: 18
Squares/Ctn: .33
Cartons/Pallet: 15
lbs/Ctn: ≤ 32
Colors Available:



**Cedar Impressions®
Single 6-1/3" Perfection
Shapes - Scallop**

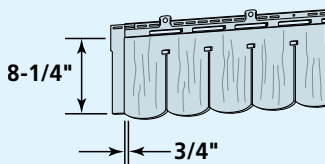

Product Code: 30147

Finish: Perfection
Length: 42"
Exposure: 6-1/3"
Projection: 3/4"
Panels/Ctn: 18
Squares/Ctn: .33
Cartons/Pallet: 15
lbs/Ctn: ≤ 38
Colors Available:

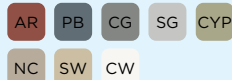

**Northwoods S7" Straight
Edge Perfection Shingles**

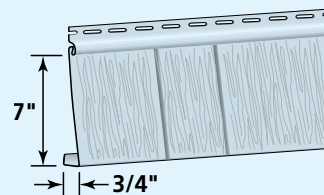

Product Code: 60108

Finish: Perfection
Length: 10' 1"
Exposure: 7"
Projection: 3/4"
Panels/Ctn: 17
Squares/Ctn: 1
Cartons/Pallet: 18
lbs/Ctn: ≤ 65
Colors Available:



Northwoods S7" Straight Edge Rough-Split Shakes

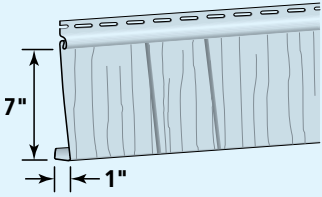

Product Code: 60106

Finish: Rough-Split
 Length: 10' 1"
 Exposure: 7"
 Projection: 1"
 Panels/Ctn: 17
 Squares/Ctn: 1
 Cartons/Pallet: 19
 lbs/Ctn: ≤ 59
 Colors Available:



Single 8" Vertical Board & Batten - 10' / 12' 6"

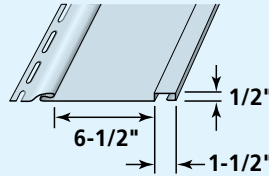

**Product Code: 34137 (12' 6")
34138 (10')**

Finish: Rough Cedar
 Length: 12' 6", 10'
 Thickness: .048"
 Exposure: 8"
 Projection: 1/2"
 Squares/Ctn: 1
 Colors Available:



Northwoods S9" Staggered Rough-Split Shakes

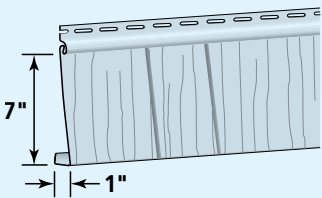

Product Code: 60106

Finish: Rough-Split
 Length: 10' 1"
 Exposure: 7"
 Projection: 1"
 Panels/Ctn: 17
 Squares/Ctn: 1
 Cartons/Pallet: 19
 lbs/Ctn: ≤ 59
 Colors Available:



Single 7" Vertical Board & Batten - 10'

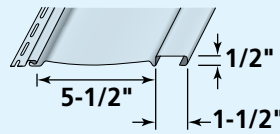

Product Code: 34136

Finish: Rough Cedar
 Length: 10'
 Thickness: .052"
 Exposure: 7"
 Projection: 1/2"
 Panels/Ctn: 34
 Squares/Ctn: 2
 Cartons/Pallet: 12
 lbs/Ctn: ≤ 112
 Colors Available:



Single 12" CedarBoards Insulated Vertical Board & Batten - 10'

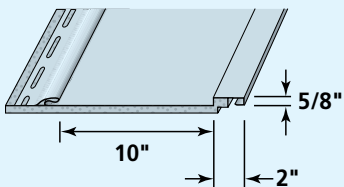

Product Code: 58153

Finish: Rough Cedar
 Length: 10'
 Thickness: .052"
 Exposure: 12"
 Projection: 1- 1/4"
 (complete assembly)
 Panels/Ctn: 10
 Squares/Ctn: 1
 Cartons/Pallet: 9
 lbs/Ctn: ≤ 59
 Colors Available:

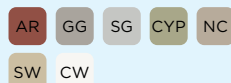

Chamfer Board™ Double 5" Solid Vertical

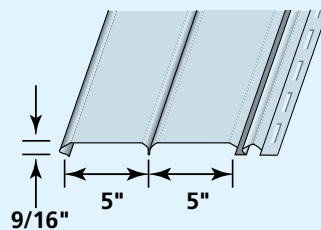

Product Code: 32100

Finish: Brushed
 Length: 12'
 Thickness: .044"
 Exposure: 10"
 Projection: 9/16"
 Panels/Ctn: 20
 Squares/Ctn: 2
 Cartons/Pallet: 14
 lbs/Ctn: ≤ 77
 Colors Available:





Accents

5" Double Channel Lineal



Cornice Molding



Band Board



Wall & Soffit Transitions

Finish Board



Attractive transitions between styles, architectural elements and colors are the best way to ensure a uniform design on any home. CertainTeed offers a wide variety of wall and soffit transition options for you to create beautiful transitions, while providing protection from damaging moisture.

Wall & Soffit Transitions

Explore Your Options

Trim provides a beautiful transition between two styles of siding. On long expanses of board & batten or soffit, a trim piece offers a way to add a signature outline or focal point. Also, consider a trim piece to transition from the wall up to the soffit.

Fast fact:

Band [Belly] Board:
Typically 5"- 6" reveal, can be used as a starter course for siding, a frieze board, a bold line separating levels of a house, or a transition piece in installations where siding alternates between horizontal, vertical and/or specialty profiles.
(Source: Vinyl Siding Institute)

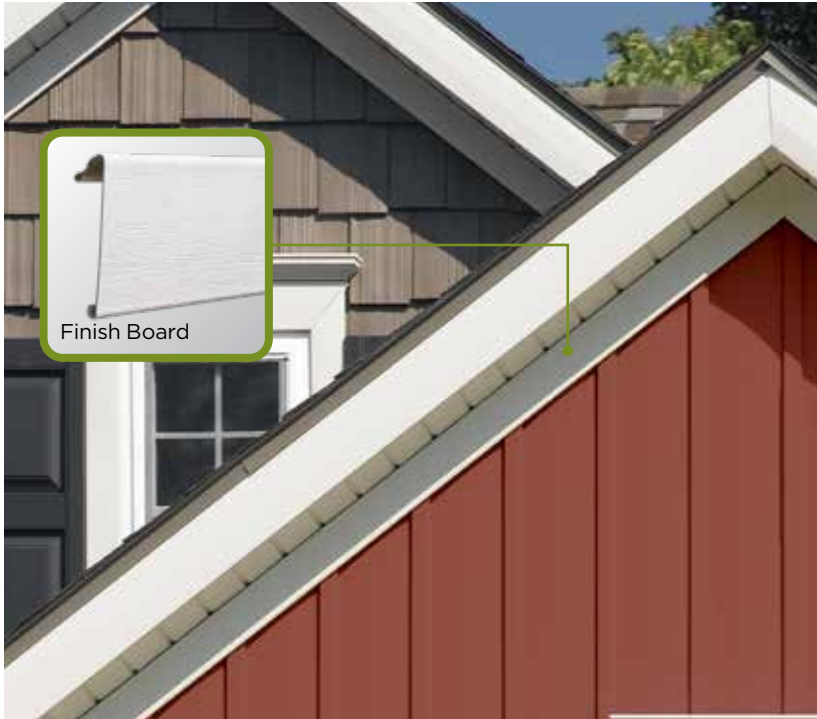



Band Board with foam insert

Create a transition using a band board with foam insert, or create your transition using a wide-faced lineal.

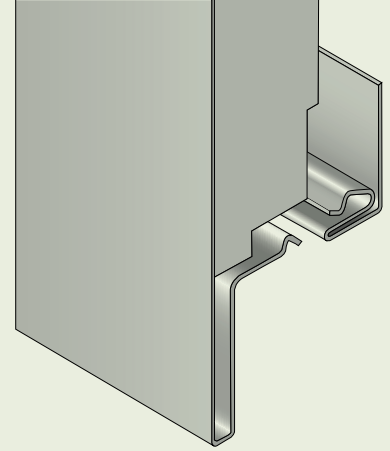

A **band board** makes an excellent wall transition.



Cornice Molding

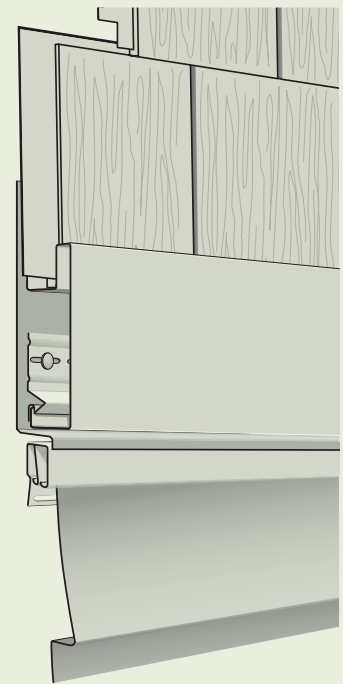

Lineals can transition lap siding to Cedar Impressions.



J-Channel

Select Your Products

Cornice Molding

Held in place by the Deluxe F-Channel or L-Receiver, this accessory hides the installation of the topmost siding panels.

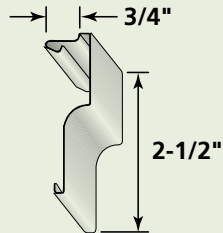

Product Code: 55817

Finish: Matte
 Length: 12' 6"
 Pieces/Ctn: 10
 Lin Ft/Ctn: 125
 Cartons/Pallet: 64
 lbs/Ctn: ≤ 16
 Colors Available:



Deluxe F-Channel

Installed under eaves to hold Cornice Molding in place. Also receives soffit panels.

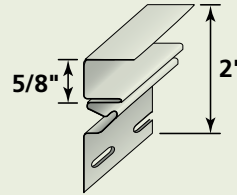

Product Code: 52503

Finish: Matte
 Length: 12' 6"
 Channel: 5/8"
 Pieces/Ctn: 24
 Lin Ft/Ctn: 300
 Cartons/Pallet: 32
 lbs/Ctn: ≤ 39
 No Color

Cornice Receiver

Installed under the eaves to hold the Cornice Molding. Also receives Band Board and Finish Board.

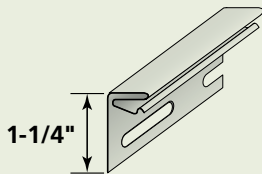

Product Code: 55812

Finish: Matte
 Length: 12' 6"
 Pieces/Ctn: 24
 Lin Ft/Ctn: 300
 Cartons/Pallet: 35
 lbs/Ctn: ≤ 28
 No Color

F-Channel

Receives soffit panels and helps hold 8" vinyl fascia in place. Available in 3/4" (52506) and 5/8" (52502)

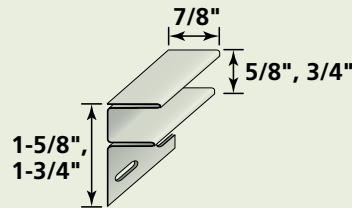

Finish: Matte
 Length: 12' 6"
 Pieces/Ctn: 24
 Lin Ft/Ctn: 300
 Cartons/Pallet: 35
 Colors Available:
 see page 37

Finish Board

A 3-1/2" top molding piece with a 1-1/4" projection designed for use with CedarBoards Insulated Siding.

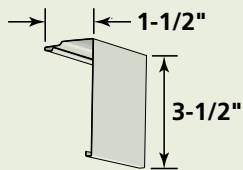

Product Code: 55815

Finish: Rough Cedar
 Length: 12' 6"
 Pieces/Ctn: 10
 Lin Ft/Ctn: 125
 Cartons/Pallet: 40
 lbs/Ctn: ≤ 19
 Colors Available:

cw



Band Board with foam insert

A 7-1/4" wide insulated lineal that serves as a transition piece between two different styles of siding or other construction materials.

Note: Use the dual-undersill trim (56916) to accommodate the lap siding below.

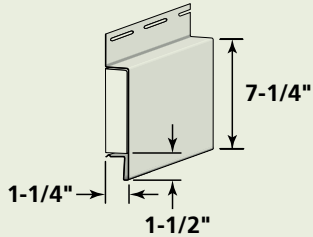

Product Code: 55814

Finish: Rough Cedar
 Length: 16' 8"
 Pieces/Ctn: 5
 Lin Ft/Ctn: 82' 5"
 Cartons/Pallet: 16
 lbs/Ctn: ≤ 33
 Colors Available:

NC CW

3/8" H-Bar

Joins soffit panels. Particularly useful on porch ceilings and hip roof applications.

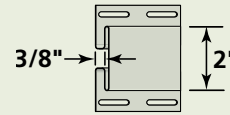

Product Code: 52505

Finish: Matte
 Length: 12' 6"
 Channel: 3/8"
 Pieces/Ctn: 10
 Lin Ft/Ctn: 125
 Cartons/Pallet: 53
 lbs/Ctn: ≤ 28
 Colors Available:

S CW

5" Double Channel Lineal

Exposure matches 5" window and door surround lineals.

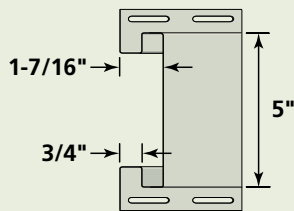

Product Code: 54714

Finish: Matte
 Length: 18'
 Pieces/Ctn: 10
 Lin Ft/Ctn: 180
 Cartons/Pallet: 15
 lbs/Ctn: ≤ 66
 Colors Available:

S CW

3/4" H-Bar

Joins soffit panels. Particularly useful on porch ceilings and hip roof applications.

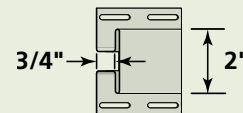

Product Code: 52507

Finish: Matte
 Length: 12' 6"
 Channel: 3/4"
 Pieces/Ctn: 10
 Lin Ft/Ctn: 125
 Cartons/Pallet: 42
 lbs/Ctn: ≤ 32
 Colors Available:

CW

1/2" H-Bar

Joins soffit panels. Particularly useful on porch ceilings and hip roof applications.

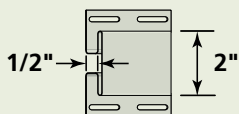

Product Code: 52504

Finish: Matte
 Length: 12' 6"
 Channel: 1/2"
 Pieces/Ctn: 10
 Lin Ft/Ctn: 125
 Cartons/Pallet: 39
 lbs/Ctn: ≤ 29
 Colors Available:

AR CG PB GG SG

SNB DT NC SW S

CW

Look what you can achieve:



Find Your Perfect Color Mix

Designers are using every conceivable color combination to create distinctive exterior designs with a modern sensibility. You can do the same thing with your home. The optimum color blend has the power to bring out the best features of your home. Whatever your color goal is, CertainTeed can help you reach it.



This home has a cool theme (selection of cool grays), but it also has a subtle theme because these grays have similar color intensity and value.

Trim Color Combinations

Traditional white trim accentuates windows cleanly with any color siding, as shown below. Other options (left) include a more subtle combination, with trim and siding closer in hue and intensity; or a reversal of dark trim with light siding as a powerful way to frame your home.



This home has a warm theme and the colors are stronger than a typical home.



Siding: Cedar Impressions Double 9" Staggered Rough-Split Shakes in natural clay
Trim: Restoration Millwork in natural white. Corner Trim is Cedar Impressions matching mitered corner in natural clay
Roof: Landmark in resawn shake

CertainTeed Visualization and Design Tools

Explore the possibilities

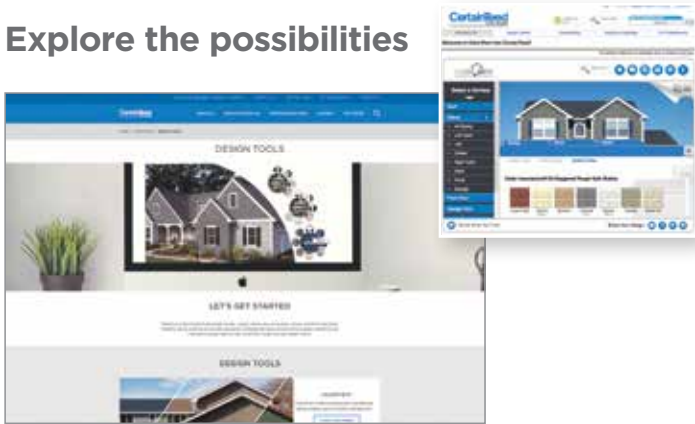

ColorView® allows users to choose from a library of stock homes to create their own custom exterior using the many color, style and types of CertainTeed roofing and siding products.

ColorView® DIY takes ColorView to the next level in home exterior designing. You or your customers can upload a photo of their home, select the siding, roofing, and trim areas they want to update, and start exploring which CertainTeed products look best on their home.

Just like ColorView DIY, you or your customers can upload a photo of a home using **ColorView Pro**. But instead of masking the products onto the home yourself, our professionals will do it for you for a small fee.

Ageless Cedar™ Blend-It™ Tool helps you explore Ageless Cedar Color Blend mixes of Cedar Impressions Individual 5" Sawmill Shingles. View how Color Blends look on a home to help you choose your own one-of-a-kind design.

Visit the color tools page:
www.certainteed.com/colorview

What is Your Color Comfort?

Our user-friendly color tools are designed to help you every step of the way. This chart shows which tool will work best for your color comfort level.

	ColorCoach	ColorView	ColorView DIY	ColorView Pro
Novice You are not sure about colors and where to start.	X			
Intermediate You understand color and enjoy experimenting with color combinations but are not exactly sure which color direction you want to go.		X		
Expert You already know what colors you want to use, but would like to see how the products available in your color theme will look together on your home.			X	X



ColorCoach™

A simple web-based tool that acts as a virtual color swatch book. You can save different combinations, use them in ColorView and share them via social media for second opinions.

Trim-It®

CertainTeed's "Trim-It" tool allows you to create distinction with the wide offering of accent and decorative trim products from both the vinyl and composite product lines.

CertainTeed products are designed to work together and complement each other in color and style to give any home a beautiful finished look.



POLYMER SHAKES & SHINGLES



VINYL SIDING



INSULATED SIDING



SOFFIT



PVC EXTERIOR TRIM & BEADBOARD



VINYL CARPENTRY® TRIM



STONE



HOUSEWRAP



ROOFING AND VENTILATION



DECKING AND RAILING



MOLDED FENCE



EXTRUDED FENCE



facebook.com/CertainTeed



[YouTube youtube.com/c/certainteedsaintgobain](https://youtube.com/c/certainteedsaintgobain)



CertainTeed

CEILING • DECKING • FENCE • GYPSUM • INSULATION • RAILING • ROOFING • SIDING • TRIM
 20 Moores Road Malvern, PA 19355 Professional: 800-233-8990 Consumer: 800-782-8777 certainteed.com

© 01/21 CertainTeed, Printed in the USA, Code No. CTS160