

DATASHEET

FANUC

A06B-0601-B031

OTHER SYMBOLS:

A06B0601B031, A06B0601 B031, A06B0601-B031, A06B 0601B031, A06B 0601 B031, A06B 0601-B031, A06B-0601B031, A06B-0601 B031, A06B-0601-B031

**RGB ELEKTRONIKA AGACIAK CIACIEK
SPÓŁKA JAWNA**

Jana Długosza 2-6 Street
51-162 Wrocław
Poland

✉ biuro@rgbelektronika.pl

☎ +48 71 325 15 05



www.rgbelektronika.pl



www.rgbautomatyka.pl

YOUR PARTNER IN MAINTENANCE

Repair **this product** with RGB ELEKTRONIKA

[ORDER A DIAGNOSIS »](#)

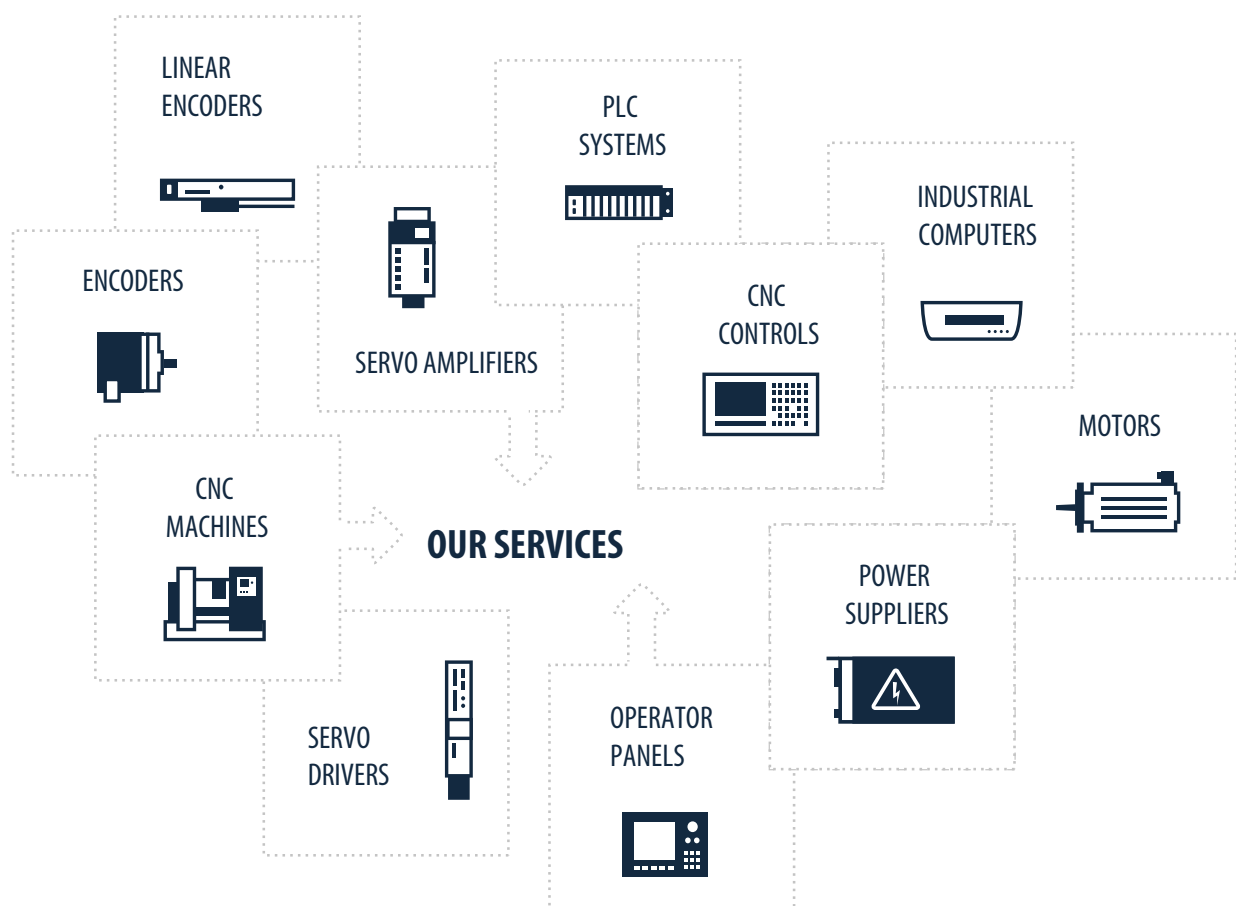

At our premises in Wrocław, we have a fully equipped servicing facility. Here we perform all the repair works and test each later sold unit. Our trained employees, equipped with a wide variety of tools and having several testing stands at their disposal, are a guarantee of the highest quality service.

Buy **this product** at RGB AUTOMATYKA

[BUY »](#)

FANUC AC SERVO MOTOR αi series
FANUC AC SPINDLE MOTOR αi series
FANUC SERVO AMPLIFIER αi series

MAINTENANCE MANUAL

B-65285EN/04

- No part of this manual may be reproduced in any form.
- All specifications and designs are subject to change without notice.

The products in this manual are controlled based on Japan's "Foreign Exchange and Foreign Trade Law". The export from Japan may be subject to an export license by the government of Japan.

Further, re-export to another country may be subject to the license of the government of the country from where the product is re-exported. Furthermore, the product may also be controlled by re-export regulations of the United States government.

Should you wish to export or re-export these products, please contact FANUC for advice.

In this manual we have tried as much as possible to describe all the various matters.

However, we cannot describe all the matters which must not be done, or which cannot be done, because there are so many possibilities.

Therefore, matters which are not especially described as possible in this manual should be regarded as "impossible".

- If operation is abnormal, for example, when an alarm is issued or a hardware failure occurs, the operation described in this manual is not guaranteed unless otherwise specifically noted. If operation is abnormal, take action according to the instructions specifically described in this manual if any or contact FANUC when the instructions are not described.

- Generally, a "safety function" means a function that protects the operators from danger posed by the machine.

The signals and functions described in this manual cannot be used separately for any "safety function" unless otherwise described as being [usable for the safety function]. Their specifications are not assumed to be used as the [safety function] in this case, unexpected danger may be caused. If you have any questions, contact FANUC.

- A device connection error or setting error can lead to unpredictable operation. When starting to operate the machine for the first time after assembling the machine, replacing parts, or changing parameter settings, exercise extreme care.

SAFETY PRECAUTIONS

The "Safety Precautions" section describes the safety precautions relating to the use of FANUC servo motors, spindle motors, and servo amplifiers (Power Supply, Servo Amplifier, and Spindle Amplifier). Users of any servo motor or amplifier model are requested to read the "Safety Precautions" carefully before using the servo motor or amplifier.

The users are also requested to read an applicable specification manual carefully and understand each function of the motor or amplifier for correct use.

The users are basically forbidden to do any behavior or action not mentioned in the "Safety Precautions." They are invited to ask FANUC previously about what behavior or action is prohibited.

Contents

1.1	DEFINITION OF WARNING, CAUTION, AND NOTE.....	s-2
1.2	FANUC AC SERVO MOTOR α is/ α i series	
	FANUC AC SPINDLE MOTOR α i series	s-3
1.2.1	Warning	s-3
1.2.2	Caution.....	s-5
1.2.3	Note.....	s-6
1.3	FANUC SERVO AMPLIFIER α i series	s-8
1.3.1	Warnings and Cautions Relating to Mounting.....	s-8
1.3.1.1	Warning	s-8
1.3.1.2	Caution	s-9
1.3.1.3	Note	s-10
1.3.2	Warnings and Cautions Relating to a Pilot Run	s-10
1.3.2.1	Warning	s-10
1.3.2.2	Caution	s-11
1.3.3	Warnings and Cautions Relating to Maintenance.....	s-12
1.3.3.1	Warning	s-12
1.3.3.2	Caution	s-13
1.3.3.3	Note	s-13

1.1 DEFINITION OF WARNING, CAUTION, AND NOTE

This manual includes safety precautions for protecting the user and preventing damage to the machine. Precautions are classified into Warning and Caution according to their bearing on safety. Also, supplementary information is described as a Note. Read the Warning, Caution, and Note thoroughly before attempting to use the machine.

**WARNING**

Applied when there is a danger of the user being injured or when there is a damage of both the user being injured and the equipment being damaged if the approved procedure is not observed.

**CAUTION**

Applied when there is a danger of the equipment being damaged, if the approved procedure is not observed.

NOTE

The Note is used to indicate supplementary information other than Warning and Caution.

If a precaution described even as "CAUTION" is not followed, a serious result may be caused depending on the status. Be sure to follow the precautions described as "WARNING" and "CAUTION" since they give important information.

* Read this manual carefully, and store it in a safe place.

1.2 FANUC AC SERVO MOTOR α is/ α i series FANUC AC SPINDLE MOTOR α i series

1.2.1 Warning

WARNING

- **Be sure to ground a motor frame.**

To avoid electric shocks, be sure to connect the grounding terminal in the terminal box to the grounding terminal of the machine.

- **Before starting to connect a motor to electric wires, make sure they are isolated from an electric power source.**

A failure to observe this caution is vary dangerous because you may get electric shocks.

- **Do not ground a motor power wire terminal or short-circuit it to another power wire terminal.**

A failure to observe this caution may cause electric shocks or a burned wiring.

* Some motors require a special connection such as a winding changeover. For details, refer to Chapter 7, "OUTLINE DRAWINGS," in B-65262EN.

- **When connecting a cord such as a power line to the terminal block, use specified tightening torque to firmly connect the cord.**

If operation is performed with a loose terminal, the terminal block can overheat, resulting in a fire. Moreover, a terminal can be detached, resulting in a ground fault, short circuit, or electric shock.

- **Do not apply current when a terminal of the terminal block or the crimp terminal of a power line is exposed.**

If the hand or a conductive object touches a terminal of the terminal block or the crimp terminal of a power line, you may get electric shocks. Attach an insulation cover (accessory) onto the terminal block. Moreover, cover the crimp terminal at the tip of a power line with an insulation tube.

- **Assemble and install a power connector securely.**

If a power line is detached due to a failure in crimping or soldering, or a conductive area is exposed due to a failure in shell assembly, you may get electric shocks.

- **Do not touch a motor with a wet hand.**

A failure to observe this caution is vary dangerous because you may get electric shocks.

- **Before touching a motor, shut off the power to it.**

Even if a motor is not rotating, there may be a voltage across the terminals of the motor.

Especially before touching a power supply connection, take sufficient precautions.

Otherwise you may get electric shocks.

- **Do not touch any terminal of a motor for a while (at least 20 minutes) after the power to the motor is shut off.**

High voltage remains across power line terminals of a motor for a while after the power to the motor is shut off. So, do not touch any terminal or connect it to any other equipment. Otherwise, you may get electric shocks or the motor and/or equipment may get damaged.

- **On the machine, install a stop device for securing safety.**

The brake built into the servo motor is not a stop device for securing safety. The machine may not be held if a failure occurs.

WARNING

- **Do not enter the area under the vertical axis without securing safety.**
If a vertical axis drop occurs unexpectedly, you may be injured.
- **Fasten a motor firmly before driving the motor.**
If a motor is driven when the motor is not fastened firmly or is fastened insufficiently, the motor can tumble or is removed, resulting in a danger. If the motor mounting section is not sufficiently strong, the machine may be damaged or the user may be injured.
- **Do not get close to a rotary section of a motor when it is rotating.**
When a motor is rotating, clothes or fingers can be caught, resulting in an injury.
- **Do not drive a motor with an object such as a key exposed.**
An object such as a key can be thrown away, resulting in an injury. Before rotating a motor, check that there is no object that is thrown away by motor rotation.
- **Do not apply a radial load exceeding the "allowable radial load".**
The shaft can break, and components can be thrown away. When the vertical axis is involved, a vertical axis drop can occur.
- **To drive a motor, use a specified amplifier and parameters.**
An incorrect combination of a motor, amplifier, and parameters may cause the motor to behave unexpectedly. This is dangerous, and the motor may get damaged.
- **Do not bring any dangerous stuff near a motor.**
Motors are connected to a power line, and may get hot. If a flammable is placed near a motor, it may be ignited, catch fire, or explode.
- **Be safely dressed when handling a motor.**
Wear safety shoes or gloves when handling a motor as you may get hurt on any edge or protrusion on it or electric shocks.
- **Use a crane or lift to move a motor from one place to another.**
A motor is heavy, so that if you lift a motor by hand, you may be exposed to various risks. For example, the waist can be damaged, and the motor can drop to injure you. Use equipment such as a crane as needed. (For the weight of a motor, see Specification manual (B-65262EN).)
- **Do not touch a motor when it is running or immediately after it stops.**
A motor may get hot when it is running. Do not touch the motor before it gets cool enough. Otherwise, you may get burned.
- **Be careful not get your hair or cloths caught in a fan.**
Be careful especially for a fan used to generate an inward air flow.
Be careful also for a fan even when the motor is stopped, because it continues to rotate while the amplifier is turned on.
- **Install the components around a motor securely.**
If a component is displaced or removed during motor rotation, a danger can result.

1.2.2 Caution

CAUTION

- **Use the eyebolt of a motor to move the motor only.**

When a motor is installed on a machine, do not move the machine by using the eyebolt of the motor. Otherwise, the eyebolt and motor can be damaged.

- **Do not disassemble a motor.**

Disassembling a motor may cause a failure or trouble in it.

If disassembly is in need because of maintenance or repair, please contact a service representative of FANUC.

For pulse coder replacement, refer to the Subsection III-1.2.6.

- **Do not machine and modify a motor.**

Do not machine and modify a motor in any case except when motor machining or modification is specified by FANUC. Modifying a motor may cause a failure or trouble in it.

- **Do not conduct dielectric strength or insulation test for a sensor.**

Such a test can damage elements in the sensor.

- **Be sure to connect motor cables correctly.**

An incorrect connection of a cable cause abnormal heat generation, equipment malfunction, or failure. Always use a cable with an appropriate current carrying capacity (or thickness). For details, refer to Chapter 7, "OUTLINE DRAWINGS" in the Specification manual (B-65262EN).

- **Do not apply shocks to a motor or cause scratches to it.**

If a motor is subjected to shocks or is scratched, its components may be adversely affected, resulting in normal operation being impaired. Plastic components and sensors can be damaged easily. So, handle those components very carefully. In particular, do not lift a motor by using a plastic component, connector, terminal block, and so forth.

- **Do not step or sit on a motor, and do not put a heavy object on a motor.**

If you step or sit on a motor, it may get deformed or broken. Do not put a motor on another unless they are in packages.

- **When attaching a component having inertia, such as a pulley, to a motor, ensure that any imbalance between the motor and component is minimized.**

If there is a large imbalance, the motor may vibrates abnormally, resulting in the motor being broken.

- **Be sure to attach a key to a motor with a keyed shaft.**

If a motor with a keyed shaft runs with no key attached, it may impair torque transmission or cause imbalance, resulting in the motor being broken.

- **Use a motor under an appropriate environmental condition.**

Using a motor in an adverse environment may cause a failure or trouble in it. Refer to Specification manual (B-65262EN) for details of the operating and environmental conditions for motors.

- **Do not apply a commercial power source voltage directly to a motor.**

Applying a commercial power source voltage directly to a motor may result in its windings being burned. Be sure to use a specified amplifier for supplying voltage to the motor.

CAUTION**- Do not use the brake built into a motor for braking.**

The brake built into a servo motor is designed for holding. If the brake is used for braking, a failure can occur.

- Ensure that motors are cooled if they are those that require forcible cooling.

If a motor that requires forcible cooling is not cooled normally, it may cause a failure or trouble. For a fan-cooled motor, ensure that it is not clogged or blocked with dust and dirt. For a liquid-cooled motor, ensure that the amount of the liquid is appropriate and that the liquid piping is not clogged. For both types, perform regular cleaning and inspection.

- When storing a motor, put it in a dry (non-condensing) place at room temperature (0 to 40 °C).

If a motor is stored in a humid or hot place, its components may get damaged or deteriorated. In addition, keep a motor in such a position that its shaft is held horizontal and its terminal box is at the top.

- FANUC motors are designed for use with machines. Do not use them for any other purpose.

If a FANUC motor is used for an unintended purpose, it may cause an unexpected symptom or trouble. If you want to use a motor for an unintended purpose, previously consult with FANUC.

1.2.3 Note

NOTE**- Ensure that a base or frame on which a motor is mounted is strong enough.**

Motors are heavy. If a base or frame on which a motor is mounted is not strong enough, it is impossible to achieve the required precision.

- Do not remove a nameplate from a motor.

If a nameplate comes off, be careful not to lose it. If the nameplate is lost, the motor becomes unidentifiable, resulting in maintenance becoming impossible.

- When testing the winding or insulation resistance of a motor, satisfy the conditions stipulated in IEC60034.

Testing a motor under a condition severer than those specified in IEC60034 may damage the motor.

- For a motor with a terminal box, make a conduit hole for the terminal box in a specified position.

When making a conduit hole, be careful not to break or damage unspecified portions. Refer to the Specification manual (B-65262EN).

- Before using a motor, measure its winding and insulation resistances, and make sure they are normal.

Especially for a motor that has been stored for a prolonged period of time, conduct these checks. A motor may deteriorate depending on the condition under which it is stored or the time during which it is stored. For the winding resistances of motors, refer to the Specification manual (B-65262EN), or ask FANUC. For insulation resistances, see the following table.

NOTE

- **To use a motor as long as possible, perform periodic maintenance and inspection for it, and check its winding and insulation resistances.**

Note that extremely severe inspections (such as dielectric strength tests) of a motor may damage its windings. For the winding resistances of motors, refer to the Specification manual (B-65262EN), or ask FANUC. For insulation resistances, see the following table.

MOTOR INSULATION RESISTANCE MEASUREMENT

Measure an insulation resistance between each winding and motor frame using an insulation resistance meter (500 VDC). Judge the measurements according to the following table. Make an insulation resistance measurement on a single motor unit after detaching cords such as a power line.

Insulation resistance	Judgment
100 M Ω or higher	Acceptable
10 to 100 M Ω	The winding has begun deteriorating. There is no problem with the performance at present. Be sure to perform periodic inspection.
1 to 10 M Ω	The winding has considerably deteriorated. Special care is in need. Be sure to perform periodic inspection.
Lower than 1 M Ω	Unacceptable. Replace the motor.

1.3 FANUC SERVO AMPLIFIER α i series

1.3.1 Warnings and Cautions Relating to Mounting

1.3.1.1 Warning

WARNING

- **Check the specification code of the amplifier.**
Check that the delivered amplifier is as originally ordered.
- **Mount a ground fault interrupter.**
To guard against fire and electric shock, fit the factory power supply or machine with a ground fault interrupter (designed for use with an inverter).
- **Securely ground the amplifier.**
Securely connect the ground terminal and metal frame of the amplifier and motor to a common ground plate of the power magnetics cabinet.
- **Be aware of the weight of the amplifier and other components.**
Control motor amplifiers and AC reactors are heavy. When transporting them or mounting them in the cabinet, therefore, be careful not to injure yourself or damage the equipment. Be particularly careful not to jam your fingers between the cabinet and amplifier.
- **Never ground or short-circuit either the power supply lines or power lines.**
Protect the lines from any stress such as bending. Handle the ends appropriately.
- **Ensure that the power supply lines, power lines, and signal lines are securely connected.**
A loose screw, loose connection, or the like will cause a motor malfunction or overheating, or a ground fault.
Be extremely careful with power supply lines, motor power lines, and DC link connections through which a large amount of current passes, because a loose screw (or poor contact in a connector or poor connection between a connector terminal and a cable) may cause a fire.
- **Insulate all exposed parts that are charged.**
- **Never touch the regenerative discharge resistor or radiator directly.**
The surface of the radiator and regenerative discharge unit become extremely hot. Never touch them directly. An appropriate structure should also be considered.
- **Close the amplifier cover after completing the wiring.**
Leaving the cover open presents a danger of electric shock.
- **Do not disassemble the amplifier.**
- **Ensure that the cables used for the power supply lines and power lines are of the appropriate diameter and temperature ratings.**
- **Do not apply an excessively large force to plastic parts.**
If a plastic section breaks, it may cause internal damage, thus interfering with normal operation. The edge of a broken section is likely to be sharp and, therefore, presents a risk of injury.

1.3.1.2 Caution

CAUTION

- **Do not step or sit on the amplifier.**
Also, do not stack unpacked amplifiers on top of each other.
- **Use the amplifier in an appropriate environment.**
See the allowable ambient temperatures and other requirements, given in the corresponding descriptions.
- **Protect the amplifier from corrosive or conductive mist or drops of water.**
Use a filter if necessary.
- **Protect the amplifier from impact.**
Do not place anything on the amplifier.
- **Do not block the air inlet to the radiator.**
A deposit of coolant, oil mist, or chips on the air inlet will result in a reduction in the cooling efficiency. In some cases, the required efficiency cannot be achieved. The deposit may also lead to a reduction in the useful life of the semiconductors. Especially, when outside air is drawn in, mount filters on both the air inlet and outlet. These filters must be replaced regularly.
So, an easy-to-replace type of filter should be used.
- **Connect the power supply lines and power lines to the appropriate terminals and connectors.**
- **Connect the signal lines to the appropriate connectors.**
- **Before connecting the power supply wiring, check the supply voltage.**
Check that the supply voltage is within the range specified in this manual, then connect the power supply lines.
- **Ensure that the combination of motor and amplifier is appropriate.**
- **Ensure that valid parameters are specified.**
Specifying an invalid parameter for the combination of motor and amplifier may not only prevent normal operation of the motor but also result in damage to the amplifier.
- **Ensure that the amplifier and peripheral equipment are securely connected.**
Check that the magnetic contactor, circuit breaker, and other devices mounted outside the amplifier are securely connected to each other and that those devices are securely connected to the amplifier.
- **Check that the amplifier is securely mounted in the power magnetics cabinet.**
If any clearance is left between the power magnetics cabinet and the surface on which the amplifier is mounted, dust entering the gap may build up and prevent the normal operation of the amplifier.
- **Apply appropriate countermeasures against noise.**
Adequate countermeasures against noise are required to maintain normal operation of the amplifier. For example, signal lines must be routed away from power supply lines and power lines.

1.3.1.3 Note

NOTE

- **Keep the nameplate clearly visible.**
- **Keep the legend on the nameplate clearly visible.**
- **After unpacking the amplifier, carefully check for any damage.**
- **Mount the amplifier in a location where it can be easily accessed periodic inspection and daily maintenance.**
- **Leave sufficient space around the machine to enable maintenance to be performed easily.**
Do not place any heavy objects such that they would interfere with the opening of the doors.
- **Keep the parameter table and spare parts at hand.**
Also, keep the specifications at hand. These items must be stored in a location where they can be retrieved immediately.
- **Provide adequate shielding.**
A cable to be shielded must be securely connected to the ground plate, using a cable clamp or the like.

1.3.2 Warnings and Cautions Relating to a Pilot Run

1.3.2.1 Warning

 WARNING

- **Before turning on the power, check that the cables connected to the power magnetics cabinet and amplifier, as well as the power lines and power supply lines, are securely connected. Also, check that no lines are slack.**
A loose screw, loose connection, or the like will cause a motor malfunction or overheating, or a ground fault. Be extremely careful with power supply lines, motor power lines, and DC link connections through which a large amount of current passes, because a loose screw (or poor contact in a connector or poor connection between a connector terminal and a cable) may cause a fire.
- **Before turning on the power, ensure that the power magnetics cabinet is securely grounded.**
- **Before turning on the power, check that the door of the power magnetics cabinet and all other doors are closed.**
Ensure that the door of the power magnetics cabinet containing the amplifier, and all other doors, are securely closed. During operation, all doors must be closed and locked.
- **Apply extreme caution if the door of the power magnetics cabinet or another door must be opened.**
Only a person trained in the maintenance of the corresponding machine or equipment should open the door, and only after shutting off the power supply to the power magnetics cabinet (by opening both the input circuit breaker of the power magnetics cabinet and the factory switch used to supply power to the cabinet). If the machine must be operated with the door open to enable adjustment or for some other purpose, the operator must keep his or her hands and tools well away from any dangerous voltages. Such work must be done only by a person trained in the maintenance of the machine or equipment.

⚠ WARNING

- **When operating the machine for the first time, check that the machine operates as instructed.**
To check whether the machine operates as instructed, first specify a small value for the motor, then increase the value gradually. If the motor operates abnormally, perform an emergency stop immediately.
- **After turning on the power, check the operation of the emergency stop circuit.**
Press the emergency stop button to check that the motor stops immediately, and that the power being supplied to the amplifier is shut off by the magnetic contactor.
- **Before opening a door or protective cover of a machine to enable adjustment of the machine, first place the machine in the emergency stop state and check that the motor has stopped.**

1.3.2.2 Caution**⚠ CAUTION**

- **Note whether an alarm status relative to the amplifier is displayed at power-up or during operation.**
If an alarm is displayed, take appropriate action as explained in the maintenance manual. If the work to be done requires that the door of the power magnetics cabinet be left open, the work must be carried out by a person trained in the maintenance of the machine or equipment. Note that if some alarms are forcibly reset to enable operation to continue, the amplifier may be damaged. Take appropriate action according to the contents of the alarm.
- **Before operating the motor for the first time, mount and adjust the position and speed sensors.**
Following the instructions given in the maintenance manual, adjust the position and speed sensors for the spindle so that an appropriate waveform is obtained.
If the sensors are not properly adjusted, the motor may not rotate normally or the spindle may fail to stop as desired.
- **If the motor makes any abnormal noise or vibration while operating, stop it immediately.**
Note that if operation is continued in spite of there being some abnormal noise or vibration, the amplifier may be damaged. Take appropriate corrective action, then resume operation.
- **Observe the ambient temperature and output rating requirements.**
The continuous output rating or continuous operation period of some amplifiers may fall as the ambient temperature increases. If the amplifier is used continuously with an excessive load applied, the amplifier may be damaged.
- **Unless otherwise specified, do not insert or remove any connector while the power is turned on. Otherwise, the amplifier may fail.**

1.3.3 Warnings and Cautions Relating to Maintenance

1.3.3.1 Warning

WARNING

- **Read the maintenance manual carefully and ensure that you are totally familiar with its contents.**
The maintenance manual describes daily maintenance and the procedures to be followed in the event of an alarm being issued. The operator must be familiar with these descriptions.
- Notes on replacing a fuse or PC board
 - 1) Before starting the replacement work, ensure that the circuit breaker protecting the power magnetics cabinet is open.
 - 2) Check that the red LED that indicates that charging is in progress is not lit.
The position of the charging LED on each model of amplifier is given in this manual. While the LED is lit, hazardous voltages are present inside the unit, and thus there is a danger of electric shock.
 - 3) Some PC board components become extremely hot. Be careful not to touch these components.
 - 4) Ensure that a fuse having an appropriate rating is used.
 - 5) Check the specification code of a PC board to be replaced. If a modification drawing number is indicated, contact FANUC before replacing the PC board.
Also, before and after replacing a PC board, check its pin settings.
 - 6) After replacing the fuse, ensure that the screws are firmly tightened. For a socket-type fuse, ensure that the fuse is inserted correctly.
 - 7) After replacing the PC board, ensure that it is securely connected.
 - 8) Ensure that all power lines, power supply lines, and connectors are securely connected.
- **Take care not to lose any screws.**
When removing the case or PC board, take care not to lose any screws. If a screw is lost inside the nit and the power is turned on, the machine may be damaged.
- **Notes on replacing the battery of the absolute pulse coder**
Replace the battery only while the power is on. If the battery is replaced while the power is turned off, the stored absolute positioning data will be lost. Some series servo amplifier modules have batteries in their servo amplifiers. To replace the battery of any of those models, observe the following procedure: Open the door of the power magnetics cabinet; Leave the control power of the power supply module on; Place the machine in the emergency stop state so that the power being input to the amplifier is shut off; Then, replace the battery. Replacement work should be done only by a person who is trained in the related maintenance and safety requirements. The power magnetics cabinet in which the servo amplifier is mounted has a high-voltage section. This section presents a severe risk of electric shock.
- **Check the number of any alarm.**
If the machine stops upon an alarm being issued, check the alarm number. Some alarms indicate that a component must be replaced. If the power is reconnected without first replacing the failed component, another component may be damaged, making it difficult to locate the original cause of the alarm.
- **Before resetting an alarm, ensure that the original cause of the alarm has been removed.**
- **Contact FANUC whenever a question relating to maintenance arises.**
- **Notes on removing the amplifier**
Before removing the amplifier, first ensure that the power is shut off. Be careful not to jam your fingers between the power magnetics cabinet and amplifier.

1.3.3.2 Caution

CAUTION

- **Ensure that all required components are mounted.**
When replacing a component or PC board, check that all components, including the snubber capacitor, are correctly mounted. If the snubber capacitor is not mounted, for example, the IPM will be damaged.
- **Tighten all screws firmly.**
- **Check the specification code of the fuse, PC board, and other components.**
When replacing a fuse or PC board, first check the specification code of the fuse or PC board, then mount it in the correct position. The machine will not operate normally if a fuse or PC board having other than the correct specification code is mounted, or if a fuse or PC board is mounted in the wrong position.
- **Mount the correct cover.**
The cover on the front of the amplifier carries a label indicating a specification code. When mounting a previously removed front cover, take care to mount it on the unit from which it was removed.
- **Notes on cleaning the heat sink and fan**
 - 1) A dirty heat sink or fan results in reduced semiconductor cooling efficiency, which degrades reliability. Periodic cleaning is necessary.
 - 2) Using compressed air for cleaning scatters the dust. A deposit of conductive dust on the amplifier or peripheral equipment will result in a failure.
 - 3) To clean the heat sink, do so only after turning the power off and ensuring that the heat sink has cooled to room temperature. The heat sink becomes extremely hot, such that touching it during operation or immediately after power-off is likely to cause a burn. Be extremely careful when touching the heat sink.

1.3.3.3 Note

NOTE

- **Ensure that the battery connector is correctly inserted.**
If the power is shut off while the battery connector is not connected correctly, the absolute position data for the machine will be lost.
- **Store the manuals in a safe place.**
The manuals should be stored in a location where they can be accessed immediately if so required during maintenance work.
- **Notes on contacting FANUC**
Inform FANUC of the details of an alarm and the specification code of the amplifier so that any components required for maintenance can be quickly secured, and any other necessary action can be taken without delay.

PREFACE

Organization of this manual

This manual describes information necessary to maintain FANUC Servo Amplifier αi series products, such as a Power Supply, Servo Amplifier, and Spindle Amplifier and FANUC Servo Motor $\alpha is/\alpha i$ series and FANUC Spindle Motor αi series products.

Part I explains the start-up procedure, and part II focuses on troubleshooting.

Part III explains the maintenance for servo motor and spindle motor.

The abbreviations listed below are used in this manual.

Product name	Abbreviations
FANUC Series 15 <i>i</i>	FS15 <i>i</i>
FANUC Series 16 <i>i</i>	FS16 <i>i</i>
FANUC Series 18 <i>i</i>	FS18 <i>i</i>
FANUC Series 21 <i>i</i>	FS21 <i>i</i>
FANUC Series 30 <i>i</i>	FS30 <i>i</i>
FANUC Series 31 <i>i</i>	FS31 <i>i</i>
FANUC Series 32 <i>i</i>	FS32 <i>i</i>
FANUC Series 0 <i>i</i>	FS0 <i>i</i>
FANUC Power Mate <i>i</i> -D	PM <i>i</i>
FANUC Power Mate <i>i</i> -H	
Power Supply	PS
Servo Amplifier	SV
Spindle Amplifier	SP

- * In this manual, the parameter numbers of servo parameters are sometimes indicated without CNC product names as follows:

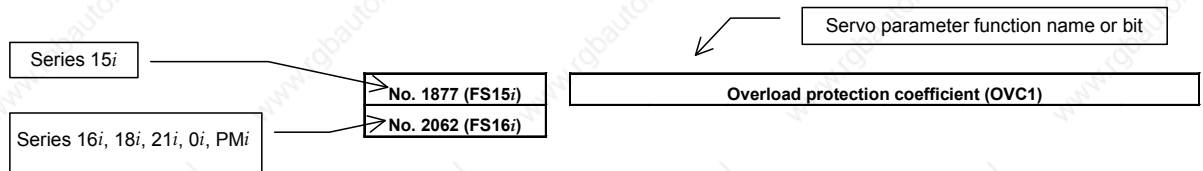

- * The manuals shown below provide information related to this manual. This manual may refer you to these manuals.

FANUC SERVO AMPLIFIER αi series Descriptions	B-65282EN
FANUC AC SERVO MOTOR αi series Descriptions	B-65262EN
FANUC AC SPINDLE MOTOR αi series Descriptions	B-65272EN
FANUC AC SERVO MOTOR αi series, FANUC AC SERVO MOTOR βi series, FANUC LINEAR MOTOR LiS series,	
FANUC SYNCHRONOUS BUILT-IN SERVO MOTOR DiS series Parameter Manual	B-65270EN
FANUC AC SPINDLE MOTOR $\alpha i/\beta i$ series, BUILT-IN SPINDLE MOTOR Bi series Parameter Manual	B-65280EN

TABLE OF CONTENTS

SAFETY PRECAUTIONS	S-1
1.1 DEFINITION OF WARNING, CAUTION, AND NOTE	s-2
1.2 FANUC AC SERVO MOTOR α is/ α i series FANUC AC SPINDLE MOTOR α i series	s-3
1.2.1 Warning	s-3
1.2.2 Caution	s-5
1.2.3 Note	s-6
1.3 FANUC SERVO AMPLIFIER α i series	s-8
1.3.1 Warnings and Cautions Relating to Mounting	s-8
1.3.1.1 Warning	s-8
1.3.1.2 Caution	s-9
1.3.1.3 Note	s-10
1.3.2 Warnings and Cautions Relating to a Pilot Run	s-10
1.3.2.1 Warning	s-10
1.3.2.2 Caution	s-11
1.3.3 Warnings and Cautions Relating to Maintenance	s-12
1.3.3.1 Warning	s-12
1.3.3.2 Caution	s-13
1.3.3.3 Note	s-13
PREFACE	p-1
I. START-UP PROCEDURE	
1 OVERVIEW	3
2 CONFIGURATIONS	4
2.1 CONFIGURATIONS	4
2.2 MAJOR COMPONENTS	5
2.2.1 Power Supply	5
2.2.2 Servo Amplifier	6
2.2.3 Spindle Amplifier	8
3 START-UP PROCEDURE	11
3.1 START-UP PROCEDURE (OVERVIEW)	11
3.2 CONNECTING THE POWER	11
3.2.1 Checking the Voltage and Capacity of the Power	11
3.2.2 Connecting a Protective Ground	12
3.2.3 Selecting the Ground Fault Interrupter That Matches the Leakage Current	12
3.2.4 Checking the Phase Sequence of the Fan Motor Power Supply	12
3.3 INITIALIZING PARAMETERS	12
4 CONFIRMATION OF THE OPERATION	13
4.1 POWER SUPPLY	13
4.1.1 Checking the Status LEDs (Power Supply)	14
4.1.2 Check Terminal on the Printed-circuit Board	14
4.1.3 The PIL LED (Power ON Indicator) Is Off	16
4.1.4 Checking Method when Magnetic Contactor Is not Switched On	16
4.2 SERVO AMPLIFIER	17
4.2.1 Checking the STATUS Display (Servo Amplifier)	18

4.2.2	VRDY-OFF Alarm Indicated on the CNC Screen	18
4.2.3	Method for Observing Motor Current	19
4.3	SPINDLE AMPLIFIER	22
4.3.1	STATUS Display (Spindle Amplifier)	23
4.3.2	Troubleshooting at Startup	23
4.3.2.1	The PIL LED (power-on indicator) is off	23
4.3.2.2	The STATUS display is blinking with "--"	23
4.3.2.3	The motor does not turn	24
4.3.2.4	A specified speed cannot be obtained	24
4.3.2.5	When cutting is not performed, the spindle vibrates, making noise	25
4.3.2.6	An overshoot or hunting occurs	25
4.3.2.7	Cutting power weakens or acceleration/deceleration slows down	25
4.3.3	Status Error Indication Function	26
4.3.4	Checking the Feedback Signal Waveform	29
4.3.4.1	α M sensor, α MZ sensor, and α BZ sensor	30
4.3.4.2	Analog α CZ sensor	31
4.3.4.3	α position coder S	32
4.3.5	Spindle Check Board	32
4.3.5.1	Spindle check board specifications	32
4.3.5.2	Check board connection	33
4.3.5.3	Check terminal output signals	33
4.3.6	Observing Data Using the Spindle Check Board	35
4.3.6.1	Overview	35
4.3.6.2	Major characteristics	35
4.3.6.3	Observation method	35
4.3.6.4	Specifying data to be monitored	36
4.3.6.5	Address descriptions and initial values (Spindle Amplifier)	36
4.3.6.6	Principles in outputting the internal data of the serial spindle	37
4.3.6.7	Data numbers	39
4.3.6.8	Example of observing data	41
4.3.7	Checking Parameters Using the Spindle Check Board	42
4.3.7.1	Overview	42
4.3.7.2	Checking parameters	42
4.3.8	Observing Data Using the SERVO GUIDE	42
4.3.8.1	Overview	42
4.3.8.2	Usable series and editions	42
4.3.8.3	List of spindle data that can be observed using the SERVO GUIDE	43
4.3.8.4	About the spindle control and spindle status signals	44
4.3.8.5	Example of observing data	45

II. TROUBLESHOOTING

1	OVERVIEW	49
2	ALARM NUMBERS AND BRIEF DESCRIPTIONS	50
2.1	FOR Series 15 <i>i</i>	50
2.1.1	Servo Alarm	50
2.1.2	Spindle Alarm	51
2.2	FOR Series 16 <i>i</i> , 18 <i>i</i> , 20 <i>i</i> , 21 <i>i</i> , 0 <i>i</i> , AND Power Mate <i>i</i>	54
2.2.1	Servo Alarm	54
2.2.2	Spindle Alarm	55
2.3	FOR Series 30 <i>i</i> / 31 <i>i</i> /32 <i>i</i>	58
2.3.1	Servo Alarm	58
2.3.2	Spindle Alarm	59
2.4	FOR Series 0 <i>i</i> -D	61

2.4.1	Servo Alarm	61
2.4.2	Spindle Alarm.....	62
3	TROUBLESHOOTING AND ACTION	64
3.1	POWER SUPPLY (αiPS , αiPS_R).....	64
3.1.1	No LED Display (αiPS , αiPS_R)	64
3.1.2	Alarm Code 1 (αiPS).....	64
3.1.3	Alarm Code 2 (αiPS , αiPS_R).....	65
3.1.4	Alarm Code 3 (αiPS).....	65
3.1.5	Alarm Code 4 (αiPS , αiPS_R).....	65
3.1.6	Alarm Code 5 (αiPS , αiPS_R).....	66
3.1.7	Alarm Code 6 (αiPS , αiPS_R).....	66
3.1.8	Alarm Code 7 (αiPS , αiPS_R).....	66
3.1.9	Alarm Code 8 (αiPS_R).....	66
3.1.10	Alarm Code A (αiPS).....	67
3.1.11	Alarm Code E (αiPS , αiPS_R)	67
3.1.12	Alarm Code H (αiPS_R).....	67
3.1.13	Alarm Code P (αiPS , αiPS_R).....	67
3.2	SERVO AMPLIFIER	68
3.2.1	Alarm Code 1	69
3.2.2	Alarm Code 2	69
3.2.3	Alarm Code 5	69
3.2.4	Alarm Code 6	69
3.2.5	Alarm Code F	70
3.2.6	Alarm Code P	70
3.2.7	Alarm Code 8	70
3.2.8	Alarm Codes 8., 9., and A	70
3.2.9	Alarm Codes 8., 9., and A	71
3.2.10	Alarm Codes b, c, and d	71
3.2.11	Alarm Code "-" Blinking	71
3.2.12	Alarm Code U	72
3.2.13	Alarm Code L.....	72
3.2.14	DB Relay Error (CNC Message "Alarm SV0654")	73
3.3	SERVO SOFTWARE	73
3.3.1	Servo Adjustment Screen	73
3.3.2	Diagnosis Screen	74
3.3.3	Overload Alarm (Soft Thermal, OVC).....	75
3.3.4	Feedback Disconnected Alarm.....	76
3.3.5	Overheat Alarm	77
3.3.6	Invalid Servo Parameter Setting Alarm.....	77
3.3.7	Alarms Related to Pulsecoder and Separate Serial Detector	78
3.3.8	Other Alarms	79
3.4	SPINDLE AMPLIFIER	81
3.4.1	Alarm Code 01	81
3.4.2	Alarm Code 02	81
3.4.3	Alarm Code 03	82
3.4.4	Alarm Code 06	82
3.4.5	Alarm Code 07	83
3.4.6	Alarm Code 09	83
3.4.7	Alarm Code 10	83
3.4.8	Alarm Code 12	84
3.4.9	Alarm Code 13	84
3.4.10	Alarm Code 14	84

TABLE OF CONTENTS

B-65285EN/04

3.4.11	Alarm Code 15	85
3.4.12	Alarm Code 16	85
3.4.13	Alarm Code 17	85
3.4.14	Alarm Code 18	85
3.4.15	Alarm Codes 19 and 20	85
3.4.16	Alarm Code 21	86
3.4.17	Alarm Code 22	86
3.4.18	Alarm Code 24	86
3.4.19	Alarm Code 27	86
3.4.20	Alarm Code 29	87
3.4.21	Alarm Code 31	88
3.4.22	Alarm Code 32	88
3.4.23	Alarm Code 34	88
3.4.24	Alarm Code 36	88
3.4.25	Alarm Code 37	89
3.4.26	Alarm Code 41	89
3.4.27	Alarm Code 42	90
3.4.28	Alarm Code 43	90
3.4.29	Alarm Code 46	90
3.4.30	Alarm Code 47	90
3.4.31	Alarm Code 49	91
3.4.32	Alarm Code 50	91
3.4.33	Alarm Codes 52 and 53	92
3.4.34	Alarm Code 54	92
3.4.35	Alarm Code 55	92
3.4.36	Alarm Code 56	92
3.4.37	Alarm Code 61	92
3.4.38	Alarm Code 65	93
3.4.39	Alarm Code 66	93
3.4.40	Alarm Code 67	93
3.4.41	Alarm Code 69	93
3.4.42	Alarm Code 70	94
3.4.43	Alarm Code 71	94
3.4.44	Alarm Code 72	94
3.4.45	Alarm Code 73	94
3.4.46	Alarm Code 74	95
3.4.47	Alarm Code 75	95
3.4.48	Alarm Code 76	95
3.4.49	Alarm Code 77	95
3.4.50	Alarm Code 78	96
3.4.51	Alarm Code 79	96
3.4.52	Alarm Code 80	96
3.4.53	Alarm Code 81	96
3.4.54	Alarm Code 82	97
3.4.55	Alarm Code 83	97
3.4.56	Alarm Code 84	98
3.4.57	Alarm Code 85	98
3.4.58	Alarm Code 86	98
3.4.59	Alarm Code 87	98
3.4.60	Alarm Code 88	98
3.4.61	Alarm Code 89	98
3.4.62	Alarm Code 90	99
3.4.63	Alarm Code 91	99
3.4.64	Alarm Code 92	100
3.4.65	Alarm Codes A, A1, and A2	100

3.4.66	Alarm Code b0	100
3.4.67	Alarm Codes C0,C1, and C2	101
3.4.68	Alarm Code C3	101
3.4.69	Alarm Code C4	101
3.4.70	Alarm Code C5	101
3.4.71	Alarm Code C7	101
3.4.72	Alarm Code C8	101
3.4.73	Alarm Code C9	102
3.4.74	Alarm Code d0	102
3.4.75	Alarm Code d1	102
3.4.76	Alarm Code d2	102
3.4.77	Alarm Code d3	103
3.4.78	Alarm Code d4	103
3.4.79	Alarm Code d7	103
3.4.80	Alarm Code d9	103
3.4.81	Alarm Code E0	103
3.4.82	Alarm Code E1	104
3.4.83	Other Alarms	104
3.5	αCi SERIES SPINDLE AMPLIFIER MODULE	105
3.5.1	Alarm Code 12	105
3.5.2	Alarm Code 35	106
4	REPLACING AMPLIFIER COMPONENTS	107
4.1	REPLACEMENT OF A FAN MOTOR	107
4.2	REPLACING BATTERY FOR ABSOLUTE PULSECODERS	112
4.2.1	Overview	112
4.2.2	Replacing Batteries	112
4.2.3	Replacing the Batteries in a Separate Battery Case	113
4.2.4	Replacing the Battery Built into the Servo Amplifier	113
4.2.5	Notes on Replacing a Battery (Supplementary Explanation)	115
4.2.5.1	Battery connection modes	115
4.2.5.2	Connecting the battery for the α series motor	115
4.2.5.3	Notes on attaching connectors	116
4.3	HOW TO REPLACE THE FUSES	118
4.3.1	Fuse Locations	119
4.3.1.1	Power Supply	119
4.3.1.2	Servo Amplifier	119
4.3.1.3	Spindle Amplifier	120

III. MOTOR/DETECTOR/AMPLIFIER PREVENTIVE MAINTENANCE

1	MOTOR/DETECTOR/AMPLIFIER PREVENTIVE MAINTENANCE ...	124
1.1	LIST OF MANUALS RELATED TO MOTORS AND AMPLIFIERS	124
1.2	PREVENTIVE MAINTENANCE OF MOTORS AND DETECTORS	125
1.2.1	Warnings, Cautions, and Notes on Preventive Maintenance of Motors and Detectors	125
1.2.2	Preventive Maintenance of a Motor (Common to All Models)	127
1.2.2.1	Main inspection items	127
1.2.2.2	Periodic cleaning of a motor	130
1.2.2.3	Notes on motor cleaning	130
1.2.2.4	Notes on the cutting fluid (informational)	130
1.2.3	Routine Inspection of a Spindle Motor with a Through Hole	131

1.2.4	Preventive Maintenance of a Built-in Spindle Motor and Spindle Unit.....	131
1.2.4.1	Routine inspection of the FANUC-NSK spindle unit.....	132
1.2.4.2	Maintenance of the FANUC-NSK spindle unit.....	132
1.2.4.3	Test run of the FANUC-NSK spindle unit.....	133
1.2.4.4	Storage method of the FANUC-NSK spindle unit.....	133
1.2.5	Preventive Maintenance of a Linear Motor.....	133
1.2.5.1	Appearance inspection of the linear motor (magnet plate).....	133
1.2.6	Maintenance of a Detector.....	134
1.2.6.1	Alarms for built-in detectors (αi and βi Pulsecoders) and troubleshooting actions.....	134
1.2.6.2	Alarms for separate detectors and troubleshooting actions.....	135
1.2.6.3	Detailed troubleshooting methods.....	135
1.2.6.4	Maintenance of βi S motor Pulsecoders.....	137
1.3	PREVENTIVE MAINTENANCE OF SERVO AMPLIFIERS.....	138
1.3.1	Warnings, Cautions, and Notes on Operation of Servo Amplifiers.....	138
1.3.2	Preventive Maintenance of a Servo Amplifier.....	141
1.3.3	Maintenance of a Servo Amplifier.....	142
1.3.3.1	Display of the servo amplifier operation status.....	142
1.3.3.2	Replacement of a fan motor.....	144
1.4	REPLACING BATTERY FOR ABSOLUTE PULSECODERS.....	145
1.4.1	Overview.....	145
1.4.2	Replacing Batteries.....	146
1.4.3	Replacing the Batteries in a Separate Battery Case.....	146
1.4.4	Replacing the Battery Built into the Servo Amplifier.....	147

IV. MOTOR MAINTENANCE

1	SERVO MOTOR MAINTENANCE.....	151
1.1	SERVO MOTOR MAINTENANCE PARTS.....	151
1.1.1	Pulsecoder.....	151
1.1.2	Cooling Fan.....	152
1.2	REPLACING COOLING FANS.....	153
1.2.1	Replacing a Cooling Fan.....	153
1.2.1.1	αi S 50 with Fan, αi S 60 with Fan, and αi F 40 with Fan.....	153
1.2.1.2	αi S 100 with Fan and αi S 200 with Fan (including HV).....	156
1.2.1.3	αi S 300 and αi S 500 (including HV).....	156
1.2.1.4	αi S 1000HV.....	157
1.2.1.5	αi S 2000HV and αi S 3000HV.....	157
2	SPINDLE MOTOR MAINTENANCE PARTS.....	158
2.1	MAINTENANCE PARTS.....	158

APPENDIX

A	MEASURING SERVO MOTOR WAVEFORMS (TCMD, VCMD).....	165
----------	--	------------

ADDITIONAL INFORMATION

I. START-UP PROCEDURE

1 OVERVIEW

This part describes the units and components of the Servo Amplifier. It also explains the following information necessary to start up the Servo Amplifier:

- Configurations
- Start-up procedure
- Confirmation of the operation
- Periodic maintenance of servo amplifier

2 CONFIGURATIONS

2.1 CONFIGURATIONS

The FANUC servo amplifier αi series consists of the units and components listed below:

- | | |
|--|----------|
| (1) Power Supply (PS) | (basic) |
| (2) Servo Amplifier (SV) | (basic) |
| (3) Spindle Amplifier (SP) | (basic) |
| (4) AC reactor | (basic) |
| (5) Connectors (for connecting cables) | (basic) |
| (6) Fuses | (option) |
| (7) Power transformer | (option) |

Constituent (example)

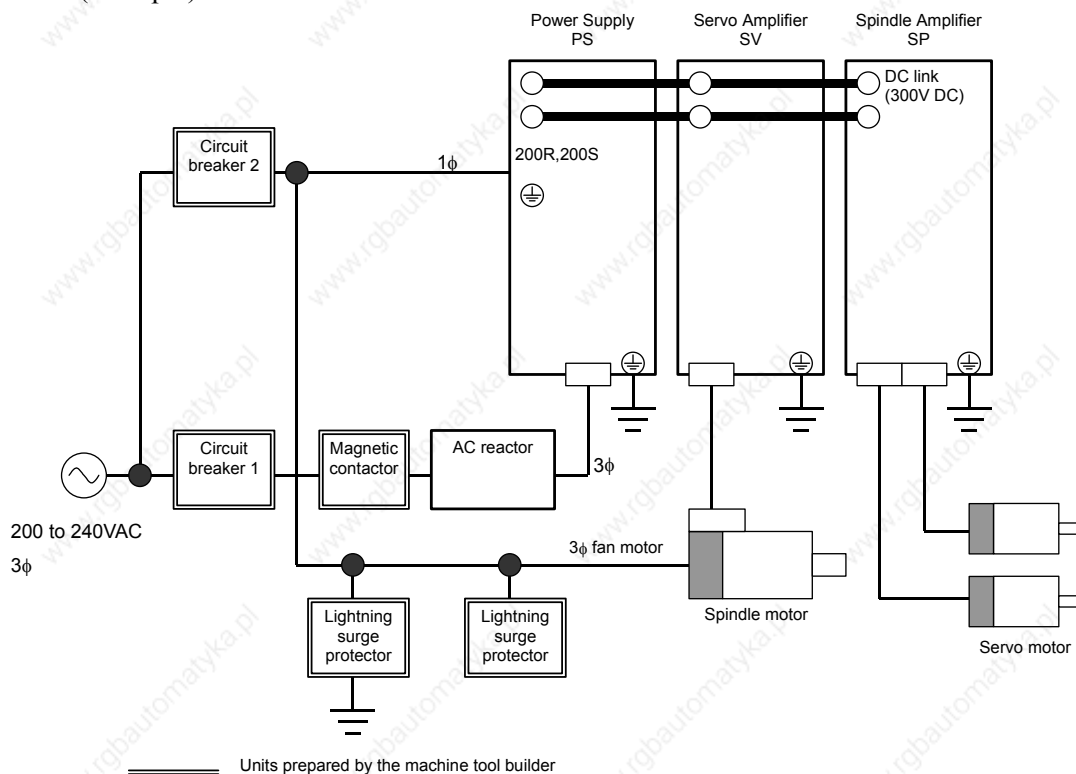

NOTE

- 1 See Chapter 4, "HOW TO SELECT THE MODULE" in the FANUC SERVO AMPLIFIER αi series (B-65282EN) for details of how to combine the Power Supply, Servo Amplifiers, and Spindle Amplifiers.
- 2 A magnetic contactor, AC reactor, and circuit breakers are always required.
- 3 To protect the unit from surge currents caused by lightning, connect surge absorbers between lines, and between the lines and ground, at the power inlet of the power magnetics cabinet. See Appendix A, "FITTING A LIGHTNING SURGE PROTECTION DEVICE" in the FANUC SERVO AMPLIFIER αi series (B-65282EN) for details.

2.2 MAJOR COMPONENTS

2.2.1 Power Supply

(1) Power Supply (PS, 200VAC-input, power regeneration type)

Model	Order specification	Unit specification	Wiring board specification	Printed circuit board specification
<i>ai</i> PS 5.5	A06B-6110-H006	A06B-6110-C006	A16B-2203-0640	A20B-2100-0391(*1)
<i>ai</i> PS 11	A06B-6110-H011	A06B-6110-C011	A16B-2203-0641	A20B-2100-0391(*1)
<i>ai</i> PS 15	A06B-6110-H015	A06B-6110-C015	A16B-2203-0642	A20B-2100-0391(*1)
<i>ai</i> PS 26	A06B-6110-H026	A06B-6110-C026	A16B-2203-0630	A20B-2100-0391(*2)
<i>ai</i> PS 30	A06B-6110-H030	A06B-6110-C030	A16B-2203-0631	A20B-2100-0391(*2)
<i>ai</i> PS 37	A06B-6110-H037	A06B-6110-C037	A16B-2203-0632	A20B-2100-0391(*2)
<i>ai</i> PS 55	A06B-6110-H055	A06B-6110-C055	A20B-1008-0081 (Driver PCB) A20B-2003-0420	A20B-2100-0391(*2)
<i>ai</i> PS 5.5	A06B-6140-H006	A06B-6140-C006	A16B-2203-0640	A20B-2100-0390
<i>ai</i> PS 11	A06B-6140-H011	A06B-6140-C011	A16B-2203-0641	A20B-2100-0390
<i>ai</i> PS 15	A06B-6140-H015	A06B-6140-C015	A16B-2203-0642	A20B-2100-0390
<i>ai</i> PS 26	A06B-6140-H026	A06B-6140-C026	A16B-2203-0630	A20B-2100-0390
<i>ai</i> PS 30	A06B-6140-H030	A06B-6140-C030	A16B-2203-0631	A20B-2100-0390
<i>ai</i> PS 37	A06B-6140-H037	A06B-6140-C037	A16B-2203-0632	A20B-2100-0390
<i>ai</i> PS 55	A06B-6140-H055	A06B-6140-C055	A20B-1008-0081 (Driver PCB) A20B-2003-0420	A20B-2100-0390

(*1) Old specification: A20B-2100-0760 (*2) Old specification: A20B-2100-0761

(2) Power Supply (PS, 400VAC-input, power regeneration type)

Model	Order specification	Unit specification	Wiring board specification	Printed circuit board specification
<i>ai</i> PS 11HV	A06B-6120-H011	A06B-6120-C011	A16B-2203-0647	A20B-2100-0391(*1)
<i>ai</i> PS 18HV	A06B-6120-H018	A06B-6120-C018	A16B-2203-0648	A20B-2100-0391(*1)
<i>ai</i> PS 30HV	A06B-6120-H030	A06B-6120-C030	A16B-2203-0636	A20B-2100-0391(*2)
<i>ai</i> PS 45HV	A06B-6120-H045	A06B-6120-C045	A16B-2203-0637	A20B-2100-0391(*2)
<i>ai</i> PS 75HV	A06B-6120-H75	A06B-6120-C75	A20B-1008-0086 (Driver PCB) A20B-2003-0420	A20B-2100-0391(*2)
<i>ai</i> PS 100HV	A06B-6120-H100	A06B-6120-C100	A20B-1008-0087 (Driver PCB) A20B-2003-0420	A20B-2100-0391(*2)
<i>ai</i> PS 11HV	A06B-6150-H011	A06B-6150-C011	A16B-2203-0647	A20B-2100-0390
<i>ai</i> PS 18HV	A06B-6150-H018	A06B-6150-C018	A16B-2203-0648	A20B-2100-0390
<i>ai</i> PS 30HV	A06B-6150-H030	A06B-6150-C030	A16B-2203-0636	A20B-2100-0390
<i>ai</i> PS 45HV	A06B-6150-H045	A06B-6150-C045	A16B-2203-0637	A20B-2100-0390
<i>ai</i> PS 60HV	A06B-6150-H060	A06B-6150-C060	A16B-2203-0638	A20B-2100-0390
<i>ai</i> PS 75HV	A06B-6150-H75	A06B-6150-C75	A20B-1008-0086 (Driver PCB) A20B-2003-0420	A20B-2100-0390
<i>ai</i> PS 100HV	A06B-6150-H100	A06B-6150-C100	A20B-1008-0087 (Driver PCB) A20B-2003-0420	A20B-2100-0390

(*1) Old specification: A20B-2100-0760 (*2) Old specification: A20B-2100-0761

(3) Power Supply (PSR, 200VAC-input, resistance regeneration type)

Model	Order specification	Unit specification	Printed circuit board specification
<i>ai</i> PSR 3	A06B-6115-H003	A06B-6115-C003	A16B-2203-0781
<i>ai</i> PSR 5.5	A06B-6115-H006	A06B-6115-C006	A16B-2203-0782

2.2.2 Servo Amplifier

(1) Single-axis Servo Amplifier (200VAC-input)

Model	Order specification	Unit specification	Wiring board specification	Printed circuit board specification
α i SV 20	A06B-6114-H103	A06B-6114-C103	A16B-2203-0691	A20B-2101-0040 (*1)
α i SV 40	A06B-6114-H104	A06B-6114-C104	A16B-2203-0660	
α i SV 80	A06B-6114-H105	A06B-6114-C105	A16B-2203-0661	
α i SV 160	A06B-6114-H106	A06B-6114-C106	A16B-2203-0662	
α i SV 360	A06B-6114-H109	A06B-6114-C109	A16B-2203-0625 or A16B-2203-0875	A20B-2101-0070 (*2)
α i SV 4	A06B-6117-H101	A06B-6117-C101	A16B-2203-0690	A20B-2101-0040
α i SV 20	A06B-6117-H103	A06B-6117-C103	A16B-2203-0691	
α i SV 40	A06B-6117-H104	A06B-6117-C104	A16B-2203-0660	
α i SV 80	A06B-6117-H105	A06B-6117-C105	A16B-2203-0661	
α i SV 160	A06B-6117-H106	A06B-6117-C106	A16B-2203-0662	A20B-2101-0070
α i SV 360	A06B-6117-H109	A06B-6117-C109	A16B-2203-0875	
α i SV 20L	A06B-6117-H153	A06B-6117-C153	A16B-2203-0666	A20B-2101-0040
α i SV 40L	A06B-6117-H154	A06B-6117-C154	A16B-2203-0660	
α i SV 80L	A06B-6117-H155	A06B-6117-C155	A16B-2203-0667	
α i SV 160L	A06B-6117-H156	A06B-6117-C156	A16B-2203-0663	

(*1) Old specification: A20B-2100-0740 (*2) Old specification: A20B-2100-0830

(2) Two-axis Servo Amplifier (200VAC-input)

Model	Order specification	Unit specification	Wiring board specification	Printed circuit board specification
α i SV 4/4	A06B-6114-H201	A06B-6114-C201	A16B-2203-0692	A20B-2101-0041 (*1)
α i SV 20/20	A06B-6114-H205	A06B-6114-C205	A16B-2203-0695	
α i SV 20/40	A06B-6114-H206	A06B-6114-C206	A16B-2203-0670	
α i SV 40/40	A06B-6114-H207	A06B-6114-C207	A16B-2203-0671	
α i SV 40/80	A06B-6114-H208	A06B-6114-C208	A16B-2203-0672	
α i SV 80/80	A06B-6114-H209	A06B-6114-C209	A16B-2203-0673	
α i SV 80/160	A06B-6114-H210	A06B-6114-C210	A16B-2203-0674	
α i SV 160/160	A06B-6114-H211	A06B-6114-C211	A16B-2203-0675	
α i SV 4/4	A06B-6117-H201	A06B-6117-C201	A16B-2203-0692	A20B-2101-0041
α i SV 4/20	A06B-6117-H203	A06B-6117-C203	A16B-2203-0694	
α i SV 20/20	A06B-6117-H205	A06B-6117-C205	A16B-2203-0695	
α i SV 20/40	A06B-6117-H206	A06B-6117-C206	A16B-2203-0670	
α i SV 40/40	A06B-6117-H207	A06B-6117-C207	A16B-2203-0671	
α i SV 40/80	A06B-6117-H208	A06B-6117-C208	A16B-2203-0672	
α i SV 80/80	A06B-6117-H209	A06B-6117-C209	A16B-2203-0673	
α i SV 80/160	A06B-6117-H210	A06B-6117-C210	A16B-2203-0674	
α i SV 160/160	A06B-6117-H211	A06B-6117-C211	A16B-2203-0675	
α i SV 20/20L	A06B-6117-H255	A06B-6117-C255	A16B-2203-0677	
α i SV 20/40L	A06B-6117-H256	A06B-6117-C256	A16B-2203-0678	
α i SV 40/40L	A06B-6117-H257	A06B-6117-C257	A16B-2203-0679	
α i SV 40/80L	A06B-6117-H258	A06B-6117-C258	A16B-2203-0672	
α i SV 80/80L	A06B-6117-H259	A06B-6117-C259	A16B-2203-0673	

(*1) Old specification: A20B-2100-0741

(3) Three-axis Servo Amplifier (200VAC-input)

Model	Order specification	Unit specification	Wiring board specification	Printed circuit board specification
<i>ai</i> SV 4/4/4	A06B-6114-H301	A06B-6114-C301	A16B-2203-0696	A20B-2101-0042 (*1)
<i>ai</i> SV 20/20/20	A06B-6114-H303	A06B-6114-C303	A16B-2203-0698	
<i>ai</i> SV 20/20/40	A06B-6114-H304	A06B-6114-C304	A16B-2203-0680	
<i>ai</i> SV 4/4/4	A06B-6117-H301	A06B-6117-C301	A16B-2203-0696	A20B-2101-0042
<i>ai</i> SV 20/20/20	A06B-6117-H303	A06B-6117-C303	A16B-2203-0698	
<i>ai</i> SV 20/20/40	A06B-6117-H304	A06B-6117-C304	A16B-2203-0680	

(*1) Old specification: A20B-2100-0742

(4) Single-axis Servo Amplifier (400VAC-input)

Model	Order specification	Unit specification	Wiring board specification	Printed circuit board specification
<i>ai</i> SV 10HV	A06B-6124-H102	A06B-6124-C102	A16B-2203-0803	A20B-2101-0040(*1)
<i>ai</i> SV 20HV	A06B-6124-H103	A06B-6124-C103	A16B-2203-0800	
<i>ai</i> SV 40HV	A06B-6124-H104	A06B-6124-C104	A16B-2203-0801	
<i>ai</i> SV 80HV	A06B-6124-H105	A06B-6124-C105	A16B-2203-0802	
<i>ai</i> SV 180HV	A06B-6124-H106	A06B-6124-C106	A16B-2203-0629 or A16B-2203-0876	A20B-2101-0071 (*2)
<i>ai</i> SV 360HV	A06B-6124-H109	A06B-6124-C109	A20B-1008-0099 (Driver PCB) A20B-2003-0420	A20B-2101-0070 (*3)
<i>ai</i> SV 10HV	A06B-6127-H102	A06B-6127-C102	A16B-2203-0803	
<i>ai</i> SV 20HV	A06B-6127-H103	A06B-6127-C103	A16B-2203-0800	
<i>ai</i> SV 40HV	A06B-6127-H104	A06B-6127-C104	A16B-2203-0801	A20B-2101-0040
<i>ai</i> SV 80HV	A06B-6127-H105	A06B-6127-C105	A16B-2203-0802	
<i>ai</i> SV 180HV	A06B-6127-H106	A06B-6127-C106	A16B-2203-0876	A20B-2101-0071
<i>ai</i> SV 360HV	A06B-6127-H109	A06B-6127-C109	A20B-1008-0098 (Driver PCB) A20B-2003-0770	A20B-2101-0070
<i>ai</i> SV 540HV	A06B-6127-H110	A06B-6127-C110	A20B-1008-0098 (Driver PCB) A20B-2003-0770	A20B-2101-0072
<i>ai</i> SV 10HVL	A06B-6127-H152	A06B-6127-C152	A16B-2203-0804	A20B-2101-0040
<i>ai</i> SV 20HVL	A06B-6127-H153	A06B-6127-C153	A16B-2203-0805	
<i>ai</i> SV 40HVL	A06B-6127-H154	A06B-6127-C154	A16B-2203-0806	
<i>ai</i> SV 80HVL	A06B-6127-H155	A06B-6127-C155	A16B-2203-0802	

(*1) Old specification: A20B-2100-0740 (*2) Old specification: A20B-2100-0831

(*3) Old specification: A20B-2100-0830

(5) Two-axis Servo Amplifier (400VAC-input)

Model	Order specification	Unit specification	Wiring board specification	Printed circuit board specification
<i>ai</i> SV 10/10HV	A06B-6124-H202	A06B-6124-C202	A16B-2203-0815	A20B-2101-0041 (*1)
<i>ai</i> SV 20/20HV	A06B-6124-H205	A06B-6124-C205	A16B-2203-0810	
<i>ai</i> SV 20/40HV	A06B-6124-H206	A06B-6124-C206	A16B-2203-0811	
<i>ai</i> SV 40/40HV	A06B-6124-H207	A06B-6124-C207	A16B-2203-0812	
<i>ai</i> SV 40/80HV	A06B-6124-H208	A06B-6124-C208	A16B-2203-0813	
<i>ai</i> SV 80/80HV	A06B-6124-H209	A06B-6124-C209	A16B-2203-0814	

Model	Order specification	Unit specification	Wiring board specification	Printed circuit board specification
<i>ai</i> SV 10/10HV	A06B-6127-H202	A06B-6127-C202	A16B-2203-0815	A20B-2101-0041
<i>ai</i> SV 20/20HV	A06B-6127-H205	A06B-6127-C205	A16B-2203-0810	
<i>ai</i> SV 20/40HV	A06B-6127-H206	A06B-6127-C206	A16B-2203-0811	
<i>ai</i> SV 40/40HV	A06B-6127-H207	A06B-6127-C207	A16B-2203-0812	
<i>ai</i> SV 40/80HV	A06B-6127-H208	A06B-6127-C208	A16B-2203-0813	
<i>ai</i> SV 80/80HV	A06B-6127-H209	A06B-6127-C209	A16B-2203-0814	
<i>ai</i> SV 10/10HVL	A06B-6127-H252	A06B-6127-C252	A16B-2203-0816	
<i>ai</i> SV 20/20HVL	A06B-6127-H255	A06B-6127-C255	A16B-2203-0817	
<i>ai</i> SV 20/40HVL	A06B-6127-H256	A06B-6127-C256	A16B-2203-0811	
<i>ai</i> SV 40/40HVL	A06B-6127-H257	A06B-6127-C257	A16B-2203-0812	

(*1) Old specification: A20B-2100-0741

2.2.3 Spindle Amplifier

The order specification varies according to the sensor (function) used.

(1) *ai* series Spindle Amplifier (200VAC-input)

TYPE A

Model	Order specification	Unit specification	Wiring board specification	Printed circuit board specification
<i>ai</i> SP 2.2	A06B-6111-H002	A06B-6111-C002	A16B-2203-0650	A20B-2101-0354
<i>ai</i> SP 5.5	A06B-6111-H006	A06B-6111-C006	A16B-2203-0651	A20B-2101-0354
<i>ai</i> SP 11	A06B-6111-H011	A06B-6111-C011	A16B-2203-0652	A20B-2101-0354
<i>ai</i> SP 15	A06B-6111-H015	A06B-6111-C015	A16B-2203-0653	A20B-2101-0354
<i>ai</i> SP 22	A06B-6111-H022	A06B-6111-C022	A16B-2203-0620	A20B-2101-0354
<i>ai</i> SP 26	A06B-6111-H026	A06B-6111-C026	A16B-2203-0621	A20B-2101-0354
<i>ai</i> SP 30	A06B-6111-H030	A06B-6111-C030	A16B-2203-0622	A20B-2101-0354
<i>ai</i> SP 37	A06B-6111-H037	A06B-6111-C037	A16B-2203-0623	A20B-2101-0354
<i>ai</i> SP 45	A06B-6111-H045	A06B-6111-C045	A20B-1008-0090 (Driver PCB) A20B-2003-0420	A20B-2101-0354
<i>ai</i> SP 55	A06B-6111-H055	A06B-6111-C055	A20B-1008-0091 (Driver PCB) A20B-2003-0420	A20B-2101-0354
<i>ai</i> SP 2.2	A06B-6141-H002	A06B-6141-C002	A16B-2203-0656	A20B-2101-0350
<i>ai</i> SP 5.5	A06B-6141-H006	A06B-6141-C006	A16B-2203-0657	A20B-2101-0350
<i>ai</i> SP 11	A06B-6141-H011	A06B-6141-C011	A16B-2203-0658	A20B-2101-0350
<i>ai</i> SP 15	A06B-6141-H015	A06B-6141-C015	A16B-2203-0659	A20B-2101-0350
<i>ai</i> SP 22	A06B-6141-H022	A06B-6141-C022	A16B-2203-0870	A20B-2101-0350
<i>ai</i> SP 26	A06B-6141-H026	A06B-6141-C026	A16B-2203-0871	A20B-2101-0350
<i>ai</i> SP 30	A06B-6141-H030	A06B-6141-C030	A16B-2203-0872	A20B-2101-0350
<i>ai</i> SP 37	A06B-6141-H037	A06B-6141-C037	A16B-2203-0873	A20B-2101-0350
<i>ai</i> SP 45	A06B-6141-H045	A06B-6141-C045	A20B-1008-0092 (Driver PCB) A20B-2003-0770	A20B-2101-0350
<i>ai</i> SP 55	A06B-6141-H055	A06B-6141-C055	A20B-1008-0093 (Driver PCB) A20B-2003-0770	A20B-2101-0350

TYPE B

Model	Order specification	Unit specification	Wiring board specification	Printed circuit board specification
<i>ai</i> SP 2.2	A06B-6112-H002	A06B-6111-C002	A16B-2203-0650	A20B-2101-0355
<i>ai</i> SP 5.5	A06B-6112-H006	A06B-6111-C006	A16B-2203-0651	A20B-2101-0355
<i>ai</i> SP 11	A06B-6112-H011	A06B-6111-C011	A16B-2203-0652	A20B-2101-0355
<i>ai</i> SP 15	A06B-6112-H015	A06B-6111-C015	A16B-2203-0653	A20B-2101-0355

Model	Order specification	Unit specification	Wiring board specification	Printed circuit board specification
αi SP 22	A06B-6112-H022	A06B-6111-C022	A16B-2203-0620	A20B-2101-0355
αi SP 26	A06B-6112-H026	A06B-6111-C026	A16B-2203-0621	A20B-2101-0355
αi SP 30	A06B-6112-H030	A06B-6111-C030	A16B-2203-0622	A20B-2101-0355
αi SP 37	A06B-6112-H037	A06B-6111-C037	A16B-2203-0623	A20B-2101-0355
αi SP 45	A06B-6112-H045	A06B-6111-C045	A20B-1008-0090 (Driver PCB) A20B-2003-0420	A20B-2101-0355
αi SP 55	A06B-6112-H055	A06B-6111-C055	A20B-1008-0091 (Driver PCB) A20B-2003-0420	A20B-2101-0355
αi SP 2.2	A06B-6142-H002	A06B-6141-C002	A16B-2203-0656	A20B-2101-0351
αi SP 5.5	A06B-6142-H006	A06B-6141-C006	A16B-2203-0657	A20B-2101-0351
αi SP 11	A06B-6142-H011	A06B-6141-C011	A16B-2203-0658	A20B-2101-0351
αi SP 15	A06B-6142-H015	A06B-6141-C015	A16B-2203-0659	A20B-2101-0351
αi SP 22	A06B-6142-H022	A06B-6141-C022	A16B-2203-0870	A20B-2101-0351
αi SP 26	A06B-6142-H026	A06B-6141-C026	A16B-2203-0871	A20B-2101-0351
αi SP 30	A06B-6142-H030	A06B-6141-C030	A16B-2203-0872	A20B-2101-0351
αi SP 37	A06B-6142-H037	A06B-6141-C037	A16B-2203-0873	A20B-2101-0351
αi SP 45	A06B-6142-H045	A06B-6141-C045	A20B-1008-0092 (Driver PCB) A20B-2003-0770	A20B-2101-0351
αi SP 55	A06B-6142-H055	A06B-6141-C055	A20B-1008-0093 (Driver PCB) A20B-2003-0770	A20B-2101-0351

(2) αi series Spindle Amplifier (400VAC-input)**TYPE A**

Model	Order specification	Unit specification	Wiring board specification	Printed circuit board specification
αi SP 5.5HV	A06B-6121-H006	A06B-6121-C006	A16B-2203-0820	A20B-2101-0354
αi SP 11HV	A06B-6121-H011	A06B-6121-C011	A16B-2203-0821	A20B-2101-0354
αi SP 15HV	A06B-6121-H015	A06B-6121-C015	A16B-2203-0822	A20B-2101-0354
αi SP 30HV	A06B-6121-H030	A06B-6121-C030	A16B-2203-0627	A20B-2101-0354
αi SP 45HV	A06B-6121-H045	A06B-6121-C045	A16B-2203-0628	A20B-2101-0354
αi SP 75HV	A06B-6121-H075	A06B-6121-C075	A20B-1008-0096 (Driver PCB) A20B-2003-0420	A20B-2101-0354
αi SP 100HV	A06B-6121-H100	A06B-6121-C100	A20B-1008-0097 (Driver PCB) A20B-2003-0420	A20B-2101-0354
αi SP 5.5HV	A06B-6151-H006	A06B-6151-C006	A16B-2203-0826	A20B-2101-0350
αi SP 11HV	A06B-6151-H011	A06B-6151-C011	A16B-2203-0827	A20B-2101-0350
αi SP 15HV	A06B-6151-H015	A06B-6151-C015	A16B-2203-0828	A20B-2101-0350
αi SP 30HV	A06B-6151-H030	A06B-6151-C030	A16B-2203-0877	A20B-2101-0350
αi SP 45HV	A06B-6151-H045	A06B-6151-C045	A16B-2203-0878	A20B-2101-0350
αi SP 75HV	A06B-6151-H075	A06B-6151-C075	A20B-1008-0094 (Driver PCB) A20B-2003-0770	A20B-2101-0350
αi SP 100HV	A06B-6151-H100	A06B-6151-C100	A20B-1008-0095 (Driver PCB) A20B-2003-0770	A20B-2101-0350

TYPE B

Model	Order specification	Unit specification	Wiring board specification	Printed circuit board specification
αi SP 5.5HV	A06B-6122-H006	A06B-6121-C006	A16B-2203-0820	A20B-2101-0355
αi SP 11HV	A06B-6122-H011	A06B-6121-C011	A16B-2203-0821	A20B-2101-0355
αi SP 15HV	A06B-6122-H015	A06B-6121-C015	A16B-2203-0822	A20B-2101-0355
αi SP 30HV	A06B-6122-H030	A06B-6121-C030	A16B-2203-0627	A20B-2101-0355
αi SP 45HV	A06B-6122-H045	A06B-6121-C045	A16B-2203-0628	A20B-2101-0355

Model	Order specification	Unit specification	Wiring board specification	Printed circuit board specification
<i>αi</i> SP 75HV	A06B-6122-H075	A06B-6121-C075	A20B-1008-0096 (Driver PCB) A20B-2003-0420	A20B-2101-0355
<i>αi</i> SP 100HV	A06B-6122-H100	A06B-6121-C100	A20B-1008-0097 (Driver PCB) A20B-2003-0420	A20B-2101-0355
<i>αi</i> SP 5.5HV	A06B-6152-H006	A06B-6151-C006	A16B-2203-0826	A20B-2101-0351
<i>αi</i> SP 11HV	A06B-6152-H011	A06B-6151-C011	A16B-2203-0827	A20B-2101-0351
<i>αi</i> SP 15HV	A06B-6152-H015	A06B-6151-C015	A16B-2203-0828	A20B-2101-0351
<i>αi</i> SP 30HV	A06B-6152-H030	A06B-6151-C030	A16B-2203-0877	A20B-2101-0351
<i>αi</i> SP 45HV	A06B-6152-H045	A06B-6151-C045	A16B-2203-0878	A20B-2101-0351
<i>αi</i> SP 75HV	A06B-6152-H075	A06B-6151-C075	A20B-1008-0094 (Driver PCB) A20B-2003-0770	A20B-2101-0351
<i>αi</i> SP 100HV	A06B-6152-H100	A06B-6151-C100	A20B-1008-0095 (Driver PCB) A20B-2003-0770	A20B-2101-0351

(3) *αCi* series Spindle Amplifiers (200VAC-input)

Model	Order specification	Unit specification	Wiring board specification	Printed circuit board specification
SPMC-2.2 <i>i</i>	A06B-6116-H002	A06B-6111-C002	A16B-2203-0650	A20B-2100-0802
SPMC-5.5 <i>i</i>	A06B-6116-H006	A06B-6111-C006	A16B-2203-0651	A20B-2100-0802
SPMC-11 <i>i</i>	A06B-6116-H011	A06B-6111-C011	A16B-2203-0652	A20B-2100-0802
SPMC-15 <i>i</i>	A06B-6116-H015	A06B-6111-C015	A16B-2203-0653	A20B-2100-0802
SPMC-22 <i>i</i>	A06B-6116-H022	A06B-6111-C022	A16B-2203-0620	A20B-2100-0802

3 START-UP PROCEDURE

3.1 START-UP PROCEDURE (OVERVIEW)

Make sure that the specifications of the CNC, servo motors, servo amplifiers, and other units you received are exactly what you ordered, and these units are connected correctly. Then, turn on the power.

- (1) Before turning on the circuit breaker, check the power supply voltage connected.
→ See Section 3.2.
- (2) Some types of Power Supply, Servo Amplifier, and Spindle Amplifier require settings before the system can be used. So check whether you must make settings.
→ See Section 3.3.
- (3) Turn on the power, and set initial parameters on the CNC.

For the initialization of servo parameters, refer to the following manual:
FANUC AC SERVO MOTOR αi series Parameter Manual (B-65270EN)

For the initialization of spindle parameters, refer to the following manual:
FANUC AD SPINDLE MOTOR αi series Parameter Manual (B-65280EN)

- (4) For start-up adjustment and troubleshooting, see Chapter 4.
 - Method of using optional wiring boards for adjustment of the Power Supply, Servo Amplifier, and Spindle Amplifier
 - Spindle sensor adjustment values

3.2 CONNECTING THE POWER

3.2.1 Checking the Voltage and Capacity of the Power

Before connecting the power, you should measure the AC power voltage.

Table 3.2.1 (c) and (b) list the input power specification for the Power Supply. Use a power source with sufficient capacity so that the system will not malfunction due to a voltage drop even at a time of peak load.

Table 3.2.1 (c) AC power voltage specifications (200-V input type)

Model	αiPS 5.5	αiPS 11	αiPS 15	αiPS 26	$\alpha iiPS$ 30	αiPS 37	αiPS 55	
Nominal voltage rating	200 to 240 VAC -15%,+10%							
Power source frequency	50/60 Hz ± 1 Hz							
Power source capacity (for the main circuit) [kVA]	9	17	22	37	44	53	79	
Power source capacity (for the control circuit) [kVA]	0.7							

Table 3.2.1 (d) AC power voltage specifications (200-V input type)

Model	αi PS 11HV	αi PS 18HV	αi PS 30HV	αi PS 45HV	αi PS 60HV	αi PS 75HV		
Nominal voltage rating (for the main circuit)	400 to 480VAC -15%,+10%							
Nominal voltage rating (for the control circuit)	200 to 240VAC -15%,+10%							
Power source frequency	50/60Hz \pm 1Hz							
Power source capacity (for the main circuit) [kVA]	17	26	44	64	86	143		
Power source capacity (for the control circuit) [kVA]	0.7							

3.2.2 Connecting a Protective Ground

Refer to the items in Chapter 5, "Installation," in "FANUC SERVO AMPLIFIER αi series Descriptions (B-65282EN)", and check that the protective ground line is connected correctly.

3.2.3 Selecting the Ground Fault Interrupter That Matches the Leakage Current

Refer to the items in Chapter 5, "Installation," in "FANUC SERVO AMPLIFIER αi series Descriptions (B-65282EN)", and check that a correct ground fault interrupter is selected.

3.2.4 Checking the Phase Sequence of the Fan Motor Power Supply

When connecting a power supply to a three-phase fan motor, check that the phase sequence is correct. If the phase sequence is incorrect, the fan motor rotates in the reverse direction, which may decrease cooling efficiency or stop the fan motor due to overheating.

3.3 INITIALIZING PARAMETERS

- (1) Servo Amplifier
For the initialization of servo parameters, refer to the following manual:
FANUC AC SERVO MOTOR αi series Parameter Manual (B-65270EN)
- (2) Spindle Amplifier
For the initialization of spindle parameters, refer to the following manual:
FANUC AC SPINDLE MOTOR αi series Parameter Manual (B-65280EN)

4 CONFIRMATION OF THE OPERATION





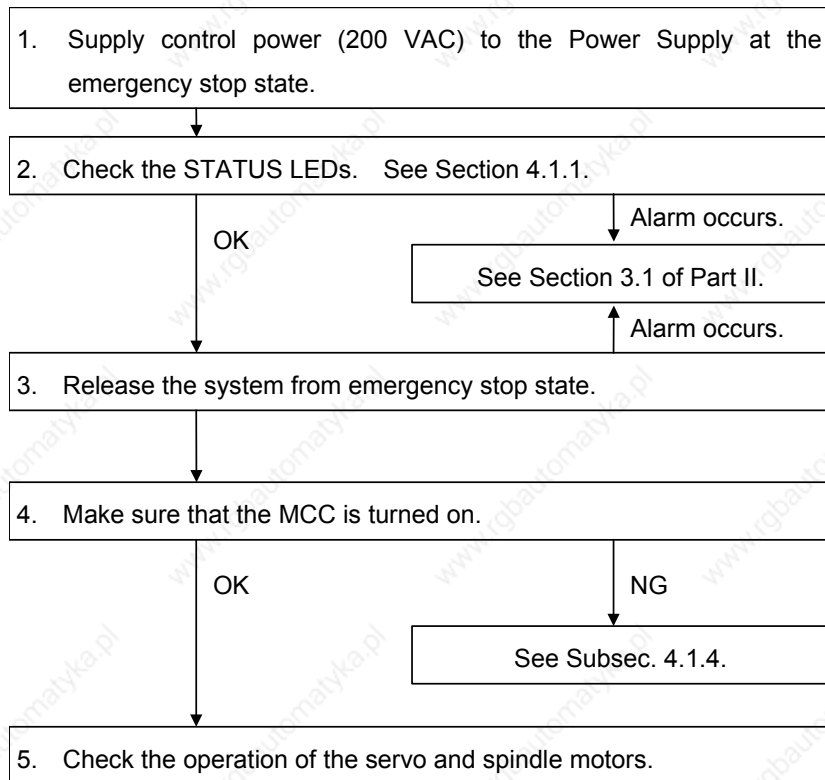

4.1 POWER SUPPLY

Check each item according to the procedure described below.

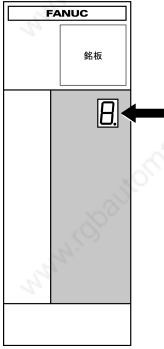

4.1.1 Checking the Status LEDs (Power Supply)

The STATUS display (a 7-segment LED) on the front of the Power Supply indicates the operation status.

STATUS LED position	STATUS display	Description
		The STATUS LED is off. Control power has not been supplied, cable is faulty, or control power circuit is defective.
		Not ready status The main circuit is not supplied with power (magnetic contactor is off); emergency stop state. When blinking: Power is off.
		Ready status The main circuit is supplied with power (magnetic contactor is on); the power supply is ready for operation. When blinking: Power is off.
		Warning state (The dot at the lower right lights.) The power supply has failed; an alarm has occurred after a certain time of operation. The warning type is indicated by the character displayed.
		Alarm status The alarm type is indicated by the character displayed.

4.1.2 Check Terminal on the Printed-circuit Board

To the Power Supply connector JX1B, the input current check signal is output. To observe the output, use the servo check pin board A06B-6071-K290 (see below).

Table 4.1.2(a) Check pins

Check pin	Description	Location of observation	Remark
IR	L1 phase (R-phase) current	JX1B-pin1	The "+" sign with respect to the input of the amplifier. If the L1 or L2 phase current exceeds the overcurrent alarm level, an alarm condition (with alarm code 01) occurs in the Power Supply.
IS	L2 phase (S-phase) current	JX1B-pin2	
0V	Reference point of observation	JX1B-pin12,14,16	

Table 4.1.2 (b) IR and IS current conversion value

Model	Current conversion
α iPS 5.5	133A/1V(2.5 V at the center)
α iPS 11	133A/1V(2.5 V at the center)
α iPS 15	200A/1V(2.5 V at the center)
α iPS 26	266A/1V(2.5 V at the center)
α iPS 30	333A/1V(2.5 V at the center)
α iPS 37	400A/1V(2.5 V at the center)
α iPS 55	666A/1V(2.5 V at the center)
α iPS 11HV	100A/1V(2.5 V at the center)
α iPS 18HV	133A/1V(2.5 V at the center)
α iPS 30HV	200A/1V(2.5 V at the center)
α iPS 45HV	266A/1V(2.5 V at the center)
α iPS 60HV	333A/1V(2.5 V at the center)
α iPS 75HV	400A/1V(2.5 V at the center)
α iPS 100HV	466A/1V(2.5 V at the center)

About the servo check pin board A06B-6071-K290

The servo check pin board can be used to observe signals in the Power Supply.

(1) Specification

Order specification	Description	Remark
A06B-6071-K290	Printed-circuit board A20B-1005-0340	Printed-circuit board with check pins mounted
	Cable A660-2042-T031#L200R0	20-conductor one-to-one cable Length : 200mm

Printed-circuit board : A20B-1005-0340

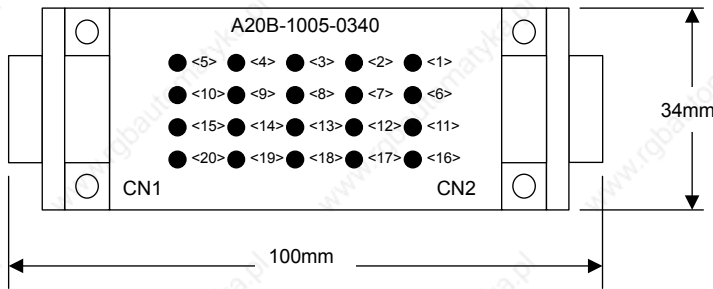

Cable : A660-2042-T031#L200R0



One-to-one wiring is provided between CN1 and CN2.
The connector pin numbers correspond to the check pin numbers.

(2) Connection

Connect the cable to the connector JX1B at the front of the Power Supply.

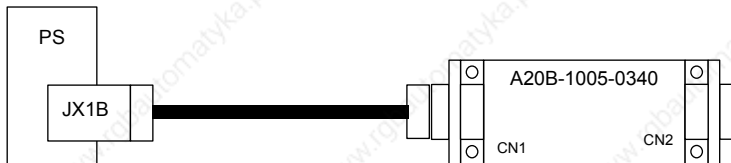

4.1.3 The PIL LED (Power ON Indicator) Is Off.

Table 4.1.3 Check method and action

No.	Cause of trouble	Check method	Action
1	AC power for the control circuit not supplied	Check that power is connected to connector CX1A.	
2	Blown fuse in the control circuit	Check whether F1 or F2 has blown. See Chapter 4 of Part II.	(1) If the AC power input for control is connected to connector CX1B by mistake, F2 (FU2) may blow. Connect the AC power input to CX1A. (2) Replace the fuse. If the fuse blows again after the replacement, replace the printed circuit board.
3	Incorrect wiring	Check whether the 24-V power output is short-circuited and whether a load exceeding the rating is connected.	
4	Faulty power supply circuit on the printed circuit board	The power-on LED indicator PIL operates on the +5-V power supply. Check the control power voltage.	Replace the printed circuit board, driver board, or power distribution board.

4.1.4 Checking Method when Magnetic Contactor Is not Switched On

- (1) The system is still in an emergency stop status.
→ Check the connection.
- (2) There is a connector problem. ("-") blinks for about 2 seconds or "P" is displayed after an emergency stop status is released.)
 - (a) Check that the connectors are attached to correct locations.
→ Ensure that the connectors are attached to the location CXA2A on the Power Supply and the location CXA2B on the Spindle Amplifier/Servo Amplifier.

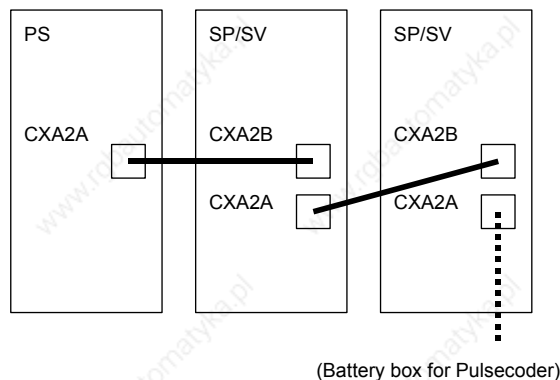

- (b) The interface cable between CXA2B of the Power Supply and CXA2A of the Servo Amplifier or Spindle Amplifier is defective.
→ Check whether the interface cable is faulty.
- (3) The power for driving the magnetic contactor is not supplied. ("-") blinks for about 2 seconds after an emergency stop status is released.
→ Check the voltage across the both ends of the coil of the magnetic contactor.

- (4) The relay for driving the magnetic contactor is defective. ("-") blinks for about 2 seconds after an emergency stop status is released.)
→ Check that a circuit between pins CX3-1 and CX3-3 of connector is closed and opened.

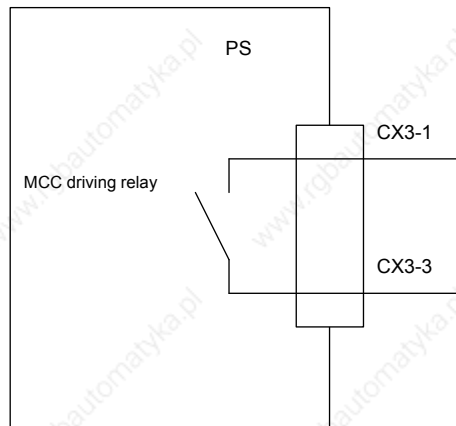

- (5) The Power Supply, Servo Amplifier, or Spindle Amplifier is defective.
→ Replace the defective module.





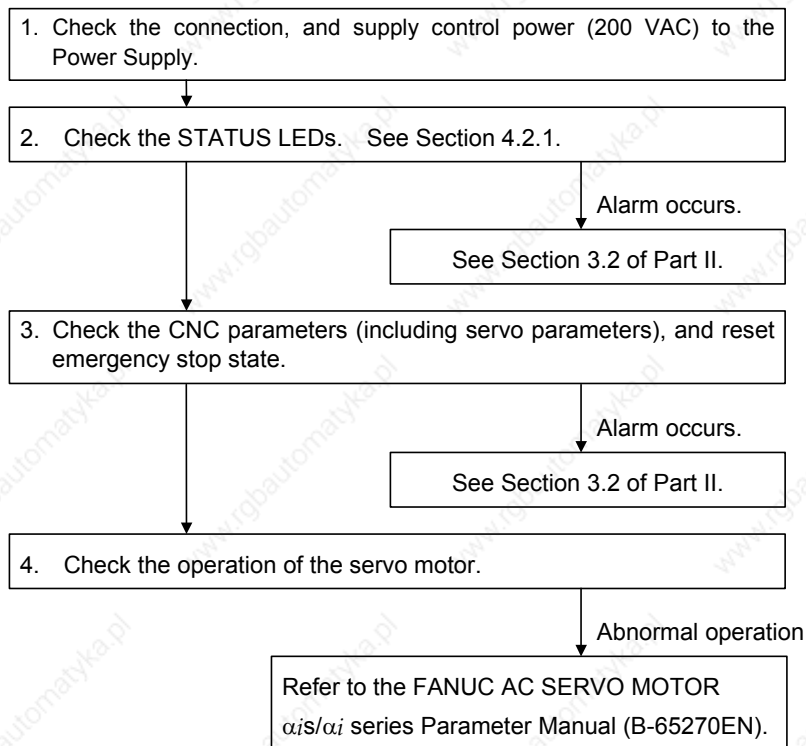

4.2 SERVO AMPLIFIER

Check each item according to the procedure described below.

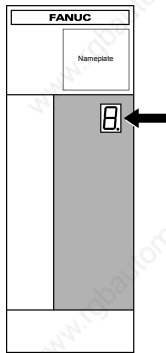

4.2.1 Checking the STATUS Display (Servo Amplifier)

The STATUS display (a 7-segment LED) on the front of the Servo Amplifier indicates the operation status.

STATUS LED position	STATUS display	Description
		The STATUS LED is off. Control power has not been supplied, cable is faulty, or control power circuit is defective.
		The control power is short-circuited (- blinks). Cable failure
		Waiting for the READY signal from the CNC.
		Ready status The servo motor is excited.
		Alarm status The alarm type is indicated by the character displayed.

4.2.2 VRDY-OFF Alarm Indicated on the CNC Screen

When the VRDY-OFF alarm is indicated on the CNC, check the items listed below. In addition, VRDY-OFF can occur also for reasons other than listed below. If the following items turn out to have not caused VRDY-OFF, check diagnosis information No. 358 (V ready-off information) on the diagnosis screen and report it to FANUC.

- (1) Communication interface between amplifiers
Is the cable for the communication interface (CXA2A/B) between the amplifiers connected correctly?
- (2) Emergency stop signal (ESP)
Has the emergency stop signal (connector: CX4) applied to the Power Supply been released?
Alternatively, is the signal connected correctly?
- (3) MCON signal
Hasn't setting up the axis detach function disabled the transmission of the ready command signal MCON from the CNC to the Servo Amplifier?
- (4) Servo Amplifier control printed-circuit board
The Servo Amplifier control printed-circuit board may be poorly installed or faulty. Be sure to push the faceplate as far as it will go. If the problem persists, replace the control printed-circuit board.

On the Series 30i/31i/32i/16i/18i/21i/0i/PMi, checking diagnosis information (DGN) No. 358 makes it possible to analyze the cause of the VRDY-OFF alarm.

Diagnosis

Convert the displayed value to binary form, and check bits 5 to 14 of the resulting binary number.

When the servo amplifier starts working, these bits become 1 sequentially, starting at bit 5. When the servo amplifier has started normally, all of bits 5 to 14 become 1.

Check bits 5 to 14 sequentially, starting at the lowest-order bit. The first lowest bit that is not 0 corresponds to the processing that caused the V ready-off alarm.

#15	#14	#13	#12	#11	#10	#9	#8
	SRDY	DRDY	INTL	RLY	CRDY	MCOFF	MCONA
#7	#6	#5	#4	#3	#2	#1	#0
MCONS	*ESP	HRDY					

- #06(*ESP) : Emergency stop signal
 #07,#08,#09 : MCON signal (CNC → Servo Amplifier → Power Supply)
 #10(CRDY) : Power Supply preparation completed signal
 #11(RLY) : Relay signal (DB relay energized)
 #12(INTL) : Interlock signal (DB relay de-energized)
 #13(DRDY) : Amplifier preparation completed signal

The following table lists diagnosis information No. 358 values and main causes of problems. Do not insert or remove any connector when the power is on.

Diagnosis No. 358 value	Problem	Check item
417	The system is still in an emergency stop state.	(1) Check whether the emergency stop signal input to CX4 on the Power Supply has been released. (2) Check whether there is no problem with the connection or cable for the communication interface between the amplifiers. (3) Replace the Servo Amplifier.
993	The Power Supply preparation completed signal (CRDY) is not output.	(1) Check whether there is no problem with the connection or cable for the communication interface (CXA2A/B) between the amplifiers. (2) Check whether the input power is supplied. (3) Check whether the power is supplied to the operation coil of the magnetic contactor. Check whether there is no problem with the connection of CX3 on the Power Supply. (4) Replace the Servo Amplifier.
4065	The interlock signal is not input.	When a dynamic brake module (DBM) is used, check (1) to (4). When no DBM is used, replace the Servo Amplifier. (1) Check the connection between the Servo Amplifier and DBM. (2) Check the connection between the Power Supply and Servo Amplifier (CX1A/B). (3) Check whether the fuse (FU2) on the control printed-circuit board on the Power Supply has blown. (4) Replace the Servo Amplifier.
225	—	Replace the Servo Amplifier.
481	—	Replace the Servo Amplifier.
2017	—	Replace the Servo Amplifier.
8161	—	Replace the Servo Amplifier.
97	—	Check whether the axis detach function is set.

4.2.3 Method for Observing Motor Current

This subsection explains how to observe the current that flows through the servo motor.

(1) Method of using the SERVO GUIDE

Refer to online help for explanations about how to connect to and use the servo adjustment tool, SERVO GUIDE.

- Supported CNC systems

Series 30*i*/ 31*i*/32*i* -MODEL A (applied to 3.00 and subsequent editions of the SERVO GUIDE)

Series 16*i*/18*i*/21*i* -MODEL B

Series 0*i*-MODEL B, C, D (Series 0*i*-MODEL D applied to 6.00 and subsequent editions of the SERVO GUIDE)

Power Mate *i* -MODEL D,H

Servo software supporting the α *i* series

90Dx/A(01) and subsequent editions, 90Ex/A(01) and subsequent editions, 90C5/A(01) and subsequent editions, 90B1/A(01) and subsequent editions, 90B5/A(01) and subsequent editions, 90B6/A(01) and subsequent editions, 90B0/L(12) and subsequent editions, 9096/C(03) and subsequent editions

- Setting

Select an axis to be subjected to measurement in graph window channel setting. Also select IR and IS under Kind. Under Coef (conversion coefficient), set the maximum allowable current (Ap) for the amplifier in use.

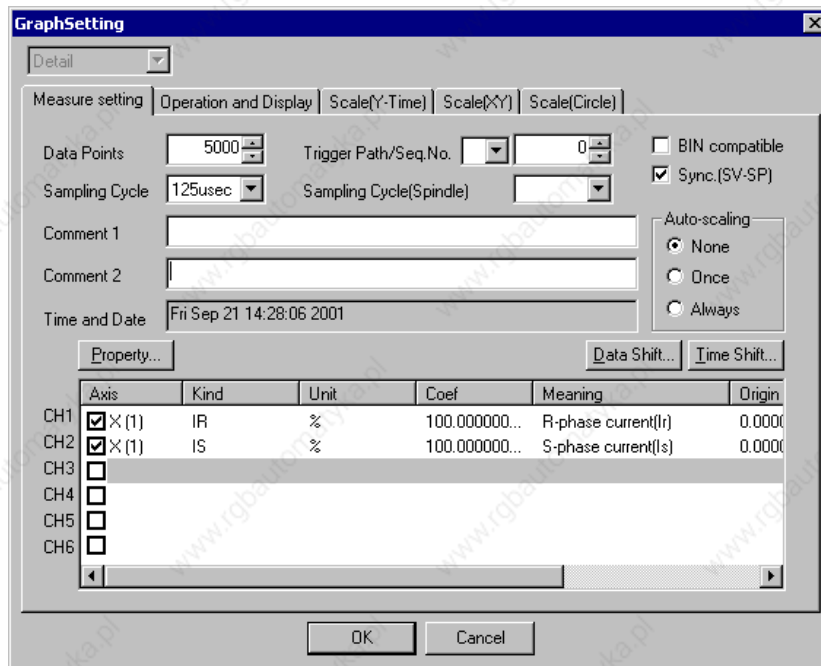

NOTE

- 1 Servo software series 90B0 supports setting of a motor current sampling period of up to 125 μ s.
- 2 Servo software series 9096 supports setting of a motor current sampling period of 1 ms only.

- Display

Select the XTYT mode from the graph window mode (M) menu to display waveforms.

(2) Method of using the servo check board

For details on how to connect and use the servo check board, refer to the following:

Appendix I in the FANUC AC SERVO MOTOR α i series Parameter Manual (B-65270EN)

For Series 30i/31i/32i and Series 0i-MODEL C, D, use the SERVO GUIDE because the servo check board cannot be connected and used.

- Required units

- Servo check board
A06B-6057-H630
- Oscilloscope

- **Settings**· **CNC setting**

Parameter setting for servo software series 90B0

Output channel	Data number 5		Data number 6	
FS15i	No.1726	No.1774	No.1775	No.1776
FS16i/18i/21i/0i/PMi	No.2115	No.2151	No.2152	No.2153
Measurement axis/ current phase	IR		IS	
L-axis (Note 1)	370	0	402	0
M-axis (Note 1)	2418	0	2450	0

Parameter setting for servo software series 9096

Output channel	Data number 5	Data number 6
FS16i/18i/21i/0i/PMi	No.2115	No.2115
Measurement axis/ current phase	IR	IS
L-axis (Note 1)	370	402
M-axis (Note 1)	1010	1042

When series 9096 is used, if no axis is paired with the measurement axis (Note 2), IR and IS cannot be observed simultaneously.

NOTE

- 1 The L-axis is an axis identified with an odd number set in parameter No. 1023. The M-axis is an axis identified with an even number set in parameter No. 1023.
- 2 The axis specified as 2n-1 in parameter No. 1023 and the axis specified as 2n will be in a pair.

Setting the output period of motor current data (for the 90B0 series only)

Output period	Parameter No. 1746 / Bit 7 of parameter No. 2206
Velocity loop period	0 (default)
Current loop period	1 (Note 3)

NOTE

- 3 If the current loop period is set up as the motor current data output period, selecting data number **0**, **1**, **2**, or **4** disables the output of signals (such as a velocity command) to channels. To observe the motor current and other signals (such as a velocity command), specify the output period as 1 ms.
- 4 For the servo software series 9096, the output period of the motor current is only 1 ms. The current loop period cannot be used for output.

· **Setting up the check board**

- Set the AXIS digit of the LED display with an axis number from **1** to **8** specified in parameter No. 1023.
- Set the DATA digit of the LED display with a data number from **5** to **6**.

- Method for observing the motor current

The voltage corresponding to the motor current is output to a channel for which **5** or **6** is set as the data number on the servo check board.

The waveform of the motor current can be observed by measuring the voltage mentioned above with an oscilloscope.

The following table lists the relationships between the observed voltage and the motor current.

Maximum amplifier current	Servo Amplifier type	Motor current/ observed voltage [A/V]
10A	α iSV 10HV and others	2.5
20A	α iSV 20 and others	5
40A	α iSV 40 and others	10
80A	α iSV 80 and others	20
160A	α iSV 160 and others	40
180A	α iSV 180HV and others	45
360A	α iSV 360 and others	90
540A	α iSV 540HV	135

For the Servo Amplifier I-20i, for example, the motor current is 5A (actual value rather than effective value) if the observed voltage is 1V.





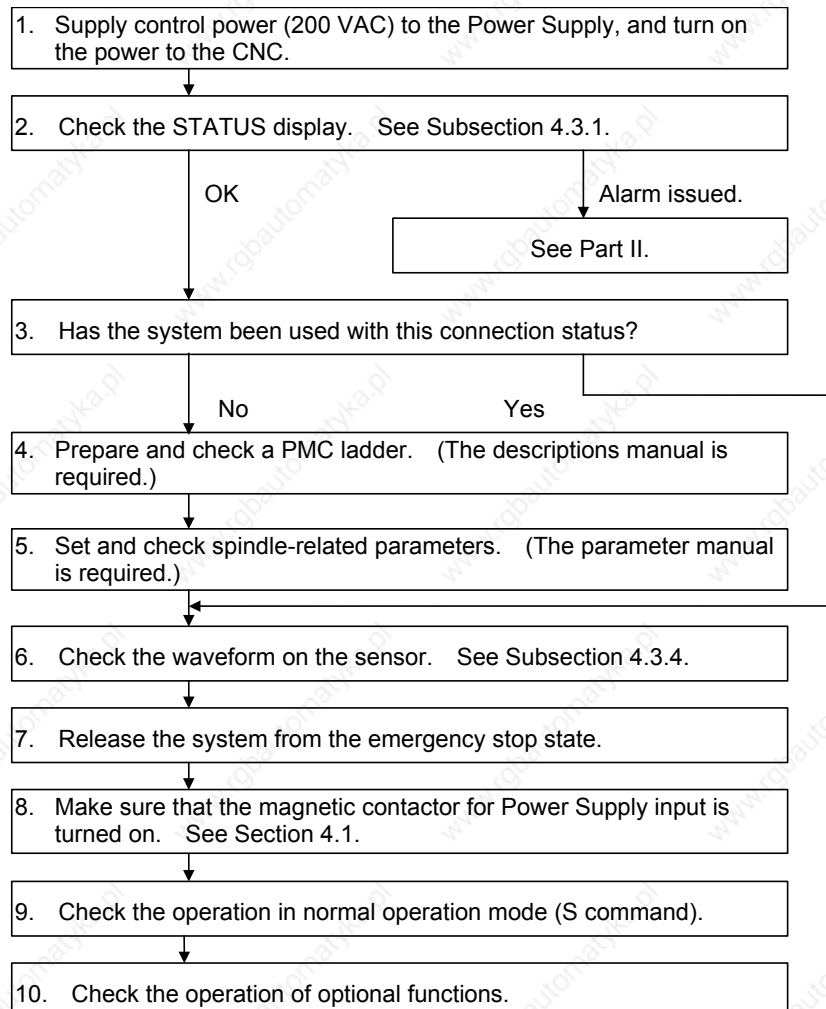

4.3 SPINDLE AMPLIFIER

Check each item according to the procedure described below.

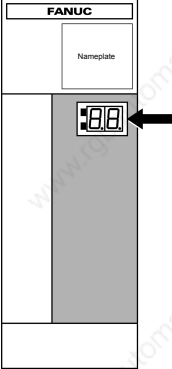
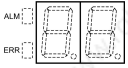

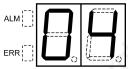
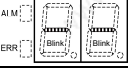
4.3.1 STATUS Display (Spindle Amplifier)

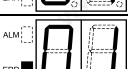
The STATUS display (a 7-segment LED) on the front of the Spindle Amplifier indicates the operation status.

STATUS LED position	STATUS display	Description
		The STATUS LED is off. Control power has not been supplied, cable is faulty, or control power circuit is defective.
		After control power is turned on, the spindle software series is displayed (for approx. 1 second). The last two digits of the spindle software series number are displayed.
		The spindle software version is displayed (for approx. 1 second following the display of the spindle software series). [Display] 01,02,03,... → [Version] A, B, C,...
		The CNC is not powered on (- - blinks). Waiting for serial communication and parameter loading completion.
		Parameter loading completed The motor is not excited.
		Ready status The spindle motor is excited.
		Alarm status The alarm type is indicated by the character displayed.
		Error status (invalid sequence or parameter setting error) The error type is indicated by the character displayed.

4.3.2 Troubleshooting at Startup

4.3.2.1 The PIL LED (power-on indicator) is off.

- (1) When the PIL LED on the spindle amplifiers does not come on after the main circuit breaker is turned on

No.	Cause of trouble	Check method	Action
1	The 200-V control power is not supplied.	The Power Supply PIL lamp is off.	Check the cable attached to CX1A of Power Supply.
2	The cable is defective.	The Power Supply PIL lamp is on.	Check the cable attached to the connector CXA2A/B.
3	The power is externally connected to 0 V, GND, or the like.	When the connector is detached, the PIL lamp is on.	Replace or repair the cable.
4	There is a blown fuse on the printed circuit board.	Even when all cables except the cable attached to connector CX2A/B are detached, the PIL lamp does not come on.	If the fuse blows, the printed circuit board may be faulty. Replace the unit.
5	The printed circuit board is defective.		Replace the unit.

4.3.2.2 The STATUS display is blinking with "--."

- (1) When no spindle communication alarm message is indicated on the CNC
Check whether the CNC software option setting or bit setting is correct.
- (2) When a communication alarm message is indicated on the CNC

No.	Cause of trouble	Check method	Action
1	The cable is incorrect.	Note that the cable used for connecting an electric/optical adapter and the cable connected directly to the CNC differ in specifications.	Replace the cable with a correct cable.
2	The cable is defective.	Check the connector housing section.	Repair or replace the cable.
3	The printed circuit board is defective.		Replace the unit.

- (3) When Dual Check Safety is in use, and No. 756 or 766 occurs on the CNC (FS16i)
Check that K76, shown below, is mounted on the second spindle.
If Dual Check Safety is not in use or the CNC has only the first spindle, K76 is unnecessary.

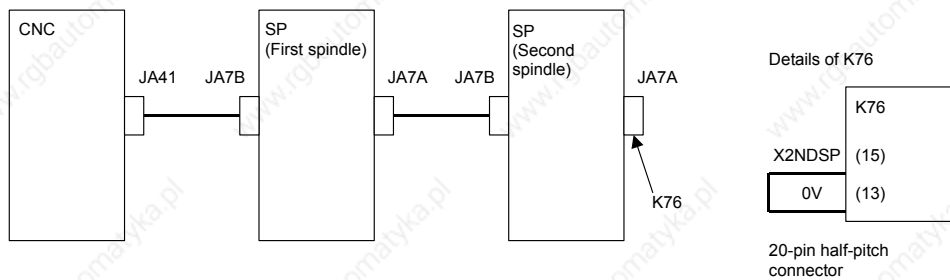

4.3.2.3 The motor does not turn.

- (1) When "--" is indicated on the STATUS display of the Spindle Amplifier
Check whether spindle control signals are input. (An example for the first spindle is shown below.)

FS15i	FS16i FS0i-B/C	FS30i FS0i-D	#7	#6	#5	#4	#3	#2	#1	#0
G227	G070	G070	MRDYA		SFRA	SRVA				
G226	G071	G071							*ESPA	
—	G029	G029		*SSTP						
—	G030	G030	SOV7	SOV6	SOV5	SOV4	SOV3	SOV2	SOV1	SOV0

- (2) When "00" is indicated on the STATUS display of the Spindle Amplifier
No spindle speed command is input.
Refer to Chapter 1 in "FANUC AC SPINDLE MOTOR α i series Parameter Manual (B-65280EN)," and check related parameters.
- (3) When an alarm number is indicated on the Spindle Amplifier
See the description of the alarm number in Part II.

4.3.2.4 A specified speed cannot be obtained.

- (1) When the speed always differs from a specified speed
Check parameters.
Refer to Chapter 1 in "FANUC AC SPINDLE MOTOR α i series Parameter Manual (B-65280EN)," and check related parameters.

- (2) When an alarm number is indicated on the Spindle Amplifier
See the description of the alarm number in Part II.

4.3.2.5 When cutting is not performed, the spindle vibrates, making noise.

- (1) The spindle vibrates only when the spindle speed has reached or is at a particular speed level. Check whether the spindle also vibrates when the motor is turning by inertia. If noise is unchanged, investigate the source of mechanical vibration. There are several methods to turn the spindle by inertia as explained below. Because these methods involve machine sequences, consult with the machine tool builder.
- A. Setting spindle control signal MPOF (FS16i: G73#2, FS15i: G228#2) to 1 immediately causes the spindle to turn by inertia.
 - B. Set ALSP (FS16i: bit 2 of parameter No. 4009, FS15i: bit 2 of parameter No. 3009) to 1. Then, when the power to the CNC is turned off during spindle rotation, the spindle turns by inertia. (On the spindle amplifier, Alarm 24 is indicated.)
- (2) When noise is generated at the time the motor is stopped or at any time
- A. See Subsection 4.3.4 of this part, and check and adjust the waveform of the spindle sensor.
 - B. Check that the motor part number matches its parameters. For details, refer to Appendix A in "FANUC AC SPINDLE MOTOR α i series Parameter Manual (B-65280EN)."
 - C. Adjust the velocity loop gain and so forth.
For details, refer to Chapter 1 in "FANUC AC SPINDLE MOTOR α i series Parameter Manual (B-65280EN)."

4.3.2.6 An overshoot or hunting occurs.

Refer to Chapter 1 in "FANUC AC SPINDLE MOTOR α i series Parameter Manual (B-65280EN)," and adjust parameters.

4.3.2.7 Cutting power weakens or acceleration/deceleration slows down.

- (1) When the load meter does not indicate the maximum output
- A. A mechanical cause such as a belt slip may occur.
- (2) When the load meter indicates the maximum output
- A. Check whether the torque limit signal is input incorrectly.

FS15i	FS16i FS0i-B/C	FS30i FS0i-D	#7	#6	#5	#4	#3	#2	#1	#0
G227	G070	G070							TLMHA	TLMLA

- B. If you are using the α i BZ sensor, it is likely that a slip has occurred between the sensor gear and spindle (on acceleration).
- C. Check that the motor part number matches its parameters.
For details, refer to Appendix A in "FANUC AC SPINDLE MOTOR α i series Parameter Manual (B-65280EN)."
- D. Check whether the output limit pattern is set incorrectly.
For details, refer to Chapter 1 in "FANUC AC SPINDLE MOTOR α i series Parameter Manual (B-65280EN)."

4.3.3 Status Error Indication Function

When there is a sequence or parameter error, the error LED (yellow) in the display section of the Spindle Amplifier (SP) goes on with an error code displayed. This can ease troubleshooting at the time of machine startup.

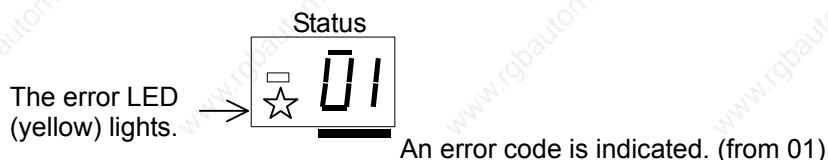

The error code is also displayed on the CNC diagnosis screen.

Diagnosis No.			Description
FS15i	FS16i	FS30i FS0i-D	
1561	710(First spindle) 711(Second spindle) 730(Third spindle) 731(Fourth spindle)	710	Status error code

When the Spindle Amplifier does not operate for a certain function, check whether the status error is indicated in the display section of the Spindle Amplifier or CNC diagnosis screen.

No.	Description	Action
01	Although neither *ESP (emergency stop signal) (there are two types of signals, a PMC signal and Power Supply (PS) contact signal) nor MRDY (machine ready signal) has been input, SFR (forward rotation signal), SRV (reverse rotation signal), or ORCM (orientation command) is input.	Check the *ESP and MRDY sequences. For MRDY, pay attention to the parameter that specifies whether to use the MRDY signal (bit 0 of parameter No. 4001).
03	Although parameter settings are such that that there is no position sensor (position control is not to be performed, that is, bits 3, 2, 1, and 0 of parameter No. 4002 are, respectively, 0, 0, 0, and 0), a Cs axis contour control command has been issued. In this case, the motor is not activated.	Check setting of the parameter.
04	Although parameter settings are such that that there is no position sensor (position control is not to be performed, that is, bits 3, 2, 1, and 0 of parameter No. 4002 are, respectively, 0, 0, 0, and 0), a servo mode (such as rigid tapping or Cs axis control) command or spindle synchronization control command has been issued. In this case, the motor is not activated.	Check setting of the parameter.
05	Although optional parameter for the orientation function is not set, an ORCM (orientation command) is input.	Check setting of the parameter for orientation.
06	Although optional parameter for the output switching option is not set, low-speed winding is selected (RCH = 1).	Check setting of the parameter for output switching and the power line status signal (RCH).
07	Although Cs contour control mode is input, neither SFR (forward rotation signal) nor SRV (reverse rotation signal) is input.	Check the sequence.
08	Although servo mode (rigid tapping or spindle positioning) control command is input, neither SFR (forward rotation signal) nor SRV (reverse rotation signal) is input.	Check the sequence.

4.CONFIRMATION OF THE OPERATION

B-65285EN/04

START-UP PROCEDURE

No.	Description	Action
09	Although spindle synchronization control command is input, neither SFR (forward rotation signal) nor SRV (reverse rotation signal) is input.	Check the sequence.
10	Although Cs contour control command is input, another operation mode (servo mode, spindle synchronization, or orientation) is specified.	Do not specify another mode during execution of the Cs contour control command. Before entering another mode, cancel the Cs contour control command.
11	Although servo mode (rigid tapping or spindle positioning) is input, another operation mode (Cs contour control, spindle synchronization, or orientation) is specified.	Do not specify another mode during execution of the servo mode command. Before entering another mode, cancel servo mode.
12	Although spindle synchronization is input, another operation mode (Cs contour control, servo mode, or orientation) is specified.	Do not specify another mode during execution of the spindle synchronization command. Before entering another mode, cancel the spindle synchronization command.
13	Although orientation specification is input, another operation mode (Cs contour control, servo mode, or synchronization control) is specified.	Do not specify another mode during execution of the orientation command. Before entering another mode, cancel the orientation command.
14	The SFR (forward rotation signal) and SRV (reverse rotation signal) are input at the same time.	Input one of the SFR and SRV signals.
16	Although the parameter not to use the differential speed control function (bit 5 of parameter No. 4000 = 0) is set, DEFMD (differential speed mode command) is input.	Check the setting of the parameter and the differential speed mode command.
17	The parameter settings for the speed detector (bits 2, 1, and 0 of parameter No. 4011) are invalid. There is no speed detector that matches the settings.	Check the setting of the parameter.
18	Although parameter settings are such that there is no position sensor (position control is not to be performed, that is, "bits 3, 2, 1, and 0 of parameter No. 4002 are, respectively, 0, 0, 0, and 0," a position coder-based orientation command has been issued.	Check the setting of the parameter and the input signal.
19	Although magnetic sensor orientation command is input, another operation mode (Cs contour control, servo mode, or spindle synchronization) is specified.	Do not specify another mode during execution of the orientation command. Before entering another mode, cancel the orientation command.
21	The tandem operation command was input in the spindle synchronization control enable state.	Input the tandem operation command when spindle synchronization control is canceled.
22	Spindle synchronization control was specified in the tandem operation enable state.	Specify spindle synchronization control when torque tandem operation is canceled.
23	The tandem operation command is input without the required option.	Torque tandem control requires a CNC software option. Check the option.
24	Although continuous indexing in position coder-based orientation is to be performed, an absolute position command (INCMD = 0) has been issued after incremental operation (INCMD = 1).	Check the INCMD (incremental command). Be sure to perform absolute position command-based orientation before an absolute position command.
26	The parameter settings are such that both spindle switch and three-stage speed range switch are used.	Check the parameter settings and the input signal.
29	Parameter settings are such that the shortest-time orientation function is to be used (bit 6 of parameter No. 4018 is 0 and parameter Nos. 4320 to 4323 are nonzero).	The shortest-time orientation function cannot be used in the α i series spindle amplifier. The use of the optimum orientation function is recommended.

4.CONFIRMATION OF THE

OPERATION

START-UP PROCEDURE

B-65285EN/04

No.	Description	Action
30	The magnetic pole has not been detected, but a command is input.	In the magnetic pole undetected state (EPFIXA = 0), the motor cannot be driven even when a command is input. Input a command in the magnetic pole detected state (EPFIXA = 1). When EPFSTR is set to 1, any command is ignored and this error is displayed even in the magnetic pole detected state. After the completion of magnetic pole detection, set EPFSTR to 0.
31	This hardware configuration does not support the use of the spindle FAD function. In this case, the motor is not activated.	Check the CNC model.
32	S0 is not specified in the velocity mode, but the disturbance input function is enabled (bit 7 of parameter No. 4395 is set to 1).	Specify S0 in the velocity mode before enabling the disturbance input function (bit 7 of parameter No. 4395 to 1).
33	This hardware configuration does not support the use of the spindle EGB function. In this case, the motor is not activated.	Check the CNC model.
34	Both spindle FAD function and spindle EGB function are enabled. In this case, the motor is not activated.	These functions cannot be used at the same time. Enable only one of the functions.
35	Spindle Amplifier (SP) ID information cannot be obtained.	Replace the spindle amplifier with one with correct ID information.
36	The submodule SM (SSM) is faulty . 1) The interface signal between the Spindle Amplifier and SSM is disconnected. 2) SSM failure	For the action to be taken for this status error, refer to Section 1.4, "Submodule SM," in Part IV in the FANUC AC SPINDLE MOTOR α i series Parameter Manual.
37	The current loop setting (No. 4012) has been changed.	Check the setting of parameter No. 4012, and turn the power off, then on again.
38	A parameter related to communication between spindle amplifiers is specified incorrectly. Alternatively, a function unavailable with the torque tandem function is set.	Check the parameters.
39	Although SFR (forward rotation command), SRV (reverse rotation command), or ORCM (orientation command) is input, DSCN (disconnection detection disable signal) is input.	Check the sequence. Do not input DSCN (disconnection detection disable signal) during the input of a command which excites the motor.
43	A setting which does not support the α iCZ sensor (serial) is used.	Check the parameter settings.
44	The spindle amplifier does not support the control period setting.	Check the setting of parameter No. 4012.

NOTE

- *1 When status error 43 is displayed, check the following items. The items to be checked differ depending on the series and edition of the spindle software.
- Series 9D80 edition E (edition 05) or edition F (edition 06): Items <1> to <12>
 Series 9D80 edition G (edition 07): Items <1> to <9>, <12>, and <13>
 Series 9D80 edition H (edition 08): Items <1> to <9>, <13>, and <14>
- (1) For both the motor sensor and spindle sensor, the setting is made to use an α iCZ sensor (serial). (No.4010#2,1,0=0,1,0 and No.4002#3,2,1,0=0,1,1,0)
 - (2) Spindle HRV control is not set. (No.4012#7=0)
 - (3) The setting is made to use the differential speed control function. (No.4000#5=1)
 - (4) The setting is made to use the spindle switch control function. (No.4014#0=1)
 - (5) The setting is made so that an alarm related to position feedback is not detected. (No.4007#6=1 or No.4016#5=0)
 - (6) The setting is made so that the disconnection of the feedback signal is not detected. (No.4007#5=1)
 - (7) The setting is made so that an alarm related to position signal feedback is not detected during thread cutting. (No.4016#5=0)
 - (8) The setting is made to use an external one-rotation signal. (No.4004#2=1)
 - (9) The setting is made to use a position coder. (No.4002#3,2,1,0=0,0,1,0)
 - (10) The setting is made to drive a synchronous spindle motor. (No.4012#6=1)
 - (11) The setting is made to use communication between Spindle Amplifiers. (No.4352#7=1 or No.4352#6=1)
 - (12) The setting is made to use the Dual Check Safety function.
 - (13) The setting is made to use the spindle tandem function. (No.4015#3=1)
 - (14) Although the setting is made to use an α iCZ sensor (serial) as the motor sensor, the Dual Check Safety function is enabled.

4.3.4 Checking the Feedback Signal Waveform

The measurement locations and the method for attaching connectors vary depending on the configuration of the detector. Check the waveform while seeing Table 4.3.4. The check terminals are on the check board.

Table 4.3.4(a) Signals input to the Spindle Amplifier and corresponding check terminals on the check board

Check terminal name	Spindle Amplifier input signal (connector name-pin No.)	Main sensors	Remarks
PA1 PB1	JYA2-pin5,6 JYA2-pin7,8	α i M, α i MZ, and α i BZ sensors Analog α i CZ sensor	
PA2 PB2	JYA4-pin5,6 JYA4-pin7,8	α i BZ sensor Analog α i CZ sensor α position coder S (1024 λ)	For TYPE B only
PS1	JYA2-pin1,2	α i MZ and α i BZ sensors (one-rotation signal) Analog α i CZ sensor (one-rotation signal)	
PS2	JYA4-pin1,2	α i BZ sensor (one-rotation signal) Analog α i CZ sensor (one-rotation signal)	For TYPE B only
EXTSC1	JYA3-pin15	Proximity switch (external one-rotation signal)	

For the α position coder and α position coder S (one-rotation signal), observe the Spindle Amplifier input signal directly, using the servo check pin board A06B-6071-K290.

4.3.4.1 α i M sensor, α i MZ sensor, and α i BZ sensor

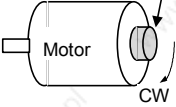
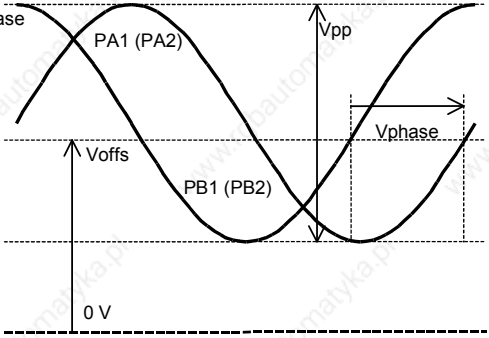
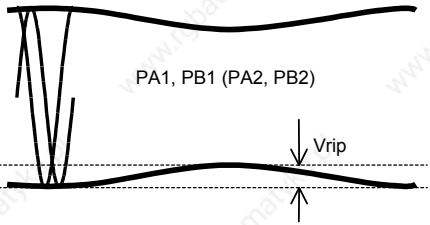
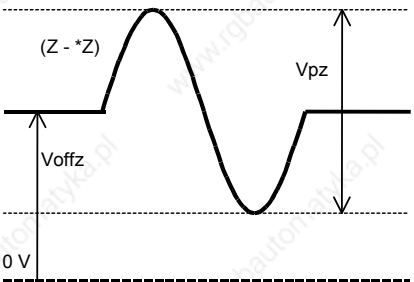
Measurement location	Measurement condition	Sample waveform
PA1, PB1 Separate sensors PA2, PB2 PS1 Separate sensor PS2	The speed must be 1500 min ⁻¹ or less. Rotation direction: CW Detection gear 	Waveforms of phase A and phase B  Ripples of phase A and phase B  For α i MZ and α i BZ sensors only Waveform of phase Z 

Measurement item	Specification	Measurement method	Adjustment method
Vpp	0.5 to 1.2 Vp-p	Use the DC range of a digital voltmeter.	Normally, the α i M and α i MZ sensors need not be adjusted. For Voffs and Voffz, only level check is possible, but adjustment is not possible.
Voffs, Voffsz	2.5 V \pm 100 mV		
Vphase	90 \pm 3°		
Vrip	< 70 mV		
Vpz	> 0.5 V		

4.3.4.2 Analog αi CZ sensor

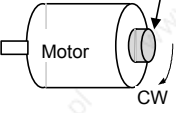
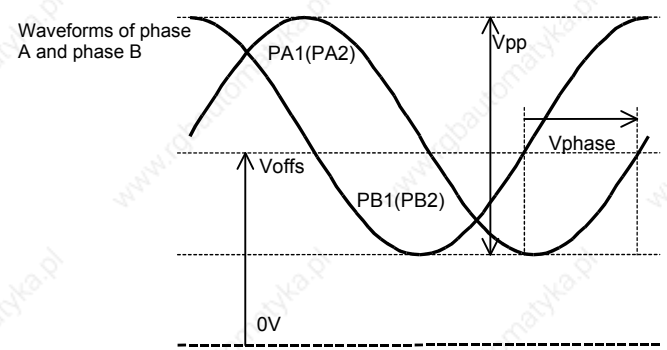
Measurement location	Measurement condition	Sample waveform
PA1, PB1 Separate sensors PA2, PB2	Speed: 500min ⁻¹ Rotation direction: CW Detection gear 	Waveforms of phase A and phase B 

Measurement item	Specification	Measurement method	Adjustment method
Vpp	0.9 to 1.1V p-p		The sensors are adjusted at shipment. Do not adjust the sensors, or the detection precision is affected.
Voffs	2.5V ± 50mV	Use the DC range of a digital voltmeter.	

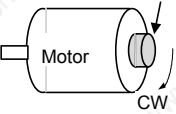
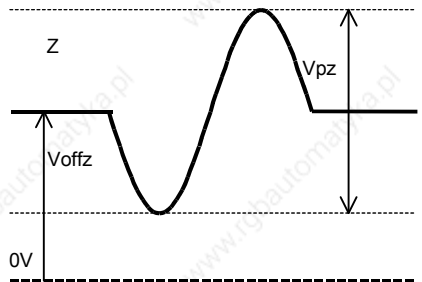
Measurement location	Measurement condition	Sample waveform
PS1 Separate sensor PS2	Speed: 500min ⁻¹ Rotation direction: CW Detection gear 	Waveform of phase Z 

Measurement item	Specification	Measurement method	Adjustment method
Vpz	0.66 to 1.65V p-p		The sensors are adjusted at shipment. Do not adjust the sensors, or the detection precision is affected.
Voffsz	2.5V ± 50mV	Use the DC range of a digital voltmeter.	

NOTE
For how to check the serial output αi CZ sensor signals, refer to the technical report of the relevant sensor.

4.3.4.3 α position coder S

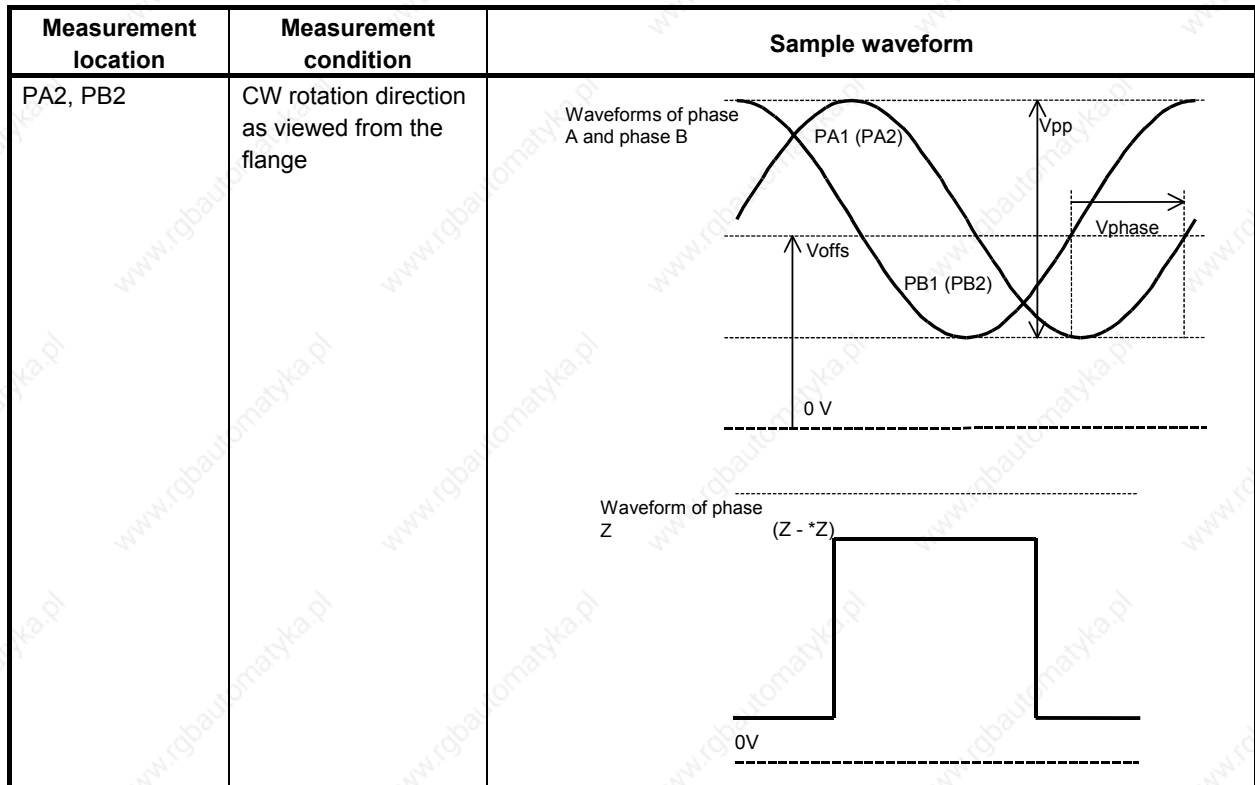

Measurement item	Specification	Measurement method	Adjustment method
Vpp	0.8 to 1.2 Vp-p		Only level check is possible, but adjustment is not possible.
Voffs,Voffsz	2.5 V \pm 100 mV	Use the DC range of a digital voltmeter.	
Vphase	90 \pm 5°		

4.3.5 Spindle Check Board

When connecting the check board, you can:

- <1> Observe signal waveforms.
- <2> Observe internal data.
- <3> Check spindle parameter values.

You can perform the above more easily by using the SERVO GUIDE. For information about the SERVO GUIDE, see Subsection 4.3.8.

4.3.5.1 Spindle check board specifications

Spindle check board specifications is bellow.

Table 4.3.5.1 Spindle check board specifications

Specification	Drawing No. of printed circuit board	Applicable unit
A06B-6078-H001	A20B-2001-0830	α i series, α Ci series (having the same specification as for the α series)

4.3.5.2 Check board connection

(1) αi series

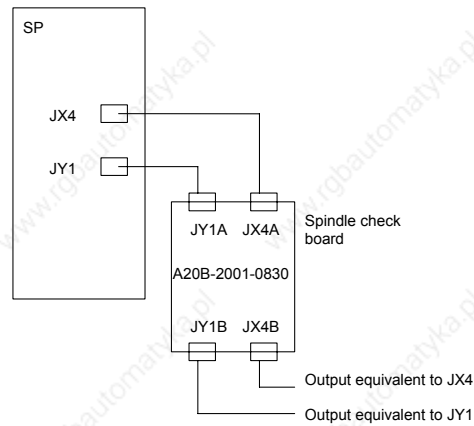

(2) αCi series

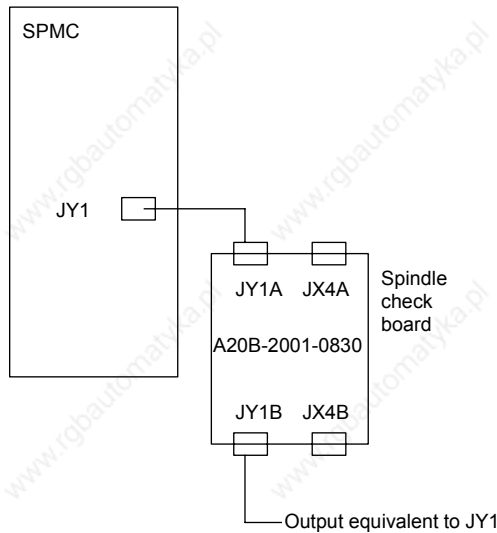

4.3.5.3 Check terminal output signals

(1) αi series

Check terminal	Signal name	Check terminal	Signal name
LM	Load meter signal	PA1	Phase A sine wave signal 1
SM	Speedometer signal	PB1	Phase B sine wave signal 1
CH1	Analog output for internal data observation (Phase U current: IU)	PS1	Phase Z sine wave signal 1
CH2	Analog output for internal data observation (Motor speed TSA: 1638 min ⁻¹ /V)	PA2	Phase A sine wave signal 2 (TYPE B)
CH1D	Output for internal data bit observation	PB2	Phase B sine wave signal 2 (TYPE B)
CH2D	Output for internal data bit observation	PS2	Phase Z sine wave signal 2 (TYPE B)
VRM	Disuse	PA3	Disuse
LSA1	Disuse	PB3	Disuse
EXTSC1	External one-rotation signal (main)	PA4	Disuse
LSA2	Disuse	PB4	Disuse

4.CONFIRMATION OF THE

OPERATION

START-UP PROCEDURE

B-65285EN/04

Check terminal	Signal name	Check terminal	Signal name
EXTSC2	Disuse	OVR2	Analog override command
PAD	Phase A of position coder signal output (TYPE B)	15V	Disuse
PBD	Phase B of position coder signal output (TYPE B)	5V	+5 VDC power check
PSD	Phase Z of position coder signal output (TYPE B)	-15V	Disuse
		GND	0 V

(2) αCi series

Check terminal	Signal name	Check terminal	Signal name
LM	Speedometer signal (This can be switched to the load meter signal by parameter setting.)	PA1	Disuse
SM	Disuse	PB1	Disuse
CH1	Analog output for internal data observation (Phase U current: IU)	PS1	Disuse
CH2	Analog output for internal data observation (Estimated motor speed : $1638 \text{ min}^{-1}/V$)	PA2	Disuse
CH1D	Output for internal data bit observation	PB2	Disuse
CH2D	Output for internal data bit observation	PS2	Disuse
VRM	Disuse	PA3	Disuse
LSA1	Disuse	PB3	Disuse
EXTSC1	Disuse	PA4	Disuse
LSA2	Disuse	PB4	Disuse
EXTSC2	Disuse	OVR2	Analog override command
PAD	Disuse	15V	Disuse
PBD	Disuse	5V	+5 VDC power check
PSD	Disuse	-15V	Disuse
		GND	0 V

Check terminal arrangement

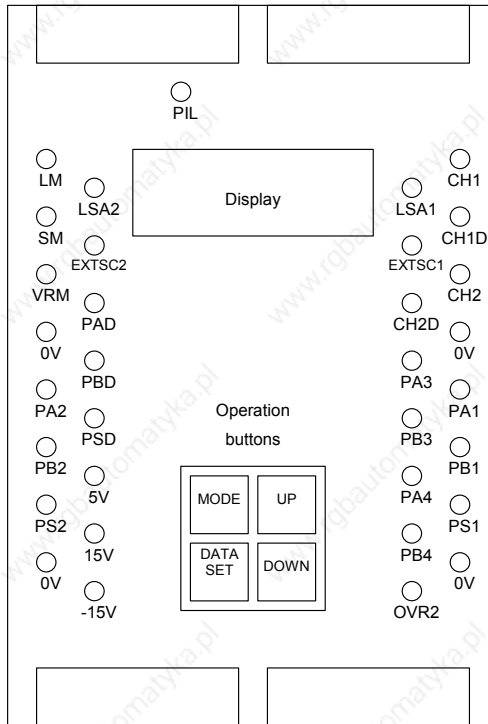

4.3.6 Observing Data Using the Spindle Check Board

4.3.6.1 Overview

By using the check board, you can convert digital signals used for control in the Spindle Amplifier to analog voltage, and observe the conversion result with an oscilloscope. For internal data observation, you can use CH1 and CH2 (output: -5 to +5 V) as the two-channel analog output, and CH1D and CH2D as the output for checking specific bits of bit data or the like. You can also view internal data on the five-digit indicator.

4.3.6.2 Major characteristics

Item		
Measurement point	CH1, CH2	CH1D, CH2D
Output voltage range	-5 to +5 V	H: 2 Vmin L: 0.8 Vmax
Resolution	About 39 mV (10 V/256)	-
Output impedance	10 kΩmin	10 kΩmin

4.3.6.3 Observation method

By setting data using four DIP switches on the check board, you can output internal data to the five-digit display, analog voltage output circuit, channels 1 and 2 (LM and SM or CH1 and CH2). Data on channels 1 and 2 is the one from an 8-bit D/A converter. The correspondence between channel 1/2 and the check terminal is listed below.

Measurement point	Check terminal
Channel 1	CH1 CH1D, data bit 0
Channel 2	CH2 CH2D, data bit 0

4.3.6.4 Specifying data to be monitored

- <1> Press the four setting switches at the same time for at least a second. "FFFFF" will be displayed on the indicator.
- <2> Turn off the switches and press the "MODE" switch. "d-00" will be displayed on the indicator and the system will enter the mode for monitoring internal data.
- <3> In this mode, the motor can be operated normally.
Press the "UP" or "DOWN" switch while holding down the "MODE" switch. The indicator display will change in the range of "d-00" to "d-12".
- <4> The following shows the correspondence between the destinations of the internal data of the serial spindle and addresses d-01 to d-12.
- d-01 to d-04 : Specifies the amount of data to be output to the indicator, data shift, and output format (decimal or hexadecimal).
- d-05 to d-08 : Specifies the amount of data to be output to the channel 1, data shift, and whether an offset is provided.
- d-09 to d-12 : Specifies the amount of data to be output to the channel 2, data shift, and whether an offset is provided.
- <5> Select address d-xx in the procedure for setting data described in <3>.
- <6> Turn off the "MODE" switch. "d-xx" will disappear 0.5 second later, and the data will be displayed for a second.
Change the set data using the "UP" or "DOWN" switch within the second the data is displayed.
- <7> When more than a second elapses without pressing the "UP" or "DOWN" switch, data cannot be changed.
If the "MODE" switch is turned on or off, however, setting can be started from the beginning of the step in item <6>.

4.3.6.5 Address descriptions and initial values (Spindle Amplifier)

[Output to the indicator]

Address	Description	Initial value
d-01	Specifies a data number.	0
d-02	Shift at data output (0 to 31 bits)	0
d-03	Data shift direction 0 : Data is shifted right. 1 : Data is shifted left.	0
d-04	Display format 0 : Decimal notation 1 : Hexadecimal notation(0 to F)	0

[Output to the channel 1]

Address	Description	Initial value
d-05	Specifies a data number	218 (U-phase current)
d-06	Shift at data output (0 to 31 bits)	8
d-07	Data shift direction 0: Data is shifted right 1: Data is shifted left	0
d-08	Offset 0: Not provided 1: Provided	1

[Output to the channel 2]

Address	Description	Initial value
d-09	Specifies a data number	19 (Motor velocity)
d-10	Shift at data output (0 to 31 bits)	18
d-11	Data shift direction 0: Data is shifted right 1: Data is shifted left	0
d-12	Offset 0: Not provided 1: Provided	1

4.3.6.6 Principles in outputting the internal data of the serial spindle

The length of data is 32 bits (BIT31 TO BIT00) unless it is described as 16 bits.

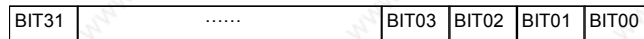

(1) Example of output to the indicator

Example1: Displaying data in decimal

When the number of digits to shift data (d-02)=0 and display format (d-04)=0 (decimal notation): The last 16 bits of data (BIT15 to BIT00) are converted into decimal (0 to 65535 max.) and displayed.

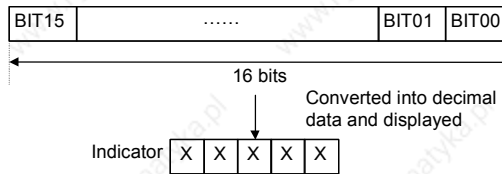

Example2: Displaying data in hexadecimal

When the number of digits to shift data (d-02)=0 and display format (d-04)=1 (hexadecimal notation): The last 16 bits of data (BIT15 to BIT00) are converted into hexadecimal (0 to FFFFF max.) and displayed.

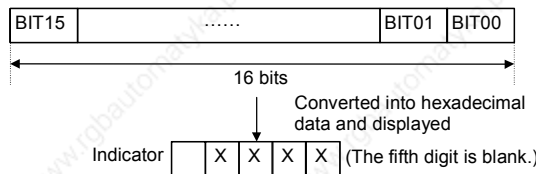

Example3: Shifting data left

When the number of digits to shift data (d-02)=3, the shift direction is left (d-03=1), and display format (d-04)=1 (hexadecimal notation): Data in BIT12 to BIT00 and the last three bits of data (=0) are converted into hexadecimal (0 to FFFFF max.) and displayed.

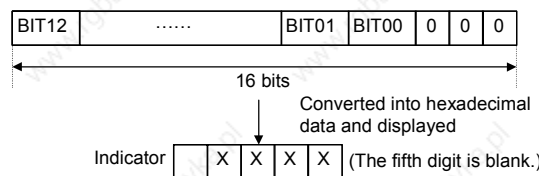

Example4: Shifting data right

When the number of digits to shift data (d-02)=5, shift direction is right (d-03=0), and display format (d-04)=0 (decimal notation): Data in BIT20 to BIT05 is converted into decimal (0 to 65535 max.) and displayed.

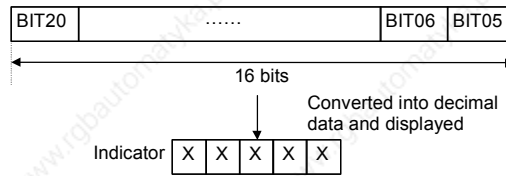

Example5: Shifting data right when the data length is 16 bits

When the data length is 16 bits, data shift (d-02)=5, shift direction is right (d-03=0), and display format is decimal notation (d-04=0): The first five bits of data and data in BIT15 to BIT05 are converted into decimal and displayed.

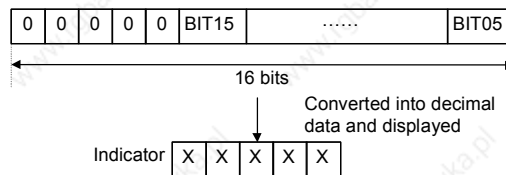

(2) Example of output to the channel 1

Internal data is output to channel 1 by setting it in an 8-bit D/A converter.

The D/A converter output ranges from -5 to +5 V, depending on a set value of internal data. See the table below.

Internal data in binary (decimal)	Setting d-08 (whether there is offset)	Output on channel 1
00000000 (0)	0	-5V
11111111 (255)	0	+4.96V
10000000 (-128)	1	-5V
00000000 (0)	1	0V
01111111 (127)	1	+4.96V

Example1: Data set

When the number of digits to shift data (d-06)=0 and when no offset is provided (d-08=0): The last eight bits of data (BIT07 to BIT00) is set in the D/A converter of the LM terminal.

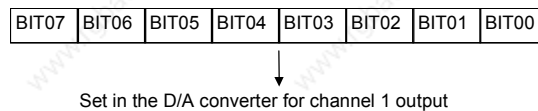

Example2: Shifting data left

When the number of digits to shift data (d-06)=3, shift direction is right (d-07=1), and no offset is provided (d-08=0): Data in BIT14 to BIT00 and the last three bits of data (=0) are set in the D/A converter.

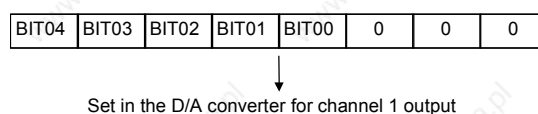

Example3: Shifting data right

When the number of digits to shift data (d-06)=10, shift direction is right (d-07=1), and no offset is provided (d-08=0): Data in BIT17 to BIT10 is set in the D/A converter.

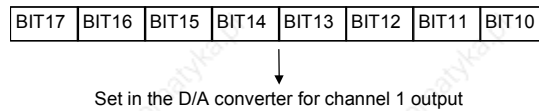
**Example4: Shifting data right when the data length is 16 bits**

When the data length is 16 bits, data shift (d-06)=10, shift direction is right (d-07=0), and no offset is provided (d-08=0): The first two bits of data (=0) and data in BIT15 to BIT10 are set in the D/A converter.

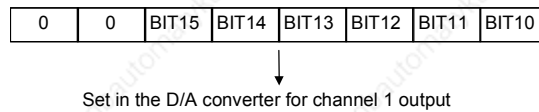
**Example5: If an offset is provided**

When the number of digits to shift data (d-06)=10, shift direction is right (d-07=0), and an offset is provided (d-08=1): Data in most significant bit BIT17 (to which 1 is added) and data in BIT16 to BIT10 are set in the D/A converter.

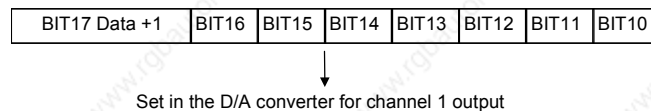
**Example6: Data bit observation**

For data shift (d-06) = 0 with no offset (d-08 = 0), the lowest data bit (BIT00) can be observed as a high/low level at check terminal CH1D.

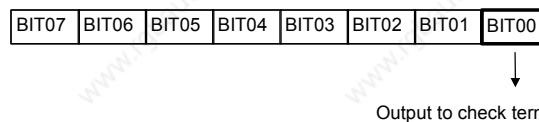
**(3) Example of output to the channel 2**

Output to the channel 2 is the same as that to the channel 1. However, the addresses for setting data (d-09 to d-12) are different from those for output to the channel 1.

Setting velocity information in the channel 1 and the number of errors in the channel 2 enables simultaneous monitoring of the change in each data item using the two channels.

4.3.6.7 Data numbers**(1) Data numbers**

Data No.	Description	Data length	Remarks
Main data			
16	Motor speed command	32	The 12th bit (BIT12) indicates a units in min^{-1} .
19	Motor speed	32	The 12th bit (BIT12) indicates a units in min^{-1} . (An estimated value is used for the αC_i series.)
25	Motor speed deviation	32	(Speed command - motor speed) The 12th bit (BIT12) indicates a units in min^{-1} .
4	Move command	32	Number of command pulses for ITP (usually 8 ms)

Data No.	Description	Data length	Remarks
Main data			
9	Positioning error	32	Number of erroneous pulses (Spindle synchronous control, Cs contour control, Rigid tapping mode)
90	Torque command	16	0 to ± 16384
131	Speedometer data	16	SM terminal
132	Load meter data	16	LM terminal
136	Position error	32	Number of erroneous pulses (Position coder orientation)
Data between the spindle and CNC			
5	Speed command data	16	± 16384 for the maximum speed command
6	Spindle control signal 1	16	See the command signal from the PMC to spindle in (3).
10	Load meter data	16	+32767 for maximum output
11	Motor speed data	16	± 16384 for maximum speed
12	Spindle status signal 1	16	See the status signal from the spindle to PMC in (3).
66	Spindle control signal 2	16	See the command signal from the PMC to spindle in (3).
182	Spindle status signal 2	16	See the status signal from the spindle to PMC in (3).
Other data			
218	Phase U current (A/D conversion data)	16	10 V/FS by shifting 8 bits left
219	Phase V current (A/D conversion data)	16	
162	DC link voltage	16	1000 V/FS by shifting 8 bits left

(2) Internal data conversion

Data No.	Signal name	Description (All are voltage values on check pins when the shift amount is 8.)	
218	IU	Phase U current	The current is positive when it is input to the amplifier. (*1)
219	IV	Phase V current	
162	VDC	DC link voltage signal 100V/1V (200 V system) 200V/1V (400 V system)	

*1 Current conversion result for channels 218 and 219

Model	Conversion result
α iSP 2.2	16.7A/1V
α iSP 5.5	
α iSP 11	33.3A/1V
α iSP 15	50.0A/1V
α iSP 22	66.7A/1V
α iSP 26	100A/1V
α iSP 30	133A/1V
α iSP 37	
α iSP 45	150A/1V
α iSP 55	233A/1V
α iSP 5.5HV	16.7A/1V
α iSP 11HV	
α iSP 15HV	33.3A/1V
α iSP 30HV	50.0A/1V
α iSP 45HV	66.7A/1V
α iSP 75HV	133A/1V
α iSP 100HV	150A/1V

(3) About the spindle control and spindle status signals

Shown below are the data numbers for the PMC signals used by the spindle and the configuration of each data item. Refer to Chapter 3, "PMC Signals (CNC \leftrightarrow PMC)" of "FANUC AC SPINDLE MOTOR α i series PARAMETER MANUAL" (B-65280EN) for explanations about each signal.

(a) Data number 6 : Spindle control signal 1

#15	#14	#13	#12	#11	#10	#9	#8
RCH	RSL	INTG	SOCN	MCFN	SPSL	*ESP	ARST
#7	#6	#5	#4	#3	#2	#1	#0
MRDY	ORCM	SFR	SRV	CTH1	CTH2	TLMH	TLML

(b) Data number 66 : Spindle control signal 2

#15	#14	#13	#12	#11	#10	#9	#8
			DSCN	SORSL	MPOF		
#7	#6	#5	#4	#3	#2	#1	#0
RCHHG	MFNHG	INCMD	OVR		NRRO	ROTA	INDX

(c) Data number 12 : Spindle status signal 1

#15	#14	#13	#12	#11	#10	#9	#8
				RCFN	RCHP	CFIN	CHP
#7	#6	#5	#4	#3	#2	#1	#0
ORAR	TLM	LDT2	LDT1	SAR	SDT	SST	ALM

(d) Data number 182 : Spindle status signal 2

#15	#14	#13	#12	#11	#10	#9	#8
#7	#6	#5	#4	#3	#2	#1	#0
			EXOF	SOREN		INCST	PC1DT

4.3.6.8 Example of observing data

(1) Example of observing a positioning error using the channel 1

Address	Description	Set Data			
d-05	Data number	9	9	9	9
d-06	Data shift	0	1	1	2
d-07	Data shift direction	0	1	1	1
d-08	Offset	1	1	1	1
Data unit (NOTE)		256p/FS	512p/FS	128p/FS	64p/FS

NOTE

FS=10V (-5V to 5V)

(2) Example of observing a motor speed using the channel 2

Address	Description	Set Data		
d-09	Data number	19	19	19
d-10	Data shift	12	13	11
d-11	Data shift direction	0	0	0
d-12	Offset	0	0	0
Data unit (NOTE)		256min ⁻¹ /FS	512min ⁻¹ /FS	128 min ⁻¹ /FS

NOTE

FS=10V (-5V to 5V)

(3) Observation of phase U current in the αiSP 11

Setting of observation data

Data No.	218
Shift amount	8
Shift direction	0 (shifted left)
Offset	1 (provided)

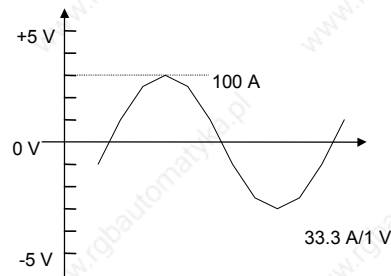

4.3.7 Checking Parameters Using the Spindle Check Board

4.3.7.1 Overview

By using the check board, you can check parameter values transferred to the Spindle Amplifier. Specify parameter numbers using the four setting switches on the check board, and check parameter values on the five-digit indicator.

4.3.7.2 Checking parameters

- <1> Press the four setting switches at the same time for at least one second. "FFFFF" will be displayed on the indicator.
- <2> Turn off the switches and press the "MODE" switch. "d-00" will be displayed on the indicator and the system will enter the mode for measuring internal data.
- <3> With "0" set for "d-00", press the "MODE" and "DATA SET" switches at the same time for at least one second. "CCCCC" will be displayed on the indicator.
- <4> Turn off the switches and press the "MODE" switch. "F-xxx" will be displayed on the indicator and the system will enter the mode for checking spindle parameters (F-mode). (Even in this mode, the motor can be operated normally.)
- <5> Press the "UP" or "DOWN" switch while holding down the "MODE" switch (with "F-xxx" displayed). The number of "F-xxx" increases or decreases. Set the internal number of a parameter you want to check. For correspondences between the parameter internal numbers and NC parameter numbers, see the parameter list in the appendix to the parameter manual.
- <6> Turn off the switches. The parameter value corresponding to the set internal number is displayed for about one second. (Bit parameter values are displayed in hexadecimal.)

4.3.8 Observing Data Using the SERVO GUIDE

4.3.8.1 Overview

Using the servo adjustment tool, SERVO GUIDE, enables you to observe internal data for the spindle. This subsection describes the spindle data that can be observed using the SERVO GUIDE. It also presents examples of observed data. Refer to online help for detailed explanations about how to use the SERVO GUIDE.

4.3.8.2 Usable series and editions

Series 9D50/B(02) and subsequent editions
 Series 9D53/A(01) and subsequent editions
 Series 9D70/A(01) and subsequent editions
 Series 9D80/A(01) and subsequent editions
 Series 9D90/A(01) and subsequent editions
 Series 9DA0/A(01) and subsequent editions

4.3.8.3 List of spindle data that can be observed using the SERVO GUIDE

The following table lists the spindle data that can be observed using the SERVO GUIDE.

Data type	Description
SPEED	Motor speed
INORM	Motor current amplitude
TCMD	Torque command
VCMD	Motor speed command
VERR	Speed deviation
ERR	Position error (9D50/11 and subsequent editions *1)
ERRC	Position error (CNC)
ORERR	Position error at orientation
WMDAT	Move command for an individual position loop
SYNC	Synchronization error (9D50/11 and subsequent editions *1)
PCPOS	Cumulative position feedback value
MCMD	Move command for an individual communication cycle
ERR2	Position error 2
ERR2C	Position error 2(CNC) (9D50/11 and subsequent editions *1)
CSPOS	Cumulative position feedback value
SPCMD	Speed command data from the CNC
SPSPD	Spindle speed (9D50/11 and subsequent editions *1)
SPCT1	Spindle control signal 1
SPCT2	Spindle control signal 2
SPCT3	Spindle control signal 3 (9D50/11 and subsequent editions *1)
SPST1	Spindle status signal 1
SPST2	Spindle status signal 2
ORSEQ	Orientation sequence data
SFLG1	Spindle flag 1 (9D50/11 and subsequent editions *1)
SPPOS	Spindle position data (9D50/12 and subsequent editions *2)
LMDAT	Load meter data 1 (9D50/11 and subsequent editions *1)
DTRQ	Spindle load torque (Unexpected disturbance torque detection function) 1 (9D50/11 and subsequent editions *1)
FREQ	Frequency of disturbance torque (Disturbance input function) 1 (9D50/11 and subsequent editions *1)
GAIN	Gain data (Disturbance input function) 1 (9D50/11 and subsequent editions *1)
MTTMP	Motor winding temperature 1 (9D50/11 and subsequent editions *1)
MFBDF	Motor sensor feedback incremental data 1 (9D50/11 and subsequent editions *1) (For amplitude ratio and phase difference compensation)
SFBDF	Spindle sensor feedback incremental data 1 (9D50/11 and subsequent editions *1) (For amplitude ratio and phase difference compensation)
PA1	AD data 1 of A phase of motor sensor (9D50/11 and subsequent editions *1)
PB1	AD data 1 of B phase of motor sensor (9D50/11 and subsequent editions *1)
PA2	AD data 1 of A phase of spindle sensor (9D50/11 and subsequent editions *1)
PB2	AD data 1 of B phase of spindle sensor (9D50/11 and subsequent editions *1)
VDC	DC link voltage 1 (9D50/11 and subsequent editions *1)
SFERR	Semi-full error 1 (Dual position feedback) (9D50/11 and subsequent editions *1)
SMERR	Semi-closed side error 1 (Dual position feedback) (9D50/11 and subsequent editions *1)
SPACC	Spindle acceleration data 1 (9D50/20 and subsequent editions *4)

NOTE

*1 Available with 9D53/03 and subsequent editions for series 9D53, 9D70/02 and subsequent editions for series 9D70, 9D80/01 and subsequent editions for series 9D80, and 9D90/01 and subsequent editions for series 9D90.

*2 Available with 9D53/04 and subsequent editions for series 9D53, 9D70/03 and subsequent editions for series 9D70, 9D80/01 and subsequent editions for series 9D80, and 9D90/0 and subsequent editions for series 9D90.

*3 To observe data marked with *1 and *2, the SERVO GUIDE Ver. 3.0 or later is required.

*4 Available with 9D70/10 and subsequent editions for series 9D70, 9D80/04 and subsequent editions for series 9D80, and 9D90/01 and subsequent editions for series 9D90.

To observe this data, the SERVO GUIDE Ver. 4.10 or later is required.

4.3.8.4 About the spindle control and spindle status signals

As stated in the previous item, the SERVO GUIDE can be used to observe the PMC signals (spindle control signals 1 and 2 and spindle status signals 1 and 2) used by the spindle.

Listed below is the data configuration for spindle control signals 1 and 2 and spindle status signals 1 and 2. Refer to Chapter 3, "PMC Signals (CNC ↔ PMC)" of "FANUC AC SPINDLE MOTOR α i series PARAMETER MANUAL" (B-65280EN) for explanations about each signal.

(a) Spindle control signal 1 (SPCT1)

#15	#14	#13	#12	#11	#10	#9	#8
RCH	RSL	INTG	SOCN	MCFN	SPSL	*ESP	ARST
#7	#6	#5	#4	#3	#2	#1	#0
MRDY	ORCM	SFR	SRV	CTH1	CTH2	TLMH	TLML

(b) Spindle control signal 2 (SPCT2)

#15	#14	#13	#12	#11	#10	#9	#8
			DSCN	SORS	MPOF		
#7	#6	#5	#4	#3	#2	#1	#0
RCHHG	MFNHG	INCMD	OVR		NRRO	ROTA	INDX

(c) Spindle control signal 3 (SPCT3)

#15	#14	#13	#12	#11	#10	#9	#8
#7	#6	#5	#4	#3	#2	#1	#0

(d) Spindle status signal 1 (SPST1)

#15	#14	#13	#12	#11	#10	#9	#8
				RCFN	RCHP	CFIN	CHP
#7	#6	#5	#4	#3	#2	#1	#0
ORAR	TLM	LDT2	LDT1	SAR	SDT	SST	ALM

(e) Spindle status signal 2 (SPST2)

#15	#14	#13	#12	#11	#10	#9	#8
#7	#6	#5	#4	#3	#2	#1	#0
			EXOF	SOREN		INCST	PC1DT

4.3.8.5 Example of observing data

The following figure shows an example of data (synchronization error and motor speed at rigid tapping) observed using the SERVO GUIDE.

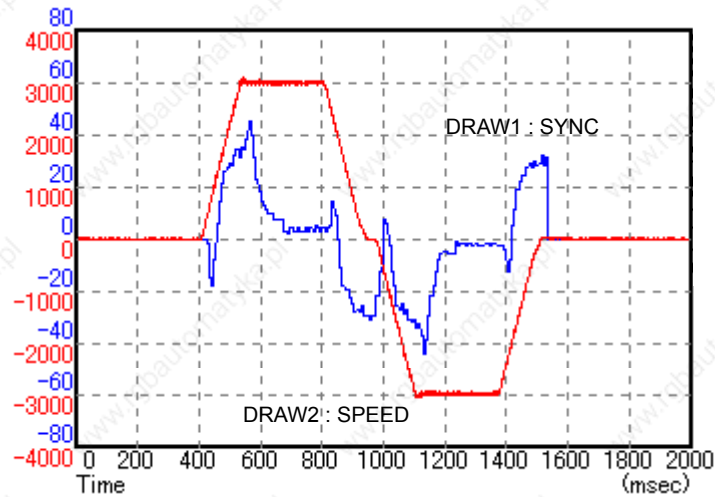

DRAW1 : SYNC (synchronization error) *1

DRAW2 : SPEED (motor speed)

*1 The synchronization error is servo axis output data.

II. TROUBLESHOOTING

1 OVERVIEW

This part describes the troubleshooting procedure for each amplifier. Read the section related to your current trouble to locate it and take an appropriate action.

First, check the alarm number and STATUS display indicated on your amplifier with each list (alarm numbers in the list are those for the CNC) in Chapter 2 to find the corresponding detailed information in Chapter 3. Then take an appropriate action according to the detailed information.

2 ALARM NUMBERS AND BRIEF DESCRIPTIONS

2.1 FOR Series 15i

2.1.1 Servo Alarm

Alarm No.	SV	PS	Description	Remarks
SV0027			Invalid digital servo parameter setting	3.3.6
SV0361			Pulsecoder phase error (built-in)	3.3.7 (1)
SV0364			Soft phase alarm (built-in)	3.3.7 (1)
SV0365			LED error (built-in)	3.3.7 (1)
SV0366			Pulse error (built-in)	3.3.7 (1)
SV0367			Count error (built-in)	3.3.7 (1)
SV0368			Serial data error (built-in)	3.3.7 (3)
SV0369			Data transfer error (built-in)	3.3.7 (3)
SV0380			LED error (separate)	3.3.7 (2)
SV0381			Pulsecoder phase error (separate)	3.3.7 (2)
SV0382			Count error (separate)	3.3.7 (2)
SV0383			Pulse error (separate)	3.3.7 (2)
SV0384			Soft phase alarm (separate)	3.3.7 (2)
SV0385			Serial data error (separate)	3.3.7 (3)
SV0386			Data transfer error (separate)	3.3.7 (3)
SV0387			Sensor error (separate)	3.3.7 (2)
SV0421			Excessive semi-full error	3.3.8
SV0430			Servo motor overheat	3.3.5
SV0431		3	Converter: main circuit overload	3.1.3
SV0432		6	Converter: control power supply undervoltage	3.1.6
SV0433		4	Converter: DC link undervoltage	3.1.4
SV0434	2		Inverter: control power supply undervoltage	3.2
SV0435	5		Inverter: DC link undervoltage	3.2
SV0436			Soft thermal (OVC)	3.3.3
SV0437		1	Converter: input circuit overcurrent	3.1.1
SV0438	b		Inverter: motor current alarm (L axis)	3.2
SV0438	c		Inverter: motor current alarm (M axis)	3.2
SV0438	d		Inverter: motor current alarm (N axis)	3.2
SV0439		7	Converter: DC link overvoltage	3.1.7
SV0440		H	Converter: Excessive deceleration power	3.1.11
SV0441			Current offset error	3.3.8
SV0442		5	Converter: DC link precharge failure	3.1.5
SV0443		2	Converter: cooling fan stopped	3.1.2
SV0444	1		Inverter: internal cooling fan stopped	3.2
SV0445			Soft disconnection alarm	3.3.4
SV0446			Hard disconnection alarm	Not issued
SV0447			Hard disconnection alarm (separate)	3.3.4
SV0448			Feedback mismatch alarm	3.3.8
SV0449	8.		Inverter: IPM alarm (L axis)	3.2
SV0449	9.		Inverter: IPM alarm (M axis)	3.2
SV0449	A.		Inverter: IPM alarm (N axis)	3.2
SV0600	8		Inverter: DC link current alarm (L axis)	3.2
SV0600	9		Inverter: DC link current alarm (M axis)	3.2

Alarm No.	SV	PS	Description	Remarks
SV0600	A		Inverter: DC link current alarm (N axis)	3.2
SV0601	F		Inverter: cooling fan stopped of the radiator	3.2
SV0602	6		Inverter: overheat	3.2
SV0603	8.		Inverter: IPM alarm (OH) (L axis)	3.2
SV0603	9.		Inverter: IPM alarm (OH) (M axis)	3.2
SV0603	A.		Inverter: IPM alarm (OH) (N axis)	3.2
SV0604	P		Communication error between amplifiers	3.2
SV0605		8	Converter: Excessive regenerative power	3.1.8
SV0606		A	Converter: cooling fan stopped of the radiator	3.1.9
SV0607		E	Open phase in the converter main power supply	3.1.10

2.1.2 Spindle Alarm

Alarm No.	SP	PS	Description	Remarks
SP0001	01		Motor overheat	3.4.1
SP0002	02		Excessive speed deviation	3.4.2
SP0003	03		DC link fuse blown	3.4.3
SP0004	04	E	Open phase in the converter main power supply	3.1.10
SP0006	06		Temperature sensor disconnected	3.4.4
SP0007	07		Excessive speed	3.4.5
SP0009	09		Main circuit overload/IPM overheat	3.4.6
SP0010	10		Low power supply input voltage	3.4.7
SP0011	11	7	Converter: DC link overvoltage	3.1.7
SP0012	12		DC link overcurrent/IPM alarm	3.4.8 3.5.1
SP098x	13		CPU internal data memory error	3.4.9
SP0014	14		Amplifier ID not registered	3.4.10
SP0015	15		Output switching/spindle switching alarm	3.4.11
SP0017	17		Amplifier ID data error	3.4.13
SP098x	18		Program sum check error	3.4.14
SP098x	19		Excessive offset of the phase U current detection circuit	3.4.15
SP098x	20		Excessive offset of the phase V current detection circuit	3.4.15
SP0021	21		Position sensor polarity setting incorrect	3.4.16
SP0022	22		Spindle amplifier current overload	3.4.17
SP022x	24		Serial transfer data error	3.4.18
SP0027	27		Position coder disconnected	3.4.19
SP0029	29		Short-period overload	3.4.20
SP0030	30	1	Overcurrent in the converter input circuit	3.1.1
SP0031	31		Motor lock alarm	3.4.21
SP0032	32		Serial communication LSI RAM error	3.4.22
SP0033	33	5	Converter: DC link precharge failure	3.1.5
SP0034	34		Parameter data out of the specifiable range	3.4.23
SP0035	35		Gear ratio parameter error	3.5.2
SP0036	36		Error counter overflow	3.4.24
SP0037	37		Speed detector parameter error	3.4.25
SP0041	41		Position coder one-rotation signal detection error	3.4.26
SP0042	42		Position coder one-rotation signal not detected	3.4.27
SP0043	43		Position coder signal for differential speed mode disconnected	3.4.28
SP0046	46		Position sensor one-rotation signal detection error during thread cutting	3.4.29
SP0047	47		Position coder signal error	3.4.30
SP0049	49		Overflow of converted motor speed for differential spindle speed control	3.4.31

2.ALARM NUMBERS AND

BRIEF DESCRIPTIONS

TROUBLESHOOTING

B-65285EN/04

Alarm No.	SP	PS	Description	Remarks
SP0050	50		Excessive speed command calculation value during spindle synchronization	3.1.4
SP0051	51	4	Converter: DC link undervoltage	3.4.33
SP0052	52		ITP signal error I	3.4.33
SP0053	53		ITP signal error II	3.4.34
SP0054	54		Current overload alarm	3.4.35
SP0055	55		Abnormal switching status of power leads	3.4.36
SP0056	56		Internal cooling fan stopped	3.1.11
SP0057	57	H	Converter: excessive deceleration power	3.1.3
SP0058	58	3	Converter: main circuit overload	3.1.2
SP0059	59	2	Converter: cooling fan stopped	3.4.37
SP0061	61		Excessive semi-closed loop/closed loop position error alarm	3.4.38
SP0065	65		Abnormal travel distance in magnetic pole determination operation	3.4.39
SP0066	66		Communication alarm between spindle and amplifier	3.4.45
SP0069	69		Safety speed exceeded	3.4.46
SP0070	70		Abnormal axis data	3.4.47
SP0071	71		Abnormal safety parameter	3.4.51
SP0072	72		Motor speed mismatch	3.4.52
SP0073	73		Motor sensor disconnected	3.4.53
SP0074	74		CPU test alarm	3.4.54
SP0075	75		CRC test alarm	3.4.55
SP0076	76		Safety function not executed	3.4.56
SP0077	77		Axis number mismatch	3.4.57
SP0078	78		Safety parameter mismatch	3.4.58
SP0079	79		Abnormal initial test operation	3.4.59
SP0080	80		Destination amplifier error in inter-spindle amplifier communication	3.4.60
SP0081	81		Motor sensor one-rotation signal detection error	3.4.61
SP0082	82		Motor sensor one-rotation signal not detected	3.4.62
SP0083	83		Motor sensor signal error	3.4.63
SP0084	84		Spindle sensor disconnected	3.4.64
SP0085	85		Spindle sensor one-rotation signal detection error	3.4.83
SP0086	86		Spindle sensor one-rotation signal not detected	3.4.83
SP0087	87		Spindle sensor signal error	3.4.65
SP0088	88		Cooling fan stopped of the radiator	3.4.65
SP0089	89		Sub module SM (SSM) error	3.4.65
SP0090	90		Unexpected rotation alarm	3.4.66
SP0091	91		Pole position count miss alarm	3.1.6
SP0092	92		Velocity command-dependent overspeed alarm	3.1.8
SP0097 (MODEL A)			Other spindle amplifier alarm	3.1.9
SP0097x	A		Program ROM error	3.4.67
SP0097x	A1		Program ROM error	3.4.67
SP0097x	A2		Program ROM error	3.4.67
SP0098			Other converter alarm	3.4.68
SP0098 (MODEL A)	b0		Communication error between amplifiers	3.4.74
SP0098 (MODEL A)	b1	6	Converter: control power supply low voltage	3.4.76
SP0098 (MODEL A)	b2	8	Converter: excessive regenerative power	3.4.77
SP0098 (MODEL A)	b3	2	Converter: cooling fan stopped of the radiator	3.4.78
SP0110 (MODEL B)	b0		Communication error between amplifiers	3.4.79

Alarm No.	SP	PS	Description	Remarks
SP0111 (MODEL B)	b1	6	Converter: control power supply low voltage	3.4.80
SP0112 (MODEL B)	b2	8	Converter: excessive regenerative power	3.4.81
SP0113 (MODEL B)	b3	A	Converter: cooling fan stopped of the radiator	3.4.82
SP0120 (MODEL B)	C0		Communication data alarm	3.4.51
SP0121 (MODEL B)	C1		Communication data alarm	3.4.51
SP0122 (MODEL B)	C2		Communication data alarm	3.4.51
SP0123 (MODEL B)	C3		Spindle switching circuit error	3.4.52
SP0130	d0		Speed polarity error in torque tandem operation	3.4.74
SP0132	d2		Serial data error	3.4.76
SP0133	d3		Data transfer error	3.4.77
SP0134	d4		Soft phase alarm	3.4.78
SP0137	d7		Device communication error	3.4.79
SP0139	d9		Pulse error alarm	3.4.80
SP0140	E0		Count error alarm	3.4.81
SP0141	E1		Serial sensor one-rotation signal not detected	3.4.82

2.2 FOR Series 16i, 18i, 20i, 21i, 0i, AND Power Mate i

2.2.1 Servo Alarm

Alarm No.	SV	PS	Description	Remarks
361			Pulsecoder phase error (built-in)	3.3.7 (1)
364			Soft phase alarm (built-in)	3.3.7 (1)
365			LED error (built-in)	3.3.7 (1)
366			Pulse error (built-in)	3.3.7 (1)
367			Count error (built-in)	3.3.7 (1)
368			Serial data error (built-in)	3.3.7 (3)
369			Data transfer error (built-in)	3.3.7 (3)
380			LED error (separate)	3.3.7 (2)
381			Pulsecoder phase error (separate)	3.3.7 (2)
382			Count error (separate)	3.3.7 (2)
383			Pulse error (separate)	3.3.7 (2)
384			Soft phase alarm (separate)	3.3.7 (2)
385			Serial data error (separate)	3.3.7 (3)
386			Data transfer error (separate)	3.3.7 (3)
387			Sensor error (separate)	3.3.7 (2)
417			Invalid parameter	3.3.6
421			Excessive semi-full error	3.3.8
430			Servomotor overheat	3.3.5
431		3	Converter: main circuit overload	3.1.3
432		6	Converter: control undervoltage	3.1.6
433		4	Converter: DC link undervoltage	3.1.4
434	2		Inverter: control power supply undervoltage	3.2
435	5		Inverter: DC link undervoltage	3.2
436			Soft thermal (OVC)	3.3.3
437		1	Converter: input circuit overcurrent	3.1.1
438	b		Inverter: motor current alarm (L axis)	3.2
438	c		Inverter: motor current alarm (M axis)	3.2
438	d		Inverter: motor current alarm (N axis)	3.2
439		7	Converter: DC link overvoltage	3.1.7
440		H	Converter: excessive deceleration power	2.1.11
441			Current offset error	3.3.8
442		5	Converter: DC link precharge failure	3.1.5
443		2	Converter: cooling fan stopped	3.1.2
444	1		Inverter: internal cooling fan stopped	3.2
445			Soft disconnection alarm	3.3.4
447			Hard disconnection alarm (separate)	3.3.4
448			Feedback mismatch alarm	3.3.8
449	8.		Inverter: IPM alarm (L axis)	3.2
449	9.		Inverter: IPM alarm (M axis)	3.2
449	A.		Inverter: IPM alarm (N axis)	3.2
453			Soft disconnection alarm (α Pulsecoder)	3.3.4
600	8.		Inverter: DC link current alarm (L axis)	3.2
600	9.		Inverter: DC link current alarm (M axis)	3.2
600	A.		Inverter: DC link current alarm (N axis)	3.2
601	F		Inverter: cooling fan stopped of the radiator	3.2
602	6		Inverter: overheat	3.2
603	8.		Inverter: IPM alarm (OH) (L axis)	3.2
603	9.		Inverter: IPM alarm (OH) (M axis)	3.2
603	A.		Inverter: IPM alarm (OH) (N axis)	3.2

Alarm No.	SV	PS	Description	Remarks
604	P		Communication error between amplifiers	3.2
605		8	Converter: excessive regenerative power	3.1.8
606		A	Converter: cooling fan stopped of the radiator	3.1.9
607		E	Open phase in the converter main power supply	3.1.10
SV0654			DB relay error	3.2.14

2.2.2 Spindle Alarm

Alarm No.	SP	PS	Description	Remarks	
9001	7n01	01	Motor overheat	3.4.1	
9002	7n02	02	Excessive speed deviation	3.4.2	
9003	7n03	03	DC link fuse blown	3.4.3	
9004	7n04	04	E	Open phase in the converter main power supply	3.1.10
9006	7n06	06	Temperature sensor disconnected	3.4.4	
9007	7n07	07	Excessive speed	3.4.5	
9009	7n09	09	Main circuit overload/IPM overheat	3.4.6	
9010	7n10	10	Low power supply input voltage	3.4.7	
9011	7n11	11	7	Converter: DC link overvoltage	3.1.7
9012	7n12	12	DC link overcurrent/IPM alarm	3.4.8 3.5.1	
750		13	CPU internal data memory error	3.4.9	
9014	7n14	14	Amplifier ID not registered	3.4.10	
9015	7n15	15	Speed range switching/spindle switching alarm	3.4.8	
9016	7n16	16	RAM error	3.4.12	
9017	7n17	17	Amplifier ID data error	3.4.13	
750		18	Program sum check error	3.4.14	
750		19	Excessive offset of the phase U current detection circuit	3.4.15	
750		20	Excessive offset of the phase V current detection circuit	3.4.15	
9021	7n21	21	Position sensor polarity setting incorrect	3.4.11	
9022	7n22	22	Spindle amplifier current overload	3.4.17	
749		24	Serial transfer data error	3.4.18	
9027	7n27	27	Position coder disconnected	3.4.19	
9029	7n29	29	Short-time overload	3.4.20	
9030	7n30	30	1	Overcurrent in the converter input circuit	3.1.1
9031	7n31	31	Motor lock alarm	3.4.21	
9032	7n32	32	Serial communication LSI RAM error	3.4.22	
9033	7n33	33	5	Converter: DC link precharge failure	3.1.5
9034	7n34	34	Parameter data out of the specifiable range	3.4.23	
9035	7n35	35	Gear ratio parameter error	3.5.2	
9036	7n36	36	Error counter overflow	3.4.24	
9037	7n37	37	Speed detector parameter error	3.4.25	
9041	7n41	41	Position coder one-rotation signal detection error	3.4.26	
9042	7n42	42	Position coder one-rotation signal not detected	3.4.27	
9043	7n43	43	Position coder signal for differential speed mode disconnected	3.4.28	
9046	7n46	46	Position sensor one-rotation signal detection error during thread cutting	3.4.29	
9047	7n47	47	Position coder signal error	3.4.30	
9049	7n49	49	Overflow of converted motor speed for differential spindle speed control	3.4.31	
9050	7n50	50	Excessive speed command calculation value during spindle synchronous control	3.4.32	
9051	7n51	51	4	Converter: DC link low voltage	3.1.4
9052	7n52	52	ITP signal error I	3.4.33	

2.ALARM NUMBERS AND BRIEF DESCRIPTIONS

TROUBLESHOOTING

B-65285EN/04

Alarm No.	SP	PS	Description	Remarks
9053	7n53	53	ITP signal error II	3.4.33
9054	7n54	54	Current overload alarm	3.4.34
9055	7n55	55	Abnormal switching status of power leads	3.4.35
9056	7n56	56	Internal cooling fan stopped	3.4.36
9057	7n57	57	H Converter: excessive deceleration power	3.1.11
9058	7n58	58	3 Converter: main circuit overload	3.1.3
9059	7n59	59	2 Converter: cooling fan stopped	3.1.2
9061	7n61	61	Excessive semi-closed loop/closed loop position error alarm	3.4.37
9065	7n65	65	Abnormal travel distance in magnetic pole determination operation	3.4.38
9066	7n66	66	Communication alarm between Spindle Amplifiers	3.4.29
9067	7n67	67	Reference position return command in the EGB mode	3.4.40
9069	7n69	69	Safety speed exceeded	3.4.30
9070	7n70	70	Abnormal axis data	3.4.31
9071	7n71	71	Abnormal safety parameter	3.4.32
9072	7n72	72	Motor speed mismatch	3.4.33
9073	7n73	73	Motor sensor disconnected	3.4.34
9074	7n74	74	CPU test alarm	3.4.35
9075	7n75	75	CRC test alarm	3.4.36
9076	7n76	76	Safety function not executed	3.4.37
9077	7n77	77	Axis number mismatch	3.4.38
9078	7n78	78	Safety parameter mismatch	3.4.39
9079	7n79	79	Abnormal initial test operation	3.4.40
9080	7n80	80	Destination amplifier error in inter-spindle amplifier communication	3.4.52
9081	7n81	81	Motor sensor one-rotation signal detection error	3.4.41
9082	7n82	82	Motor sensor one-rotation signal not detected	3.4.42
9083	7n83	83	Motor sensor signal error	3.4.43
9084	7n84	84	Spindle sensor disconnected	3.4.44
9085	7n85	85	Spindle sensor one-rotation signal detection error	3.4.45
9086	7n86	86	Spindle sensor one-rotation signal not detected	3.4.46
9087	7n87	87	Spindle sensor signal error	3.4.47
9088	7n88	88	Cooling fan stopped of the radiator	3.4.48
9089	7n89	89	Sub module SM (SSM) error	3.4.61
9090	7n90	90	Unexpected rotation alarm	3.4.62
9091	7n91	91	Pole position count miss alarm	3.4.63
9092	7n92	92	Velocity command-dependent overspeed alarm	3.4.64
	7n97		Other spindle amplifier alarm	3.4.52
	7n98		Other converter alarm	3.4.52
749	A		Program ROM error	3.4.65
749	A1		Program ROM error	3.4.65
749	A2		Program ROM error	3.4.65
9110	7n98	b0	Communication error between amplifiers	3.4.50
9111	7n98	b1	6 Converter: control power supply low voltage	3.1.6
9112	7n98	b2	8 Converter: excessive regenerative power	3.1.8
9113	7n98	b3	A Converter: cooling fan stopped of the radiator	3.1.9
9120		C0	Communication data alarm	3.4.51
9121		C1	Communication data alarm	3.4.51
9122		C2	Communication data alarm	3.4.51
9123		C3	Spindle switching circuit error	3.4.52
9124	7n97	C4	Invalid learning control velocity command	3.4.69
9125	7n97	C5	Invalid dynamic characteristic compensation degree	3.4.70
9127	7n97	C7	Invalid learning cycle	3.4.71
9128	7n97	C8	Excessive speed deviation alarm in spindle synchronization	3.4.72
9129	7n97	C9	Excessive position error alarm in spindle synchronization	3.4.73

Alarm No.		SP	PS	Description	Remarks
9130	7n97	d0		Speed polarity error in torque tandem operation	3.4.74
9131	7n97	d1		Spindle adjustment function alarm	3.4.75
9132	7n97	d2		Serial data error	3.4.76
9133	7n97	d3		Data transfer error	3.4.77
9134	7n97	d4		Soft phase alarm	3.4.78
9137	7n97	d7		Device communication error	3.4.79
9139	7n97	d9		Pulse error alarm	3.4.80
9140	7n97	E0		Count error alarm	3.4.81
9141	7n97	E1		Serial sensor one-rotation signal not detected	3.4.82
756, 766				Abnormal axis data	3.4.83

* n represents a spindle number.

2.3 FOR Series 30i/ 31i/32i

2.3.1 Servo Alarm

Alarm No.	SV	PS	Description	Remarks
SV0361			Pulsecoder phase error (built-in)	3.3.7 (1)
SV0364			Soft phase alarm (built-in)	3.3.7 (1)
SV0365			LED error (built-in)	3.3.7 (1)
SV0366			Pulse error (built-in)	3.3.7 (1)
SV0367			Count error (built-in)	3.3.7 (1)
SV0368			Serial data error (built-in)	3.3.7 (3)
SV0369			Data transfer error (built-in)	3.3.7 (3)
SV0380			LED error (separate)	3.3.7 (2)
SV0381			Pulsecoder phase error (separate)	3.3.7 (2)
SV0382			Count error (separate)	3.3.7 (2)
SV0383			Pulse error (separate)	3.3.7 (2)
SV0384			Soft phase alarm (separate)	3.3.7 (2)
SV0385			Serial data error (separate)	3.3.7 (3)
SV0386			Data transfer error (separate)	3.3.7 (3)
SV0387			Sensor error (separate)	3.3.7 (2)
SV0401			V ready off	I 4.2.2
SV0417			Invalid servo parameter	3.3.6
SV0421			Excessive semi-full error	3.3.8
SV0430			Servo motor overheat	3.3.5
SV0431		3	Converter: main circuit overload	3.1.3
SV0432		6	Converter: control power supply undervoltage	3.1.6
SV0433		4	Converter: DC link undervoltage	3.1.4
SV0434	2		Inverter: control power supply undervoltage	3.2
SV0435	5		Inverter: DC link undervoltage	3.2
SV0436			Soft thermal (OVC)	3.3.3
SV0437		1	Converter: input circuit overcurrent	3.1.1
SV0438	b		Inverter: motor current alarm (L axis)	3.2
SV0438	C		Inverter: motor current alarm (M axis)	3.2
SV0438	d		Inverter: motor current alarm (N axis)	3.2
SV0439		7	Converter: DC link overvoltage	3.1.7
SV0440		H	Converter: Excessive deceleration power	2.1.11
SV0441			Current offset error	3.3.8
SV0442		5	Converter: DC link precharge failure	3.1.5
SV0443		2	Converter: cooling fan stopped	3.1.2
SV0444	1		Inverter: internal cooling fan stopped	3.2
SV0445			Soft disconnection alarm	3.3.4
SV0447			Hard disconnection alarm (separate)	3.3.4
SV0448			Feedback mismatch alarm	3.3.8
SV0449	8.		Inverter: IPM alarm (L axis)	3.2
SV0449	9.		Inverter: IPM alarm (M axis)	3.2
SV0449	A.		Inverter: IPM alarm (N axis)	3.2
SV0453			α Pulsecoder soft disconnection	3.3.4
SV0600	8		Inverter: DC link current alarm (L axis)	3.2
SV0601	F		Inverter: cooling fan stopped of the radiator	3.2
SV0602	6		Inverter: overheat	3.2
SV0603	8.		Inverter: IPM alarm (OH) (L axis)	3.2
SV0603	9.		Inverter: IPM alarm (OH) (M axis)	3.2
SV0603	A.		Inverter: IPM alarm (OH) (N axis)	3.2
SV0604	P		Communication error between amplifiers	3.2

Alarm No.	SV	PS	Description	Remarks
SV0605		8	Converter: Excessive regenerative power	3.1.8
SV0606		A	Converter: cooling fan stopped of the radiator	3.1.9
SV0607		E	Open phase in the converter main power supply	3.1.10
SV0654			DB relay error	3.2.14

2.3.2 Spindle Alarm

Alarm No.	SP	PS	Description	Remarks
SP9001	01		Motor overheat	3.4.1
SP9002	02		Excessive speed deviation	3.4.2
SP9003	03		DC link fuse blown	3.4.3
SP9004	04	E	Open phase in the converter main power supply	3.1.10
SP9006	06		Temperature sensor disconnected	3.4.4
SP9007	07		Excessive speed	3.4.5
SP9009	09		Main circuit overload/IPM overheat	3.4.6
SP9010	10		Low power supply input voltage	3.4.7
SP9011	11	7	Converter: DC link overvoltage	3.1.7
SP9012	12		DC link overcurrent/IPM alarm	3.4.8 3.5.1
SP12xx	13		CPU internal data memory error	3.4.9
SP9014	14		Amplifier ID not registered	3.4.10
SP9015	15		Output switching/spindle switching alarm	3.4.11
SP9016	16		RAM error	3.4.12
SP0017	17		Amplifier ID data error	3.4.13
SP12xx	18		Program sum check error	3.4.14
SP12xx	19		Excessive offset of the phase U current detection circuit	3.4.15
SP12xx	20		Excessive offset of the phase V current detection circuit	3.4.15
SP9021	21		Position sensor polarity setting incorrect	3.4.16
SP9022	22		Spindle amplifier current overload	3.4.17
SP12xx	24		Serial transfer data error	3.4.18
SP9027	27		Position coder disconnected	3.4.19
SP9029	29		Short-period overload	3.4.20
SP9030	30	1	Overcurrent in the converter input circuit	3.1.1
SP9031	31		Motor lock alarm	3.4.21
SP9032	32		Serial communication LSI RAM error	3.4.22
SP9033	33	5	Converter: DC link precharge failure	3.1.5
SP9034	34		Parameter data out of the specifiable range	3.4.23
SP9035	35		Gear ratio parameter error	3.5.2
SP9036	36		Error counter overflow	3.4.24
SP9037	37		Speed detector parameter error	3.4.25
SP9041	41		Position coder one-rotation signal detection error	3.4.26
SP9042	42		Position coder one-rotation signal not detected	3.4.27
SP9043	43		Position coder signal for differential speed mode disconnected	3.4.28
SP9046	46		Position sensor one-rotation signal detection error during thread cutting	3.4.29
SP9047	47		Position coder signal error	3.4.30
SP9049	49		Overflow of converted motor speed for differential spindle speed control	3.4.31
SP9050	50		Excessive speed command calculation value in spindle synchronization	3.4.32
SP9051	51	4	Converter: DC link undervoltage	3.1.4
SP9052	52		ITP signal error I	3.4.33
SP9053	53		ITP signal error II	3.4.33
SP9054	54		Current overload alarm	3.4.34
SP9055	55		Abnormal switching status of power leads	3.4.35
SP9056	56		Internal cooling fan stopped	3.4.36
SP9057	57	H	Converter: excessive deceleration power	3.1.11

2.ALARM NUMBERS AND

BRIEF DESCRIPTIONS

TROUBLESHOOTING

B-65285EN/04

Alarm No.	SP	PS	Description	Remarks
SP9058	58	3	Converter: main circuit overload	3.1.3
SP9059	59	2	Converter: cooling fan stopped	3.1.2
SP9061	61		Excessive semi-closed loop/closed loop position error alarm	3.4.37
SP9065	65		Abnormal travel distance in magnetic pole determination operation	3.4.38
SP9066	66		Communication alarm between spindle and amplifier	3.4.39
SP9067	67		Reference position return command in the EGB mode	3.4.40
SP9069	69		Safety speed exceeded	3.4.41
SP9070	70		Abnormal axis data	3.4.42
SP9071	71		Abnormal safety parameter	3.4.43
SP9072	72		Motor speed mismatch	3.4.44
SP9073	73		Motor sensor disconnected	3.4.45
SP9074	74		CPU test alarm	3.4.46
SP9075	75		CRC test alarm	3.4.47
SP9076	76		Safety function not executed	3.4.48
SP9077	77		Axis number mismatch	3.4.49
SP9078	78		Safety parameter mismatch	3.4.50
SP9079	79		Abnormal initial test operation	3.4.51
SP9080	80		Destination amplifier error in inter-spindle amplifier communication	3.4.52
SP9081	81		Motor sensor one-rotation signal detection error	3.4.53
SP9082	82		Motor sensor one-rotation signal not detected	3.4.54
SP9083	83		Motor sensor signal error	3.4.55
SP9084	84		Spindle sensor disconnected	3.4.56
SP9085	85		Spindle sensor one-rotation signal detection error	3.4.57
SP9086	86		Spindle sensor one-rotation signal not detected	3.4.58
SP9087	87		Spindle sensor signal error	3.4.59
SP9088	88		Cooling fan stopped of the radiator	3.4.60
SP9089	89		Sub module SM (SSM) error	3.4.61
SP9090	90		Unexpected rotation alarm	3.4.62
SP9091	91		Pole position count miss alarm	3.4.63
SP9092	92		Velocity command-dependent overspeed alarm	3.4.64
SP12xx	A		Program ROM error	3.4.65
SP12xx	A1		Program ROM error	3.4.65
SP12xx	A2		Program ROM error	3.4.65
SP9110	b0		Communication error between amplifiers	3.4.66
SP9111	b1	6	Converter: control power supply low voltage	3.1.6
SP9112	b2	8	Converter: excessive regenerative power	3.1.8
SP9113	b3	A	Converter: cooling fan stopped of the radiator	3.1.9
SP9120	C0		Communication data alarm	3.4.67
SP9121	C1		Communication data alarm	3.4.67
SP9122	C2		Communication data alarm	3.4.67
SP9123	C3		Spindle switching circuit error	3.4.68
SP9124	C4		Invalid learning control velocity command	3.4.69
SP9125	C5		Invalid dynamic characteristic compensation degree	3.4.70
SP9127	C7		Invalid learning cycle	3.4.71
SP9128	C8		Excessive speed deviation alarm in spindle synchronization	3.4.72
SP9129	C9		Excessive position error alarm in spindle synchronization	3.4.73
SP9130	d0		Speed polarity error in torque tandem operation	3.4.74
SP9131	d1		Spindle adjustment function alarm	3.4.75
SP9132	d2		Serial data error	3.4.76
SP9133	d3		Data transfer error	3.4.77
SP9134	d4		Soft phase alarm	3.4.78
SP9137	d7		Device communication error	3.4.79
SP9139	d9		Pulse error alarm	3.4.80
SP9140	E0		Count error alarm	3.4.81

Alarm No.	SP	PS	Description	Remarks
SP9141	E1		Serial sensor one-rotation signal not detected	3.4.82

2.4 FOR Series 0i-D

2.4.1 Servo Alarm

Alarm No.	SV	PS	Description	Remarks
SV0361			Pulsecoder phase error (built-in)	3.3.7 (1)
SV0364			Soft phase alarm (built-in)	3.3.7 (1)
SV0365			LED error (built-in)	3.3.7 (1)
SV0366			Pulse error (built-in)	3.3.7 (1)
SV0367			Count error (built-in)	3.3.7 (1)
SV0368			Serial data error (built-in)	3.3.7 (3)
SV0369			Data transfer error (built-in)	3.3.7 (3)
SV0380			LED error (separate)	3.3.7 (2)
SV0381			Pulsecoder phase error (separate)	3.3.7 (2)
SV0382			Count error (separate)	3.3.7 (2)
SV0383			Pulse error (separate)	3.3.7 (2)
SV0384			Soft phase alarm (separate)	3.3.7 (2)
SV0385			Serial data error (separate)	3.3.7 (3)
SV0386			Data transfer error (separate)	3.3.7 (3)
SV0387			Sensor error (separate)	3.3.7 (2)
SV0401			V ready off	I 4.2.2
SV0417			Invalid servo parameter	3.3.6
SV0421			Excessive semi-full error	3.3.8
SV0430			Servo motor overheat	3.3.5
SV0431		3	Converter: main circuit overload	3.1.3
SV0432		6	Converter: control power supply undervoltage	3.1.6
SV0433		4	Converter: DC link undervoltage	3.1.4
SV0434	2		Inverter: control power supply undervoltage	3.2
SV0435	5		Inverter: DC link undervoltage	3.2
SV0436			Soft thermal (OVC)	3.3.3
SV0437		1	Converter: input circuit overcurrent	3.1.1
SV0438	b		Inverter: motor current alarm (L axis)	3.2
SV0438	C		Inverter: motor current alarm (M axis)	3.2
SV0438	d		Inverter: motor current alarm (N axis)	3.2
SV0439		7	Converter: DC link overvoltage	3.1.7
SV0440		H	Converter: Excessive deceleration power	2.1.11
SV0441			Current offset error	3.3.8
SV0442		5	Converter: DC link precharge failure	3.1.5
SV0443		2	Converter: cooling fan stopped	3.1.2
SV0444	1		Inverter: internal cooling fan stopped	3.2
SV0445			Soft disconnection alarm	3.3.4
SV0447			Hard disconnection alarm (separate)	3.3.4
SV0448			Feedback mismatch alarm	3.3.8
SV0449	8.		Inverter: IPM alarm (L axis)	3.2
SV0449	9.		Inverter: IPM alarm (M axis)	3.2
SV0449	A.		Inverter: IPM alarm (N axis)	3.2
SV0453			α Pulsecoder soft disconnection	3.3.4
SV0600	8		Inverter: DC link current alarm (L axis)	3.2
SV0601	F		Inverter: cooling fan stopped of the radiator	3.2
SV0602	6		Inverter: overheat	3.2
SV0603	8.		Inverter: IPM alarm (OH) (L axis)	3.2

2.ALARM NUMBERS AND

BRIEF DESCRIPTIONS

TROUBLESHOOTING

B-65285EN/04

Alarm No.	SV	PS	Description	Remarks
SV0603	9.		Inverter: IPM alarm (OH) (M axis)	3.2
SV0603	A.		Inverter: IPM alarm (OH) (N axis)	3.2
SV0604	P		Communication error between amplifiers	3.2
SV0605		8	Converter: Excessive regenerative power	3.1.8
SV0606		A	Converter: cooling fan stopped of the radiator	3.1.9
SV0607		E	Open phase in the converter main power supply	3.1.10
SV0654			DB relay error	3.2.14

2.4.2 Spindle Alarm

Alarm No.	SP	PS	Description	Remarks
SP9001	01		Motor overheat	3.4.1
SP9002	02		Excessive speed deviation	3.4.2
SP9003	03		DC link fuse blown	3.4.3
SP9004	04	E	Open phase in the converter main power supply	3.1.10
SP9006	06		Temperature sensor disconnected	3.4.4
SP9007	07		Excessive speed	3.4.5
SP9009	09		Main circuit overload/IPM overheat	3.4.6
SP9010	10		Low power supply input voltage	3.4.7
SP9011	11	7	Converter: DC link overvoltage	3.1.7
SP9012	12		DC link overcurrent/IPM alarm	3.4.8 3.5.1
SP12xx	13		CPU internal data memory error	3.4.9
SP9014	14		Amplifier ID not registered	3.4.10
SP9015	15		Output switching/spindle switching alarm	3.4.11
SP9016	16		RAM error	3.4.12
SP0017	17		Amplifier ID data error	3.4.13
SP12xx	18		Program sum check error	3.4.14
SP12xx	19		Excessive offset of the phase U current detection circuit	3.4.15
SP12xx	20		Excessive offset of the phase V current detection circuit	3.4.15
SP9021	21		Position sensor polarity setting incorrect	3.4.16
SP9022	22		Spindle amplifier current overload	3.4.17
SP12xx	24		Serial transfer data error	3.4.18
SP9027	27		Position coder disconnected	3.4.19
SP9029	29		Short-period overload	3.4.20
SP9030	30	1	Overcurrent in the converter input circuit	3.1.1
SP9031	31		Motor lock alarm	3.4.21
SP9032	32		Serial communication LSI RAM error	3.4.22
SP9033	33	5	Converter: DC link precharge failure	3.1.5
SP9034	34		Parameter data out of the specifiable range	3.4.23
SP9035	35		Gear ratio parameter error	3.5.2
SP9036	36		Error counter overflow	3.4.24
SP9037	37		Speed detector parameter error	3.4.25
SP9041	41		Position coder one-rotation signal detection error	3.4.26
SP9042	42		Position coder one-rotation signal not detected	3.4.27
SP9043	43		Position coder signal for differential speed mode disconnected	3.4.28
SP9046	46		Position sensor one-rotation signal detection error during thread cutting	3.4.29
SP9047	47		Position coder signal error	3.4.30
SP9049	49		Overflow of converted motor speed for differential spindle speed control	3.4.31
SP9050	50		Excessive speed command calculation value in spindle synchronization	3.4.32
SP9051	51	4	Converter: DC link undervoltage	3.1.4
SP9052	52		ITP signal error I	3.4.33
SP9053	53		ITP signal error II	3.4.33
SP9054	54		Current overload alarm	3.4.34

Alarm No.	SP	PS	Description	Remarks
SP9055	55		Abnormal switching status of power leads	3.4.35
SP9056	56		Internal cooling fan stopped	3.4.36
SP9057	57	H	Converter: excessive deceleration power	3.1.11
SP9058	58	3	Converter: main circuit overload	3.1.3
SP9059	59	2	Converter: cooling fan stopped	3.1.2
SP9061	61		Excessive semi-closed loop/closed loop position error alarm	3.4.37
SP9065	65		Abnormal travel distance in magnetic pole determination operation	3.4.38
SP9066	66		Communication alarm between spindle and amplifier	3.4.39
SP9069	69		Safety speed exceeded	3.4.41
SP9070	70		Abnormal axis data	3.4.42
SP9071	71		Abnormal safety parameter	3.4.43
SP9072	72		Motor speed mismatch	3.4.44
SP9073	73		Motor sensor disconnected	3.4.45
SP9074	74		CPU test alarm	3.4.46
SP9075	75		CRC test alarm	3.4.47
SP9076	76		Safety function not executed	3.4.48
SP9077	77		Axis number mismatch	3.4.49
SP9078	78		Safety parameter mismatch	3.4.50
SP9079	79		Abnormal initial test operation	3.4.51
SP9080	80		Destination amplifier error in inter-spindle amplifier communication	3.4.52
SP9081	81		Motor sensor one-rotation signal detection error	3.4.53
SP9082	82		Motor sensor one-rotation signal not detected	3.4.54
SP9083	83		Motor sensor signal error	3.4.55
SP9084	84		Spindle sensor disconnected	3.4.56
SP9085	85		Spindle sensor one-rotation signal detection error	3.4.57
SP9086	86		Spindle sensor one-rotation signal not detected	3.4.58
SP9087	87		Spindle sensor signal error	3.4.59
SP9088	88		Cooling fan stopped of the radiator	3.4.60
SP9089	89		Sub module SM (SSM) error	3.4.61
SP9090	90		Unexpected rotation alarm	3.4.62
SP9091	91		Pole position count miss alarm	3.4.63
SP9092	92		Velocity command-dependent overspeed alarm	3.4.64
SP12xx	A		Program ROM error	3.4.65
SP12xx	A1		Program ROM error	3.4.65
SP12xx	A2		Program ROM error	3.4.65
SP9110	b0		Communication error between amplifiers	3.4.66
SP9111	b1	6	Converter: control power supply low voltage	3.1.6
SP9112	b2	8	Converter: excessive regenerative power	3.1.8
SP9113	b3	A	Converter: cooling fan stopped of the radiator	3.1.9
SP9120	C0		Communication data alarm	3.4.67
SP9121	C1		Communication data alarm	3.4.67
SP9122	C2		Communication data alarm	3.4.67
SP9123	C3		Spindle switching circuit error	3.4.68
SP9128	C8		Excessive speed deviation alarm in spindle synchronization	3.4.72
SP9129	C9		Excessive position error alarm in spindle synchronization	3.4.73
SP9131	d1		Speed polarity error in torque tandem operation	3.4.75
SP9132	d2		Serial data error	3.4.76
SP9133	d3		Data transfer error	3.4.77
SP9134	d4		Soft phase alarm	3.4.78
SP9137	d7		Device communication error	3.4.79
SP9139	d9		Pulse error alarm	3.4.80
SP9140	E0		Count error alarm	3.4.81
SP9141	E1		Serial sensor one-rotation signal not detected	3.4.82

3 TROUBLESHOOTING AND ACTION

3.1 POWER SUPPLY (αiPS , αiPS_R)

If an alarm occurs, in the STATUS display, the ALM LED lights red, and the one-digit 7-segment display indicates an alarm code or warning code.

The meaning of each warning code is the same as that of the corresponding alarm code. If a warning code is displayed, an alarm condition will occur in a certain period of time. The Power Supply remains operable while the warning code stays displayed.

Example of an alarm code display

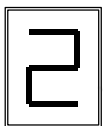

Example of a warning code display

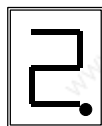

3.1.1 No LED Display (αiPS , αiPS_R)

- (1) Meaning
The 200-V control power (CX1A) is not supplied.
Alternatively, the 24-VDC power is short-circuited.
- (2) Cause and troubleshooting
 - (a) Check whether the circuit breaker for the control power supply is off.
When a lightning surge absorber is connected immediately following the circuit breaker, check whether the lightning surge absorber is short-circuited by lightning. If the lightning surge absorber is short-circuited, replace it.
 - (b) Disconnect the cable from the connector CX1A and turn the control power on. If "-" is displayed, the 24-V power to a Servo Amplifier or Spindle Amplifier may be short-circuited.
→ Detect the amplifier which causes the power to be short-circuited by sequentially connecting the cable from the Power Supply and replace it.
 - (c) Disconnect the cable from the connector CX4 and turn the control power on. If "-" is displayed, the external 24-V power may be connected to pin 3 of CX4 incorrectly.
→ Correct the connection.

3.1.2 Alarm Code 1 (αiPS)

For the αiPS -5.5 to -15 and 11HV to 18HV

- (1) Meaning
The main circuit power module (IPM) has detected an abnormal condition.
- (2) Cause and troubleshooting
 - (a) Control supply voltage decrease of the power module (IPM)
→ Replace the power unit.
 - (b) Input supply voltage imbalance
→ Check the input power supply specification.
 - (c) The specification of the AC reactor does not match the PSM in use.
→ Check the PSM and the specification of the AC reactor.

- (d) IPM failure
→ Replace the IPM.

For the α iPS15 to -55 and 30HV to 100HV

- (1) Meaning
Overcurrent flowed into the input of the main circuit.
- (2) Cause and troubleshooting
 - (a) Input supply voltage imbalance
→ Check the input power supply specification.
 - (b) The specification of the AC reactor does not match the PSM in use.
→ Check the PSM and the specification of the AC reactor.
 - (c) IGBT defective
→ Replace IGBT.

3.1.3 Alarm Code 2 (α iPS, α iPS_R)

- (1) Meaning
A cooling fan for the control circuit has stopped.
With the A06B-6140-HXXX or A06B-6150-HXXX (an upgrade version of PS), this alarm is also issued when a unit stirring fan has stopped.
- (2) Cause and troubleshooting
 - (a) Cooling fan broken
Check whether the cooling fan rotates normally.
→ Replace it.
 - (b) Internal stirring fan broken (only with an upgrade version of PS)
→ Replace it.

3.1.4 Alarm Code 3 (α iPS)

- (1) Meaning
The temperature of the main circuit heat sink has risen abnormally.
- (2) Cause and troubleshooting
 - (a) Cooling fan for the main circuit broken
Check whether the cooling fan for the main circuit rotates normally.
→ Replace it.
 - (b) Dust accumulation
→ Clean the cooling system with a vacuum cleaner or the factory air blower.
 - (c) Overload
→ Examine the operating conditions.
 - (d) Poor installation of the control printed-circuit board
→ Be sure to push the faceplate as far as it will go. (This alarm may be displayed if one of the connectors for connection between the control printed-circuit board and power printed-circuit board is detached.)

3.1.5 Alarm Code 4 (α iPS, α iPS_R)

- (1) Meaning
In the main circuit, the DC voltage (DC link) has dropped.
- (2) Cause and troubleshooting
 - (a) A small power dip has occurred.
→ Check the power supply.

3. TROUBLESHOOTING AND

ACTION

TROUBLESHOOTING

B-65285EN/04

- (b) Low input power supply voltage
→ Check the power supply specification.
- (c) The main circuit power supply may have been switched off with an emergency stop state released.
→ Check the sequence.

3.1.6 Alarm Code 5 (αiPS , αiPS_R)

- (1) Meaning
The main circuit capacitor was not recharged within the specified time.
- (2) Cause and troubleshooting
 - (a) Too many Servo Amplifier and/or Spindle Amplifier units are connected.
→ Check the specification of the PSM.
 - (b) The DC link is short-circuited.
→ Check the connection.
 - (c) The recharge current limiting resistor is defective.
→ Replace the distributing board.

3.1.7 Alarm Code 6 (αiPS , αiPS_R)

- (1) Meaning
The control power supply voltage decrease.
The 24-V power supply is abnormal in the Power Supply. (Internal fuse blown)
- (2) Cause and troubleshooting
 - (a) Input voltage decrease
→ Check the power supply.
 - (b) Power Supply broken
→ If this alarm is issued just by turning the control power on, replace the Power Supply.

3.1.8 Alarm Code 7 (αiPS , αiPS_R)

- (1) Meaning
In the main circuit, the DC voltage at the DC link is abnormally high.
- (2) Cause and troubleshooting
 - (a) Excessive regenerated power
The PSM does not have a sufficient capacity.
→ Check the specification of the PSM.
 - (b) The output impedance of the AC power source is too high.
→ Check the power source output impedance.
(Normal if the voltage variation at maximum output time is within 7%)
 - (c) The main circuit power supply may have been switched off with an emergency stop state released.
→ Check the sequence.

3.1.9 Alarm Code 8 (αiPS_R)

- (1) Meaning
There is excessive short-term regenerative power.
- (2) Cause and troubleshooting
 - (a) Insufficient regenerative resistance
→ Review the specification of the regenerative resistance.

- (b) Regenerative circuit failure
 - The regenerative circuit is abnormal. Replace the PSMR.

3.1.10 Alarm Code A (αiPS)

- (1) Meaning

A cooling fan of external cooling fin has stopped.
With the A06B-6110-HXXX or A06B-6120-HXXX, this alarm is also issued when a unit stirring fan has stopped.
- (2) Cause and troubleshooting
 - (a) Cooling fan for the radiator cooling fin broken

Check whether the cooling fan for the radiator cooling fin rotates normally.

→ Replace it.
 - (b) Unit stirring fan broken (A06B-6110-HXXX, A06B-6120-HXXX のみ)

Check whether the unit stirring fan rotates normally.

→ Replace it.
 - (c) Poor installation of the control printed-circuit board

→ Be sure to install the control printed-circuit board.
(This alarm may be issued if one of the connectors for connection between the control printed-circuit board and power printed-circuit board become loose.)
 - (d) Poor installation of the control printed-circuit board

→ Be sure to push the faceplate as far as it will go. (This alarm may be displayed if one of the connectors for connection between the control printed-circuit board and power printed-circuit board is detached.)

3.1.11 Alarm Code E (αiPS , αiPS_R)

- (1) Meaning

The input power supply is abnormal (open phase).
- (2) Cause and troubleshooting
 - (a) The input power supply has an open phase.

Check the power supply voltage.

→ If there is no problem with the power supply voltage, check the connections.

3.1.12 Alarm Code H (αiPS_R)

- (1) Meaning

The temperature of the regenerative resistor has arisen abnormally.
- (2) Cause and troubleshooting
 - (a) Regenerative resistance not detected

→ Check the wiring for the regenerative resistance.
 - (b) Insufficient regenerative resistance

→ Review the specification for the regenerative resistance.
 - (c) Excessive regenerative power

→ Reduce the frequency at which acceleration/ deceleration occurs.
 - (d) Regenerative resistor cooling fan stopped

→ Check to see if the regenerative resistor cooling fan has stopped.

3.1.13 Alarm Code P (αiPS , αiPS_R)

- (1) Meaning

Communication error between amplifiers

3.TROUBLESHOOTING AND

ACTION

TROUBLESHOOTING

B-65285EN/04

- (2) Cause and troubleshooting
 - (a) Check the connector and cable (CXA2A).
 - (b) Replace the Power Supply (control printed-circuit board).

3.2 SERVO AMPLIFIER

The following table lists alarms related to the Servo Amplifier.

See this table while comparing the CNC alarm codes presented in Chapter 2, "Alarm Numbers and Brief Description" with the LED displays of the Servo Amplifier.

Alarm	LED display	Major cause	Reference
Inverter: internal cooling fan stopped	1	- Fan not running. - Fan motor connector or cable defective - Servo Amplifier failure	3.2.1
Inverter: control power supply undervoltage	2	- The 24 V control power supply output from the Power Supply is low. - Connector/cable (CXA2A/B) defective - Servo Amplifier failure	3.2.2
Inverter: DC link undervoltage	5	- Low input voltage - DC link short-bar poor connection - Servo Amplifier failure	3.2.3
Inverter: overheat	6	- The motor is being used under a harsh condition. - The ambient temperature is high. - Servo Amplifier failure	3.2.4
Inverter: cooling fan stopped of the radiator	F	- Fan not running. - Fan motor connector or cable defective - Servo Amplifier failure	3.2.5
Communication error between amplifiers	P	- Connector/cable (CXA2A/B) defective - Servo Amplifier failure	3.2.6
Inverter: DC link current alarm (L axis)	8	- Short-circuit between power lead phases or ground fault in them - Short-circuit between motor winding phases or ground fault in them - Servo Amplifier failure	3.2.7
Inverter: IPM alarm (L axis)	8.	- Short-circuit between power lead phases or ground fault in them - Short-circuit between motor winding phases or ground fault in them - Servo Amplifier failure	3.2.8
Inverter: IPM alarm (M axis)	9.		
Inverter: IPM alarm (N axis)	A.		
Inverter: IPM alarm (OH) (L axis)	8.	- The motor is being used under a harsh condition. - The ambient temperature is high. - Servo Amplifier failure	3.2.9
Inverter: IPM alarm (OH) (M axis)	9.		
Inverter: IPM alarm (OH) (N axis)	A.		
Inverter: motor current alarm (L axis)	b	- Short-circuit between power lead phases or ground fault in them - Short-circuit between motor winding phases or ground fault in them - Incorrect motor ID setting - Servo Amplifier failure - Motor failure	3.2.10
Inverter: motor current alarm (M axis)	c		
Inverter: motor current alarm (N axis)	d		
Inverter: abnormal control power supply	Blinking -	- Connector or cable (JF*) failure - Motor failure - Servo Amplifier failure	3.2.11
Inverter: FSSB communication error (COP10B)	U	- Connector or cable (COP10B) failure - Servo Amplifier failure - CNC failure	3.2.12

Alarm	LED display	Major cause	Reference
Inverter: FSSB communication error (COP10A)	L	- Connector or cable (COP10A) failure - Servo Amplifier failure	3.2.13

3.2.1 Alarm Code 1

- (1) Meaning
Inverter: internal cooling fan stopped
- (2) Cause and troubleshooting
 - (a) Check whether there is any foreign material in the fan.
 - (b) Be sure to push the faceplate (control printed-circuit board) as far as it will go.
 - (c) Check that the fan connector is attached correctly.
 - (d) Replace the fan.
 - (e) Replace the Servo Amplifier.

3.2.2 Alarm Code 2

- (1) Meaning
Inverter: control power supply undervoltage
- (2) Cause and troubleshooting
 - (a) Check the three-phase input voltage of the amplifier (the voltage shall not be lower than 85% of the rated input voltage).
 - (b) Check the 24 V power supply voltage output from the Power Supply (the voltage shall normally not lower than 22.8 V).
 - (c) Check the connector and cable (CXA2A/B).
 - (d) Replace the Servo Amplifier.

3.2.3 Alarm Code 5

- (1) Meaning
Inverter: DC link undervoltage
- (2) Cause and troubleshooting
 - (a) Check that the screws for the DC link connection cable (bar) are tight.
 - (b) If a DC link low voltage alarm condition occurs in more than one module, see Subsection 3.1.4, "Alarm code 4" for explanations about how to troubleshoot the Power Supply.
 - (c) If a DC link low voltage alarm condition occurs in one Servo Amplifier only, be sure to push the faceplate (control printed-circuit board) of that Servo Amplifier as far as it will go.
 - (d) Replace the Servo Amplifier in which this alarm has occurred.

3.2.4 Alarm Code 6

- (1) Meaning
Inverter: overheat
- (2) Cause and troubleshooting
 - (a) Check that the motor is being used at or below its continuous rating.
 - (b) Check that the cooling capacity of the cabinet is sufficient (inspect the fans and filters).
 - (c) Check that the ambient temperature is not too high.
 - (d) Be sure to push the faceplate (control printed-circuit board) as far as it will go.
 - (e) Replace the Servo Amplifier.

3.2.5 Alarm Code F

- (1) Meaning
Inverter: cooling fan stopped of the radiator
- (2) Cause and troubleshooting
 - (a) Check whether there is any foreign material in the fan.
 - (b) Be sure to push the faceplate (control printed-circuit board) as far as it will go.
 - (c) Check that the fan connector is attached correctly.
 - (d) Replace the fan.
 - (e) Replace the Servo Amplifier.

3.2.6 Alarm Code P

- (1) Meaning
Communication error between amplifiers
- (2) Cause and troubleshooting
 - (a) Check the connector and cable (CXA2A/B).
 - (b) Replace the control printed-circuit board.
 - (c) Replace the Servo Amplifier.

3.2.7 Alarm Code 8

- (1) Meaning
Inverter: DC link current alarm
- (2) Cause and troubleshooting
 - (a) Disconnect the motor power leads from the Servo Amplifier, and release the Servo Amplifier from an emergency stop condition.
 - <1> If no abnormal DC link current alarm condition has occurred → Go to (b).
 - <2> If an abnormal DC link current alarm condition has occurred → Replace the Servo Amplifier.
 - (b) Disconnect the motor power leads from the Servo Amplifier, and check the insulation between PE and the motor power lead U, V, or W.
 - <1> If the insulation is deteriorated → Go to (c).
 - <2> If the insulation is normal → Replace the Servo Amplifier.
 - (c) Disconnect the motor from its power leads, and check whether the insulation of the motor or power leads is deteriorated.
 - <1> If the insulation of the motor is deteriorated → Replace the motor.
 - <2> If the insulation of any power lead is deteriorated → Replace the power lead.

3.2.8 Alarm Codes 8., 9., and A.

- (1) Meaning
Inverter: IPM alarm
- (2) Cause and troubleshooting
 - (a) Be sure to push the faceplate (control printed-circuit board) as far as it will go.
 - (b) Disconnect the motor power leads from the Servo Amplifier, and release the Servo Amplifier from an emergency stop condition.
 - <1> If no IPM alarm condition has occurred → Go to (b).
 - <2> If an IPM alarm condition has occurred → Replace the Servo Amplifier.
 - (c) Disconnect the motor power leads from the Servo Amplifier, and check the insulation between PE and the motor power lead U, V, or W.
 - <1> If the insulation is deteriorated → Go to (c).
 - <2> If the insulation is normal → Replace the Servo Amplifier.

- (d) Disconnect the motor from its power leads, and check whether the insulation of the motor or power leads is deteriorated.
- <1> If the insulation of the motor is deteriorated → Replace the motor.
- <2> If the insulation of any power lead is deteriorated → Replace the power lead.

3.2.9 Alarm Codes 8., 9., and A.

- (1) Meaning
Inverter: IPM alarm (OH)
- (2) Cause and troubleshooting
- (a) Be sure to push the faceplate (control printed-circuit board) as far as it will go.
- (b) Check that the heat sink cooling fan is running.
- (c) Check that the motor is being used at or below its continuous rating.
- (d) Check that the cooling capacity of the cabinet is sufficient (inspect the fans and filters).
- (e) Check that the ambient temperature is not too high.
- (f) Replace the Servo Amplifier.

3.2.10 Alarm Codes b, c, and d

- (1) Meaning
Inverter: DC link current alarm
- (2) Cause and troubleshooting
- (a) Checking the servo parameters
Referring to "FANUC AC SERVO MOTOR *αi* series Parameter Manual (B-65270EN)," check whether the following parameters have default values.

Series 15 <i>i</i>	No.1809	No.1852	No.1853
Series 16 <i>i</i> , 18 <i>i</i> , 20 <i>i</i> , 21 <i>i</i> , 0 <i>i</i> Power Mate <i>i</i>	No.2004	No.2040	No.2041

- Alternatively, if an abnormal motor current alarm condition occurs only on rapid acceleration/deceleration, it is likely that the motor is being used under too harsh a condition. Increase the acceleration/deceleration time constant, and see what will occur.
- (b) Be sure to push the faceplate (control printed-circuit board) as far as it will go.
- (c) Disconnect the motor power leads from the Servo Amplifier, and release the Servo Amplifier from an emergency stop condition.
- <1> If no abnormal motor current occurs → Go to (c).
- <2> If an abnormal motor current occurs → Replace the Servo Amplifier.
- (d) Disconnect the motor power leads from the Servo Amplifier, and check the insulation between PE and the motor power lead U, V, or W.
- <1> If the insulation is deteriorated → Go to (d).
- <2> If the insulation is normal → Replace the Servo Amplifier.
- (e) Disconnect the motor from its power leads, and check whether the insulation of the motor or power leads is deteriorated.
- <1> If the insulation of the motor is deteriorated → Replace the motor.
- <2> If the insulation of any power lead is deteriorated → Replace the power lead.

3.2.11 Alarm Code "-" Blinking

- (1) Meaning
Inverter: abnormal control power supply
- (2) Cause and troubleshooting
- (a) Disconnect the feedback cable (JF*) from the Servo Amplifier, and then switch on the power.
- <1> If blinking continues → Replace the Servo Amplifier.
- <2> If blinking stops → Go to (b).

3.TROUBLESHOOTING AND

ACTION

TROUBLESHOOTING

B-65285EN/04

- (b) Disconnect the feedback cable (JF*) from the Pulsecoder, and then switch on the power. (Keep the cable on the Servo Amplifier side connected.)
- <1> If blinking continues → Replace the cable.
 - <2> If blinking stops → Replace the motor.

3.2.12 Alarm Code U

- (1) Meaning
Inverter: FSSB communication error (COP10B) (NOTE)
- (2) Cause and troubleshooting
- (a) Replace the Servo Amplifier optical cable (COP10B) that is nearest to the CNC on which "U" is displayed (in Fig. 3.2.12, the cable between UNIT2 and UNIT3).
 - (b) Replace the Servo Amplifier that is nearest to the CNC on which "U" is displayed (in Fig. 3.2.12, UNIT3).
 - (c) Replace the COP10B-side Servo Amplifier that is nearest to the CNC on which "U" is displayed (in Fig. 3.2.12, UNIT2).
 - (d) Replace the servo card in the CNC.

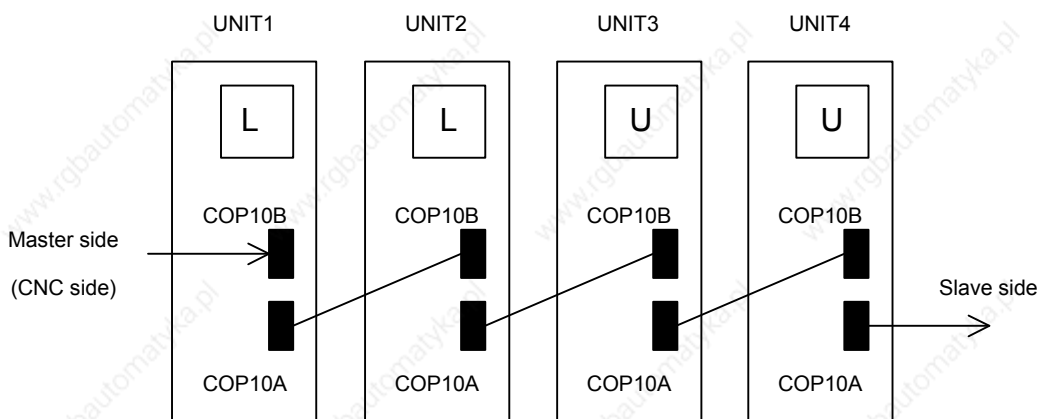

Fig. 3.2.12

NOTE

When the CNC power is turned on, "U" blinks momentarily, and then "-" steadily lights. This is not a failure, though.

3.2.13 Alarm Code L

- (1) Meaning
Inverter: FSSB communication error (COP10A)
- (2) Cause and troubleshooting
- (a) Replace the Servo Amplifier optical cable (COP10A) that is farthest to the CNC on which "L" is displayed (in Fig. 3.2.13, the cable between UNIT2 and UNIT3).
 - (b) Replace the Servo Amplifier that is farthest to the CNC on which "L" is displayed (in Fig. 3.2.13, UNIT2).
 - (c) Replace the COP10A-side Servo Amplifier that is farthest to the CNC on which "L" is displayed (in Fig. 3.2.13, UNIT3).

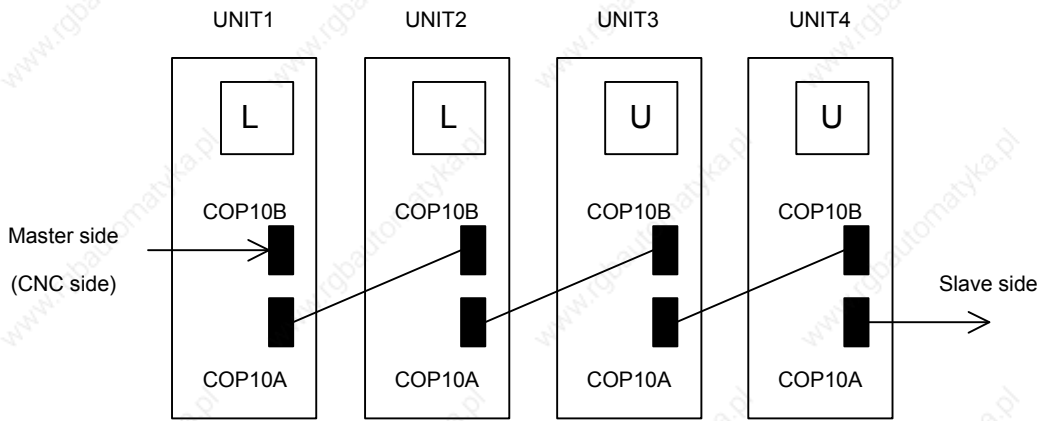

Fig. 3.2.13

3.2.14 DB Relay Error (CNC Message "Alarm SV0654")

- (1) Meaning
DB relay error
- (2) Cause and troubleshooting
 - (a) Check whether the power lead is short-circuited.
 - (b) Replace the Servo Amplifier.

3.3 SERVO SOFTWARE

If a servo alarm is issued, an alarm message is output, and details of the alarm are also displayed on the servo adjustment screen or the diagnosis screen. Using the alarm identification table given in this section, determine the alarm, and take a proper action.

3.3.1 Servo Adjustment Screen

The following procedure can be used to display the servo adjustment screen.
(The DPL/MDI of the Power Mate has no servo adjustment screen.)

● **Series 15i**

SYSTEM → [CHAPTER] → [SERVO] → [▷] → [SERVO ALARM]

● **Series 16i, 18i, 20i, 21i, 0i**

SYSTEM → [SYSTEM] → [▷] → [SV-PRM] → [SV-TUN]

If the servo setting screen does not appear, specify the following parameter, then switch the CNC off and on again.

	#7	#6	#5	#4	#3	#2	#1	#0
3111								SVS

SVS (#0)=1 (to display the servo setting screen)

Alarm detail information

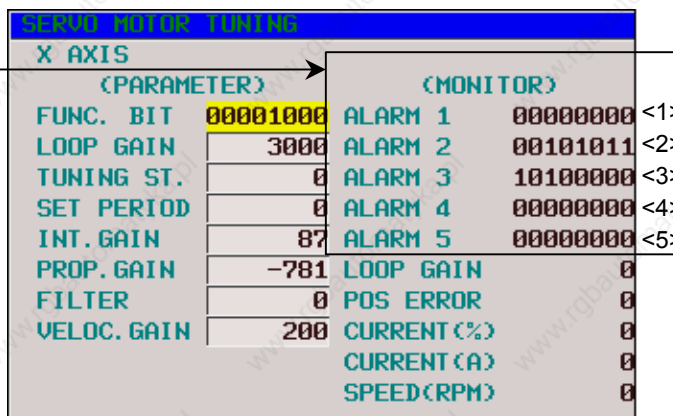

Fig. 3.3.1(a) Servo adjustment screen

Alarm detail information

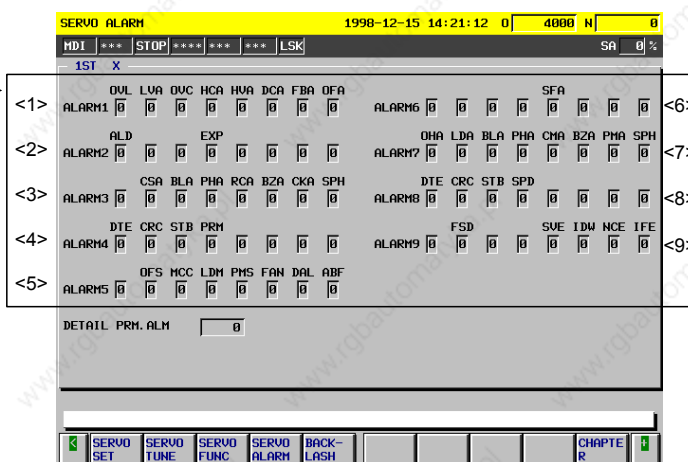

Fig. 3.3.1(b) Series 15i servo alarm screen

The table below indicates the names of the alarm bits.

Table 3.3.1 List of alarm bit names

	#7	#6	#5	#4	#3	#2	#1	#0
<1> Alarm 1	OVL	LVA	OVC	HCA	HVA	DCA	FBA	OFA
<2> Alarm 2	ALD		EXP					
<3> Alarm 3		CSA	BLA	PHA	RCA	BZA	CKA	SPH
<4> Alarm 4	DTE	CRC	STB	PRM				
<5> Alarm 5		OFS	MCC	LDM	PMS	FAN	DAL	ABF
<6> Alarm 6					SFA			
<7> Alarm 7	OHA	LDA	BLA	PHA	CMA	BZA	PMA	SPH
<8> Alarm 8	DTE	CRC	STB	SPD				
<9> Alarm 9		FSD			SVE	IDW	NCE	IFE

NOTE

The empty fields do not represent alarm codes.

3.3.2 Diagnosis Screen

The alarm items of the servo adjustment screen correspond to the diagnosis screen numbers indicated in the table below.

Table 3.3.2 Correspondence between the servo adjustment screen and diagnosis screen

Alarm No.	Series 15i	Series 16i, 18i, 21i, 0i
<1> Alarm 1	No 3014 + 20(X-1)	No 200
<2> Alarm 2	3015 + 20(X-1)	201
<3> Alarm 3	3016 + 20(X-1)	202
<4> Alarm 4	3017 + 20(X-1)	203
<5> Alarm 5	_____	204
<6> Alarm 6	_____	_____
<7> Alarm 7	_____	205
<8> Alarm 8	_____	206
<9> Alarm 9	_____	_____

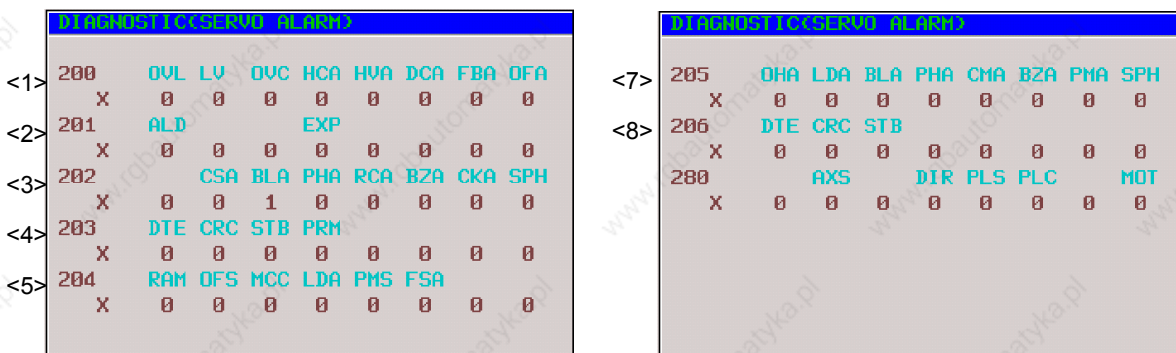

Fig. 3.3.2 Diagnosis screen

3.3.3 Overload Alarm (Soft Thermal, OVC)

(Alarm identification method)

	#7	#6	#5	#4	#3	#2	#1	#0
<1> Alarm 1	OVL	LVA	OVC	HCA	HVA	DCA	FBA	OFA

(Action)

- (1) Make sure that the motor is not vibrating.
 - ⇒ If a motor vibrates, the current flowing in it becomes more than necessary, resulting in an alarm.
- (2) Make sure that the power lead to the motor is connected correctly.
 - ⇒ If the connection is incorrect, an abnormal current flows in the motor, resulting in an alarm.
- (3) Make sure that the following parameters are set correctly.
 - ⇒ An overload alarm is issued based on the result of calculation of these parameters. Be sure to set them to the standard values. For details of the standard values, refer to the FANUC AC SERVO MOTOR α i series Parameter Manual (B-65270EN).

No. 1877 (FS15i)	Overload protection coefficient (OVC1)
No. 2062 (FS16i)	
No. 1878 (FS15i)	Overload protection coefficient (OVC2)
No. 2063 (FS16i)	
No. 1893 (FS15i)	Overload protection coefficient (OVCLMT)
No. 2065 (FS16i)	
No. 1785 (FS15i)	Overload protection coefficient (OVC21)
No. 2162 (FS16i)	

3.TROUBLESHOOTING AND

ACTION

TROUBLESHOOTING

B-65285EN/04

No. 1786 (FS15i)
No. 2163 (FS16i)

Overload protection coefficient (OVC22)

No. 1787 (FS15i)
No. 2165 (FS16i)

Overload protection coefficient (OVCLMT2)

Measure the actual current values (IR, IS) using the SERVO GUIDE, compare the values with overload duty curves in the Servo Motor Descriptions (B-65262EN), and check whether the load on the machine is too large compared with the motor capacity. If the actual current is high on acceleration/deceleration, it is likely that the time constant is too small.

3.3.4 Feedback Disconnected Alarm

(Alarm identification method)

	#7	#6	#5	#4	#3	#2	#1	#0
<1> Alarm 1	OVL	LVA	OVC	HCA	HVA	DCA	FBA	OFA
<2> Alarm 2	ALD			EXP				
<6> Alarm 6					SFA			

FBA	ALD	EXP	SFA	Alarm description	Action
1	1	1	0	Hard disconnection (separate phase A/B)	1
1	0	0	0	Soft disconnection (closed loop)	2
1	0	0	1	Soft disconnection (α i Pulsecoder)	3

(Action)

Action 1: This alarm is issued when a separate phase A/B scale is used. Check if the phase A/B detector is connected correctly.

Action 2: This alarm is issued when the position feedback pulse variation is small relative to the velocity feedback pulse variation. This means that this alarm is not issued when a semi-full is used. Check if the separate detector outputs position feedback pulses correctly. If position feedback pulses are output correctly, it is considered that the motor alone is rotating in the reverse direction at the start of machine operation because of a large backlash between the motor position and scale position.

	#7	#6	#5	#4	#3	#2	#1	#0
No. 1808 (FS15i)							TGAL	
No. 2003 (FS16i)								

TGAL (#1) 1: Uses the parameter for the soft disconnection alarm detection level.

No. 1892 (FS15i)	Soft disconnection alarm level
No. 2064 (FS16i)	

Standard setting 4: Alarm issued for a 1/8 rotation of the motor.
Increase this value.

Action 3: This alarm is issued when synchronization between the absolute position data sent from the built-in Pulsecoder and phase data is lost. Turn off the power to the CNC, then detach the Pulsecoder cable then attach it again. If this alarm is still issued, replace the Pulsecoder.

3.3.5 Overheat Alarm

(Alarm identification method)

	#7	#6	#5	#4	#3	#2	#1	#0
<1> Alarm 1	OVL	LVA	OVC	HCA	HVA	DCA	FBA	OFA
<2> Alarm 2	ALD			EXP				

OVL	ALD	EXP	Alarm description	Action
1	1	0	Motor overheat	1
1	0	0	Amplifier overheat	1

(Action)

(1) Motor overheat

First, check whether the motor temperature is high immediately after the alarm is issued. If the alarm is issued when the motor temperature is not high, the temperature detection circuit may be abnormal. Contact your FANUC service staff.

When the motor temperature is high immediately after the alarm is issued, check the following items:

(a) Check the cooling state of the motor.

<1> If the cooling state is abnormal, for example, when the cooling fan stops, check the power specification (voltage, phase sequence, and so on) of the cooling fan. If there is no problem with the power specification, replace the fan unit.

<2> When a liquid-cooled motor is used, check the cooling system.

<3> When the motor ambient temperature is higher than the specified temperature, lower the ambient temperature to satisfy the specification.

(b) Increase the time constant or stop time in the program to ease the cutting conditions.

Motor temperature information is displayed on the diagnosis screen.

Motor temperature: Diagnosis information No. 308 (Series 16*i*, 30*i*, and others), diagnosis information No. 3520 (Series 15*i*)

Pulsecoder temperature: Diagnosis information No. 309 (Series 16*i*, 30*i*, and others), diagnosis information No. 3521 (Series 15*i*)

If an overheat alarm is issued when the temperature is not high, contact your FANUC service staff.

(2) Amplifier overheat

See the description about inverter overheat in Subsection 3.2.4.

3.3.6 Invalid Servo Parameter Setting Alarm

The invalid servo parameter setting alarm is issued when a setting out of the specifiable range is specified, or an overflow has occurred in an internal calculation. When an invalid parameter is detected on the servo side, alarm 4 #4 (PRM) = 1 results.

(Alarm identification method)

	#7	#6	#5	#4	#3	#2	#1	#0
<4> Alarm 4	DTE	CRC	STB	PRM				

For details and action required when the invalid servo parameter setting alarm is issued on the servo side, refer to the FANUC AC SERVO MOTOR α i series Parameter Manual (B-65270EN).

(Reference information)

Method of checking details of an invalid parameter detected on the servo side

(For Series 15*i*)

A number is indicated in the item "Details of invalid parameter" on the servo alarm screen (Fig. 3.3.1(b)).

3.TROUBLESHOOTING AND

ACTION

TROUBLESHOOTING

B-65285EN/04

(For Series 16i, 18i, 21i, 0i, and Power Mate i)

A number is indicated in No. 352 of the diagnosis screen.

Referring to "FANUC AC SERVO MOTOR α i series Parameter Manual (B-65270EN)" for details.

3.3.7 Alarms Related to Pulsecoder and Separate Serial Detector

(Bits for alarm identification)

	#7	#6	#5	#4	#3	#2	#1	#0
<1> Alarm 1	OVL	LVA	OVC	HCA	HVA	DCA	FBA	OFA
<2> Alarm 2	ALD			EXP				
<3> Alarm 3		CSA	BLA	PHA	RCA	BZA	CKA	SPH
<4> Alarm 4	DTE	CRC	STB	PRM				
<5> Alarm 5		OFS	MCC	LDM	PMS	FAN	DAL	ABF
<6> Alarm 6					SFA			
<7> Alarm 7	OHA	LDA	BLA	PHA	CMA	BZA	PMA	SPH
<8> Alarm 8	DTE	CRC	STB	SPD				
<9> Alarm 9		FSD			SVE	IDW	NCE	IFE

(1) For a built-in Pulsecoder

An alarm is determined from the bits of alarms 1, 2, 3, and 5. The table below indicates the meaning of each bit.

Alarm 3							Alarm 5		1	Alarm 2		Alarm description	Action
CSA	BLA	PHA	RCA	BZA	CKA	SPH	LDM	PMA	FBA	ALD	EXP		
						1						Soft phase alarm	2
				1								Zero battery voltage	1
			1						1	1	0	Count error alarm	2
		1										Phase alarm	2
	1											Battery voltage decrease (warning)	1
								1				Pulse error alarm	
							1					LED error alarm	



CAUTION

An alarm for which no action number is given is considered to be caused by a Pulsecoder failure. Replace the Pulsecoder.

(2) For a separate serial detector

An alarm is determined from the bits of alarm 7. The table below indicates the meaning of each bit.

Alarm 7								Alarm description	Action
OHA	LDA	BLA	PHA	CMA	BZA	PMA	SPH		
							1	Soft phase alarm	2
						1		Pulse error alarm	
					1			Zero battery voltage	1
				1				Count error alarm	2
			1					Phase alarm	2
		1						Battery voltage decrease (warning)	1
	1							LED error alarm	
1								Separate detector alarm	3

⚠ CAUTION

An alarm for which no action number is given is considered to be caused by a detector failure. Replace the detector.

(Action)

Action 1: Battery-related alarms

Check if a battery is connected. When the power is turned on for the first time after a battery is connected, the zero battery voltage alarm is issued. In such a case, turn off the power, then turn on the power again. If the alarm is still issued, check the battery voltage. If the battery voltage decrease alarm is issued, check the voltage, and replace the battery as required.

Action 2: Alarms that may be issued for noise

If an alarm is issued intermittently or after emergency stop cancellation, noise is probably the cause. So, provide noise protection. If the same alarm is still issued after noise protection is provided, replace the detector.

Action 3: Alarm condition detected by the separate detector

If the separate detector detects an alarm condition, contact the manufacturer of the detector for information on troubleshooting.

(3) Alarms related to serial communication

An alarm is determined from the bits of alarms 4 and 8.

Alarm 4			Alarm 8			Alarm description
DTE	CRC	STB	DTE	CRC	STB	
1						Serial Pulsecoder communication alarm
	1					
		1				Separate serial Pulsecoder communication alarm
			1			
				1		
					1	

Action: Serial communication is not performed correctly. Check if the cable is connected correctly and is not broken. If CRC or STB is issued, noise may be the cause. So, provide noise protection. If CRC or STB is always issued after the power is turned on, the Pulsecoder or amplifier control board or the pulse module may be faulty.

3.3.8 Other Alarms

(Alarm identification method)

	#7	#6	#5	#4	#3	#2	#1	#0
<5> Alarm 5		OFS	MCC	LDM	PMS	FAN	DAL	ABF

OFS	DAL	ABF	Alarm description	Action
		1	Feedback mismatch alarm	1
	1		Excessive semi-full error alarm	2
1			Current offset error alarm	3

(Action)

Action 1: This alarm is issued when the move direction of the position detector is opposite to the move direction of the speed detector. Check the rotation direction of the separate detector. If the rotation direction of the separate detector is opposite to the rotation direction of the motor, take the following action:

3.TROUBLESHOOTING AND

ACTION

TROUBLESHOOTING

B-65285EN/04

For a phase A/B detector:

Reverse the connections of A and \bar{A} .

For a serial detector:

Reverse the setting of the signal direction of the separate detector.

In the Series 90B0/G(07) and subsequent editions, the following settings enable signal directions in the A/B phase detector to be inverted.

	#7	#6	#5	#4	#3	#2	#1	#0
No. 1960 (FS15i)								RVRSE
No. 2018 (FS16i)								

RVRSE (#0) Reverses the signal direction of the separate detector.

0: Does not reverse the signal direction of the separate detector.

1: Reverses the signal direction of the separate detector.

If a large distortion exists between the motor and separate detector, this alarm may be issued in the case of abrupt acceleration/deceleration. In such a case, modify the detection level.

	#7	#6	#5	#4	#3	#2	#1	#0
No. 1741 (FS15i)							RNLV	
No. 2201 (FS16i)								

RNLV (#1) Modifies the feedback mismatch alarm detection level.

1: Detected with 1000 min⁻¹ or more

0: Detected with 600 min⁻¹ or more

Action 2: This alarm is issued when the difference between the motor position and separate detector position exceeds the excessive semi-full error level. Check if the conversion efficient for dual position feedback is set correctly. If the conversion efficient is set correctly, increase the alarm level. If this alarm is still issued after the level is modified, check the connection direction of the scale.

No. 1971 (FS15i)	Dual position feedback conversion coefficient (numerator)
No. 2078 (FS16i)	

No. 1972 (FS15i)	Dual position feedback conversion coefficient (denominator)
No. 2079 (FS16i)	

$$\text{Conversion coefficient} = \frac{\left(\begin{array}{l} \text{Number of feedback pulses per motor} \\ \text{revolution (detection unit)} \end{array} \right)}{1,000,000}$$

No. 1729 (FS15i)	Dual position feedback semi-full error level
No. 2118 (FS16i)	

[Setting] Detection unit. When 0 is set, no detection is made.

Action 3: The current offset value of the current detector (equivalent to the current value in the emergency stop state) is abnormally high. If this alarm is still issued after the power is turned off then back on, the current detector is faulty. For the α i series, replace the amplifier.

3.4 SPINDLE AMPLIFIER

If an alarm occurs in the Spindle Amplifier, the ALM LED lights red in the STATUS display, and the two-digit 7-segment LEDs indicate the alarm code.

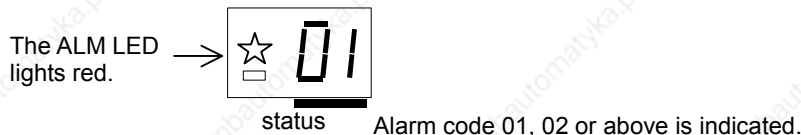

3.4.1 Alarm Code 01

The inside temperature of the motor is higher than the specified temperature.

- (1) If this alarm is issued during cutting (the motor temperature is high)
 - (a) Check the cooling state of the motor.
 - <1> If the cooling fan of the spindle motor is stopped, check the power supply of the cooling fan. If the cooling fan is still inoperative, replace it with a new one.
 - <2> When a liquid-cooled motor is used, check the cooling system.
 - <3> When the ambient temperature of the spindle motor is higher than the specified temperature, lower the ambient temperature to satisfy the specification.
 - (b) Recheck the cutting conditions.
- (2) If this alarm is issued under a light load (the motor temperature is high)
 - (a) When the frequency of acceleration/deceleration is too high
Set such a use condition that the average including output at acceleration/deceleration does not exceed the continuous rating.
 - (b) The parameters specific to the motor are not correctly.
Referring to "FANUC AC SPINDLE MOTOR α i series Parameter Manual (B-65280EN)," check the motor-specific parameters.
- (3) If this alarm is issued when the motor temperature is low
 - (a) The spindle motor feedback cable is faulty.
Replace the cable.
 - (b) The parameters specific to the motor are not set correctly.
Referring to "FANUC AC SPINDLE MOTOR α i series Parameter Manual (B-65280EN)," check the motor-specific parameters.

FS15i	FS16i FS0i-B/C	FS30i FS0i-D	For α series motor	For α i series motor
3134	4134	4134	0	Motor-specific parameter

- (c) The control printed circuit board is faulty.
Replace the control printed circuit board or spindle amplifier.
- (d) The motor (internal thermostat) is faulty.
Replace the motor.

3.4.2 Alarm Code 02

The actual motor speed is largely deviated from the commanded speed.

- (1) If this alarm is issued during motor acceleration
 - (a) The parameter setting of acceleration/deceleration time is incorrect.
Set the following parameter with the actual acceleration/deceleration time for your machine plus some margin.

3.TROUBLESHOOTING AND

ACTION

TROUBLESHOOTING

B-65285EN/04

FS15i	FS16i FS0i-B/C	FS30i FS0i-D	Description
3082	4082	4082	Setting of acceleration/deceleration time

(b) The parameter for the speed detector is not set correctly.
Referring to "FANUC AC SPINDLE MOTOR α i series Parameter Manual (B-65280EN)," set a correct value.

(2) If this alarm is issued at a heavy cutting load

(a) The cutting load has exceeded the motor output power.
Check the load meter indication, and review the use condition.

(b) The parameters for output restriction are not set correctly.
Check that the settings of the following parameters satisfy the machine and motor specifications:

FS15i	FS16i FS0i-B/C	FS30i FS0i-D	Description
3028	4028	4028	Output restriction pattern setting
3029	4029	4029	Output restriction value

(c) The parameters specific to the motor are not correctly.
Referring to "FANUC AC SPINDLE MOTOR α i series Parameter Manual (B-65280EN)," check the motor-specific parameters.

3.4.3 Alarm Code 03

The fuse of the DC link has blown. (The voltage at the DC link is insufficient.) This alarm is checked when emergency stop is cancelled.

(1) If this alarm is issued during spindle operation (rotation)

The fuse of the DC link inside the Spindle Amplifier has probably blown. So, replace the Spindle Amplifier. This alarm may be caused by the following:

- <1> Power lead short-circuited to ground
- <2> Motor winding short-circuited to ground
- <3> IGBT or IPM module failure

(2) If the Power Supply input magnetic contactor is once turned on and is turned off with this alarm when emergency stop is cancelled or the CNC is started (When two spindles are connected, the magnetic contactor may not be turned off.)

- (a) The DC link wire is not connected.
Check the DC link wiring for errors.
- (b) The fuse of the DC link inside the Spindle Amplifier has blown.
Replace the Spindle Amplifier.

3.4.4 Alarm Code 06

The temperature sensor is abnormal, or the temperature sensor cable is broken.

- (1) The parameters specific to the motor are not correctly.
Referring to "FANUC AC SPINDLE MOTOR α i series Parameter Manual (B-65280EN)," check the motor-specific parameters.
- (2) Cable is faulty.
Feedback cable is faulty.
Replace the cable.
- (3) The control printed-circuit board is faulty.
Replace the control printed-circuit board or spindle amplifier.
- (4) A thermo sensor is faulty.
Replace the motor (thermo sensor).

3.4.5 Alarm Code 07

The motor rotates at a speed exceeding 115% (standard setting) of the maximum allowable speed.

- (1) If this alarm is issued during spindle synchronization
If one of the motors operating in spindle synchronization is deactivated (SFR or SRV) and activated again, the spindle motor may accelerate to its maximum rotation speed in order to eliminate the position error accumulated while the motor is off, resulting in this alarm being issued.
Modify the ladder in such a way that this sequence will not be used.
- (2) Spindle Amplifier is faulty.
Replace the Spindle Amplifier.

3.4.6 Alarm Code 09

The temperature of the heat sink of the Spindle Amplifier main circuit has risen abnormally. This alarm is issued for αi SP22, αi SP30HV and later. With αi SP2.2 to αi SP15 and αi SP5.5HV to αi SP15HV, however, Alarm 12 is issued for the same cause.

- (1) If this alarm is issued during cutting (the heat sink temperature is high)
 - (a) If this alarm is issued when the load meter reads a value below the continuous rating of the amplifier, check the cooling state of the heat sink.
 - <1> If the cooling fan is stopped, check the power supply (connector CX1A/B). If the cooling fan is still inoperative, replace the Spindle Amplifier with a new one.
 - <2> When the ambient temperature is higher than the specified temperature, lower the ambient temperature to satisfy the specification.
 - (b) When this alarm is issued because the load meter reads a value above the continuous rating of the amplifier, improve the use method.
 - (c) When the heat sink on the back of the amplifier is too dirty, clean the heat sink, for example, by blowing air. Consider the use of a structure that prevents the heat sink from being directly exposed to coolant.
- (2) If this alarm is issued under a light load (the heat sink temperature is high)
 - (a) When the frequency of acceleration/deceleration is too high
Set such a use condition that the average including output at acceleration/deceleration does not exceed the continuous rating.
 - (b) The parameters specific to the motor are not set correctly.
Referring to "FANUC AC SPINDLE MOTOR αi series Parameter Manual (B-65280EN)," check the motor-specific parameters.
- (3) Poor installation of the control printed-circuit board
Be sure to push the faceplate as far as it will go. (This alarm may be displayed if one of the connectors for connection between the control printed-circuit board and power printed-circuit board is detached.)
- (4) If this alarm is issued when the heat sink temperature is low
Replace the Spindle Amplifier.

3.4.7 Alarm Code 10

The control power supply voltage decreases.

Troubleshooting when this alarm is issued

The control power supply, power cable, Power Supply, or Spindle Amplifier is defective.
Replace the control power supply, power cable, Power Supply, or Spindle Amplifier.

3.4.8 Alarm Code 12

An excessively large current flowed into the DC link of the main circuit.

With α i SP2.2 to α i SP15 and α i SP5.5HV to α i SP15HV, this alarm indicates that the power module (IPM) of the main circuit detected an error such as an excessive load, overcurrent.

- (1) If this alarm is issued on α i SP2.2 to α i SP1 and α i SP5.5HV to α i SP15HV
Check alarm code 09 as well.
- (2) Poor installation of the control printed-circuit board
Be sure to push the faceplate as far as it will go. (This alarm may be displayed if one of the connectors for connection between the control printed-circuit board and power printed-circuit board is detached.)
- (3) If this alarm is issued immediately after a spindle rotation command is specified
 - (a) The motor power lead is faulty.
Check for a short circuit between motor power leads and short-circuit to ground, and replace the power lead as required.
 - (b) The motor winding has an insulation failure.
If the motor is short-circuited to ground, replace the motor.
 - (c) The parameters specific to the motor are not set correctly.
Referring to "FANUC AC SPINDLE MOTOR α i series Parameter Manual (B-65280EN)," check the motor-specific parameters.
 - (d) The Spindle Amplifier is faulty.
A power element (IGBT, IPM) may be destroyed. Replace the Spindle Amplifier.
- (4) If this alarm is issued during spindle rotation
 - (a) A power element is destroyed.
A power element (IGBT, IPM) may be destroyed. Replace the Spindle Amplifier.
If the amplifier setting condition is not satisfied, or cooling is insufficient because the heat sink is dirty, the power elements may be destroyed.
When the heat sink on the back of the amplifier is too dirty, clean the heat sink, for example, by blowing air. Consider the use of a structure that prevents the heat sink from being directly exposed to coolant.
For the installation condition, refer to "FANUC SERVO AMPLIFIER α i series Descriptions (B-65282EN)."
 - (b) The parameters specific to the motor are not set correctly.
Referring to "FANUC AC SPINDLE MOTOR α i series Parameter Manual (B-65280EN)," check the parameters specific to the motor.
 - (c) Speed sensor signal error
Check the spindle sensor signal waveform. If an error is found, make an adjustment or replace the sensor as required.

3.4.9 Alarm Code 13

An error was detected in the CPU internal RAM.

Troubleshooting when this alarm is issued

The Spindle Amplifier is abnormal. Replace the Spindle Amplifier.

3.4.10 Alarm Code 14

Amplifier ID data inconsistent with series and edition of software was detected.

Troubleshooting when this alarm is issued

The Spindle Amplifier is abnormal. Replace the Spindle Amplifier.

3.4.11 Alarm Code 15

In output switching control or spindle switching control, the switching operation sequence was not executed correctly.

This alarm is issued if one second or more elapses from the transition of a switch request signal (SPSL or RSL) until a power lead state check signal (MCFN, MFNHG, RCH, or RCHHG) makes a transition.

(1) Troubleshooting when this alarm is issued

(a) The magnetic contactor (switch unit) for power lead switching is faulty.

If the contact is inoperative, check the power supply of the magnetic contactor. If the magnetic contactor is still inoperative, replace the magnetic contactor.

(b) The I/O unit or wiring for checking the contact of the magnetic contactor is faulty.

If a defect is found in the I/O unit or wiring, replace the I/O unit or wiring.

(c) The sequence (ladder) is incorrect.

Modify the sequence so that switching is completed within 1 second.

3.4.12 Alarm Code 16

An error was found in a CPU internal RAM test by the Dual Check Safety function.

Troubleshooting when this alarm is issued

The Spindle Amplifier is abnormal. Replace the Spindle Amplifier.

3.4.13 Alarm Code 17

An error was detected in amplifier ID data.

Troubleshooting when this alarm is issued

The Spindle Amplifier control printed-circuit board becomes loose or the Spindle Amplifier is abnormal.

Check whether the Spindle Amplifier control printed-circuit board is mounted correctly.

When the board is mounted correctly, replace the Spindle Amplifier.

3.4.14 Alarm Code 18

A sum check is abnormal.

If this alarm is issued, replace the Spindle Amplifier or Spindle Amplifier control printed-circuit board.

3.4.15 Alarm Codes 19 and 20

The offset voltage of the phase U (alarm code 19) or phase V (alarm code 20) current detection circuit is excessively high. A check is made when the power is turned on.

If this alarm is issued, replace the Spindle Amplifier. If this alarm is issued immediately after the Spindle Amplifier control printed circuit board is replaced, check the plugging of the connectors between the power unit and Spindle Amplifier control printed circuit board.

3.TROUBLESHOOTING AND

ACTION

TROUBLESHOOTING

B-65285EN/04

3.4.16 Alarm Code 21

The specified polarity of the position sensor is incorrect.

Troubleshooting when this alarm is issued

- (a) Check the position sensor polarity parameter (bit 4 of parameter No. 4001).
- (b) Check the feedback cable of the position sensor.

3.4.17 Alarm Code 22

Overcurrent exceeding the time rating of the Spindle Amplifier flowed.

Possible causes are a high frequency of acceleration/deceleration and high cutting load.

Troubleshooting when this alarm is issued

Ease the operation conditions.

3.4.18 Alarm Code 24

Serial communication data transferred between the CNC and Spindle Amplifier contains an error. (Note)

Troubleshooting when this alarm is issued

- (a) Noise occurring between the CNC and Spindle Amplifier (connected via an electric cable) caused an error in communication data.
Check the condition for maximum wiring length.
Referring to "Connection," in "FANUC SERVO AMPLIFIER α i series Descriptions (B-65282EN)," check the condition of electric cable connection.
- (b) Noise exercises an influence because a communication cable is bundled with the power lead.
If a communication cable is bundled with the power lead for the motor, separate them from each other.
- (c) A cable is faulty.
Replace the cable.
If an optical I/O link adapter is used, the optical link adapter or optical cable may be faulty.
- (d) The Spindle Amplifier is faulty.
Replace the Spindle Amplifier or Spindle Amplifier control printed circuit board.
- (e) The CNC is faulty.
Replace the board or module related to the serial spindle.

NOTE

This alarm is issued also if the CNC power is off. This is not a failure, though.

3.4.19 Alarm Code 27

The signal of the α i position coder is disconnected.

(1) If this alarm is issued when the motor is deactivated

- (a) The setting of a parameter is incorrect.
Referring to "FANUC AC SPINDLE MOTOR α i series Parameter Manual (B-65280EN)," check the parameter for sensor setting.
- (b) The cable is disconnected.
If the connection of the feedback cable is correct, replace the cable.
- (c) The Spindle Amplifier is faulty.
Replace the Spindle Amplifier or Spindle Amplifier control printed circuit board.

- (2) If this alarm is issued when the cable is moved
- (a) The connector has a bad contact, or the cable is disconnected.
The conductor may be broken. Replace the cable. If coolant has penetrated into the connector, clean the connector.

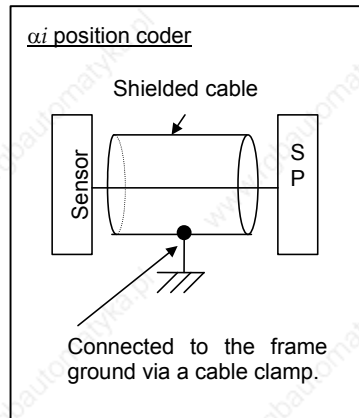

- (3) If this alarm is issued when the motor rotates
- (a) The shielding of the cable between the sensor and the Spindle Amplifier is faulty.
Referring to, "Connection," in "FANUC SERVO AMPLIFIER α i series Descriptions (B-65282EN)," check the shielding of the cable.
- (b) The signal cable is bundled with the servo motor power lead.
If the cable between the sensor and the Spindle Amplifier is bundled with the servo motor power lead, separate them from each other.

3.4.20 Alarm Code 29

An excessive load (standard setting: load meter reading of 9 V) has been applied continuously for a certain period (standard setting: 30 seconds).

- (1) If this alarm is issued during cutting
Check the load meter, and review the cutting condition.
- (2) If this alarm is issued during a stop
- (a) The spindle is locked.
Check the sequence to see if the spindle is locked when a command for very slow movement is specified or orientation is specified for the spindle.
- (3) If the spindle does not rotate as specified (the spindle rotates at a very low speed) and this alarm is issued
- (a) The setting of a parameter is incorrect.
Referring to "FANUC AC SPINDLE MOTOR α i series Parameter Manual (B-65280EN)," check the parameter for sensor setting.
- (b) The phase sequence of the motor power lead is incorrect.
- (c) The feedback cable of the motor has a problem.
Check if the phase A/B signals are connected correctly.
- (d) The feedback cable of the motor is faulty.
Rotate the motor manually to see if a speed is indicated in the item of motor speed on the CNC diagnosis screen or on the spindle check board. If no speed indication is provided, replace the cable or spindle sensor (or motor).
- (4) If the spindle does not rotate as specified (the spindle does not rotate at all) and this alarm is issued
- (a) The power lead is abnormal.
Check if the motor power lead is connected normally. If spindle switching or output switching is performed, check if the magnetic contactor is on.
- (b) The Spindle Amplifier is faulty.
Replace the Spindle Amplifier.

3.4.21 Alarm Code 31

The motor failed to rotate as specified, and has stopped or is rotating at a very low speed.

- (1) If the motor rotates at a very low speed and this alarm is issued
 - (a) The setting of a parameter is incorrect.
Referring to "FANUC AC SPINDLE MOTOR α i series Parameter Manual (B-65280EN)," check the parameter for sensor setting.
 - (b) The phase sequence of the motor power lead is incorrect.
Check whether the phase sequence of the motor power lead is correct.
 - (c) The feedback cable of the motor has a problem.
Check if the phase A/B signals are connected correctly.
 - (d) The feedback cable of the motor is faulty.
Rotate the motor manually to see if a speed is indicated in the item of motor speed on the CNC diagnosis screen or on the spindle check board. If no speed indication is provided, replace the cable or spindle sensor (or motor).
- (2) If the motor does not rotate at all and this alarm is issued
 - (a) The sequence for locking the spindle is incorrect.
Check the sequence to see if the spindle is locked.
 - (b) The power lead is faulty.
Check if the power lead is connected to the motor correctly. If spindle switching or winding switching is performed, check if the magnetic contactor is on.
 - (c) The Spindle Amplifier is faulty.
Replace the Spindle Amplifier.

3.4.22 Alarm Code 32

LSI memory for serial communication is abnormal. A check is made when the power is turned on.

If this alarm is issued, replace the Spindle Amplifier or Spindle Amplifier control printed circuit board.

3.4.23 Alarm Code 34

Parameter data outside the specifiable range was set.

Troubleshooting when this alarm is issued

Connect the spindle check board.

The spindle check board displays "AL-34" and "F-xxx" alternately. "F-xxx" indicates a parameter number outside the specifiable range. For the correspondence between the CNC parameter numbers and "F-xxx," refer to "FANUC AC SPINDLE MOTOR α i series Parameter Manual (B-65280EN)."

3.4.24 Alarm Code 36

The error counter overflowed.

- (1) The setting of a parameter is incorrect.
 - (a) The gear ratio set in a parameter is incorrect.
Check if an excessively large gear ratio is set.
 - (b) The setting of a position gain is incorrect.
If the gear ratio data is correct, increase the position gain.

FS15i	FS16i FS0i-B/C	FS30i FS0i-D	Description
3056 to 3059	4056 to4059	4056 to4059	Gear ratio between the spindle and motor
3060 to3063	4060 to4063	4060 to4063	Position gain at orientation
3065 to3068	4065 to4068	4065 to4068	Position gain in the servo mode/spindle synchronization
3069 to3072	4069 to4072	4069 to4072	Position gain in Cs contour control

- (2) Sequence error
- (a) Check if the motor is deactivated (by turning off SFR/SRV) in a position control mode (rigid tapping, Cs contour control, or spindle synchronization).

3.4.25 Alarm Code 37

After emergency stop signal input, the motor is accelerated without being decelerated. This alarm is issued also when the motor is not deactivated (the motor is not decelerated completely) when the acceleration/deceleration time (initial parameter setting: 10 seconds) has elapsed after emergency stop signal input.

Troubleshooting when this alarm is issued

- (a) The parameter setting of the speed detector is incorrect.
Referring to Chapter 1 in "FANUC AC SPINDLE MOTOR α i series Parameter Manual (B-65280EN)," set a correct time.
- (b) The parameter setting of an acceleration/deceleration time is not proper.
Check the parameter-set value and actual acceleration/ deceleration time, then set an actual acceleration/deceleration time plus some margin.

FS15i	FS16i FS0i-B/C	FS30i FS0i-D	Description
3082	4082	4082	Acceleration/deceleration time setting

3.4.26 Alarm Code 41

The position where the one-rotation signal of the α i position coder is generated is incorrect.

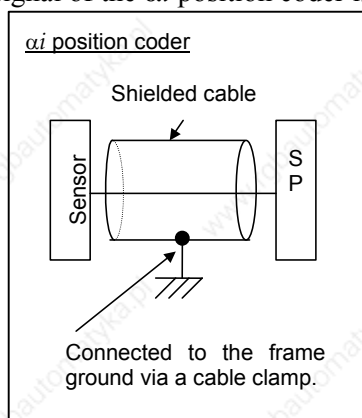

Troubleshooting when this alarm is issued

- (a) The setting of a parameter is incorrect.
Referring to "FANUC AC SPINDLE MOTOR α i series Parameter Manual (B-65280EN)," check the parameter for sensor setting.
- (b) The α i position coder is faulty.
Observe the Z signal of the position coder. If the signal is not generated per rotation, replace the position coder.

3. TROUBLESHOOTING AND

ACTION

TROUBLESHOOTING

B-65285EN/04

- (c) The shielding of the cable between the sensor and Spindle Amplifier is faulty.
Referring to "Connection," in "FANUC SERVO AMPLIFIER α i series Descriptions (B-65282EN)," check the shielding of the cable.
- (d) The signal cable is bundled with the servo motor power lead.
If the cable between the sensor and Spindle Amplifier is bundled with the servo motor power lead, separate them from each other.
- (e) The Spindle Amplifier is faulty.
Replace the Spindle Amplifier or Spindle Amplifier control printed circuit board.

3.4.27 Alarm Code 42

The one-rotation signal of the α i position coder is not generated.

Troubleshooting when this alarm is issued

- (a) The setting of a parameter is incorrect.
Referring to "FANUC AC SPINDLE MOTOR α i series Parameter Manual (B-65280EN)," check the parameter for sensor setting.
- (b) The α i position coder is faulty.
Check the check pin PSD on the spindle check board. If the signal is not generated per rotation, replace the connection cable and position coder.
- (c) The Spindle Amplifier is faulty.
Replace the Spindle Amplifier or Spindle Amplifier control printed circuit board.

3.4.28 Alarm Code 43

The position coder signal of the master spindle used in differential spindle speed control is disconnected.

For troubleshooting when this alarm is issued, see the subsection about alarm code 27.

3.4.29 Alarm Code 46

The one-rotation signal of the position coder cannot be detected normally during thread cutting.

Troubleshoot as in the case of alarm code 41.

3.4.30 Alarm Code 47

The count value of α i position coder signal pulses is abnormal.

Phases A and B for the position coder have a feedback pulse count of 4096 p/rev per spindle rotation. The Spindle Amplifier checks the pulse counts of phases A and B equivalent to the position coder each time a one-rotation signal is generated. The alarm is issued when a pulse count beyond the specified range is detected.

- (1) If this alarm is issued when the cable is moved (as in the case where the spindle moves)
The conductor may be broken. Replace the cable. If coolant has penetrated into the connector, clean the connector.
- (2) Troubleshooting in other cases
 - (a) The setting of a parameter is incorrect.
Referring to "FANUC AC SPINDLE MOTOR α i series Parameter Manual (B-65280EN)," check the parameter for sensor setting.

- (b) The shielding of the cable between the sensor and Spindle Amplifier is faulty.
Referring to "Connection," in "FANUC SERVO AMPLIFIER α i series Descriptions (B-65282EN)," check the shielding of the cable.
- (c) The signal cable is bundled with the servo motor power lead.
If the cable between the sensor and Spindle Amplifier is bundled with the servo motor power lead, separate them from each other.
- (d) The Spindle Amplifier is faulty.
Replace the Spindle Amplifier or Spindle Amplifier control printed circuit board.

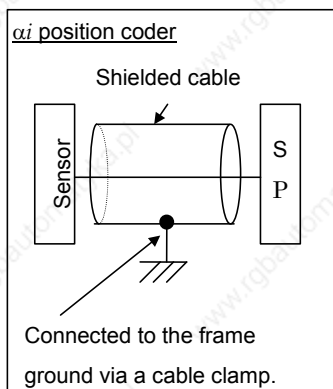

3.4.31 Alarm Code 49

In differential spindle speed control, the speed of the master spindle converted to the motor speed of the slave spindle exceeded the allowable range.

Troubleshooting when this alarm is issued

The master spindle speed is converted to the motor speed of the slave spindle by multiplying the master spindle speed by the gear ratio between the slave spindle and motor. Check whether the converted spindle speed exceeds the maximum motor speed and operate the machine so that the maximum motor speed is not exceeded.

3.4.32 Alarm Code 50

A value obtained by internal calculation in spindle synchronization exceeded the allowable range.

Troubleshooting when this alarm is issued

- (a) The setting of parameters for gear ratio setting is incorrect.
Check if an excessively large gear ratio is set.
- (b) Position gain setting limit
If correct gear ratio data is set, increase the position gain value in spindle synchronization.

FS16i FS0i-B/C	FS30i FS0i-D	Description
4056 to 4059	4056 to 4059	Gear ratio between the spindle and motor
4065 to 4068	4065 to 4068	Position gain in the servo mode/spindle synchronization

3.4.33 Alarm Codes 52 and 53

The synchronization signal (ITP) in communication data transferred to and from the CNC stopped.

Troubleshooting when this alarm is issued

- (a) The Spindle Amplifier is faulty.
Replace the Spindle Amplifier or Spindle Amplifier control printed circuit board.
- (b) The CNC is faulty.
Replace the board or module related to the serial spindle.

3.4.34 Alarm Code 54

A large current flowing in the motor for a long time was detected.

Troubleshoot as in the case of alarm code 29.

3.4.35 Alarm Code 55

In spindle switching control or output switching control, a mismatch between the switching request signal (SPSL or RSL) and the power lead state check signal (MCFN, MFNHG, RCH, or RCHHG) continues during motor activation.

Troubleshooting when this alarm is issued

- (a) The magnetic contactor (switch unit) for power lead switching is faulty.
If the contact is inoperative, check the power supply of the magnetic contactor. If the magnetic contactor is still inoperative, replace the magnetic contactor.
- (b) The I/O unit or wiring for checking the contact of the magnetic contactor is faulty.
If a defect is found in the I/O unit or wiring, replace the I/O unit or wiring.
- (c) The sequence (ladder) is incorrect.
Modify the sequence so that switching is not performed during activation. For details of the signals, refer to "FANUC SERVO AMPLIFIER α i series Descriptions (B-65282EN)."

3.4.36 Alarm Code 56

The cooling fan for the control circuit section has stopped.

- (a) Poor installation of the control printed-circuit board
Be sure to push the faceplate as far as it will go. (This alarm may be displayed if one of the connectors for connection between the control printed-circuit board and power printed-circuit board is detached.)
- (b) Replace the Spindle Amplifier or its internal cooling fan.

3.4.37 Alarm Code 61

The difference in position between the semi-closed side and closed side exceeded the setting level (parameter No. 4354) for the dual position feedback function.

Troubleshooting when this alarm is issued

- (a) When this alarm is issued at the start of the machine, there may be a setting error in a sensor-related parameter or motor-end position feedback conversion coefficient parameter.
Check whether conversion coefficient parameters Nos. 4171 and 4172 (in high gear) and Nos. 4173 and 4174 (in low gear) are set correctly. Also, refer to the FANUC AC SPINDLE MOTOR ai series Parameter Manual (B-65280EN) to check the settings of the sensor-related parameters.

- (b) When the conversion coefficients are set correctly, the level set for parameter No. 4354 may be too low.
- (c) When this alarm is issued for a system which has been operating normally, there may be slippage between the motor and spindle. Check the machine.
- (d) When this alarm is intermittently issued for a system which has been operating normally, a count error may occur in the motor-end or spindle-end position feedback signal due to noise.

3.4.38 Alarm Code 65

A magnetic pole detection error occurred. This spindle alarm is issued for the BiS Series spindle motors (synchronous spindle motors).

Troubleshooting when this alarm is issued

When this alarm is issued at the start, possible causes are all of (a) to (f) below. When the machine has been operating normally, possible causes are (d), (e), and (f).

- (a) There is a setting error in a parameter (number of teeth of a motor sensor or number of phases of a motor).
Check whether the settings of the parameters of the number of teeth of the motor sensor (bits 2, 1, and 0 of parameter No. 4011 and parameter No. 4334) and the number of phases of the motor (bits 7 and 3 of parameter No. 4011 and parameter No. 4368) are correct.
- (b) The phase sequence of the motor power lead differs from that of connection of motor sensor feedback.
- (c) The motor power lead is not connected.
- (d) The motor is locked and cannot move. Alternatively, the excitation current is low and the motor cannot move smoothly due to the effect of friction.
Detect the magnetic pole when the motor can move smoothly.
- (e) The motor sensor or rotor shaft slips and the phase relationship between the motor sensor and rotor changes.
- (f) A count error occurs in the motor feedback signal due to the effect of noise.

3.4.39 Alarm Code 66

An error occurred during communication (connector JX4) between spindle and amplifier.

Troubleshooting when this alarm is issued

- (a) Check the connection between the spindle and amplifier.
- (b) Replace the cable.

3.4.40 Alarm Code 67

The reference position return command was issued for the slave axis in the spindle EGB mode.

Troubleshooting when this alarm is issued

- (a) Reference position return cannot be performed in the spindle EGB mode (G81). Before performing reference position return, turn the EGB mode off (G80).

3.4.41 Alarm Code 69

This alarm can be issued only when Dual Check Safety is in use.

The alarm occurs if, in safety signal mode C (a guard open request was entered to open the guard), the spindle motor rotation speed exceeds the safety speed.

3.TROUBLESHOOTING AND

ACTION

TROUBLESHOOTING

B-65285EN/04

Troubleshooting when this alarm is issued

- (a) If the guard is open, observe the safety speed.
- (b) Check the safety speed parameter.
- (c) Replace the Spindle Amplifier control printed-circuit board.

3.4.42 Alarm Code 70

This alarm can be issued only when Dual Check Safety is in use.
The spindle amplifier connection status does not match the hardware setting.

Troubleshooting when this alarm is issued

- (a) Check the Spindle Amplifier connection and its setting.
- (b) Replace the CPU card or Spindle Amplifier control printed-circuit board.

3.4.43 Alarm Code 71

This alarm can be issued only when Dual Check Safety is in use.
A safety parameter error occurred.

Troubleshooting when this alarm is issued

- (a) Re-set the safety parameter.
- (b) Replace the CPU card or Spindle Amplifier control printed-circuit board.

3.4.44 Alarm Code 72

This alarm can be issued only when Dual Check Safety is in use.
The result of the spindle amplifier speed check does not match the result of the CNC speed check.

If the alarm occurs, replace the CPU card in the CNC or the Spindle Amplifier control printed-circuit board.

3.4.45 Alarm Code 73

The signal of the motor sensor is disconnected.

- (1) If this alarm is issued when the motor is deactivated
 - (a) The setting of a parameter is incorrect.
Referring to "FANUC AC SPINDLE MOTOR α i series Parameter Manual (B-65280EN)," check the parameter for sensor setting.
 - (b) The cable is disconnected.
Replace the cable.
 - (c) The sensor is not adjusted correctly.
Adjust the sensor signal. If the sensor signal cannot be adjusted correctly, or the sensor signal is not observed, replace the connection cable and sensor.
 - (d) The Spindle Amplifier is faulty.
Replace the Spindle Amplifier or Spindle Amplifier control printed circuit board.
- (2) If this alarm is issued when the cable is moved (as in the case where the spindle moves)
The conductor may be broken. Replace the cable. If coolant has penetrated into the connector, clean the connector.

- (3) If this alarm is issued when the motor rotates
- (a) The shielding of the cable between the sensor and the Spindle Amplifier is faulty.
Referring to, "Connection," in "FANUC SERVO AMPLIFIER α i series Descriptions (B-65282EN)," check the shielding of the cable.
 - (b) The signal cable is bundled with the servo motor power lead.
If the cable between the sensor and the Spindle Amplifier is bundled with the servo motor power lead, separate them from each other.

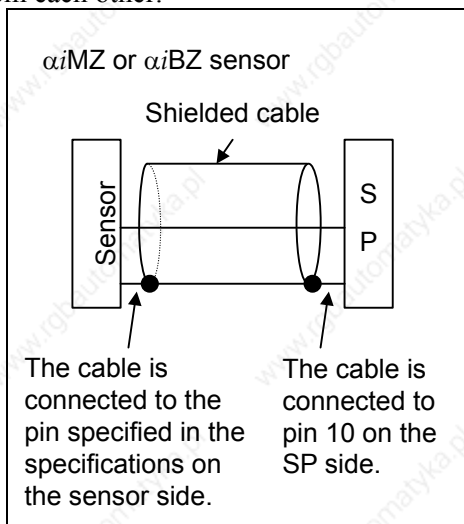

3.4.46 Alarm Code 74

This alarm can be issued only when Dual Check Safety is in use.
The CPU test failed to end normally.

When this alarm is issued, Replace the Spindle Amplifier or Spindle Amplifier control printed circuit board.

3.4.47 Alarm Code 75

This alarm can be issued only when Dual Check Safety is in use.
An error occurred in the CRC test.

When this alarm is issued, Replace the Spindle Amplifier or Spindle Amplifier control printed circuit board.

3.4.48 Alarm Code 76

This alarm can be issued only when Dual Check Safety is in use.
The spindle safety function has not been executed.

If the alarm occurs, replace the Spindle Amplifier control printed-circuit board.

3.4.49 Alarm Code 77

This alarm can be issued only when Dual Check Safety is in use.
The result of the spindle amplifier axis number check does not match the result of the CNC axis number check.

If the alarm occurs, replace the CPU card in the CNC or the Spindle Amplifier control printed-circuit board.

3.4.50 Alarm Code 78

This alarm can be issued only when Dual Check Safety is in use.

The result of spindle amplifier safety parameter check does not match the result of the CNC safety parameter check.

If the alarm occurs, replace the CPU card in the CNC or the Spindle Amplifier control printed-circuit board.

3.4.51 Alarm Code 79

This alarm can be issued only when Dual Check Safety is in use.

An abnormal operation was detected in the initial test.

When this alarm is issued, Replace the Spindle Amplifier or Spindle Amplifier control printed circuit board.

3.4.52 Alarm Code 80

A spindle alarm was issued for the destination amplifier in inter-Spindle Amplifier communication (connector JX4).

Troubleshooting when this alarm is issued

- (a) There is no problem with the Spindle Amplifier to which this alarm is issued. Check the spindle alarm in the destination amplifier and take appropriate action.

3.4.53 Alarm Code 81

The position where the one-rotation signal of the motor sensor is generated is incorrect.

- (1) If the external one-rotation signal is used

- (a) The settings of parameters are incorrect.

Check that the gear ratio data matches the specification of the machine.

FS15i	FS16i FS0i-B/C	FS30i FS0i-D	Description
3171 3173	4171 4173	4171 4173	Denominator of gear ratio between motor sensor and spindle
3172 3174	4172 4174	4172 4174	Numerator of gear ratio between motor sensor and spindle

- (b) Slippage between the spindle and motor

Check that there is no slippage between the spindle and motor. The external one-rotation signal is not applicable to V-belt connection.

- (2) Troubleshooting in other cases

- (a) The setting of a parameter is incorrect.

Referring to "FANUC AC SPINDLE MOTOR α i series Parameter Manual (B-65280EN)," check the parameter for sensor setting.

- (b) A sensor (α iMZ sensor or α iBZ sensor) is not adjusted correctly.

Adjust the sensor signal. If the sensor signal cannot be adjusted correctly, or the sensor signal is not observed, replace the connection cable and sensor.

- (c) The shielding of the cable between the sensor and Spindle Amplifier is faulty.

Referring to "Connection," in "FANUC SERVO AMPLIFIER α i series Descriptions (B-65282EN)," check the shielding of the cable.

- (d) The signal cable is bundled with the servo motor power lead.
If the cable between the sensor and Spindle Amplifier is bundled with the servo motor power lead, separate them from each other.
- (e) The Spindle Amplifier is faulty.
Replace the Spindle Amplifier or Spindle Amplifier control printed circuit board.

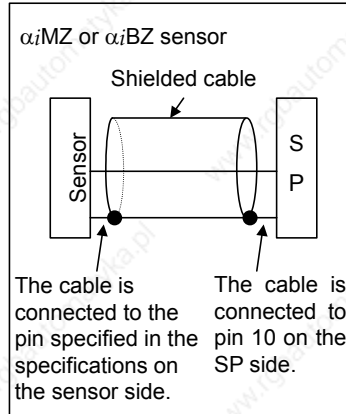

3.4.54 Alarm Code 82

The one-rotation signal of the motor sensor is not generated.

Troubleshooting when this alarm is issued

- (a) The setting of a parameter is incorrect.
Referring to "FANUC AC SPINDLE MOTOR αi series Parameter Manual (B-65280EN)," check the parameter for sensor setting.
- (b) The αiMZ sensor or αiBZ sensor is not adjusted correctly.
Adjust the sensor. If the sensor cannot be adjusted or the signal is not observed, replace the connection cable and sensor.
- (c) The external one-rotation signal is faulty.
Check the check pin EXTSC1 on the spindle check board. If the signal is not generated per rotation, replace the connection cable and position coder.
- (d) The Spindle Amplifier is faulty.
Replace the Spindle Amplifier or Spindle Amplifier control printed circuit board.

3.4.55 Alarm Code 83

The Spindle Amplifier checks the pulse counts of phases A and B each time a one-rotation signal is generated. The alarm is issued when a pulse count beyond the specified range is detected.

- (1) If this alarm is issued when the cable is moved (as in the case where the spindle moves)
The conductor may be broken. Replace the cable. If coolant has penetrated into the connector, clean the connector.
- (2) Troubleshooting in other cases
 - (a) The setting of a parameter is incorrect.
Referring to "FANUC AC SPINDLE MOTOR αi series Parameter Manual (B-65280EN)," check the parameter for sensor setting.
 - (b) The αiMZ sensor or αiBZ sensor is not adjusted correctly.
Adjust the sensor. If the sensor cannot be adjusted or the signal is not observed, replace the connection cable and sensor.
 - (c) The shielding of the cable between the sensor and Spindle Amplifier is faulty.
Referring to "Connection," in "FANUC SERVO AMPLIFIER αi series Descriptions (B-65282EN)," check the shielding of the cable.

3.TROUBLESHOOTING AND

ACTION

TROUBLESHOOTING

B-65285EN/04

- (d) The signal cable is bundled with the servo motor power lead.
If the cable between the sensor and Spindle Amplifier is bundled with the servo motor power lead, separate them from each other.
- (e) The Spindle Amplifier is faulty.
Replace the Spindle Amplifier or Spindle Amplifier control printed circuit board.

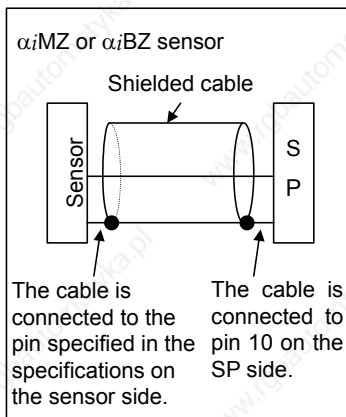

3.4.56 Alarm Code 84

The spindle sensor signal was disconnected.
Refer to Alarm Code 73 for this alarm trouble shooting.

3.4.57 Alarm Code 85

The one-rotation signal of the spindle sensor occurred in an incorrect location.
Refer to Alarm Code 81 for this alarm trouble shooting.

3.4.58 Alarm Code 86

No spindle sensor one-rotation signal occurred.
Refer to Alarm Code 82 for this alarm trouble shooting.

3.4.59 Alarm Code 87

A spindle sensor signal is abnormal.
Refer to Alarm Code 83 for this alarm trouble shooting.

3.4.60 Alarm Code 88

The heat sink cooling fan is not running.
If this alarm is issued, replace the Spindle Amplifier heat sink cooling fan.

3.4.61 Alarm Code 89

The submodule SM (SSM) is abnormal. This spindle alarm is issued for the BiS Series spindle motors (synchronous spindle motors).
When this alarm is issued at the start, possible causes are all of (a) to (d) below. When the machine has been operating normally, possible causes are (c) and (d).

Troubleshooting when this alarm is issued

- (a) The Spindle Amplifier does not support the SSM.
Replace the Spindle Amplifier.
- (b) The SSM is not mounted or connected.
Check the connection of the interface signal cable between JYA4 (Spindle Amplifier) and CX31 (SSM).
- (c) The interface signal between the Spindle Amplifier and SSM is disconnected.
Check the connection of the interface signal cable between JYA4 (Spindle Amplifier) and CX31 (SSM).
- (d) The SSM is faulty.
Replace the SSM.

3.4.62 Alarm Code 90

An unexpected rotation state (state in which the polarity in the torque command differs that of acceleration) was detected. This spindle alarm is issued for the BiS Series spindle motors (synchronous spindle motors). When this alarm is issued at the start, possible causes are all of (a) to (d) below. When the machine has been operating normally, it is highly possible that the cause is (c) or (d).

Troubleshooting when this alarm is issued

- (a) There is a setting error in a parameter (number of teeth of the motor sensor or number of phases of the motor).
Refer to the FANUC AC SPINDLE MOTOR α i series Parameter Manual (B-65280EN) to check the relevant parameters.
- (b) There is a setting error in an AMR offset-related parameter (No. 4084 or 4085).
Parameter No. 4084 (AMR offset) is adjusted for each machine. Readjust this parameter when the phase relationship between the magnetic pole 0-deg position of the rotor and the one-rotation signal position of the sensor changes due to the replacement of the sensor or slippage of the shaft or when the parameter is loaded from another machine.
Parameter No. 4085 is provided for AMR offset adjustment. Normally, this parameter must be set to "0".
- (c) When this alarm is issued after the spindle is banded, a possible cause is a change to the phase relationship between the motor sensor and rotor due to slippage of the motor sensor or rotor shaft.
- (d) A count error occurs in the motor sensor due to noise.
Apply appropriate countermeasures against noise.

3.4.63 Alarm Code 91

A count error occurred for the magnetic pole position (a large difference between the magnetic pole position at the one-rotation signal position and the setting of parameter No. 4084 (AMR offset) was detected). This spindle alarm is issued for the BiS Series spindle motors (synchronous spindle motors).

When this alarm is issued at the start, possible causes are both (a) and (b) below. When the machine has been operating normally, check (b) and take appropriate action.

Troubleshooting when this alarm is issued

- (a) There is a setting error in a parameter (number of teeth of the motor sensor or number of phases of the motor).
Refer to the FANUC AC SPINDLE MOTOR α i series Parameter Manual (B-65280EN) to check the relevant parameters.
- (b) An unnecessary one-rotation signal is generated or a count error occurs for feedback pulses due to slippage of the sensor ring or noise.
Check whether the motor sensor slips. When there is no problem with the motor sensor, take appropriate countermeasures against noise.

3.4.64 Alarm Code 92

The actual motor speed exceeded the overspeed level corresponding to the velocity command.

When this alarm is issued at the start, possible causes are all of (a) to (c) below. When the machine has been operating normally, it is highly possible that the cause is noise in (c).

Troubleshooting when this alarm is issued

- (a) There is a setting error in a parameter (number of teeth of the motor sensor or number of phases of the motor).
Refer to the FANUC AC SPINDLE MOTOR α i series Parameter Manual (B-65280EN) to check the relevant parameters.
- (b) When a BiS Series spindle motor (synchronous spindle motor) is driven, there is a setting error in an AMR offset-related parameter (No. 4084 or 4085).
Parameter No. 4084 (AMR offset) is adjusted for each machine. Readjust this parameter when the phase relationship between the magnetic pole 0-deg position of the rotor and the one-rotation signal position of the sensor changes due to the replacement of the sensor or slippage of the shaft or when the parameter is loaded from another machine.
Parameter No. 4085 is provided for AMR offset adjustment. Normally, this parameter must be set to "0".
- (d) A count error occurs in the motor sensor due to noise.
Apply appropriate countermeasures against noise.

3.4.65 Alarm Codes A, A1, and A2

The control program is not running.

An error was detected when the control program was running.

- (1) If this alarm is issued when the spindle amplifier power is switched on
 - (a) Wrong software specification
 - (b) Defective printed-circuit board
Replace the Spindle Amplifier or Spindle Amplifier control printed-circuit board.
- (2) If this alarm is issued when the motor is active.
 - (a) Influence by noise
Referring to "Installation" in "FANUC SERVO AMPLIFIER α i series Descriptions (B-65282EN)," check the grounding wire. If the spindle sensor signal wire is bundled together with any motor power wire, separate them.

3.4.66 Alarm Code b0

An error occurred in communication between amplifiers (Spindle Amplifier, Servo Amplifier, and Power Supply).

Troubleshooting when this alarm is issued

- (1) If this alarm is issued immediately after the power supply of CNC is turned on
 - (a) Check the way the connectors are coupled.
Normally, CXA2A and CXA2B must be coupled.
 - (b) The cable is defective.
Check the connection pin number. If there is any problem, correct it.
Alternatively, replace the cable.
 - (c) The Spindle Amplifier, Servo Amplifier, or Power Supply is defective.
Replace the Spindle Amplifier, Servo Amplifier, or Power Supply. Alternatively, replace the Spindle Amplifier, Servo Amplifier, or Power Supply control printed-circuit board.

3.4.67 Alarm Codes C0,C1, and C2

An error occurred in serial communication data between the CNC and Spindle Amplifier.

Troubleshooting when this alarm is issued

- (a) The Spindle Amplifier is defective.
Replace the Spindle Amplifier or Spindle Amplifier control printed-circuit board.
- (b) The CNC is defective.
Replace the board or module related to the serial spindle.

3.4.68 Alarm Code C3

In spindle switching, a mismatch is found between the switching request signal (SPSL) and the internal status of the motor/spindle sensor signal switching circuit (submodule SW).

Troubleshooting when this alarm is issued

The submodule SW (SSW) is defective.
Replace the submodule SW (SSW).

3.4.69 Alarm Code C4

An invalid learning cycle is set in learning control in the time synchronization mode.

Troubleshooting when this alarm is issued

- (a) Check whether the value specified in the velocity command is appropriate.
- (b) Check whether the setting of the learning cycle (parameter No. 4425) is within a range between 20 and 4800.

3.4.70 Alarm Code C5

An invalid value is set for the highest or lowest degree of a dynamic characteristic compensation element in learning control.

Troubleshooting when this alarm is issued

Decrease the setting of the highest (parameter No. 4427) or lowest (parameter No. 4428) of dynamic characteristic compensation element Gx.

3.4.71 Alarm Code C7

An invalid reference angle cycle is set in learning control in the angle synchronization mode.

Troubleshooting when this alarm is issued

Increase the setting of parameter No. 4425 (number of divisions per cycle) in learning control.

3.4.72 Alarm Code C8

In spindle synchronization, the speed deviation (difference between the specified speed at the spindle end calculated based on the position error and position gain and the actual speed) exceeded the alarm detection level (parameter No. 4515).

3.TROUBLESHOOTING AND

ACTION

TROUBLESHOOTING

B-65285EN/04

- (1) When this alarm is issued immediately after the motor excitation (SFR, SRV) is turned off, then on again in spindle synchronization
This alarm may be issued because the spindle motor is accelerated to eliminate the accumulated position error while the motor excitation is off. Modify the sequence so that the motor excitation is turned off after spindle synchronization is released.
- (2) When this alarm is issued during cutting
 - (a) A possible cause is overload. Review the cutting conditions.
 - (b) When no overload occurs, review whether the alarm detection level setting is appropriate.

3.4.73 Alarm Code C9

In spindle synchronization, the position error exceeded the alarm detection level (parameter No. 4516).

For troubleshooting when this alarm is issued, see the subsection about alarm code C8.

3.4.74 Alarm Code d0

In tandem control, the speed polarity relationship between the master motor and slave motor is abnormal.

Troubleshooting when this alarm is issued

Check the setting related to the rotation direction (FS16: bit 2 of parameter No. 4353).

3.4.75 Alarm Code d1

An error occurred during spindle adjustment function operation.

Troubleshooting when this alarm is issued

Refer to the description of the error and action to be taken that are displayed on the SERVO GUIDE.

3.4.76 Alarm Code d2

Communication between the sensor (serial) and Spindle Amplifier is disconnected.

When this alarm is issued at the start, possible causes are all of (a) to (d) below. When the machine has been operating normally, possible causes are (c) and (d).

Troubleshooting when this alarm is issued

- (a) There is a parameter setting error.
Refer to the section, "START-UP," in the FANUC AC SPINDLE MOTOR *ai* series Parameter Manual (B-65280EN) to check the settings of the sensor setting parameters.
- (b) The Spindle Amplifier is not supported.
Check the items related to the section, "PARAMETERS RELATED TO DETECTORS," in the FANUC SERVO AMPLIFIER *ai* series Descriptions (B-65282EN).
- (c) The cable is broken or connected incorrectly.
Replace the cable or check the connection.
- (d) The Spindle Amplifier is defective.
Replace the Spindle Amplifier or Spindle Amplifier control printed-circuit board.

3.4.77 Alarm Code d3

Serial data between the sensor (serial) and Spindle Amplifier that was received by the Spindle Amplifier was detected being destroyed by noise.

Troubleshooting when this alarm is issued

- (a) Check the shielding of the cable between the sensor (serial) and Spindle Amplifier.
Check the items related to the section, "Detectors," in the FANUC SERVO AMPLIFIER αi series Descriptions (B-65282EN).

3.4.78 Alarm Code d4

A change to position data from the sensor (serial) was detected exceeding the expected range. When this alarm is issued at the start, possible causes are both (a) and (b) below. When the machine has been operating normally, the possible cause is (b).

Troubleshooting when this alarm is issued

- (a) There is a parameter setting error.
Refer to the section, "Parameters Related to Start-up," in the FANUC AC SPINDLE MOTOR αi series Parameter Manual (B-65280EN) to check the settings of the sensor setting parameters.
- (b) Check the shielding of the cable between the sensor (serial) and Spindle Amplifier.
Check the items related to the section, "Detectors," in the FANUC SERVO AMPLIFIER αi series Descriptions (B-65282EN).

3.4.79 Alarm Code d7

A communication error occurred in an electronic device on the Spindle Amplifier control circuit.

Troubleshooting when this alarm is issued

- The Spindle Amplifier control printed-circuit board becomes loose or the Spindle Amplifier is abnormal.
Check whether the Spindle Amplifier control printed-circuit board is mounted correctly.
When the board is mounted correctly, replace the Spindle Amplifier.

3.4.80 Alarm Code d9

An error occurred in the inner circuit of the sensor (serial).

Troubleshooting when this alarm is issued

- (a) The detection circuit is abnormal.
Replace the detection circuit.

3.4.81 Alarm Code E0

The number of pulses between one-rotation signals of the sensor (serial) is outside the specified range.

Troubleshooting when this alarm is issued

- (a) The detection circuit is abnormal.
Replace the detection circuit.

3.4.82 Alarm Code E1

The one-rotation signal of the sensor (serial) was not generated within five rotations after power-on. When this alarm is issued at the start, possible causes are all of (a) to (c) below. When the machine has been operating normally, possible causes are (b) and (c).

Troubleshooting when this alarm is issued

- (a) There is a parameter setting error.

When an invalid number of teeth of the sensor is set, this alarm may be issued because the actual number of rotations does not match the number of rotations calculated by the Spindle Amplifier. Refer to the section, "Parameters Related to Start-up," in the FANUC AC SPINDLE MOTOR α i series Parameter Manual (B-65280EN) to check the settings of the sensor setting parameters.

- (b) Sensor adjustment is defective.

Refer to the section, "Detectors," in the FANUC SERVO AMPLIFIER α i series Descriptions (B-65282EN) to adjust the sensor signal.

- (c) The detection circuit is abnormal.

Replace the detection circuit.

3.4.83 Other Alarms

- (1) If the Spindle Amplifier status display is 4, 11, 30, 33, 51, 57, 58, b1, b2, or b3

This status display means that an alarm condition occurred in the Power Supply. Check the status display of the Power Supply, and see Section 2.3.

- (2) About CNC alarms 756 and 766 (abnormal axis number)

These alarms can be issued only when the Dual Check Safety function is in use. If this alarm is issued, check that K76 shown below is attached to the JA7A connector of the second spindle. K76 is unnecessary if only the first spindle is used. If the wiring is normal, replace the Spindle Amplifier control printed-circuit board.

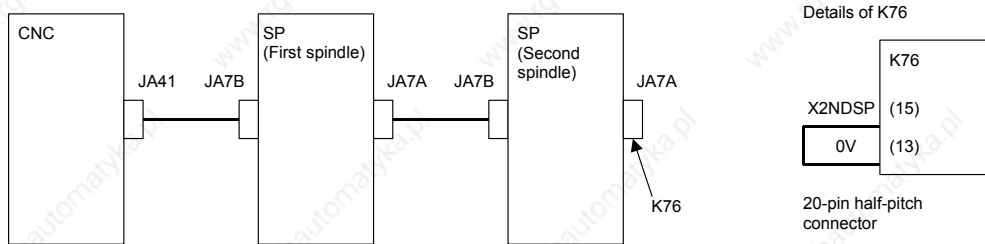

3.5 αCi SERIES SPINDLE AMPLIFIER MODULE

This section explains those alarm codes for the αCi series which require troubleshooting sequences that are different from those for the αi series even when the alarm numbers are the same.

For explanations about the alarm codes not stated herein, see the descriptions about the corresponding number given in Section 2.4, "Spindle Amplifier."

3.5.1 Alarm Code 12

An excessive motor current was detected.

An excessively large current flowed into the DC link of the main circuit.

For SPMC-2.2*i* to -15*i*

An overload, overcurrent, or a low control power supply voltage was detected in the power module (IPM) of the main circuit.

- (1) If this alarm is issued on SPMC-2.2*i* to -15*i*
Check alarm code 09 as well.
- (2) If this alarm is issued immediately after a spindle rotation command is specified
 - (a) The motor power lead is faulty.
Check for a short circuit between motor power leads and short-circuit to ground, and replace the power lead as required.
 - (b) The insulation of the motor winding is defective.
If the motor is short-circuited to ground, replace the motor.
 - (c) The parameters specific to the motor are not set correctly.
Refer to "FANUC AC SPINDLE MOTOR αi series Parameter Manual (B-65280EN)."
 - (d) The SPMC is faulty.
A power element (IGBT, IPM) may be destroyed. Replace the SPMC.
- (3) If this alarm is issued during spindle rotation
 - (a) Belt slippage
It is likely that there may be belt slippage between the spindle and motor. Clean the pulleys and adjust the belt tension.
 - (b) The parameters specific to the motor are not set correctly.
Referring to "FANUC AC SPINDLE MOTOR αi series Parameter Manual (B-65280EN)," check the parameters specific to the motor.
 - (c) The SPMC is faulty.
A power element (IGBT, IPM) may be destroyed. Replace the SPMC.
If the amplifier setting condition is not satisfied, or cooling is insufficient because the heat sink is dirty, the power elements may be destroyed.
When the heat sink on the back of the amplifier is too dirty, clean the heat sink, for example, by blowing air. Consider the use of a structure that prevents the heat sink from being directly exposed to coolant.
For the installation condition, refer to "FANUC SERVO AMPLIFIER αi series Descriptions (B-65282EN)."

3.5.2 Alarm Code 35

There is a large difference between the motor speed calculated from the position coder and the motor speed estimated with the spindle software.

(1) If an alarm is issued when a rotation command is entered

(a) Error in the position coder setting parameter

Correctly specify the bits representing the relationships between the direction of position coder rotation and that of spindle rotation and between the direction of spindle rotation and that of motor rotation.

FS15i	FS16i	Description
3000#0	4000#0	Spindle and spindle motor rotation directions
3001#4	4001#4	Spindle sensor (position coder) mounting direction

(b) Invalid gear ratio parameter setting

Check to see if an incorrect gear ratio has been specified.

This value is used to convert the position coder speed to the motor speed. Be sure to specify the correct value.

FS15i	FS16i	Description
3056 to 3059	4056 to 4059	Spindle-motor gear ratio data

(c) Clutch/gear signal error

Make sure that the entered clutch/gear signals (CTH1A, CTH2A) are correct with respect to the actually selected gear.

	FS15i	FS16i	#7	#6	#5	#4	#3	#2	#1	#0
First spindle	G227	G070					CTH1A	CTH2A		
Second spindle	G235	G074					CTH1B	CTH2B		

(d) Belt slippage between the spindle and spindle motor

Make adjustments so that no belt slippage will occur between the spindle and spindle motor.

(2) If an alarm is issued during a cutting operation

An overload has occurred to decrease the motor speed.

Review the cutting condition.

4 REPLACING AMPLIFIER COMPONENTS

This chapter describes how to replace a fan motor, absolute Pulsecoder battery, fuses, and printed-circuit board.

⚠ WARNING

Because the Servo Amplifier uses a large-capacitance electrolytic capacitor internally, the Servo Amplifier remains charged for a while even after the power is turned off. Before touching the Servo Amplifier for maintenance or other purposes, ensure your safety by measuring the residual voltage in the DC link with a tester and confirming that the charge indication LED (red) is off.

4.1 REPLACEMENT OF A FAN MOTOR

(1) Fan motor for internal cooling

Replace the internal fan motor, according to the procedure shown in the figure below.

When replacing the fan motor, be careful about the direction of the fan motor (air blow direction), the direction of the connector, etc.

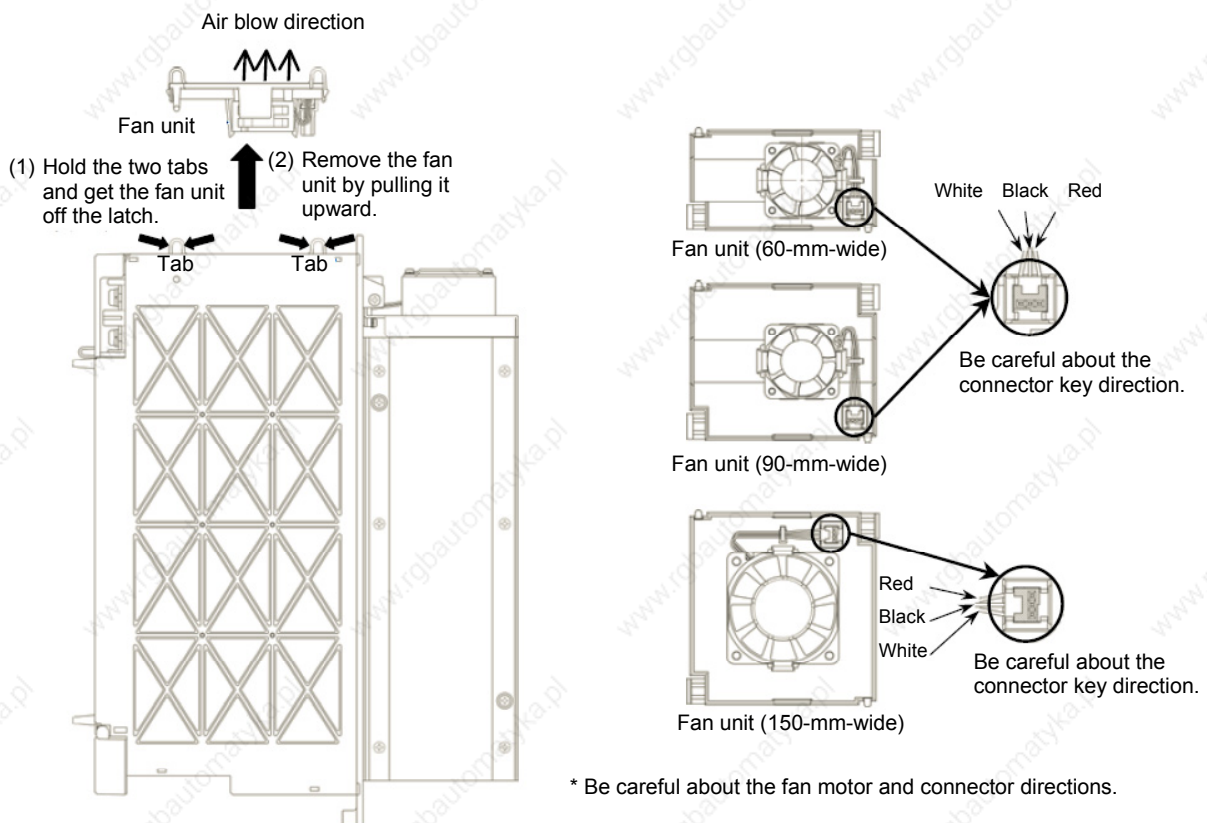

4.REPLACING AMPLIFIER

COMPONENTS

TROUBLESHOOTING

B-65285EN/04

- (2) Fan motor for cooling the external radiator
- <1> Remove the two sheet metal mounting screws (for the 60-mm-wide model only), and detach the fan motor from the unit together with the sheet metal.
 - <2> Remove the fan motor mounting screws (two for one fan motor and four for two fan motors).
 - <3> Remove the connector mounting screws (two and four for the 300-mm-wide model).
- When replacing the fan motor, be careful about the direction of the fan motor (air blow direction), the direction of the connector, etc.

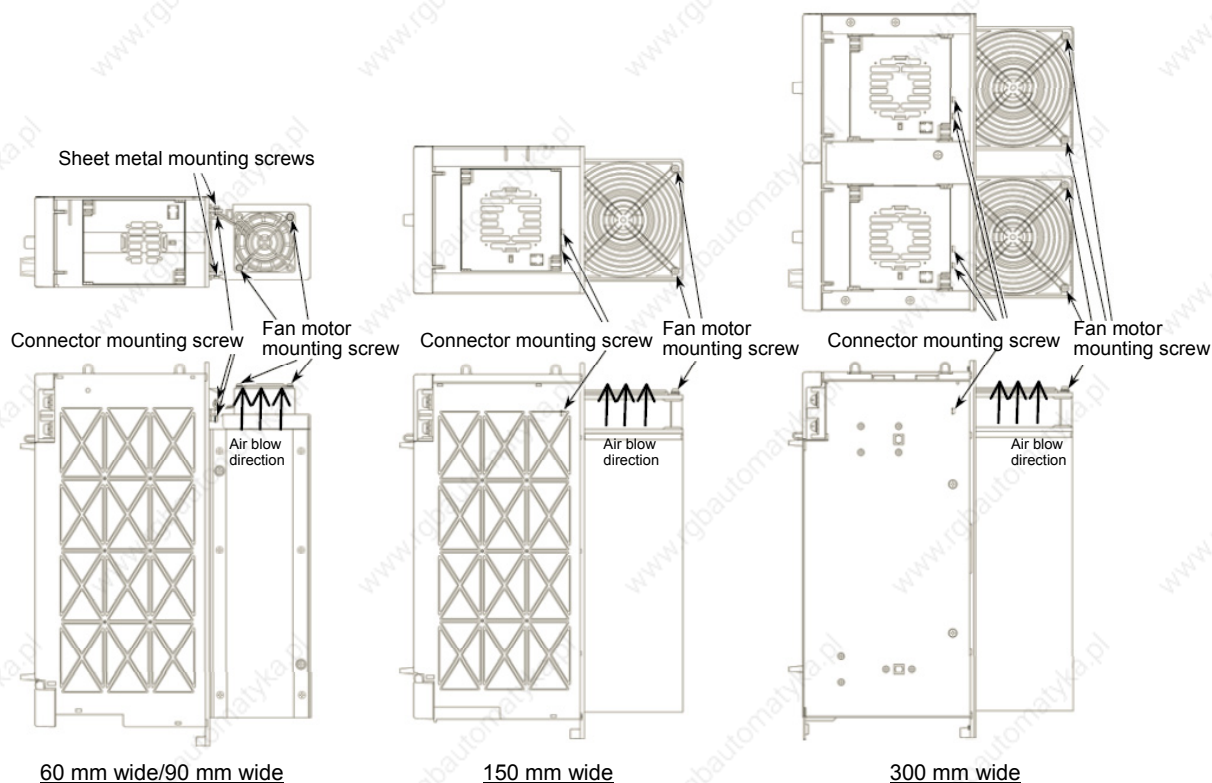

Specification number of fan unit - Power Supply

Model name	Internal cooling fan		Radiator cooling fan	
	Fan unit (*1)	Fan motor	Fan unit (*1)	Fan motor
α iPS 5.5	-	A90L-0001-0441/39	-	-
α iPS 11 α iPS 15 α iPS 11HV α iPS 18HV	-	A90L-0001-0441/39	A06B-6110-C603	A90L-0001-0508
α iPS 26 α iPS 30 α iPS 37	-	A90L-0001-0441/39	(A06B-6110-C604)	A90L-0001-0509
α iPS 30HV α iPS 45HV α iPS 60HV	A06B-6110-C607	A90L-0001-0441/39 A90L-0001-0511(*2)	(A06B-6110-C604)	A90L-0001-0509
α iPS 55 α iPS 75HV α iPS 100HV	A06B-6110-C607 Two are used.	A90L-0001-0441/39 A90L-0001-0511(*2)	(A06B-6110-C604) Two are used.	A90L-0001-0509 Two are used.

- Servo Amplifier

(1) 200 V input with one axis

Model name	Internal cooling fan		Radiator cooling fan	
	Fan unit (*1)	Fan motor	Fan unit (*1)	Fan motor
<i>αiSV</i> 4	A06B-6110-C605	A90L-0001-0510		
<i>αiSV</i> 20	A06B-6110-C605	A90L-0001-0510	-	-
<i>αiSV</i> 40	A06B-6110-C605	A90L-0001-0510	-	-
<i>αiSV</i> 80	A06B-6110-C605	A90L-0001-0510	-	-
<i>αiSV</i> 160	A06B-6110-C605	A90L-0001-0510	A06B-6110-C602	A90L-0001-0507/B
<i>αiSV</i> 360	A06B-6110-C607	A90L-0001-0511	(A06B-6110-C604)	A90L-0001-0509
<i>αiSV</i> 20L	A06B-6110-C605	A90L-0001-0510		
<i>αiSV</i> 40L	A06B-6110-C605	A90L-0001-0510		
<i>αiSV</i> 80L	A06B-6110-C605	A90L-0001-0510	A06B-6110-C602	A90L-0001-0507/B
<i>αiSV</i> 160L	A06B-6110-C606	A90L-0001-0510	A06B-6110-C603	A90L-0001-0508

(2) 200 V input with two axes

Model name	Internal cooling fan		Radiator cooling fan	
	Fan unit (*1)	Fan motor	Fan unit (*1)	Fan motor
<i>αiSV</i> 4/4	A06B-6110-C605	A90L-0001-0510	-	-
<i>αiSV</i> 4/20	A06B-6110-C605	A90L-0001-0510		
<i>αiSV</i> 20/20	A06B-6110-C605	A90L-0001-0510	-	-
<i>αiSV</i> 20/40	A06B-6110-C605	A90L-0001-0510	-	-
<i>αiSV</i> 40/40	A06B-6110-C605	A90L-0001-0510	A06B-6110-C601	A90L-0001-0507/A
<i>αiSV</i> 40/80	A06B-6110-C605	A90L-0001-0510	A06B-6110-C601	A90L-0001-0507/A
<i>αiSV</i> 80/80	A06B-6110-C605	A90L-0001-0510	A06B-6110-C601	A90L-0001-0507/A
<i>αiSV</i> 80/160	A06B-6110-C606	A90L-0001-0510	A06B-6110-C603	A90L-0001-0508
<i>αiSV</i> 160/160	A06B-6110-C606	A90L-0001-0510	A06B-6110-C603	A90L-0001-0508
<i>αiSV</i> 20/20L	A06B-6110-C605	A90L-0001-0510		
<i>αiSV</i> 20/40L	A06B-6110-C605	A90L-0001-0510	A06B-6110-C601	A90L-0001-0507/A
<i>αiSV</i> 40/40L	A06B-6110-C605	A90L-0001-0510	A06B-6110-C601	A90L-0001-0507/A
<i>αiSV</i> 40/80L	A06B-6110-C606	A90L-0001-0510	A06B-6110-C603	A90L-0001-0508
<i>αiSV</i> 80/80L	A06B-6110-C606	A90L-0001-0510	A06B-6110-C603	A90L-0001-0508

(*1) A fan unit is a set of a fan motor and a cover for mounting it. A fan motor can be replaced separately from the fan unit. The fan unit A06B-6110-C604, enclosed in parentheses, cannot be dismantled from the outside. So replace only the fan motor, which can be dismantled from the outside. (See Section III-1.3, "HOW TO REPLACE THE FAN MOTOR.")

(*2) For A06B-6110-C607

(3) 200 V input with three axes

Model name	Internal cooling fan		Radiator cooling fan	
	Fan unit (*1)	Fan motor	Fan unit	Fan motor
<i>αiSV</i> 4/4/4	A06B-6110-C605	A90L-0001-0510	-	-
<i>αiSV</i> 20/20/20	A06B-6110-C605	A90L-0001-0510	-	A90L-0001-0385/T(*2)
<i>αiSV</i> 20/20/40	A06B-6110-C605	A90L-0001-0510	-	-

(4) 400 V input with one axis

Model name	Internal cooling fan		Radiator cooling fan	
	Fan unit (*1)	Fan motor	Fan unit (*1)	Fan motor
α iSV 10HV	A06B-6110-C605	A90L-0001-0510	-	-
α iSV 20HV	A06B-6110-C605	A90L-0001-0510	-	-
α iSV 40HV	A06B-6110-C605	A90L-0001-0510	-	-
α iSV 80HV	A06B-6110-C605	A90L-0001-0510	A06B-6110-C602	A90L-0001-0507/B
α iSV 180HV	A06B-6110-C607	A90L-0001-0511	(A06B-6110-C604)	A90L-0001-0509
α iSV 360HV	A06B-6110-C607 Two are used.	A90L-0001-0511 Two are used.	(A06B-6110-C604) Two are used.	A90L-0001-0509 Two are used.
α iSV 540HV	A06B-6110-C607 Two are used.	A90L-0001-0511 Two are used.	(A06B-6110-C604) Two are used.	A90L-0001-0509 Two are used.
α iSV 10HVL	A06B-6110-C605	A90L-0001-0510		
α iSV 20HVL	A06B-6110-C605	A90L-0001-0510		
α iSV 40HVL	A06B-6110-C605	A90L-0001-0510	A06B-6110-C602	A90L-0001-0507/B
α iSV 80HVL	A06B-6110-C606	A90L-0001-0510	A06B-6110-C603	A90L-0001-0508

(5) 400 V input with two axes

Model name	Internal cooling fan		Radiator cooling fan	
	Fan unit (*1)	Fan motor	Fan unit (*1)	Fan motor
α iSV 10/10HV	A06B-6110-C605	A90L-0001-0510	-	-
α iSV 20/20HV	A06B-6110-C605	A90L-0001-0510	-	-
α iSV 20/40HV	A06B-6110-C606	A90L-0001-0510	A06B-6110-C603	A90L-0001-0508
α iSV 40/40HV	A06B-6110-C606	A90L-0001-0510	A06B-6110-C603	A90L-0001-0508
α iSV 40/80HV	A06B-6110-C606	A90L-0001-0510	A06B-6110-C603	A90L-0001-0508
α iSV 80/80HV	A06B-6110-C606	A90L-0001-0510	A06B-6110-C603	A90L-0001-0508
α iSV 10/10HVL	A06B-6110-C605	A90L-0001-0510		
α iSV 20/20HVL	A06B-6110-C605	A90L-0001-0510	A06B-6110-C601	A90L-0001-0507/A
α iSV 20/40HVL	A06B-6110-C606	A90L-0001-0510	A06B-6110-C603	A90L-0001-0508
α iSV 40/40HVL	A06B-6110-C606	A90L-0001-0510	A06B-6110-C603	A90L-0001-0508

(*1) A fan unit is a set of a fan motor and a cover for mounting it. A fan motor can be replaced separately from the fan unit. The fan unit A06B-6110-C604, enclosed in parentheses, cannot be dismantled from the outside. So replace only the fan motor, which can be dismantled from the outside.

(*2) The α iSV 20/20/20 has, within its housing, a fan motor for cooling the heat sink fins on the power transistor.

- Spindle Amplifier

Model name	Internal cooling fan		Radiator cooling fan	
	Fan unit (*1)	Fan motor	Fan unit (*1)	Fan motor
<i>α</i> iSP 2.2	A06B-6110-C605	A90L-0001-0510	-	-
<i>α</i> iSP 5.5	A06B-6110-C605	A90L-0001-0510	A06B-6110-C601	A90L-0001-0507/A
<i>α</i> iSP 5.5HV	A06B-6110-C605	A90L-0001-0510	A06B-6110-C602	A90L-0001-0507/B
<i>α</i> iSP 11 <i>α</i> iSP 15 <i>α</i> iSP 11HV <i>α</i> iSP 15HV	A06B-6110-C606	A90L-0001-0510	A06B-6110-C603	A90L-0001-0508
<i>α</i> iSP 22 <i>α</i> iSP 26 <i>α</i> iSP 30 <i>α</i> iSP 37 <i>α</i> iSP 30HV <i>α</i> iSP 45HV	A06B-6110-C607	A90L-0001-0511	(A06B-6110-C604)	A90L-0001-0509
<i>α</i> iSP 45 <i>α</i> iSP 55 <i>α</i> iSP 75HV <i>α</i> iSP 100HV	A06B-6110-C607 Two are used.	A90L-0001-0511 Two are used.	(A06B-6110-C604) Two are used.	A90L-0001-0509 Two are used.

- (*1) A fan unit is a set of a fan motor and a cover for mounting it. A fan motor can be replaced separately from the fan unit. The fan unit A06B-6110-C604, enclosed in parentheses, cannot be dismantled from the outside. So replace only the fan motor, which can be dismantled from the outside.

4.2 REPLACING BATTERY FOR ABSOLUTE PULSECODERS

4.2.1 Overview

- When the voltage of the batteries for absolute Pulsecoders becomes low, alarm 307 or 306 occurs, with the following indication in the CNC state display at the bottom of the CNC screen.
Alarm 307 (alarm indicating the voltage of the battery becomes low) :
The indication "APC" blinks in reversed display.
Alarm 306 (battery zero alarm) :
The indication "ALM" blinks in reversed display.
- When alarm 307 (alarm indicating the voltage of the battery becomes low) occurs, replace the battery as soon as possible. In general, the battery should be replaced within one or two weeks, however, this depends on the number of Pulsecoders used.
- When alarm 306 (battery zero alarm) occurs, Pulsecoders are reset to the initial state, in which absolute positions are not held. Alarm 300 (reference position return request alarm) also occurs, indicating that reference position return is required.
- In general, replace the batteries periodically within the service life listed below.
 - A06B-6050-K061 or D-size alkaline dry cells (LR20) : Two years (for each six-axis configuration)
 - A06B-6073-K001 : Two years (for each three-axis configuration)
 - A06B-6114-K504 : One year (for each three-axis configuration)

NOTE

The above values indicate the estimated service life of batteries used with FANUC absolute Pulsecoders. The actual battery service life depends on the machine configuration based on, for example, detector types. For details, contact the machine tool builder.

4.2.2 Replacing Batteries

To prevent absolute position information in absolute Pulsecoders from being lost, turn on the machine power before replacing the battery. The replacement procedure is described below.

- <1> Ensure that the power to the servo amplifier is turned on.
- <2> Ensure that the machine is in the emergency stop state (the motor is inactive).
- <3> Ensure that the DC link charge LED of the servo amplifier is off.
- <4> Detach the old batteries and attach new ones.

The replacement of the batteries in a separate battery case and the replacement of the battery built into the servo amplifier are described below in detail.

⚠ WARNING

- The absolute Pulsecoder of each of the $\alpha i/\alpha i$ S series servo motors and the βi S series servo motors (βi S0.4 to βi S22) has a built-in backup capacitor. Therefore, even when the power to the servo amplifier is off and the batteries are replaced, reference position return is not required if the replacement completes within less than 10 minutes. Turn the power on and replace the batteries if the replacement will take 10 minutes or more.
- To prevent electric shock, be careful not to touch metal parts in the power magnetics cabinet when replacing the batteries.
- Because the servo amplifier uses a large-capacitance electrolytic capacitor internally, the servo amplifier remains charged for a while even after the power is turned off. Before touching the servo amplifier for maintenance or other purposes, ensure your safety by measuring the residual voltage in the DC link with a tester and confirming that the charge indication LED (red) is off.
- Be sure to replace the batteries with specified ones. Pay attention to the battery polarity. If a wrong type of battery is used or a battery is installed with incorrect polarity, the battery may overheat, blow out, or catch fire, or the absolute position information in the absolute Pulsecoders may be lost.
- Ensure that the battery connector is inserted in the correct position.

4.2.3 Replacing the Batteries in a Separate Battery Case

Use the following procedure to replace the batteries in the battery case.

- <1> Loosen the screws on the battery case and detach the cover.
- <2> Replace the batteries in the case (pay attention to the polarity).
- <3> Attach the cover to the battery case.

Battery case (with a cover)
A06B-6050-K060

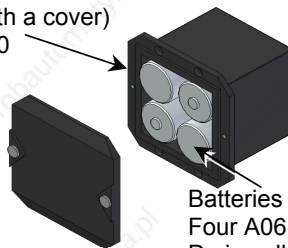

Batteries
Four A06B-6050-K061 batteries or
D-size alkaline dry cells

⚠ CAUTION

- Four D-size alkaline dry cells (LR20) that are commercially available can be used as batteries. A set of four A06B-6050-K061 batteries is optionally available from FANUC.
- Replace all the four batteries with new ones. If old and new batteries are mixed, the absolute position information in the absolute Pulsecoders may be lost.

4.2.4 Replacing the Battery Built into the Servo Amplifier

Use the following procedure to replace the special lithium battery.

- <1> Detach the battery case.
- <2> Replace the special lithium battery.
- <3> Attach the battery case.

- ⚠ CAUTION**
- Purchase the battery from FANUC because it is not commercially available. It is therefore recommended that you have a backup battery.
 - When the built-in battery is used, do not connect BATL (B3) of connector CXA2A/CXA2B. Also, do not connect two or more batteries to the same BATL (B3) line. These connections are dangerous because battery output voltages may be short-circuited, causing the batteries to overheat.
 - Install the battery in the servo amplifier in a direction that allows slack in the cable. If the battery cable is under tension, a bad connection may occur.
 - If the +6 V pin and 0 V pin are short-circuited, the battery may overheat, blow out, or catch fire, or the absolute position information in the absolute Pulsecoders may be lost.
 - When inserting the connector, align it to the connector pins.

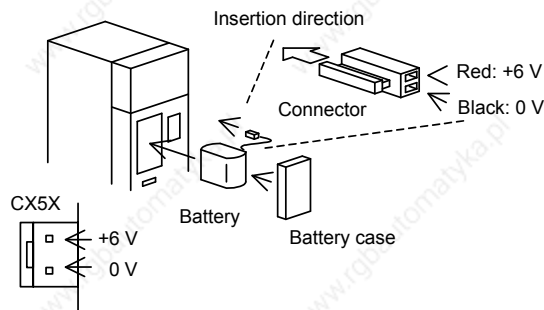

[Battery sets and outlines]

Battery ordering drawing number	Manufacturer model number	Applicable servo amplifier	Battery case ordering drawing number	Outline
A06B-6114-K504 (Note)	BR-2/3AGCT4A (Panasonic)	<i>αi</i> series 60/90 mm width	A06B-6114-K505	
		<i>αi</i> series 150/300 mm width	A06B-6114-K506	

NOTE
When using an old-type battery BR-CCF2TH, order a battery case applicable for battery A06B-6114-K504.

Used batteries

Old batteries should be disposed as "INDUSTRIAL WASTES" according to the regulations of the country or autonomy where your machine has been installed.

4.2.5 Notes on Replacing a Battery (Supplementary Explanation)

4.2.5.1 Battery connection modes

For absolute Pulsecoders, there are two types of battery connection modes: "Connecting batteries in a separate battery case" and "connecting batteries built into the Servo Amplifier." For details, refer to Subsection 9.3.2.10, "Connecting the battery (for the absolute Pulsecoder)," in the FANUC SERVO AMPLIFIER α i series Descriptions (B-63282EN).

[Batteries in a separate battery case]

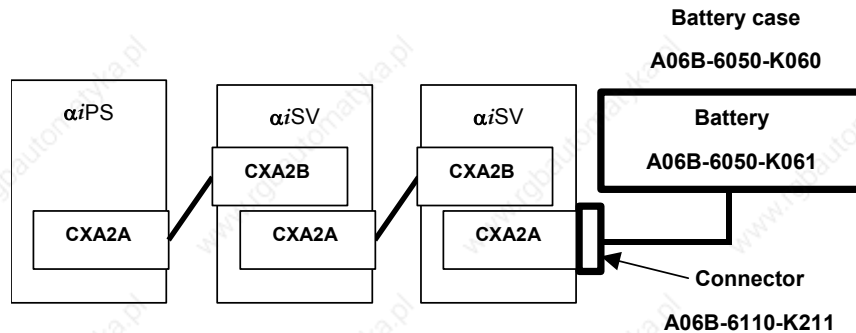

[Batteries built into the Servo Amplifier]

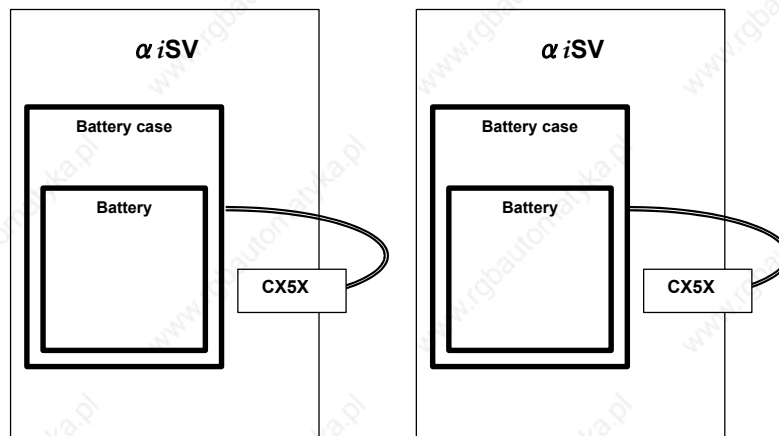

4.2.5.2 Connecting the battery for the α series motor

The Pulsecoder for the α series servo motor is not incorporated with a backup capacitor as standard. To keep the absolute position information in the absolute Pulsecoder, you need to keep the control power turned on during battery replacement. Follow the procedure explained below.

[Replacing procedure for the battery]

1. Make sure that the power to the Servo Amplifier is on (the 7-segment LED on the front of the SVM is on).
2. Make sure that the emergency stop button of the system has been pressed.
3. Make sure that the motor is not activated.
4. Make sure that the DC link charge LED of the SVM is off.
5. Remove the old battery, and install a new battery.
6. This completes the replacement. You can turn off the power to the system.



⚠ WARNING

- 1 When replacing the battery, be careful not to touch bare metal parts in the panel. In particular, be careful not to touch any high-voltage circuits due to the electric shock hazard.
- 2 Before replacing the battery, check that the DC link charge confirmation LED on the front of the servo amplifier is off. Neglecting this check creates an electric shock hazard.
- 3 Install the battery with correct polarity. If the battery is installed with incorrect polarity, it may overheat, blow out, or catch fire.
- 4 Avoid a short-circuit between the +6 V and 0 V lines of a battery or cable. A short-circuit may lead to a hot battery, an explosion, or fire.

4.2.5.3 Notes on attaching connectors

If an excessive strain is applied to a connector when it is inserted or removed, a poor contact may result. When inserting and removing the battery connector, therefore, be careful not to apply an excessive wrenching force to it; just follow the instructions given in the following table.

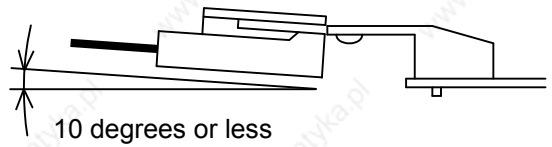
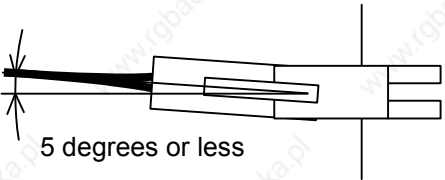
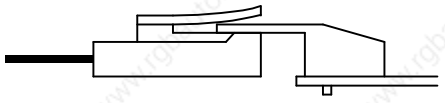
(1) Attaching connectors

<1>		Check the attachment position.
<2>	 <p style="text-align: center;">10 degrees or less</p>	Plug the cable connector while raising it slightly.
<5>	 <p style="text-align: center;">5 degrees or less</p>	Here, the angle of the cable connector to the horizontal must be 5 degrees or less.
<3>		After passing the lock pin, insert the connector straight.
<4>		The attachment of the connector is completed.

(2) Detaching the connector

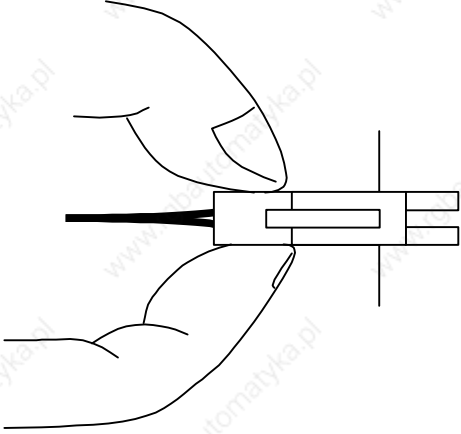
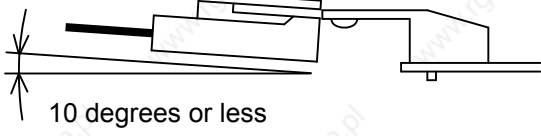
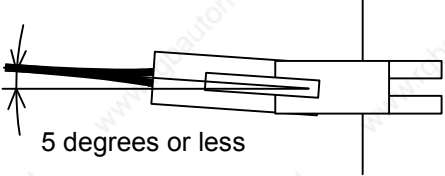
<1>		Hold both the sides of the cable insulator and the cable, and pull them horizontally.
<2>	 <p>10 degrees or less</p>	Pull out the cable side while raising it slightly.
<3>	 <p>5 degrees or less</p>	Here, the angle of the cable to the horizontal must be 5 degrees or less.

4.3 HOW TO REPLACE THE FUSES

In the α i series, a printed-circuit board can be removed and inserted from the front of the servo amplifier. The printed-circuit board removal/insertion procedure is common to the Power Supply, Servo Amplifier, and Spindle Amplifier.

NOTE

- 1 If a fuse blows, it is likely that there is a short-circuit in the power supply for a device (such as a sensor) connected to the Servo Amplifier. After checking that all devices connected to the Servo Amplifier are normal, replace the fuse. If you do not remove the cause, it is very much likely that the fuse will blow again.
- 2 Do not use any fuse not supplied from FANUC.
- 3 Before replacing a fuse, check a marking on it with that on the printed-circuit board. Be careful not to mount a fuse with an incorrect rating.

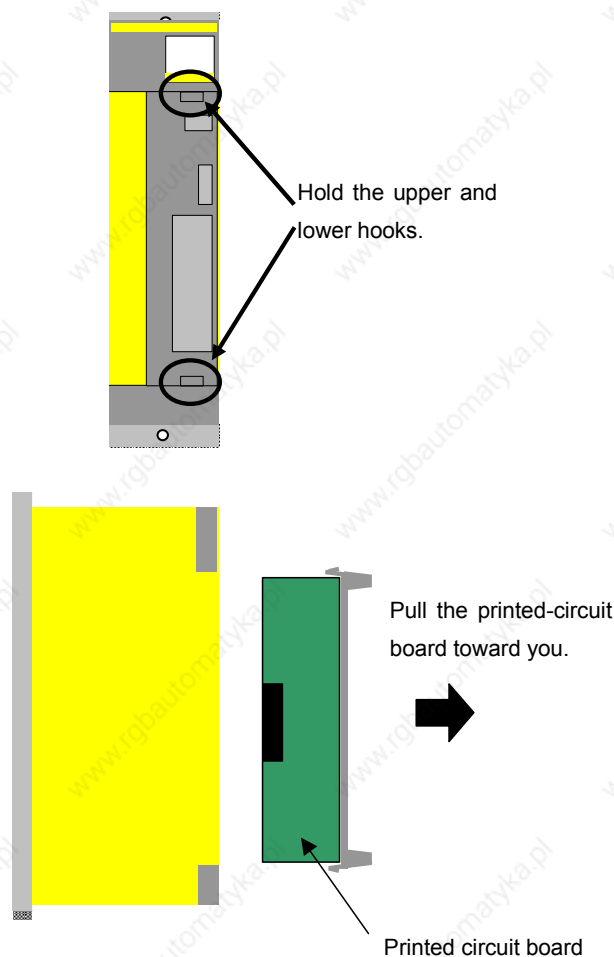

To insert the printed-circuit board, reverse the above procedure.

Ensure that the upper and lower hooks snap into the housing.

If the printed-circuit board is not inserted completely, the housing remains lifted. Pull out the printed-circuit board and insert it again.

4.3.1 Fuse Locations

4.3.1.1 Power Supply

There are two different fuses on the Power Supply printed-circuit board. Be careful not to confuse their ratings during replacement.

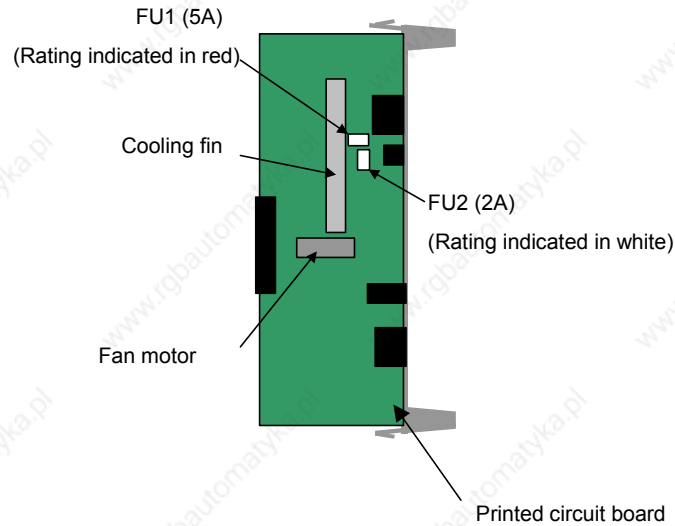

Fuse specification

Symbol	Ordering number
FU1	A60L-0001-0359
FU2	A60L-0001-0176/2.0A
FU3	A60L-0001-0290/LM32C

4.3.1.2 Servo Amplifier

There is one fuse on the Servo Amplifier printed-circuit board.

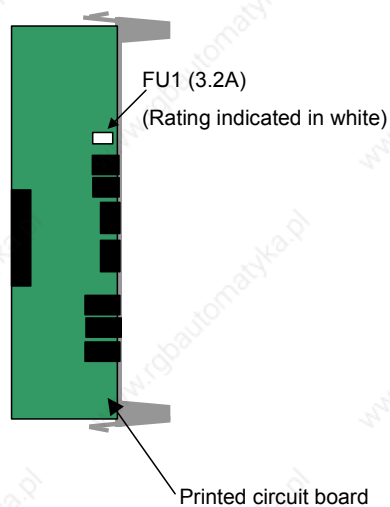

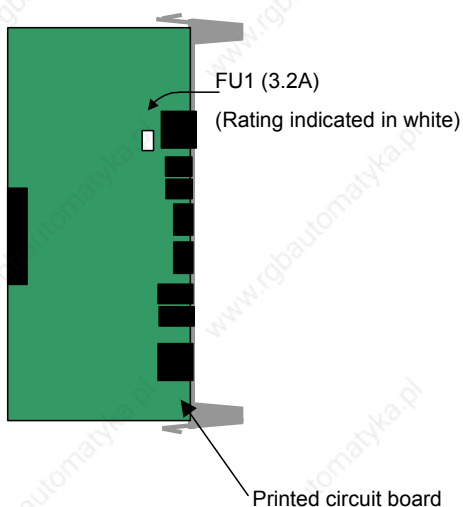

Fuse specification

Symbol	Ordering number
FU1	A60L-0001-0290/LM32C

4.3.1.3 Spindle Amplifier

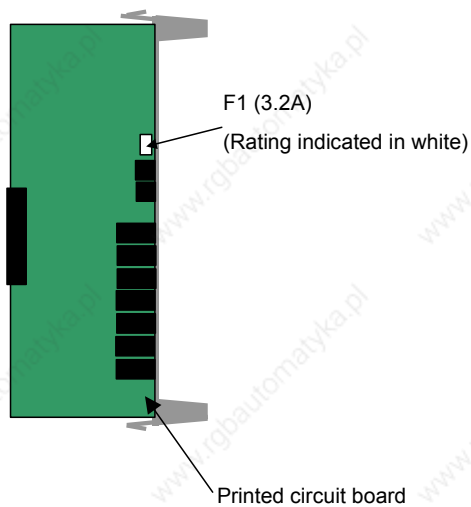

Fuse specification

Symbol	Ordering number
F1	A60L-0001-0290/LM32C

III. MOTOR/DETECTOR/AMPLIFIER PREVENTIVE MAINTENANCE

This chapter describes preventive maintenance of motors, detectors, and amplifiers that is to be performed by the customer the machine uses.

Contents

1	MOTOR/DETECTOR/AMPLIFIER PREVENTIVE MAINTENANCE ...	124
1.1	LIST OF MANUALS RELATED TO MOTORS AND AMPLIFIERS	124
1.2	PREVENTIVE MAINTENANCE OF MOTORS AND DETECTORS	125
1.2.1	Warnings, Cautions, and Notes on Preventive Maintenance of Motors and Detectors.....	125
1.2.2	Preventive Maintenance of a Motor (Common to All Models).....	127
1.2.2.1	Main inspection items	127
1.2.2.2	Periodic cleaning of a motor.....	130
1.2.2.3	Notes on motor cleaning.....	130
1.2.2.4	Notes on the cutting fluid (informational).....	130
1.2.3	Routine Inspection of a Spindle Motor with a Through Hole	131
1.2.4	Preventive Maintenance of a Built-in Spindle Motor and Spindle Unit.....	131
1.2.4.1	Routine inspection of the FANUC-NSK spindle unit	132
1.2.4.2	Maintenance of the FANUC-NSK spindle unit.....	132
1.2.4.3	Test run of the FANUC-NSK spindle unit	133
1.2.4.4	Storage method of the FANUC-NSK spindle unit	133
1.2.5	Preventive Maintenance of a Linear Motor.....	133
1.2.5.1	Appearance inspection of the linear motor (magnet plate).....	133
1.2.6	Maintenance of a Detector.....	134
1.2.6.1	Alarms for built-in detectors (α i and β i Pulsecoders) and troubleshooting actions.....	134
1.2.6.2	Alarms for separate detectors and troubleshooting actions	135
1.2.6.3	Detailed troubleshooting methods	135
1.2.6.4	Maintenance of β iS motor Pulsecoders	137
1.3	PREVENTIVE MAINTENANCE OF SERVO AMPLIFIERS	138
1.3.1	Warnings, Cautions, and Notes on Operation of Servo Amplifiers	138
1.3.2	Preventive Maintenance of a Servo Amplifier	141
1.3.3	Maintenance of a Servo Amplifier	142
1.3.3.1	Display of the servo amplifier operation status	142
1.3.3.2	Replacement of a fan motor.....	144
1.4	REPLACING BATTERY FOR ABSOLUTE PULSECODERS	145
1.4.1	Overview	145
1.4.2	Replacing Batteries.....	146
1.4.3	Replacing the Batteries in a Separate Battery Case.....	146
1.4.4	Replacing the Battery Built into the Servo Amplifier	147

1 MOTOR/DETECTOR/AMPLIFIER PREVENTIVE MAINTENANCE

1.1 LIST OF MANUALS RELATED TO MOTORS AND AMPLIFIERS

Details of individual motors and amplifiers are described in the manuals listed in the table below. Before performing periodic inspection or any other maintenance work, consult with the machine tool builder and, if necessary, obtain the latest version of the corresponding manual shown in the list. The information about the specifications of each device, such as the weight and winding resistance value, is given in the relevant "DESCRIPTIONS" manual.

Manual name	Type of manual	Specification number
FANUC AC SERVO MOTOR αi series	DESCRIPTIONS	B-65262EN
FANUC AC SERVO MOTOR $\beta i s$ series	DESCRIPTIONS	B-65302EN
FANUC SYNCHRONOUS BUILT-IN SERVO MOTOR $D i S$ series	DESCRIPTIONS	B-65332EN
FANUC LINEAR MOTOR $L i S$ series	DESCRIPTIONS	B-65382EN
FANUC AC SPINDLE MOTOR αi series	DESCRIPTIONS	B-65272EN
FANUC AC SPINDLE MOTOR βi series	DESCRIPTIONS	B-65312EN
FANUC BUILT-IN SPINDLE MOTOR $B i l$ series	DESCRIPTIONS	B-65292EN
FANUC SYNCHRONOUS BUILT-IN SPINDLE MOTOR $B i S$ series	DESCRIPTIONS	B-65342EN
FANUC - NSK SPINDLE UNIT series	DESCRIPTIONS	B-65352EN
FANUC SERVO AMPLIFIER αi series	DESCRIPTIONS	B-65282EN
FANUC SERVO AMPLIFIER βi series	DESCRIPTIONS	B-65322EN
FANUC AC SERVO MOTOR αi series FANUC AC SERVO MOTOR βi series FANUC LINEAR MOTOR $L i S$ series FANUC SYNCHRONOUS BUILT-IN SERVO MOTOR $D i S$ series	PARAMETER MANUAL	B-65270EN
FANUC AC SPINDLE MOTOR $\alpha i / \beta i$ series BUILT-IN SPINDLE MOTOR $B i$ series	PARAMETER MANUAL	B-65280EN
FANUC AC SERVO MOTOR $\alpha i s / \alpha i$ series AC SPINDLE MOTOR αi series SERVO AMPLIFIER αi series	MAINTENANCE MANUAL	B-65285EN
FANUC AC SERVO MOTOR $\beta i s$ series AC SPINDLE MOTOR βi series SERVO AMPLIFIER βi series	MAINTENANCE MANUAL	B-65325EN
FANUC SERVO AMPLIFIER βi series	MAINTENANCE MANUAL	B-65395EN
FANUC SERVO GUIDE	OPERATOR'S MANUAL	B-65404EN
FANUC AC SERVO MOTOR $\alpha i s / \alpha i / \beta i s$ series	SERVO TUNING PROCEDURE (BASIC)	B-65264EN

1.2 PREVENTIVE MAINTENANCE OF MOTORS AND DETECTORS

1.2.1 Warnings, Cautions, and Notes on Preventive Maintenance of Motors and Detectors

This subsection contains the safety precautions for motor and detector preventive maintenance, which are classified into "warnings", "cautions", and "notes" according to their bearing on safety. Make sure that you understand and comply with these precautions when carrying out the maintenance work.

WARNING

- **Make sure that you are safely dressed and have a safe working environment when performing preventive maintenance for a motor.**
 - Be dressed safely, e.g. by wearing gloves and safety shoes, to protect against injury due to an edge or protrusion and electric shock.
 - Have the work done by more than one person, where possible, so that immediate action can be taken if an accident occurs when handling a motor.
 - A motor is heavy. When moving it, use a crane or other appropriate equipment to protect against injury. For information about the weight of the motor, refer to its DESCRIPTIONS manual (shown earlier).
 - Clothes or fingers can be caught in a rotating motor or come into contact with a moving part of it. Standing in the direction of motor rotation (direction of motion) can pose a risk of injury. Before rotating a motor, check that there is no object that is thrown away by motor rotation.
- **Be careful about electric shock, fire, and other accidents.**
 - Do not handle a motor with a wet hand.
 - To prevent electric shock, make sure that no conductive object, such as a terminal, is exposed when the motor is powered on.
 - Before touching a motor or any surrounding part, check that the power is shut off and take appropriate safety precautions.
 - High voltage remains across power line terminals of a motor even after the power is shut off (for at least five minutes). Do not touch a motor in such a condition or connect it to other equipment.
 - A loose or disconnected terminal, short-circuited terminals, or a terminal connected to the ground can cause overheating, spark, fire, or damage to the motor. Take appropriate precautions to prevent these accidents.
 - When placed near any inflammable object or material, a motor can be ignited, catch fire, or explode. Avoid placing it near such object or material.
- **Do not disassemble or modify a motor.**

Motors such as linear motors, synchronous built-in servo motors, and synchronous built-in spindle motors contain very strong magnets. If electronic medical apparatus comes near, these motors can cause the apparatus to malfunction, potentially putting the user's life in danger. Also, disassembling or modifying a motor can cause a failure, regardless of the type of motor. Do not disassemble or modify a motor in any way not specified by FANUC.

CAUTION

- **Ensure that the specified cooling conditions are met.**
If the specified cooling conditions are not met (the motor is insufficiently or excessively cooled), the motor can fail. Problems that can cause a motor failure, such as liquid piping clog, leakage, and fan motor trouble, should be eliminated through periodic inspection. Do not drive the motor when the cooling system is in an abnormal condition.
- **Do not change the system configuration.**
Do not change the configuration of the system when it is running normally. Doing so can cause an accident or failure. If you disconnect a cable for maintenance or some other purpose, take an appropriate measure, such as putting a mark on it, to ensure you can restore the original state.
- **Use the tapped holes of a motor only to move the motor.**
Do not use the tapped holes of a motor to lift or move any other object along with the motor. Doing so can damage the motor. Depending on the type of motor, the place and direction in which the motor can be lifted may be predetermined. For details, refer to the DESCRIPTIONS manual of the motor (shown earlier).
- **Do not touch a motor when it is running or immediately after it stops.**
A motor may get hot when it is running. Do not touch the motor before it gets cool enough. Otherwise, you may get burned.

NOTE

- **Do not remove a nameplate from a motor.**
The nameplate is used to identify the motor during maintenance work. If a nameplate comes off, be careful not to lose it.
- **Do not step or sit on a motor, and avoid applying shock to a motor.**
Any of these acts can deform or break the motor or affect its component, crippling the normal motor operation. Do not put a motor on top of another motor.
- **Comply with the specified conditions when conducting an electric test (winding resistance test, insulation resistance test, etc.) for a motor or other device or supplying power.**
 - Conduct an electric test according to the specified method. Conducting such a test by any method that is not specified can damage the motor.
 - Do not conduct a dielectric strength test or insulation test for a Pulsecoder or other detector, or do not apply a commercial power source voltage. Doing so can destroy the internal elements.
- **Perform preventive maintenance (inspection of the external appearance, measurement of winding resistance, insulation resistance, etc.) and cleaning on a regular basis.**
To use a motor safely throughout its entire service life, perform preventive maintenance and cleaning on a regular basis. Be careful, however, because excessively severe inspection (dielectric strength test, etc.) can damage its windings. For information about winding resistance values, refer to the DESCRIPTIONS manual of the motor (its specification number is shown in this manual). Information about insulation resistance is given later in this manual.

NOTE

- This manual is focused on the preventive maintenance work to be performed for a single FANUC motor or detector alone. The information contained herein may not apply depending on the type or configuration of the machine. When reading this manual, refer to the manual of the machine as well. If you have any questions or doubts, do not act on your own; please contact the machine tool builder or FANUC.
- For detailed information about a motor, see the manual list shown earlier and, if necessary, obtain the latest version of the corresponding manual.

1.2.2 Preventive Maintenance of a Motor (Common to All Models)

This subsection describes the common preventive maintenance items to be handled regardless of the model of the motor. For the items specific to a particular motor model, see one of the subsequent subsections that pertains to that particular motor model.

CAUTION

- The preventive maintenance method differs from machine to machine in many respects. Depending on the machine in use, it may be difficult for the user to perform periodic inspection or cleaning. If you are not sure about anything as to preventive maintenance, consult with the machine tool builder and ensure that you can perform periodic inspection and cleaning.
- The machine should be used within the scope of specification defined by the machine tool builder. Using the machine in any way that is outside the specified scope can reduce the motor's service life or cause a failure.

1.2.2.1 Main inspection items

The following table summarizes the main inspection items for a motor. If any of these items **is found to be abnormal, stop the use of the machine immediately and fix the abnormal part** by repairing or replacing it. At the same time, **identify and remove the cause and take a measure to prevent its recurrence**. If it is difficult to take a preventive measure or to prevent its recurrence, consult with the machine tool builder or FANUC.

Appearance of the motor	Crack or deformation	<ul style="list-style-type: none"> - Check the motor for any scar, crack, deformation, bulge, etc. - If the interior of the motor is visible or there is interference with a peripheral component, it is imperative to replace the motor or the peripheral component. - A light peel-off or scar of the surface may be repairable; consult with FANUC.
	Wet or dirty part	<ul style="list-style-type: none"> - If you find any wet or dirty part, clean it immediately. - A preventive measure is needed if the part in question remains wet continually due to cutting fluid or dew condensation.
Operating conditions	Temperature, humidity, etc.	<ul style="list-style-type: none"> - Comply with the operating conditions of the machine. For details of the operating conditions of a specific motor, refer to the corresponding DESCRIPTIONS manual. Generally, the ambient temperature should be 0°C to 40°C (or 30°C for a spindle unit) and dew condensation is not allowed. In a place subject to severe vibration, the components of the motor may be broken.

1.MOTOR/DETECTOR/AMPLIFIER MOTOR/DETECTOR/AMPLIFIER

PREVENTIVE MAINTENANCE

PREVENTIVE MAINTENANCE

B-65285EN/04

Connection state	Cable	<ul style="list-style-type: none"> - Check for any cable sheath damage, exposed conductor, damaged conduit or cable bearing, abnormal bending, loose terminal, etc. - If there is any trace of fluid flowing, the fluid may have entered the inside of the motor or connector. It is necessary to make a check and take a measure to prevent recurrence.
	Connector/terminal	<ul style="list-style-type: none"> - Check for any cracked, exposed, loose, or removed terminal or connector, etc. - Fluid causes a failure; be sure to remove fluid. - A scarred or damaged connector or terminal needs to be replaced. In the case of a resin molded motor, such as a linear motor, the motor needs to be replaced.
Operation of the motor	Noise/vibration	<ul style="list-style-type: none"> - Check for any abnormal noise or vibration not only when the motor is running (the spindle is rotating) but also when it is stopped. - Abnormal noise heard when the motor is rotating indicates an abnormality of the bearing or a failure inside the motor. - If abnormal noise is generated from the connection section of a Spindle Amplifier, check the following items: Belt connection: Check whether the belt tension is appropriate. Gear connection: Check whether an appropriate value is set for the gear backlash. Coupling connection: Check whether the coupling is free from deformation, crack, and looseness.
	Movement	<ul style="list-style-type: none"> - Check that the motor operates normally and smoothly. - If the circuit breaker trips at the same time the motor starts to operate, it indicates abnormal motor windings.
	Heat	<p>Check whether the motor does not overheat during the normal operation cycle.</p> <p>Note: While the motor is running or immediately after it is stopped, the motor surface may become very hot. Instead of touching the motor directly by hand, use a thermolabel, surface thermometer, etc.</p>
Electric characteristics of the motor	Winding resistance	<p>If the resistance value exceeds the specified range, the motor needs to be replaced.</p> <p>Note: When conducting winding resistance measurement, disconnect the motor from the amplifier and measure the resistance at the power line or connector closest to the motor.</p>
	Insulation resistance	<p>For the measuring method and judgment criteria, see the table that follows.</p>
Cooling fan (for a model with a fan motor)	Noise/vibration	<ul style="list-style-type: none"> - Check that the fan blows air normally without causing abnormal noise or vibration. - If abnormal noise is heard even when the motor is stopped, it indicates a fan motor failure.
	Movement	<ul style="list-style-type: none"> - If the power is on and if the fan does not operate or the fan blades cannot be moved even manually, or if the fan blades are rotating but no cooling wind is blown out, the fan motor may have cutting chips or sludge accumulated in it and needs to be cleaned. - If the fan does not operate normally for any other reason, the fan motor needs to be replaced.

Forcible cooling unit (when using an external cooling unit such as liquid cooling unit)	Dew condensation (over-cooling)	<ul style="list-style-type: none"> - Check that forcible cooling does not cause dew condensation on the motor surface. Dew condensation is likely particularly when the cooling unit continues to run after the machine is stopped. In that case, be sure to make this check. - Dew condensation or water drop on the motor surface can reduce the motor's service life. It is necessary to wipe it dry and take a measure to prevent recurrence.
	Liquid leakage/clog	<ul style="list-style-type: none"> - Check the cooling pipe for leakage or clog. Do not drive the motor unless the leakage or clog is fixed. - Liquid leakage from a spindle motor with a through hole indicates a failure of the coolant joint. In this case, the joint needs to be replaced. - In the case of liquid leakage from a linear motor (coil slider), the linear motor (coil slider) needs to be replaced. - If the motor gets wet due to liquid leakage or any other cause, it is necessary to clean and dry the motor and perform electric characteristic checks (winding resistance/insulation resistance).

Insulation resistance measurement

The following table shows the judgment criteria to be applied when measuring insulation resistance between winding and frame using a megohmmeter (500 VDC).

Insulation resistance	Judgment
100M Ω or higher	Acceptable
10M to 100M Ω	The winding has begun deteriorating. There is no problem with the performance at present. Be sure to perform periodic inspection.
1M to 10M Ω	The winding has considerably deteriorated. Special care is in need. Be sure to perform periodic inspection.
Lower than 1M Ω	Unacceptable. Replace the motor.

If insulation resistance drops sharply during a short period of time or if the circuit breaker trips, the cutting fluid or other foreign matter may have entered the inside of the motor or cable. In that case, contact the machine tool builder or FANUC for instructions.

CAUTION

- Let the motor dry and cool to room temperature before winding or insulation resistance is measured. Otherwise, not only an accurate measurement cannot be performed but also the motor may be damaged.
- The winding or insulation resistance measurement should be performed on the motor alone, with its power line disconnected. Measuring insulation resistance with the motor connected to the amplifier may damage the amplifier.
- During insulation resistance measurement, applying voltage to the motor for a long time may further deteriorate the insulation of the motor. Therefore, the measurement of insulation resistance should be performed in a minimum amount of time where possible.
- When disconnecting the power line and other cables, take an appropriate measure, such as labeling, to ensure that they can be restored to their original state.

1.2.2.2 Periodic cleaning of a motor

Periodic cleaning is necessary to remove an accumulation of cutting chips or sludge that may eventually cause a failure. Also, leaving the cutting fluid or other chemical substance attached for a long time can reduce the motor's service life substantially. When forcible cooling is provided by a liquid or air cooling unit, check the unit for pipe clog, fan failure, etc. and perform cleaning periodically to ensure that the coolant flows smoothly and that the motor is cooled properly.



WARNING

Depending on the type of motor, the handling may involve a risk and require safety education in advance. Also, some machines are difficult for users to clean on their own. If you are to clean the motor, consult with the machine tool builder in advance with regard to the cleaning method, safety education, etc.

1.2.2.3 Notes on motor cleaning

A motor is an electric product, which is incompatible with most kinds of fluid. When removing cutting chips, sludge, cutting fluid, etc. during cleaning, note the following.

Note on cleaning	Measure
Do not sprinkle fluid. Do not wash by submerging.	Do not sprinkle or spray detergent or any other fluid over the motor (including its peripheral components), or do not wash the motor by submerging it in such fluid. When cleaning the motor, use a cloth moistened with a small amount of neutral detergent so that the fluid does not enter the inside the motor.
Do not use solvent.	Solvent may damage the motor; do not use one. If the dirt is difficult to remove with neutral detergent, use a cloth moistened with a small amount of industrial alcohol (e.g., IPA). Be careful, however, because rubbing with force or repeatedly may damage the coated or resin surface.
Do not leave the motor wet or moistened.	If the motor is wet or moistened after cleaning, dry it before supplying power and before performing electric tests. When drying the motor in an oven, make sure that the temperature is below 40°C and that hot air does not blow directly against the motor.

1.2.2.4 Notes on the cutting fluid (informational)

Depending on the type of cutting fluid used, the motor and amplifier may be affected greatly. Take due care because, even if you ensure that they do not come into direct contact with the fluid, a mist or atmosphere of the fluid can cause the problems described below.

Type of cutting fluid requiring care	Expected problem
Cutting fluid containing highly active sulfur	Some types of cutting fluid contain highly active sulfur. If such cutting fluid enters the inside of the motor or amplifier, it causes copper, silver, and other kinds of metal to corrode, leading to a component failure.
Synthetic cutting fluid with high permeability	Some types of cutting fluid containing such substance as polyalkylene glycol have very high permeability. Such cutting fluid permeates into the inside of the motor, causing insulation deterioration or component failure.
Highly alkaline, water-soluble cutting fluid	Some types of cutting fluid that enhance their alkaline property using such substance as alkanolamine remain highly alkaline - pH10 or higher - when diluted. If such cutting fluid is left attached for a long time, its chemical change will deteriorate the resin and other materials of the motor and amplifier.

Other types of cutting fluid not mentioned above may cause various unexpected problems. If any problem arises for which the cutting fluid is thought to be responsible, consult with the machine tool builder or FANUC.

1.2.3 Routine Inspection of a Spindle Motor with a Through Hole

- Check whether coolant does not always leak from the drain on the rotation joint support housing. (See Fig. 2)
- Check whether coolant does not always leak from the notch on the rotation joint support housing. (See Fig. 2)
- Check whether coolant leaking from the coolant joint does not leak from the coupling. (See Fig. 3)
- Check whether leaking coolant is not collected in the coupling box.

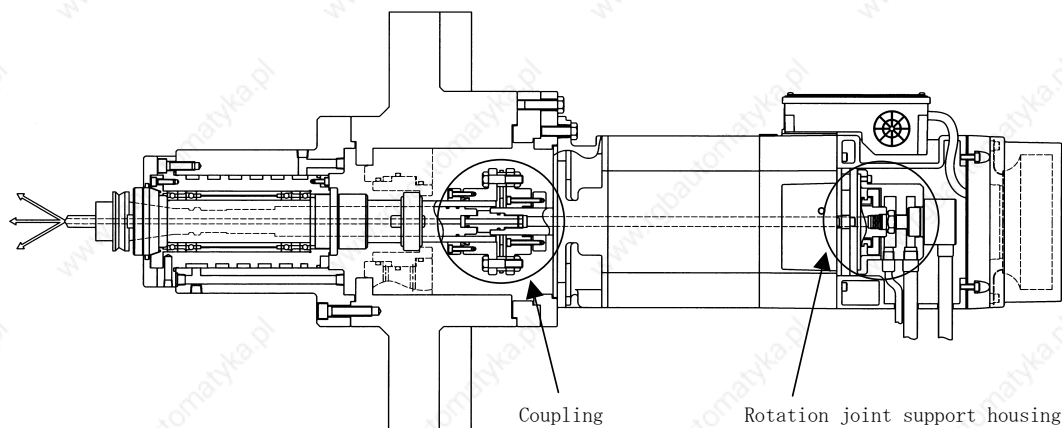

Fig. 1: Example of using a coolant-through spindle motor

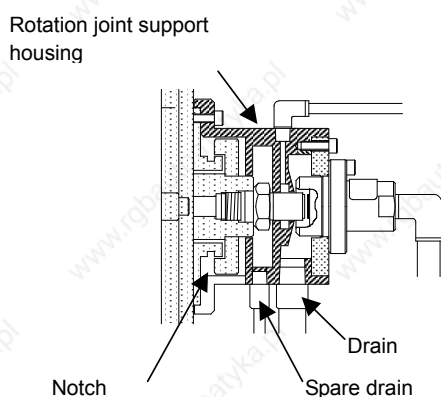

Fig. 2: Rotation joint support housing

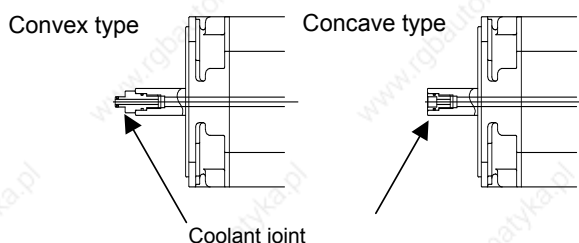

Fig. 3: Example of a coolant joint

1.2.4 Preventive Maintenance of a Built-in Spindle Motor and Spindle Unit

This subsection contains the safety precautions you need to bear in mind when performing preventive maintenance for a built-in spindle motor (BiI or BiS Series) or the FANUC-NSK spindle unit. In some cases, the work may involve a life-threatening risk or cause substantial damage. Make sure that you fully understand these safety precautions before carrying out the work.

⚠ WARNING

- Do not disassemble the spindle. Particularly, the rotor of a synchronous built-in spindle motor (BiS Series) uses strong permanent magnets. The strong magnet force may cause injury or medical appliance malfunction.
- Do not operate a synchronous built-in spindle motor with an external engine. Doing so is very dangerous because it makes the motor act as a power generator, generating high voltage. A power outage is also dangerous because the motor runs freely and, again, generates high voltage. As a safety precaution, a sub module SM (SSM) is connected between motor and amplifier. Do not disconnect the SSM under any circumstances. Also, connect the machine frame to the ground to prevent electric shock.
- A synchronous built-in spindle motor may perform a pole position detection operation when it receives the first rotation command after it is powered on or recovers from an alarm. The pole position detection operation takes 20 to 60 seconds to complete, during which the spindle behaves oddly, e.g., rotating clockwise and counterclockwise alternately in rapid succession. This phenomenon is not abnormal. During the detection operation, do not touch or look down at the spindle, which is a dangerous act.

⚠ CAUTION

Performing a test run described in Chapter 3, "TEST RUN METHOD", in Part IV, of "FANUC - NSK SPINDLE UNIT series DESCRIPTIONS (B-65352EN)" and the inspection and maintenance work described in this manual is the condition for guaranteeing the operation of the FANUC-NSK spindle unit. Be sure to perform the test run and inspection and maintenance work as instructed.

1.2.4.1 Routine inspection of the FANUC-NSK spindle unit

Perform the following routine inspections every day at the start of operation so that stable performance can be obtained from the spindle.

	Item	Check
1	Check if the axis, when turned manually, rotates lightly and smoothly. ⚠ WARNING When turning the axis manually, be sure to turn off the power to the machine.	
2	Check if cuttings and coolant residuals are attached to the periphery of a slinger.	
3	Check if dust such as cuttings is attached to the spindle taper portion.	
4	For operation at 15,000 min ⁻¹ or more immediately after power-up, increase the speed gradually by using the spindle override function. (This substitutes for a simple test run.)	
5	Check if an abnormal sound is generated.	
6	Check if an abnormal vibration is generated.	
7	Check if an abnormal heat is generated.	

1.2.4.2 Maintenance of the FANUC-NSK spindle unit

A FANUC-NSK spindle unit with a grease unit requires periodical maintenance for consumable/wear parts, such as supplying grease. Depending on the use frequency of and damage to parts, **maintenance generally becomes necessary after two years of machine operation or 10,000 hours of spindle operation.** Contact FANUC or the machine tool builder when maintenance becomes necessary. Also, an effective way to reduce the machine down time due to maintenance is to prepare spare parts; consult with the machine tool builder.

1.2.4.3 Test run of the FANUC-NSK spindle unit

If any of the following cases applies, be sure to contact the machine tool builder and perform a test run as described in **Chapter 3, "TEST RUN METHOD", in Part IV, of "FANUC - NSK SPINDLE UNIT series DESCRIPTIONS (B-65352EN)"**.

- If the spindle unit is rotated for the first time after it is unpacked or attached to the machine
- If the machine or spindle unit has undergone transportation or relocation
- If the spindle unit alone has been stored for a period longer than six months or has not been used for one month or more after installation

CAUTION

FANUC assumes no responsibility for any damage resulting from the failure to perform a test run or improper use of the spindle unit.

1.2.4.4 Storage method of the FANUC-NSK spindle unit

Apply rust-proof oil to the surface of the spindle unit, pack the spindle unit, and store the packed spindle unit at a location that satisfies the conditions described below. Also, follow the "This Side Up" and "No Pile Up" instructions indicated on the pack surface.

- Indoor well ventilated place not exposed to direct sunlight (place where the temperature varies little, the room temperature is within 5°C to 40°C, and the humidity is 35% to 85% RH)
- Place on the shelf subject to little vibration and dust (Do not place the spindle unit directly on the floor; vibration and dust can damage the bearing or other parts of the spindle.)

Before using the spindle unit after a storage period of one month or more, make necessary checks, such as measuring winding and insulation resistance, examining the appearance for rust and other problems, and checking whether the axis can be turned manually. Depending on the storage period, a test run may be necessary (described earlier).

1.2.5 Preventive Maintenance of a Linear Motor

The magnet plate of a linear motor contains very strong magnets. When performing the maintenance work, make sure all those engaged in the work fully understand the potential risks involved.

WARNING

- The FANUC linear motors use very strong magnets. Improper handling of the motor is very dangerous and can lead to a serious accident. Particularly, a person wearing a pacemaker or other medical apparatus should stay away from the linear motor; otherwise, the apparatus may malfunction, potentially resulting in a life-threatening accident.
- Those who will come near or touch a linear motor for maintenance work should receive safety education in advance. For details, contact the machine tool builder or FANUC.

1.2.5.1 Appearance inspection of the linear motor (magnet plate)

Perform an appearance inspection as well during cleaning or other maintenance work. A crack, chip, deformation, or any other abnormality in appearance of the motor can lead to a serious failure in the not-so-distant future. If you find any such abnormality, be sure to report it to the machine tool builder. A scratch or other slight scar on the motor surface can also be a sign of future trouble and needs to be addressed with care. Some suggested appearance inspection items for the magnet plate are described below.

- * For the coil slider (the side to which the power line is connected), see "Main inspection items" earlier in this manual.

Appearance of the magnet plate (which may have a stainless cover)

Appearance inspection item	Measure
Crack or chip in the magnet plate resin Deformation or bulge of the magnet plate or softening of the resin	The magnet plate needs to be replaced. If unattended, it can cause trouble in the not-so-distant future. If the problem is extremely minor, consult with the machine tool builder or FANUC.
The magnet is exposed, or the resin or magnet is floating	The magnet plate needs to be replaced urgently.
Scratch on the magnet plate	Foreign matter may have entered into the motor, or interference between parts is likely. It is necessary to eliminate the cause and take a measure to prevent recurrence.
Floating, bulging, or deformed stainless cover	The cover or magnet plate needs to be replaced.

1.2.6 Maintenance of a Detector

⚠ CAUTION

- Detectors such as Pulsecoders are precision equipment. When handling a detector, avoid applying shock to it. Also, exercise care to prevent cutting powder, dust, cutting fluid, or other foreign matter from attaching to it.
- Make sure that all connectors are connected properly and securely. A connection failure can cause an alarm or some other problem.
- If the detector and/or connectors are not installed securely, cutting fluid may enter the inside of the detector, making it necessary to replace the detector. In that case, contact the machine tool builder or FANUC.

NOTE

If you use a detector not manufactured by FANUC, contact the machine tool builder or detector manufacturer for detailed information on the detector.

1.2.6.1 Alarms for built-in detectors (α_i and β_i Pulsecoders) and troubleshooting actions

These alarms concern built-in detectors that are connected directly to the control unit (CNC/servo amplifier).

Based on the alarm number and description, take an appropriate action as described in the following subsection, "Detailed troubleshooting methods".

Alarm No.: Alarm	Description	Possible cause	Action	Detailed troubleshooting method
361: ABNORMAL PHASE DATA(INT)	- Communication error in the Pulsecoder - ID data error	- Pulse coder failure - Noise	Replace the Pulsecoder.	(3) (4)
364: SOFT PHASE ALARM(INT)	Position data alarm	- Noise - Entry of cutting fluid	Check the effect of noise. Replace the Pulsecoder.	(1) (3)
365: BROKEN LED(INT)	LED disconnection	- Pulse coder failure	Replace the Pulsecoder.	(3)

Alarm No.: Alarm	Description	Possible cause	Action	Detailed troubleshooting method
366: PULSE MISS(INT)	Small internal signal amplitude	- Pulse coder failure - Noise	Replace the Pulsecoder.	(3) (4)
367: COUNT MISS(INT)	Position data count error	- Pulse coder failure - Noise	Replace the Pulsecoder.	(3) (4)
368: SERIAL DATA ERROR(INT)	Communication interruption	- Cable disconnection - Pulse coder failure - Noise	Check the cable. Replace the Pulsecoder.	(2) (3) (4)
369: DATA TRANS. ERROR(INT)	Communication data alarm	- Noise	Check the effect of noise.	(1)
453: SPC SOFT DISCONNECT ALARM	Position - pole data error	- Pulse coder failure - Entry of cutting fluid	Replace the Pulsecoder.	(3)

1.2.6.2 Alarms for separate detectors and troubleshooting actions

These alarms concern separate detectors that are connected to the control unit via a separate detector interface unit (SDU).

Based on the alarm number and description, take an appropriate action as described in the following subsection, "Detailed troubleshooting methods".

Alarm No.: Alarm	Description	Possible cause	Action	Detailed troubleshooting method
380: BROKEN LED(EXT)	LED disconnection	- Detector failure	Replace the detector.	(4)
382: COUNT MISS(EXT)	Position data count error			
383: PULSE MISS(EXT)	Small internal signal amplitude			
384: SOFT PHASE ALARM(EXT)	Position data alarm			
385: SERIAL DATA ERROR(EXT)	Communication interruption	- Cable disconnection - Noise - Detector failure	Check the cable. Check the effect of noise. Replace the detector.	(2) (1) (4)
386: DATA TRANS. ERROR(EXT)	Communication data alarm	- Noise	Check the effect of noise.	(1)
381: ABNORMAL PHASE (EXT) 387: ABNORMAL ENCODER(EXT)	For details, contact the machine tool builder or detector manufacturer.			

1.2.6.3 Detailed troubleshooting methods

(1) Checking the effect of noise

Check CNC diagnosis information No.356 (Built-in detector), No.357 (Separate detector).

Normally, 0 is displayed. However, if the position data from the Pulsecoder becomes unstable due to noise or some other factor, this value is incremented. The value is cleared when the CNC unit is powered off. Immediately after the power is turned on, 0 is displayed.

(2) Checking the cable

Check whether the feedback cable is not disconnected and whether the connector is properly plugged.

(3) Replacing the Pulsecoder

(3)-1 Pulse coder replacement procedure

<1> Remove the four M4 hexagon socket head cap screws fastening the Pulsecoder. The M3 bolts fastening the Pulsecoder cover do not need to be loosed. (See the figure at right.)

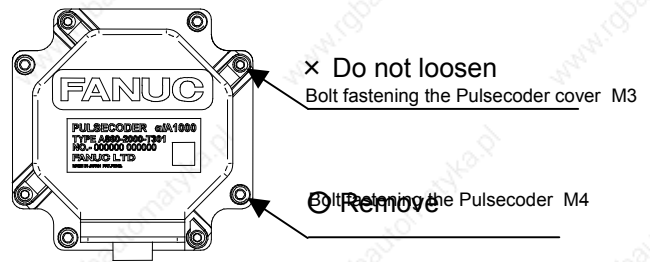

<2> Remove the Pulsecoder and Oldham's coupling (see the following figure).

<3> Set the new Pulsecoder and Oldham's coupling on the motor. Adjust the direction of the mate Oldham's coupling to that of the Oldham's coupling so that the teeth are engaged.

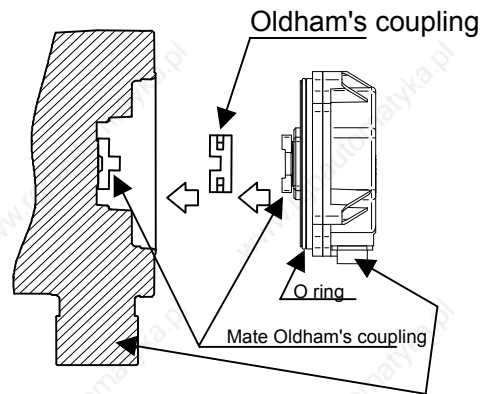

Push in the Pulsecoder until the O ring fits in the joint between the motor and Pulsecoder. Take care so that the O ring of the Pulsecoder is not bitten.

Adjust the connector direction

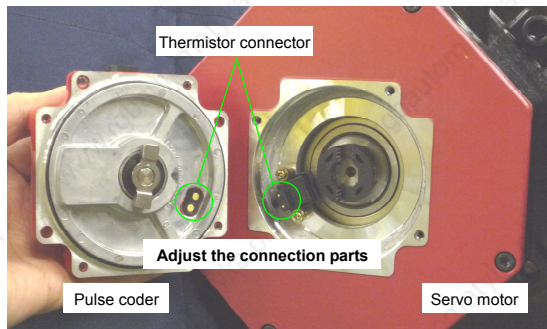

Attach the Pulsecoder in such a direction that the power connector of the servo motor and the feedback cable of the Pulsecoder face the same direction or that the thermistor connection parts of the servo motor and Pulsecoder match each other (see the figure at left).

<4> Fastening the Pulsecoder with the four M4 hexagon socket head cap screws. (Appropriate torque: 1.5 Nm)

(3)-2 Feedback cable plugging procedure

Plug in the feedback cable connector, as instructed in the procedure below, and check that the connector is securely connected.

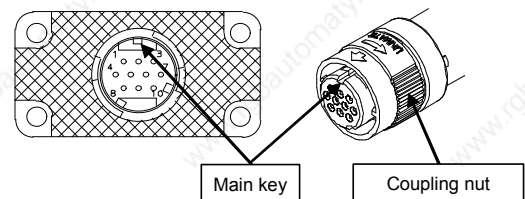

<1> Check the plugging side and key direction. Check that the plugging side is free of foreign matter, such as dirt or oil.

<2> Plug in the feedback cable connector. Hold the connector, as shown in the figure at right. Plug in the connector until you hear a click.

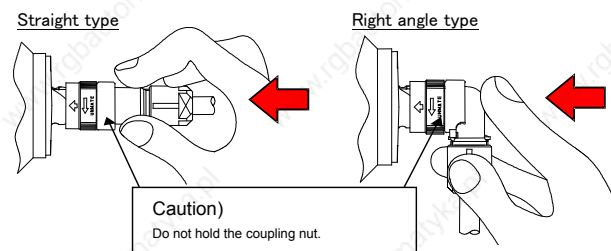

<3> Check the connection condition.

1. Check that the arrow mark of the connector is at the center, as shown in the figure at right. If the arrow mark is not at the center, turn the coupling nut manually until the mark comes to the appropriate position.

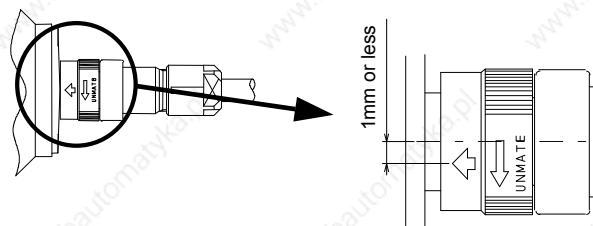

2. Hold the connector by the same part as in <2>, and pull it lightly to check that the connector does not come off. Do not pull the cable.

(4) If troubleshooting is difficult for the user

If the problem is difficult for the user to troubleshoot because it is due to a detector failure or noise, consult with the machine tool builder or FANUC.

1.2.6.4 Maintenance of β iS motor Pulsecoders

Problems concerning the Pulsecoders of the motors listed in the table below require the maintenance (replacement) of the entire motor (it is not possible to maintain the Pulsecoder alone).

Motor model	Motor specification	Remarks
β iS 0.2/5000	A06B-0111-Bx03	x=1,2,4,5
β iS 0.3/5000	A06B-0112-Bx03	
β iS 0.4/5000	A06B-0114-Bx03#0y00	x=1,2,4,5 y=0,1
β iS 0.5/6000	A06B-0115-Bx03#0y00	
β iS 1/6000	A06B-0116-Bx03#0y00	

1.3 PREVENTIVE MAINTENANCE OF SERVO AMPLIFIERS

1.3.1 Warnings, Cautions, and Notes on Operation of Servo Amplifiers

This subsection contains the safety precautions on preventive maintenance of a servo amplifier (a generic term to refer to the power supply, servo amplifier, spindle amplifier, and other sub modules of a motor drive unit). These precautions are classified into "warnings", "cautions", and "notes" according to their bearing on safety. Make sure that you understand and comply with these precautions when carrying out the maintenance work.

WARNING

- **Make sure that you are safely dressed and have a safe working environment when performing preventive maintenance for a servo amplifier.**
 - Be dressed safely, e.g. by wearing gloves and safety shoes, to protect against injury due to an edge or protrusion and electric shock.
 - Have the work done by more than one person, where possible, so that immediate action can be taken if an accident occurs when handling a motor.
 - A servo amplifier and AC reactor contain heavy components. Be careful when transporting them or mounting them on the power magnetic cabinet. Also be careful not to get your fingers caught between the power magnetics cabinet and servo amplifier.
- **Before turning on the power, check that the door of the power magnetics cabinet and all other doors.**
 - Ensure that the door of the power magnetics cabinet containing the servo amplifier, as well as all other doors, are closed and locked except during maintenance work.
- **When the need arises to open the door of the power magnetics cabinet, only a person trained in the maintenance of the corresponding machine or equipment should do the task after shutting off the power supply to the power magnetics cabinet by opening both the input circuit breaker of the power magnetics cabinet and the factory switch used to supply power to the cabinet.**
- **Be careful about electric shock, fire, and other accidents.**
 - If the machine must be operated with the door open for adjustment or some other purpose, the operator must keep his or her hands and tools well away from any dangerous voltages. Such work must be done only by a person trained in the maintenance of the machine or equipment.
 - Ensure that the door of the power magnetics cabinet is locked so that the door cannot be opened by anyone, except service personnel or a qualified person trained in maintenance to prevent electric shock, when the servo amplifier is powered on.
 - When the need arises for an operator to open the door of the power magnetics cabinet and perform an operation, ensure that the operator is sufficiently educated in safety or that a protective cover is added to prevent the operator from touching any dangerous part.
 - The servo amplifier contains a large-capacity electrolytic capacitor in it and remains charged for a while after the power is shut off. Before touching the servo amplifier for maintenance or some other purpose, measure the residual voltage of the DC link connection using a tester and check that the red LED for indicating charging is in progress is not lit, in order to ensure safety.
 - After wiring, be sure to close the servo amplifier cover.

- A loose screw or poor connector contact can cause a motor malfunction or overheating, connection to ground, or short-circuit. Be extremely careful with power supply lines, motor power lines, and DC link connections through which a large electric current flows, because a loose screw or poor connector contact may lead to a fire. Tighten screws and connectors using the specified screw tightening torque.
 - The surfaces of the regenerative discharge unit and heat radiator may become very hot. Do not touch them directly by hand.
- **When operating the machine for the first time after preventive maintenance, check that the machine operates as instructed.**
 - To check whether the machine operates as instructed, first specify a small value for the motor and then increase the value gradually. If the motor operates abnormally, perform an emergency stop immediately.
 - When pressing the emergency stop button, check that the motor stops immediately and that the power being supplied to the amplifier is shut off by the magnetic contactor.
 - **Notes on alarms**
 - If the machine stops due to an alarm, check the alarm number. Depending on the alarm issued, if the power is supplied without replacing the failed component, another component may be damaged, making it difficult to identify the original cause of the alarm.
 - Before resetting an alarm, ensure that the original cause of the alarm has been removed.
 - **If the motor causes any abnormal noise or vibration while operating, stop it immediately.**
 - Using the motor in spite of the abnormal noise or vibration may damage the servo amplifier.
 - **Do not disassemble or modify a servo amplifier.**
Do not disassemble or modify a servo amplifier in any way not specified by FANUC; doing so can lead to a failure.

 **CAUTION**

- **Notes on servo amplifier replacement and wiring**
 - The work of servo amplifier replacement and wiring should be carried out by a person trained in the maintenance of the machine and equipment concerned.
 - When replacing a servo amplifier, check that the combination of the amplifier and the motor is appropriate.
 - Check that the servo amplifier is securely mounted on the power magnetics cabinet. If there is any clearance between the power magnetics cabinet and the surface on which the amplifier is mounted, dust entering the gap may hinder the normal operation of the servo amplifier.
 - Ensure that the power supply lines, motor power lines, and signal lines are each connected to the correct terminal or connector.
 - Unless otherwise instructed, do not unplug a connector and plug it back with the power on; doing so may cause the servo amplifier to fail.
 - When mounting or unmounting the servo amplifier, exercise care not to get your fingers caught between the servo amplifier and power magnetics cabinet.
 - Take care not to lose track of removed screws. Turning on the power with any lost screw left in the unit may damage the machine.
 - Exercise care to prevent the power supply lines and motor power lines from being connected to the ground or being short-circuited.
 - Protect the lines from any stress such as bending. Handle the line ends appropriately.

- **Be careful about the handling of a servo amplifier.**
 - Do not disassemble a servo amplifier. Doing so poses the risk of electric shock, because the capacitor may remain charged.
 - Do not apply shock to a servo amplifier. Doing so may damage its components, potentially causing the amplifier to malfunction.
 - Do not apply an excessively large force to plastic parts. If a plastic section breaks, it may damage internal parts, thus hindering normal operation or leading to a risk of injury due to a broken section.

- **Be careful about the operating environment of a servo amplifier.**
 - Prevent conductive, combustible, or corrosive foreign matter, mist, or drops of water from entering the inside of the unit. The entry of any such material may cause the unit to explode, break, malfunction, etc.
 - Exercise care to prevent cutting fluid, oil mist, cutting chips, or other foreign matter from attaching to the radiator or fan motor exposed to the outside of the power magnetics cabinet. Otherwise, the servo amplifier may become unable to meet its specifications. The service lives of the fan motor and semiconductors can also be reduced.

- **Clean the heat sink and fan motor on a regular basis.**
 - Replace the filter of the power magnetics cabinet on a regular basis.
 - Before cleaning the heat sink, shut down the power and ensure that the temperature of the heat sink is as cool as the room temperature. The heat sink is very hot immediately after power shutdown, touching it may cause burn injury.
 - When cleaning the heat sink by blowing air, be careful about dust scattering. Conductive dust attached to the servo amplifier or its peripheral equipment can lead to a failure.

NOTE

- **Make sure that there is sufficient maintenance clearance around the doors of the machine and equipment.**

- **Do not step or sit on the servo amplifier, or do not apply shock to it.**

- **Do not remove a nameplate from a motor.**
 - The nameplate is necessary to identify the servo amplifier during maintenance work.
 - If a nameplate comes off, be careful not to lose it.

NOTE

- This manual is focused on the preventive maintenance work to be performed for a FANUC servo amplifier. The information contained herein may not apply depending on the type or configuration of the machine. When reading this manual, refer to the manual of the machine as well. If you have any questions or doubts, do not act on your own; please contact the machine tool builder or FANUC.
- For detailed information about a servo amplifier, see the manual list shown earlier and, if necessary, obtain the latest version of the corresponding manual.

1.3.2 Preventive Maintenance of a Servo Amplifier

To use a servo amplifier safely throughout its entire service life, perform daily and periodic inspections.

⚠ CAUTION

- The preventive maintenance method differs from machine to machine in many respects. Depending on the machine in use, it may be difficult for the user to perform periodic inspection or cleaning. If you are not sure about anything as to preventive maintenance, consult with the machine tool builder and ensure that you can perform periodic inspection and cleaning.
- The machine should be used within the scope of specification defined by the machine tool builder. Using the machine in any way that is outside the specified scope can reduce the servo amplifier's service life or cause a failure.

Inspection part	Inspection item	Inspection interval		Judgment criterion
		Routine	Periodic	
Operating environment	Ambient temperature	√		Around the power magnetics cabinet: 0°C - 45°C Inside the power magnetics cabinet: 0°C - 55°C
	Humidity	√		90% or below RH (dew condensation not allowed)
	Dust/oil mist	√		There shall be no dust or oil mist attached near the servo amplifier.
	Cooling air path	√		The cooling fan shall be operating normally without the air flow being interrupted.
	Abnormal vibration/noise	√		- No abnormal noise or vibration shall be present that has not been experienced in the past. - Vibration near the servo amplifier shall be 0.5 G or less.
	Supply voltage	√		200-V input type: Within 200 - 240 V 400-V input type: Within 400 - 480 V
Servo amplifier	General	√		There shall be no abnormal noise or smell, and there shall be no dust or oil mist attached.
	Screw		√	There shall be no loose screw.
	Fan motor ^(NOTE 1, 2)	√		- There shall be no abnormal vibration or noise, and the fan blades shall be rotating normally. - There shall be no dust or oil mist attached.
	Connector		√	There shall be no loose or broken connector.
	Cable		√	There shall be no sign of overheating or sheath deterioration (discoloration or crack).
CNC	Absolute ^(NOTE 2) Pulse coder battery	√		The machine operator's panel or screen shall not display the alarm indicating the battery voltage of the absolute Pulsecoder is low.
External equipment	Magnetic contactor		√	The contactor shall not rattle or chatter.
	Ground fault interrupter		√	The interrupter shall be able to trip.
	AC reactor		√	There shall be no hum.

NOTE

- 1 Fan motors are periodic-replacement parts. It is recommended to inspect fan motors on a routine basis and replace them in a preventive manner.
- 2 Fan motors and batteries are periodic-replacement parts. It is recommended to keep spare parts.

1.3.3 Maintenance of a Servo Amplifier

1.3.3.1 Display of the servo amplifier operation status

The STATUS LEDs on the front of the servo amplifier indicate the operation status of the servo amplifier (whether it is operating normally, the type of alarm, etc.). Use these LEDs for maintenance, inspection, troubleshooting, etc.





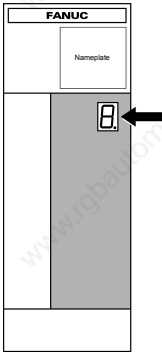

⚠ CAUTION

A servo amplifier failure may arise from a combination of multiple causes, in which case it can be difficult to identify all those causes. Handling the failure in an improper way may worsen the problem. It is therefore important to analyze the failure status minutely and identify the true cause or causes of the failure. There may be cases in which the failure appears to have been fixed but later recurs or cause a more serious trouble. If you are not sure about the root cause of or corrective action for a failure, do not act on your own; please contact the machine tool builder or FANUC for instructions on proper action.

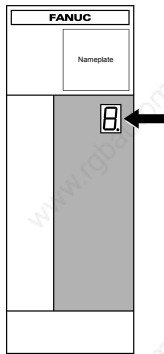









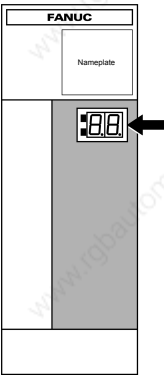





(1) Power supply

STATUS LED position	STATUS display	Description
		The STATUS LED is off. Control power has not been supplied, cable is faulty, or control power circuit is defective.
		Not ready status The main circuit is not supplied with power (magnetic contactor is off); emergency stop state. When blinking: Power is off.
		Ready status The main circuit is supplied with power (magnetic contactor is on); the power supply is ready for operation. When blinking: Power is off.
		Warning state (The dot at the lower right lights.) The power supply has failed; an alarm has occurred after a certain time of operation. The warning type is indicated by the character displayed.
		Alarm status The alarm type is indicated by the character displayed.

(2) Servo amplifier

STATUS LED position	STATUS display	Description
		The STATUS LED is off. Control power has not been supplied, cable is faulty, or control power circuit is defective.
		The control power is short-circuited (- blinks). Cable failure
		Waiting for the READY signal from the CNC.
		Ready status The servo motor is excited.
		Alarm status The alarm type is indicated by the character displayed.

(3) Spindle amplifier

STATUS LED position	STATUS display	Description
	ALM:  ERR: 	The STATUS LED is off. Control power has not been supplied, cable is faulty, or control power circuit is defective.
	ALM:  ERR: 	After control power is turned on, the spindle software series is displayed (for approx. 1 second). The last two digits of the spindle software series number are displayed.
	ALM:  ERR: 	The spindle software version is displayed (for approx. 1 second following the display of the spindle software series). [Display] 01,02,03,... → [Version] A, B, C,...
	ALM:  ERR: 	The CNC is not powered on (- - blinks). Waiting for serial communication and parameter loading completion.
	ALM:  ERR: 	Parameter loading completed The motor is not excited.
	ALM:  ERR: 	Ready status The spindle motor is excited.
	ALM:  ERR: 	Alarm status The alarm type is indicated by the character displayed.
	ALM:  ERR: 	Error status (invalid sequence or parameter setting error) The error type is indicated by the character displayed.

1.3.3.2 Replacement of a fan motor

(1) Fan motor for internal cooling

Replace the internal fan motor, according to the procedure shown in the figure below.

When replacing the fan motor, be careful about the direction of the fan motor (air blow direction), the direction of the connector, etc.

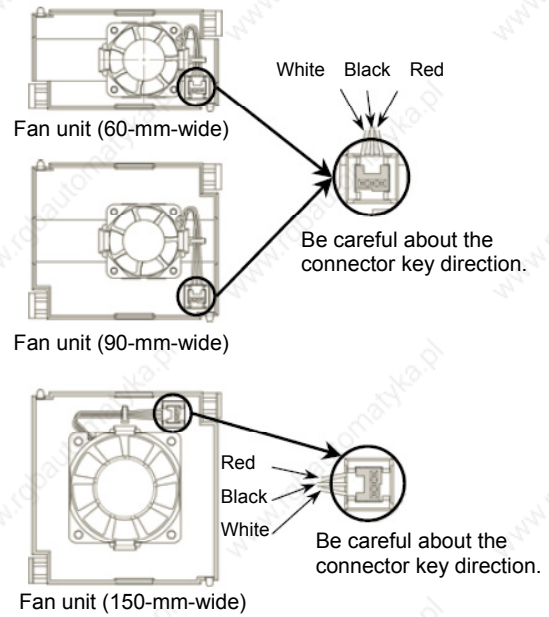
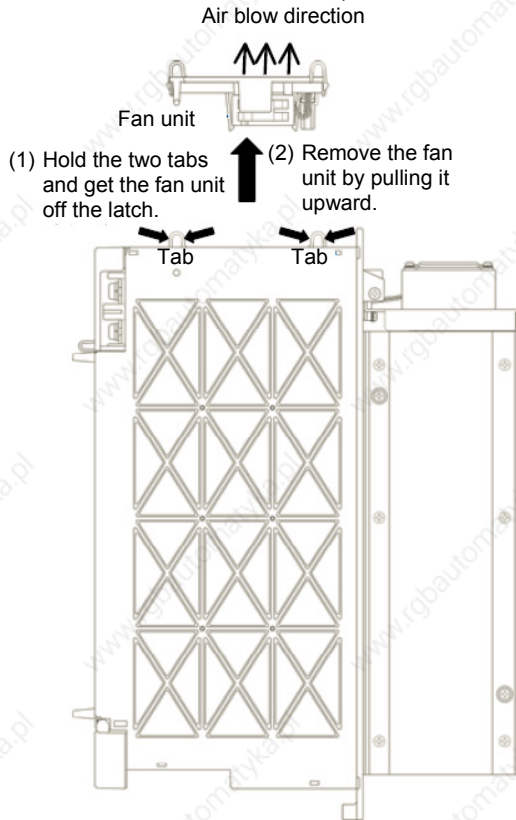

* Be careful about the fan motor and connector directions.

(2) Fan motor for cooling the external radiator

<1> Remove the two sheet metal mounting screws (for the 60-mm-wide model only), and detach the fan motor from the unit together with the sheet metal.

<2> Remove the fan motor mounting screws (two for one fan motor and four for two fan motors).

<3> Remove the connector mounting screws (two and four for the 300-mm-wide model).

When replacing the fan motor, be careful about the direction of the fan motor (air blow direction), the direction of the connector, etc.

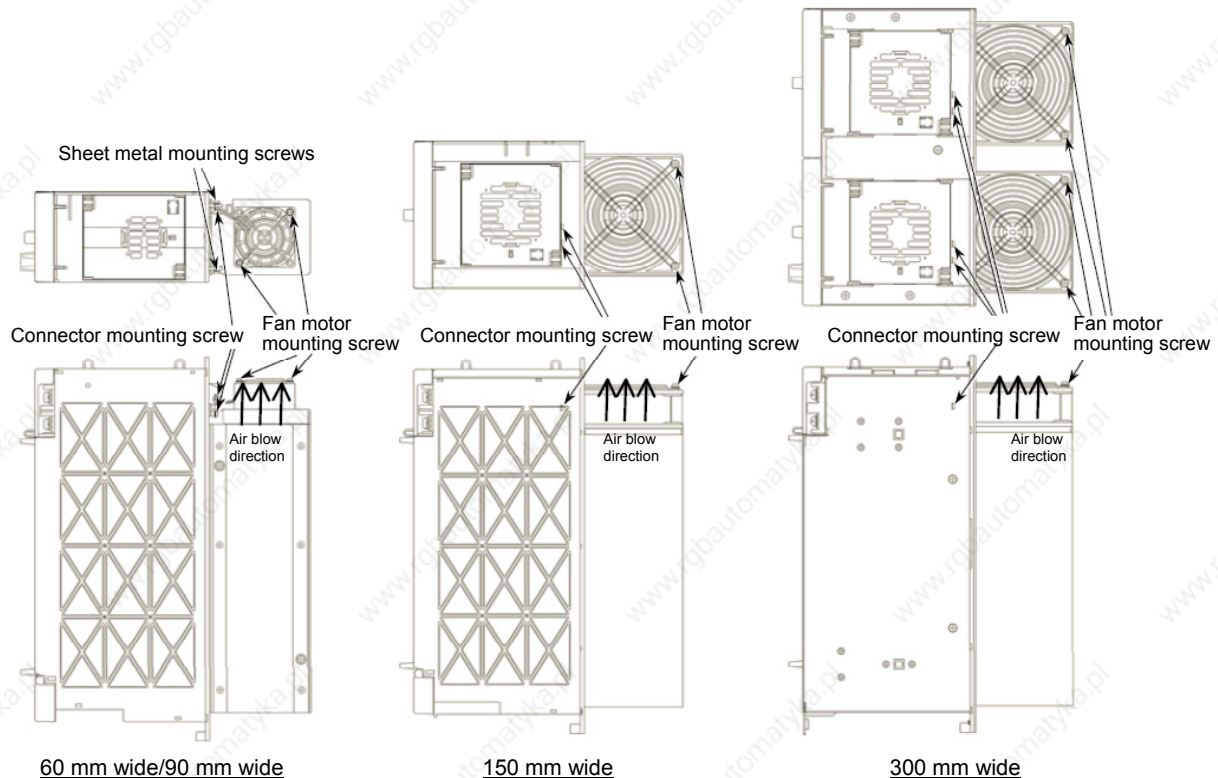

1.4 REPLACING BATTERY FOR ABSOLUTE PULSECODERS

1.4.1 Overview

- When the voltage of the batteries for absolute Pulsecoders becomes low, alarm 307 or 306 occurs, with the following indication in the CNC state display at the bottom of the CNC screen.
Alarm 307 (alarm indicating the voltage of the battery becomes low) :
The indication "APC" blinks in reversed display.
Alarm 306 (battery zero alarm) :
The indication "ALM" blinks in reversed display.
- When alarm 307 (alarm indicating the voltage of the battery becomes low) occurs, replace the battery as soon as possible. In general, the battery should be replaced within one or two weeks, however, this depends on the number of Pulsecoders used.
- When alarm 306 (battery zero alarm) occurs, Pulsecoders are reset to the initial state, in which absolute positions are not held. Alarm 300 (reference position return request alarm) also occurs, indicating that reference position return is required.
- In general, replace the batteries periodically within the service life listed below.
 - A06B-6050-K061 or D-size alkaline dry cells (LR20): Two years (for each six-axis configuration)
 - A06B-6073-K001 : Two years (for each three-axis configuration)
 - A06B-6114-K504 : One year (for each three-axis configuration)

NOTE

The above values indicate the estimated service life of batteries used with FANUC absolute Pulsecoders. The actual battery service life depends on the machine configuration based on, for example, detector types. For details, contact the machine tool builder.

1.4.2 Replacing Batteries

To prevent absolute position information in absolute Pulsecoders from being lost, turn on the machine power before replacing the battery. The replacement procedure is described below.

- <1> Ensure that the power to the servo amplifier is turned on.
- <2> Ensure that the machine is in the emergency stop state (the motor is inactive).
- <3> Ensure that the DC link charge LED of the servo amplifier is off.
- <4> Detach the old batteries and attach new ones.

The replacement of the batteries in a separate battery case and the replacement of the battery built into the servo amplifier are described below in detail.

⚠ WARNING

- The absolute Pulsecoder of each of the $\alpha i/\alpha iS$ series servo motors and the βiS series servo motors ($\beta iS0.4$ to $\beta iS22$) has a built-in backup capacitor. Therefore, even when the power to the servo amplifier is off and the batteries are replaced, reference position return is not required if the replacement completes within less than 10 minutes. Turn the power on and replace the batteries if the replacement will take 10 minutes or more.
- To prevent electric shock, be careful not to touch metal parts in the power magnetics cabinet when replacing the batteries.
- Because the servo amplifier uses a large-capacitance electrolytic capacitor internally, the servo amplifier remains charged for a while even after the power is turned off. Before touching the servo amplifier for maintenance or other purposes, ensure your safety by measuring the residual voltage in the DC link with a tester and confirming that the charge indication LED (red) is off.
- Be sure to replace the batteries with specified ones. Pay attention to the battery polarity. If a wrong type of battery is used or a battery is installed with incorrect polarity, the battery may overheat, blow out, or catch fire, or the absolute position information in the absolute Pulsecoders may be lost.
- Ensure that the battery connector is inserted in the correct position.

1.4.3 Replacing the Batteries in a Separate Battery Case

Use the following procedure to replace the batteries in the battery case.

- <1> Loosen the screws on the battery case and detach the cover.
- <2> Replace the batteries in the case (pay attention to the polarity).
- <3> Attach the cover to the battery case.

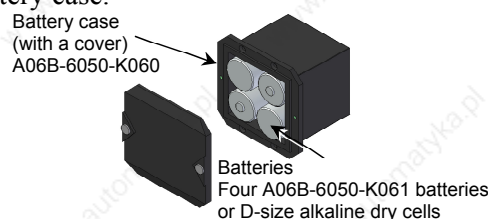

⚠ CAUTION

- Four D-size alkaline dry cells (LR20) that are commercially available can be used as batteries. A set of four A06B-6050-K061 batteries is optionally available from FANUC.
- Replace all the four batteries with new ones. If old and new batteries are mixed, the absolute position information in the absolute Pulsecoders may be lost.

1.4.4 Replacing the Battery Built into the Servo Amplifier

Use the following procedure to replace the special lithium battery.

- <1> Detach the battery case.
- <2> Replace the special lithium battery.
- <3> Attach the battery case.

⚠ CAUTION

- Purchase the battery from FANUC because it is not commercially available. It is therefore recommended that you have a backup battery.
- When the built-in battery is used, do not connect BATL (B3) of connector CXA2A/CXA2B. Also, do not connect two or more batteries to the same BATL (B3) line. These connections are dangerous because battery output voltages may be short-circuited, causing the batteries to overheat.
- Install the battery in the servo amplifier in a direction that allows slack in the cable. If the battery cable is under tension, a bad connection may occur.
- If the +6 V pin and 0 V pin are short-circuited, the battery may overheat, blow out, or catch fire, or the absolute position information in the absolute Pulsecoders may be lost.
- When inserting the connector, align it to the connector pins.

[Connecting the battery]

The battery for the αi series amplifiers is mounted at the front of each of the amplifiers.

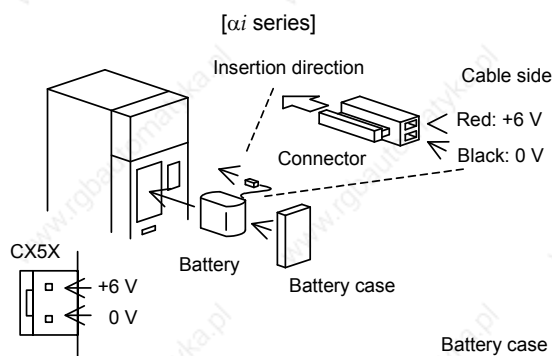
**[Battery sets and outlines]**

Battery ordering drawing number	Manufacturer model number	Applicable servo amplifier	Battery case ordering drawing number	Outline
A06B-6114-K504 (Note)	BR-2/3AGCT4A (Panasonic)	αi series 60/90 mm width	A06B-6114-K505	
		αi series 150/300 mm width	A06B-6114-K506	

NOTE

When using an old-type battery BR-CCF2TH, order a battery case applicable for battery A06B-6114-K504.

Used batteries

Old batteries should be disposed as "INDUSTRIAL WASTES" according to the regulations of the country or autonomy where your machine has been installed.

IV. MOTOR MAINTENANCE

1 SERVO MOTOR MAINTENANCE

1.1 SERVO MOTOR MAINTENANCE PARTS

1.1.1 Pulsecoder

The following lists the ordering specification numbers for maintenance.

(1) Pulsecoder: ordering specification

Motor model	Motor specification	Pulsecoder: ordering specification			
<i>α</i> S series <i>α</i> F series	A06B-02aa-BccX (aa, cc : Any)	X=0	A860-2000-T301	<i>α</i> iA1000	Standard specification
		X=1	A860-2005-T301	<i>α</i> iI1000	Standard specification
		X=2	A860-2001-T301	<i>α</i> iA16000	Standard specification
	A06B-02aa -BccX #0100 (aa, cc : Any)	X=0	A860-2000-T321	<i>α</i> iA1000	IP67 specification
		X=1	A860-2005-T321	<i>α</i> iI1000	IP67 specification
		X=2	A860-2001-T321	<i>α</i> iA16000	IP67 specification

(2) Oldham's coupling: ordering specification

Motor model	Motor specification	Oldham's coupling: ordering specification
<i>α</i> S series <i>α</i> F series	A06B-02aa-BccX (aa, cc, X : Any)	A290-0501-V535

1.1.2 Cooling Fan

The following lists the ordering specification numbers of cooling fan units.

α iS 50 with Fan, α iS 60 with Fan, α iF 40 with Fan

Motor model	Model name	Motor specification	Fan unit: ordering specification	Remark
α iS series α iF series	α iS 50/3000 with Fan α iS 50/3000HV with Fan	A06B-0275-BXaX A06B-0276-BXaX (X :Any, a=1 or 3)	A06B-0241-K053	200VAC 1-phase
	α iS 60/3000 with Fan α iS 60/3000HV with Fan	A06B-0278-BXaX A06B-0279-BxaX (X :Any, a=1 or 3)		
	α iF 40/3000 with Fan	A06B-0257-BXaX (X :Any, a=1 or 3)		

α iS 100 to α iS 500

Motor model	Model name	Motor specification	Fan unit: ordering specification	Remark
α iS series	α iS 100/2500 with Fan α iS 200/2500 with Fan α iS 300/2000 α iS 500/2000	A06B-0285-BX1X A06B-0288-BX1X A06B-0292-BX1X A06B-0295-BX1X (X : Any)	A290-0281-V053	200VAC 3-phase
	α iS 100/2500HV with Fan α iS 200/2500HV with Fan α iS 300/2000HV α iS 300/3000HV α iS 500/2000HV α iS 500/3000HV	A06B-0286-BX1X A06B-0289-BX1X A06B-0293-BX1X A06B-0290-BX1X A06B-0296-BX1X A06B-0297-BX1X (X : Any)	A290-0281-V054	400VAC 3-phase

α iS 1000HV to α S 3000HV

Motor model	Model name	Motor specification	Fan unit: ordering specification	Remark
α iS series	α iS 1000/2000HV	A06B-0298-BX1X (X : Any)	A290-0298-V054	AC400V 3-phase
	α iS 1000/2000HV	A06B-0098-BXXX (X : Any)	A290-0098-V051	
	α iS 1000/3000HV	A06B-0099-BXXX (X : Any)	A290-0098-V050	
	α iS 2000/2000HV α iS 3000/2000HV	A06B-0091-BX4X A06B-0092-BX4X (X : Any)	A290-0091-T054	

1.2 REPLACING COOLING FANS

This section describes how to replace cooling fan units.
For each motor, replace the cooling fan unit according to the procedure.

⚠ CAUTION

Before replacing a fan motor, remove the power lead to the fan motor and check that the rotation of the fan motor stops.

If the load on the fan motor is high or an invalid phase sequence is made for a 3-phase fan motor, the fan motor may overheat and stop. If the power lead is connected, the fan motor suddenly starts rotating when recovered from overheating.

1.2.1 Replacing a Cooling Fan

1.2.1.1 α iS 50 with Fan, α iS 60 with Fan, and α iF 40 with Fan

(1) Removing a cooling fan unit

- <1> Remove six M6 pan head machine screws fastening the fan cover and remove the front fan cover. You need only to loosen the pan head machine screws indicated by the arrow in the figure.

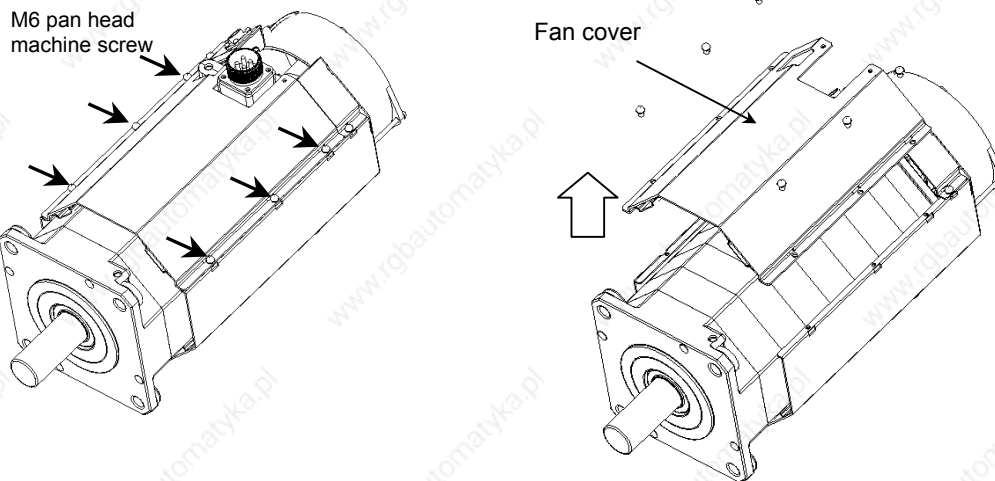

- <2> Remove the cooling fan unit from the motor.

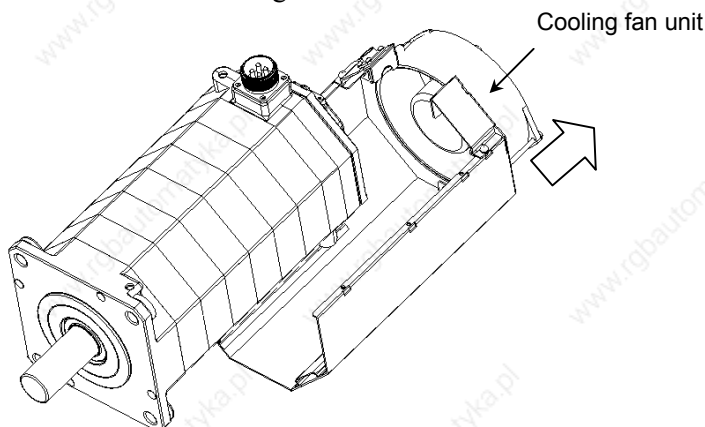

(2) Mounting a cooling fan unit

<1> Remove six M6 pan head machine screws from a new cooling fan unit and remove the front fan cover.

You need only to loosen the pan head machine screws indicated by the arrow in the figure.

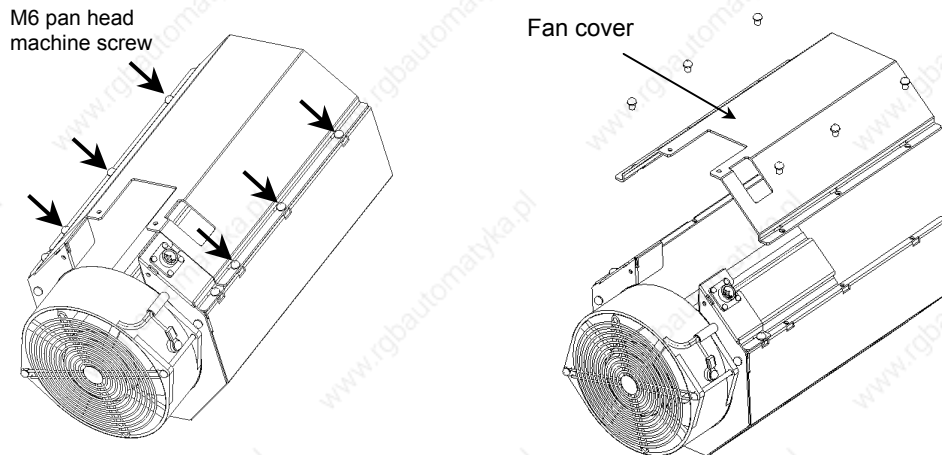

<2> Assemble the cooling fan unit and motor.

Align the inside of the sheet metal of the cooling fan unit with the side of the motor and touch the end of the sheet metal with the back of the motor. (See the figure below.)

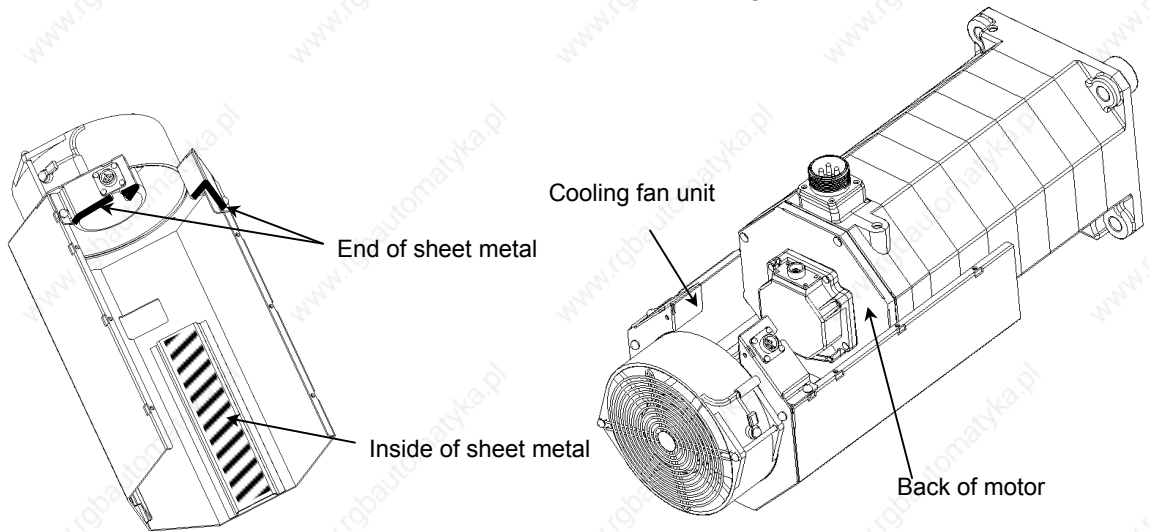

- <2> Mount the fan cover and tighten the six M6 pan head machine screws.
(Appropriate torque: 2.5 to 2.8 Nm)

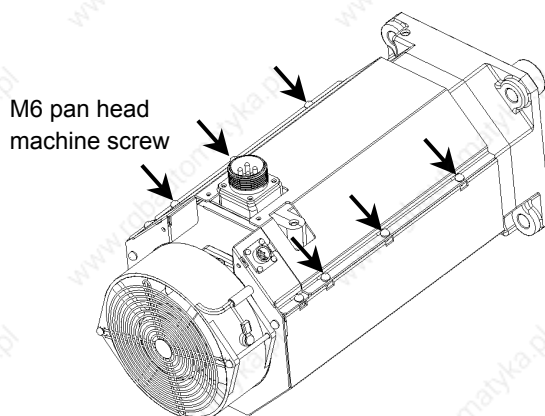

1.2.1.2 α iS 100 with Fan and α iS 200 with Fan (including HV)

- (1) Removing a cooling fan unit
Remove the four M6 hexagon socket head cap screws fastening the fan unit and remove the fan unit.
- (2) Mounting a cooling fan unit
Apply adhesive for fastening (moderate strength) to the four M6 hexagon socket head cap screws and mount the fan unit. (Appropriate torque: 3.0 to 3.5 Nm)

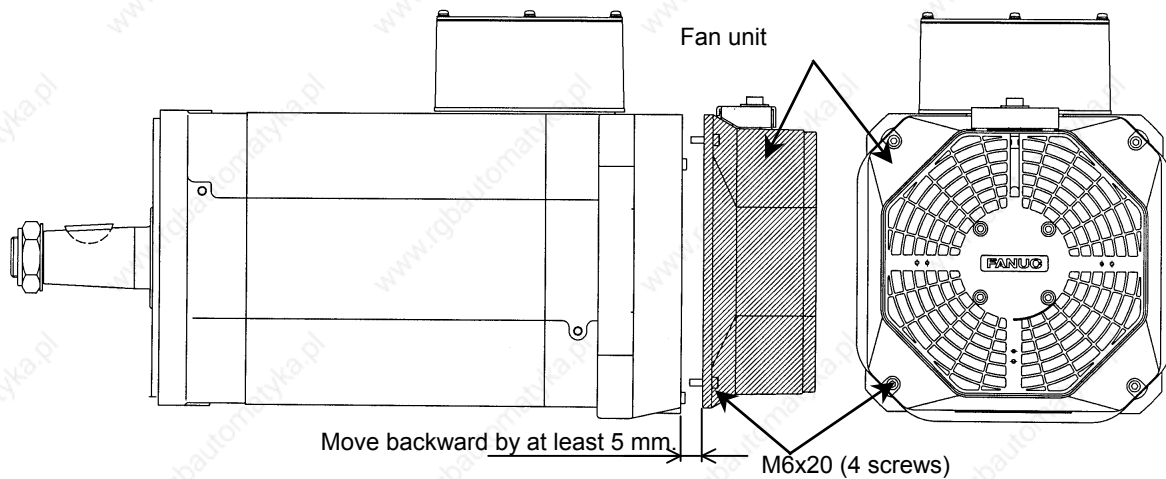

1.2.1.3 α iS 300 and α iS 500 (including HV)

- (1) Removing a cooling fan unit
Remove the four M6 hexagon socket head cap screws fastening the fan unit and remove the fan unit.
- (2) Mounting a cooling fan unit
Apply adhesive for fastening (moderate strength) to the four M6 hexagon socket head cap screws and mount the fan unit. (Appropriate torque: 3.0 to 3.5 Nm)

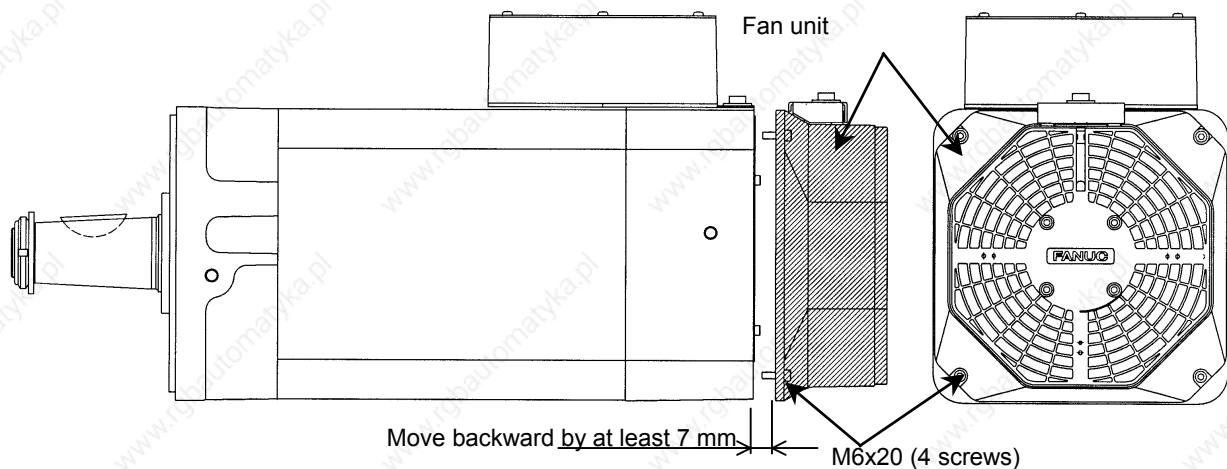

1.2.1.4 α iS 1000HV

- (1) Removing a cooling fan unit
Remove the four hexagon socket head cap screws fastening the fan unit and remove the fan unit.
M6x40: 4 screws (A06B-0298-BXXX)
M10x40: 4 screws (A06B-0098-BXXX, A06B-0099-BXXX)
- (2) Mounting a cooling fan unit
Apply adhesive for fastening (moderate strength) to the four hexagon socket head cap screws and mount the fan unit.
Appropriate torque: 9.6 to 13Nm (M6), 19 to 26Nm (M10)

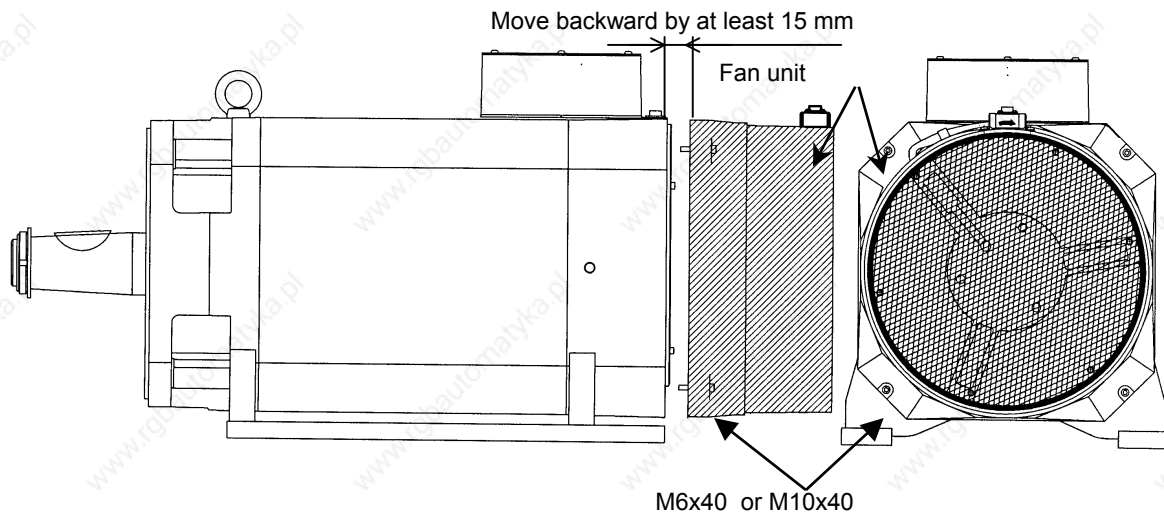
**1.2.1.5 α iS 2000HV and α iS 3000HV**

- (1) Removing a cooling fan unit
Remove the eight M6 hexagon socket head cap screws fastening the fan unit and remove the fan unit.
- (2) Mounting a cooling fan unit
Apply adhesive for fastening (moderate strength) to the eight M6 hexagon socket head cap screws and mount the fan unit. (Appropriate torque: 9.6 to 13 Nm)

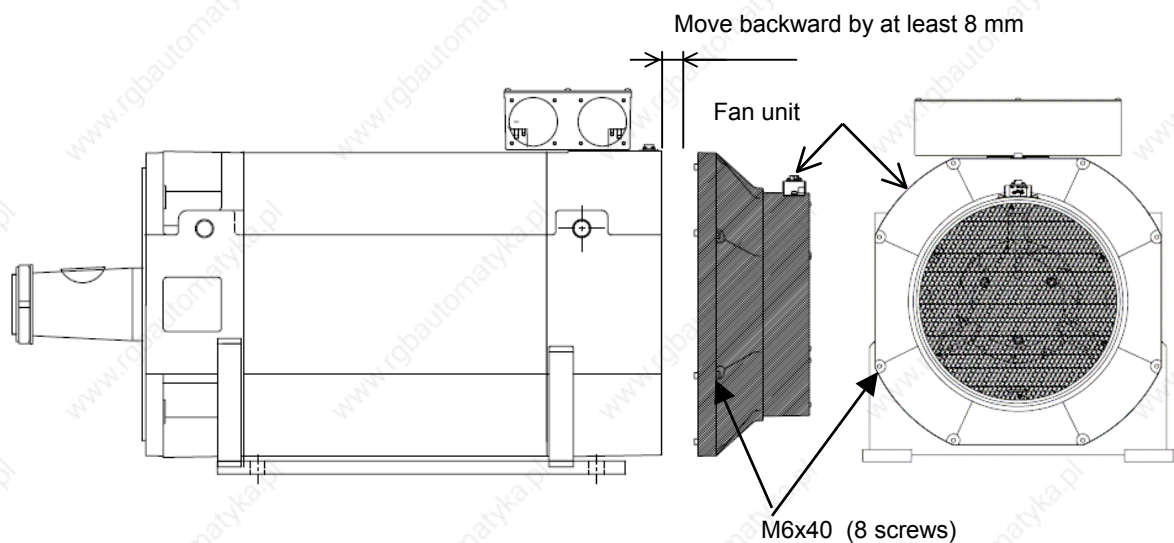

2 SPINDLE MOTOR MAINTENANCE PARTS

2.1 MAINTENANCE PARTS

(1) Parts of the terminal box (αiI , αiI_P , and αCi series 200V type)

Model	Terminal box assembly	Lid of terminal box
αiI 1/10000, αiI 1/15000 αiI 1.5/10000, αiI 1.5/20000 $\alpha C1/6000i$	A290-1402-T400	A290-1402-V410
αiI 2/10000, αiI 2/20000 αiI 3/10000, αiI 3/12000 $\alpha C2/6000i$, $\alpha C3/6000i$	A290-1404-T400	A290-1402-V410
αiI 6/10000 to αiI 15/7000 αiI 6/12000 to αiI 15/12000 αiI_P 12/6000 to αiI_P 22/6000 αiI_P 12/8000 to αiI_P 22/8000 $\alpha C6/6000i$ to $\alpha C15/6000i$	A290-1406-T400	A290-1406-V410
αiI 18/7000, αiI 22/7000	A290-1410-T400	A290-1410-V410
αiI 18/10000, αiI 22/10000 αiI_P 30/6000 to αiI_P 50/6000	A290-1410-T401	A290-1410-V410
αiI 30/6000, αiI 40/6000	A290-1412-T400	A290-1040-V402
αiI 50/5000	A290-1414-T400	A290-1040-V402
αiI_P 60/5000	A290-0833-T400	A290-1040-V402

NOTE

The above table may not apply to motors of which motor drawing number ends with B9xx. Contact your FANUC service representative.

(2) Parts of the terminal box (αiI_T and αiI_L series 200V type)

Model	Terminal box assembly	Lid of terminal box
αiI_T 1.5/20000	A290-1402-T400	A290-1402-V410
αiI_T 2/20000, αiI_T 3/12000	A290-1404-T400	A290-1402-V410
αiI_T 6/12000, αiI_T 8/12000 αiI_T 8/15000, αiI_T 15/10000	A290-1406-T400	A290-1406-V410
αiI_T 15/15000	A290-1410-T402	A290-1410-V410
αiI_T 22/10000	A290-1410-T401	A290-1410-V410
αiI_L 8/20000	A290-1487-T400	A290-1406-V410
αiI_L 15/15000, αiI_L 26/15000	A290-1489-T400	A290-1410-V410

NOTE

The above table may not apply to motors of which motor drawing number ends with B9xx. Contact your FANUC service representative.

(3) Parts of the terminal box ($\alpha i I$ and $\alpha i I_P$ series 400V type)

Model	Terminal box assembly	Lid of terminal box
$\alpha i I$ 1/10000HV, $\alpha i I$ 1.5/10000HV	A290-1502-T400	A290-1402-V410
$\alpha i I$ 2/10000HV, $\alpha i I$ 3/10000HV	A290-1504-T400	A290-1402-V410
$\alpha i I$ 6/10000HV to $\alpha i I$ 22/7000HV $\alpha i I_P$ 15/6000HV, $\alpha i I_P$ 22/6000HV	A290-1406-T400	A290-1406-V410
$\alpha i I_P$ 40/6000HV, $\alpha i I_P$ 50/6000HV	A290-1410-T401	A290-1410-V410
$\alpha i I$ 30/6000HV, $\alpha i I$ 40/6000HV	A290-1412-T400	A290-1040-V402
$\alpha i I$ 50/5000HV	A290-1414-T400	A290-1040-V402
$\alpha i I$ 60/5000HV, $\alpha i I_P$ 60/5000HV	A290-0860-T403	A290-1040-V402
$\alpha i I$ 75/5000HV	A290-1516-T400	A290-1040-V402
$\alpha i I$ 100/5000HV	A290-1516-T410	A290-1040-V402
$\alpha i I$ 100/5000HV(Large terminal box type)	A290-1532-T410	A290-1532-V402
$\alpha i I$ 100/4000HV	A290-0884-T401	A290-1040-V402
$\alpha i I$ 150/5000HV	A290-1532-T400	A290-1532-V402

NOTE

The above table may not apply to motors of which motor drawing number ends with B9xx. Contact your FANUC service representative.

(4) Parts of the terminal box ($\alpha i I_T$ and $\alpha i I_L$ series 400V type)

Model	Terminal box assembly	Lid of terminal box
$\alpha i I_T$ 1.5/20000HV	A290-1502-T400	A290-1402-V410
$\alpha i I_T$ 2/20000HV, $\alpha i I_T$ 3/12000HV	A290-1504-T400	A290-1402-V410
$\alpha i I_T$ 6/12000HV, $\alpha i I_T$ 8/12000HV $\alpha i I_T$ 15/15000HV, $\alpha i I_T$ 22/10000HV	A290-1406-T400	A290-1406-V410
$\alpha i I_L$ 8/20000HV	A290-1597-T400	A290-1406-V410
$\alpha i I_L$ 15/15000HV, $\alpha i I_L$ 26/15000HV	A290-1595-T400	A290-1410-V410

NOTE

The above table may not apply to motors of which motor drawing number ends with B9xx. Contact your FANUC service representative.

2.SPINDLE MOTOR

MAINTENANCE PARTS

MOTOR MAINTENANCE

B-65285EN/04

(5) Fan motor parts (αiI , αiI_P , and αCi series 200V type)

Model	Fan assembly (*1)	Fan cover	Fan motor	Exhaust direction
αiI 1/10000, αiI 1/15000 αiI 1.5/10000, αiI 1.5/20000 $\alpha C1/6000i$	A290-1402-T500	A290-1402-X501	A90L-0001-0537/R	Rear
	A290-1402-T501		A90L-0001-0537/F	Front
αiI 2/10000, αiI 2/20000 αiI 3/10000, αiI 3/12000 $\alpha C2/6000i$, $\alpha C3/6000i$	A290-1404-T500	A290-1404-X501	A90L-0001-0538/R	Rear
	A290-1404-T501		A90L-0001-0538/F	Front
αiI 6/10000, αiI 8/8000 αiI 6/12000, αiI 8/10000 αiI 8/12000 $\alpha C6/6000i$, $\alpha C8/6000i$	A290-1406-T500	A290-1406-X501	A90L-0001-0515/R	Rear
	A290-1406-T501		A90L-0001-0515/F	Front
αiI 12/7000 to αiI 22/7000 αiI 12/10000 to αiI 22/10000 αiI_P 12/6000 to αiI_P 22/6000 αiI_P 12/8000 to αiI_P 22/8000 $\alpha C12/6000i$ to $\alpha C22/6000i$	A290-1408-T500	A290-1408-X501	A90L-0001-0548/R	Rear
	A290-1408-T501		A90L-0001-0548/F	Front
αiI 30/6000, αiI 40/6000 (*2) αiI_P 30/6000 to αiI_P 50/6000 (*2)	A290-1412-T510	-	-	Rear
	A290-1412-T511	-	-	Front
αiI 50/5000 (*2)	A290-1414-T510	-	-	Rear
	A290-1414-T511	-	-	Front
αiI_P 60/5000 (*2)	A290-0832-T510	-	-	Rear
	A290-0832-T511	-	-	Front

NOTE

- 1 These drawing numbers include fan motors.
- 2 In case of exchange these fan motors, please change fan assembly (fan motor with fan cover) unit.
- 3 The above table may not apply to motors of which motor drawing number ends with B9xx. Contact your FANUC service representative.

(6) Fan motor parts (αiI_T series 200V type)

Model name	Fan assembly (*1)	Fan cover	Fan motor
αiI_T 1.5/20000	A290-1463-T500	A290-1402-X501	A90L-0001-0537/RL
αiI_T 2/20000, αiI_T 3/12000	A290-1464-T500	A290-1404-X501	A90L-0001-0538/RL
αiI_T 6/12000 αiI_T 8/12000, αiI_T 8/15000	A290-1466-T500	A290-1406-X501	A90L-0001-0515/RL
αiI_T 15/10000, αiI_T 15/15000 αiI_T 22/10000	A290-1469-T500	A290-1408-X501	A90L-0001-0548/RL

NOTE

- 1 These drawing numbers include fan motors.
- 2 The above table may not apply to motors of which motor drawing number ends with B9xx. Contact your FANUC service representative.

(7) Fan motor parts ($\alpha i I$ and $\alpha i I_P$ series 400V type)

Model	Fan assembly (*1)	Fan cover	Fan motor	Exhaust direction
$\alpha i I$ 1/10000HV, $\alpha i I$ 1.5/10000HV	A290-1502-T500	A290-1402-X501	A90L-0001-0539/R	Rear
	A290-1502-T501		A90L-0001-0539/F	Front
$\alpha i I$ 2/10000HV, $\alpha i I$ 3/10000HV	A290-1504-T500	A290-1404-X501	A90L-0001-0540/R	Rear
	A290-1504-T501		A90L-0001-0540/F	Front
$\alpha i I$ 6/10000HV, $\alpha i I$ 8/8000HV	A290-1506-T500	A290-1406-X501	A90L-0001-0519/R	Rear
	A290-1506-T501		A90L-0001-0519/F	Front
$\alpha i I$ 12/7000HV, $\alpha i I$ 15/7000HV $\alpha i I$ 22/7000HV $\alpha i I_P$ 15/6000HV, $\alpha i I_P$ 22/6000HV	A290-1508-T500	A290-1408-X501	A90L-0001-0549/R	Rear
	A290-1508-T501		A90L-0001-0549/F	Front
$\alpha i I$ 30/6000HV, $\alpha i I$ 40/6000HV (*2) $\alpha i I_P$ 40/6000HV, $\alpha i I_P$ 50/6000HV(*2)	A290-1512-T510	-	-	Rear
	A290-1512-T511	-	-	Front
$\alpha i I$ 60/5000HV (*2) $\alpha i I_P$ 60/5000HV (*2)	A290-0883-T510	-	-	Rear
	A290-0883-T511	-	-	Front
$\alpha i I$ 50/5000HV (*2)	A290-1514-T510	-	-	Rear
	A290-1514-T511	-	-	Front
$\alpha i I$ 75/5000HV, $\alpha i I$ 100/5000HV (*2)	A290-1516-T500	-	-	Rear
$\alpha i I$ 100/4000HV (*2)	A290-0780-T512	-	-	Pedestal-side intake
	A290-0780-T514	-	-	
	A290-0780-T513	-	-	Pedestal-side exhaust
	A290-0780-T515	-	-	
	A290-0884-T500	-	-	Rear
$\alpha i I$ 150/5000HV (*2)	A290-1532-T500	-	-	Rear

NOTE

- 1 These drawing numbers include fan motors.
- 2 In case of exchange these fan motors, please change fan assembly (fan motor with fan cover) unit.
- 3 The above table may not apply to motors of which motor drawing number ends with B9xx. Contact your FANUC service representative.

(8) Fan motor parts ($\alpha i I_T$ series 400V type)

Model name	Fan assembly (*1)	Fan cover	Fan motor
$\alpha i I_T$ 1.5/20000HV	A290-1563-T500	A290-1402-X501	A90L-0001-0539/RL
$\alpha i I_T$ 2/20000HV, $\alpha i I_T$ 3/12000HV	A290-1564-T500	A290-1404-X501	A90L-0001-0540/RL
$\alpha i I_T$ 6/12000HV, $\alpha i I_T$ 8/15000HV	A290-1566-T500	A290-1406-X501	A90L-0001-0519/RL
$\alpha i I_T$ 15/15000HV, $\alpha i I_T$ 22/10000HV	A290-1569-T500	A290-1408-X501	A90L-0001-0549/RL

NOTE

- 1 These drawing numbers include fan motors.
- 2 The above table may not apply to motors of which motor drawing number ends with B9xx. Contact your FANUC service representative.

APPENDIX

A MEASURING SERVO MOTOR WAVEFORMS (TCMD, VCMD)

To use a servo motor in a good performance condition for a long time and prevent any failure from occurring, the TCMD and VCMD waveforms of the servo motor can be checked as diagnosis.

(1) Observation of torque command (TCMD) and speed command (VCMD) waveforms

Check whether there is no abnormality in the waveforms.

For how to measure the TCMD and VCMD waveforms, refer to the FANUC AC SERVO MOTOR α series Parameter Manual (B-65270EN).

The waveforms vary according to the operating conditions such as load and cutting speed. Note that you should make comparisons under the same condition (for example, during fast traverse to the reference position or low-speed cutting).

(2) Diagnosis by waveforms

Check the measured waveforms to see whether:

<1> The peak current is within the limit to the current in the amplifier during rapid traverse, acceleration, or deceleration.(TCMD)

The limit to the amplifier current is listed below.

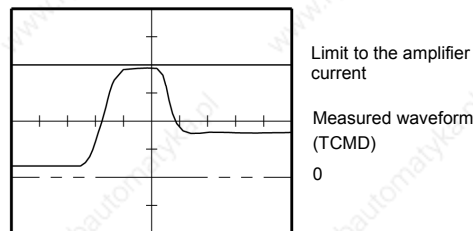

⇒ The motor used to accelerate/decelerate with the amplifier current within the limit (the acceleration/deceleration torque used to be sufficient), but something is wrong now. If this is the case, the probable causes are:

- The load conditions in the machine have changed because of changed friction or reduced machine efficiency after long period of use.
- Motor failure

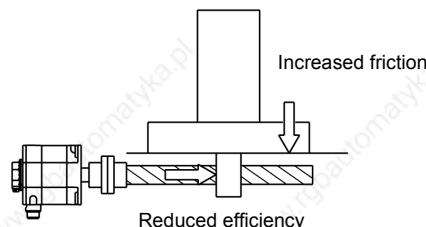

[Table 1]

Models	Current value
<i>αiS2/5000HV, αiS2/6000HV, αiS4/5000HV, αiS4/6000HV</i>	10Ap
<i>αiS2/5000, αiS2/6000, αiS4/5000, αiS4/6000 αiF1/5000, αiF2/5000, αiF4/4000HV, αiF8/3000HV</i>	20Ap
<i>αiS8/4000HV, αiS8/6000HV, αiS12/4000HV, αiF4/4000, αiF8/3000, αiF12/3000HV, αiF22/3000HV,</i>	40Ap
<i>αiS8/4000, αiS8/6000, αiS12/4000, αiS12/6000HV, αiS22/4000HV, αiS22/6000HV, αiS30/4000HV, αiS40/4000HV, αiS50/2000HV, αiS60/2000HV, αiF12/3000, αiF 22/3000,</i>	80Ap
<i>αiS12/6000, αiS22/4000, αiS22/6000, αiS30/4000, αiS40/4000, αiS50/2000, αiS60/2000, αiF30/3000, αiF40/3000, αiF40/3000 with fan</i>	160Ap
<i>αiS50/3000HV with fan, αiS100/2500HV, αiS100/2500HV with fan, αiS 200/2500HV, αiS 200/2500HV with fan</i>	180Ap
<i>αiS50/3000 with fan, αiS100/2500, αiS100/2500 with fan, αiS200/2500, αiS200/2500 with fan, αiS300/2000HV, αiS500/2000HV</i>	360Ap
<i>αiS300/3000HV, αiS500/3000HV</i>	540Ap
<i>αiS300/2000, αiS500/2000, αiS1000/2000HV</i>	360Ap x 2 (Note)
<i>αiS1000/3000HV, αiS2000/2000HV, αiS3000/2000HV</i>	360Ap x 4 (Note)

NOTE

More than one Servo Amplifier is used for one motor.

<2> The waveform has ripple during constant-speed feeding (VCMD).

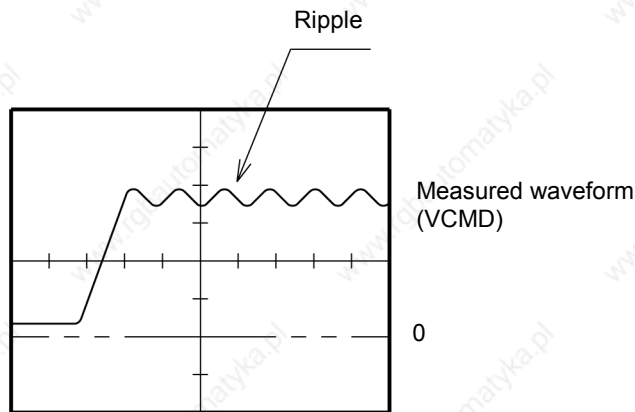

<3> The current waveform has ripple or jumps when the motor is not rotating (VCMD).

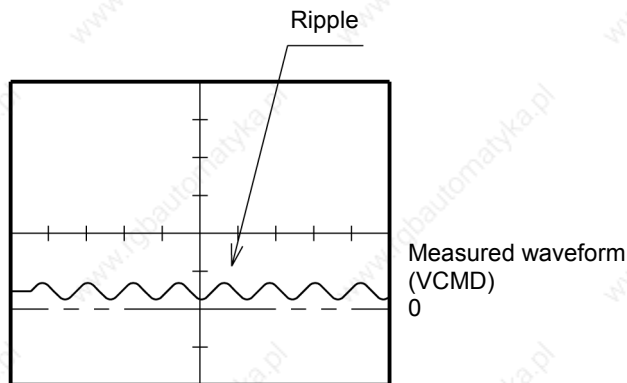

If you find anything unusual in relation to the above items <1> to <3>, contact your FANUC service staff.

INDEX

< α >

α i M sensor, α i MZ sensor, and α i BZ sensor 30

<A>

A specified speed cannot be obtained 24

About the spindle control and spindle status signals 44

Address descriptions and initial values (Spindle Amplifier) 36

Alarm Code 22 86

Alarm Code 49 91

Alarm Code 90 99

Alarm Code 91 99

Alarm Code C4 101

Alarm Code C5 101

Alarm Code C7 101

Alarm Code C8 101

Alarm Code C9 102

Alarm Code d0 102

Alarm Code d1 102

Alarm Code d3 103

Alarm Code E1 104

Alarm Code "-" Blinking 71

Alarm Code 01 81

Alarm Code 02 81

Alarm Code 03 82

Alarm Code 06 82

Alarm Code 07 83

Alarm Code 09 83

Alarm Code 1 69

Alarm Code 1 (α iPS) 64

Alarm Code 10 83

Alarm Code 12 84,105

Alarm Code 13 84

Alarm Code 14 84

Alarm Code 15 85

Alarm Code 16 85

Alarm Code 17 85

Alarm Code 18 85

Alarm Code 2 69

Alarm Code 2 (α iPS, α iPS_R) 65

Alarm Code 21 86

Alarm Code 24 86

Alarm Code 27 86

Alarm Code 29 87

Alarm Code 3 (α iPS) 65

Alarm Code 31 88

Alarm Code 32 88

Alarm Code 34 88

Alarm Code 35 106

Alarm Code 36 88

Alarm Code 37 89

Alarm Code 4 (α iPS, α iPS_R) 65

Alarm Code 41 89

Alarm Code 42 90

Alarm Code 43 90

Alarm Code 46 90

Alarm Code 47 90

Alarm Code 5 69

Alarm Code 5 (α iPS, α iPS_R) 66

Alarm Code 50 91

Alarm Code 54 92

Alarm Code 55 92

Alarm Code 56 92

Alarm Code 6 69

Alarm Code 6 (α iPS, α iPS_R) 66

Alarm Code 61 92

Alarm Code 65 93

Alarm Code 66 93

Alarm Code 67 93

Alarm Code 69 93

Alarm Code 7 (α iPS, α iPS_R) 66

Alarm Code 70 94

Alarm Code 71 94

Alarm Code 72 94

Alarm Code 73 94

Alarm Code 74 95

Alarm Code 75 95

Alarm Code 76 95

Alarm Code 77 95

Alarm Code 78 96

Alarm Code 79 96

Alarm Code 8 70

Alarm Code 8 (α iPS_R) 66

Alarm Code 80 96

Alarm Code 81 96

Alarm Code 82 97

Alarm Code 83 97

Alarm Code 84 98

Alarm Code 85 98

Alarm Code 86 98

Alarm Code 87 98

Alarm Code 88 98

Alarm Code 89 98

Alarm Code 92 100

Alarm Code A (α iPS) 67

Alarm Code b0 100

Alarm Code C3 101

Alarm Code d2 102

Alarm Code d4 103

Alarm Code d7 103

Alarm Code d9 103

Alarm Code E (α iPS, α iPS_R) 67

Alarm Code E0 103

Alarm Code F 70

Alarm Code H (α iPS_R) 67

Alarm Code L 72

Alarm Code P 70

Alarm Code P (α iPS, α iPS_R) 67

Alarm Code U 72

Alarm Codes 19 and 20	85		
Alarm Codes 52 and 53	92		
Alarm Codes 8., 9., and A	70,71		
Alarm Codes A, A1, and A2	100		
Alarm Codes b, c, and d	71		
Alarm Codes C0,C1, and C2	101		
ALARM NUMBERS AND BRIEF DESCRIPTIONS...	50		
Alarms for built-in detectors (αi and βi Pulsecoders) and troubleshooting actions	134		
Alarms for separate detectors and troubleshooting actions	135		
Alarms Related to Pulsecoder and Separate Serial Detector	78		
An overshoot or hunting occurs	25		
Analog αi CZ sensor	31		
Appearance inspection of the linear motor (magnet plate)	133		
			
Battery connection modes	115		
<C>			
Caution	s-5,s-9,s-11,s-13		
Check board connection	33		
Check Terminal on the Printed-circuit Board	14		
Check terminal output signals	33		
Checking Method when Magnetic Contactor Is not Switched On	16		
Checking parameters	42		
Checking Parameters Using the Spindle Check Board	42		
Checking the Feedback Signal Waveform	29		
Checking the Phase Sequence of the Fan Motor Power Supply	12		
Checking the STATUS Display (Servo Amplifier)	18		
Checking the Status LEDs (Power Supply)	14		
Checking the Voltage and Capacity of the Power	11		
αCi SERIES SPINDLE AMPLIFIER MODULE	105		
CONFIGURATIONS	4		
CONFIRMATION OF THE OPERATION	13		
Connecting a Protective Ground	12		
Connecting the battery for the α series motor	115		
CONNECTING THE POWER	11		
Cooling Fan	152		
Cutting power weakens or acceleration/deceleration slows down	25		
<D>			
Data numbers	39		
DB Relay Error (CNC Message "Alarm SV0654")	73		
DEFINITION OF WARNING, CAUTION, AND NOTE	s-2		
Detailed troubleshooting methods	135		
Diagnosis Screen	74		
Display of the servo amplifier operation status	142		
<E>			
Example of observing data	41,45		
<F>			
FANUC AC SERVO MOTOR $\alpha is/\alpha i$ series	s-3		
FANUC AC SPINDLE MOTOR αi series	s-3		
FANUC SERVO AMPLIFIER αi series	s-8		
Feedback Disconnected Alarm	76		
FOR Series 0i-D	61		
FOR Series 15i	50		
FOR Series 16i, 18i, 20i, 21i, 0i, AND Power Mate i	54		
FOR Series 30i/ 31i/32i	58		
Fuse Locations	119		
<H>			
HOW TO REPLACE THE FUSES	118		
<I>			
INITIALIZING PARAMETERS	12		
Invalid Servo Parameter Setting Alarm	77		
αiS 100 with Fan and αiS 200 with Fan (including HV)	156		
αiS 1000HV	157		
αiS 2000HV and αiS 3000HV	157		
αiS 300 and αiS 500 (including HV)	156		
αiS 50 with Fan, αiS 60 with Fan, and αiF 40 with Fan	153		
<L>			
LIST OF MANUALS RELATED TO MOTORS AND AMPLIFIERS	124		
List of spindle data that can be observed using the SERVO GUIDE	43		
<M>			
Main inspection items	127		
Maintenance of βiS motor Pulsecoders	137		
Maintenance of a Detector	134		
Maintenance of a Servo Amplifier	142		
Maintenance of the FANUC-NSK spindle unit	132		
MAINTENANCE PARTS	158		
Major characteristics	35		
MAJOR COMPONENTS	5		
MEASURING SERVO MOTOR WAVEFORMS (TCMD, VCMD)	165		
Method for Observing Motor Current	19		
MOTOR/DETECTOR/AMPLIFIER PREVENTIVE MAINTENANCE	124		
<N>			
No LED Display (αiPS , αiPS_R)	64		
Note	s-6,s-10,s-13		
Notes on attaching connectors	116		
Notes on motor cleaning	130		
Notes on Replacing a Battery (Supplementary Explanation)	115		
Notes on the cutting fluid (informational)	130		
<O>			
Observation method	35		
Observing Data Using the SERVO GUIDE	42		
Observing Data Using the Spindle Check Board	35		

Other Alarms	79,104	START-UP PROCEDURE (OVERVIEW)	11
Overheat Alarm	77	STATUS Display (Spindle Amplifier)	23
Overload Alarm (Soft Thermal, OVC)	75	Status Error Indication Function	26
OVERVIEW	3,35,42,49,112,145	Storage method of the FANUC-NSK spindle unit	133
<P>			
Periodic cleaning of a motor	130	<T>	
α position coder S	32	Test run of the FANUC-NSK spindle unit	133
Power Supply	5,13,119	The motor does not turn	24
POWER SUPPLY (α iPS, α iPS _R)	64	The PIL LED (Power ON Indicator) Is Off	16
PREFACE	p-1	The PIL LED (power-on indicator) is off.	23
Preventive Maintenance of a Built-in Spindle Motor and Spindle Unit	131	The STATUS display is blinking with "--"	23
Preventive Maintenance of a Linear Motor	133	TROUBLESHOOTING AND ACTION	64
Preventive Maintenance of a Motor (Common to All Models)	127	Troubleshooting at Startup	23
Preventive Maintenance of a Servo Amplifier	141	<U>	
PREVENTIVE MAINTENANCE OF MOTORS AND DETECTORS	125	Usable series and editions	42
PREVENTIVE MAINTENANCE OF SERVO AMPLIFIERS	138	<V>	
Principles in outputting the internal data of the serial spindle	37	VRDY-OFF Alarm Indicated on the CNC Screen	18
Pulsecoder	151	<W>	
<R>		Warning	s-3,s-8,s-10,s-12
REPLACEMENT OF A FAN MOTOR	107,144	Warnings and Cautions Relating to a Pilot Run	s-10
Replacing a Cooling Fan	153	Warnings and Cautions Relating to Maintenance	s-12
REPLACING AMPLIFIER COMPONENTS	107	Warnings and Cautions Relating to Mounting	s-8
Replacing Batteries	112,146	Warnings, Cautions, and Notes on Operation of Servo Amplifiers	138
REPLACING BATTERY FOR ABSOLUTE PULSECODERS	112,145	Warnings, Cautions, and Notes on Preventive Maintenance of Motors and Detectors	125
REPLACING COOLING FANS	153	When cutting is not performed, the spindle vibrates, making noise.	25
Replacing the Batteries in a Separate Battery Case	113,146		
Replacing the Battery Built into the Servo Amplifier	113,147		
Routine Inspection of a Spindle Motor with a Through Hole	131		
Routine inspection of the FANUC-NSK spindle unit ..	132		
<S>			
SAFETY PRECAUTIONS	S-1		
Selecting the Ground Fault Interrupter That Matches the Leakage Current	12		
Servo Adjustment Screen	73		
Servo Alarm	50,54,58,61		
Servo Amplifier	6,17,68,119		
SERVO MOTOR MAINTENANCE	151		
SERVO MOTOR MAINTENANCE PARTS	151		
SERVO SOFTWARE	73		
Specifying data to be monitored	36		
Spindle Alarm	51,55,59,62		
Spindle Amplifier	8,22,81,120		
Spindle Check Board	32		
Spindle check board specifications	32		
SPINDLE MOTOR MAINTENANCE PARTS	158		
START-UP PROCEDURE	11		

REVISION RECORD

Edition	Date	Contents
04	Aug., 2011	<ul style="list-style-type: none">• Addition of an upgrade version of a Servo Amplifier
03	Mar., 2003	<ul style="list-style-type: none">• Changing of model names of Servo motor and Spindle motor
02	Sep., 2002	<ul style="list-style-type: none">• Addition of contents related a(HV)i series• Addition of contents related SERVO GUIDE in the Chapter 4 of Part I• Correction of errors
01	Jul., 2001	

ADDITIONAL INFORMATION

αi series SERVO AMPLIFIER for 30*i*-B Start-up and Maintenance manual

1. Type of applied technical documents

Name	αi series SERVO AMPFLIER for 30<i>i</i>-B Start-up and Maintenance manual
Spec.No./Ver.	B-65285EN/03-02/01

2. Summary of change

Group	Name / Outline	New,Add Correct,Del	Applicable Date
Basic Function	αi series SERVO AMPLIFIER for 30<i>i</i>-B	Add	3 Feb.2011
Optional Function			
Unit			
Maintenance Parts			
Notice			
Correction			
Another			

				TITLE	αi series SERVO AMPLIFIER for 30<i>i</i>-B Start-up and Maintenance manual		
01	2011.02.03	Harada	Newly added	NO.	B-65285EN/03-02/01		
EDT.	DATE	DESIG.	DESCRIPTION	FANUC CORPORATION		PAGE	1 / 76

INDEX

1. START-UP	3
1.1. COMPONENTS AND ITEMS TO BE CHECKED AT START-UP	3
1.2. INITIALIZING PARAMETERS	13
1.3. TROUBLESHOOTING AT START-UP	22
2. TROUBLESHOOTING	34
2.1. TROUBLESHOOTING PROCEDURES	34
2.2. SMART TROUBLE SHOOTING FUNCTION	35
2.3. ALARM NUMBER	52
3. PERIODIC MAINTENANCE OF SERVO AMPLIFIER	60
3.1. PERIODIC MAINTENANCE ITEM	60
3.2. INSULATION DETERIORATION DETECTION FUNCTION	62
3.3. HOW TO REPLACE THE BATTERY FOR THE ABSOLUTE PULSECORDER	64
4. MAINTENANCE PARTS AND REPLACEMENT METHODS	67
4.1. HOW TO REPLACE FAN MOTORS	67
4.2. HOW TO REPLACE FUSES ON PRINTED-CIRCUIT BOARDS	74

				TITLE	<i>αi</i> series SERVO AMPLIFIER for 30<i>i</i>-B Start-up and Maintenance manual		
				NO.	B-65285EN/03-02/01		
EDT.	DATE	DESIG.	DESCRIPTION	FANUC CORPORATION		PAGE	2 / 76

1. START-UP

1.1. COMPONENTS AND ITEMS TO BE CHECKED AT START-UP

1.1.1 200 V Series Configuration

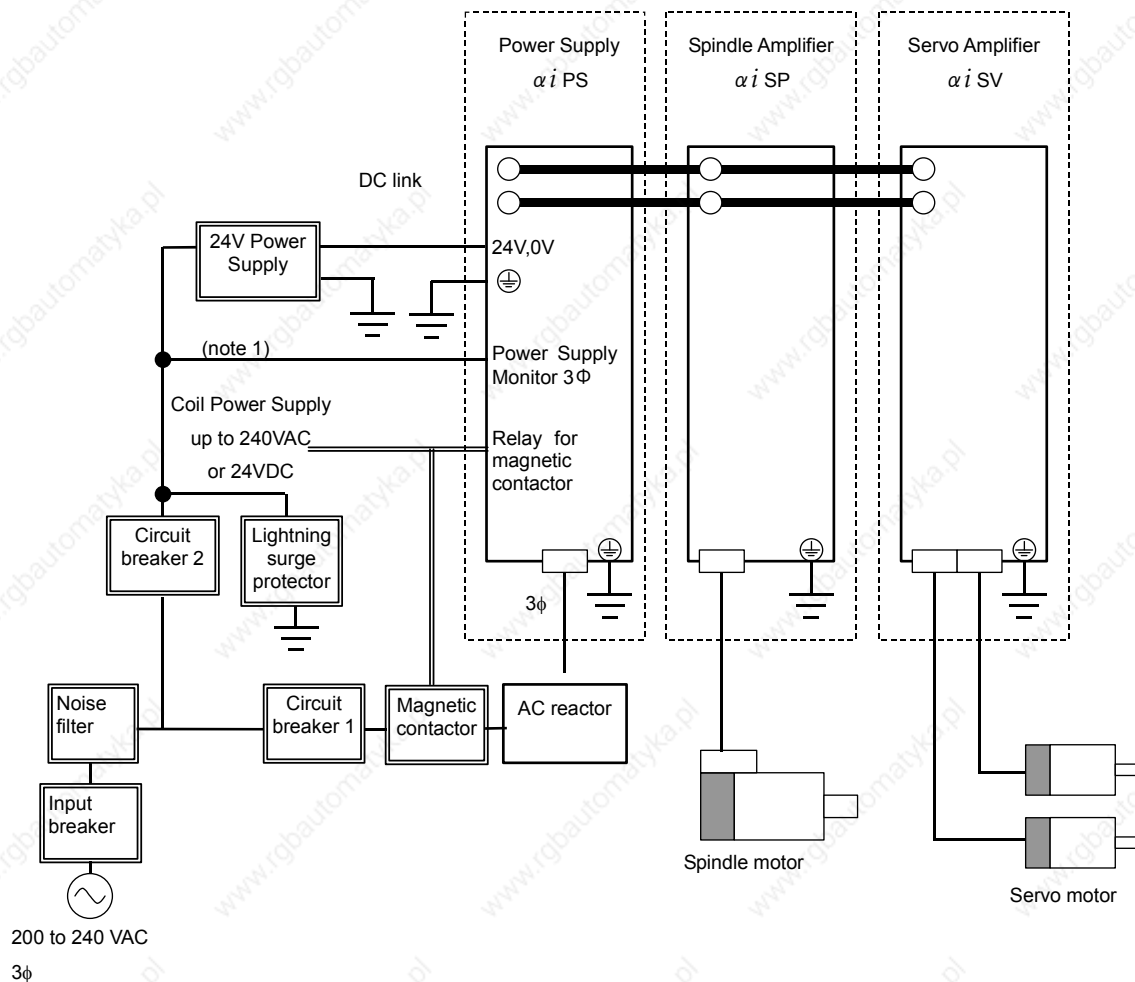

NOTE

1. Before wiring the power supply monitor, connect a circuit breaker or fuse so that the wiring can be protected.

				TITLE	αi series SERVO AMPLIFIER for 30i-B Start-up and Maintenance manual		
				NO.	B-65285EN/03-02/01		
EDT.	DATE	DESIG.	DESCRIPTION	FANUC CORPORATION	PAGE	3 / 76	

1.1.2

400 V Series Configuration

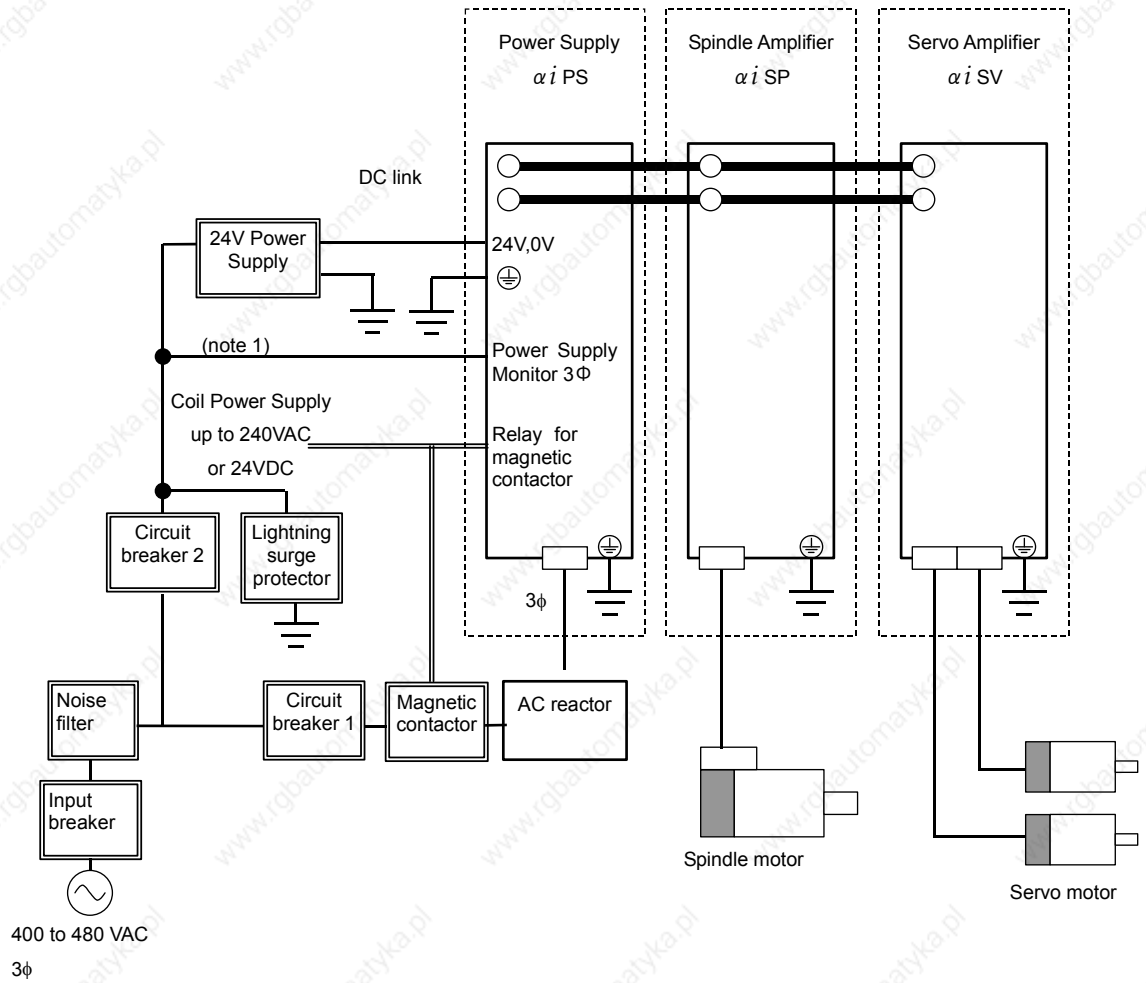

NOTE

1. Before wiring the power supply monitor, connect a circuit breaker or fuse so that the wiring can be protected.

				TITLE	αi series SERVO AMPLIFIER for 30i-B Start-up and Maintenance manual		
				NO.	B-65285EN/03-02/01		
EDT.	DATE	DESIG.	DESCRIPTION	FANUC CORPORATION	PAGE	4 / 76	

1.1.3

Label and Display on αi PS

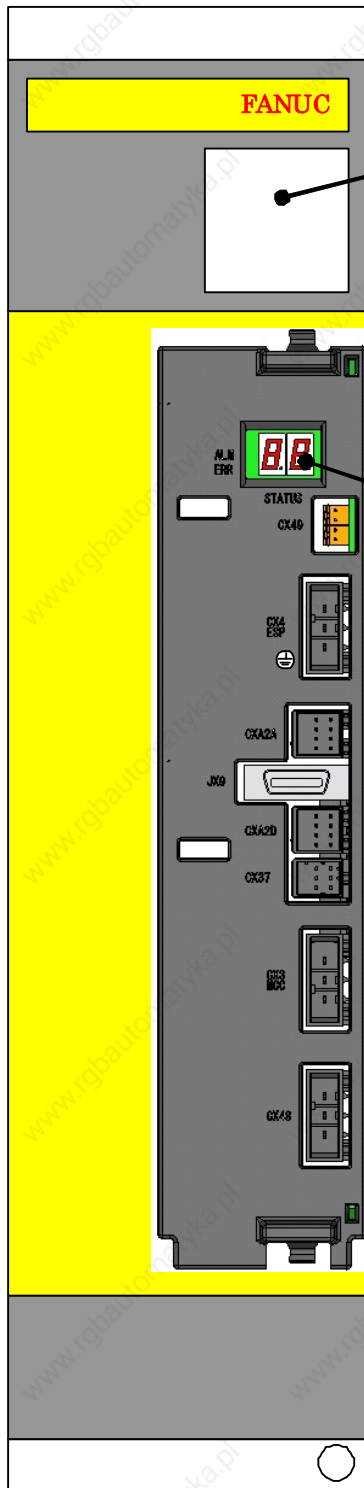

<u>A06B-6200-H011</u>	<u>A</u>
Specification Number	Unit Version
<u>V00000000</u>	
Manufacture number	

LABEL

LED display

- Alarm number
- Warning number
- Software series and version

POWER ON LED (GREEN)

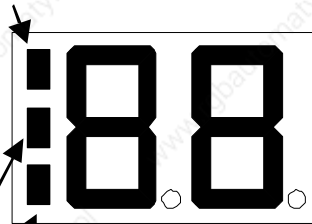

ALARM LED (RED)

ERROR LED (ORANGE)

- POWER ON LED (GREEN) : Lighting when control power ON
- ALARM LED (RED) : Lighting when Alarm status
- ERROR LED (ORANGE) : Lighting when Error status

				TITLE	αi series SERVO AMPLIFIER for 30i-B Start-up and Maintenance manual		
				NO.	B-65285EN/03-02/01		
EDT.	DATE	DESIG.	DESCRIPTION	FANUC CORPORATION	PAGE	5 / 76	

Detail of LED Display of αi PS

ALARM LED	ERROR LED	STATUS LED	Contents
		LED is off	Control power has not been supplied. Fault of hardware.
		Number / alphabet	The software series/edition is displayed at 4 sessions for about 4 seconds after the power is turned on. First 1 sec: Upper 2 digits of the software series Second 1 sec: Lower 2 digits of the software series Third 1sec : Upper 2 digits of software version Forth 1sec : Lower 2 digits of software version Example) In case of Software serie/version 9G00/01.0 <div style="border: 1px solid black; display: inline-block; padding: 2px;"> 9 G → 0 0 → 0 1 → 0 </div>
		-- <u>Blink</u>	Serial communication with the servo or spindle amplifier is being established
		-- <u>Lighting</u>	Serial communication with the servo or spindle amplifier is established
		00 <u>Blink</u>	Start up main power (Precharging)
		00	Ready main power
Lighting		Number 01~	Alarm status
		Number 01~	Warning status

				TITLE	αi series SERVO AMPLIFIER for 30i-B Start-up and Maintenance manual
				NO.	B-65285EN/03-02/01
EDT.	DATE	DESIG.	DESCRIPTION	FANUC CORPORATION	PAGE 6 / 76

1.1.4 Label and Display on αi SV

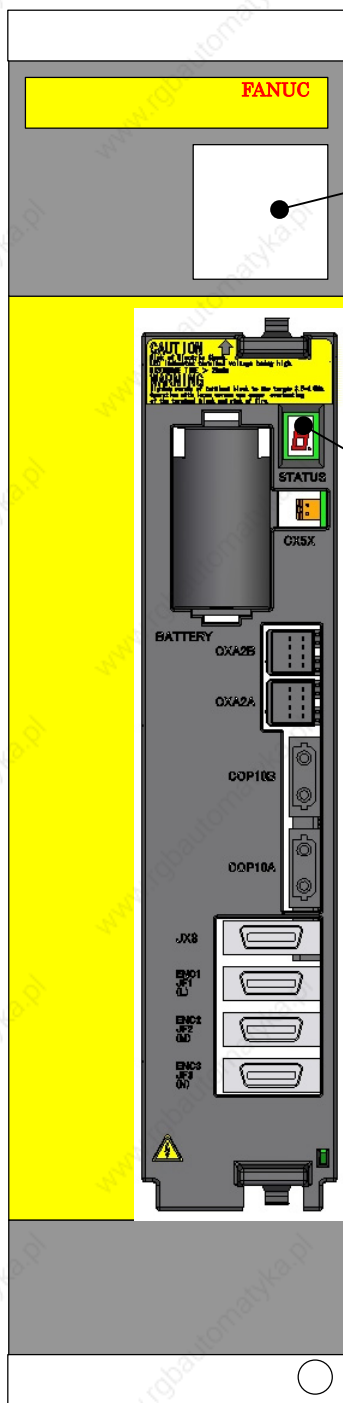

<u>A06B-6240-H210</u>	<u>A</u>
Specification Number	Unit Version
<u>V00000000</u>	
Manufacture Number	

- LED display
- Alarm number
 - Warning number
 - Software series and version

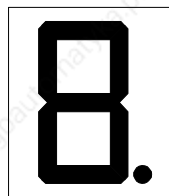

Number

				TITLE	αi series SERVO AMPLIFIER for 30i-B Start-up and Maintenance manual		
				NO.	B-65285EN/03-02/01		
EDT.	DATE	DESIG.	DESCRIPTION	FANUC CORPORATION		PAGE	7 / 76

Detail of LED Display of αi SV

LED	Contents															
LED is off	Control power has not been supplied. Fault of hardware															
Number <u>Lighting</u>	The software series/version is displayed at 4seconds after the power is turned on. Example) In case of software series/version is 9H00/01.0 <div style="text-align: center;"> <table border="1" style="display: inline-table; border-collapse: collapse;"> <tr> <td style="padding: 2px 5px;">9</td> <td style="padding: 2px 5px;">→</td> <td style="padding: 2px 5px;">H</td> <td style="padding: 2px 5px;">→</td> <td style="padding: 2px 5px;">0</td> <td style="padding: 2px 5px;">→</td> <td style="padding: 2px 5px;">0</td> <td style="padding: 2px 5px;">→</td> <td style="padding: 2px 5px;">0</td> <td style="padding: 2px 5px;">→</td> <td style="padding: 2px 5px;">1</td> <td style="padding: 2px 5px;">→</td> <td style="padding: 2px 5px;">.</td> <td style="padding: 2px 5px;">→</td> <td style="padding: 2px 5px;">0</td> </tr> </table> </div>	9	→	H	→	0	→	0	→	0	→	1	→	.	→	0
9	→	H	→	0	→	0	→	0	→	1	→	.	→	0		
— <u>Blink</u>	Self-Check															
— <u>Lighting</u>	SV is waiting for a ready signal															
— <u>Blink</u>	Measuring isolation resistor															
— <u>Lighting</u>	SV is ready to operate															
Number 1~	Alarm state															

				TITLE	αi series SERVO AMPLIFIER for 30 <i>i</i> -B Start-up and Maintenance manual		
				NO.	B-65285EN/03-02/01		
EDT.	DATE	DESIG.	DESCRIPTION	FANUC CORPORATION		PAGE	8 / 76

1.1.5

Label and Display on αi SP

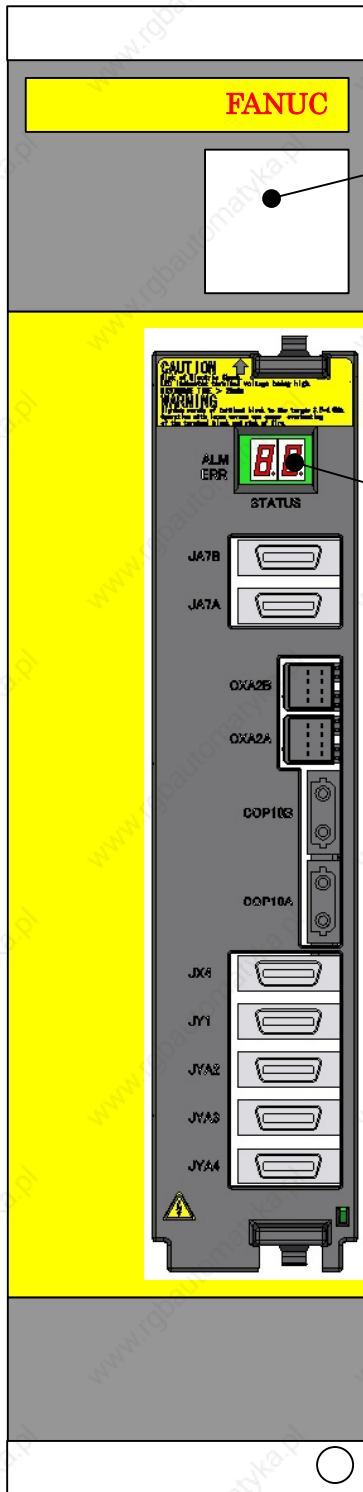

<u>A06B-6220-H011</u>	<u>A</u>
Specification Number	Unit Version
<u>V00000000</u>	
Manufacture number	

LABEL

LED display

- Alarm number
- Warning number
- Software series and version

POWER ON LED (GREEN)

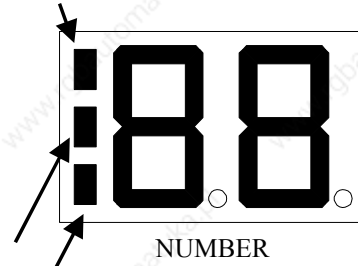

ALARM LED (RED)

ERROR LED (ORANGE)

- POWER ON LED (GREEN) : Lighting when control power ON
- ALARM LED (RED) : Lighting when Alarm status
- ERROR LED (ORANGE) : Lighting when Error status

				TITLE	αi series SERVO AMPLIFIER for 30i-B Start-up and Maintenance manual		
				NO.	B-65285EN/03-02/01		
EDT.	DATE	DESIG.	DESCRIPTION	FANUC CORPORATION		PAGE	9 / 76

Detail of LED Display of αi SP

ALARM LED	ERROR LED	STATUS LED	Contents								
		LED is off	Control power has not been supplied. Fault of hardware.								
		Number / alphabet	For about 3.0 s after the control power supply is switched on, the spindle software series No. and the spindle software edition No. are indicated. First 1 sec : A Second 1 sec : The lower two digits of the spindle software series No. Third 1sec : The spindle software edition No. Example) A0: Software series No. 9DA0 04: Software edition D <div style="text-align: center;"> <table border="1" style="display: inline-table; border-collapse: collapse;"> <tr> <td style="padding: 2px 5px;">A</td> <td style="padding: 2px 5px;"> </td> <td style="padding: 2px 5px;">→</td> <td style="padding: 2px 5px;">A</td> <td style="padding: 2px 5px;">0</td> <td style="padding: 2px 5px;">→</td> <td style="padding: 2px 5px;">0</td> <td style="padding: 2px 5px;">4</td> </tr> </table> </div>	A		→	A	0	→	0	4
A		→	A	0	→	0	4				
		-- <u>Blink</u>	The CNC has not been switched on. The machine is waiting for serial communication and parameter loading to end.								
		-- <u>Lighting</u>	Parameter loading has ended. The motor is not supplied with power.								
		00	The motor is supplied with power.								
Lighting		Number 01~	Alarm status The SPM is not operable. See Chapter 1 of Part II.								
	Lighting	Number 01~	Warning status Incorrect parameter setting or improper sequence.								

				TITLE	αi series SERVO AMPLIFIER for 30i-B Start-up and Maintenance manual
				NO.	B-65285EN/03-02/01
EDT.	DATE	DESIG.	DESCRIPTION	FANUC CORPORATION	PAGE 10 / 76

1.1.6 Check Items

No.	Description	Check method
Servo amplifier installation status check		
1	Servo amplifier and servo motor specifications	Check the combination of the servo amplifier and servo motor referring to Section 4.1 of “ αi series Servo Amplifier Descriptions” (B-65282EN/06).
2	Flange packing	Check the supplied packing is attached properly and that there is no gap between the control panel and amplifier flange.
3	Maintenance area	Please keep a maintenance area for the amplifier. For details, refer to Section 5.1 of the document (B-65282EN/06-18) attached to “ αi series Servo Amplifier Descriptions”.
4	Preventing contact with any current-carrying section	Check a protective plate is attached to the DC link terminal board properly and the terminal board cover is locked. For details, refer to Section 5.3 of the document (B-65282EN/06-18) attached to “ αi series Servo Amplifier Descriptions”.
5	Order of amplifier locations	As for the αi SP45HV or the larger model, there is a rule to place the amplifiers. For details, refer to Section 5.3 of the document (B-65282EN/06-18) attached to “ αi series Servo Amplifier Descriptions”.
6	Prevent cutting fluid intrusion	Take a measure to prevent electroconductive, flammable, and corrosive material as well as mist and water drop from getting in the unit. For the detail of an effective closeness of the control panel, refer to Appendix G of “ αi series Servo Amplifier Descriptions” (B-65282EN/06).
Servo amplifier wiring status check		
7	Tightening terminal board screws	When connecting wires to the servo amplifier terminal board, be sure to tighten the screws with a proper torque. For the detail of the tightening torque for the terminal board screws, refer to Subsection 5.5.2.9 of “ αi series Servo Amplifier Descriptions” (B-65282EN/06).
8	Connecting a protective ground	Use a proper cable for grounding in order to prevent electrical shocks at a ground fault. For details, refer to Subsection 9.3.1.7 of “ αi series Servo Amplifier Descriptions” (B-65282EN/06).
9	Installing a lightning surge protector	In order to prevent damage due to a surge voltage applied to the input power supply, install a lightning surge protector. For details, refer to Appendix A of “ αi series Servo Amplifier Descriptions” (B-65282EN/06).
10	Measure for noise	Check that ground wires, including feedback cable shielding clamps, are connected to proper places to maintain a stable operation of the machine. For details, refer to Section 5.2 of “ αi series Servo Amplifier Descriptions” (B-65282EN/06) and Subsection 7.2.5 of the document (B-65282EN/06-18) attached to “ αi series Servo Amplifier Descriptions”. Also refer to Subsection 7.2.8 if the 24 V power supply is shared between the servo amplifier and the CNC.

(Continued on the next page)

				TITLE	αi series SERVO AMPLIFIER for 30 i -B Start-up and Maintenance manual		
				NO.	B-65285EN/03-02/01		
EDT.	DATE	DESIG.	DESCRIPTION	FANUC CORPORATION	PAGE	11 / 76	

(Continued from the previous page)

11	Order of motor power line phases	If the order of motor power line phases is incorrect, there is a risk of an unexpected behavior of motor. So, make sure that the power wires are connected to the motor properly.
12	Checking the axis where motor feedback and power wires are connected	If the axis where motor feedback and power wires are connected is incorrect, there is a risk of an unexpected behavior of motor. So, make sure that the connection is correct.
13	Battery connection	Do not connect the built-in batteries in parallel. Please make sure, if the built-in batteries are used with an amp-to-amp battery connection cable (CXA2A/B or BATL (B3)) attached, they may be connected in parallel. For details, refer to Subsection 9.3.2.10 of “ αi series Servo Amplifier Descriptions” (B-65282EN/06).
Operation start-up check		
14	Power supply voltage check	Before turning power on, check that the power supply voltage is in its proper range. For details of the power supply voltage specification, refer to Section 2.1 of “ αi series Servo Amplifier Descriptions” (B-65282EN/06).
15	Ground potential check	The 400 V servo amplifier supports only neutral grounding. For details, refer to Section 2.1 of “ αi series Servo Amplifier Descriptions” (B-65282EN/06).
16	Ground fault interrupter setting	Use a ground fault interrupter that supports inverters. For explanations about leakage current, refer to Section 5.1 of “ αi series Servo Amplifier Descriptions” (B-65282EN/06).
17	Control power check	Check that the voltage of the 24 V power supply for amplifiers is in its proper range and the selected current capacity is proper. For details, refer to Section 4.5 and Subsection 7.2.8 of the document (B-65282EN/06-18) attached to “ αi series Servo Amplifier Descriptions”.
18	Parameter setting	Set initial parameters while referencing Section 1.2 of this document.
19	Handling early failures	Solve start-up problems, such as being impossible to turn power on, motor failing to rotate, and alarm occurrence, while referencing Section 1.3 of this document.

				TITLE	αi series SERVO AMPLIFIER for 30 <i>i</i> -B Start-up and Maintenance manual		
				NO.	B-65285EN/03-02/01		
EDT.	DATE	DESIG.	DESCRIPTION	FANUC CORPORATION		PAGE	12 / 76

1.2. INITIALIZING PARAMETERS

1.2.1 Common Power Supply

The common power supply (PS) for the 30*i*-B series is controlled by software. So, information concerning the power supply can be known on the CNC. Using these informations makes it possible to diagnose failures resulting from power supply fluctuation.

Unlike the servo amplifier (SV) or spindle amplifier (SP), PS cannot communicate directly with CNC. So, the power supply information is transferred through SV or SP to CNC.

1.2.1.1 Amplifier group number

A group of one PS and the servo and spindle amplifiers connected to the PS is defined as an “amplifier group”. This means that a system having more than one PS has more than one amplifier group. A unique number is assigned to each amplifier group. The unique number is described as “amplifier group number”.

1.2.1.2 PS control axis

The PS is connected to amplifiers via the CXA2x connector. In this connection, let us refer to an axis driven by the servo/spindle amplifier nearest to the PS is described as “PS control axis”.

The power supply information mentioned above is transferred through this PS control axis to the CNC.

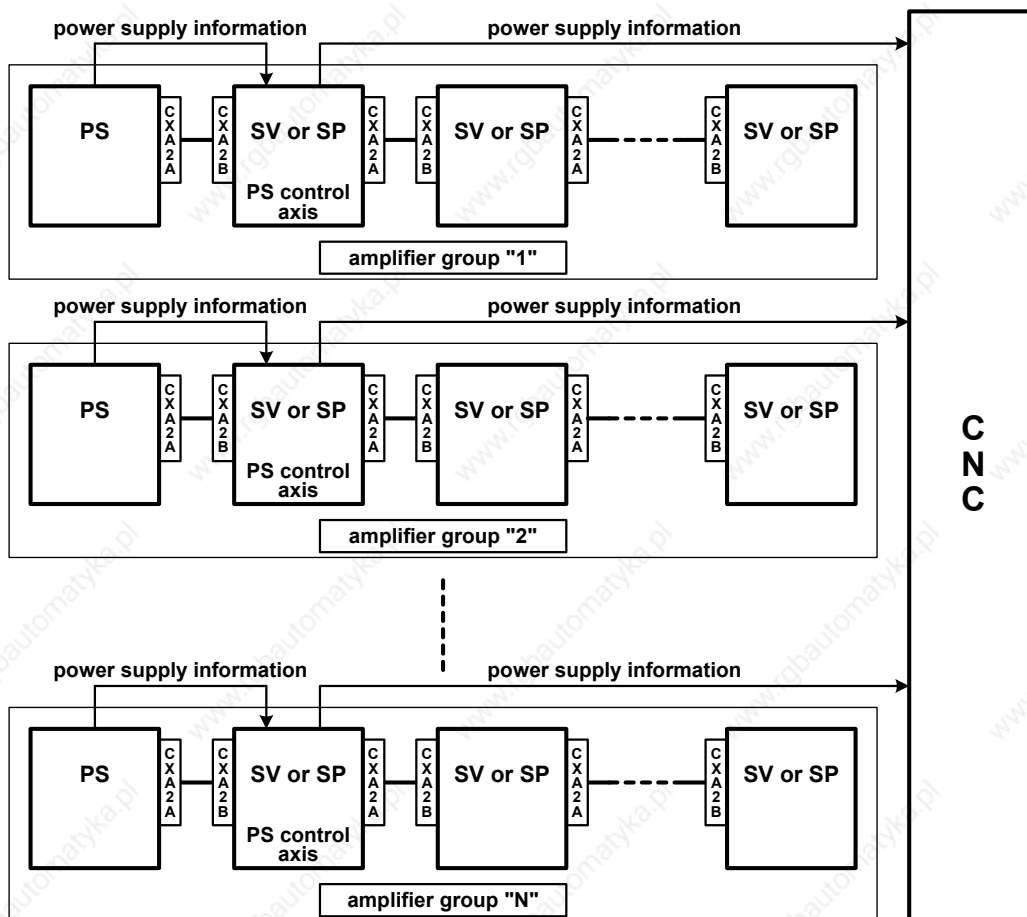

				TITLE	α <i>i</i> series SERVO AMPLIFIER for 30 <i>i</i> -B Start-up and Maintenance manual		
				NO.	B-65285EN/03-02/01		
EDT.	DATE	DESIG.	DESCRIPTION	FANUC CORPORATION	PAGE	13 / 76	

1.2.1.3 Parameter setting for specifying a PS control axis

Using the servo and spindle amplifiers for the 30i-B series requires the following procedure.

1.2.1.3a Parameter setting procedure

In order for the CNC software to recognize the PS control axis, it is necessary to set an amplifier group number in either of the following parameters:

Parameter No. 2557 in case the PS control axis is a servo axis

Parameter No. 4657 in case the PS control axis is a spindle axis

This setting can be made automatically with the following procedure.

- (1) Set bit 0 (APS) of parameter No. 11549 to 1.

The message "PW0000 POWER MUST BE OFF" appears on the alarm message screen. So turn the CNC power off and on again. Parameters Nos. 2557 and 4657 are automatically set with an amplifier group number, thus completing PS control axis parameter setting.

* Upon completion of automatic parameter setting, bit 0 of parameter No. 11549 returns to 0.

* If the amplifier configuration is changed, the alarm "PS CONTROL AXIS ERROR" occurs just after CNC start-up. So, perform automatic parameter setting again.

Related parameter	Description
No.11549#0(APS)	Setting this parameter to 1 causes an amplifier group number to be automatically set in PS control axis parameter No. 2557 or 4657.
No.2557	In case the servo axis is a PS control axis, an amplifier group number is set for the PS control axis.
No.4657	In case the spindle axis is a PS control axis, an amplifier group number is set for the PS control axis.

				TITLE	αi series SERVO AMPLIFIER for 30i-B Start-up and Maintenance manual		
				NO.	B-65285EN/03-02/01		
EDT.	DATE	DESIG.	DESCRIPTION	FANUC CORPORATION	PAGE	14 / 76	

1.2.1.3b Concrete parameter setting examples

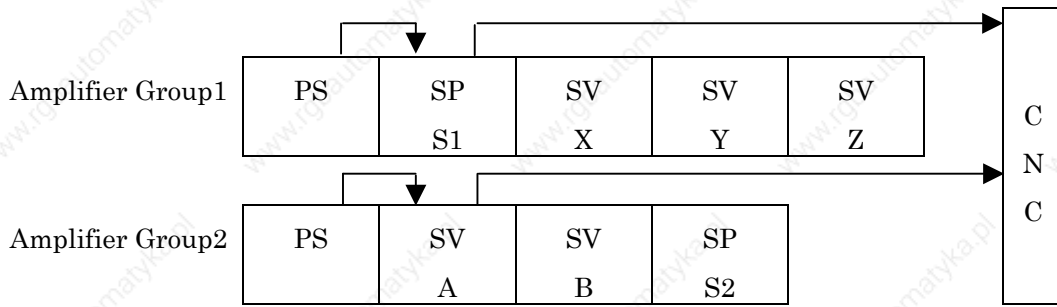

For the amplifier configuration shown above, the parameters are set as shown below. Amplifier group numbers 1 and 2 are assigned automatically.

Amplifier Group1	PS	SP S1	SV X	SV Y	SV Z
------------------	----	----------	---------	---------	---------

No.2557	/	0	0	0
No.4657	1	/	/	/

Amplifier Group2	PS	SV A	SV B	SP S2
------------------	----	---------	---------	----------

No.2557	2	0	/
No.4657	/	/	0

				TITLE	αi series SERVO AMPLIFIER for 30i-B Start-up and Maintenance manual		
				NO.	B-65285EN/03-02/01		
EDT.	DATE	DESIG.	DESCRIPTION	FANUC CORPORATION		PAGE	15 / 76

1.2.2 Servo Amplifiers

1.2.2.1 Servo parameter initialization procedure

The initialization procedure for servo amplifiers and servo motors is described below. For details of each item of the procedure, refer to “FANUC AC SERVO MOTOR αi series/FANUC AC SERVO MOTOR βi series/FANUC LINEAR LiS series/FANUC BUILT-IN SERVO MOTOR DiS series Parameter Manual” (B-65270).

<p>Preparation</p> <ul style="list-style-type: none"> - In emergency stop state, switch on CNC - Set parameter write enable - Servo adjusting screen
--

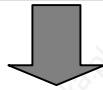

<p>Setting of servo parameter</p> <table border="1"> <tr><td>Setting</td></tr> <tr><td>Initialization bits</td></tr> <tr><td>Motor No.</td></tr> <tr><td>AMR</td></tr> <tr><td>CMR</td></tr> <tr><td>Flexible feed gear</td></tr> <tr><td>Move direction</td></tr> <tr><td>Velocity pulse</td></tr> <tr><td>Reference counter</td></tr> <tr><td>Full closed loop</td></tr> <tr><td>Servo loop gain</td></tr> </table>	Setting	Initialization bits	Motor No.	AMR	CMR	Flexible feed gear	Move direction	Velocity pulse	Reference counter	Full closed loop	Servo loop gain
Setting											
Initialization bits											
Motor No.											
AMR											
CMR											
Flexible feed gear											
Move direction											
Velocity pulse											
Reference counter											
Full closed loop											
Servo loop gain											

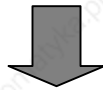

Turn power off then on

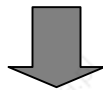

Absolute position detection setting

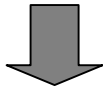

End of parameter setting

				TITLE	αi series SERVO AMPLIFIER for 30 <i>i</i> -B Start-up and Maintenance manual		
				NO.	B-65285EN/03-02/01		
EDT.	DATE	DESIG.	DESCRIPTION	FANUC CORPORATION		PAGE	16 / 76

1.2.2.2 Multi-axis amplifier start-up

The conventional multi-axis amplifier cannot become ready unless the start-up conditions for all axes are satisfied. However, the multi-axis servo amplifier for the 30i-B series can become ready for individual axes separately if the start-up conditions for them are satisfied.

Multi-axis amplifier ready status indicator

The 7-segment LED indicator on the multi-axis servo amplifier for the 30i-B series can indicate “0.” (dotted zero) meaning a ready status for some axes and a not-ready status for others as well as “0” meaning a ready status for all axes and “-” meaning a not-ready status for all axes.

7-segment LED indicator	Amplifier status	Description
—	Not ready (for all axes)	Not ready for all axes (same as conventional) All axes are braked dynamically and inoperable.
0	Ready (for all axes)	Ready for all axes (same as conventional) All axes are operable.
0.	Ready (except for some axes)	Ready for some axes and not ready for others. This indication differs from the all-axis ready status indication in that the dot lights. Only the axes for which the amplifier is ready are operable. The axes for which the amplifier is not ready are braked dynamically.

- **Multi-axis amplifier behavior at alarm occurrence**

If the former multi-axis servo amplifier detects an alarm even on one axis, it becomes Not ready for all axes regardless of what the alarm is like and applies a dynamic brake to all the axes to bring them to halt. If the multi-axis servo amplifier for the 30i-B series detects an individual-axis alarm (such as an IPM alarm) on any axis, however, it becomes Not ready only for that axis and stays ready for the other axes in the servo amplifier.

- **No restriction on the multi-axis amplifier at alarm occurrence**

Even if an alarm occurs on the brake control function, quick stop function, or the Gravity-axis drop prevention function at an emergency stop for any axis, unlike the former multi-axis servo amplifier, there is no restriction on the multi-axis servo amplifier for the 30i-B series regarding any application using the operation of the other axes.

				TITLE	αi series SERVO AMPLIFIER for 30i-B Start-up and Maintenance manual		
				NO.	B-65285EN/03-02/01		
EDT.	DATE	DESIG.	DESCRIPTION	FANUC CORPORATION		PAGE	17 / 76

[Behavior of axes (normal axes) at alarm occurrence on any other axis]

	Alarm	Behavior of normal axes	
		Conventional servo amplifier	Servo amplifier for the 30i-B series
<1>	Alarm (such as excessive-error alarm) detected by the servo or CNC software	Possible to delay the ready status of the servo amplifier.*	Possible to delay the ready status of the servo amplifier.*
<2>	Individual-axis alarm detected by the servo amplifier <1> Abnormal Motor current <2> IPM alarm <3> DB relay abnormal alarm	Possible to delay the ready status of the servo amplifier only for the one-axis amplifier.* (Impossible to delay the ready status of the servo amplifier if a multi-axis amplifier detects an alarm for axes of the same amplifier.)	Possible to delay the ready status of the servo amplifier for all amplifiers.*
<3>	Alarms other than <1> or <2> above	Becomes Not ready instantly.	Becomes Not ready instantly.

*It is possible to pull up normal vertical axes while the ready status of the servo amplifier is being delayed.

				TITLE	αi series SERVO AMPLIFIER for 30i-B Start-up and Maintenance manual		
				NO.	B-65285EN/03-02/01		
EDT.	DATE	DESIG.	DESCRIPTION	FANUC CORPORATION		PAGE	18 / 76

- **Supporting the axis detach function for multi-axis amplifiers**

Conventionally, the axis detach function has been applicable only to axes driven by a one-axis servo amplifier. Now, the detach function is applicable to each axis driven by the multi-axis servo amplifier for the 30i-B series.

- **Setting dummy axes for multi-axis amplifiers**

Starting up a specific axis on the conventional multi-axis amplifier requires attaching a dummy connector to the axes not in use. With the servo amplifier for the 30i-B series, it is possible to start up only arbitrary axes. So, it is unnecessary to attach a dummy connector to any axis not in use.

- **Sharing a multi-axis amplifier with two or more paths**

If the conventional multi-axis amplifier is shared among multiple paths, it is necessary to input a signal for ignoring the VRDY-OFF alarm when the amplifier becomes Not ready for an axis being used by one path, so that it will not become Not ready for axes in use by the other paths. For the servo amplifier for the 30i-B series, it is unnecessary to input such a signal.

CAUTION

1. Note on synchronization control and tandem control

If an alarm occurs on one of the axes used on a multi-axis amplifier under synchronization or tandem control, it is necessary for the multi-axis amplifier to become Not ready immediately also for the other axes in order to prevent machine distortion. To meet this requirement, be sure to enable the servo software's "servo alarm 2-axis simultaneous monitoring function" for axes under synchronization or tandem control.

In some cases, implementing synchronization or tandem control for two axes driven by the conventional multi-axis amplifier caused the amplifier to become Not ready for the two axes simultaneously at alarm occurrence as if the "servo alarm 2-axis simultaneous monitoring function" had operated.

Because the ready status conditions of the multi-axis amplifier for the 30i-B series for each axis are independent of one another, using the multi-axis amplifier does not work in place of the "servo alarm 2-axis simultaneous monitoring function". For this reason, be sure to enable the "servo alarm 2-axis simultaneous monitoring function" for axes under synchronization or tandem control also when the multi-axis amplifier is used. Refer to "Parameter Manual" for detailed descriptions of the "servo alarm 2-axis simultaneous monitoring function" and the related parameter setting.

2. If an alarm (such as a DC link low-voltage alarm) common to all axes occurs, any axis driven by the multi-axis amplifier can be the cause of the alarm in the same manner as with the conventional amplifier, resulting in the amplifier becoming Not ready simultaneously for all axes and a dynamic brake being applied to all axes to bring them to halt.

3. If an emergency stop signal (input signal to the connector CX4 of the PS) is input, the amplifier becomes Not ready for all axes and applies a dynamic brake to all axes to bring them to halt.

				TITLE	αi series SERVO AMPLIFIER for 30i-B Start-up and Maintenance manual		
				NO.	B-65285EN/03-02/01		
EDT.	DATE	DESIG.	DESCRIPTION	FANUC CORPORATION		PAGE	19 / 76

1.2.3 SPINDLE AMPLIFIER

1.2.3.1 PARAMETER FOR SPINDLE SERIAL OUTPUT

Only the list of parameters for SPINDLE SERIAL OUTPUT is mentioned.

As for the detail of these parameter, refer to 11.2 “SPINDLE SERIAL OUTPUT” of FANUC Series 30*i* / 31*i* / 32*i* –MODEL B CONNECTION MANUAL (FUNCTION)

Parameter number	Description
30<i>i</i>-B	
3716#0	(Analog/Serial) Selection of Spindle (Set to “1”)
3702#1	The multi-spindle control function (The multi-spindle control function is used /not used)
3717	The spindle amplifier number of each spindle
3718	Subscript for display of spindle (main spindle)
3719	Subscript for display of spindle (sub-spindle)

Note

When a serial spindle is used, the option for spindle serial output is required.

About FSSB Setting,

refer to 1.4.4 「FSSB Setting」 of FANUC Series 30*i* / 31*i* / 32*i* –MODEL B CONNECTION MANUAL (FUNCTION).

1.2.3.2 Automatic Spindle Parameter Initialization

An automatic setup of spindle parameters (No.4000-No.4799) is described as follow.

Note

When you do not want to initialize the adjusted parameters, don't perform automatic spindle parameter initialization.

1.2.3.2a Parameter List

Parameter No.	Description
30<i>i</i>-B	
4019#7	Function for automatically initializing spindle parameters.
4133	Spindle motor model code

				TITLE	<i>αi</i> series SERVO AMPLIFIER for 30 <i>i</i> -B Start-up and Maintenance manual		
				NO.	B-65285EN/03-02/01		
EDT.	DATE	DESIG.	DESCRIPTION	FANUC CORPORATION		PAGE	20 / 76

1.2.3.2b Procedure for automatic spindle parameter initialization

Perform automatic spindle parameter initialization by following the procedure below.

<1> Set the model code for the desired motor for automatic parameter initialization.

Parameter No.	Description
30i-B	
4133	Model code

Note

- 1 The control method usable with the αi series spindle is spindleHRV control only. The conventional control method is not supported.
- 2 About the model code of each motor, refer to FANUC AC SPINDLE MOTOR αi series PARAMETER MANUAL B-65280JA.
- 3 When using a spindle motor that has no model code, set model code "300" ("400" for a spindle motor with speed range switching control) for automatic parameter setting, then manually input data according to the parameter table for each motor model.

<2> Set the relevant parameter to enable automatic spindle parameter initialization.

Parameter No.	Description
30i-B	
4019#7	1

Note

This bit is reset to its original value after automatic parameter initialization.

<3> Turn the CNC off, then on again. Then, the spindle parameters specified with a model code are automatically initialized.

				TITLE	αi series SERVO AMPLIFIER for 30i-B Start-up and Maintenance manual		
				NO.	B-65285EN/03-02/01		
EDT.	DATE	DESIG.	DESCRIPTION	FANUC CORPORATION		PAGE	21 / 76

1.3. Troubleshooting at Start-up

1.3.1 Power supply

(1) The LED on power supply is off

When the LED on power supply does not become on after the main circuit breaker is turned on.

No.	Cause of trouble	Check method	Action
1	The 24V control power is not supplied.	Check the voltage of the external power supply (24V).	Check whether the external power supply is faulty.
2	The cable is defective.	Check whether the cable attached to the connector CXA2A/B is disconnected or short-circuited.	Check the cable attached to the connector CXA2A/B.
3	The power is externally connected to 0 V, GND, or the like.	Check whether the cable for 24V power is short-circuited	Replace or repair the cable.
4	There is a blown fuse on the printed circuit board.	Check whether the fuse on the printed circuit board for the control has blown. See Chapter 4.2 about the location of the fuse.	If the fuse blows, the printed circuit board may be faulty. Replace the unit.
5	The printed circuit board is defective.	If the cause is not No.1 - 4, the printed circuit board of servo amplifier may be faulty.	Replace the unit.

				TITLE	α i series SERVO AMPLIFIER for 30i-B Start-up and Maintenance manual		
				NO.	B-65285EN/03-02/01		
EDT.	DATE	DESIG.	DESCRIPTION	FANUC CORPORATION		PAGE	22 / 76

1.3.2 Servo amplifier

(1)The LED on servo amplifier is off

When the LED on servo amplifier does not become on after the main circuit breaker is turned on.

No.	Cause of trouble	Check method	Action
1	The 24V control power supply is not supplied	Check the voltage of the 24V power supply	Check the 24V power supply
2	The cable is defective	Checke that the cable connected the CXA2A/2B is disconnected or short	Checke the cable connected the CXA2A/2B
		Check whether 5V power supply short-circuits by the feedback cable.	Checke the feedback cable
3	The power supply is short-circuited externally.	Please check whether the power cable is short-circuited.	Exchange or repair the cable.
4	Blown fuse in the control circuit	Check the fuse on the control PCB (Refer to 4.2 about position of fuse)	Since Control PCB may be out of order when this fuse is blown, please exchange the unit.
5	The PCB of servo amplifier is defective	If it does not correspond to No.1~4, the PCB of servo amplifier may be defective.	Exchange the servo amplifier

				TITLE	α i series SERVO AMPLIFIER for 30i-B Start-up and Maintenance manual		
				NO.	B-65285EN/03-02/01		
EDT.	DATE	DESIG.	DESCRIPTION	FANUC CORPORATION		PAGE	23 / 76

(2) VRDY-OFF alarm is indicated on the CNC screen.

When the VRDY-OFF alarm is indicated on the NC, check the items listed below.

In addition, VRDY-OFF can occur also for reasons other than listed below. If all of the following items turn out to have not caused VRDY-OFF, check diagnosis information No.358 (V ready-off information) on the diagnosis screen and report it to FANUC.

(1) Communication between amplifiers

Is the cable for the communication interface (CXA2A/B) between the amplifiers connected correctly?

(2) Emergency stop signal (ESP)

Has the emergency stop signal (connector: CX4) applied to the common power supply been released? Alternatively, is the signal connected correctly?

(3) MCON signal

Hasn't setting up the axis detach function disabled the transmission of the ready command signal MCON from the NC to the servo amplifier?

(4) Servo amplifier control board

The servo amplifier control board may be poorly installed or faulty. Be sure to push the face plate as far as it will go. If the problem persists, replace the control board.

On the Series 30i/31 i /32 i, checking diagnosis information (DGN) No.358 makes it possible to analyze the cause of the VRDY-OFF alarm.

Diagnosis

Convert the displayed value to binary form, and check bits 5 to 14 of the resulting binary number.

When the servo amplifier starts working, these bits become 1 sequentially, starting at bit 5. When the servo amplifier has started normally, all of bits 5 to 14 become 1.

Check bits 5 to 14 sequentially, starting at the lowest-order bit. The first lowest bit that is 0 corresponds to the processing that caused the V ready-off alarm.

#15	#14	#13	#12	#11	#10	#9	#8
	SRDY	DRDY	INTL	RLY	CRDY	MCOFF	MCONA
#7	#6	#5	#4	#3	#2	#1	#0
MCONS	*ESP	HRDY					

#06(*ESP) : Emergency stop signal

#07,#08,#09 : MCON signal (CNC→SV→PS)

#10(CRDY) : PS preparation completed signal

#11(RLY) : Relay signal (DB relay energized)

#12(INTL) : Interlock signal(DB relay de- energized)

#13(DRDY) : SV preparation completed signal

				TITLE	αi series SERVO AMPLIFIER for 30i-B Start-up and Maintenance manual		
				NO.	B-65285EN/03-02/01		
EDT.	DATE	DESIG.	DESCRIPTION	FANUC CORPORATION		PAGE	24 / 76

The following table lists the values of diagnosis information No.358 and the major failure causes. Do not detach or attach any connector while the power is on.

Values of diagnosis information No.358	Description of failures	Check items
417	Emergency stop has not been released.	(1) Check that an emergency stop signal applied to CX4 of the common power supply has been released. (2) Check that there is no anomaly on the connection for communication between the amplifiers or the related cable. (3) Replace the servo amplifier.
993	No PS ready signal (CRDY) is output.	(1) Check that there is no problem with the connection for communication (CXA2A/B) between the amplifiers or the related cable. (2) Check that the input power is supplied. (3) Check that the operation coil of the magnetic contactor is supplied with power and that there is no problem with the connection of CX3 of the common power supply. (4) Replace the servo amplifier.
4065	No interlock signal is input.	If the dynamic brake module (DBM) is in use, make checks (1) to (4). If not, replace the servo amplifier. (1) Check the connection between the servo amplifier and DBM. (2) Check the connection (CX1A/B) between the common power supply and servo amplifier. (3) Check that the fuse (FU2) on the common power supply control board has not blown. (4) Replace the servo amplifier.
225	—	Replace the servo amplifier.
481	—	Replace the servo amplifier.
2017	—	Replace the servo amplifier.
8161	—	Replace the servo amplifier.
97	—	Check that the axis detach function has not been set.

				TITLE	αi series SERVO AMPLIFIER for 30i-B Start-up and Maintenance manual		
				NO.	B-65285EN/03-02/01		
EDT.	DATE	DESIG.	DESCRIPTION	FANUC CORPORATION		PAGE	25 / 76

1.3.3 SPINDLE AMPLIFIER

(1) The PIL LED (power-on indicator) is off.

- (1) When the PIL LED on the spindle amplifier module does not become on after the main circuit breaker is turned on.

No.	Cause of trouble	Check method	Action
1	The 24V control power is not supplied.	The PS PIL lamp is off.	Check the cable attached to CX1D of PS.
2	The cable is defective.	The PS PIL lamp is on.	Check the cable attached to the connector CXA2A/B.
3	The power is externally connected to 0 V, GND, or the like.	When the connector is detached, the PIL lamp is on.	Replace or repair the cable.
4	There is a blown fuse on the printed circuit board.	Even when all cables except the cable attached to connector CX2A/B are detached, the PIL lamp does not come on.	If the fuse blows, the printed circuit board may be faulty. Replace the unit.
5	The printed circuit board is defective.		Replace the unit.

(2) The STATUS display is blinking with "--."

- (1) When no spindle communication alarm message is indicated on the CNC
Check whether the CNC software option setting or bit setting is correct.
- (2) When a communication alarm message is indicated on the CNC

No.	Cause of trouble	Check method	Action
1	The cable is defective.	Check the connector housing section.	Repair or replace the cable.
2	The printed circuit board is defective.		Replace the unit.

				TITLE	αi series SERVO AMPLIFIER for 30 <i>i</i> -B Start-up and Maintenance manual		
				NO.	B-65285EN/03-02/01		
EDT.	DATE	DESIG.	DESCRIPTION	FANUC CORPORATION		PAGE	26 / 76

(3) The motor does not turn.

- (1) When "--" is indicated on the STATUS display of the SP

Check whether spindle control signals are input. (An example for the first spindle is shown below.)

FS30i	#7	#6	#5	#4	#3	#2	#1	#0
G070	MRDYA		SFRA	SRVA				
G071							*ESPA	
G029		*SSTP						
G030	SOV7	SOV6	SOV5	SOV4	SOV3	SOV2	SOV1	SOV0

- (2) When "00" is indicated on the STATUS display of the SP

No spindle speed command is input.

Refer to Chapter 1 in "FANUC AC SPINDLE MOTOR α i series Parameter Manual (B-65280EN)," and check related parameters.

- (3) When an alarm number is indicated on the SP

See the description of the alarm number in Part II.

(4) A specified speed cannot be obtained.

- (1) When the speed always differs from a specified speed

Check parameters.

Refer to Chapter 1 in "FANUC AC SPINDLE MOTOR α i series Parameter Manual (B-65280EN)," and check related parameters.

- (2) When an alarm number is indicated on the SP

See the description of the alarm number in Part II.

(5) When cutting is not performed, the spindle vibrates, making noise.

- (1) The spindle vibrates only when the spindle speed has reached or is at a particular speed level.

Check whether the spindle also vibrates when the motor is turning by inertia. If noise is unchanged, investigate the source of mechanical vibration. There are several methods to turn the spindle by inertia as explained below. Because these methods involve machine sequences, consult with the machine tool builder.

A. Setting spindle control signal MPOF (FS30i-B: G73#2) to 1 immediately causes the spindle to turn by inertia.

B. Set ALSP (FS30i-B: bit 2 of parameter No. 4009) to 1. Then, when the power to the CNC is turned off during spindle rotation, the spindle turns by inertia. (On the spindle amplifier, Alarm 24 is indicated.)

- (2) When noise is generated at the time the motor is stopped or at any time

A. See Subsection 4.3.4 of this part, and check and adjust the waveform of the spindle sensor.

B. Check that the motor part number matches its parameters. For details, refer to Appendix A in "FANUC AC SPINDLE MOTOR α i series Parameter Manual (B-65280EN)."

C. Adjust the velocity loop gain and so forth.

For details, refer to Chapter 1 in "FANUC AC SPINDLE MOTOR α i series Parameter Manual (B-65280EN)."

				TITLE	α i series SERVO AMPLIFIER for 30i-B Start-up and Maintenance manual		
				NO.	B-65285EN/03-02/01		
EDT.	DATE	DESIG.	DESCRIPTION	FANUC CORPORATION		PAGE	27 / 76

(6) An overshoot or hunting occurs.

Refer to Chapter 1 in "FANUC AC SPINDLE MOTOR αi series Parameter Manual (B-65280EN)," and adjust parameters.

(7) Cutting power weakens or acceleration/deceleration slows down.

- (1) When the load meter does not indicate the maximum output
 - A. A mechanical cause such as a belt slip may occur.
- (2) When the load meter indicates the maximum output
 - A. Check whether the torque limit signal is input incorrectly.

FS30i	#7	#6	#5	#4	#3	#2	#1	#0
G070							TLMHA	TLMLA

B. If you are using the αi BZ sensor, it is likely that a slip has occurred between the sensor gear and spindle (on acceleration).

C. Check that the motor part number matches its parameters.

For details, refer to Appendix A in "FANUC AC SPINDLE MOTOR αi series Parameter Manual (B-65280EN)."

D. Check whether the output limit pattern is set incorrectly.

For details, refer to Chapter 1 in "FANUC AC SPINDLE MOTOR αi series Parameter Manual (B-65280EN)."

				TITLE	αi series SERVO AMPLIFIER for 30i-B Start-up and Maintenance manual		
				NO.	B-65285EN/03-02/01		
EDT.	DATE	DESIG.	DESCRIPTION	FANUC CORPORATION		PAGE	28 / 76

(8) Status Error Indication Function

When a parameter is set incorrectly or a sequence is incorrect, the error LED (orange) on the indicator of the spindle amplifier (SP) is turned on, and an error code is displayed.

Ex. Display of error indicator

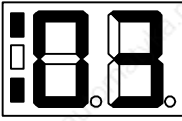
Status	Indicator
Error display	 <p>error LED and error code</p>

The error is also displayed on the diagnosis screen of the CNC.

Diagnostic number	Content
FS30i	
710	State error number

When the spindle amplifier module does not operate for a certain function, check whether the status error is indicated in the display section of the SP or the diagnosis screen of the CNC.

No.	Description	Action
01	Although neither *ESP (emergency stop signal) (there are two types of signals, a PMC signal and PSM contact signal) nor MRDY (machine ready signal) has been input, SFR (forward rotation signal), SRV (reverse rotation signal), or ORCM (orientation command) is input.	Check the *ESP and MRDY sequences. For MRDY, pay attention to the parameter that specifies whether to use the MRDY signal (bit 0 of parameter No. 4001).
03	Although parameter settings are such that there is no position sensor (position control is not to be performed, that is, bits 3, 2, 1, and 0 of parameter No. 4002 are, respectively, 0, 0, 0, and 0), a Cs axis contour control command has been issued. In this case, the motor is not activated.	Check setting of the parameter.
04	Although parameter settings are such that there is no position sensor (position control is not to be performed, that is, bits 3, 2, 1, and 0 of parameter No. 4002 are, respectively, 0, 0, 0, and 0), a servo mode (such as rigid tapping or Cs axis control) command or spindle synchronization control command has been issued. In this case, the motor is not activated.	Check setting of the parameter.
05	Although optional parameter for the orientation function is not set, an ORCM (orientation command) is input.	Check setting of the parameter for orientation.

				TITLE	αi series SERVO AMPLIFIER for 30i-B Start-up and Maintenance manual		
				NO.	B-65285EN/03-02/01		
EDT.	DATE	DESIG.	DESCRIPTION	FANUC CORPORATION		PAGE	29 / 76

No.	Description	Action
06	Although optional parameter for the output switching option is not set, low-speed winding is selected (RCH = 1).	Check setting of the parameter for output switching and the power line status signal (RCH).
07	Although Cs contour control mode is input, neither SFR (forward rotation signal) nor SRV (reverse rotation signal) is input.	Check the sequence.
08	Although servo mode (rigid tapping or spindle positioning) control command is input, neither SFR (forward rotation signal) nor SRV (reverse rotation signal) is input.	Check the sequence.
09	Although spindle synchronization control command is input, neither SFR (forward rotation signal) nor SRV (reverse rotation signal) is input.	Check the sequence.
10	Although Cs contour control command is input, another operation mode (servo mode, spindle synchronization, or orientation) is specified.	Do not specify another mode during execution of the Cs contour control command. Before entering another mode, cancel the Cs contour control command.
11	Although servo mode (rigid tapping or spindle positioning) is input, another operation mode (Cs contour control, spindle synchronization, or orientation) is specified.	Do not specify another mode during execution of the servo mode command. Before entering another mode, cancel servo mode.
12	Although spindle synchronization is input, another operation mode (Cs contour control, servo mode, or orientation) is specified.	Do not specify another mode during execution of the spindle synchronization command. Before entering another mode, cancel the spindle synchronization command.
13	Although orientation specification is input, another operation mode (Cs contour control, servo mode, or synchronization control) is specified.	Do not specify another mode during execution of the spindle synchronization command. Before entering another mode, cancel the spindle synchronization command.
14	The SFR (forward rotation signal) and SRV (reverse rotation signal) are input at the same time.	Input one of the SFR and SRV signals.
16	Although the parameter not to use the differential speed control function (bit 5 of parameter No. 4000 = 0) is set, DEFMD (differential speed mode command) is input.	Check the setting of the parameter and the differential speed mode command
17	The parameter settings for the speed detector (bits 2, 1, and 0 of parameter No. 4011) are invalid. There is no speed detector that matches the settings.	Check the setting of the parameter.

				TITLE	αi series SERVO AMPLIFIER for 30i-B Start-up and Maintenance manual		
				NO.	B-65285EN/03-02/01		
EDT.	DATE	DESIG.	DESCRIPTION	FANUC CORPORATION		PAGE	30 / 76

No.	Description	Action
18	Although parameter settings are such that there is no position sensor (position control is not to be performed, that is, "bits 3, 2, 1, and 0 of parameter No. 4002 are, respectively, 0, 0, 0, and 0," a position coder-based orientation command has been issued.	Check the setting of the parameter and the input signal.
19	Although magnetic sensor orientation command is input, another operation mode (Cs contour control, servo mode, or spindle synchronization) is specified.	Do not specify another mode during execution of the orientation command. Before entering another mode, cancel the orientation command.
21	A tandem operation command was input when spindle synchronous control is enabled.	Input a tandem operation command after canceling spindle synchronous control.
22	Spindle synchronous control was specified when tandem operation is enabled.	Specify spindle synchronous control after canceling torque tandem operation.
23	A tandem operation command is input even if the option is not specified.	Torque tandem control requires the CNC software option. Check the option.
24	Although continuous indexing in position coder-based orientation is to be performed, an absolute position command (INCMD = 0) has been issued after incremental operation (INCMD = 1).	Check the INCMD (incremental command). Be sure to perform absolute position command-based orientation before an absolute position command.
26	Parameter settings are made to use both spindle switching and three stage speed range switching control.	Check the parameter settings and input signals.
29	Parameter settings are such that the shortest-time orientation function is to be used (bit 6 of parameter No. 4018 is 0 and parameter Nos. 4320 to 4323 are nonzero).	The shortest-time orientation function cannot be used in the αi series spindle amplifier. Use a different type of orientation.
30	The magnetic pole undetected state is set, but a command is input.	In the magnetic pole undetected state (EPFIXA=0), the motor cannot be driven even if a command is input. input a command in the magnetic pole detection completed state (EPFIXA=1). While EPFSTR=1 is set, a command is ignored even in the magnetic pole detection completed state, and this error is indicated. Upon completion of magnetic pole detection, set EPFSTR=0.
31	This hardware configuration does not support the use of the spindle FAD function. In this case, the motor is not activated.	Check the CNC model.
32	Although S0 is not specified for the speed mode, the parameter setting is made to enable the disturbance input function (bit 7 of parameter No.4395 =1).	Specify S0 for the speed mode before enabling the disturbance input function (setting bit 7 of parameter No.4395 to 1).

				TITLE	αi series SERVO AMPLIFIER for 30 <i>i</i> -B Start-up and Maintenance manual		
				NO.	B-65285EN/03-02/01		
EDT.	DATE	DESIG.	DESCRIPTION	FANUC CORPORATION		PAGE	31 / 76

No.	Description	Action
33	This hardware configuration does not support the use of the spindle EGB function. In this case, the motor is not activated.	Check the CNC model.
34	Both spindle FAD function and spindle EGB function are enabled. In this case, the motor is not activated.	These functions cannot be used at the same time. Enable only one of the functions
35	ID information of the spindle amplifier cannot be obtained.	Replace the spindle amplifier with one for which correct ID information is written
36	The SSM is abnormal. (1) The interface signal between the spindle amplifier(SP) and SSM is disconnect. (2) The SSM is faulty.	For action to be taken for this error, see Section 1.4."SUB MODULE SM", in Part IV in FANUC AC SPINDLE MOTOR αi series PARAMETER MANUAL B-65280JA.
37	The current loop setting (parameter No.4012) is changed.	Check the setting of parameter No.4012, and turn the power off, then on again.
38	-Parameters related to inter-spindle amplifier communication are not set correctly. -Functions that cannot be used together with the torque tandem function are set.	Check the parameters.
39	DSCN(disconnection detection disable signal) is input in the state where SFR (forward rotation command), SRV (reverse rotation command), or ORCM (orientation command) is input.	Check the sequence. Do not input DSCN(disconnection detectiondisable signal) while a command for motor activation is input.
43	A setting unavailable with the αi CZ sensor (serial) is made.(*1)	Check the parameters.
44	The spindle amplifier does not support the control frequency setting.	Check the setting of parameter No.4012.

				TITLE	αi series SERVO AMPLIFIER for 30 i -B Start-up and Maintenance manual		
				NO.	B-65285EN/03-02/01		
EDT.	DATE	DESIG.	DESCRIPTION	FANUC CORPORATION		PAGE	32 / 76

Note

*1 If state error 43 is displayed, check the following items.

- <1> The setting is made so that the αi CZ sensor (serial) is used as both of the motor and spindlesensors. (No.4010#2,1,0=0,1,0 and No.4002#3,2,1,0=0,1,1,0)
- <2> Spindle HRV control is not set. (No.4012#7=0)
- <3> The use of the differential spindle speed control function is set. (No.4000#5=1)
- <4> The use of the spindle switching control function is set. (No.4014#0=1)
- <5> The setting is made so that alarms related to position feedback are not detected.
(No.4007#6=1 or No.4016#5=0)
- <6> The setting is made so that feedback signal disconnection is not detected. (No.4007#5=1)
- <7> The setting is made so that alarms related to threading position detection signal feedback are not detected. (No.4016#5=0)
- <8> The use of an external one-rotation signal is set. (No.4004#2=1)
- <9> The use of a position coder is set. (No.4002#3,2,1,0=0,0,1,0)
- <10> The setting is made so that the synchronous built-in spindle motor is driven.
(No.4012#6=1)
- <11> The use of inter-spindle amplifier communication is set. (No.4352#7=1 or No.4352#6=1)
- <12> The use of the dual check safety function is set.
- <13> The use of the spindle tandem function is set. (No.4015#3=1)
- <14> The use of the αi CZ sensor (serial) as the motor sensor is set and the dual check safety function is enabled.

				TITLE	αi series SERVO AMPLIFIER for 30i-B Start-up and Maintenance manual		
				NO.	B-65285EN/03-02/01		
EDT.	DATE	DESIG.	DESCRIPTION	FANUC CORPORATION	PAGE	33 / 76	

2. TROUBLESHOOTING

2.1. TROUBLESHOOTING PROCEDURES

2.1.1 Troubleshooting Procedure

Smart trouble shooting function is available for the combination of the 30*i*-B series CNC and the αi servo amplifier for the 30*i*-B series. The function analyzes causes of alarm occurrence and shows how to remove them. At alarm occurrence, switch from the CNC screen to the “Trouble diagnosis guidance” screen and remove the cause of the alarm according to what is displayed on the screen.

⇒ 2.2 SMART TROUBLE SHOOTING FUNCTION

⇒ 2.2.1 Failure Diagnosis Guidance

IMPORTANT

- Using the failure diagnosis guidance requires keeping it in the “SAMPLING” status. See Subsection 2.2.3 for explanations about how to shift to the “SAMPLING” status.

Data (about power supply, motor current, and detector) related to servo amplifiers before alarm and just at alarm are sent to the CNC immediately. This data can be used in taking action for alarm occurrence.

Data (about power supply, motor current, and detector) related to servo amplifiers is saved to the CNC immediately before and at alarm occurrence. This data can be used in taking action for alarm occurrence.

⇒ 2.2.2 Failure Diagnosis Monitor

IMPORTANT

- The failure diagnosis monitor has two status, “SAMPLING” and “LATCHED”. If you want to monitor data at future alarm occurrence, perform “CLEAR”. If you want to save the conditions at past alarm occurrence, do not perform “CLEAR”. See Subsection 2.2.3 for detailed descriptions of this procedure.

See Section 2.3 for lists of CNC alarm numbers related to servos and LED indication numbers on servo amplifiers.

NOTE

- There might be a possibility that you cannot get exact analysis even when you use smart trouble shooting function. In such case, identify the alarm number, the program where the alarm occur, and what you operated, and then make a service call.

				TITLE	αi series SERVO AMPLIFIER for 30 <i>i</i> -B Start-up and Maintenance manual		
				NO.	B-65285EN/03-02/01		
EDT.	DATE	DESIG.	DESCRIPTION	FANUC CORPORATION	PAGE	34 / 76	

2.2. SMART TROUBLE SHOOTING FUNCTION

The 30*i*-B series CNC has a function for failure diagnosis. With this function, the operator can get diagnostic information that may be useful to make decisions at the occurrence of a servo, spindle, or CNC alarm from the CNC screen.

The major features of the smart trouble shooting function are as follows:

- “Trouble diagnosis guidance” screen for figuring out alarm causes according to the failure diagnosis flow
- “Trouble diagnosis monitor” screen for monitoring the states of servo circuits and spindles during normal operation and enabling data to be latched at alarm occurrence
- “Trouble diagnosis graphic” screen for making it possible to display waveforms observed at the occurrence of a servo or spindle alarm

In all of these features, the “Trouble diagnosis guidance” screen can be used to identify an alarm cause and how to handle it quickly, leading to a possible improvement in facility availability ratio due to a reduction of down time.

Shown below is an example of the “Trouble diagnosis guidance” screen.

The screenshot shows the following data:

ACTUAL POSITION				
ABSOLUTE				
X	0	.	0000	
Y	0	.	0000	
Z	0	.	0000	

MODAL				
G00	G80	G15	F	M
G17	G98	G40.1	H	M
G90	G50	G25	D	M
G22	G67	G160	T	
G94	G97	G13.1	S	
G21	G54	G50.1		
G40	G64	G54.2		
G49	G69	G80.5		

TROUBLE DGN. GUIDANCE

NC-SV0410 01/01

Xax: EXCESS ERROR (STOP)

PROBABLE CAUSE :

1. CHANGE LOAD LARGELY
2. SEPARATE DETECTOR FAILURE
3. SV AMP FAILURE

GUIDANCE :

Does TCMD vibrate on trouble diagnosis graphic screen before the alarm occur?

LATCHED

Trouble diagnosis guidance screen

The failure diagnosis guidance executes a diagnosis flow to identify these causes. Many analyses are made automatically according to information inside of CNC. However, questions may be displayed on the guidance screen in making some analyses. Answer the questions using the soft key [YES] or [No] to proceed on the guidance flow.

NOTE

- “PROBABLE CAUSE” and “GUIDANCE” (how to handle) show the most likely information obtained. Before any replacement, make a double check using another method (for example, detecting an insulation resistance or checking conductivity).

				TITLE	α <i>i</i> series SERVO AMPLIFIER for 30 <i>i</i> -B Start-up and Maintenance manual		
				NO.	B-65285EN/03-02/01		
EDT.	DATE	DESIG.	DESCRIPTION	FANUC CORPORATION	PAGE	35 / 76	

2.2.1 Failure Diagnosis Guidance

IMPORTANT

- Using the failure diagnosis guidance requires keeping it in the “SAMPLING” status. See Subsection 2.2.3 for explanations about how to shift to the “SAMPLING” status.

Explained below is how to use the failure diagnosis guidance to identify the causes of alarm occurrence, using SV011 (“EXCESS ERROR (MOVING)”) and SV0449 (“SV IPM ALARM”) as examples.

Alarm example 1) Occurrence of SV0411 (“EXCESS ERROR (MOVING)”)

(1) At alarm occurrence, follow the steps below to display the “Trouble diagnosis guidance” screen.

<1> If no alarm screen appears, press the Message key.

<2> Keep pressing the continuation menu key [>] until the soft key [GUIDE] appears.

<3> Press the soft key [GUIDE].

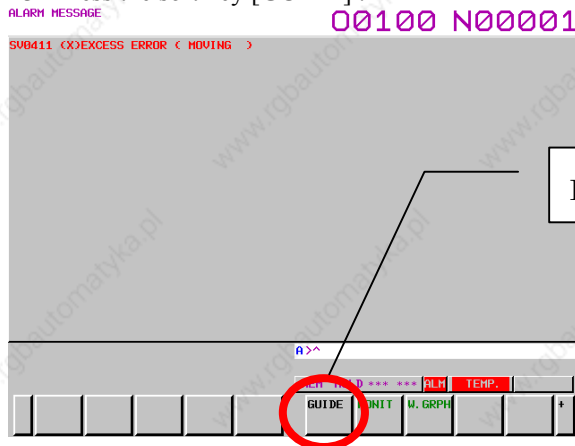

(2) There are some causes to occur EXCESS ERROR as follows.

- Amplifier abnormal
- Power wire or motor winding short-circuited
- Power wire or motor winding broken
- Servo-off signal malfunctioning
- Excessive load fluctuation
- Brake faulty
- Command for speed higher than specification issued

The failure diagnosis guidance executes a diagnosis flow to identify these causes. Many analyses are made automatically according to information within the NC. However, questions may be displayed on the guidance screen in making some analyses. Answer the questions using the soft key [YES] or [NO] to proceed on the guidance flow.

				TITLE	αi series SERVO AMPLIFIER for 30i-B Start-up and Maintenance manual		
				NO.	B-65285EN/03-02/01		
EDT.	DATE	DESIG.	DESCRIPTION	FANUC CORPORATION	PAGE	36 / 76	

Example) “EXCESS ERROR (MOVING)” resulting from a broken power wire

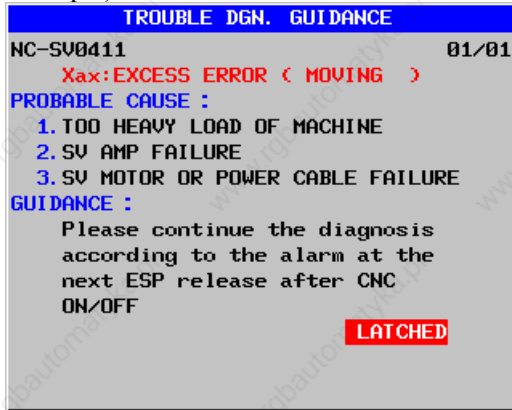

Pressing [GUIDE] causes the message shown on the left to appear. The guidance requests you to turn off the power once. After the servo amplifier is turned off and on again, self-diagnosis is conducted.

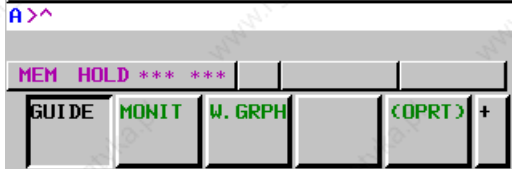

Just after the servo amplifier is turned on, self-diagnosis was conducted, and the “PHASE OPEN” alarm occurred. Press the [GUIDE] button again to display the “Trouble diagnosis guidance” screen.

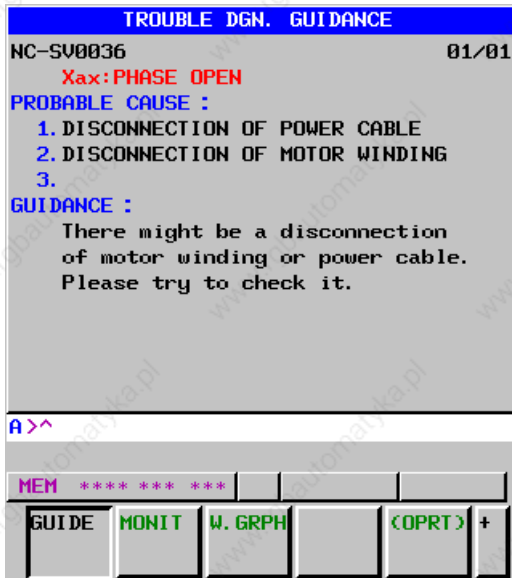

The [Trouble diagnosis guidance] screen suggests a possible broken motor winding or power wire. Take action as directed by the message.

				TITLE	αi series SERVO AMPLIFIER for 30i-B Start-up and Maintenance manual		
				NO.	B-65285EN/03-02/01		
EDT.	DATE	DESIG.	DESCRIPTION	FANUC CORPORATION	PAGE	37 / 76	

Alarm example 2) Occurrence of SV0449 ([SV IPM alarm])

- (1) At alarm occurrence, follow the steps below to display the “Trouble diagnosis guidance” screen.
 - <1> If no alarm screen appears, press the Message key.
 - <2> Keep pressing the continuation menu key [>] until the soft key [GUIDE] appears.
 - <3> Press the soft key [GUIDE] .

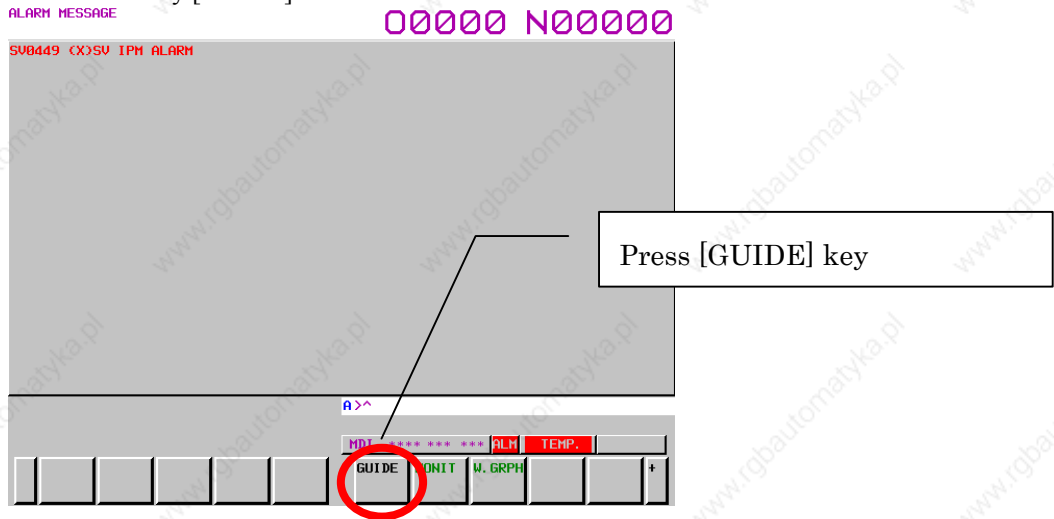

- (2) There are some causes to occur “SV IPM alarm” as follows.

- Amplifier abnormal
- Power wire or motor winding short-circuited
- Power wire or motor winding broken
- Current control disturbed

The failure diagnosis guidance executes a diagnosis flow to identify these causes. Many analyses are made automatically according to information within the NC. However, questions may be displayed on the guidance screen in making some analyses. Answer the questions using the soft key [YES] or [NO] to proceed on the guidance flow.

Example) “SV IPM alarm” resulting from a broken power wire

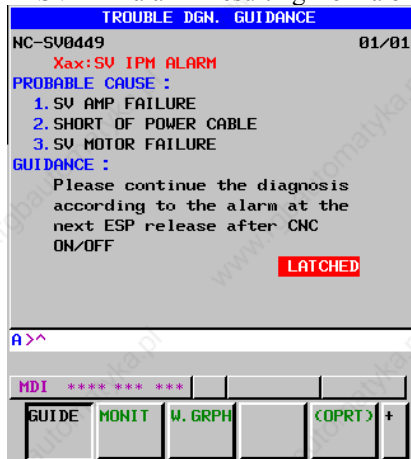

Pressing [GUIDE] causes the message shown on the left to appear. The guidance requests you to turn off the power once. After the servo amplifier is turned off and on again, self-diagnosis is conducted.

				TITLE	αi series SERVO AMPLIFIER for 30i-B Start-up and Maintenance manual		
				NO.	B-65285EN/03-02/01		
EDT.	DATE	DESIG.	DESCRIPTION	FANUC CORPORATION	PAGE	38 / 76	



Just after the servo amplifier is turned on, self-diagnosis was conducted, and the “FAILURE OF CURRENT CTL” alarm occurs. Display the “Trouble diagnosis guidance” screen again.

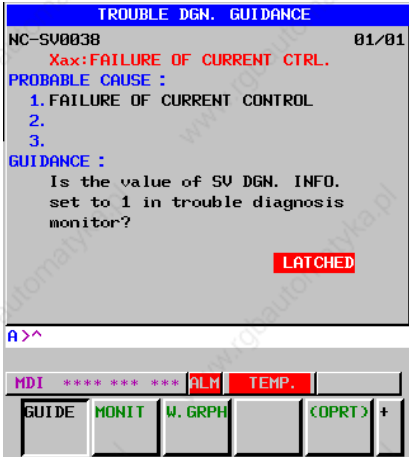

The guidance displays “Is the value of SV DGN. INFO. set to 1 in trouble diagnosis monitor?”. So, view the “Trouble diagnosis monitor” screen.

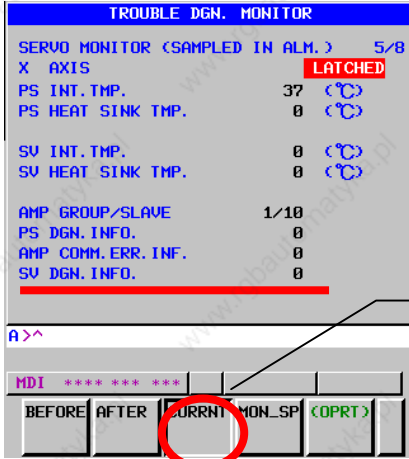

Press [CURRENT] key



				TITLE	αi series SERVO AMPLIFIER for 30i-B Start-up and Maintenance manual		
				NO.	B-65285EN/03-02/01		
EDT.	DATE	DESIG.	DESCRIPTION	FANUC CORPORATION	PAGE	39 / 76	

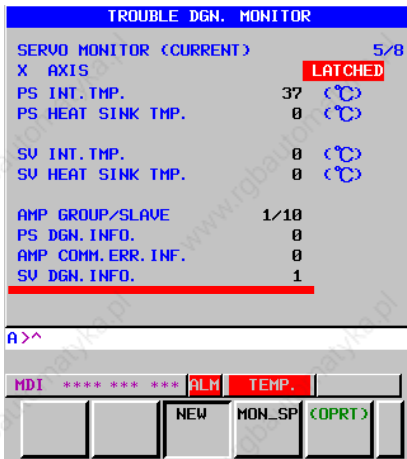

Check the value of [SV DNG INFO], which is either [0] or [1]. [1] means that a short-circuited power cable or motor winding was detected at servo amplifier self-diagnosis.

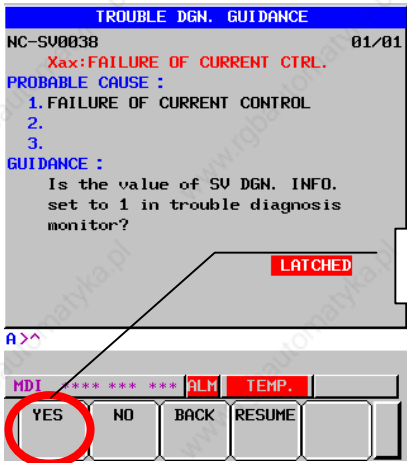

Display the “Trouble diagnosis guidance” screen, and press [YES] on the screen.

Press [YES] key

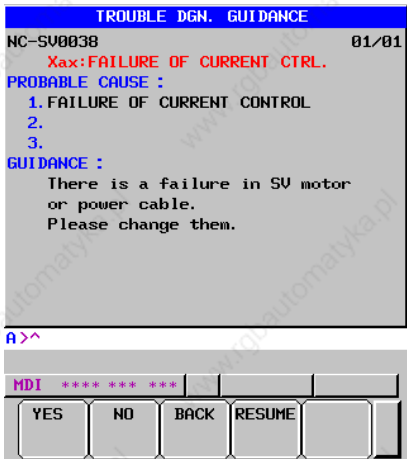

The guidance suggests a possibility of short-circuited power wire or motor winding. Take action according to the message.

				TITLE	αi series SERVO AMPLIFIER for 30i-B Start-up and Maintenance manual		
				NO.	B-65285EN/03-02/01		
EDT.	DATE	DESIG.	DESCRIPTION	FANUC CORPORATION	PAGE	40 / 76	

2.2.2 Failure Diagnosis Monitor

IMPORTANT

- The failure diagnosis monitor has two status, "SAMPLING" and "LATCHED". If you want to monitor data at future alarm occurrence, perform "CLEAR". If you want to save the conditions at past alarm occurrence, do not perform "CLEAR". See Subsection 2.2.3 for detailed descriptions of this procedure.

The failure diagnosis monitor can display the following information.

Follow the steps below to display the "Trouble diagnosis monitor" screen.

- Press the Message key to display the alarm screen.
- Keep pressing the continuation menu key [>] until the soft key [MONIT] appears.
- Press the soft key [MONIT] to display the "Trouble diagnosis monitor" screen.

				TITLE	αi series SERVO AMPLIFIER for 30i-B Start-up and Maintenance manual		
				NO.	B-65285EN/03-02/01		
EDT.	DATE	DESIG.	DESCRIPTION	FANUC CORPORATION		PAGE	41 / 76

How to check data just before alarm and at alarm occurrence

The failure diagnosis monitor enables the operator to view:

- Data at the moment
- Data at alarm occurrence
- Data some sampling periods before alarm occurrence

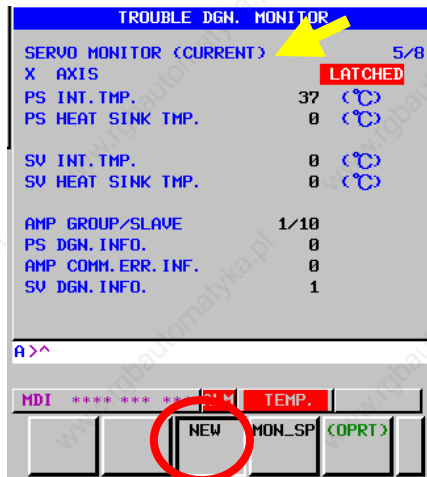

Current value

At alarm occurrence, pressing [NEW] button:

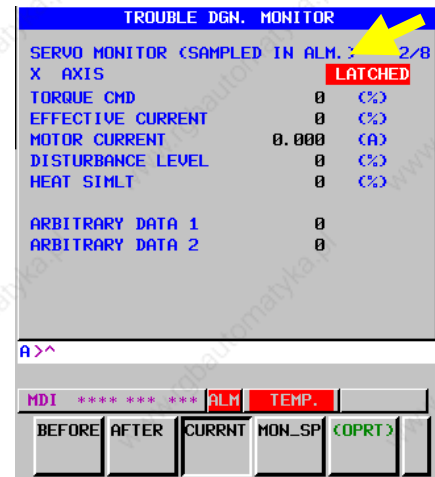

The value at time of alarm

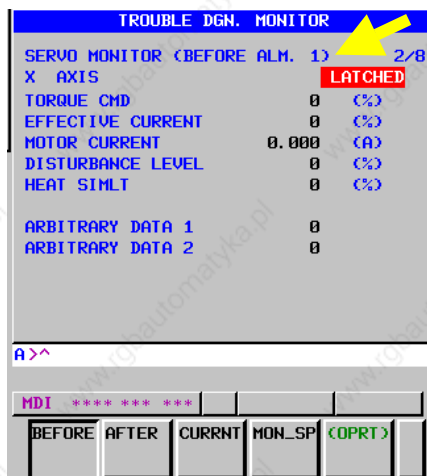

The value before 1 sampling

Pressing [BEFORE] button lets the operator go back 5 sampling periods.

				TITLE	αi series SERVO AMPLIFIER for 30i-B Start-up and Maintenance manual		
				NO.	B-65285EN/03-02/01		
EDT.	DATE	DESIG.	DESCRIPTION	FANUC CORPORATION	PAGE	42 / 76	

Details of the monitor screens related to servo amplifiers

TROUBLE DGN. MONITOR	
SERVO MONITOR (SAMPLED IN ALM.)	1/8
X AXIS	LATCHED
COM. PULSE	200166 (pulse)
F. B. PULSE	-1 (pulse)
REF. COUNT	166 (pulse)
POS. ERROR	200166 (pulse)
ACT. SPEED	0 (1/min)
AMR DATA	248

TROUBLE DGN. MONITOR	
SERVO MONITOR (SAMPLED IN ALM.)	2/8
X AXIS	LATCHED
TORQUE CMD	89 (%)
EFFECTIVE CURRENT	0 (%)
MOTOR CURRENT	0.000 (A)
DISTURBANCE LEVEL	0 (%)
HEAT SIMLT	0 (%)
ARBITRARY DATA 1	6554
ARBITRARY DATA 2	6554

TROUBLE DGN. MONITOR	
SERVO MONITOR (SAMPLED IN ALM.)	3/8
X AXIS	LATCHED
DC LINK VOLT.	294 (V)
PS VOLTAGE RMS	211 (Vrms)
PS VOLT. UMBALANCE	0.5 (%)
PS VOLTAGE THD	0.5 (%)
PS CURRENT	0 (A)
PS STATUS FLAG1	0
PS STATUS FLAG2	0
PS STATUS FLAG3	0
PS STATUS FLAG4	0
PS INPUT FREQ	50.0 (Hz)

TROUBLE DGN. MONITOR	
SERVO MONITOR (SAMPLED IN ALM.)	4/8
X AXIS	LATCHED
SV INS. INFO.	0
SV INS. RESISTANCE	0.0 (MΩ)

TROUBLE DGN. MONITOR	
SERVO MONITOR (SAMPLED IN ALM.)	5/8
X AXIS	LATCHED
PS INT. TMP.	36 (°C)
PS HEAT SINK TMP.	0 (°C)
SV INT. TMP.	0 (°C)
SV HEAT SINK TMP.	0 (°C)
AMP GROUP/SLAVE	1/10
PS DGN. INFO.	0
AMP COMM. ERR. INF.	0
SV DGN. INFO.	0

TROUBLE DGN. MONITOR	
SERVO MONITOR (SAMPLED IN ALM.)	6/8
X AXIS	LATCHED
SV FSSB UPR. ERR.	0 0
SV FSSB LWR. ERR.	0 0
SV FSSB UPR. JTR.	6D74 3F00
SV FSSB LWR. JTR.	71B4 373E
SDU FSSB UPR. ERR.	0 0
SDU FSSB LWR. ERR.	0 0
SDU FSSB UPR. JTR.	0 0
SDU FSSB LWR. JTR.	0 0

TROUBLE DGN. MONITOR	
SERVO MONITOR (SAMPLED IN ALM.)	7/8
X AXIS	LATCHED
INT. DTCT. INTP. CNT	0
INT. DTCT. COM. CNT	0
INT. DETECTOR WRN.	0
EXT. DTCT. INTP. CNT	0
EXT. DTCT. COM. CNT	0
EXT. DETECTOR WRN.	0
SV DATA1	0
SV DATA2	0
SV DATA3	0
SV DATA4	0

TROUBLE DGN. MONITOR	
SERVO MONITOR (SAMPLED IN ALM.)	8/8
X AXIS	LATCHED
LAST LATCH DATE	04/06/08
LAST LATCH TIME	14:37:43
EXECUTED FILE NAME	
	0100
EXECUTED N-NUM.	1

				TITLE	αi series SERVO AMPLIFIER for 30i-B Start-up and Maintenance manual		
				NO.	B-65285EN/03-02/01		
EDT.	DATE	DESIG.	DESCRIPTION	FANUC CORPORATION	PAGE	43 / 76	

Data (unit)	Data explanation	Display page No.
COMMAND PULSE (pulse)		1/8
F.B. PULSE (pulse)	(Note 3)	1/8
REF.COUNTER (pulse)		1/8
POS. ERROR (pulse)		1/8
ACTUAL SPEED (1/min)		1/8
AMR DATA	Armature position data of motor (256/1cycle of motor current)	1/8
TORQUE COMMAND (%)	Maximum torque =100%	2/8
EFFECTIVE CURRENT (%)	Maximum current of servo amplifier =100%	2/8
MOTOR CURRENT (A)		2/8
DISTURBANCE LEVEL (%)	Alarm level of unexpected disturbance torque detection =100%	2/8
HEAT SIMULATION (%)	OVC alarm level =100%	2/8
ARBITRARY DATA1	(note2)	2/8
ARBITRARY DATA2	(note2)	2/8
DC LINK VOLT. (V)	Instantaneous value (Note 3)	3/8
PS VOLTAGE RMS (Vrms)	Average of 1cycle of input power supply(Note 3)	3/8
PS VOLT.UMBALANCE (%)	Average of 1cycle of input power supply (Note 3)	3/8
PS VOLTAGE THD (%)	Average of 1cycle of THD(Total Harmonic Distortion) (Note 3)	3/8
PS CURRENT (A)	Average of current amplitude of the 1 cycle of input power supply (Note 3)	3/8
PS STATUS FLAG 1	(Note 4)	3/8
PS STATUS FLAG 2	(Note 4)	3/8
PS STATUS FLAG 3	(Note 4)	3/8
PS STATUS FLAG 4	(Note 4)	3/8
PS INPUT FREQ (Hz)	Average of 1cycle of input power supply (Note 3)	3/8
SV INS.INFO.	State flage of INSULATION DETERIORATION DETECTION FUNCTION	4/8
SV INS.RESISTANCE (MΩ)	Insulation resistance (Note 3)	4/8
PS INT.TMP. (°C)	(Note 3)	4/8
PS HEAT SINK TMP. (°C)	(Note 3)	5/8
SV INT.TMP. (°C)	(Note 3)	5/8
SV HEAT SINK TMP. (°C)	(Note 3)	5/8
AMP GROUP/SLAVE	Groupe No. and Slave No.	5/8
PS DGN.INFO.	State flage of PS	5/8
AMP COMM.ERR.INF.	Error state flage of communication between amplifier	5/8

				TITLE	αi series SERVO AMPLIFIER for 30i-B Start-up and Maintenance manual		
				NO.	B-65285EN/03-02/01		
EDT.	DATE	DESIG.	DESCRIPTION	FANUC CORPORATION		PAGE	44 / 76

SV DGN.INFO.	State flag of SV	5/8
SV FSSB UPR.ERR.	(Note 5)	6/8
SV FSSB LWR.ERR.	(Note 5)	6/8
SV FSSB UPR.JTR.	(Note 5)	6/8
SV FSSB LWR.JTR.	(Note 5)	6/8
SDU FSSB UPR.ERR.	(Note 5)	6/8
SDU FSSB LWR.ERR.	(Note 5)	6/8
SDU FSSB UPR.JTR.	(Note 5)	6/8
SDU FSSB LWR.JTR.	(Note 5)	6/8
INT.DTCT.INTP.CNT	The number of times by which the data of a built-in detector was disturbed in the noise (The number of times which detected the abnormalities in data)	7/8
INT.DTCT.COM.CNT	The number of times which detected the abnormalities in data of a built-in detector (The number of times which detected the communication error)	7/8
INT.DETECTOR WRN.	Warning information of a built-in detector	7/8
EXT.DTCT.INTP.CNT	The number of times by which the data of a separated detector was disturbed in the noise (The number of times which detected the abnormalities in data)	7/8
EXT.DTCT.COM.CNT	The number of times which detected the abnormalities in data of a separated detector (The number of times which detected the communication error)	7/8
EXT.DETECTOR WRN.	Warning information of a separated detector	7/8
SV DATA 1	(Note 2)	7/8
SV DATA 2	(Note 2)	7/8
SV DATA 3	(Note 2)	7/8
SV DATA 4	(Note 2)	7/8
LAST LATCH DATE		8/8
LAST LATCH TIME		8/8
EXECUTED FILE NAME		8/8
EXECUTED N-NUM		8/8

				TITLE	αi series SERVO AMPLIFIER for 30i-B Start-up and Maintenance manual		
				NO.	B-65285EN/03-02/01		
EDT.	DATE	DESIG.	DESCRIPTION	FANUC CORPORATION		PAGE	45 / 76

NOTE

- 1 The range of displays listed above is only the one that can be displayed with the monitor function. It includes neither a system performance nor a rated value.
- 2 Arbitrary data items 1 and 2 and SV data items 1 to 4 are intended for use by FANUC for maintenance purposes.
- 3 The displayed voltage, current, frequency, resistance, and temperature values are approximate values with some error included. If accurate data is needed, measure them using dedicated measuring instruments.
- 4 PS status flags 1 to 4 are intended for use by FANUC for maintenance purposes.
- 5 FSSB errors and jitter data indicate the status of FSSB communication. They are intended for use by FANUC for maintenance purposes.

				TITLE	<i>α</i> series SERVO AMPLIFIER for 30 <i>i</i> -B Start-up and Maintenance manual		
				NO.	B-65285EN/03-02/01		
EDT.	DATE	DESIG.	DESCRIPTION	FANUC CORPORATION		PAGE	46 / 76

Details of the monitor screens related to spindle amplifiers

TROUBLE DGN. MONITOR	
SPINDLE MONIT (BEFORE ALM. 1)	1/9
SPINDLE :	LATCHED
OPERATION	
GEAR/OUT SEL	/
COMMAND PULSE	(pulse)
COMMAND SPEED	(1/min)
CONTROL INPUT	
CONTROL OUTPUT	

TROUBLE DGN. MONITOR	
SPINDLE MONIT (BEFORE ALM. 1)	2/9
SPINDLE :	LATCHED
SPINDLE SPEED	
ACT. MOTOR SPEED	(1/min)
LOAD METER	(%)
TORQUE CMD	(%)
MOTOR CURRENT	(A)
HEAT SIMU. (MOTOR)	(%)
HEAT SIMU. (AMP)	(%)
POS. ERROR	(pulse)
SYN ERR	(pulse)

TROUBLE DGN. MONITOR	
SPINDLE MONIT (BEFORE ALM. 1)	3/9
SPINDLE :	LATCHED
DC LINK VOLT.	
PS VOLTAGE RMS	(V)
PS VOLT. UNBALANCE	(%)
PS VOLTAGE THD	(%)
PS CURRENT	(A)
PS STATUS FLAG1	
PS STATUS FLAG2	
PS STATUS FLAG3	
PS STATUS FLAG4	
PS INPUT FREQ	(Hz)

TROUBLE DGN. MONITOR	
SPINDLE MONIT (BEFORE ALM. 1)	4/9
SPINDLE :	LATCHED
SP INS. INFO.	
SP INS. RESISTANCE	(MΩ)

TROUBLE DGN. MONITOR	
SPINDLE MONIT (BEFORE ALM. 1)	5/9
SPINDLE :	LATCHED
PS INT. TMP.	
PS HEAT SINK TMP.	(°C)
SP INT. TMP.	
SP HEAT SINK TMP.	(°C)
AMP GROUP/SLAVE	
PS DGN. INFO.	
AMP COMM. ERR. INF.	
SP DGN. INFO.	

TROUBLE DGN. MONITOR	
SPINDLE MONIT (BEFORE ALM. 1)	6/9
SPINDLE :	LATCHED
SP FSSB UPR. ERR.	
SP FSSB LWR. ERR.	
SP FSSB UPR. JTR.	
AMP FSSB LWR. JTR.	

TROUBLE DGN. MONITOR	
SPINDLE MONIT (BEFORE ALM. 1)	7/9
SPINDLE :	LATCHED
INT. A/B AMPLITUDE	
INT. A/B MAX FLUCT	(%)
INT. A/B OFFSET A	(mV)
INT. A/B OFFSET B	(mV)
INT. A/B NOISE CNT	
EXT. A/B AMPLITUDE	(V)
EXT. A/B MAX FLUCT	(%)
EXT. A/B OFFSET A	(mV)
EXT. A/B OFFSET B	(mV)
EXT. A/B NOISE CNT	

TROUBLE DGN. MONITOR	
SPINDLE MONIT (BEFORE ALM. 1)	8/9
SPINDLE :	LATCHED
INT. SRAL INTP. CNT	
INT. SRAL COM. CNT	
INT. SRAL WRN.	
EXT. SRAL INTP. CNT	
EXT. SRAL COM. CNT	
EXT. SRAL WRN.	
SP DATA1	
SP DATA2	
SP DATA3	
SP DATA4	

TROUBLE DGN. MONITOR	
SPINDLE MONIT (BEFORE ALM. 1)	9/9
SPINDLE :	LATCHED
LAST LATCH DATE	
LAST LATCH TIME	04/06/08
EXECUTED FILE NAME	
EXECUTED N-NUM.	0100
	1

				TITLE	αi series SERVO AMPLIFIER for 30i-B Start-up and Maintenance manual		
				NO.	B-65285EN/03-02/01		
EDT.	DATE	DESIG.	DESCRIPTION	FANUC CORPORATION	PAGE	47 / 76	

Data (unit)	Data explanation	Display page No.
Operation mode		1/9
Gear select command		1/9
Command pulse (pulse)		1/9
Command speed (1/min)	(Note2)	1/9
Input signals		1/9
Output signals		1/9
ACT.SPINDLE SPEED (1/min)		2/9
ACT.MOTOR SPEED (1/min)	(Note2)	2/9
LOAD METER (%)		2/9
TORQUE COMMAND (%)	Maximum torque=100%	2/9
MOTOR CURRENT (A)		2/9
HEAT SIMU.(MOTOR) (%)	OVC alarm level=100%	2/9
HEAT SIMU.(AMP) (%)	OVC alarm level=100%	2/9
POS. ERROR (pulse)		2/9
Synchronization error (pulse)		2/9
DC LINK VOLT. (V)	Instantaneous value (Note 3)	3/9
PS VOLTAGE RMS (Vrms)	Average of 1cycle of input power supply (Note 3)	3/9
PS VOLT.UMBALANCE (%)	Average of 1cycle of input power supply (Note 3)	3/9
PS VOLTAGE THD (%)	Average of 1cycle of THD(Total Harmonic Distortion) (Note 3)	3/9
PS CURRENT (A)	Average of current amplitude of the 1 cycle of input power supply (Note 3)	3/9
PS STATUS FLAG 1	(Note 5)	3/9
PS STATUS FLAG 2	(Note 5)	3/9
PS STATUS FLAG 3	(Note 5)	3/9
PS STATUS FLAG 4	(Note 5)	3/9
PS INPUT FREQ (Hz)	Average of 1cycle of input power supply(3/9
SP INS.INFO.	State flage of INSULATION DETERIORATION DETECTION FUNCTION	4/9
SP INS.RESISTANCE (MΩ)	Insulation resistance (Note 3)	4/9
PS INT.TMP. (°C)	(Note 3)	5/9
PS HEAT SINK TMP. (°C)	(Note 3)	5/9
SP INT.TMP. (°C)	(Note 3)	5/9
SP HEAT SINK TMP. (°C)	(Note 3)	5/9
AMP GROUP/SLAVE	Gruppe No. and Slave No.	5/9

				TITLE	αi series SERVO AMPLIFIER for 30i-B Start-up and Maintenance manual		
				NO.	B-65285EN/03-02/01		
EDT.	DATE	DESIG.	DESCRIPTION	FANUC CORPORATION		PAGE	48 / 76

PS DGN.INFO.	State flage of PS	5/9
AMP COMM.ERR.INF.	Error state flage of communication between amplifier	5/9
SP DGN.INFO.	State flage of SP	5/9
SP FSSB UPR.ERR.	(Note 6)	6/9
SP FSSB LWR.ERR.	(Note 6)	6/9
SP FSSB UPR.JTR.	(Note 6)	6/9
SP FSSB LWR.JTR.	(Note 6)	6/9
INT.A/B AMPLITUDE (V)	Amplitude of built-in analog sensor	7/9
INT.A/B MAX FLUCT (%)	Max. fluctuation of built-in analog sensor	7/9
INT.A/B OFFSET A (mV)	A phase offset of built-in analog sensor	7/9
INT.A/B OFFSET B (mV)	B phase offset of built-in analog sensor	7/9
INT.A/B NOISE CNT	The number of times by which the data of a built-in sensor was disturbed in the noise (The number of times which detected the abnormalities in data)	7/9
EXT.A/B AMPLITUDE (V)	Amplitude of separated analog sensor	7/9
EXT.A/B MAX FLUCT (%)	Max. fluctuation of separated analog sensor	7/9
EXT.A/B OFFSET A (mV)	A phase offset of separated analog sensor	7/9
EXT.A/B OFFSET B (mV)	B phase offset of separated analog sensor	7/9
EXT.A/B NOISE CNT	The number of times by which the data of a separated analog sensor is disturbed in the noise (The number of times which detected the abnormalities in data)	7/9
INT.SRAL INTP.CNT	The number of times by which the data of a built-in serial sensor is disturbed in the noise (The number of times which detected the abnormalities in data)	8/9
INT.SRAL COM.CNT	The number of times which detected the abnormalities in data of a built-in serial sensor (The number of times which detected the communication error)	8/9
INT.SRAL WRN.	Warning information of built-in serial sensor	8/9
EXT.SRAL INTP.CNT	The number of times by which the data of a separated serial sensor is disturbed in the noise (The number of times which detected the abnormalities in data)	8/9
EXT.SRAL COM.CNT	The number of times which detected the abnormalities in data of a separated serial sensor (The number of times which detected the communication error)	8/9

				TITLE	<i>αi</i> series SERVO AMPLIFIER for 30<i>i</i>-B Start-up and Maintenance manual		
				NO.	B-65285EN/03-02/01		
EDT.	DATE	DESIG.	DESCRIPTION	FANUC CORPORATION		PAGE	49 / 76

EXT.SRAL WRN.	Warning information of separated serial sensor	8/9
SP DATA 1	(Note 4)	8/9
SP DATA 2	(Note 4)	8/9
SP DATA 3	(Note 4)	8/9
SP DATA 4	(Note 4)	8/9
LAST LATCH DATE		9/9
LAST LATCH TIME		9/9
EXECUTED FILE NAME		9/9
EXECUTED N-NUM		9/9

Note

- 1 The range of displays listed above is only the one that can be displayed with the monitor function. It includes neither a system performance nor a rated value.
- 2 The parameter of maximum speed of motor should be set in order to display the speed command and actual speed.
 - No.4020 : Maximum speed of main spindle motor
 - No.4196 : Maximum speed of sub spindle motor motor (when the spindle switching control function is used)
- 3 The displayed voltage, current, frequency, resistance, and temperature values are approximate values with some error included. If accurate data is needed, measure them using dedicated measuring instruments.
- 4 SP data items 1 to 4 are intended for use by FANUC for maintenance purposes.
- 5 PS status flags 1 to 4 are intended for use by FANUC for maintenance purposes.
- 6 FSSB errors and jitter data indicate the status of FSSB communication. They are intended for use by FANUC for maintenance purposes.

				TITLE	α i series SERVO AMPLIFIER for 30i-B Start-up and Maintenance manual		
				NO.	B-65285EN/03-02/01		
EDT.	DATE	DESIG.	DESCRIPTION	FANUC CORPORATION		PAGE	50 / 76

2.2.3 How to set the Failure Diagnosis Guidance and Failure Diagnosis Monitor in the “SAMPLING” status

The failure diagnosis monitor has two statuses, “SAMPLING” and “LATCHED”.

The monitor is initially in the “SAMPLING” status. When an alarm occurs, it shifts to the “LATCHED” status. When the monitor is in the “LATCHED” status, performing the “CLEAR” operation erases the data saved at alarm occurrence and places it back to the “SAMPLING” status.

For this reason, observe the following:

- If it is necessary to monitor data at future alarm occurrence, perform the “CLEAR” operation.
- If it is necessary to save the statuses at past alarm occurrence, do not perform the “CLEAR” operation

Shown below is how to place the monitor back in the “SAMPLING” status by performing the “CLEAR” operation.

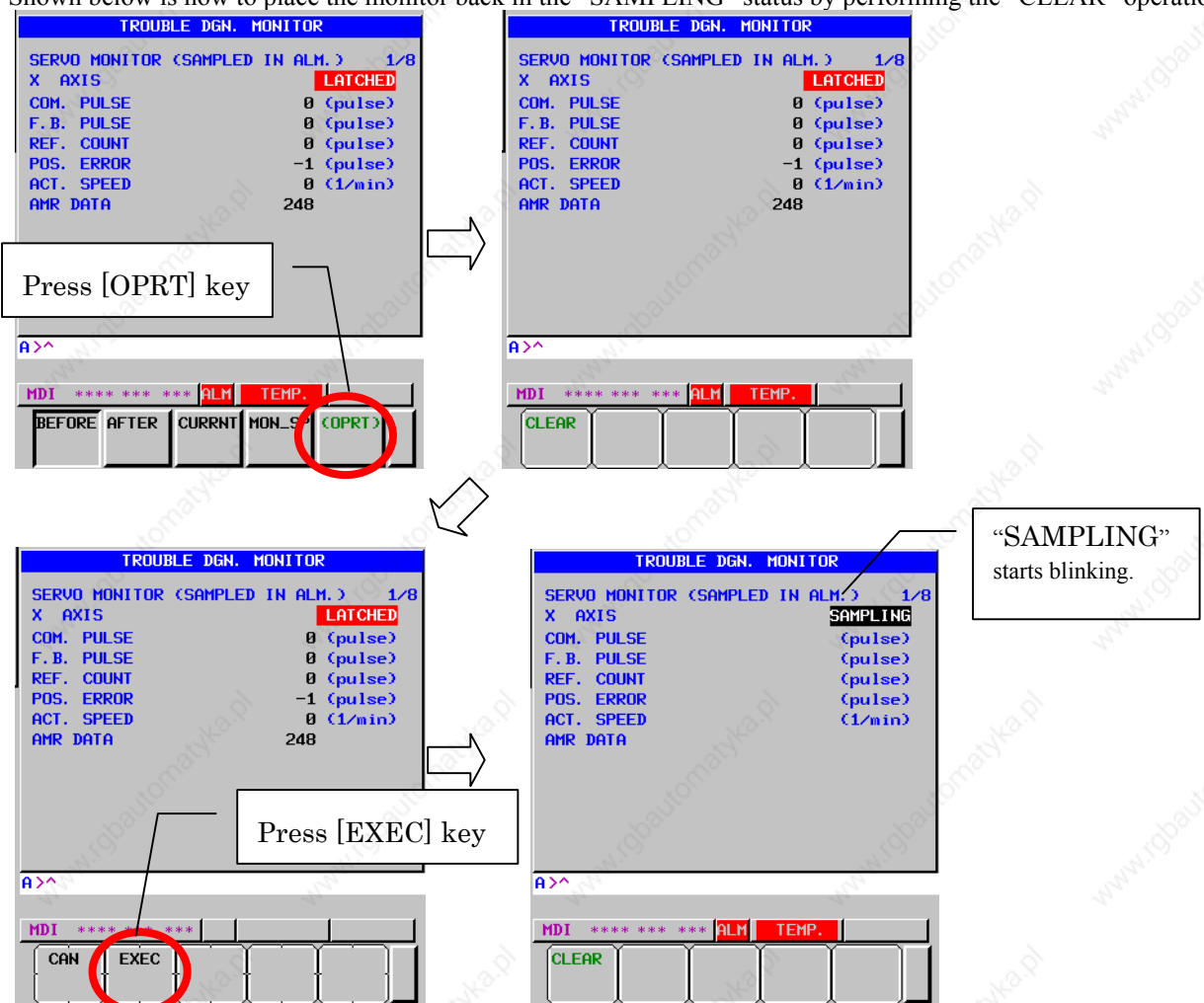

				TITLE	αi series SERVO AMPLIFIER for 30i-B Start-up and Maintenance manual		
				NO.	B-65285EN/03-02/01		
EDT.	DATE	DESIG.	DESCRIPTION	FANUC CORPORATION	PAGE	51 / 76	

2.3. Alarm number
2.3.1 Servo alarm

Alarm No	LED		Description
	SV	PS	
SV0001			Sync alignment error
SV0002			Sync excess error alarm 2
SV0003			Synchronous/composite/super imposed control mode can't be continued
SV0004			Excess error (G31)
SV0005			Sync excess error (MCN)
SV0006			Illegal tandem axis
SV0007			SV alarm another path (Multi AMP.)
SV0010			SV overheat
SV0011			SV motor over current(SOFT)
SV0012	4		SV drive off circuit failure
SV0013	3		SV cpu bus failure
SV0014	J		SV cpu watch dog
SV0015	2		SV low volt driver
	(Blink)		
SV0016	b.		SV current detect error
	C.		
	d.		
SV0017	11		SV internal serial bus failure
SV0018	11		SV rom data failure
	(Blink)		
SV0019	b		SV motor current abnormal (Ground fault)
	C		
	d		
	(Blink)		
SV0020		9	PS ground fault
SV0024		15	PS soft thermal
SV0034		24	PS hardware error
SV0035	—		NO failure
SV0036	A		Phase open
	(Blink)		
SV0037	9		Failure of SV (OPEN)
SV0038	—		Failure of current CTL.
SV0039	8		Failure of SV (SHORT)
	(Blink)		

				TITLE	αi series SERVO AMPLIFIER for 30i-B Start-up and Maintenance manual		
				NO.	B-65285EN/03-02/01		
EDT.	DATE	DESIG.	DESCRIPTION	FANUC CORPORATION		PAGE	52 / 76

Alarm No	LED		Description
	SV	PS	
SV0301			APC alarm: communication error
SV0302			APC alarm: over time error
SV0303			AAPC alarm: framing error
SV0304			APC alarm: parity error
SV0305			APC alarm: pulse error
SV0306			APC alarm: over flow error
SV0307			APC alarm: movement excess error
SV0360			Abnormal checksum(INT)
SV0361			Abnormal phase data(INT)
SV0363			Abnormal clock(INT)
SV0364			Soft phase alarm(INT)
SV0365			Broken LED(INT)
SV0366			Pulse miss(INT)
SV0367			Count miss(INT)
SV0368			Serial data error(INT)
SV0369			Data trans. error(INT)
SV0380			Broken LED(EXT)
SV0381			Abnormal phase (EXT)
SV0382			Count miss(EXT)
SV0383			Pulse miss(EXT)
SV0384			Soft phase alarm(EXT)
SV0385			Serial Data error(EXT)
SV0386			Data trans. error(EXT)
SV0387			Abnormal encoder(EXT)
SV0401			Improper v_ready off
SV0403			Card/soft mismatch
SV0404			Improper v_ready on
SV0407			Excess error
SV0409			Detect abnormal Torque
SV0410			Excess error (STOP)
SV0411			Excess error (MOVING)
SV0413			LSI overflow
SV0415			Motion value overflow
SV0417			Ill dgtl servo parameter
SV0420			Sync Torque excess
SV0421			Excess error(Semi-full)
SV0422			Excess velocity in torque
SV0423			Excess error in torque
SV0430			SV motor overheat

				TITLE	αi series SERVO AMPLIFIER for 30i-B Start-up and Maintenance manual		
				NO.	B-65285EN/03-02/01		
EDT.	DATE	DESIG.	DESCRIPTION	FANUC CORPORATION	PAGE	53 / 76	

Alarm No	LED		Description
	SV	PS	
SV0431		3	PS overload
SV0432		6	PS low volt. control
SV0433		4	PS low volt. DC link
SV0434	2		SV low volt control
SV0435	5		SV low volt DC link
SV0436			Softthermal(OVC)
SV0437		1	PS Overcurrent
SV0438	b		SV abnormal current
	C		
	d		
SV0439		7	PS over volt. DC link
SV0441			Abnormal current offset
SV0442		5	PS pre-charge failure
SV0443		2	PS internal fan failure
SV0444	1		SV internal fan failure
SV0445			Soft disconnect alarm
SV0446			Hard disconnect alarm
SV0447			Hard disconnect(EXT)
SV0448			Unmatched feedback alarm
SV0449	8.		SV IPM alarm
	9.		
	A.		
SV0453			SPC soft disconnect alarm
SV0454			Illegal rotor pos detect
SV0456			Illegal current loop
SV0458			Current loop error
SV0459			Hi HRV setting error
SV0460			FSSB disconnect
SV0462			Send CNC data failed
SV0463			Send slave data failed
SV0465			Read ID data failed
SV0466			Motor/Amp. Combination
SV0468			Hi HRV setting error(AMP)
SV0474			Excess error(STOP:SV)
SV0475			Excess error(MOVE:SV)
SV0476			Illegal Speed cmd.(SV)
SV0477			Illegal machine pos.(SV)
SV0478			Illegal axis data(SV)

				TITLE	αi series SERVO AMPLIFIER for 30i-B Start-up and Maintenance manual		
				NO.	B-65285EN/03-02/01		
EDT.	DATE	DESIG.	DESCRIPTION	FANUC CORPORATION		PAGE	54 / 76

Alarm No	LED		Description
	SV	PS	
SV0481			Safety param error(SV)
SV0484			Safety function error(SV)
SV0488			Self test over time
SV0489			Safety param error(CNC)
SV0490			Safety function error(CNC)
SV0494			Illegal speed cmd.(CNC)
SV0496			Illegal axis data(CNC)
SV0498			Axis number not set(CNC)
SV0600	8		SV DC link over current
SV0601	F		SV external fan failure
SV0602	6		SV overheat
SV0603	8.		SV IPM alarm(OH)
	9.		
	A.		
SV0604	P		AMP communication error
SV0606		10	PS external fan failure
SV0607		14	PS improper Input power
SV0646			Abnormal analog signal(EXT)
SV0652			Temp.error
SV0654	7		DB Relay failure
SV1025			V_ready on (Initializing)
SV1026			Illegal axis arrange
SV1055			Illegal tandem axis
SV1067			FSSB:configuration error(SOFT)
SV1068			Dual check safety alarm
SV1069			Excess error(Servo off:CNC)
SV1070			Excess error(Servo off:SV)
SV1071			Excess error(Move:CNC)
SV1072			Excess error(Stop:CNC)
SV1100			S-comp. value overflow
SV5134			FSSB:Open ready time out
SV5136			FSSB:Number of AMP. is insufficient
SV5137			FSSB:Configuration error
SV5139			FSSB>Error
SV5197			FSSB:Open time out
SV5311			FSSB:Illegal connection

				TITLE	αi series SERVO AMPLIFIER for 30i-B Start-up and Maintenance manual		
				NO.	B-65285EN/03-02/01		
EDT.	DATE	DESIG.	DESCRIPTION	FANUC CORPORATION		PAGE	55 / 76

2.3.2

Spindle Alarm

Alarm No	LED		Description
	SP	PS	
SP9001	01		Motor overheat
SP9002	02		Excessive speed deviation
SP9003	03		DC link fuse blown
SP9004		14	Open phase in the converter main power supply
SP9006	06		Temperature sensor disconnected
SP9007	07		Excessive speed
SP9009	09		Main circuit overload/IPM overheat
SP9010	10		Low voltage input power
SP9011		07	Converter: DC link overvoltage
SP9012	12		DC link overcurrent/IPM alarm
	13		CPU Data memory fault
SP9014	14		No ID number
SP9015	15		Output switching/spindle switching alarm
SP9016	16		RAM Error
SP9017	17		ID number parity error
	18		Program sum check error
SP9019	19		Excessive offset of the phase U current detection circuit
SP9020	20		Excessive offset of the phase V current detection circuit
SP9021	21		Position sensor polarity setting incorrect
SP9022	22		Spindle Amplifier overload current
	24		Serial transfer data error
SP9027	27		Position coder disconnected
SP9029	29		Short-period overload
SP9030		01	Overcurrent in the converter input circuit
SP9031	31		Motor lock alarm
SP9032	32		Serial communication LSI RAM error
SP9033		05	Converter: DC link precharge failure
SP9034	34		Parameter data out of the specifiable range
SP9036	36		Error counter overflow
SP9037	37		Speed detector parameter error
SP9041	41		Position coder one-rotation signal detection error
SP9042	42		Position coder one-rotation signal not detected
SP9043	43		Disconnect position coder signal for differential speed
SP9046	46		Position sensor one-rotation signal detection error during thread cutting
SP9047	47		Position coder signal error

				TITLE	αi series SERVO AMPLIFIER for 30i-B Start-up and Maintenance manual		
				NO.	B-65285EN/03-02/01		
EDT.	DATE	DESIG.	DESCRIPTION	FANUC CORPORATION		PAGE	56 / 76

Alarm No	LED		Description
	SP	PS	
SP9049	49		Differential speed is over value
SP9050	50		Excessive speed command calculation value during spindle synchronization
SP9051		04	Converter: DC link undervoltage
SP9052	52		ITP signal error I
SP9053	53		ITP signal error II
SP9054	54		Current overload alarm
SP9055	55		Abnormal switching status of power leads
SP9056	56		Internal cooling fan stopped
SP9058		03	Converter: main circuit overload
SP9059		02	Converter: cooling fan stopped
SP9061	61		Excess of error between semi-closed and full-closed
SP9065	65		Move distance is too long when Magnetic pole confirmed
SP9066	66		Communication alarm between spindle amplifiers
SP9067	67		FSC/EGB command error
SP9069	69		Safety speed exceeded
SP9070	70		Abnormal axis data
SP9071	71		Abnormal safety parameter
SP9072	72		Motor speed mismatch
SP9073	73		Motor sensor disconnected
SP9074	74		CPU test alarm
SP9075	75		CRC test alarm
SP9076	76		Safety function not executed
SP9077	77		Axis number mismatch
SP9078	78		Safety parameter mismatch
SP9079	79		Abnormal initial test operation
SP9080	80		Alarm at the other spindle amplifier
SP9081	81		Motor sensor one-rotation signal detection error
SP9082	82		Motor sensor one-rotation signal not detected
SP9083	83		Motor sensor signal error
SP9084	84		Spindle sensor disconnected
SP9085	85		Spindle sensor one-rotation signal detection error
SP9086	86		Spindle sensor one-rotation signal not detected
SP9087	87		Spindle sensor signal error
SP9088	88		Cooling fan stopped of the radiator
SP9089	89		Sub module SM error
SP9090	90		Unexpected rotation
SP9091	91		Pole position count miss

				TITLE	αi series SERVO AMPLIFIER for 30i-B Start-up and Maintenance manual		
				NO.	B-65285EN/03-02/01		
EDT.	DATE	DESIG.	DESCRIPTION	FANUC CORPORATION		PAGE	57 / 76

Alarm No	LED		Description
	SP	PS	
SP9092	92		Over speed to velocity command
	A		Program ROM error
	A1		Program ROM error
	A2		Program ROM error
SP9110	b0		Communication error between amplifiers
SP9111		06	Converter: control power supply low voltage
SP9113		10	PS external fan failure
SP9114	b4		PS control axis error 1
SP9115	b5		PS control axis error 2
SP9120	C0		Communication data alarm
SP9121	C1		Communication data alarm
SP9122	C2		Communication data alarm
SP9123	C3		Spindle switching circuit error
SP9124	C4		Learning control rotation command error
SP9125	C5		Learning control compensation order error
SP9127	C7		Learning control period error
SP9128	C8		Spindle synchronous control velocity error excess
SP9129	C9		Spindle synchronous control position error excess
SP9130	d0		Torque tandem polarity error
SP9131	d1		Spindle tuning function alarm
SP9132	d2		Serial sensor data error
SP9133	d3		Serial sensor transfer error
SP9134	d4		Serial sensor soft phase error
SP9137	d7		SP device communication error
SP9138	d8		Current limit setting error
SP9139	d9		Serial sensor pulse miss
SP9140	E0		Serial sensor count miss
SP9141	E1		Serial sensor no 1 rotation signal
SP9142	E2		Serial sensor abnormal
SP9143	E3		Cs high speed change command error
SP9144	E4		Current detect circuit error
SP9145	E5		Low voltage for driver circuit
SP9147	E7		Spindle ground fault
SP9148	E8		Axis number not set
SP9153	F3		SP not failure
SP9154	F4		Phase open
SP9155	F5		Failure of SP (OPEN)
SP9156	F6		Current control failure

				TITLE	αi series SERVO AMPLIFIER for 30i-B Start-up and Maintenance manual		
				NO.	B-65285EN/03-02/01		
EDT.	DATE	DESIG.	DESCRIPTION	FANUC CORPORATION		PAGE	58 / 76

Alarm No	LED		Description
	SP	PS	
SP9157	F7		Failure of SP (SHORT)
SP9160	G0		Spindle thermistor disconnect
SP9161	G1		Motor power line short-circuit
	UU		FSSB master port disconnect
	LL		FSSB slave port disconnect
SP0756			Axes data error
SP9200		9	Power supply ground fault
SP9204		15	PS soft thermal
SP9212		24	PS hardware error

				TITLE	α i series SERVO AMPLIFIER for 30i-B Start-up and Maintenance manual		
				NO.	B-65285EN/03-02/01		
EDT.	DATE	DESIG.	DESCRIPTION	FANUC CORPORATION		PAGE	59 / 76

3. PERIODIC MAINTENANCE OF SERVO AMPLIFIER

3.1. PERIODIC MAINTENANCE ITEM

To use the servo amplifier for a long time and keep its high performance and reliability, you should perform maintenance and inspection on it routinely.

⚠ Note

- The methods of maintenance differ for the machine. Moreover, a scheduled inspection and fixed cleaning according to a user depending on a machine may be difficult. Please prepare the procedure which can perform a periodic maintenance and cleaning certainly after asking a machine maker about an unknown point.
- Please use a machine within the limits of the specification specified by a machine maker. When how to use besides specification is adopted, there is a possibility of shortening the life of servo amplifier or becoming the cause of an obstacle

Inspection target	Inspection item	Inspection cycle		Criterion
		Routine	Periodic	
Environment	Ambient temperature	○		Surroundings of the power magnetics cabinet: 0 to 45° C Inside of power magnetics cabinet: 0 to 55° C
	Humidity	○		90%RH or lower (no condensation allowed)
	Dust and Oil mist	○		No dust or oil mist shall be on and around the servo amplifier.
	Cooling air path	○		Whether the cooling air path is free from an obstacle. Whether the cooling fan motor is working.
	Abnormal vibration and noise	○		(1) There shall be no abnormal sound or vibration that has not be experienced so far. (2) Any vibration on and around the amplifier shall not be over 0.5 G.
	Power supply voltage	○		200V input model: 200 to 240 V. 400V input model: 400 to 240 V.
Amplifier	General	○		Whether there is dust or oil mist on the amplifier. Whether the amplifier generates abnormal sound or odor.
	Screw		○	There shall be no loose screw
	Fan motor <small>(note 1) (note 2)</small>	○		(1) The motor shall not generate abnormal vibration or sound. (2) There shall be no dust or oil mist on the motor.
	Connector		○	Whether there is a loose connector.
	Cable		○	1) Whether there is a sign of past heat generation. 2) Whether there is a deteriorated sheath (discolored or cracked).

				TITLE	αi series SERVO AMPLIFIER for 30i-B Start-up and Maintenance manual		
				NO.	B-65285EN/03-02/01		
EDT.	DATE	DESIG.	DESCRIPTION	FANUC CORPORATION		PAGE	60 / 76

C N C	Battery for absolute pulseorder (note 2)	○		The battery low alarm of an absolute pulse coder is not displayed on a mechanical control board or a screen.
External device	Magnetic contactor		○	The magnetic contactor shall not rattle or chatter.
	Ground fault interrupter		○	The interrupter shall be able to trip.
	AC reactor		○	There shall be no hum.

(note 1) Generally, fan motors are periodic-replacement parts.

If a fan motor for a servo amplifier does not work, the amplifier will not get broken immediately. However, you should inspect the fan motor constantly and replace it in a preventive manner.

(note 2) Since the fan motor and battery are periodic maintenance parts, Fanuc recommend preparation of spare parts.

				TITLE	αi series SERVO AMPLIFIER for 30 <i>i</i> -B Start-up and Maintenance manual		
				NO.	B-65285EN/03-02/01		
EDT.	DATE	DESIG.	DESCRIPTION	FANUC CORPORATION		PAGE	61 / 76

3.2. INSULATION DETERIORATION DETECTION FUNCTION

The αi servo amplifier for the 30*i*-B series includes an insulation deterioration detection function, which can detect a sign of insulation deterioration in motor windings and power wires automatically and accurately. This function can use the voltage charged in the servo amplifier DC link to measure automatically the insulation resistance between the motor or power cable and a ground immediately after the servo amplifier has shifted from a servo-on state to an emergency stop state, thereby checking for insulation deterioration. If an insulation resistance of 10 M Ω or below is detected, a warning is issued.

3.2.1 How to Use

- (1) To use the insulation deterioration detection function, set the parameters listed below.

	Parameter No.	Enabling/disabling the function (axis by axis)
Servo amplifier	No2429#0	0: Disable for SV (default)/1: Enable for SV
Spindle amplifier	No4549#0	0: Disable for SP (default)/1: Enable for SP

- (2) Measuring the insulation resistance requires charging the DC link voltage. So, keep the amplifier released from an emergency stop for at least 5 seconds before measurement. This is unnecessary when the machine is working normally before measurement.
- (3) The measurement of insulation resistance start by inputting the emergency stop(*ESP) to connector CX4 of common power supply (PS) after the DC link voltage is charged.

3.2.2 How to Check

- (1) If insulation deterioration is detected, "LKG" in the lower section of the CNC screen blinks.
- (2) Measurement results can be viewed on the "LEAKAGE DETECTION MONITOR" screen of the CNC.

3.2.3 Action

If insulation deterioration is detected, measure the insulation resistance of motor and power cables separately with a megohmmeter to see which has a deteriorated insulation, the motor or power cable. Then, replace the motor or power cable whichever is relevant.

				TITLE	αi series SERVO AMPLIFIER for 30 <i>i</i> -B Start-up and Maintenance manual		
				NO.	B-65285EN/03-02/01		
EDT.	DATE	DESIG.	DESCRIPTION	FANUC CORPORATION		PAGE	62 / 76

3.2.4

Other Notes

- (1) No insulation resistance is measured in the following cases:
 - The servo amplifier enters an emergency stop state again before entering a ready state.
 - The servo amplifier is released from an emergency stop state during insulation deterioration checks.
- (2) Continuing a long-term operation with insulation deteriorated may cause the machine to stop because of the ground fault interrupter tripping or an alarm occurring. If insulation deterioration is detected, replace the relevant motor or power cable as soon as possible.
- (3) No accurate measurement can be made while the motor is running. So, no measurement will be made even in an emergency stop state, for example, if the spindle motor is rotating through inertia.

⚠ WARNING

Insulation resistance measurement starts when the emergency stop signal (*ESP) applied to the connector CX4 of the common power supply (PS) represents an emergency stop state. During insulation resistance measurement, the voltage charged in the DC link is applied to the motor. Do not touch the motor during measurement to avoid getting electrical shocks. Insulation resistance measurement begins 6 seconds after the emergency stop state has been entered.

				TITLE	αi series SERVO AMPLIFIER for 30 <i>i</i> -B Start-up and Maintenance manual		
				NO.	B-65285EN/03-02/01		
EDT.	DATE	DESIG.	DESCRIPTION	FANUC CORPORATION		PAGE	63 / 76

3.3. How to replace the battery for the absolute Pulsecorder

3.3.1 Outline

- When the voltage of the batteries for absolute Pulsecoders becomes low, alarm 307 or 306 occurs, with the following indication in the CNC state display at the bottom of the CNC screen.

Alarm 307 (alarm indicating the voltage of the battery becomes low) :
The indication "APC" blinks in reversed display.

Alarm 306 (battery zero alarm) :
The indication "ALM" blinks in reversed display.
- When alarm 307 (alarm indicating the voltage of the battery becomes low) occurs, replace the battery as soon as possible. In general, the battery should be replaced within one or two weeks, however, this depends on the number of Pulsecoders used.
- When alarm 306 (battery zero alarm) occurs, Pulsecoders are reset to the initial state, in which absolute positions are not held. Alarm 300 (reference position return request alarm) also occurs, indicating that reference position return is required.
- In general, replace the batteries periodically within the service life listed below.
 - A06B-6050-K061 or D-size alkaline dry cells (LR20) : Two years (for each six-axis configuration)
 - A06B-6073-K001 : Two years (for each three-axis configuration)
 - A06B-6114-K504 : One year (for each three-axis configuration)

NOTE

The above values indicate the estimated service life of batteries used with FANUC absolute Pulsecoders. The actual battery service life depends on the machine configuration based on, for example, detector types. For details, contact the machine tool builder.

3.3.2 Replacing procedure of the battery

To prevent absolute position information in absolute Pulsecoders from being lost, turn on the machine power before replacing the battery. The replacement procedure is described below.

- <1> Ensure that the power to the servo amplifier is turned on.
- <2> Ensure that the machine is in the emergency stop state (the motor is inactive).
- <3> Ensure that the DC link charge LED of the servo amplifier is off.
- <4> Detach the old batteries and attach new ones.

				TITLE	αi series SERVO AMPLIFIER for 30i-B Start-up and Maintenance manual		
				NO.	B-65285EN/03-02/01		
EDT.	DATE	DESIG.	DESCRIPTION	FANUC CORPORATION		PAGE	64 / 76

⚠ WARNING

- The absolute Pulsecoder of each of the $\alpha iF, \alpha iS$ series servo motors and the βiS series servo motors ($\beta iS0.4$ to $\beta iS22$) has a built-in backup capacitor. Therefore, even when the power to the servo amplifier is off and the batteries are replaced, reference position return is not required if the replacement completes within less than 10 minutes. Turn the power on and replace the batteries if the replacement will take 10 minutes or more.
- To prevent electric shock, be careful not to touch metal parts in the power magnetics cabinet when replacing the batteries.
- Because the servo amplifier uses a large-capacitance electrolytic capacitor internally, the servo amplifier remains charged for a while even after the power is turned off. Before touching the servo amplifier for maintenance or other purposes, ensure your safety by measuring the residual voltage in the DC link with a tester and confirming that the charge indication LED (red) is off.
- Be sure to replace the batteries with specified ones. Pay attention to the battery polarity. If a wrong type of battery is used or a battery is installed with incorrect polarity, the battery may overheat, blow out, or catch fire, or the absolute position information in the absolute Pulsecoders may be lost.
- Ensure that the battery connector is inserted in the correct position.

3.3.3 How to insert batteries into the battery case

Use the following procedure to replace the batteries in the battery case.

- <1> Loosen the screws on the battery case and detach the cover.
- <2> Replace the batteries in the case (pay attention to the polarity).
- <3> Attach the cover to the battery case.

Battery case
A06B-6050-K060

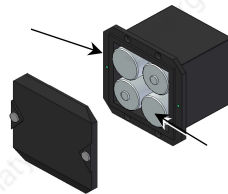

Battery A06B-6050-K061
or four D-size alkaline dry cells

⚠ CAUTION

- Four D-size alkaline dry cells (LR20) that are commercially available can be used as batteries. A set of four A06B-6050-K061 batteries is optionally available from FANUC.
- Replace all the four batteries with new ones. If old and new batteries are mixed, the absolute position information in the absolute Pulsecoders may be lost.

3.3.4 How to replace the built-in lithium battery

Use the following procedure to replace the lithium battery.

- <1> Remove the battery cover.
- <2> Install the lithium battery.
- <3> Install the battery cover.

				TITLE	αi series SERVO AMPLIFIER for 30i-B Start-up and Maintenance manual		
				NO.	B-65285EN/03-02/01		
EDT.	DATE	DESIG.	DESCRIPTION	FANUC CORPORATION		PAGE	65 / 76

CAUTION

- Since a battery is not a commercial item, please be sure to purchase it from Fanuc. Therefore, Fanuc recommend preparation of the spare battery.
- When using the built-in batteries, do not connect them to the BATL (B3) of connector CXA2A/CXA2B. The output voltages from different SV batteries may be short-circuited, resulting in the batteries becoming very hot.
- If it is attached where a battery cable is stretched, loose connection etc. may occur.
- When +6V of CX 5X and 0V short-circuit, it becomes the cause of generation of heat of the battery, a burst, ignition, and the absolute position information disappearance in an absolute pulse coder.
- In case you insert a connector, please insert horizontally to the direction of the pin of the connector.

[Connection method of battery]

The battery is installed in the front of servo amplifier

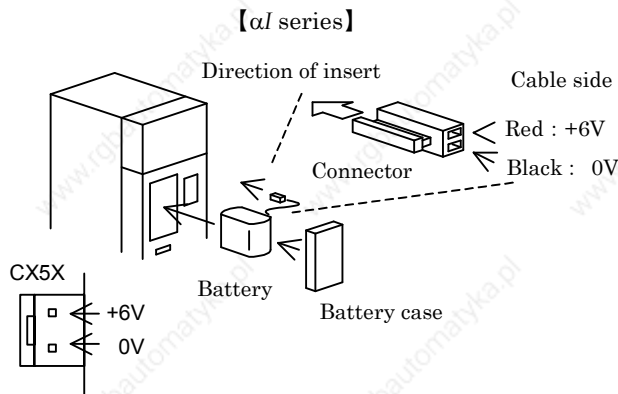

[Combination and outline of the battery]

Battery Specification No.	Type	Servo amplifier	Battery case Specification No.	Outline
A06B-6114-K504 (note)	BR-2/3AGCT4 A (Panasonic)	αi series 60/90mm width	A06B-6114-K505	
		αi series 150/300mm width	A06B-6114-K506	

(note) When old type battery BR-CCF2TH(A06B-6073-K001) is used, please order battery case A06B-6114-K500.

About a used battery

Please dispose correctly as "industrial waste" about the battery after exchange according to the law which the country in which the machine was installed.

				TITLE	αi series SERVO AMPLIFIER for 30i-B Start-up and Maintenance manual		
				NO.	B-65285EN/03-02/01		
EDT.	DATE	DESIG.	DESCRIPTION	FANUC CORPORATION		PAGE	66 / 76

4. MAINTENANCE PARTS AND REPLACEMENT METHODS

4.1. HOW TO REPLACE FAN MOTORS

4.1.1 How to Detach Fan Units from 60 and 90 mm Width Units

- (1) Holding the two lugs on the fan unit, lift the internal cooling fan unit upward. (Removal of internal cooling fan unit is completed.)
- (2) The lock of DC link terminal cover is released, and DC link terminal cover is opened. And discharge of DC link (LED has gone out) is checked, and DC link short bar is removed.
- (3) From the hole beside DC link terminal, the screw driver is inserted and the lower screw (one place) of the radiator cooling fan unit is loosened.
- (4) The upper screw (60mm wide is one place and 90mm wide is two places) of the radiator cooling fan unit is loosened.
- (5) The radiator cooling fan unit is pulled out to the front. (Removal of radiator cooling fan unit is completed.)
- (6) When it mounts, the fan unit is mounted in the reverse procedure.

Note) The connector may be hard to fit in at the time of mounting of the internal fan unit. In that case, please mount, pushing the lug by the side of the back of the internal fan unit to the left.

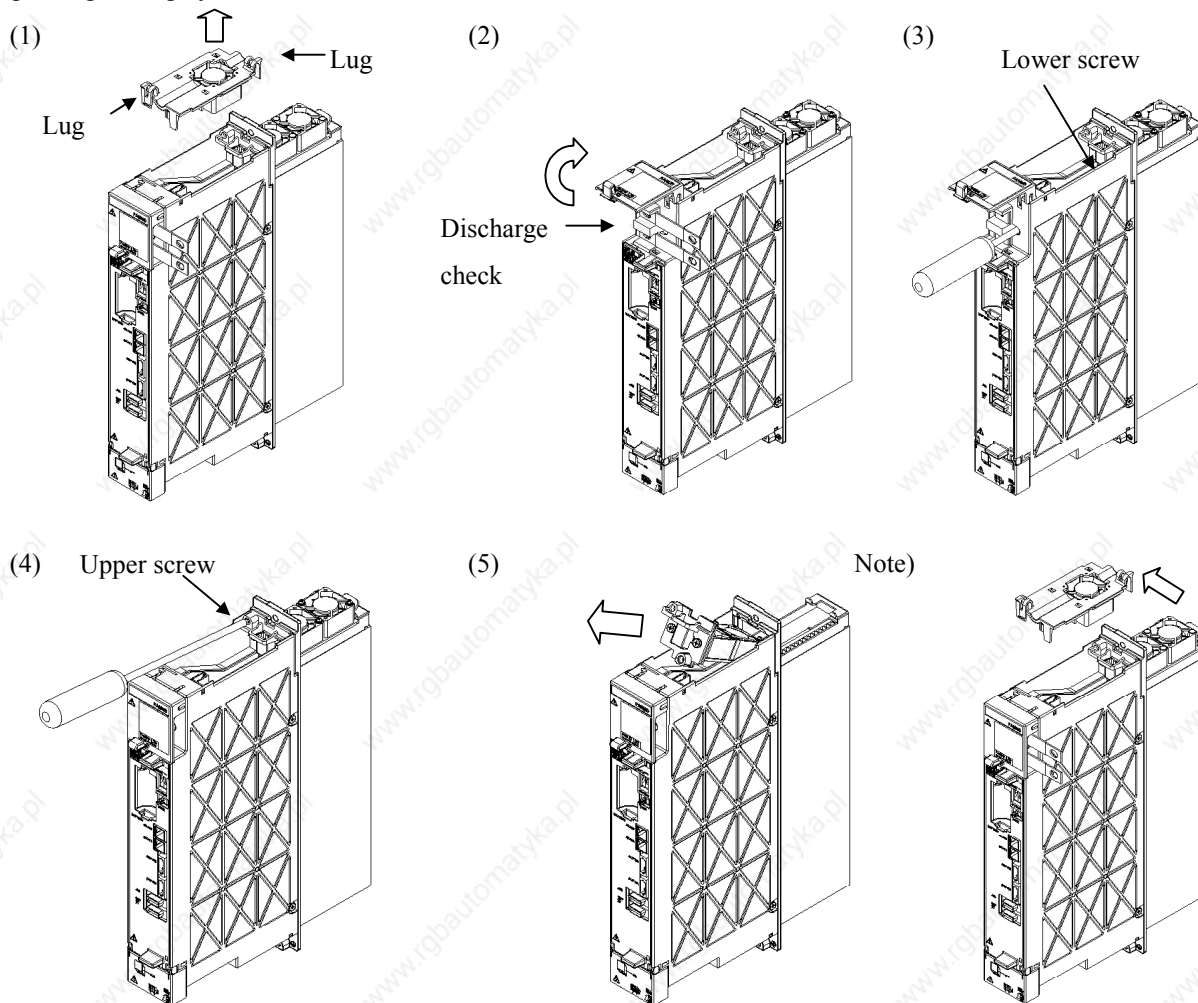

				TITLE	αi series SERVO AMPLIFIER for 30i-B Start-up and Maintenance manual		
				NO.	B-65285EN/03-02/01		
EDT.	DATE	DESIG.	DESCRIPTION	FANUC CORPORATION	PAGE	67 / 76	

4.1.2 How to Detach Fan Units from 150 and 300 mm Width Units

- (1) Holding the two lugs on the fan unit, lift the internal cooling fan unit upward. (Removal of internal cooling fan unit is completed.)
- (2) The lock of DC link terminal cover is released, and DC link terminal cover is opened. And discharge (LED has gone out) of DC link is checked, and DC link short bar is removed.
- (3) From the hole beside DC link terminal, the screw driver is inserted and the lower screw (one place) of the radiator cooling fan unit is loosened.
- (4) The upper screw (one place) of the radiator cooling fan unit is loosened.
- (5) The radiator cooling fan unit is pulled out to the front. (Removal of radiator cooling fan unit is completed.)
- (6) When it mounts, the fan unit is mounted in the reverse procedure.

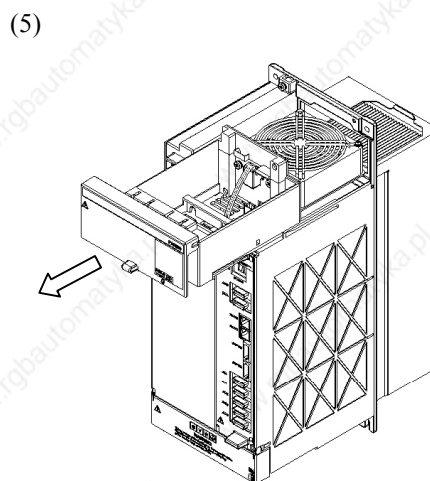
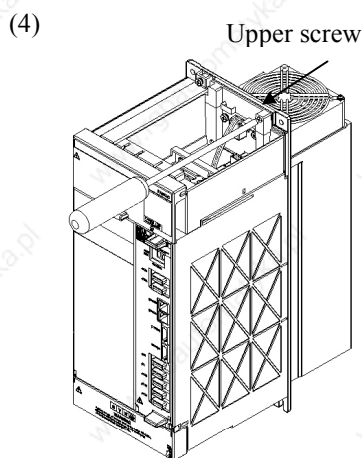
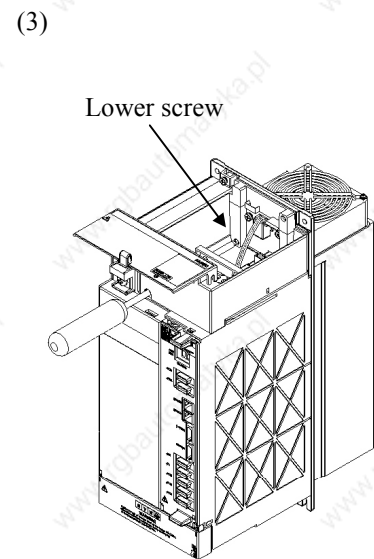
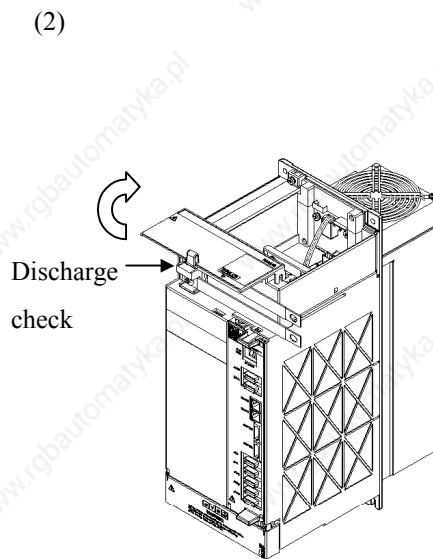
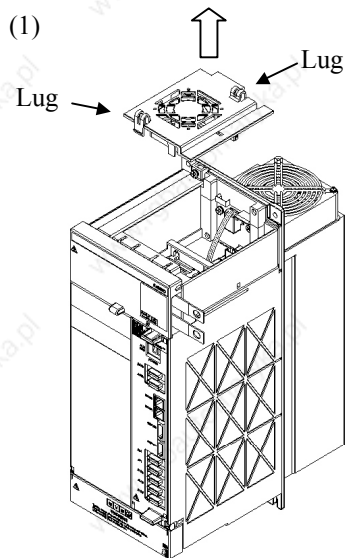

				TITLE	αi series SERVO AMPLIFIER for 30i-B Start-up and Maintenance manual		
				NO.	B-65285EN/03-02/01		
EDT.	DATE	DESIG.	DESCRIPTION	FANUC CORPORATION		PAGE	68 / 76

4.1.3 How to Detach the Fan Motor from the Internal Cooling Fan Unit

- (1) The connector (one place or two places) is removed from the case. (Refer to the following figure for details.)
- (2) The fan motor is removed from the case.

By twisting lightly in the direction of the arrow, resin on either side is bent and the central latch separates.

The connector separates from the case by drawing out to the up side, twisting the connector.

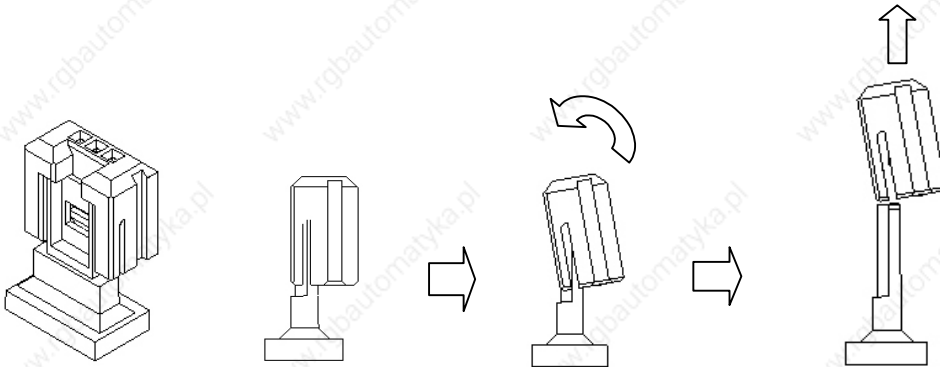

- The internal cooling fan unit for 60mm width model
(There are three kinds of fan units distinguished with connector composition.)

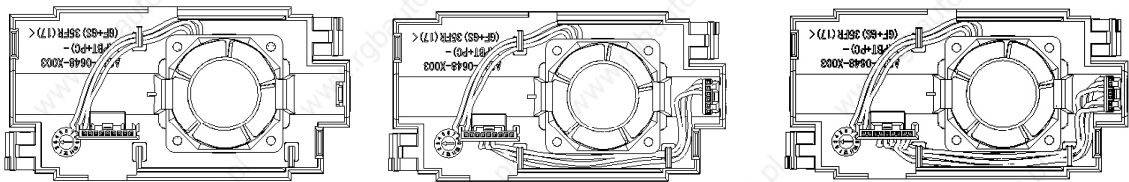

The internal cooling fan unit for 90mm width model The internal cooling fan unit for 150mm width model



Be careful of direction (when mounted in amplifier, the label turns to a top.) of a fan motor, and direction of a connector at the time of fan motor exchange.

				TITLE	αi series SERVO AMPLIFIER for 30i-B Start-up and Maintenance manual		
				NO.	B-65285EN/03-02/01		
EDT.	DATE	DESIG.	DESCRIPTION	FANUC CORPORATION		PAGE	69 / 76

4.1.4 How to Detach the Fan Motor from the Head Sink Cooling Fan Unit

- (1) In the case of the fan unit for 150mm width and 300mm width, the relay connector is removed from the connector of the fan motor. (There is no connector for relay in the fan unit for 60mm and 90mm wide.)
- (2) Two or four screws which are fixing the fan motor are removed.
- (3) Two screws which are fixing the connector of a fan motor are removed.

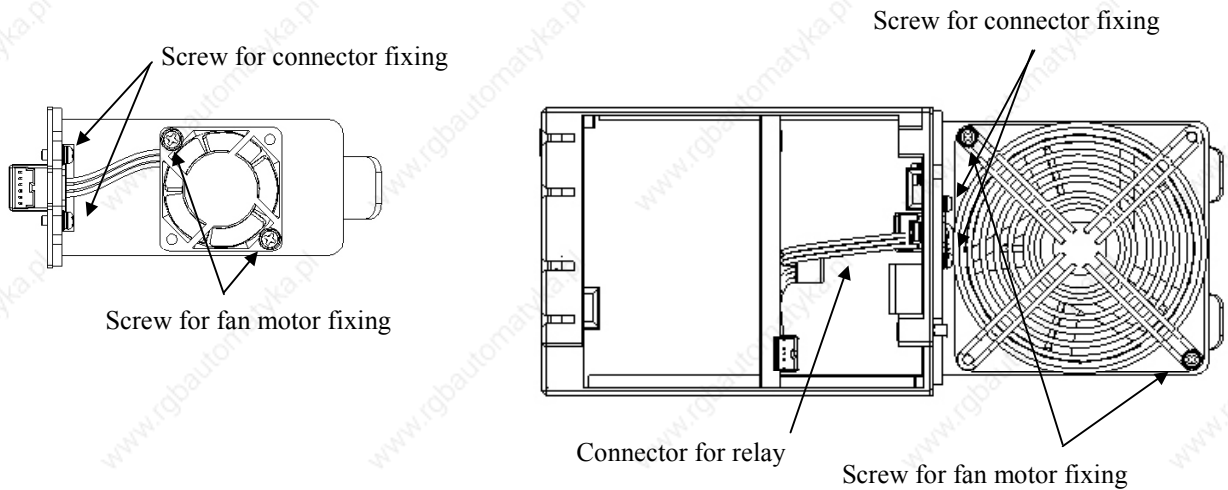

The radiator cooling fan unit for 60mm width model

(There are two kinds of fan units distinguished by the number of fan motors.)

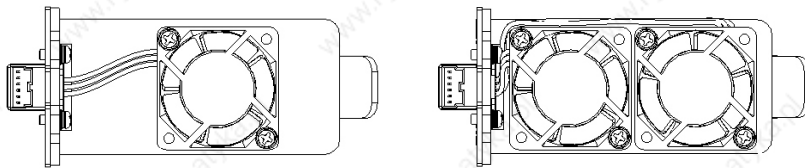

The radiator cooling fan unit for 90mm width model The radiator cooling fan unit for 150mm width model

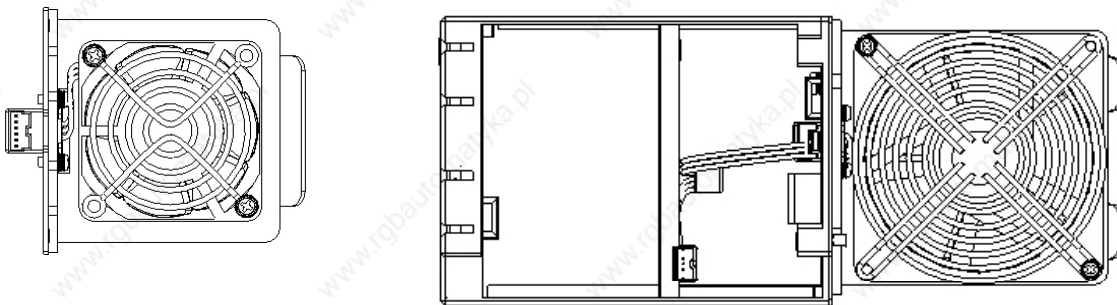

Be careful of direction (when mounted in amplifier, the label turns to a top.) of a fan motor, and direction of a connector at the time of fan motor exchange.

				TITLE	αi series SERVO AMPLIFIER for 30i-B Start-up and Maintenance manual		
				NO.	B-65285EN/03-02/01		
EDT.	DATE	DESIG.	DESCRIPTION	FANUC CORPORATION	PAGE	70 / 76	

4.1.5 Specification of Fan Unit and Fan Motor for Maintenance

• Power Supply

Model	Internal cooling fan		Radiator cooling fan	
	Fan unit	Fan motor	Fan unit	Fan motor
αi PS 7.5	A06B-6200-C607	A90L-0001-0580#B	A06B-6200-C601	A90L-0001-0575#A
αi PS 11 αi PS 15	A06B-6200-C609	A90L-0001-0580#B	A06B-6200-C603	A90L-0001-0576
αi PS 26 αi PS 30 αi PS 37	A06B-6200-C610	A90L-0001-0581	A06B-6200-C604	A90L-0001-0577
αi PS 11HV αi PS 18HV	A06B-6200-C609	A90L-0001-0580#B	A06B-6200-C603	A90L-0001-0576
αi PS 30HV αi PS 45HV αi PS 60HV	A06B-6200-C610	A90L-0001-0581	A06B-6200-C604	A90L-0001-0577

Basically, maintenance can be performed in the unit of the fan motor. The fan unit is the set of the cover for fan motor attachment, and the fan motor. (Please refer to 「4.1. HOW TO REPLACE THE FAN MOTOR」.)

- Spindle Amplifier

Model	Internal cooling fan		Radiator cooling fan	
	Fan unit	Fan motor	Fan unit	Fan unit
αi SP 2.2	A06B-6200-C606	A90L-0001-0580#A	-	-
αi SP 5.5	A06B-6200-C607	A90L-0001-0580#B	A06B-6200-C601	A90L-0001-0575#A
αi SP 11 αi SP 15	A06B-6200-C609	A90L-0001-0580#B	A06B-6200-C603	A90L-0001-0576
αi SP 22 αi SP 26 αi SP 30	A06B-6200-C610	A90L-0001-0581	A06B-6200-C604	A90L-0001-0577
αi SP 37	A06B-6200-C610	A90L-0001-0581	A06B-6200-C605	A90L-0001-0578
αi SP 11HV αi SP 15HV	A06B-6200-C609	A90L-0001-0580#B	A06B-6200-C603	A90L-0001-0576
αi SP 22HV αi SP 30HV	A06B-6200-C610	A90L-0001-0581	A06B-6200-C604	A90L-0001-0577
αi SP 45HV	A06B-6200-C610	A90L-0001-0581	A06B-6200-C605	A90L-0001-0578

Basically, maintenance can be performed in the unit of the fan motor. The fan unit is the set of the cover for fan motor attachment, and the fan motor. (Please refer to 「4.2. HOW TO REPLACE THE FAN MOTOR」.)

-Servo and Spindle Multi-axis Amplifier

Model	Internal cooling fan		Radiator cooling fan	
	Fan unit	Fan motor	Fan unit	Fan unit
αi SVP 20/20/20-5.5	A06B-6200-C609	A90L-0001-0580#B	A06B-6200-C603	A90L-0001-0576

Basically, maintenance can be performed in the unit of the fan motor. The fan unit is the set of the cover for fan motor attachment, and the fan motor. (Please refer to 「4.2. HOW TO REPLACE THE FAN MOTOR」.)

				TITLE	αi series SERVO AMPLIFIER for 30i-B Start-up and Maintenance manual		
				NO.	B-65285EN/03-02/01		
EDT.	DATE	DESIG.	DESCRIPTION	FANUC CORPORATION	PAGE	71 / 76	

- Servo Amplifier Modules

(1) Single-axis servo amplifier (SVM1, 200VAC-input)

Model	Internal cooling fan		Radiator cooling fan	
	Fan unit	Fan motor		Fan unit
αi SV 4 αi SV 20 αi SV 40 αi SV 80	A06B-6200-C606	A90L-0001-0580#A	-	-
αi SV 160	A06B-6200-C608	A90L-0001-0580#C	A06B-6200-C602	A90L-0001-0575#B
αi SV 360	A06B-6200-C610	A90L-0001-0581	A06B-6200-C604	A90L-0001-0577
αi SV 160L	A06B-6200-C609	A90L-0001-0580#B	A06B-6200-C603	A90L-0001-0576
αi SV 10HV αi SV 20HV αi SV 40HV	A06B-6200-C606	A90L-0001-0580#A	-	-
αi SV 80HV	A06B-6200-C608	A90L-0001-0580#C	A06B-6200-C602	A90L-0001-0575#B
αi SV 180HV	A06B-6200-C610	A90L-0001-0581	A06B-6200-C605	A90L-0001-0577

(2) Two-axis servo amplifier (SVM2, 200VAC-input)

Model	Internal cooling fan		Radiator cooling fan	
	Fan unit	Fan motor		Fan unit
αi SV 4/4 αi SV 4/20 αi SV 20/20 αi SV 20/40	A06B-6200-C606	A90L-0001-0580#A	-	-
αi SV 40/40 αi SV 40/80 αi SV 80/80	A06B-6200-C607	A90L-0001-0580#B	A06B-6200-C601	A90L-0001-0575#A
αi SV 80/160 αi SV 160/160	A06B-6200-C609	A90L-0001-0580#B	A06B-6200-C603	A90L-0001-0576
αi SV 10/10HV αi SV 10/20HV	A06B-6200-C606	A90L-0001-0580#A	-	-
αi SV 20/20HV αi SV 20/40HV αi SV 40/40HV	A06B-6200-C607	A90L-0001-0580#B	A06B-6200-C601	A90L-0001-0575#A
αi SV 40/80HV αi SV 80/80HV	A06B-6200-C609	A90L-0001-0580#B	A06B-6200-C603	A90L-0001-0576

				TITLE	αi series SERVO AMPLIFIER for 30i-B Start-up and Maintenance manual		
				NO.	B-65285EN/03-02/01		
EDT.	DATE	DESIG.	DESCRIPTION	FANUC CORPORATION		PAGE	72 / 76

(3) Three-axis servo amplifier (SVM3, 200VAC-input)

Model	Internal cooling fan		Radiator cooling fan	
	Fan unit	Fan motor		Fan unit
α iSV 4/4/4 α iSV 20/20/20 α iSV 20/20/40	A06B-6200-C606	A90L-0001-0580#A	-	-
α iSV 40/40/40	A06B-6200-C608	A90L-0001-0580#C	A06B-6200-C602	A90L-0001-0575#B
α iSV 10/10/10HV α iSV 10/10/20HV	A06B-6200-C606	A90L-0001-0580#A	-	-
α iSV 20/20/20HV	A06B-6200-C608	A90L-0001-0580#C	A06B-6200-C602	A90L-0001-0575#B

Basically, maintenance can be performed in the unit of the fan motor. The fan unit is the set of the cover for fan motor attachment, and the fan motor. (Please refer to 「4.2. HOW TO REPLACE THE FAN MOTOR」.)

				TITLE	α i series SERVO AMPLIFIER for 30i-B Start-up and Maintenance manual		
				NO.	B-65285EN/03-02/01		
EDT.	DATE	DESIG.	DESCRIPTION	FANUC CORPORATION		PAGE	73 / 76

4.2. HOW TO REPLACE FUSES ON PRINTED-CIRCUIT BOARDS

In the αi series, a printed-circuit board can be removed and inserted from the front of the servo amplifier. The printed-circuit board removal/insertion procedure is common to the PS, SV, and SP.

Note

1. When the fuse is blowed, the cause by the power supply short circuit of other apparatus (sensor etc.) connected to servo amplifier can be considered.
Please exchange the fuse after a check whether other apparatus is normal.
If the cause is not removed, there is a possibility that the fuse will be blowed again.
2. Please use the fuse supplied from FANUC.
3. Please check the rating mark on the PCB and seal of the fuse to prevent mistakes.

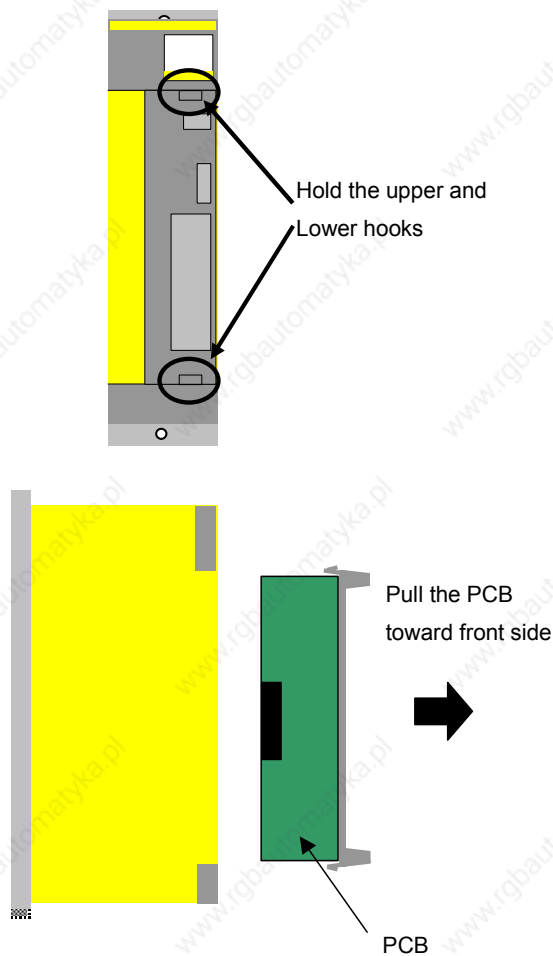

To insert the printed-circuit board, reverse the above procedure. Ensure that the upper and lower hooks snap into the housing. If the printed-circuit board is not inserted completely, the housing remains lifted. Pull out the printed-circuit board and insert it again.

				TITLE	αi series SERVO AMPLIFIER for 30 <i>i</i> -B Start-up and Maintenance manual		
				NO.	B-65285EN/03-02/01		
EDT.	DATE	DESIG.	DESCRIPTION	FANUC CORPORATION		PAGE	74 / 76

4.2.1 Power Supply

There is one fuse on the printed-circuit board for SP.

Symbol	Ordering number	Rating
FU1	A60L-0001-0290#LM32C	3.2A/48V

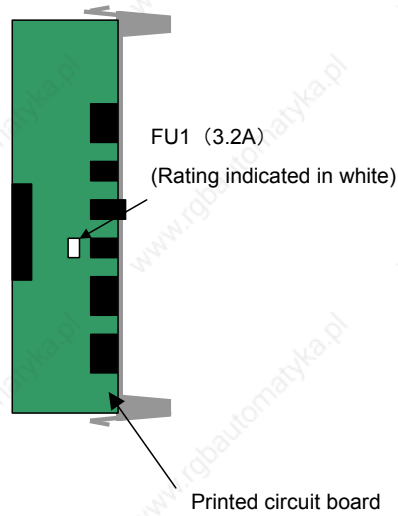

4.2.2 Servo amplifier

There is one fuse on the printed-circuit board for SP.

Symbol	Ordering number	Rating
FU1	A60L-0001-0290#LM32C	3.2A/48V

(1) 60/90mm width servo amplifier

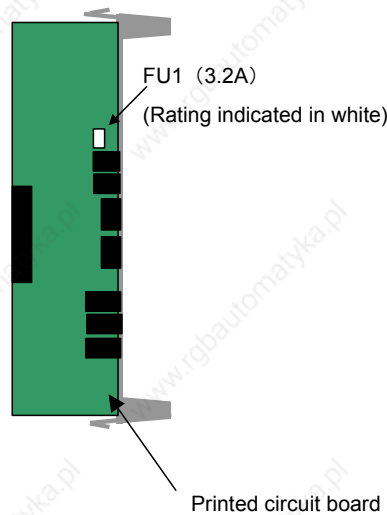

				TITLE	αi series SERVO AMPLIFIER for 30i-B Start-up and Maintenance manual		
				NO.	B-65285EN/03-02/01		
EDT.	DATE	DESIG.	DESCRIPTION	FANUC CORPORATION		PAGE	75 / 76

4.2.3 Spindle amplifier

There is one fuse on the printed-circuit board for SP.

Symbol	Ordering number	Rating
F1	A60L-0001-0290#LM32C	3.2A/48V

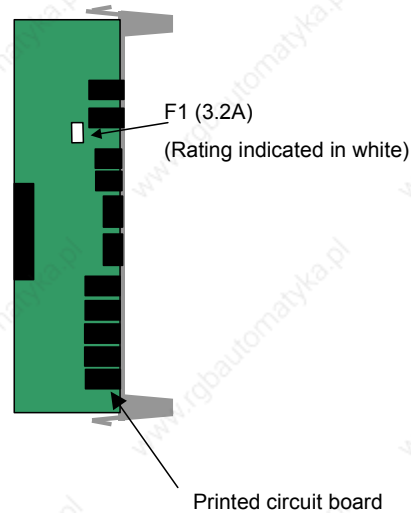

4.2.4 Servo /Spindle multi-axis model

There is one fuse on the printed-circuit board for SVP.

Symbol	Ordering number	Rating
F1	A60L-0001-0290#LM32C	3.2A/48V

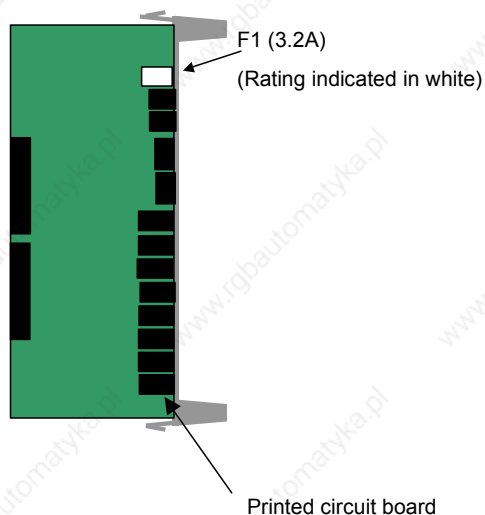

				TITLE	αi series SERVO AMPLIFIER for 30i-B Start-up and Maintenance manual		
				NO.	B-65285EN/03-02/01		
EDT.	DATE	DESIG.	DESCRIPTION	FANUC CORPORATION		PAGE	76 / 76