

SIEMENS



Fuse Systems

SENTRON

Configu-
ration
Manual

Edition
10/2015

siemens.com/lowvoltage

Fuse Systems

















2	Introduction
8	NEOZED fuse systems NEOZED fuse links
15	DIAZED fuse systems
24	Cylindrical fuse systems Cylindrical fuse links and cylindrical fuse holders
32	Fuse holders in size 10 x 38 mm and Class CC
36	Class CC fuse systems
40	Busbar systems
45	3NA, 3ND LV HRC fuse systems LV HRC fuse links
68	LV HRC signal detectors
69	LV HRC fuse bases and accessories
78	SITOR semiconductor fuses LV HRC design
147	Cylindrical fuse design
168	NEOZED and DIAZED design
172	Configuration
186	Photovoltaic fuses Introduction
186	PV cylindrical fuses
191	PV cumulative fuses
For further technical product information:	
Siemens Industry Online Support: www.siemens.com/lowvoltage/product-support	
→ Entry type: Application example Certificate Characteristic Download FAQ Manual Product note Software archive Technical data	

Fuse Systems

Introduction

Overview

Devices	Page	Application	Standards	Used in		
				Non-residential buildings	Residential buildings	Industry
 <p>NEOZED fuse systems</p>	8	MINIZED switch disconnectors, bases, fuse links from 2 A to 63 A of operational class gG and accessories. Everything you need for a complete system.	Fuse system: IEC 60269-3; DIN VDE 0636-3 Safety switching devices IEC/EN 60947-3 DIN VDE 0638; DIN EN 60947-3 (VDE 0660-107)	✓	✓	✓
 <p>DIAZED fuse systems</p>	15	Fuse links from 2 A to 100 A in various operational classes, base versions with classic screw base connections. A widely used fuse system.	IEC 60269-3; DIN VDE 0635; DIN VDE 0636-3; CEE 16	✓	✓	✓
Cylindrical fuse systems						
 <p>Cylindrical fuse links and cylindrical fuse holders</p>	24	Line protection or protection of switching devices. The fuse holders with touch protection ensure the safe "no-voltage" replacement of fuse links. Auxiliary switches can be retrofitted.	IEC 60269-1, -2, -3; NF C 60-200; NF C 63-210, -211; NBN C 63269-2, CEI 32-4, -12 Fuse holders: File No. E171267	✓	✓	✓
 <p>Fuse holders in size 10 x 38 mm and Class CC</p>	32	For installing fused loaded motor starter combinations.	IEC 60269-1, -2; IEC 60947-4; UL 4248-1, File No. E171267 CSA 250269, 6225-01 Auxiliary switches: UL 508, File No. E334003	✓	--	✓
 <p>Class CC fuse systems</p>	36	These comply with American standard and have UL and CSA approval, for customers exporting OEM products and mechanical engineers. Modern design with touch protection according to BGV A3 for use in "branch circuit protection".	Fuse holders: UL 4248-1, E171267 CSA 22.2 Fuse links: UL 248-4, File No. E258218, CSA 231237, 1422-02 and 1422-82	✓	✓	✓
 <p>Busbar systems</p>	40	Busbars for NEOZED fuse bases, NEOZED fuse disconnectors, MINIZED switch disconnectors, DIAZED fuse systems and for the cylindrical fuse systems. Compact cylindrical fuse holders for busbars.	DIN EN 60439-1 (VDE 0660-500) UL 4248-1, E337131	✓	✓	✓

Devices	Page	Application	Standards	Used in			
				Non-residential buildings	Residential buildings	Industry	
3NA, 3ND LV HRC fuse systems							
	LV HRC fuse links	45	Fuse links from 2 A to 1250 A for selective line protection and system protection in non-residential buildings, industry and power utilities.	IEC 60269-1, -2; EN 60269-1; DIN VDE 0636-2; CSA 16325 - 1422-02	✓	✓	✓
	LV HRC signal detectors	68	Signal detectors for when a fuse is tripped on all LV HRC fuse links with combination or front indicators with non-insulated grip lugs. Plus the comprehensive accessory range required for LV HRC fuse systems.	--	✓	✓	✓
	LV HRC fuse bases and accessories	69	Fuse bases for screw or snap-on mounting onto standard mounting rails, available as 1-pole or 3-pole version.	IEC 60269-1, -2; EN 60269-1; DIN VDE 0636-2 UL 4248-1, File No. E171267-IZLT2 (only downstream from branch circuit protection) CSA C22.2 No. 4248.1-07	✓	✓	✓
SITOR semiconductor fuses							
	LV HRC design	78	Fuse links in LV HRC design and a huge variety of models support a wide range of applications from 500 V to 1500 V and 150 A to 1600 A. Fuses with slotted blade contacts, bolt-on links or female thread, and special designs.	UL 4248-13, File No. E167357-JFHR2	--	--	✓
	Cylindrical fuse design	147	Fuse links, fuse holders – usable as fuse switch disconnectors and fuse bases up to 600/690 V AC and 400/700 V DC from 1 A to 100 A in the sizes 10 × 38 mm, 14 × 51 mm and 22 × 58 mm.	Fuse links: UL 4248-13, File No. E167357-JFHR2 CSA 248170, 1422-30 Fuse holders: UL 4248-1, File No. E171267-IZLT CSA 248170, 6225-01	--	--	✓
	NEOZED and DIAZED design	168	NEOZED fuse links for 400 V AC and 250 V DC and DIAZED for 500 V AC and 500 V DC.	--	--	--	✓
Photovoltaic fuses							
	PV cylindrical fuses	186	Fuses with a rated voltage of 1000 V DC and operational class gPV for the protection of photovoltaic modules, their connecting cables and other components.	IEC 60269-6	✓	✓	✓
	PV cumulative fuses	191	Fuses with a rated voltage of 1000 V and 1500 V DC, a rated current of 63 A to 630 A and operational class gPV for the protection of connecting cables and other components.	IEC60269-6	✓	✓	✓

Fuse Systems

Introduction

Overview

Rated voltage U_n

The rated voltage is the designated voltage of the fuse and is used to determine its test conditions and operational voltage limits.

For LV HRC and SITOR fuse links, the rated voltage is always the rms value of an AC voltage.

For wind power plants and some industrial applications, a higher voltage tolerance is demanded of the LV HRC and SITOR fuses than the tolerance of +5 % defined in the standard. On request, you can obtain a manufacturer's declaration for the rated voltage of 690 V +10 %.

In the case of NEOZED and DIAZED fuse links, a distinction is made between AC and DC voltage values.

Rated current I_n

The rated current of a fuse link is the designated current of the fuse link and is the current up to which it can be continuously loaded under prescribed conditions without adverse affects.

Rated frequency

The rated frequency is the frequency for which the fuse link is rated with regard to power dissipation, current, voltage, characteristic curve and breaking capacity.

Selectivity

Several fuses are usually connected in series in a system. Selectivity ensures that only the faulty electric circuit and not all operating processes are interrupted in a system in serious cases.

Siemens fuses of operational class gG, at an operational voltage of up to 400 V AC and a ratio of 1:1.25, are interselective, i.e. from rated current level to rated current level. This is achieved by means of the considerably smaller band of scatter of $\pm 5\%$ of the time/current characteristics, which far exceeds the demand for a ratio of 1:1.6 specified in the standard.

It is therefore possible to use smaller conductor cross-sections due to the lower rated currents.

Breaking capacity

The rated breaking capacity is the highest prospective short-circuit current I_p that the fuse link can blow under prescribed conditions.

A key feature of these fuses is their high rated breaking capacity with the smallest footprint. The basic demands and circuit data for tests – voltage, power factor, actuating angle, etc. – are specified in both national (DIN VDE 0636) and international (IEC 60269) regulations.

However, for a constant fail-safe breaking capacity, from the smallest non-permissible overload current through to the highest short-circuit current, a number of quality characteristics need to be taken into account when designing and manufacturing fuse links. These include the design of the fuse element with regard to dimensions and punch dimension and its position in the fuse body, as well as its compressive strength and the thermal resistance of the body. The chemical purity, particle size and the density of the quartz sand also play a key role.

The rated breaking capacity for AC voltage for NEOZED fuses – and the majority of DIAZED fuses – is 50 kA, and in the case of our LV HRC fuses (NH type), it is even 120 kA. The various type ranges of SITOR semiconductor fuses have different switching capacities ranging from 50 to 100 kA.

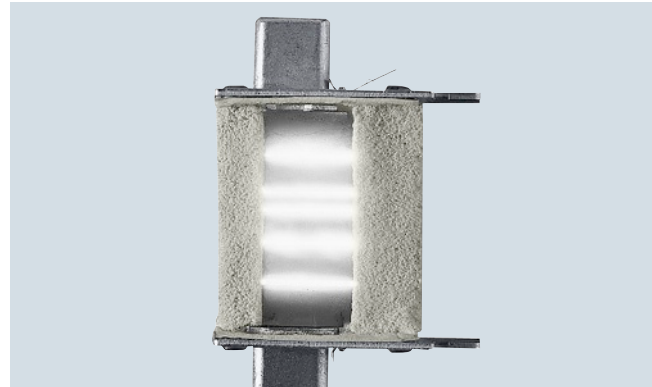

Faster arcing and precise arc quenching are the requirements for a reliable breaking capacity.

Operational classes

Fuses are categorized according to function and operational classes. The first letter defines the function class and the second the object to be protected:

1st letter

a = Partial range protection
(accompanied fuses):

Fuse links that carry currents at least up to their specified rated current and can switch currents above a specific multiple of their rated current up to their rated breaking current.

g = Full range protection
(general purpose fuses):

Fuse links that can continuously carry currents up to at least their specified rated current and can switch currents from the smallest melting current through to the breaking current. Overload and short-circuit protection.

2nd letter

G = Cable and line protection
(general applications)

M = Switching device protection in motor circuits
(for protection of motor circuits)

R, S = Semiconductor protection/thyristor protection
(for protection of rectifiers)

L = Cable and line protection
(in acc. with the old, no longer valid DIN VDE)

B = Mine equipment protection

Tr = Transformer protection

The designations "slow" and "quick" still apply to DIAZED fuses. These are defined in IEC/CEE/DIN VDE.

In the case of "quick" characteristics, the fuse blows in the breaking range faster than those of operational class gG.

In the case of DIAZED fuse links for DC railway network protection, the "slow" characteristic is particularly suitable for switching off direct currents with greater inductance. Both characteristics are also suitable for the protection of cables and lines.

Full range fuses (gG, gR, quick, slow) reliably break the current in the event of non-permissible overload and short-circuit currents.

Partial range fuses (aM, aR) exclusively serve short-circuit protection.

The following operational classes are included in the product range:

gG	(DIN VDE/IEC) = Full-range cable and line protection
aM	(DIN VDE/IEC) = Partial-range switching device protection
aR	(DIN VDE/IEC) = Partial-range semiconductor protection
gR	(DIN VDE/IEC) = Full-range semiconductor protection
gS	(DIN VDE/IEC) = Full-range semiconductor protection and cable and line protection
quick	(DIN VDE/IEC/CEE) = Full-range cable and line protection
slow	(DIN VDE) = Full range cable and line protection

Characteristic curves (time/current characteristic curves)

The time/current characteristic curve specifies the virtual time (e.g. the melting time) as a function of the prospective current under specific operating conditions.

Melting times of fuse links are presented in the time/current diagrams with logarithmic subdivision as a function of their currents. The melting time characteristic curve extends from the lowest melting current, which still just causes the melting conductor to melt asymptotically to the I^2t line of equal Joulean heat values in the range of higher short-circuit currents, which specifies the constant melting heat value I^2t . For the sake of simplicity, the time/current characteristics diagrams omit the I^2t lines (c).

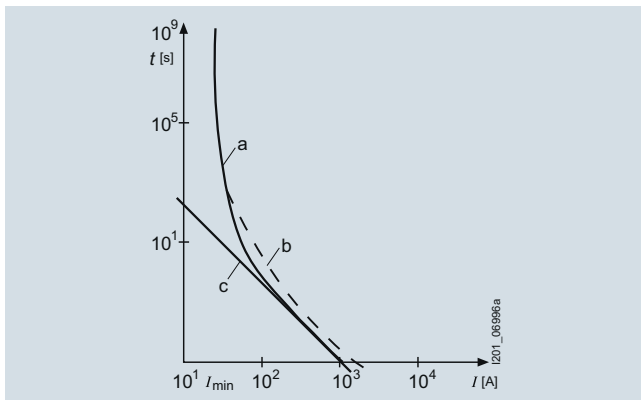

General representation of the time/current characteristic curve of a fuse link of operational class gL/gG

I_{\min} : Smallest melting current

- a: Melting time/current characteristic
- b: Breaking time characteristic curve
- c: I^2t line

The curve of the characteristic depends on the outward heat transfer from the fuse element. DIN VDE 0636 specifies tolerance-dependent time/current ranges within which the characteristic curves of the fuse must lie. Deviations of $\pm 10\%$ are permissible in the direction of the current axis. With Siemens LV HRC fuse links of operational class gG, the deviations work out at less than $\pm 5\%$, a mark of our outstanding production accuracy. For currents up to approx. $20 I_n$, the melting time/current characteristic curves are the same as the breaking time characteristic curves. In the case of higher short-circuit currents, the two characteristic curves move apart, influenced by the respective arc quenching time.

The difference between both lines (= arc quenching time) also depends on the power factor, the operational voltage and the breaking current.

The Siemens characteristic curves show the mean virtual melting time characteristic curves recorded at an ambient temperature of $(20 \pm 5)^\circ\text{C}$. They do not apply to preloaded fuse links.

Virtual time t_v

The virtual time is the time span calculated when an I^2t value is divided by the square of the prospective current:

$$t_v = \frac{\int i^2 dt}{I_p^2}$$

The time/current characteristic curve specifies the prospective current I_p and the virtual melting time t_{vs} .

Prospective short-circuit current I_p

The prospective short-circuit current is the rms value of the line-frequency AC component, or the value of direct current to be expected in the event of a short-circuit occurring downstream of the fuse, were the fuse to be replaced by a component of negligible impedance.

Let-through current characteristic curves

The let-through current characteristic curve specifies the value of the let-through current at 50 Hz as a function of the prospective current.

The let-through current I_c is the maximum instantaneous value of the current reached during a switching operation of a fuse.

The fuse element of the fuse links melts so quickly at very high currents that the surge short-circuit current I_p is prevented from occurring. The highest instantaneous value of the current reached during the breaking cycle is called the let-through current I_c . The current limits are specified in the current limiting diagrams, otherwise known as let-through current diagrams.

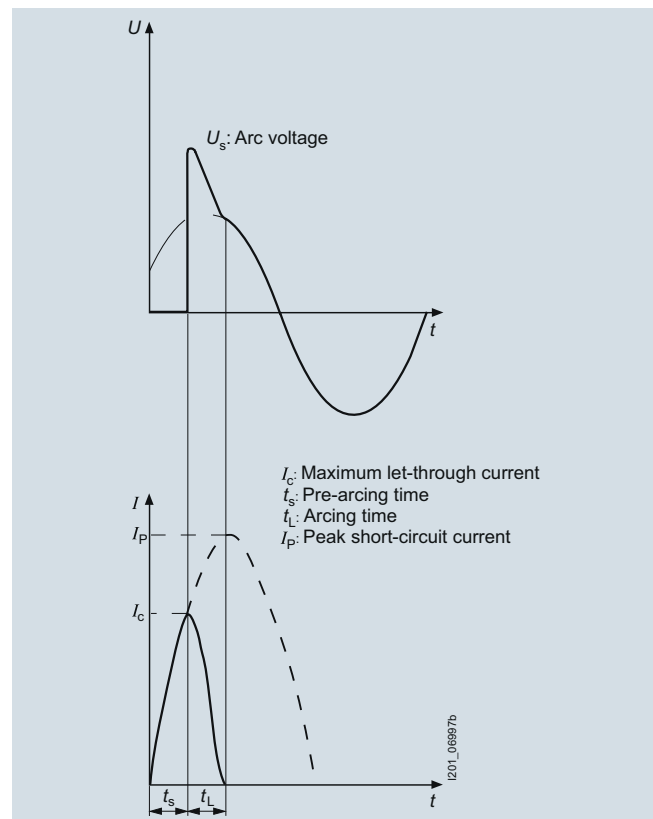

Oscillograph of a short-circuit current breaking operation through a fuse link

Fuse Systems

Introduction

Current limiting

As well as a fail-safe rated breaking capacity, the current-limiting effect of a fuse link is of key importance for the cost effectiveness of a system. In the event of short-circuit breaking by a fuse, the short-circuit current continues to flow through the network until the fuse link is switched off. However, the short-circuit current is only limited by the system impedance.

The simultaneous melting of all the bottlenecks of a fuse element produce a sequence of tiny partial arcs that ensure a fast breaking operation with strong current limiting. The current limitation is also strongly influenced by the production quality of the fuse – which in the case of Siemens fuses is extremely high. For example, an LV HRC fuse link, size 2 (224 A) limits a short-circuit current with a possible rms value of approximately 50 kA to a let-through current with a peak value of approx. 18 kA. This strong current limitation provides constant protection for the system against excessive loads.

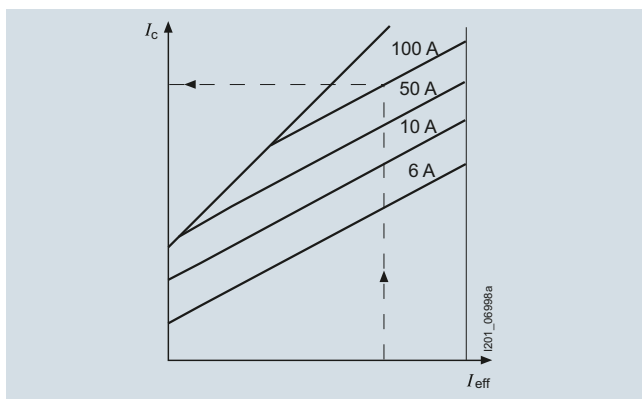

Current limiting diagram
Let-through current diagram of LV HRC fuse links, size 00
Operational class gL/gG
Rated currents 6 A, 10 A, 50 A, 100 A

Legend

- t_{vs} = Virtual melting time
- I_c = Max. let-through current
- I_{rms} = rms value of the prospective short-circuit current
- I^2t_s = Melting I^2t value
- I^2t_a = Breaking I^2t value
- I_n = Rated current
- P_v = Rated power dissipation
- $\Delta\theta$ = Temperature rise
- k_A = Correction factor for I^2t value
- U_w = Recovery voltage
- \hat{U}_s = Peak arc voltage
- I_p = Peak short-circuit current
- ① = Peak short-circuit current with largest DC component
- ② = Peak short-circuit current without DC component
- U = Voltage
- i = Current
- t_s = Melting time
- t_l = Arc quenching time

Rated power dissipation

Rated power dissipation is the power loss during the load of a fuse link with its rated current under prescribed conditions.

The cost effectiveness of a fuse depends largely on the rated power dissipation (power loss). This should be as low as possible and have low self-heating. However, when assessing the power loss of a fuse, it must also be taken into account that there is a physical dependence between the rated breaking capacity and the rated power dissipation. On the one hand, fuse elements need to be very thick in order to achieve the lowest possible resistance value, on the other, a high rated breaking capacity requires the thinnest possible fuse elements in order to achieve reliable arc quenching.

Siemens fuses have the lowest possible rated power dissipation while also providing the highest possible load breaking reliability.

These values lie far below the limit values specified in the regulations. This means a low temperature rise, reliable breaking capacity and high cost effectiveness.

I^2t value

The I^2t value (joule integral) is the integral of the current squared over a specific time interval:

$$I^2t = \int_{t_0}^{t_1} i^2 dt$$

Specifies the I^2t values for the melting process (I^2t_s) and for the breaking cycle (I^2t_a , – sum of melting and quenching I^2t value). The melting I^2t value, also known as the total I^2t value or breaking I^2t value, is particularly important when dimensioning SITOR semiconductor fuses. This value depends on the voltage and is specified with the rated voltage.

Peak arc voltage \hat{U}_s

The peak arc voltage is the maximum value of the voltage that occurs at the connections of the fuse link during the arc quenching time.

Residual value factor RV

The residual value factor is a reduction factor for determining the permissible load period of the fuse link with currents that exceed the permissible load current I_n' (see rated current I_n). This factor is applied when dimensioning SITOR semiconductor fuses.

Varying load factor VL

The varying load factor is a reduction factor for the rated current with varying load states. This factor is applied when dimensioning SITOR semiconductor fuses.

Recovery voltage U_w

The recovery voltage (rms value) is the voltage that occurs at the connections of a fuse link after the power is cut off.

More information

Load capability with increased ambient temperature

The time/current characteristic curve of the NEOZED/DIAZED and LV HRC fuse links is based on an ambient temperature of $20\text{ °C} \pm 5\text{ °C}$ in accordance with DIN VDE 0636. When used in higher ambient temperatures (see diagram) a reduced load-carrying capacity must be planned for. At an ambient temperature of 50 °C , for example, an LV HRC fuse link should be dimensioned for only 90 % of the rated current. While the short-circuit behavior is not influenced by an increased ambient temperature, it is influenced by overload and operation at rated value.

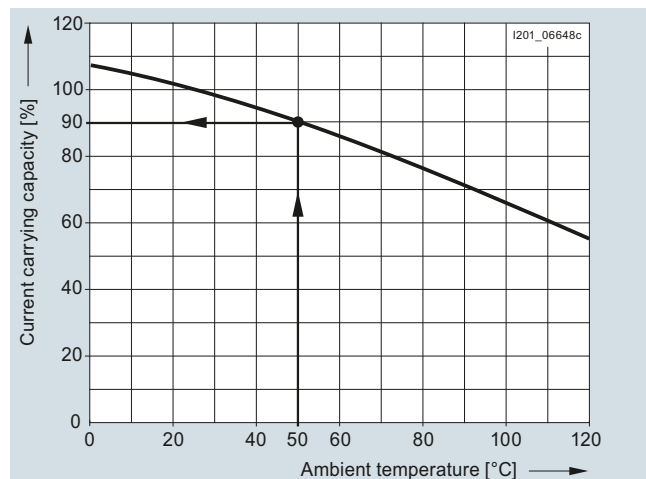

Influence of the ambient temperature on the load capability of NEOZED/DIAZED and LV HRC fuses of operational class gG with natural convection in the distribution board.

Assignment of cable and line protection

When gG fuses are assigned for cable and line protection against overloading, the following conditions must be met in order to comply with DIN VDE 0100 Part 430:

$$(1) I_B = I_n = I_Z \text{ (rated current rule)}$$

$$(2) I_2 = 1.45 \times I_Z \text{ (tripping rule)}$$

I_B : Operational current of electrical circuit

I_n : Rated current of selected protective device

I_Z : Permissible current carrying capacity of the cable or line under specified operating conditions

I_2 : Tripping current of the protective device under specified operating conditions ("high test current").

These days, the factor 1.45 has become an internationally accepted compromise of the protection and utilization ratio of a line, taking into account the breaking response of the protective device (e.g. fuse).

In compliance with the supplementary requirements for DIN VDE 0636, Siemens fuse links of operational class gG comply with the following condition:

"Load breaking switching with $I_2 = 1.45 \times I_n$ during conventional test duration under special test conditions in accordance with the aforementioned supplementary requirements of DIN VDE 0636".

This therefore permits direct assignment.

Fuse Systems

NEOZED Fuse Systems

NEOZED fuse links

Overview

The NEOZED fuse system is primarily used in distribution technology and industrial switchgear assemblies. The system is easy to use and is also approved for domestic installation.

The MINIZED switch disconnectors are primarily used in switchgear assemblies and control engineering. They are approved for switching loads as well as for safe switching in the event of short circuits. The MINIZED D02 is also suitable for use upstream of the meter in household applications in compliance with the recommendations of VDEW according to TAB 2007.

Due to its compact design, the MINIZED D01 fuse switch disconnector is primarily used in control engineering.

The NEOZED fuse bases are the most cost-effective solution for using NEOZED fuses. All NEOZED bases must be fed from the bottom to ensure that the threaded ring is insulated during removal of the fuse link. The terminals of the NEOZED bases are available in different versions and designs to support the various installation methods.



Fuse bases D01 with terminal version BB

- Incoming feeders, clamp-type terminal B
- Outgoing feeders, clamp-type terminal B



Fuse bases D02, with terminal version KS

- Incoming feeders, screw head contact K
- Outgoing feeders, saddle terminal S



Fuse bases D02, with terminal version SS

- Incoming feeders, saddle terminal S
- Outgoing feeders, saddle terminal S

Technical specifications

		NEOZED fuse links						
		5SE2						
Standards		IEC 60269-3; DIN VDE 0636-3						
Operational class		gG						
Rated voltage U_n	V AC	400						
	V DC	250						
Rated current I_n	A	2 ... 100						
Rated breaking capacity	kA AC	50						
	kA DC	8						
Non-interchangeability		Using adapter sleeves						
Resistance to climate	°C	Up to 45 at 95 % rel. humidity						
Ambient temperature	°C	-5 to +40, humidity 90 % at 20						
		MINIZED switch dis- connectors	MINIZED fuse switch discon- nectors	Fuse bases, made of ceramic			Comfort bases	Fuse bases
		D02 5SG71	D01 5SG76	D01 5SG15 5SG55	D02 5SG16 5SG56	D03 5SG18	D01/02 5SG1.01 5SG5.01	5SG1.30 5SG1.31 5SG5.30
Standards		DIN VDE 0638; EN 60947-3 (VDE 0660-107) IEC/EN 60947-3		IEC 60269-3; DIN VDE 0636-3				
Main switch characteristic, EN 60204-1		Yes	--	--				
Insulation characteristic EN 60664-1		Yes	--	--				
Rated voltage U_n	V AC	230/400, 240/415		400				
	• 1P V DC	65	48	250				
	• 2P in series V DC	130	110	250				
Rated current I_n	A	63	16	16	63	100	16/63	16/63
Rated insulation voltage	V AC	500	400	--				
Rated impulse withstand voltage	KV AC	6	2.5	--				
Overvoltage category		IV	IV	--				
Utilization category acc. to VDE 0638								
• AC-22	A	63	16	--				
Utilization category acc. to EN 60947-3								
• AC-22 A	A	--	16	--				
• AC-22 B	A	63	--	--				
• AC-23 B	A	35	--	--				
• DC-22 B	A	63	--	--				
Sealable When switched on		Yes		Yes, with sealable screw caps				
Mounting position		Any, preferably vertical						
Reduction factor of I_n with 18 pole								
• Side-by-side mounting		0.9	--					
• On top of one another, with vertical standard mounting rail		0.87	--					
Degree of protection acc. to IEC 60529		IP20, with connected conductors ¹⁾						
Terminals With touch protection acc. to BGV A3		Yes			No		Yes	
Ambient temperature	°C	-5 to +40, humidity 90 % at 20						
Terminal versions		--	--	B	K, S	K/S	--	--
Conductor cross-sections								
• Solid and stranded	mm ²	1.5 ... 35	1.5 ... 16	1.5 ... 4	1.5 ... 25	10 ... 50	0.75 ... 35	1.5 ... 35
• Flexible, with end sleeve	mm ²	1.5 ... 35	1.5	1.5	1.5	10	--	--
• Finely stranded, with end sleeve	mm ²	--	--	0.75 ... 25	--	--	--	--
Tightening torque	Nm	2.5 ... 3	2.5	1.2	2	3.5/2.5	3.5	3

¹⁾ Degree of protection IP20 is tested according to regulations using a straight test finger (from the front), with the device mounted and equipped with a cover, housing or some other enclosure.

Fuse Systems

NEOZED Fuse Systems

NEOZED fuse links

Dimensional drawings

5SG71.3 MINIZED D02 switch disconnectors, with draw-out technology

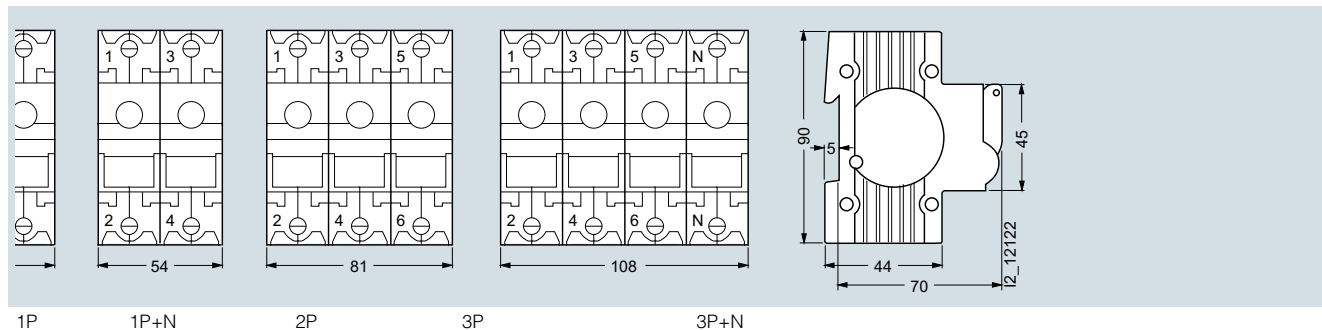

Locking cap for MINIZED D02 switch disconnectors

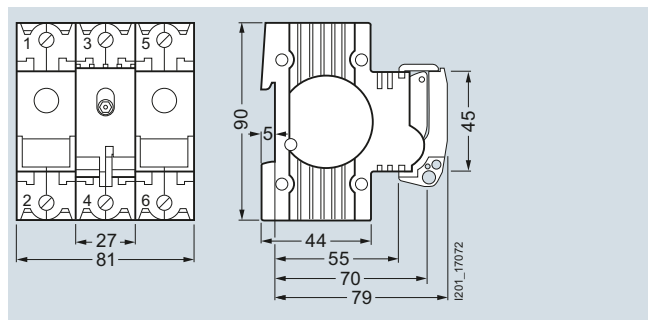

5SG76 MINIZED D01 fuse switch disconnectors, with draw-out technology

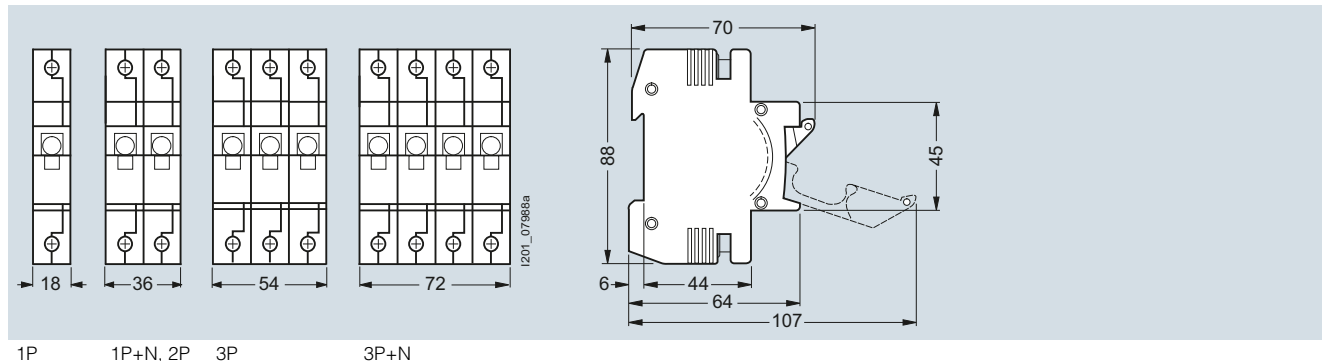

Fuse bases with touch protection BGV A3 (VBG4), molded plastic

Sizes D01/D02, with combined terminal, can be busbar mounted

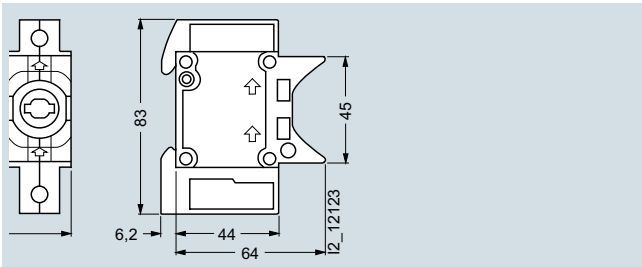

5SG1301, 5SG1701 5SG5301, 5SG5701

With cover

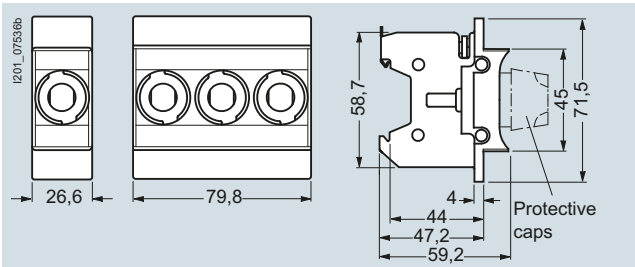

5SG1330, 5SG1331, 5SG1730, 5SG1731 5SG5330, 5SG5730

NEOZED fuse bases made of ceramic

Sizes D01/D02/D03

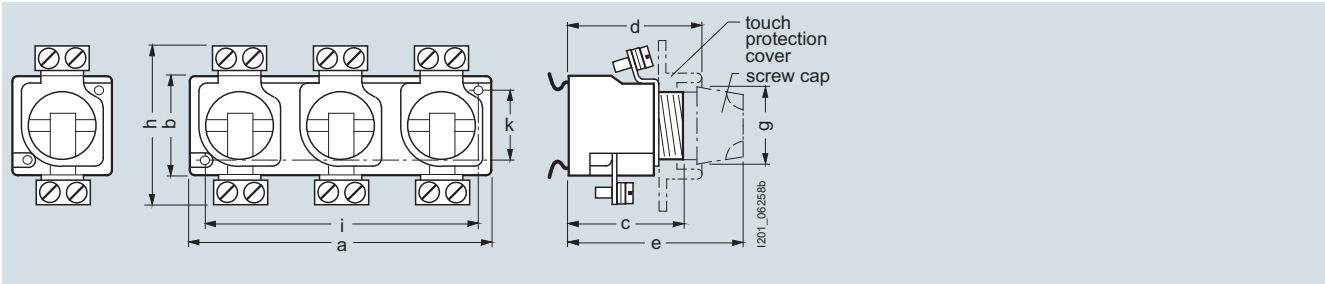

5SG15

5SG55

Type	Version	Size	Connection type	Dimensions									
				a	b	c	d	e	g Not sealed/ sealed	h	i	k	
Snap-on with cover													
5SG1553	1-pole	D01	BB	26.8	36	40	56	70	23/26.5	54	--	--	
5SG1653		D02	SS	26.8	36	41	56	70	23/26.5	59	--	--	
5SG1693		D02	KS	26.8	36	41	56	70	23/26.5	60	--	--	
5SG5553	3-pole	D01	BB	80.8	36	40	56	70	23/26.5	54	--	--	
5SG5653		D02	SS	80.8	36	41	56	70	23/26.5	59	--	--	
5SG5693		D02	KS	80.8	36	41	56	70	23/26.5	60	--	--	
Snap-on without cover													
5SG1595	1-pole	D01	BB	26.8	36	40	56	70	23/26.5	54	--	--	
5SG1655		D02	SS	26.8	36	41	56	70	23/26.5	59	--	--	
5SG1695		D02	KS	26.8	36	41	56	70	23/26.5	60	--	--	
5SG1812	D03	KS	44.9	50	44	54.5	76	44	86	--	--		
5SG5555	3-pole	D01	BB	80.8	36	40	56	70	23/26.5	54	--	--	
5SG5655		D02	SS	80.8	36	41	56	70	23/26.5	59	--	--	
5SG5695		D02	KS	80.8	36	41	56	70	23/26.5	60	--	--	
Screw-on without cover													
5SG1590	1-pole	D01	BB	26.8	36	40	56	70	23/26.5	54	20	22	
5SG1650		D02	SS	26.8	36	41	56	70	23/26.5	59	20	22	
5SG1810		D03	KS	44.9	50	46	54.5	76	44	86	32	32	
5SG5550	3-pole	D01	BB	80.8	36	40	56	70	23/26.5	54	74	22	
5SG5650		D02	SS	80.8	36	41	56	70	23/26.5	59	74	22	
5SG5690		D02	KS	80.8	36	41	56	70	23/26.5	60	74	22	

Legend

Connection type:

K = Screw head contact
 B = Clamp-type terminal
 S = Saddle terminal

BB = Clamp-type terminal at incoming feeder
 Clamp-type terminal at outgoing feeder
 SS = Saddle terminal at incoming feeder
 Saddle terminal at outgoing feeder
 KS = Screw head contact at incoming feeder
 Saddle terminal at outgoing feeder

NEOZED covers made of molded plastic

NEOZED covers for NEOZED fuse bases, made of molded plastic

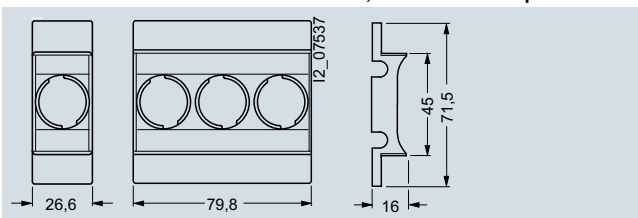

5SH5244 (A1) 5SH5245 (A2)

NEOZED covers for NEOZED fuse bases, made of ceramic

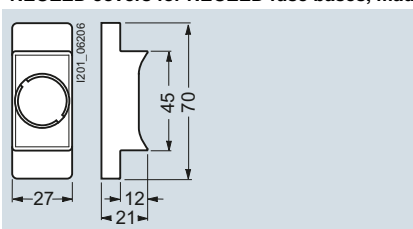

5SH5251 (A4) and 5SH5253 (A10)

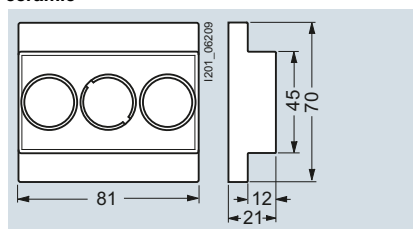

5SH5252 (A5) and 5SH5254 (A11)

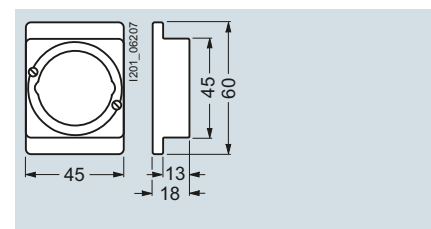

5SH5233 (A6)

Fuse Systems

NEOZED Fuse Systems

NEOZED fuse links

NEOZED screw caps

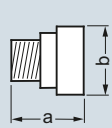
5SH4	Type	Size	Sealable	For mounting depth	Dimensions	
					a	b
	5SH4116	D01	--	70	27.5	24
	5SH4163	D02	--	70	27.5	24
	5SH4316	D01	✓	70	33	26.5
	5SH4363	D02	✓	76	33	26.5
	5SH4100	D03	--	70	37	44
	5SH4317	D01	--	70	29.5	25
	5SH4362	D02	--	70	30.5	25

NEOZED fuse links

Size/thread	Rated current in A	Dimension d _{2 min}	Dimension d ₃	Dimension d _{4 max}	Dimension h
D01/E14	2 ... 16	9.8	11	6	36
D02/E18	20 ... 63	13.8	15.3	10	36
D03/M30	80 ... 100	20.8	22.5	36	43

Size	I _n A
D01/E14	2 ... 16
D02/E18	20 ... 63
D03/M30	80 ... 100

Circuit diagrams

Graphical symbols

5SG71.3 MINIZED D02 switch disconnectors, with draw-out technology

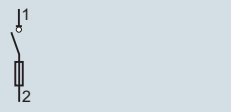
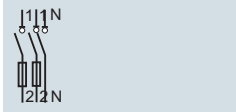
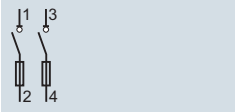
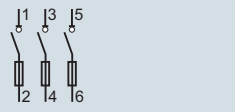
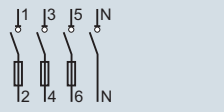
				
5SG7113	5SG7153	5SG7123	5SG7133 5SG7133-8BA25 5SG7133-8BA35 5SG7133-8BA50	5SG7163
1P	1P+N	2P	3P	3P+N

5SG76 MINIZED D01 fuse switch disconnectors, with draw-out technology

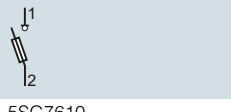
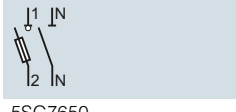
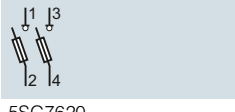
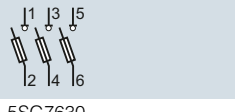
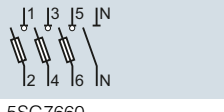
				
5SG7610	5SG7650	5SG7620	5SG7630	5SG7660
1P	1P+N	2P	3P	3P+N

NEOZED fuse bases/fuses in general

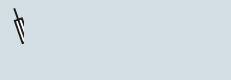
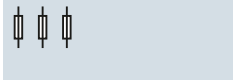
	
5SG1	5SG5
1P	3P

Characteristic curves

Series 5SE2

Sizes: D01, D02, D03
Operational class: gG
Rated voltage: 400 V AC/250 V DC
Rated current: 2 ... 100 A

Time/current characteristics diagram

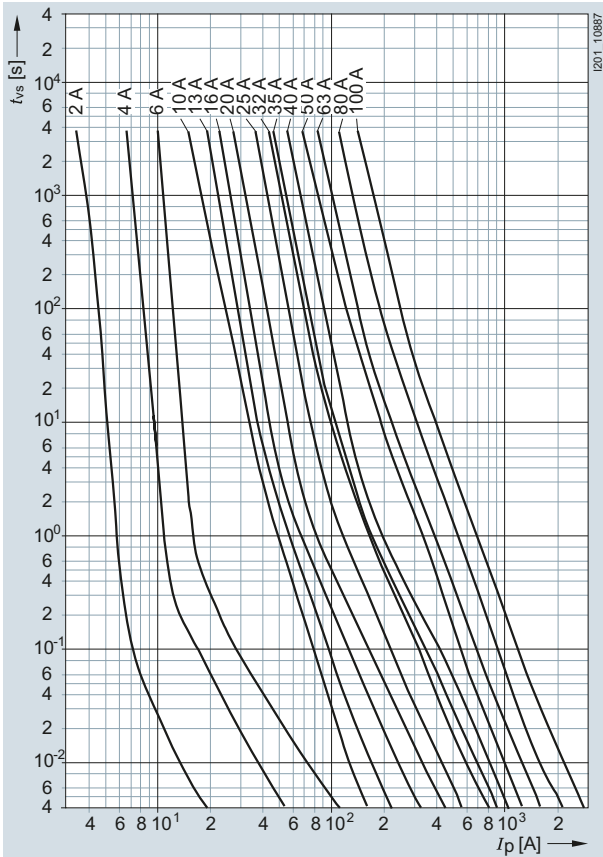

Melting I^2t values diagram

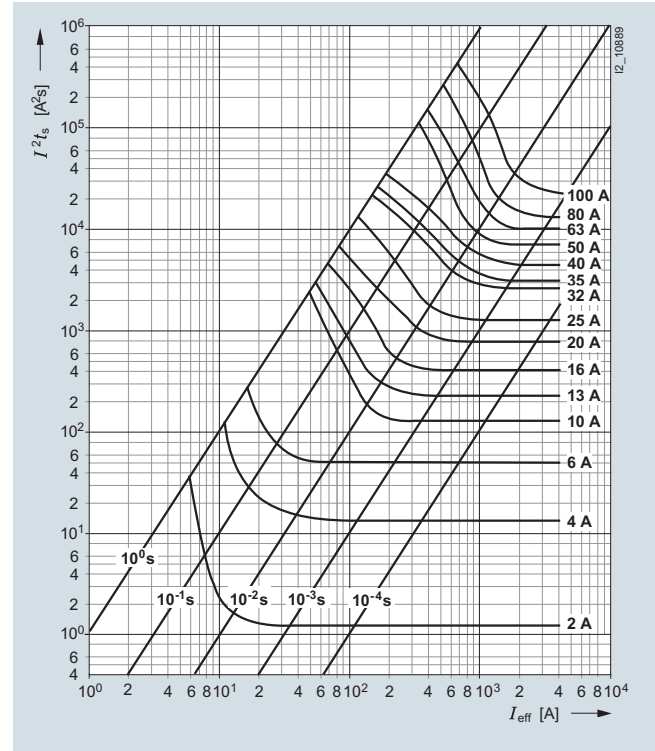
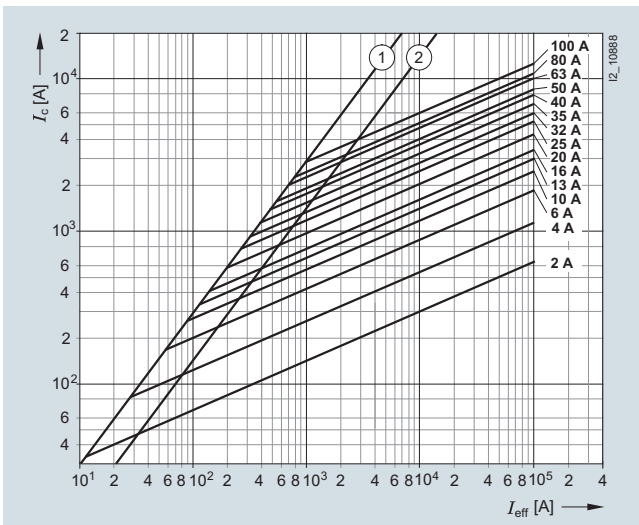

Table see page 14.

Current limiting diagram



- ① Peak short-circuit current with largest DC component
- ② Peak short-circuit current without DC component

Fuse Systems

NEOZED Fuse Systems

NEOZED fuse links

Series 5SE2

Sizes: D01, D02, D03
 Operational class: gG
 Rated voltage: 400 V AC/250 V DC
 Rated current: 2 ... 100 A

Type	I_n	P_v	$\Delta\theta$	I^2t_s		I^2t_a	
	A	W	K	1 ms A ² s	4 ms A ² s	230 V AC ($t \leq 4$ ms) A ² s	400 V AC A ² s
5SE2302	2	1.6	19	1.2	1.4	2.9	3.9
5SE2304	4	1.3	14	12.5	13.6	22	30
5SE2306	6	1.7	19	46.7	48	58	75
5SE2310	10	1.3	16	120	136	220	280
5SE2013-2A	13	2.0	23	220	244	290	370
5SE2316	16	2.1	24	375	410	675	890
5SE2320	20	2.4	26	740	810	1250	1650
5SE2325	25	3.2	33	1210	1300	1900	2600
5SE2332	32	3.6	34	2560	2800	4300	5500
5SE2335	35	3.8	36	3060	3500	5100	6500
5SE2340	40	4.0	37	4320	4800	7900	9500
5SE2350	50	4.2	38	6750	7400	10500	13000
5SE2363	63	5.3	45	10000	10900	16000	20500
5SE2280	80	5.3	43	13000	15400	25000	34500
5SE2300	100	6.4	47	22100	30000	46000	60000

Overview

The DIAZED fuse system is one of the oldest fuse systems in the world. It was developed by Siemens as far back as 1906. It is still the standard fuse system in many countries to this day. It is particularly widely used in the harsh environments of industrial applications.

The series is available with rated voltages from 500 V to 750 V.

All DIAZED bases must be fed from the bottom to ensure an insulated threaded ring when the fuse link is being removed. Reliable contact of the fuse links is only ensured when used together with DIAZED screw adapters.

The terminals of the DIAZED bases are available in different versions and designs to support the various installation methods.

The high-performing EZR bus-mounting system for screw fixing is an outstanding feature. The busbars, which are particularly suited for bus-mounting bases, have a load capacity of up to 150 A with lateral infeed.

DIAZED stands for **D**iametral gestuftes **z**weiteiliges Sicherungs-system mit **E**disongewinde (diametral two-step fuse system with Edison screw).

Benefits

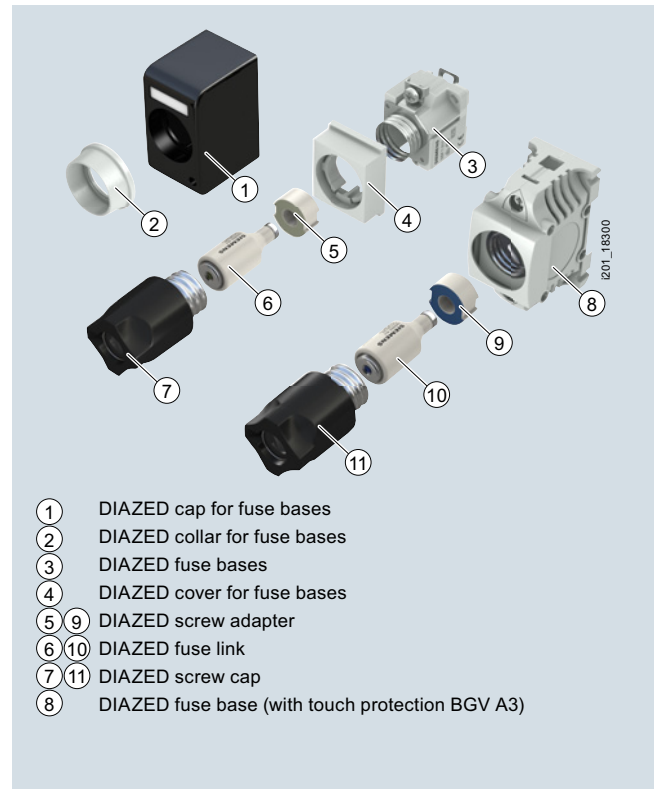

DIII fuse bases with terminal version BS

- Outgoing feeders (top), saddle terminal S
- Incoming feeders (bottom), clamp-type terminal B



NDZ fuse bases with terminal version KK

- Outgoing feeders (top), screw head contact K
- Incoming feeders (bottom), screw head contact K



DIII fuse bases with terminal version BB

- Outgoing feeders (top), clamp-type terminal B
- Incoming feeders (bottom), clamp-type terminal B



DIII fuse bases with terminal version SS

- Outgoing feeders (top), saddle terminal S
- Incoming feeders (bottom), saddle terminal S

Fuse Systems

DIAZED fuse systems

Technical specifications

		5SA, 5SB, 5SC, 5SD
Standards		IEC 60269-3; DIN VDE 0635; DIN VDE 0636-3; CEE 16
Operational class	Acc. to IEC 60269; DIN VDE 0636	gG
Characteristic	Acc. to DIN VDE 0635	Slow and quick
Rated voltage U_n	V AC V DC	500, 690, 750 500, 600, 750
Rated current I_n	A	2 ... 100
Rated breaking capacity	kA AC kA DC	50, 40 at E16 8, 1.6 at E16
Overvoltage category		III II (DIAZED fuse bases made of molded plastic for use at 690 V AC / 600 V DC)
Mounting position		Any, preferably vertical
Non-interchangeability		Using screw adapter or adapter sleeves
Degree of protection	Acc. to IEC 60529	IP20, with connected conductors ¹⁾
Resistance to climate	°C	Up to 45, at 95 % rel. humidity
Ambient temperature	°C	-5 to +40, humidity 90 % at 20

¹⁾ Degree of protection IP20 is tested according to regulations using a straight test finger (from the front), with the device mounted and equipped with a cover, housing or some other enclosure.

		Terminal version								
		B		K		S		R		
Size		DII	DIII	NDz	DII	DIII	DIII	DIV	DII	DIII
Conductor cross-sections										
• Rigid, min.	mm ²	1.5	2.5	1.0	1.5	2.5	2.5	10	1.5	1.5
• Rigid, max.	mm ²	10	25	6	10	25	25	50	35	35
• Flexible, with end sleeve	mm ²	10	25	6	10	25	25	50	35	35
Tightening torque										
• Screw M4	Nm	1.2							--	
• Screw M5	Nm	2.0							--	
• Screw M6	Nm	2.5							3.0	
• Screw M8	Nm	3.5							--	

Dimensional drawings

DIAZED fuse links

5SA1, 5SA2

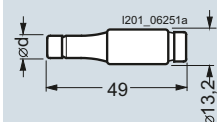

Size/thread	TNDz/E16, NDz/E16						
Rated current in A	2	4	6	10	16	20	25
Dimension d	6	6	6	8	10	12	14

5SB1, 5SB2

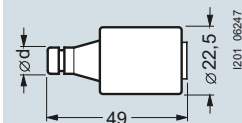

Size/thread	DII/E27						
Rated current in A	2	4	6	10	16	20	25
Dimension d	6	6	6	8	10	12	14

5SB3, 5SB4

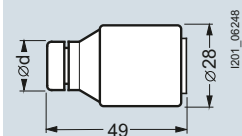

Size/thread	DIII/E33			
Rated current in A	32	35	50	63
Dimension d	16	16	18	20

5SC1, 5SC2

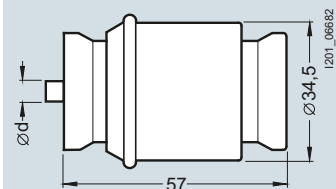

Size/thread	DIV/R1¼"	
Rated current in A	80	100
Dimension d	5	7

5SD6, 5SD8

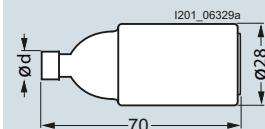

Size/thread	DIII/E33									
Rated current in A	2	4	6	10	16	20	25	35	50	63
Dimension d	6	6	6	8	10	12	14	16	18	20

Fuse Systems

DIAZED fuse systems

DIAZED fuse bases made of ceramic

5SF1

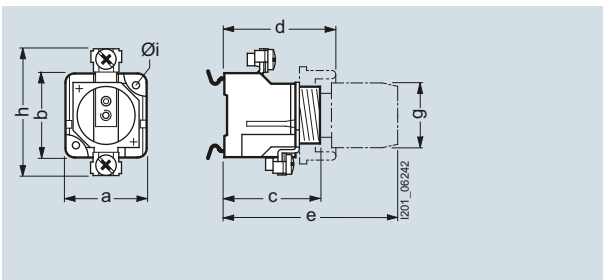

Version Type	Connection type	Dimensions							
		a	b	c	d	e	Øg	h	Øi
NDz/25 A 5SF1012	KK	29	49	44.6	55	75	32	49	--
DII/25 A 5SF1005 5SF1024	BB	38.4	41	46.6	53	83	34	63	--
	BB	38.4	41	46.6	53	83	34	63	4.3
DIII/63 A 5SF1205 5SF1215 5SF1224	BS	45.5	46	47	54	83	43	78	--
	SS	45.5	46	47	54	83	43	78	--
	BS	45.5	46	47	54	83	43	78	4.3
DIV/100 A 5SF1401	Flat terminal	68	68	--	79	110	65	116	6.5

5SF4230

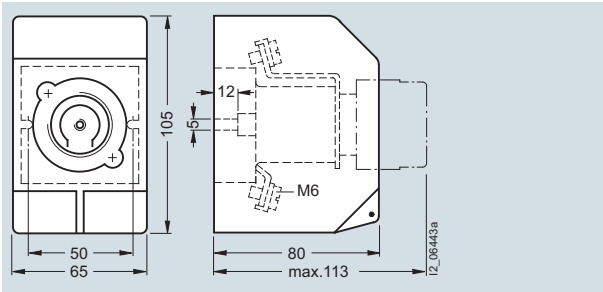

DIAZED fuse bases made of molded plastic

5SF1, 5SF5

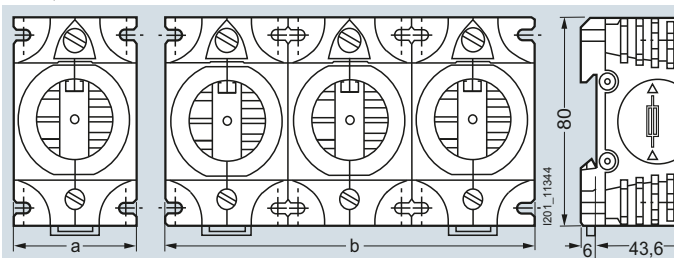

Type	Dimensions	
	a	b
5SF1060	40	--
5SF1260	50	--
5SF5068	--	120
5SF5268	--	150

DIAZED EZR bus-mounting bases

5SF6005

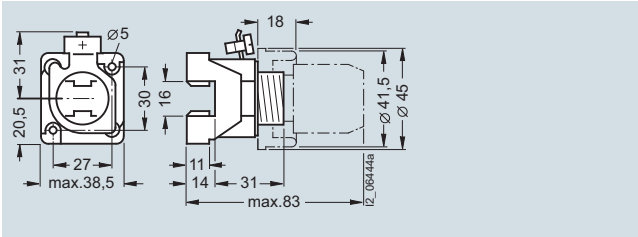

5SF6205

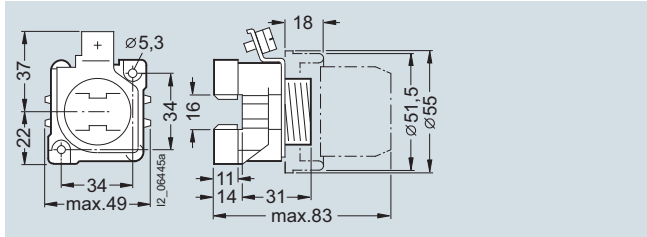

DIAZED screw caps/cover rings made of molded plastic/ceramic

Screw caps

5SH1

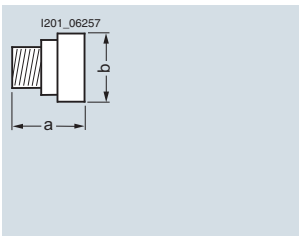

Cover rings

5SH3

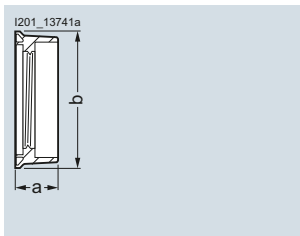

Size/thread	Screw caps		Cover rings		
	Type	Dimensions a Øb	Type	Dimensions a Øb	
NDz/E16	5SH1112	36 24			
	5SH1221	42 33	5SH3401	17.5	39.5
	5SH112	45.5 34	5SH332	17.5	41.5
DII/E27	5SH122	43 39			
	5SH1231	42 40	5SH3411	17.5	49.5
	5SH113	45.5 43	5SH334	19	51.5
	5SH123	47 45			
	5SH1161	48 48			
	5SH1170	68 43			

DIAZED caps made of molded plastic

5SH2

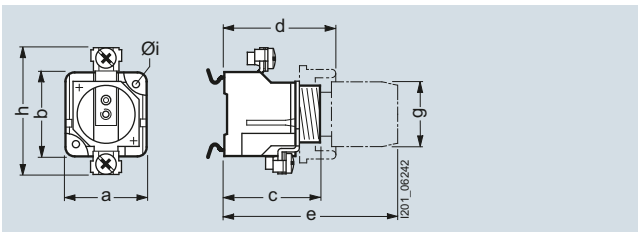

Size/thread	Type	Dimensions			
		a _{max}	b _{max}	c _{max}	d _{max}
NDz/E16	5SH201	33	68	51.7	75
	5SH202	43	74.7	53.6	83
DIII/E33	5SH222	51	90.5	53.6	83

Fuse Systems

DIAZED fuse systems

Characteristic curves

Series 5SA2

Size: E16
 Characteristics: Slow
 Rated voltage: 500 V AC/500 V DC
 Rated current: 2 ... 25 A

Time/current characteristics diagram

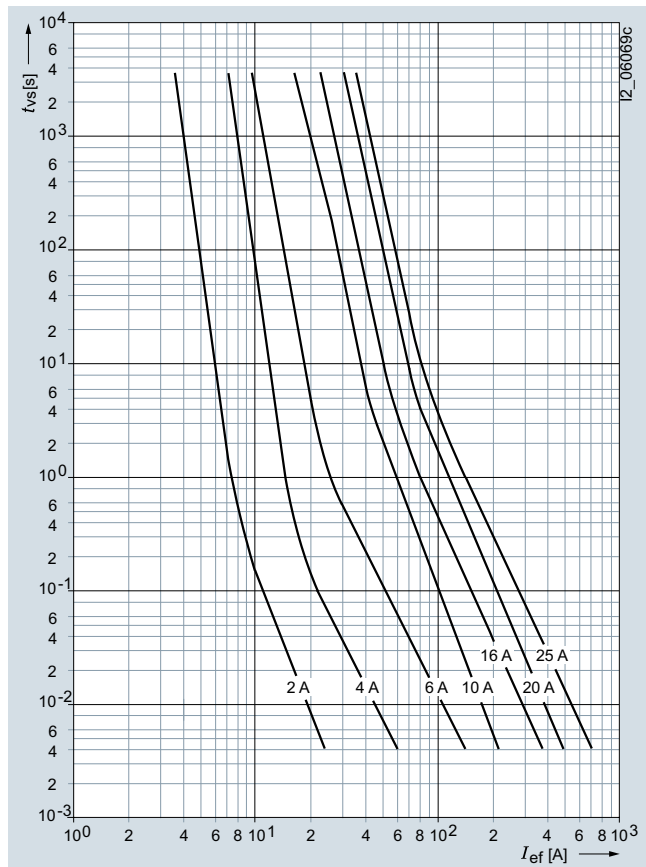

Melting I²t values diagram

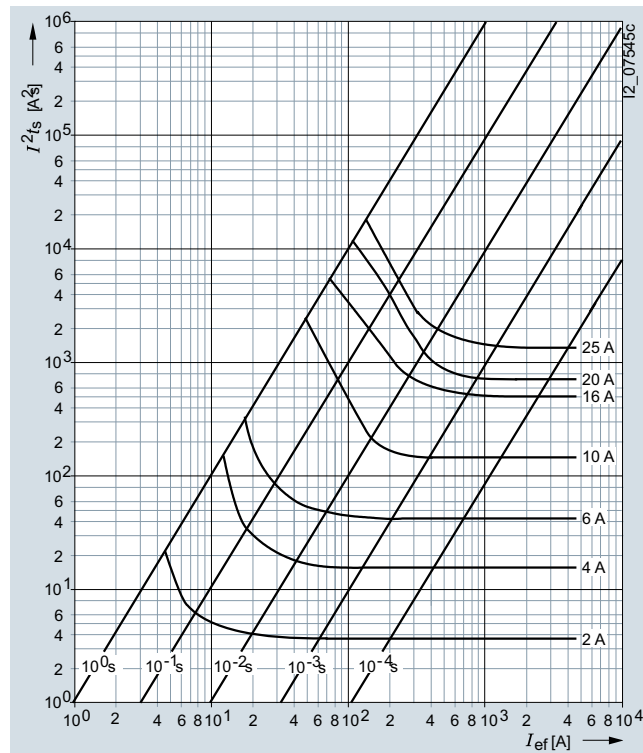

Current limiting diagram

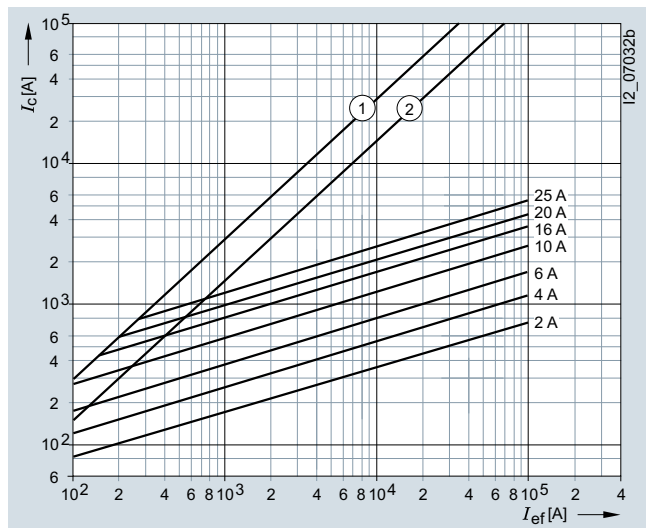

- ① Peak short-circuit current with largest DC component
- ② Peak short-circuit current without DC component

Type	I_n A	P_v W	$\Delta\theta$ K	I^2t_s 1 ms A ² s	4 ms A ² s
5SA211	2	0.85	15	1.2	2.3
5SA221	4	1.3	17	8.5	13
5SA231	6	1.9	14	40	80
5SA251	10	1.4	17	200	190
5SA261	16	2.4	30	290	550
5SA271	20	2.6	36	470	1990
5SA281	25	3.4	34	1000	2090

Type	I^2t_a 230 V AC A ² s	320 V AC A ² s	500 V AC A ² s
5SA211	6.6	7.8	0.7
5SA221	22	26	34
5SA231	66	76	100
5SA251	240	270	340
5SA261	890	950	1090
5SA271	1200	1350	1620
5SA281	2400	2600	3450

Series 5SB2, 5SB4, 5SC2

Size: DII, DIII, DIV
 Operational class: gG
 Rated voltage: 500 V AC/500 V DC
 Rated current: 2 ... 100 A

Time/current characteristics diagram

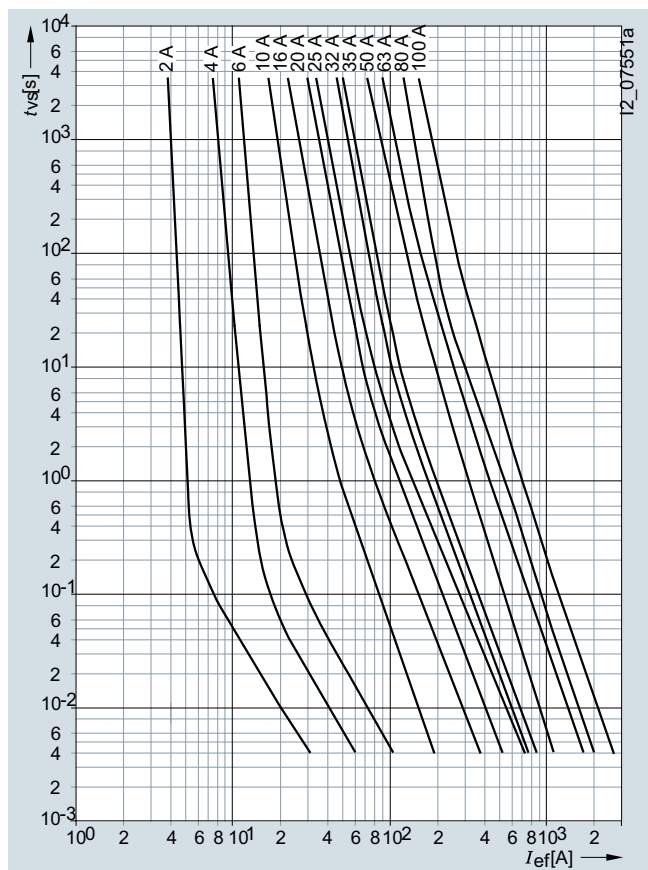

Melting I^2t values diagram

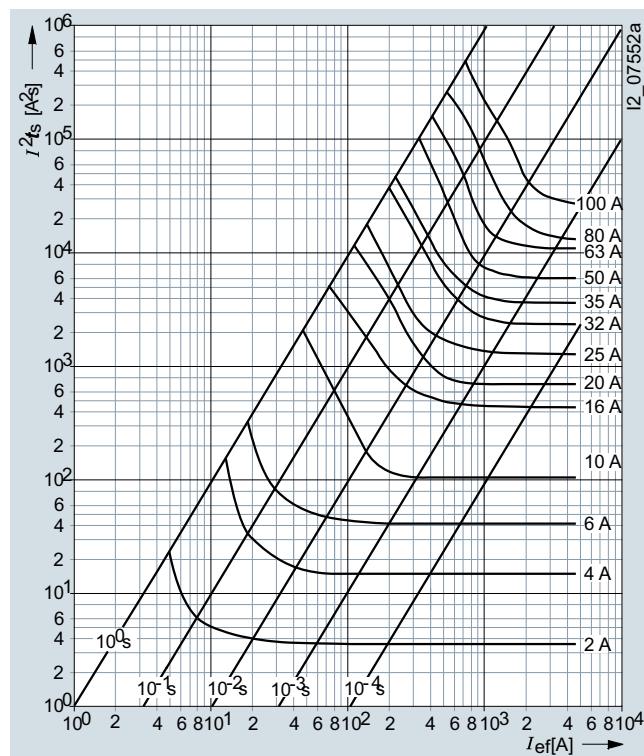

Current limiting diagram

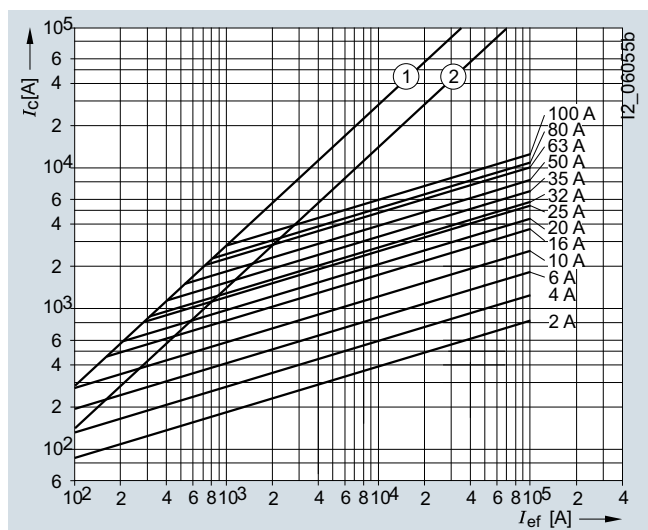

- ① Peak short-circuit current with largest DC component
- ② Peak short-circuit current without DC component

Type	I_n	P_V	$\Delta\theta$	I^2t_s	
	A	W	K	1 ms A ² s	4 ms A ² s
5SB211	2	2.6	15	3.7	3.9
5SB221	4	2.0	13	15	16
5SB231	6	2.2	14	42	45
5SB251	10	1.6	20	120	140
5SB261	16	2.4	23	500	580
5SB271	20	2.6	26	750	1100
5SB281	25	3.4	38	1600	2000
5SB4010	32	3.6	23	2300	2500
5SB411	35	3.7	25	3450	3000
5SB421	50	5.7	41	6500	5200
5SB431	63	6.9	48	11000	12000
5SC211	80	7.5	33	14600	16400
5SC221	100	8.8	46	28600	30000

Type	I^2t_a		
	230 V AC A ² s	320 V AC A ² s	500 V AC A ² s
5SB211	6.6	8.8	10.7
5SB221	22	28	34
5SB231	66	85	100
5SB251	240	300	340
5SB261	890	1060	1090
5SB271	1200	1450	1620
5SB281	2400	3150	3450
5SB4010	3450	4150	4850
5SB411	5200	6200	7200
5SB421	9750	12350	14500
5SB431	16500	22200	26500
5SC211	23000	28500	32500
5SC221	44000	56000	65000

Fuse Systems

DIAZED fuse systems

Series 5SD8

Size: DIII
 Operational class: gG
 Rated voltage: 690 V AC/600 V DC
 Rated current: 2 ... 63 A

Time/current characteristics diagram

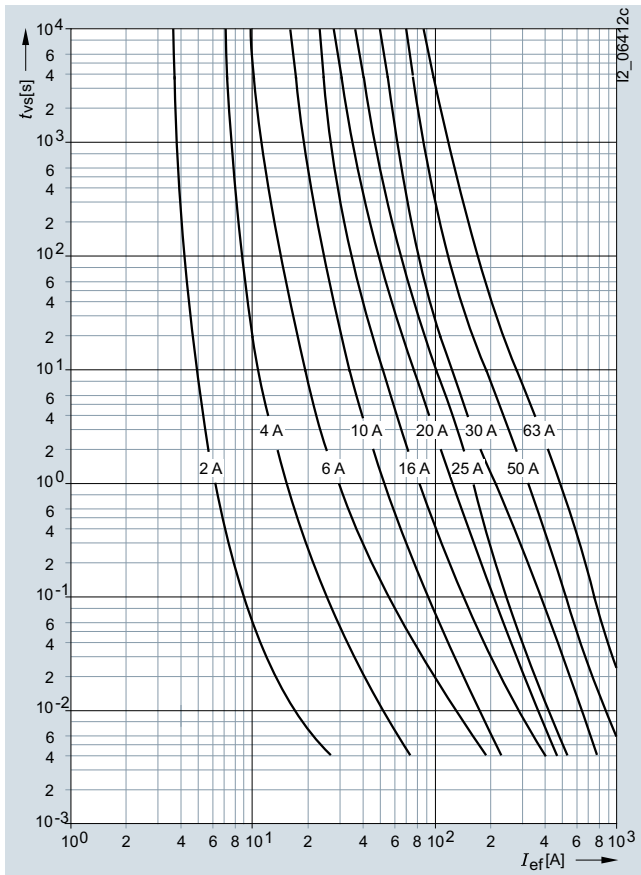

Melting I²t values diagram

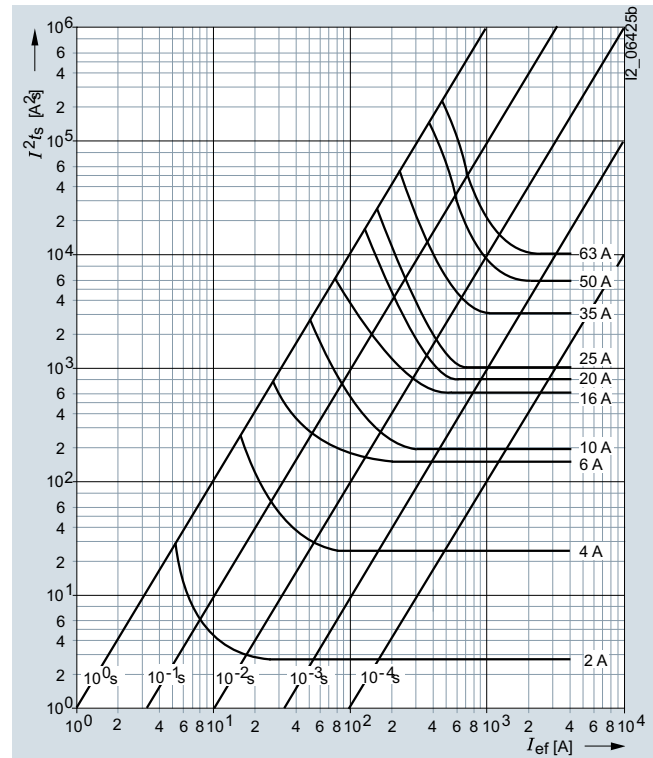

Current limiting diagram

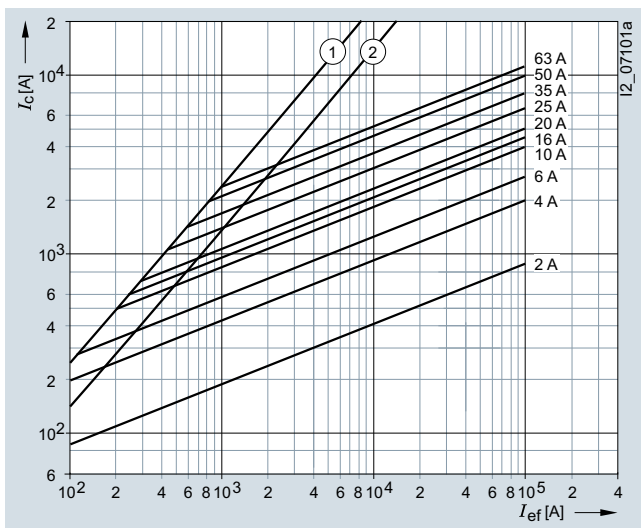

- ① Peak short-circuit current with largest DC component
- ② Peak short-circuit current without DC component

Type	I_n A	P_v W	I^2t_s 4 ms A ² s	I^2t_a 242 V AC A ² s
5SD8002	2	1	4.4	7
5SD8004	4	1.2	40	62
5SD8006	6	1.6	88	140
5SD8010	10	1.4	240	380
5SD8016	16	1.8	380	600
5SD8020	20	2	750	1200
5SD8025	25	2.3	2000	3200
5SD8035	35	3.1	3300	5100
5SD8050	50	4.6	7000	11000
5SD8063	63	5.5	9500	15000

Series 5SD6

Size: DIII
 Operational class: Quick (railway network protection)
 Rated voltage: 750 V AC/750 V DC
 Rated current: 2 ... 63 A

Time/current characteristics diagram

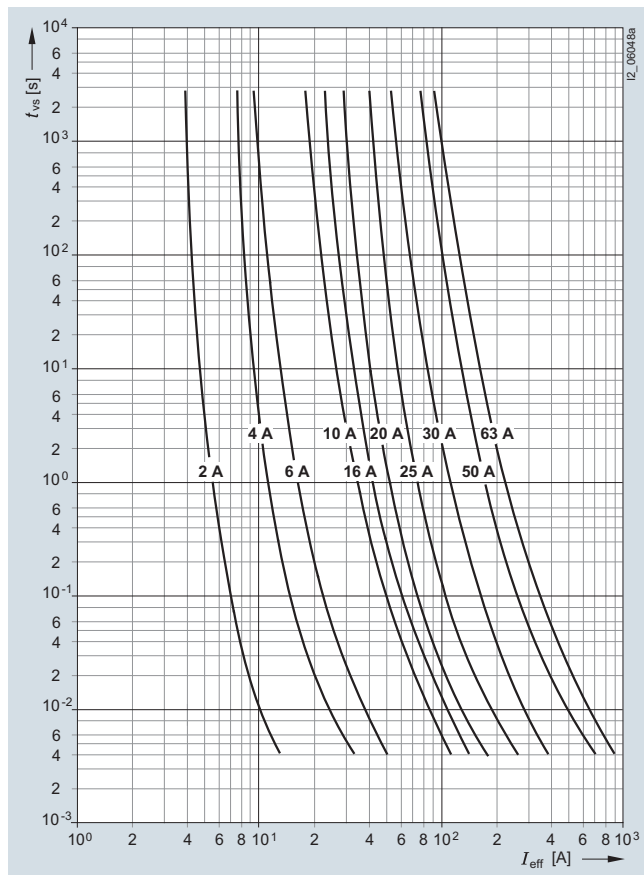

Melting I^2t values diagram

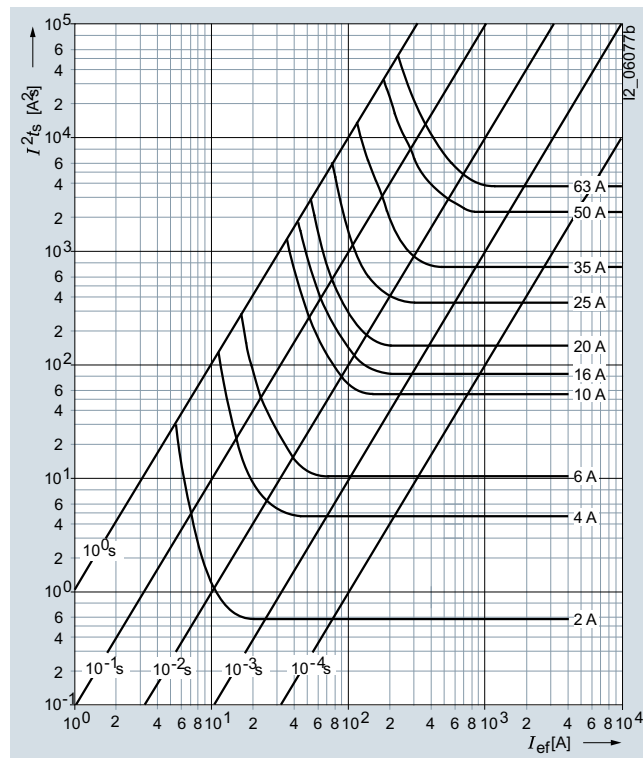

Current limiting diagram

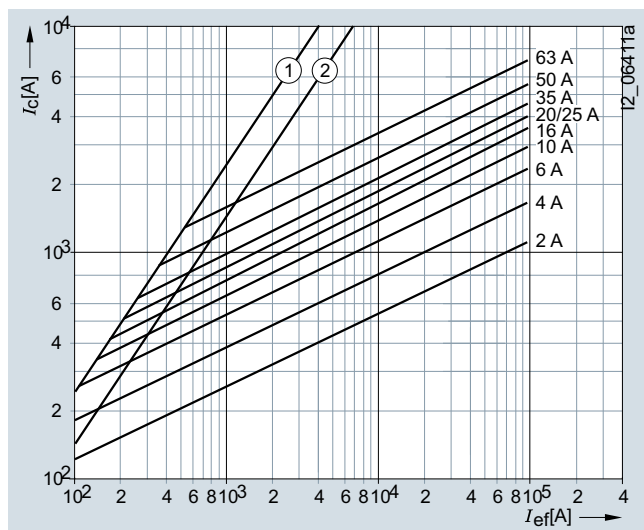

- ① Peak short-circuit current with largest DC component
- ② Peak short-circuit current without DC component

Type	I_n	P_V	I^2t_s	I^2t_a
	A		4 ms A^2s	500 V AC A^2s
5SD601	2	2.8	0.7	2
5SD602	4	4	4.5	13
5SD603	6	4.8	10	29
5SD604	10	4.8	50	135
5SD605	16	5.9	78	220
5SD606	20	6.3	125	380
5SD607	25	8.3	265	800
5SD608	35	13	550	1600
5SD610	50	16.5	1800	5500
5SD611	63	18	3100	9600

Fuse Systems

Cylindrical Fuse Systems

Cylindrical fuse links and cylindrical fuse holders

Overview

Cylindrical fuses are standard in Europe. There are a range of different cylindrical fuse links and holders that comply with the standards IEC 60269-1, -2 and -3, and which are suitable for use in industrial applications. In South West Europe they are also approved for use in residential buildings.

The cylindrical fuse holders are also approved according to UL 512. The cylindrical fuse holders are tested and approved as fuse disconnectors according to the switching device standard IEC 60947-3. They are not suitable for switching loads.

Cylindrical fuse holders can be supplied with or without signal detectors. In the case of devices with signal detector, a small electronic device with LED is located behind an inspection window in the plug-in module. If the inserted fuse link is tripped, this is indicated by the LED flashing.





The switching state of the fuse holder can be signaled over a laterally retrofitted auxiliary switch, which enables the integration of the fuses in the automation process.

Benefits

- Devices with pole number 1P+N are available in a single modular width. This reduces the footprint by 50 %
- The sliding catch for type ranges 8 x 32 mm and 10 x 38 mm enables the removal of individual devices from the assembly
- Space for a spare fuse in the plug-in module enables the fast replacement of fuses. This saves time and money and increases system availability
- A flashing LED signals that a fuse link has been tripped. This enables fast detection during runtime

Technical specifications

		Cylindrical fuse links						
		3NW63..	3NW60..	3NW61..	3NW62..	3NW80..	3NW81..	3NW82..
Size	mm x mm	8 x 32	10 x 38	14 x 51	22 x 58	10 x 38	14 x 51	22 x 58
Standards		IEC 60269-1, -2, -3; NF C 60-200; NF C 63-210, -211; NBN C 63269-2, CEI 32-4, -12						
Operational class		gG					aM	
Rated voltages U_n	V AC	400	400 or 500					
Rated current I_n	A	2 ... 20	0.5 ... 32	4 ... 50	8 ... 100	0.5 ... 32	2 ... 50	10 ... 100
Rated breaking capacity								
• 500 V versions	kA AC	--	120	100		120	100	
• 400 V versions	kA AC	20	120	20		120	20	
Mounting position		Any, preferably vertical						

		Cylindrical fuse holders			
		3NW73..	3NW70..	3NW71..	3NW72..
Size	mm x mm	8 x 32	10 x 38	14 x 51	22 x 58
Standards		IEC 60269-1, -2, -3; NF C 60-200, NF C 63-210, -211; NBN C 63269-2-1; CEI 32-4, -12; UL 4248-1			
Approvals	Acc. to UL Acc. to CSA	-- --	 	 	-- --
Rated voltage U_n	Acc. to UL/CSA V AC V AC	400 400	690 600		
Rated current I_n	A AC	20	32	50	100
Rated breaking capacity	kA	20	100		
Breaking capacity		AC-20B (switching without load), DC-20B			
• Utilization category					
No-voltage changing of fuse links		Yes			
Sealable when installed		Yes			
Mounting position		Any, preferably vertical			
Degree of protection	Acc. to IEC 60529	IP20, with connected conductors ¹⁾			
Terminals with touch protection according to BGV A3 at incoming and outgoing feeder		Yes			
Ambient temperature	°C	-5 to +40, humidity 90 % at +20			
Conductor cross-sections					
• Rigid	mm ²	0.5 ... 10		2.5 ... 10	4 ... 10
• Stranded	mm ²	0.5 ... 10		2.5 ... 25	4 ... 50
• Finely stranded, with end sleeve	mm ²	0.5 ... 10 ²⁾		2.5 ... 16	4 ... 35
• AWG (American Wire Gauge)	AWG	--	10 ... 20	6 ... 10	--
Tightening torque	Nm	1.2		2.0	2.5

¹⁾ Degree of protection IP20 is tested according to regulations using a straight test finger (from the front), with the device mounted and equipped with a cover, housing or some other enclosure.

²⁾ Max. cross-section 10 mm² with K28 crimper from Klauke.

Dimensional drawings

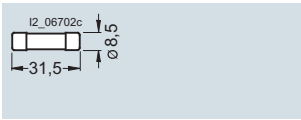

Size
8 × 32 mm

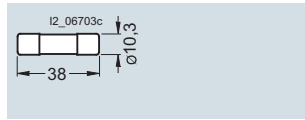

10 × 38 mm

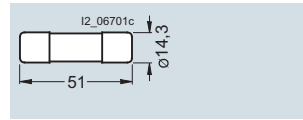

14 × 51 mm

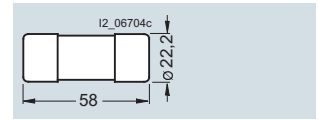

22 × 58 mm

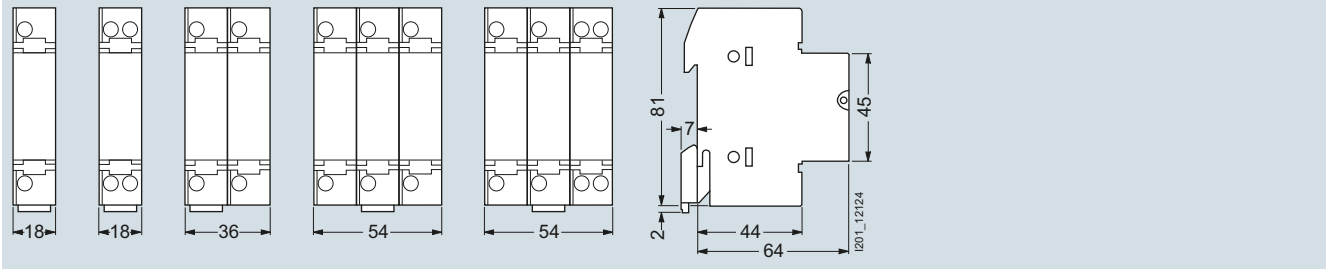

3NW70, 3NW73
1P 1P + N 2P 3P 3P+N

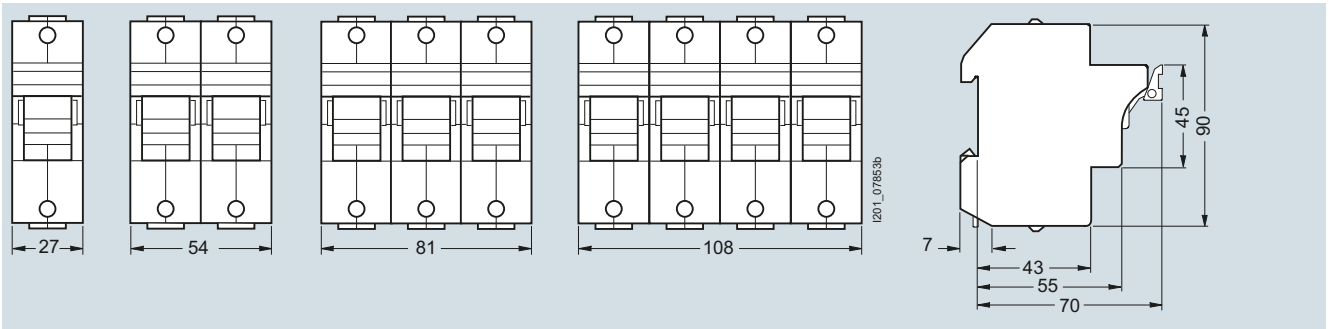

3NW71
1P 1P+N/2P 3P 3P+N

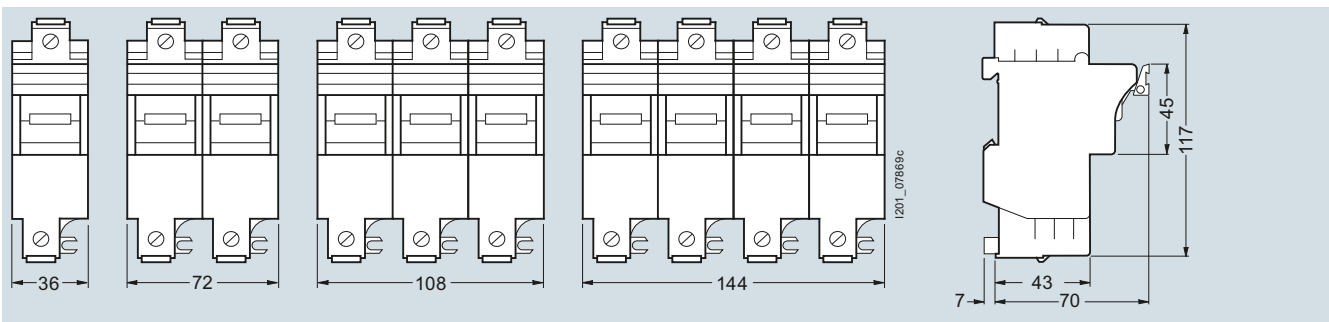

3NW72
1P 1P+N/2P 3P 3P+N

Auxiliary switches

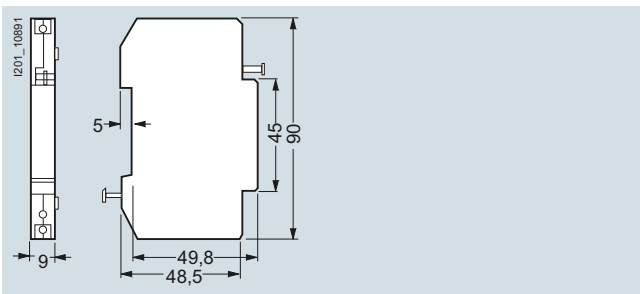

3NW7901
3NW7902

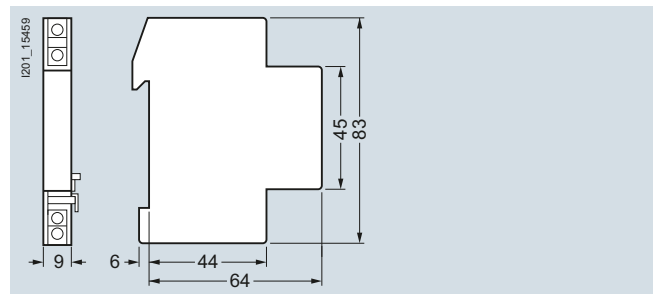

3NW7903

Fuse Systems

Cylindrical Fuse Systems

Cylindrical fuse links and cylindrical fuse holders

Circuit diagrams

Graphical symbols

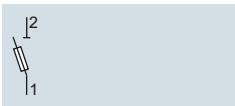

1P

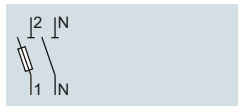

1P+N

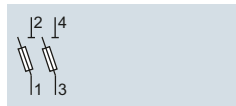

2P

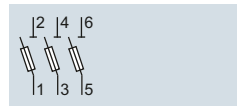

3P

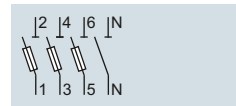

3P+N

Auxiliary switches

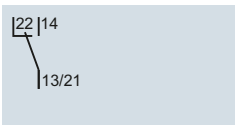
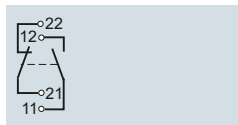
3NW7901
3NW7902

3NW7903

Characteristic curves

3NW60 series

Size: 10 × 38 mm
Operational class: gG
Rated voltage: 500 V AC (0.5 ... 25 A),
400 V AC (32 A)
Rated current: 2 ... 32 A

Time/current characteristics diagram

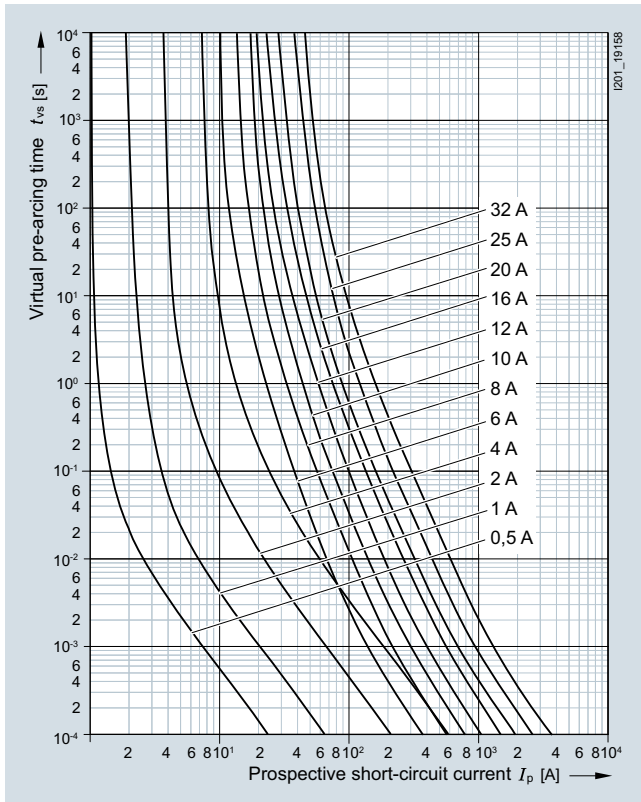

Melting I^2t values diagram

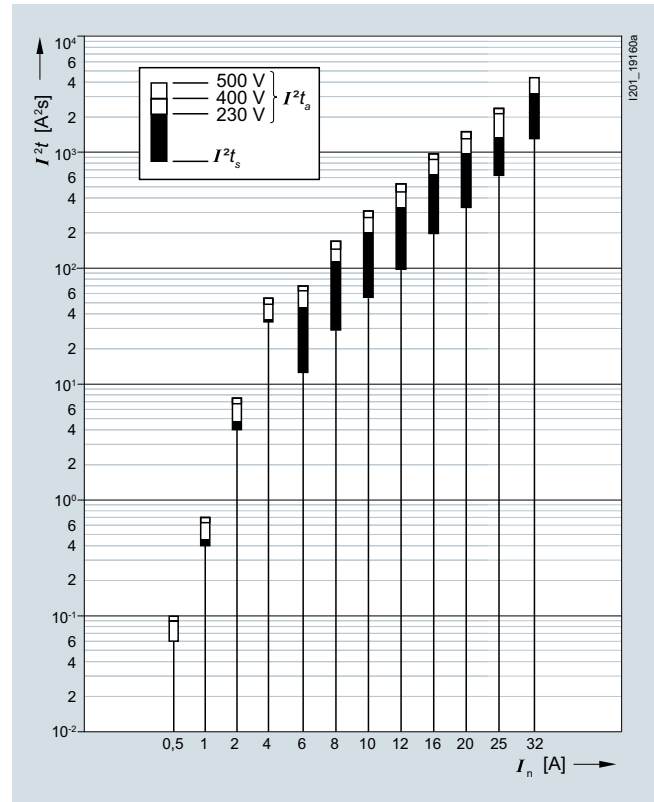

Current limiting diagram

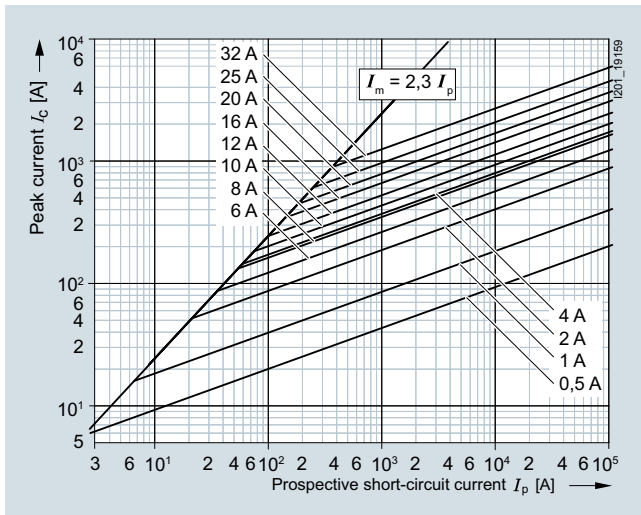

Type	I_n	P_v	$\Delta 9$	I^2t_s	I^2t_a			
	A	W	K	1 ms A^2s	230 V AC A^2s	400 V AC A^2s	500 V AC A^2s	
3NW6000-1	0.5	0.07	On req.	0.06	0.06	0.09	0.10	
3NW6011-1	1	0.45	On req.	0.50	0.45	0.63	0.7	
3NW6002-1	2	0.50	On req.	4	4.80	6.80	7.50	
3NW6004-1	4	0.85	On req.	34	35.70	49.50	55	
3NW6001-1	6	0.95	On req.	12.5	45.50	63	70	
3NW6008-1	8	1.15	On req.	29	10	153	170	
3NW6003-1	10	1.30	On req.	56	201	279	310	
3NW6006-1	12	1.40	On req.	99	344	477	530	
3NW6005-1	16	1.90	On req.	199	630	873	970	
3NW6007-1	20	2.40	On req.	333	975	1350	1500	
3NW6010-1	25	2.70	On req.	619	1560	2160	2400	
3NW6012-1	32	2.80	On req.	1331	3250	4500	--	

- ① Peak short-circuit current with largest DC component
- ② Peak short-circuit current without DC component

Fuse Systems

Cylindrical Fuse Systems

Cylindrical fuse links and cylindrical fuse holders

3NW61series

Size: 14 × 51 mm
 Operational class: gG
 Rated voltage: 500 V AC (4 ... 40 A),
 400 V AC (50 A)
 Rated current: 4 ... 50 A

Time/current characteristics diagram

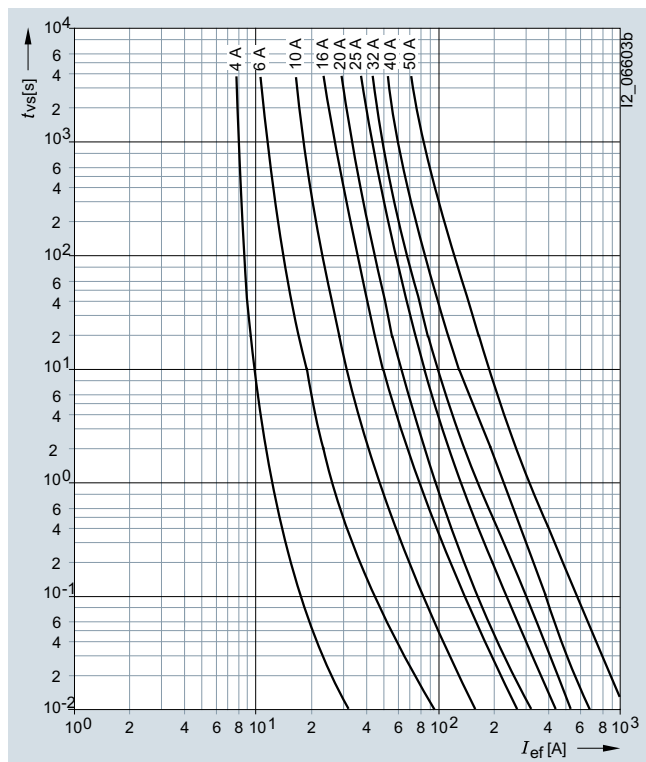

Melting I²t values diagram

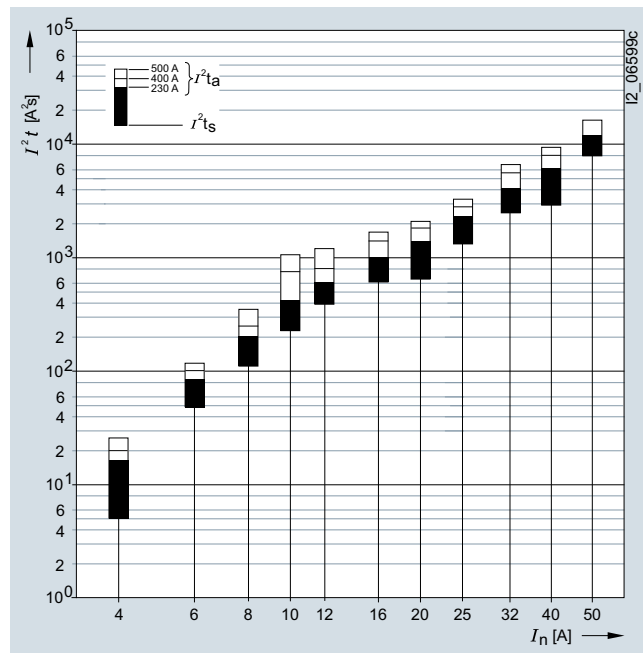

Current limiting diagram

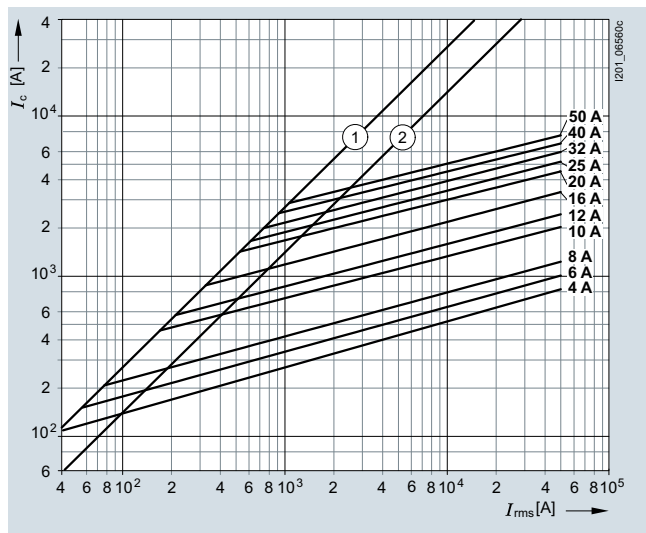

- ① Peak short-circuit current with largest DC component
- ② Peak short-circuit current without DC component

Type	I _n	P _v	Δθ	I ² t _s	I ² t _a	400 V AC	500 V AC
	A	W	K	1 ms A ² s	230 V AC A ² s		
3NW6104-1	4	1.9	19	5	16	20	26
3NW6101-1	6	2.5	25	48	85	100	120
3NW6108-1	8	2.4	18	110	200	250	350
3NW6103-1	10	0.8	12	230	420	750	1050
3NW6106-1	12	1.0	16	390	600	800	1200
3NW6105-1	16	1.6	27	600	1000	1400	1700
3NW6107-1	20	2.3	32.5	670	1400	1800	2100
3NW6110-1	25	2.2	31.5	1300	2300	2800	3200
3NW6112-1	32	3.2	39.5	2500	4100	5500	6500
3NW6117-1	40	4.5	48	3600	6100	8000	9200
3NW6120-1	50	4.8	55	8000	12200	16000	--

3NW62 series

Size: 22 × 58 mm
Operational class: gG
Rated voltage: 500 V AC (8 ... 80 A),
400 V AC (100 A)
Rated current: 8 ... 100 A

Time/current characteristics diagram

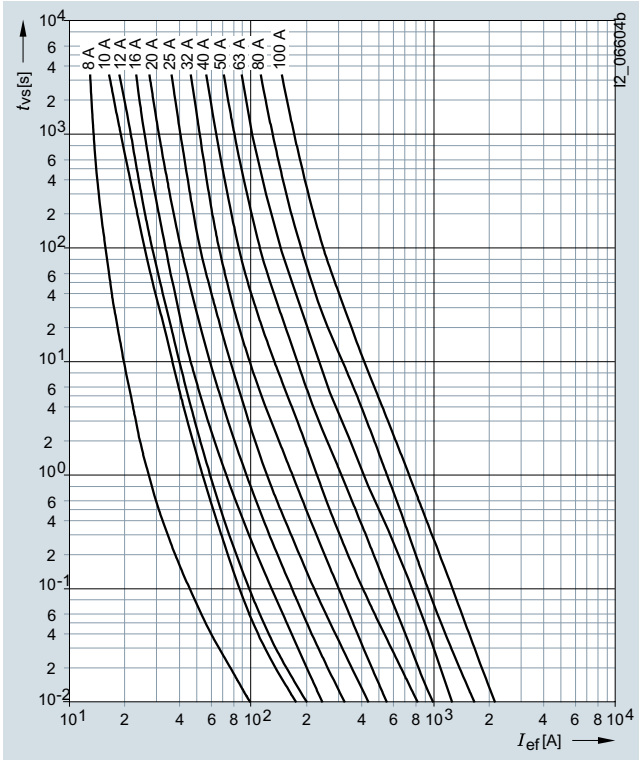

Melting I²t values diagram

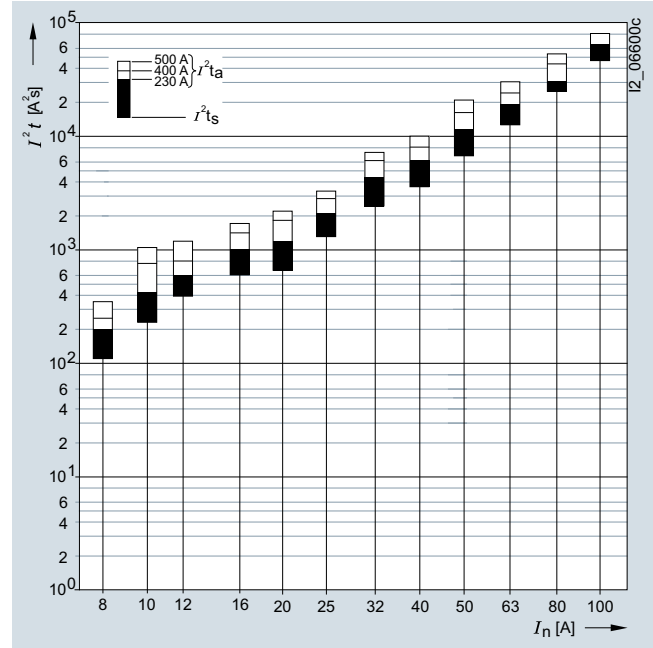

Current limiting diagram

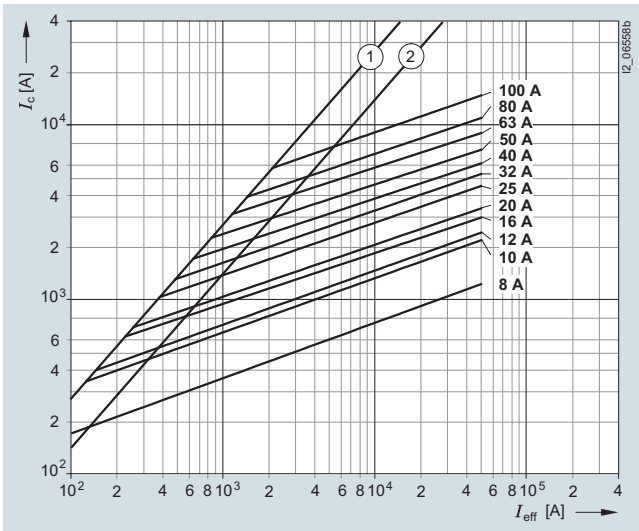

- ① Peak short-circuit current with largest DC component
- ② Peak short-circuit current without DC component

Type	I_n	P_v	$\Delta\theta$	I^2t_s	I^2t_a		
	A	W	K	1 ms A²s	230 V AC A²s	400 V AC A²s	500 V AC A²s
3NW6208-1	8	2.5	15	110	200	170	350
3NW6203-1	10	0.9	10.5	230	420	760	1050
3NW6206-1	12	1.1	12	390	600	800	1200
3NW6205-1	16	1.6	14.5	600	1000	1400	1700
3NW6207-1	20	2.4	22.5	670	1200	1800	2200
3NW6210-1	25	2.7	24	1300	2100	2800	3300
3NW6212-1	32	3.2	28	2450	4400	6100	7200
3NW6217-1	40	4.9	35	3600	6200	8000	10000
3NW6220-1	50	5.9	46	6800	11400	16200	20600
3NW6222-1	63	6.8	48	12500	18800	24000	30000
3NW6224-1	80	7.5	48	24700	30500	43000	52500
3NW6230-1	100	8.4	55	46000	64700	80000	--

Fuse Systems

Cylindrical Fuse Systems

Cylindrical fuse links and cylindrical fuse holders

3NW630.-1 series

Size: 8 × 32 mm
 Operational class: gG
 Rated voltage: 400 V AC
 Rated current: 2 ... 20 A

Time/current characteristics diagram

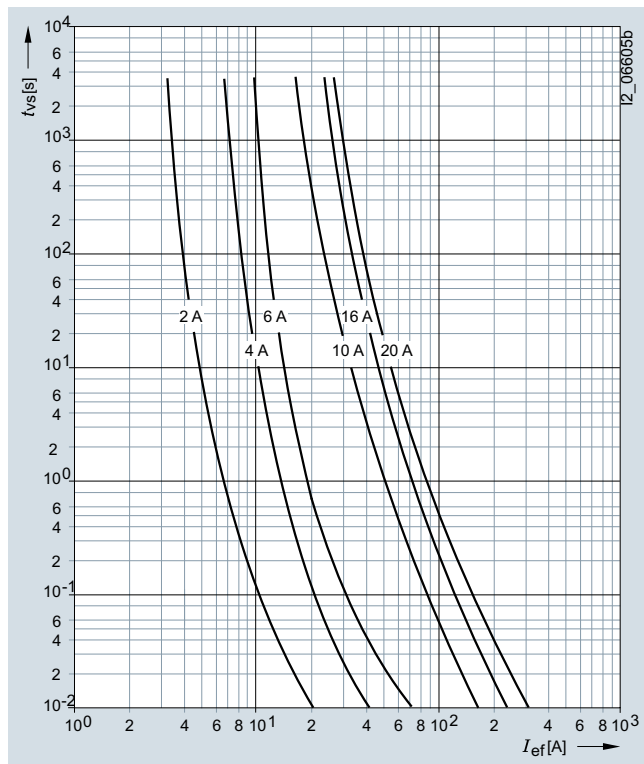

Melting I²t values diagram

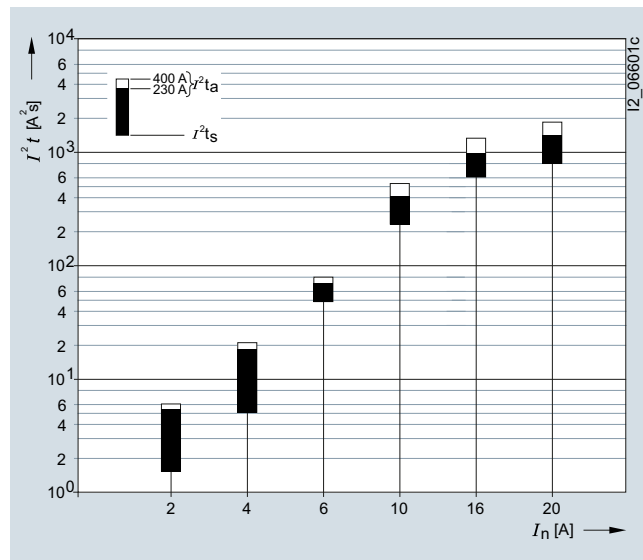

Type	I_n A	P_v W	$\Delta\theta$ K	I^2t_s 1 ms A ² s	I^2t_a 400 V AC A ² s
3NW6302-1	2	2	27	1.6	6
3NW6304-1	4	1.5	19	5	21
3NW6301-1	6	1.5	20.5	48	85
3NW6303-1	10	0.7	15	230	530
3NW6305-1	16	1.1	29	600	1400
3NW6307-1	20	1.7	34.5	790	1800

Current limiting diagram

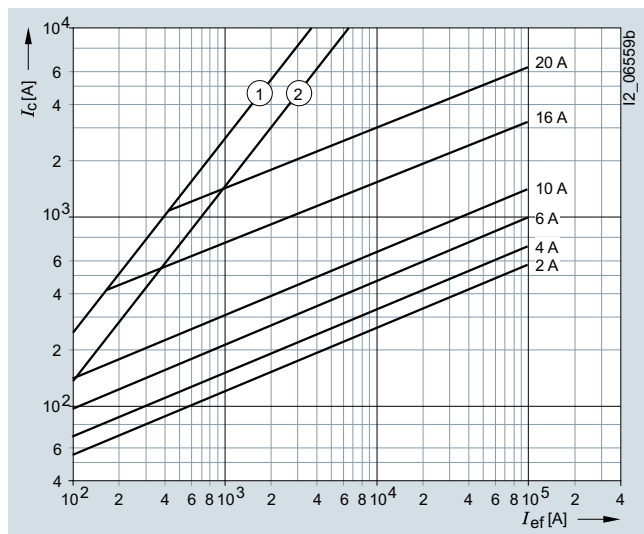

- ① Peak short-circuit current with largest DC component
- ② Peak short-circuit current without DC component

3NW8 series

Size: 10 × 38 mm, 14 × 51 mm, 22 × 58 mm
 Operational class: aM
 Rated voltage: 500 V AC,
 400 V AC (3NW8120-1, 3NW8230-1)
 Rated current: 0.5 ... 100 A

Time/current characteristics diagram

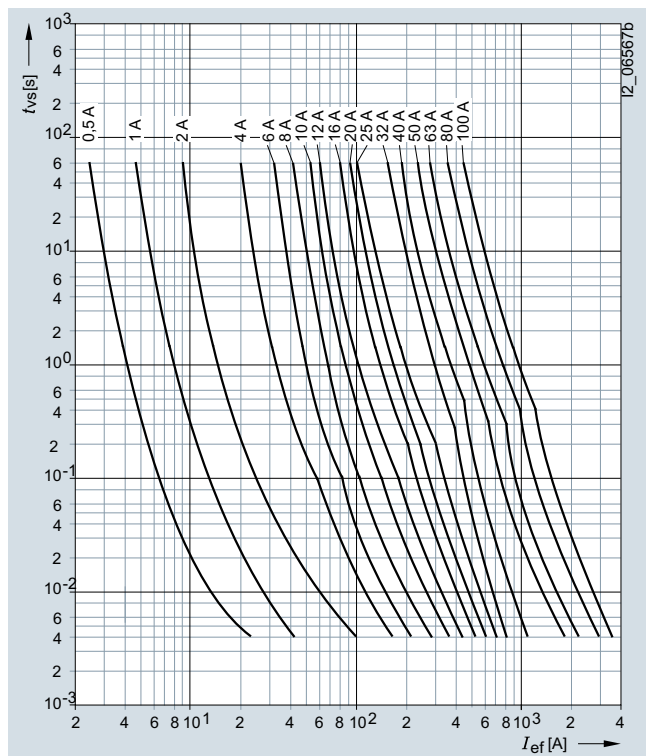

Current limiting diagram

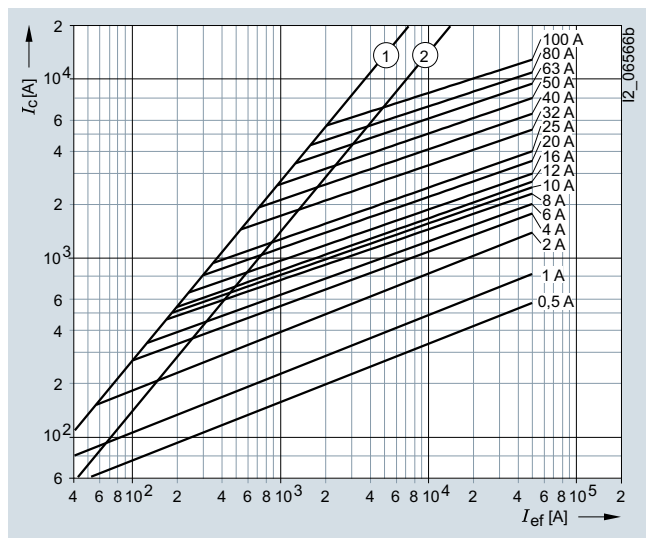

- ① Peak short-circuit current with largest DC component
- ② Peak short-circuit current without DC component

Melting I^2t values diagram

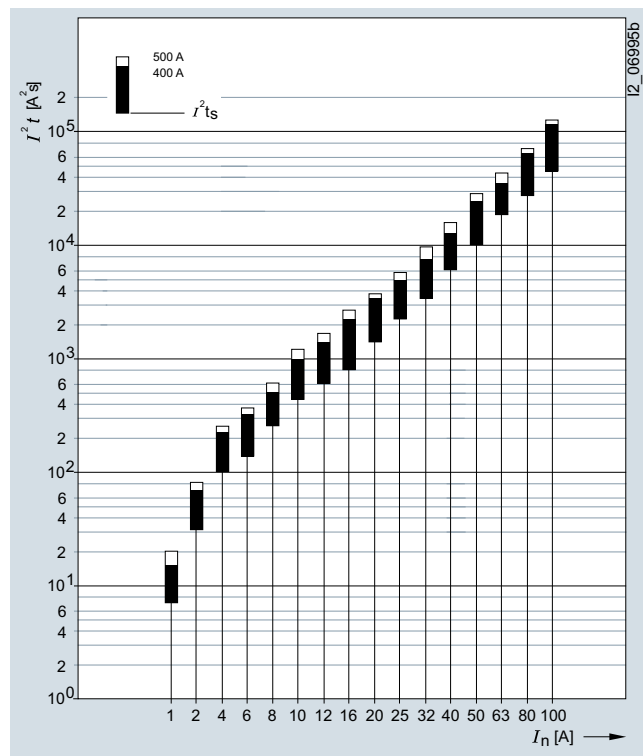

Type	Size mm	BK	I_n A	U_n V	P_V W			
3NW8000-1	10 x 38	aM	0.5	500	0.1			
3NW8011-1			1		0.1			
3NW8002-1			2		0.1			
3NW8004-1			4		0.3			
3NW8001-1	14 x 51		6	400	0.4			
3NW8008-1			8		0.6			
3NW8003-1			10		0.6			
3NW8006-1			12		0.8			
3NW8005-1			165		0.9			
3NW8007-1			20		1.1			
3NW8010-1			25		1.2			
3NW8012-1			32		1.8			
3NW8102-1			14 x 51			2	690	1
3NW8104-1						4		0.3
3NW8101-1						6		0.3
3NW8108-1						8		0.5
3NW8103-1	10	0.6						
3NW8106-1	12	0.6						
3NW8105-1	16	1						
3NW8107-1	20	1						
3NW8110-1	25	1.3						
3NW8112-1	32	1.9						
3NW8117-1	40	2						
3NW8120-1	50	3.7						
3NW8208-1	22 x 58		8	500	No info.			
3NW8203-1			10		No info.			
3NW8206-1			12		No info.			
3NW8205-1			16		0.9			
3NW8207-1			20		1.1			
3NW8210-1			25		1.4			
3NW8212-1			32		2			
3NW8217-1			40		2.5			
3NW8220-1			50		2.6			
3NW8222-1			63		4.1			
3NW8224-1			80		4.9			
3NW8230-1			100		5.6			

Fuse Systems

Cylindrical Fuse Systems

Fuse holders in size 10 x 38 mm and Class CC

Overview

A key feature of our three-pole fuse holders is their ultra compact design. With a width of only 45 mm, they are ideal for use with fused motor starter combinations. Because the contactor and the fuse holder have the same 45 mm width, they are easy to mount on top of one another. The strong current-limiting fuses ensure a type 2 protection level (coordination according to IEC 60947-4, no damage protection) for the contactor.

The UL version has an SCCR value of 200 kA. The accessories are generally UL-certified.

Customers can mount an auxiliary switch which signals the switching state or prevents the fuse holder from switching off under load by interrupting the contactor control, thus increasing safety for the operator and process. Busbars and a matching three-phase feeder terminal complete the product range.

Benefits

- Compact design, especially for motor starter combinations
- For IEC fuses of size 10 x 38 mm up to 32 A and Class CC UL fuses up to 30 A
- Meets the requirements of UL 508 with regard to clearances
- UL-approved microswitches, busbars and adapters for 60 mm busbar systems
- Optical signal detector for fast fault locating







Compact cylindrical fuse holder Class CC with signal detector and mounted auxiliary switch





Installation configuration of a cylindrical fuse holder and a SIRIUS contactor on busbar device adapter for the 60 mm busbar system

Technical specifications

		Cylindrical fuse holders 3NW70...-1	Fuse holders 3NW75...-1HG
Size	mm x mm	10 x 38	Class CC
Standards		IEC 60269; UL4248-1; CSA	UL4248-1; CSA
Approvals		 UL File Number E171267 	 UL File Number E171267 
Rated voltage U_n	V AC	690	600
Rated current I_n	A AC	32	30
Rated short-circuit strength	kA	120 (at 500 V) 80 (at 690 V)	200
Breaking capacity		AC-20B (switching without load)	--
• Utilization category			
Rated impulse withstand voltage	kV	6	
Overvoltage category		III	
Pollution degree		2	
Max. power dissipation of the fuse link	W	3	
No-voltage changing of fuse links	°C	-5 to +40, humidity 90 % at +20	
Sealable when installed		Yes	
Lockable with padlock		Yes	
Mounting position		Any, preferably vertical	
Current direction		Any	
Degree of protection	Acc. to IEC 60529	IP20, with connected conductors ¹⁾	
Terminals with touch protection acc. to BGV A3 at incoming and outgoing feeder		Yes	
Ambient temperature	°C	-5 to +40, humidity 90 % at +20	
Conductor cross-sections			
• Finely stranded, with end sleeve	mm ²	1 ... 4	
• AWG cables (American Wire Gauge)	AWG	18 ... 10	
Tightening torque			
• Terminal screws	Nm	1.5	
	lb.in	13 PZ2	

¹⁾ Degree of protection IP20 is tested according to regulations using a straight test finger (from the front), with the device mounted and equipped with a cover, housing or some other enclosure.

		Auxiliary switches 3NW7903-1							
Standards		IEC 60947							
Approvals		  UL 508, UL File Number E334003							
Utilization category		AC-12	DC-13			AC-15			Acc. to UL
Rated voltage U_n	V AC	250	--	--	--	24	120	240	240
	V DC	--	24	120	240	--	--	--	--
Rated current I_n	A	5	2	0.5	0.25	4	3	1.5	5

		Busbars 5ST260.	
For cylindrical fuse holders		3NW70...-1	3NW75...-1HG
Pin spacing	mm	15	
Standards		EN 609741 (VDE 0660-100), IEC 60947-1:2004, UL 508, CSA 22.2	
Approvals		 UL 4248-1, UL File Number E337131	
Busbar material		E-Cu 58 F25	
Partition material		PA66-V0	
Lamp wire resistance/1.5 mm²	°C	960	
Insulation coordination		Overvoltage category III, degree of pollution 2	
Rated operating voltage U_n			
• Acc. to UL	V AC	--	600
• Acc. to IEC	V AC	690	--
Maximum busbar current I_n			
• Acc. to UL	A	--	65
• Acc. to IEC	A	80	--

Fuse Systems

Cylindrical Fuse Systems

Fuse holders in size 10 x 38 mm and Class CC

		Terminals 5ST2600	
For cylindrical fuse holders		3NW70...-1	3NW75...-1HG
Pin spacing	mm	15	
Standards		IEC 60999:2000, UL 508	
Approvals		Ⓢ, UL 4248-1, UL File Number E337131	
Enclosure/cover material		PA66-V0	
Lamp wire resistance/1 mm²	°C	960	
Temperature resistance PA66-V0, HDT B ISO 179, UL 94-V0/1.5	°C	200	
Insulation coordination		Overvoltage category III, degree of pollution 2	
Maximum operating voltage U_{max}			
• Acc. to UL	V AC	--	600
• Acc. to IEC	V AC	690	--
Maximum electrical load I_{max}			
• Acc. to UL	A	--	65
• Acc. to IEC	A	80	--
Rated current I_n	A	63	
Conductor cross-sections			
• Solid/stranded	mm ²	2.5 ... 35	
• Finely stranded, with end sleeve	mm ²	2.5 ... 25	
Tightening torque of clamping screw	Nm	2.5 ... 3.5	

Dimensional drawings

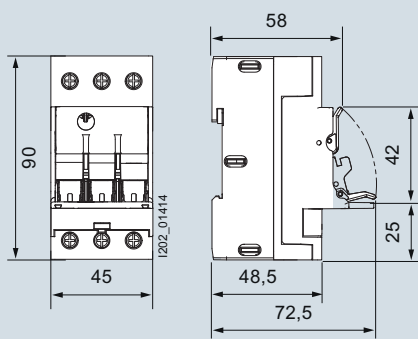

3NW703.-1
3NW753.-1HG

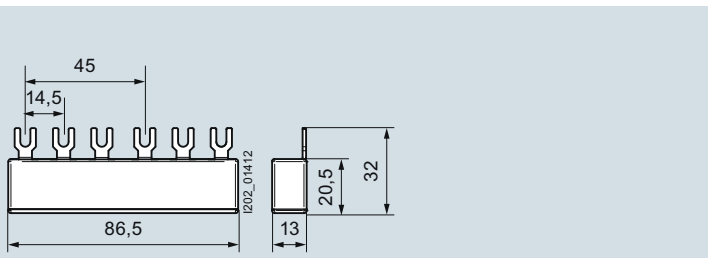

5ST260.

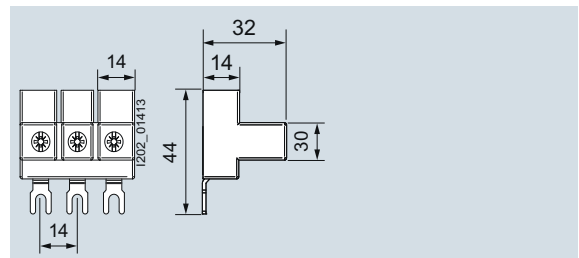

5ST2600

Circuit diagrams

Circuit diagrams

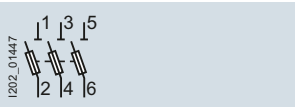

3NW703.-1
3NW753.-1HG

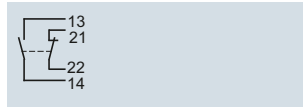

3NW7903-1

Fuse Systems

Class CC fuse systems

Overview

Class CC fuses are used for "branch circuit protection".

The enclosed fuse holders are designed and tested to comply with the US National Electrical Code NEC 210.20(A). This means that when subject to continuous operation, only 80 % of the rated current is permissible as operational current.

An operational current of 100 % of the rated current (30 A) is only permissible short-time.

The devices are prepared for the inscription labels of the ALPHA FIX terminal blocks 8WH8120-7AA15 and 8WH8120-7XA05.

There are three different series:

- Characteristic: slow 3NW1...-0HG
For the protection of control transformers, reactors, inductances. Significantly slower than the minimum requirements specified by UL for Class CC Fuses of 12 s at $2 \times I_n$.

- Characteristic: quick 3NW2...-0HG
For a wide range of applications, for the protection of lighting installations, heating, control systems.
- Characteristic: slow, current-limiting 3NW3...-0HG
Slow for overloads and quick for short circuits. High current limitation for the protection of motor circuits.

Note:

For class CC compact fuse holders for motor starter combinations, see [page 32](#).

Benefits

- For switchgear assemblies and machine manufacturers who export their systems to the USA or Canada
- Easier export due to UL and CSA approvals for typical applications
- Modern design with touch protection to BGV A3 ensures safe installation.

Technical specifications

		Class CC fuse holders 3NW75.3-0HG	
Standards		UL 4248-1; CSA C22.2	
Approvals		UL 4248-1; UL File Number E171267; CSA C22.2	
Rated voltage U_n	V AC	600	
Rated current I_n	A	30	
Rated conditional short-circuit current	kA	200	
Breaking capacity		AC-20B (switching without load)	
• Utilization category			
Max. power dissipation of the fuse link			
• With cable, 6 mm ²	W	3	
• With cable, 10 mm ²	W	4.3	
Rated impulse withstand voltage	kV	6	
Overvoltage category		II	
Pollution degree		2	
No-voltage changing of fuse links		Yes	
Sealable when installed		Yes	
Mounting position		Any	
Current direction		Any	
Degree of protection acc. to IEC 60529		IP20	
Terminals with touch protection acc. to BGV A3 at incoming and outgoing feeder		Yes	
Ambient temperature	°C	45	
Conductor cross-sections			
• Solid and stranded	mm ²	1.5 ... 16	
• AWG conductor cross-section, solid and stranded	AWG	15 ... 5	
Tightening torque	Nm	2.5 (22 lb.in)	

		Class CC fuse links		
		3NW1...-0HG	3NW2...-0HG	3NW3...-0HG
Standards		UL 248-4; CSA C22.2		
Approvals		UL 248-4; UL File Number E258218; CSA C22.2		
Characteristic		Slow	Quick	Slow, current limiting
Rated voltage	V AC	600	600	600
	V DC	--	--	150 (3 ... 15 A) 300 (< 3 A, > 15 A)
Rated breaking capacity	kA AC	200		

Dimensional drawings

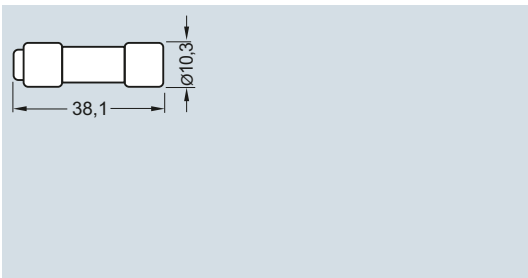

3NW1...-0HG
3NW2...-0HG
3NW3...-0HG

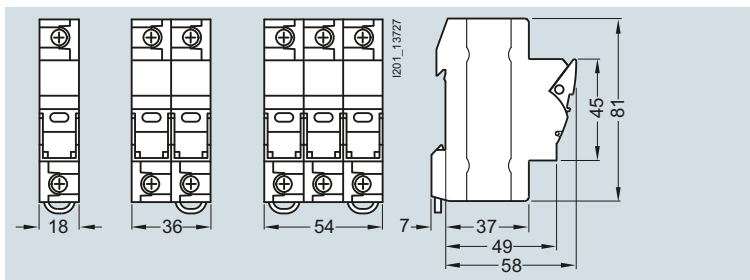

3NW75.3-0HG

Fuse Systems

Class CC fuse systems

Characteristic curves

3NW1...-0HG series

Time/current characteristics diagram

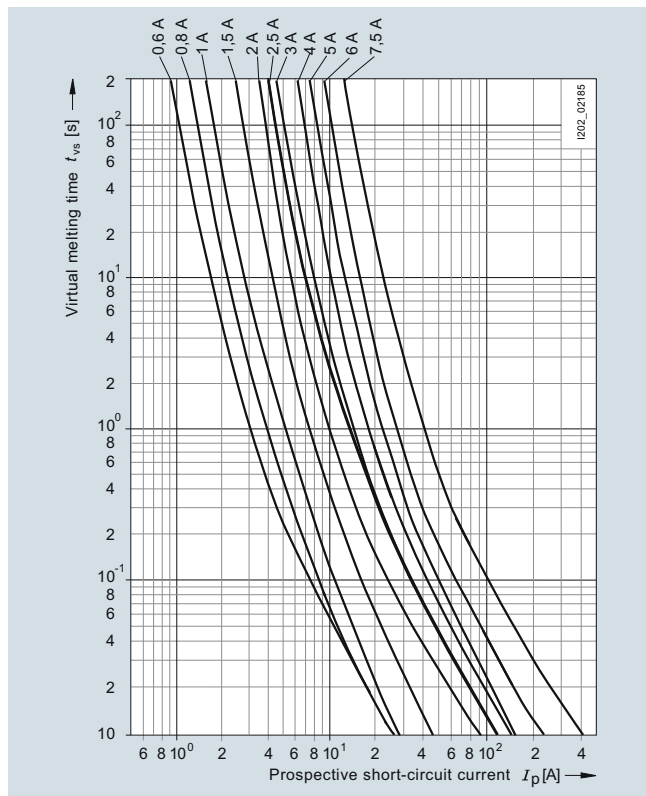

3NW2...-0HG series

Time/current characteristics diagram

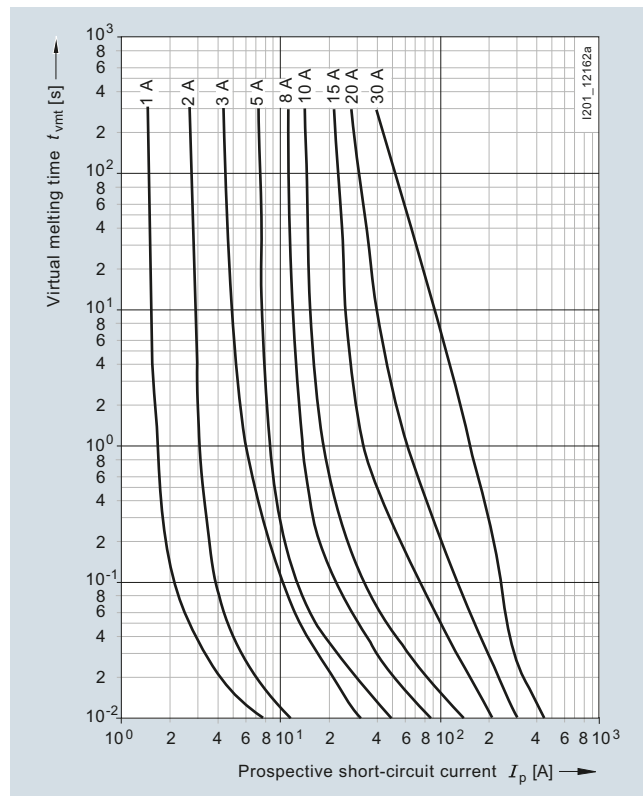

3NW1...-0HG series

Time/current characteristics diagram

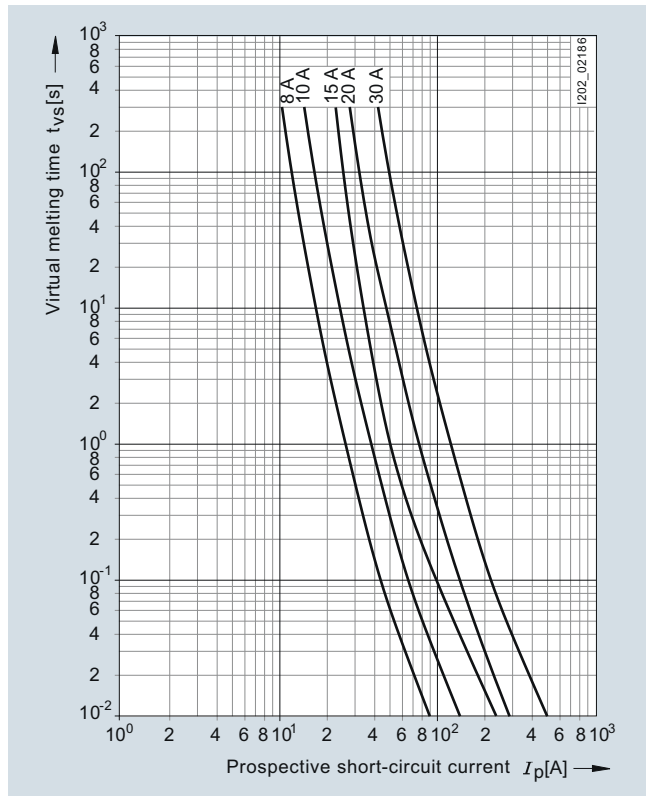

3NW3...-0HG series

Time/current characteristics diagram

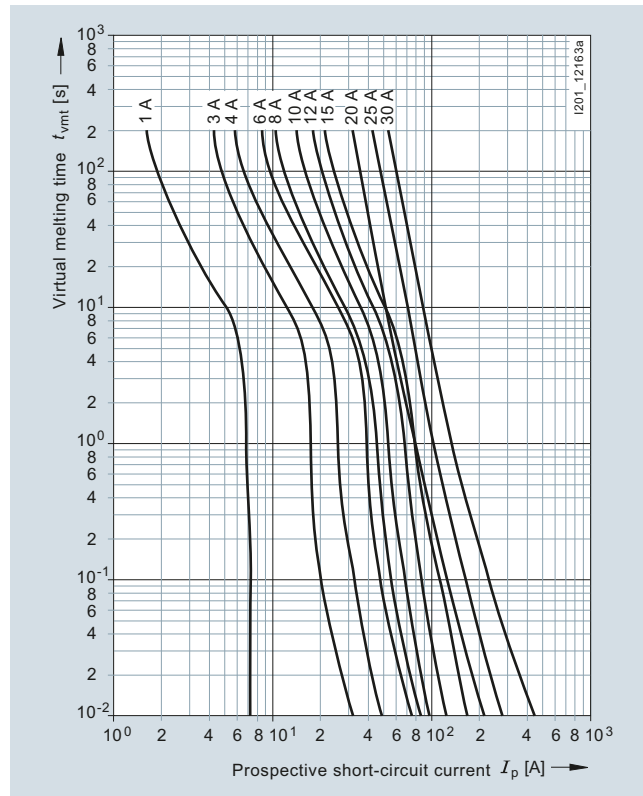

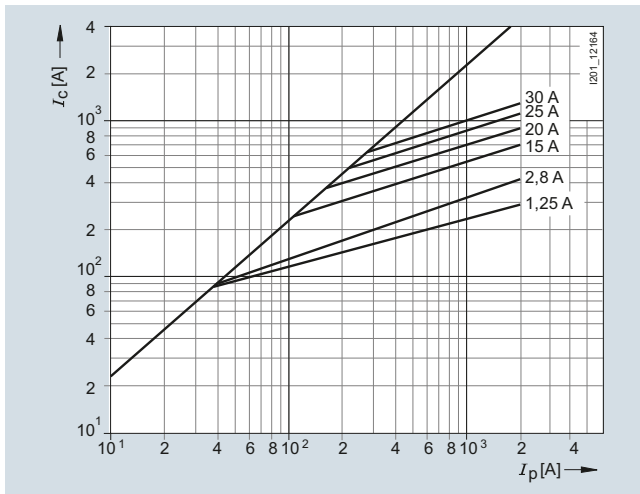
3NW3...-OHG series**Current limiting diagram**

Fuse Systems

Busbar systems

Overview

Busbars with pin-type connections can be used for NEOZED safety switching devices and fuse bases. Busbars in 10 mm² and 16 mm² versions are available.

Busbars with fork plugs are used for the most frequently used NEOZED fuse bases made of ceramic.

Benefits

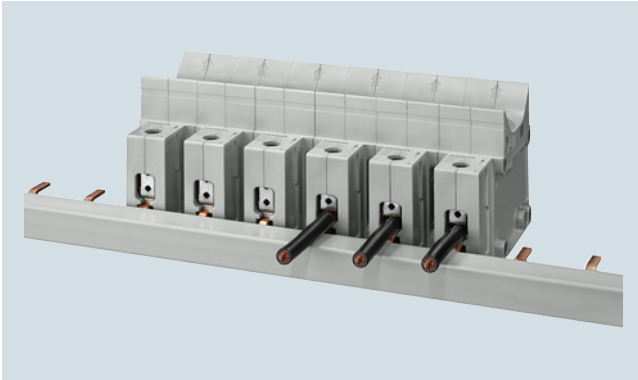

- Clear and visible conductor connection that can be easily checked when using the NEOZED D02 comfort base and which facilitates cable entry

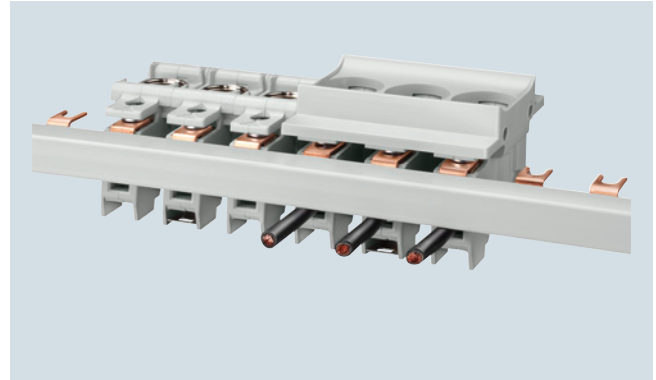

- Bus-mounting of NEOZED fuse bases made of molded plastic on 3-phase busbar with fork plug, which can be cut to length

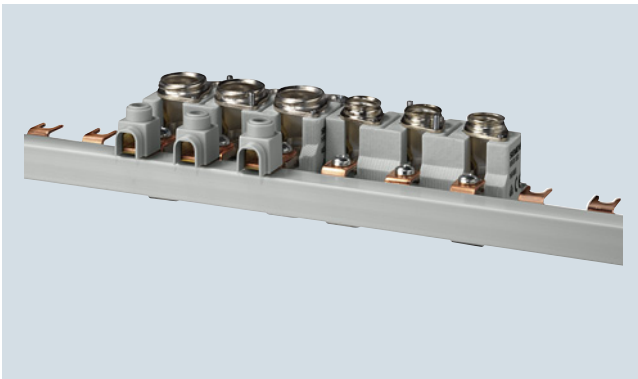

- Bus-mounting of NEOZED fuse bases made of ceramic on 3-phase busbar with fork plug, which can be cut to length

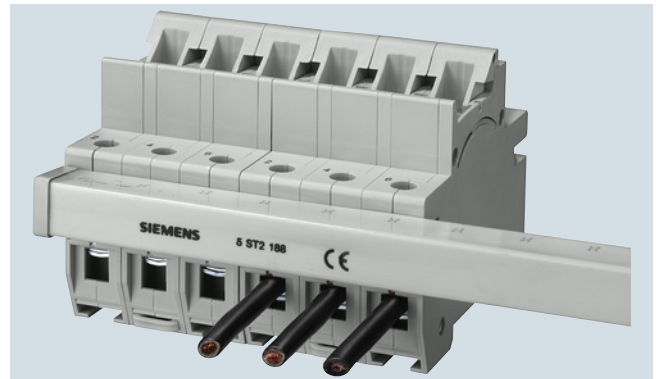

- Bus-mounting of MINIZED D01 fuse switch disconnectors on 3-phase busbar with fork plug, can be cut to length

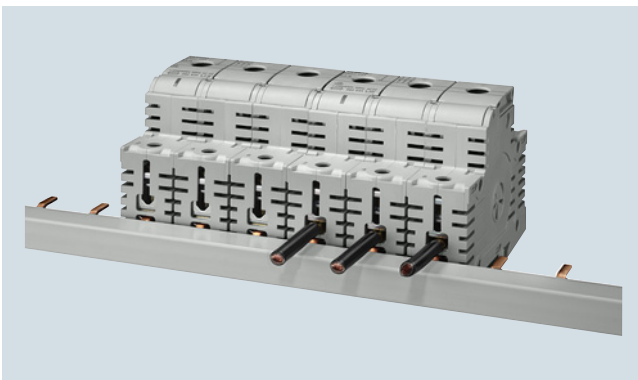

- Clear and visible conductor connection that can be easily checked when using MINIZED D02 switch disconnectors. This facilitates cable entry and saves time

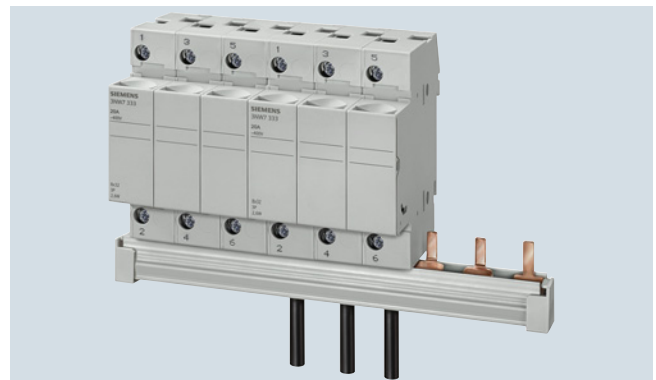

- Bus-mounting of cylindrical fuse holders 8 × 32 mm and 10 × 38 mm with three-phase pin busbar that can be cut to length

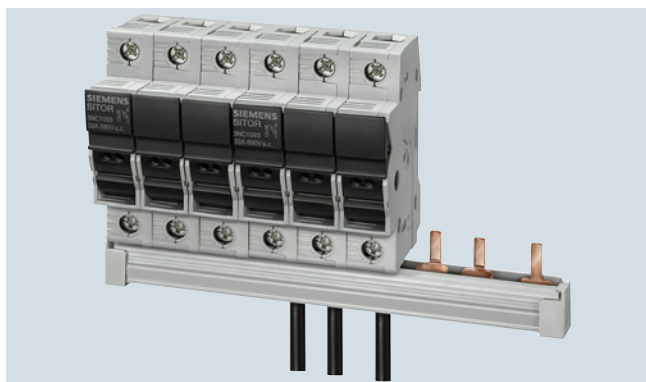

- Bus-mounting of SITOR cylindrical fuse holders 10 mm x 38 mm with the same terminal connection as Class CC fuse holders with 3-phase pin busbar that can be cut to length

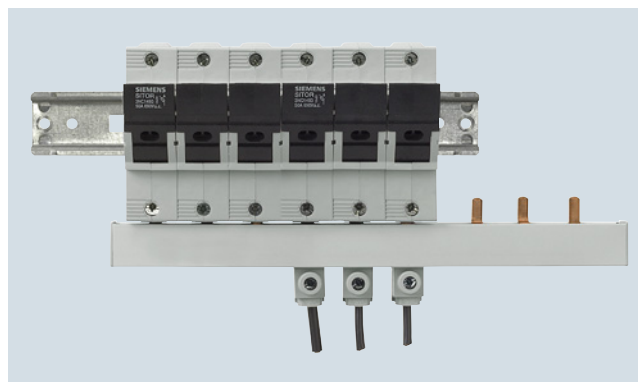

- Bus mounting with infeed through a connection terminal directly on the fuse holder up to a conductor cross-section of 25 mm²

Technical specifications

		5ST, 5SH
Standards		EN 60439-1 (VDE 0660-500): 2005-01
Busbar material		SF-Cu F 24
Partition material		Plastic Cyclooloy 3600, heat-resistant above 90 °C, flame-retardant, self-extinguishing, free of dioxins and halogens
Rated operational voltage U_c	V AC	400
Rated current I_n		
• Cross-section 10 mm ²	A	63
• Cross-section 16 mm ²	A	80
Rated impulse withstand voltage U_{imp}	kV	4
Test pulse voltage (1.2/50)	kV	6.2
Rated conditional short-circuit current I_{cc}	kA	25
Resistance to climate		
• Constant atmosphere	Acc. to DIN 50015	23/83; 40/92; 55/20
• Humid heat	Acc. to IEC 60068-2-30	28 cycles
Insulation coordination		
• Overvoltage category		III
• Pollution degree		2
Maximum busbar current I_S per phase		
• Infeed at the start of the busbar		
- Cross-section 10 mm ²	A	63
- Cross-section 16 mm ²	A	80
• Infeed at the center of the busbar		
- Cross-section 10 mm ²	A	100
- Cross-section 16 mm ²	A	130

Fuse Systems

Busbar systems

5ST37...-HG busbars acc. to UL 508

		5ST37...-0HG	5ST37...-2HG	5ST3770-0HG	5ST3770-1HG
Standards		UL 508, CSA C22.2 No. 14-M 95			
Approvals		UL 508 File No. E328403 CSA			
Operational voltage					
• Acc. to IEC	V AC	690			
• Acc. to UL 489	V AC	600			
Rated conditional short-circuit current	kA	10 (RMS symmetrical 600 V for three cycles)			
• Dielectric strength	kV/mm	25			
• Surge strength	kV	> 9.5			
Rated current	A	--	--	115	
Maximum busbar current I_S per phase					
• Infeed at the start of the busbar	A	80	100	--	--
• Infeed at the center of the busbar	A	160	200	--	--
Insulation coordination					
• Overvoltage category		III			
• Pollution degree		2			
Busbar cross-section	mm ² Cu	18	25	--	--
Infeed		Any			
Conductor cross-sections	AWG mm ²	-- --	-- --	10 ... 1/0 6 ... 35	14 ... 1 1.5 ... 50
Terminals					
• Terminal tightening torque	Nm lbs/in	-- --	-- --	5 50	3.5 35

Infeed at the start of the busbar

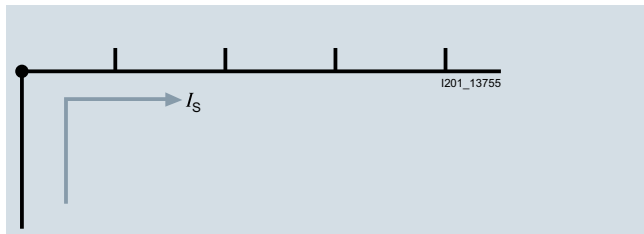

Infeed along the busbar or midpoint infeed

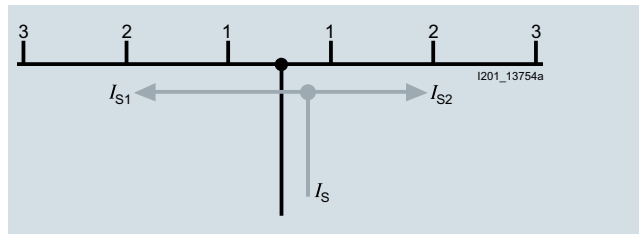

The sum of the output current per branch must not be greater than the busbar current $I_{S1,2}/\text{phase}$.

Dimensional drawings

5ST37

Pin spacing in MW (modular width; 1 MW = 18 mm)

Dimensions of side views in mm (approx.)

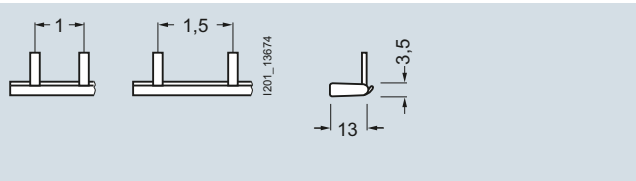

5ST3700 5ST3703
5ST3701
Single-phase Single-phase

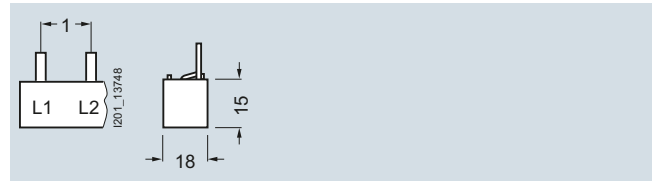

5ST3704
5ST3705
Two-phase

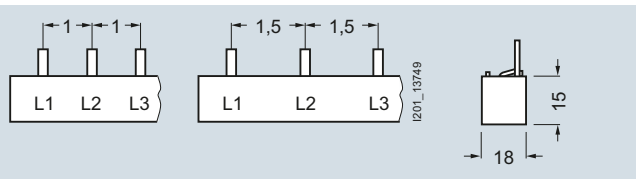

5ST3708 5ST3714
5ST3710
Three-phase Three-phase

5ST2

Fork spacing in MW (modular width; 1 MW = 18 mm)

Dimensions of side views in mm (approx.)

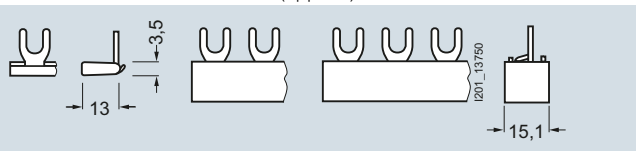

5ST2186 5ST2187 5ST2188
5ST2190 5ST2191 5ST2192
Single-phase Two-phase Three-phase

Busbars for DIAZED EZR fuse bases

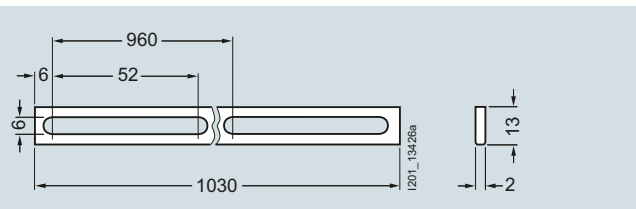

5SH3500

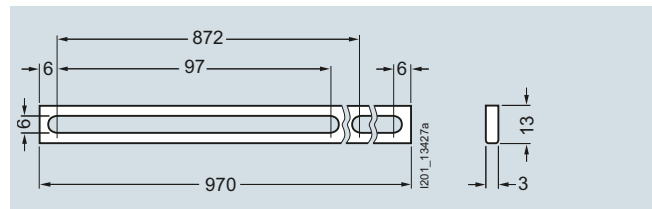

5SH3501

5SH5

Fork spacing in MW (modular width; 1 MW = 18 mm), dimensions of side views in mm (approx.)

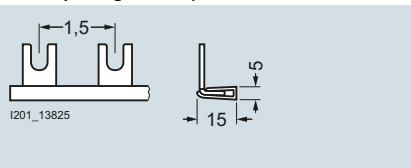

5SH5517

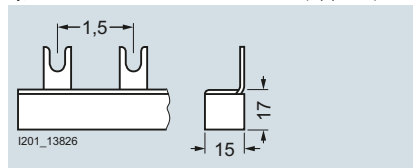

5SH5320

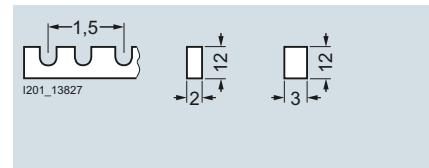

5SH5321 5SH5322

Fuse Systems

Busbar systems

5ST37 . . . HG busbars acc. to UL 508

5ST37

Pin spacing in MW (modular width; 1 MW = 18 mm)

Dimensions of side views in mm (approx.)

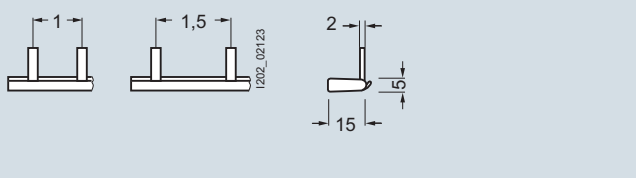

5ST3701-0HG 5ST3703-0HG

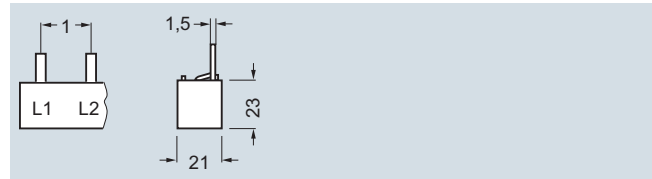

5ST3705-0HG

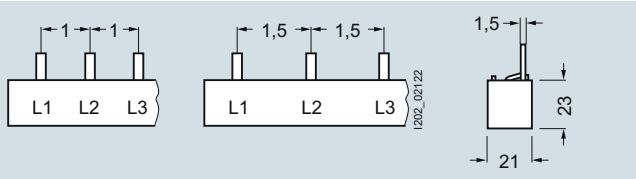

5ST3710-0HG 5ST3714-0HG

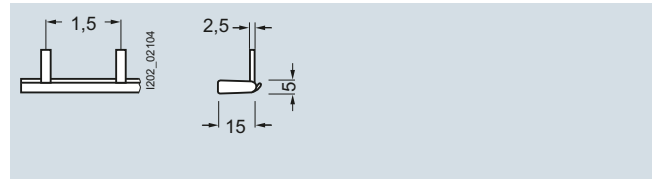

5ST3701-2HG

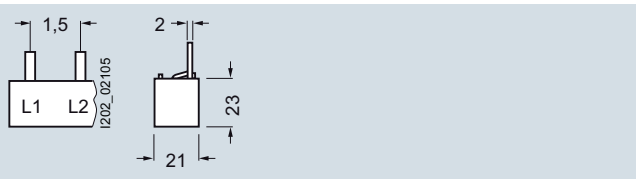

5ST3705-2HG

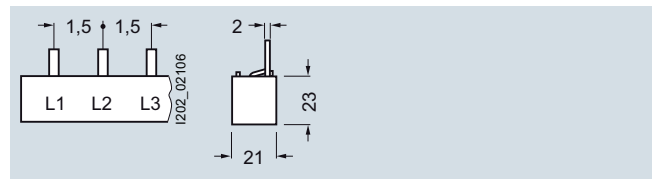

5ST3710-2HG

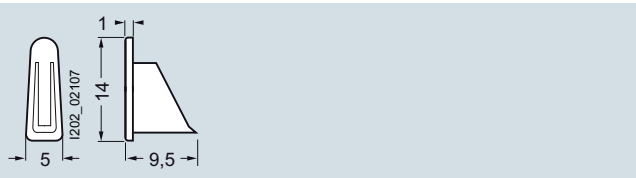

5ST3748-0HG

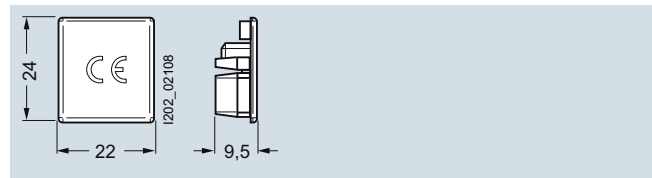

5ST3750-0HG

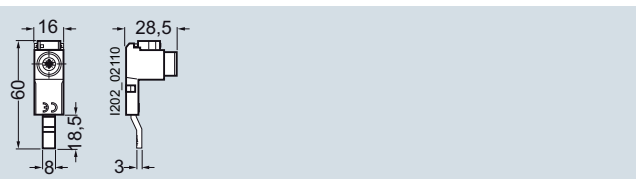

5ST3770-0HG

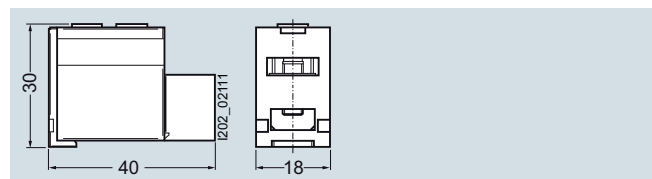

5ST3770-1HG

5ST36 touch protection covers

Pin spacing in MW (modular width; 1 MW = 18 mm)

Dimensions of side views in mm (approx.)

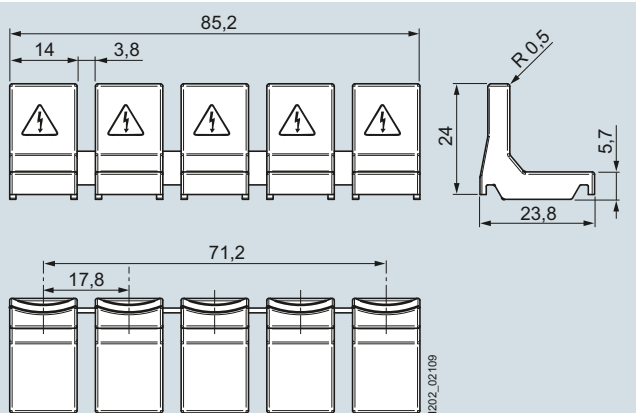

5ST3655-0HG

Overview

LV HRC fuse systems (NH type) are used for installation systems in non-residential, commercial and industrial buildings as well as in switchgear assemblies of power utilities. They therefore protect essential building parts and systems.

LV HRC fuse systems (NH type) are fuse systems designed for operation by experts. There are no constructional requirements for non-interchangeability of rated current and touch protection.

The components and auxiliary equipment are designed in such a way as to ensure the safe replacement of LV HRC fuse systems or isolation of systems.

LV HRC fuse links are available in the sizes 000, 00, 0, 1, 2, 3, 4 and 4a.

LV HRC fuse links are available in the following operational classes:

- gG for cable and line protection
- aM for short-circuit protection of switching devices in motor circuits
- gR or aR for protection of power semiconductors
- gS: The new gS operational class combines cable and line protection with semiconductor protection

LV HRC fuse links of size 000 can also be used in LV HRC fuse bases, LV HRC fuse switch disconnectors, LV HRC fuse strips as well as LV HRC in-line fuse switch disconnectors of size 00.

The fuse links 300 A, 355 A and 425 A comply with the standard but do not have the VDE mark.

LV HRC components:

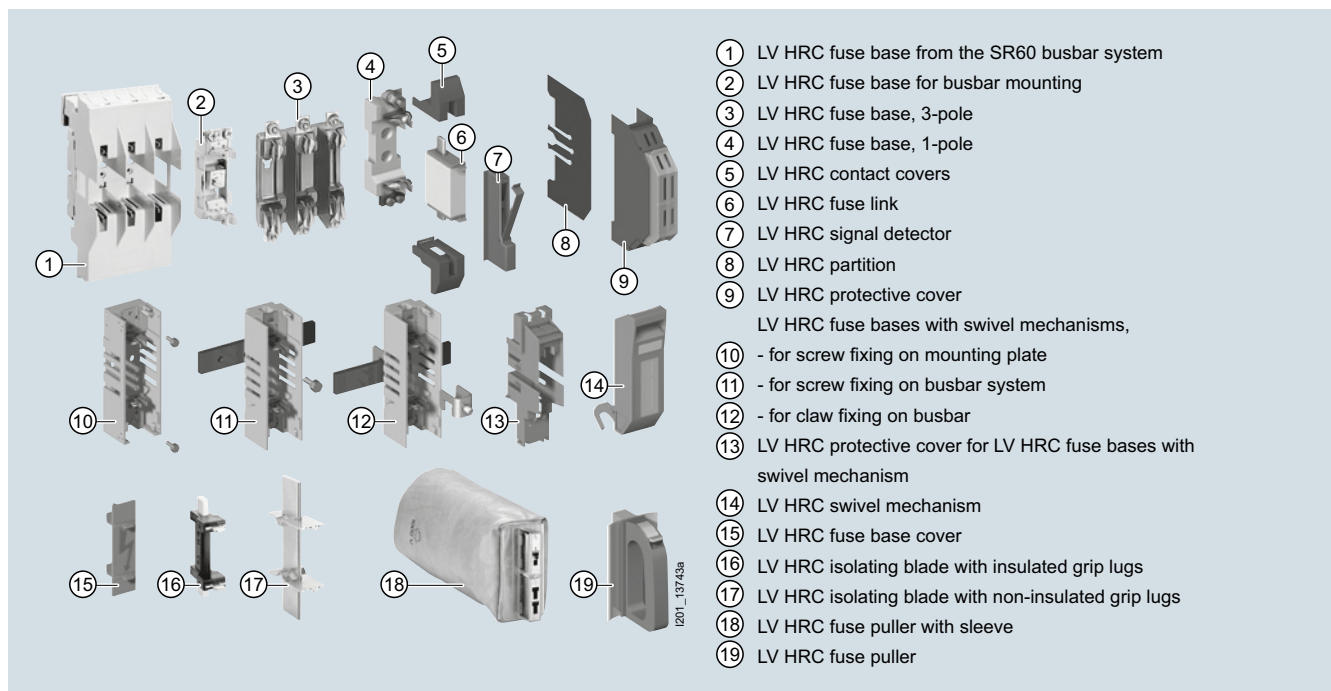

Fuse Systems

3NA, 3ND LV HRC Fuse Systems

LV HRC fuse links

Technical specifications

	LV HRC fuse links						Operational class aM
	Operational class						
	gG						
	3NA6...-4 3NA6...-4KK 3NA383.-8	3NA6... 3NA6...-7 3NA7... 3NA7...-7	3NA3... 3NA3...-7	3NA6...-6 3NA7...-6	3NA3...-6		3ND1 3ND2
Standards	IEC 60269-1, -2; EN 60269-1; DIN VDE 0636						
Approvals	DIN VDE 0636-2; CSA 22.2 No.106, File Number 016325_0_00 (CSA approval of fuses 500 V for 600 V)						
Rated voltage U_n							
• Sizes 000 and 00	V AC	400	500	500	690 ¹⁾	690 ¹⁾	500
	V DC	--	250	250	250	250	--
• Sizes 1 and 2	V AC	400	500	500	690 ¹⁾	690 ¹⁾	690
	V DC	--	440	440	440	440	--
• Size 3	V AC	--	--	500	--	690 ¹⁾	690
	V DC	--	--	440	--	440	--
• Sizes 4 and 4a (IEC design)	V AC	--	--	500	--	--	--
	V DC	--	--	440	--	--	--
Rated current I_n	A	10 ... 400	2 ... 400	2 ... 1250	2 ... 315	2 ... 500	6 ... 630
Rated breaking capacity	kA AC	120					
	kA DC	--	25				--
Contact pins	Non-corroding, silver-plated						
Resistance to climate	°C	-20 ... +50 at 95% relative humidity					

¹⁾ Manufacturer's confirmation for 690 V +10 % rated voltage available on request.

Characteristic curves

3NA30 series

Size: 0
Operational class: gG
Rated voltage: 500 V AC/440 V DC
Rated current: 6 ... 160 A

Time/current characteristics diagram

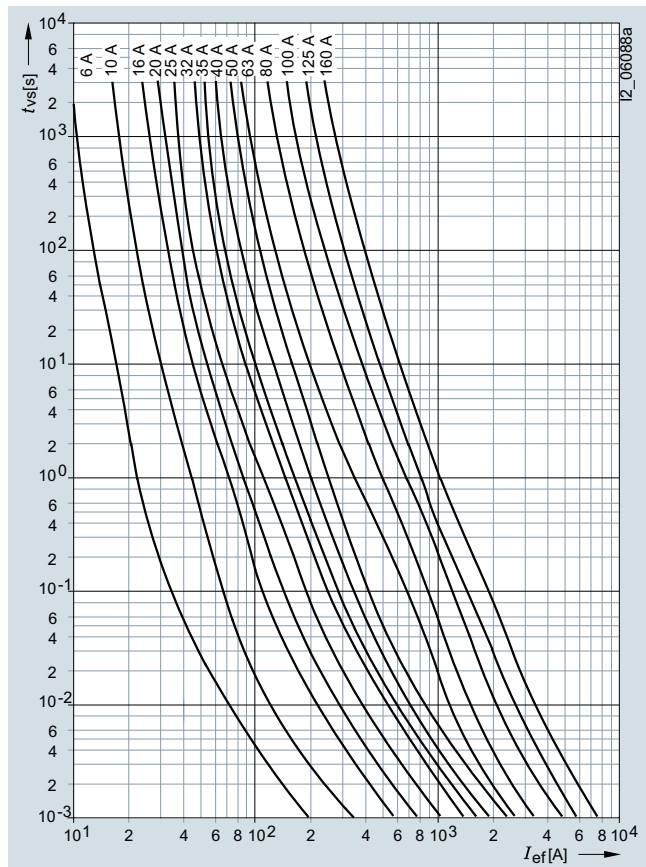

Melting I²t values diagram

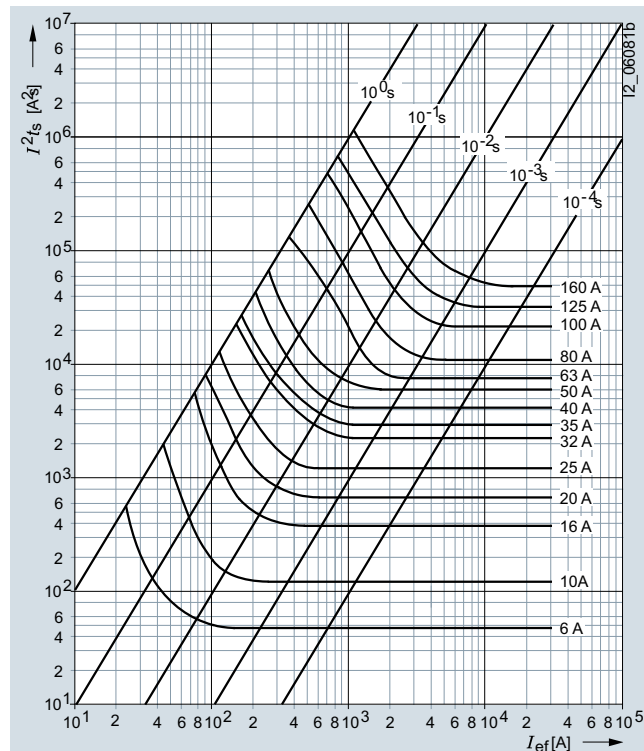

Current limiting diagram

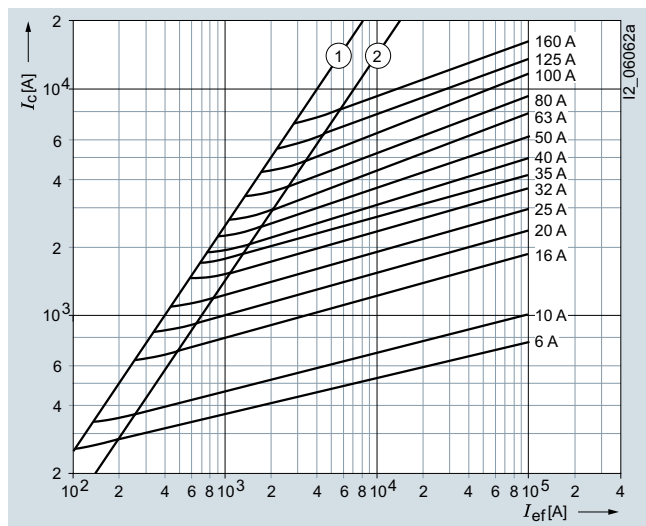

- ① Peak short-circuit current with largest DC component
- ② Peak short-circuit current without DC component

Type	I _n A	P _v W	Δθ K	I ² t _{1ms} A ² s	4 ms A ² s
3NA3001	6	1.5	6	46	50
3NA3003	10	1	9	120	130
3NA3005	16	1.9	11	370	420
3NA3007	20	2.3	13	670	750
3NA3010	25	2.7	15	1200	1380
3NA3012	32	3	13	2200	2400
3NA3014	35	3	17	3000	3300
3NA3017	40	3.4	17	4000	4500
3NA3020	50	4.5	24	6000	6800
3NA3022	63	5.8	27	7700	9800
3NA3024	80	7	34	12000	16000
3NA3030	100	8.2	37	24000	30600
3NA3032	125	10.2	38	36000	50000
3NA3036	160	13.5	44	58000	85000

Type	I ² t _a 230 V AC A ² s	400 V AC A ² s	500 V AC A ² s
3NA3001	80	110	150
3NA3003	180	265	370
3NA3005	580	750	1000
3NA3007	1000	1370	1900
3NA3010	1800	2340	3300
3NA3012	3400	4550	6400
3NA3014	4900	6750	9300
3NA3017	6100	8700	12100
3NA3020	9100	11600	16000
3NA3022	14200	19000	26500
3NA3024	23100	30700	43000
3NA3030	40800	56200	80000
3NA3032	70000	91300	130000
3NA3036	120000	158000	223000

Fuse Systems

3NA, 3ND LV HRC Fuse Systems

LV HRC fuse links

3NA31, 3NA61, 3NA71 series

Size: 1
 Operational class: gG
 Rated voltage: 500 V AC/440 V DC
 Rated current: 16 ... 250 A

Time/current characteristics diagram

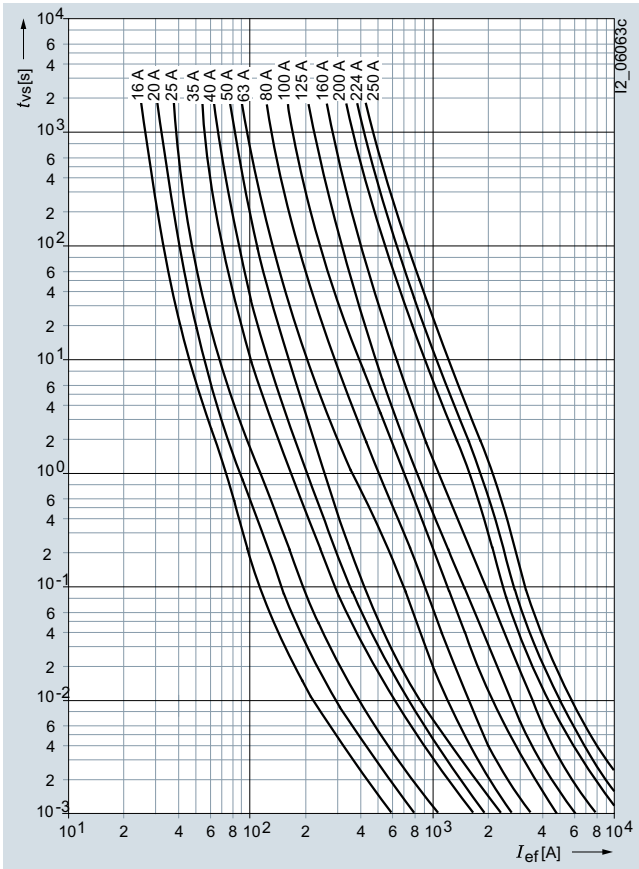

Melting I^2t values diagram

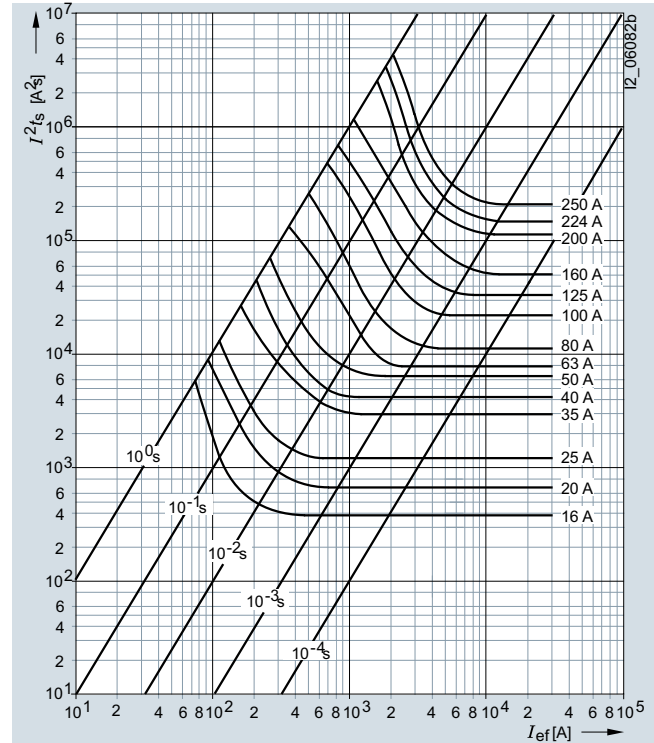

Current limiting diagram

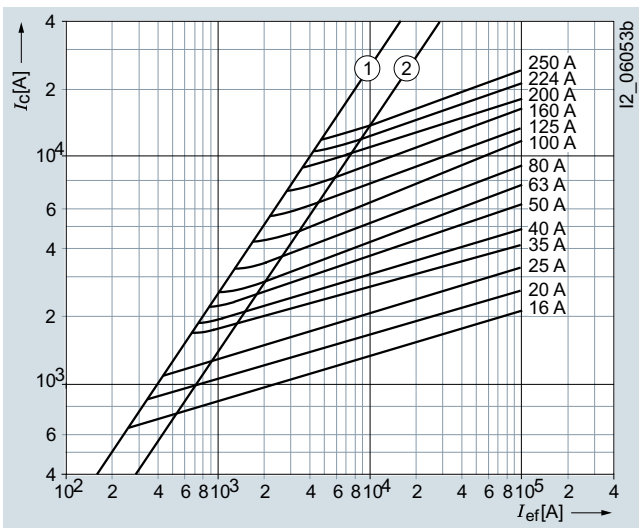

- ① Peak short-circuit current with largest DC component
- ② Peak short-circuit current without DC component

Type	I_n	P_v	$\Delta\theta$	I^2t_s	
	A	W	K	1 ms A^2s	4 ms A^2s
3NA3105, 3NA6105, 3NA7105	16	2.1	8	370	420
3NA3107, 3NA6107, 3NA7107	20	2.4	10	670	750
3NA3110, 3NA6110, 3NA7110	25	2.8	11	1200	1380
3NA3114, 3NA6114, 3NA7114	35	3.2	16	3000	3300
3NA3117, 3NA6117, 3NA7117	40	3.6	16	4000	4500
3NA3120, 3NA6120, 3NA7120	50	4.6	20	6000	6800
3NA3122, 3NA6122, 3NA7122	63	6	21	7700	9800
3NA3124, 3NA6124, 3NA7124	80	7.5	29	12000	16000
3NA3130, 3NA6130, 3NA7130	100	8.9	30	24000	30600
3NA3132, 3NA6132, 3NA7132	125	10.7	31	36000	50000
3NA3136, 3NA6136, 3NA7136	160	13.9	34	58000	85000
3NA3140, 3NA6140, 3NA7140	200	15	36	115000	135000
3NA3142, 3NA6142, 3NA7142	224	16.1	37	145000	170000
3NA3144, 3NA6144, 3NA7144	250	17.3	39	205000	230000

Type	I^2t_a		
	230 V AC A^2s	400 V AC A^2s	500 V AC A^2s
3NA3105, 3NA6105, 3NA7105	580	750	1000
3NA3107, 3NA6107, 3NA7107	1000	1370	1900
3NA3110, 3NA6110, 3NA7110	1800	2340	3300
3NA3114, 3NA6114, 3NA7114	4900	6750	9300
3NA3117, 3NA6117, 3NA7117	6100	8700	12100
3NA3120, 3NA6120, 3NA7120	9100	11600	16000
3NA3122, 3NA6122, 3NA7122	14200	19000	26500
3NA3124, 3NA6124, 3NA7124	23100	30700	43000
3NA3130, 3NA6130, 3NA7130	40800	56200	80000
3NA3132, 3NA6132, 3NA7132	70000	91300	130000
3NA3136, 3NA6136, 3NA7136	120000	158000	223000
3NA3140, 3NA6140, 3NA7140	218000	285000	400000
3NA3142, 3NA6142, 3NA7142	299000	392000	550000
3NA3144, 3NA6144, 3NA7144	420000	551000	780000

3NA31...-6, 3NA61...-6, 3NA71...-6 series

Size: 1
Operational class: gG
Rated voltage: 690 V AC¹⁾/440 V DC
Rated current: 50 ... 200 A

Time/current characteristics diagram

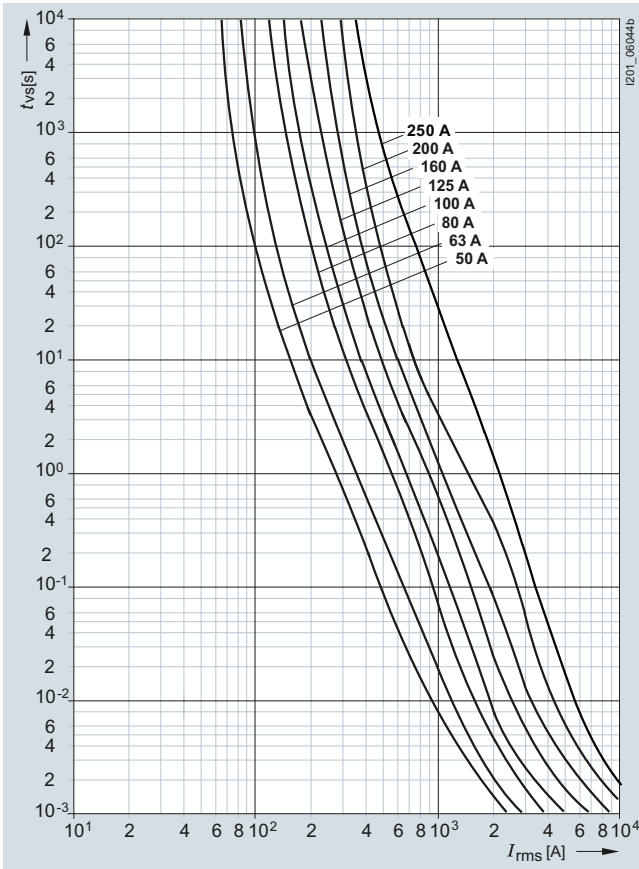

Melting I^2t_s values diagram

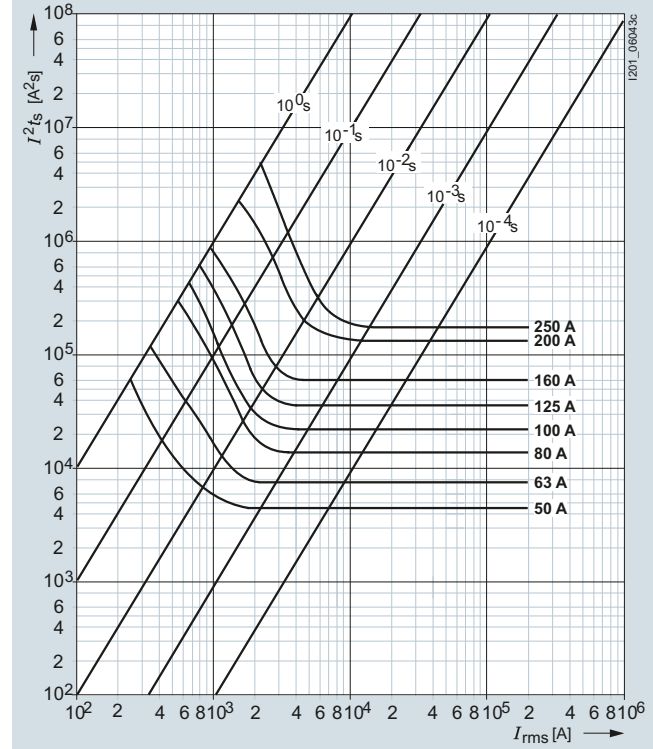

Current limiting diagram

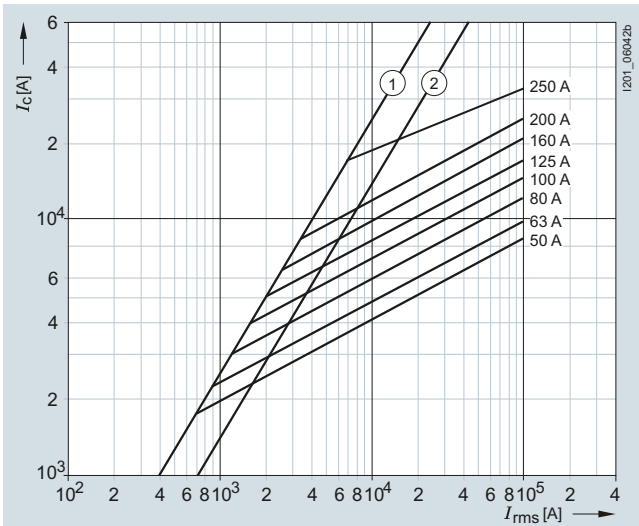

- ① Peak short-circuit current with largest DC component
- ② Peak short-circuit current without DC component

Type	I_n	P_v	$\Delta\theta$	I^2t_s	
	A	W	K	1 ms A ² s	4 ms A ² s
3NA3120-6, 3NA6120-6, 3NA7120-6	50	6.7	21	440	7400
3NA3122-6, 3NA6122-6, 3NA7122-6	63	7.6	22	7600	10100
3NA3124-6, 3NA6124-6, 3NA7124-6	80	6.7	22	13500	17000
3NA3130-6, 3NA6130-6, 3NA7130-6	100	8.7	28	21200	30500
3NA3132-6, 3NA6132-6, 3NA7132-6	125	10.5	29	36000	50000
3NA3136-6, 3NA6136-6, 3NA7136-6	160	13.8	33	58000	85000
3NA3140-6, 3NA6140-6, 3NA7140-6	200	16.6	35	132000	144000

Type	I^2t_a		
	230 V AC A ² s	400 V AC A ² s	690 V AC A ² s
3NA3120-6, 3NA6120-6, 3NA7120-6	9100	11200	1900
3NA3122-6, 3NA6122-6, 3NA7122-6	13600	17000	24000
3NA3124-6, 3NA6124-6, 3NA7124-6	24300	32000	55000
3NA3130-6, 3NA6130-6, 3NA7130-6	42400	52000	75000
3NA3132-6, 3NA6132-6, 3NA7132-6	69500	82200	130000
3NA3136-6, 3NA6136-6, 3NA7136-6	120000	155000	223000
3NA3140-6, 3NA6140-6, 3NA7140-6	211000	240000	360000

¹⁾ Manufacturer's confirmation for 690 V +10 % rated voltage available on request.

Fuse Systems

3NA, 3ND LV HRC Fuse Systems

LV HRC fuse links

3NA32, 3NA62, 3NA72 series

Size: 2
 Operational class: gG
 Rated voltage: 500 V AC/440 V DC
 Rated current: 35 ... 400 A

Time/current characteristics diagram

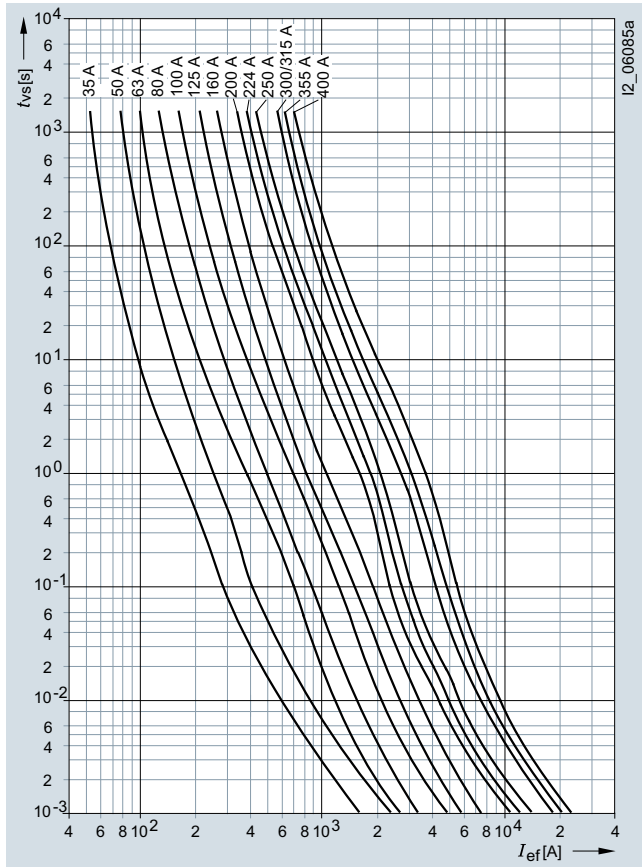

Melting I^2t values diagram

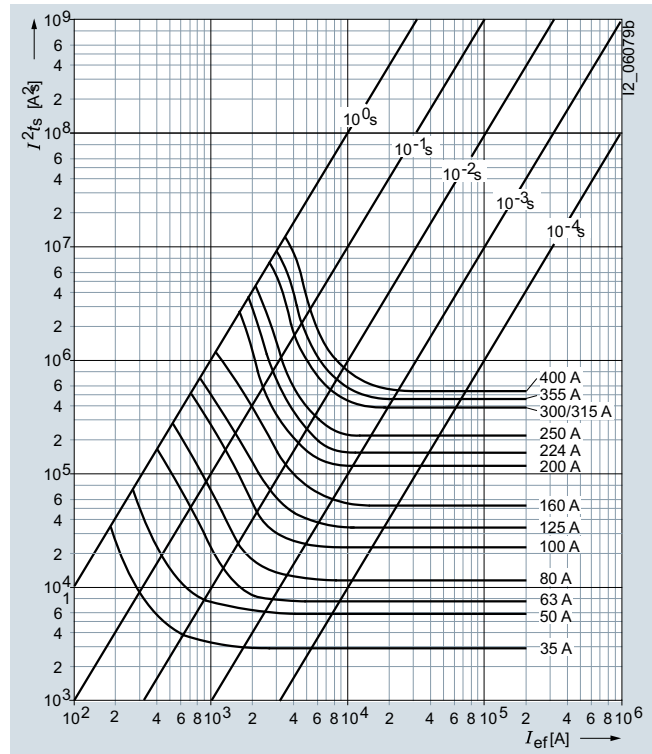

Current limiting diagram

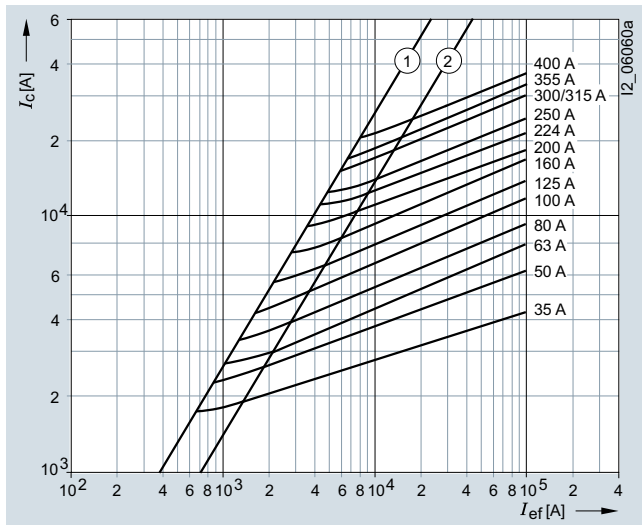

- ① Peak short-circuit current with largest DC component
- ② Peak short-circuit current without DC component

Type	I_n A	P_v W	$\Delta\theta$ K	I^2t_s	
				1 ms A^2s	4 ms A^2s
3NA3214, 3NA6214, 3NA7214	35	3.2	12	3000	3300
3NA3220, 3NA6220, 3NA7220	50	4.7	16	6000	6800
3NA3222, 3NA6222, 3NA7222	63	5.9	16	7700	9800
3NA3224, 3NA6224, 3NA7224	80	6.8	21	12000	16000
3NA3230, 3NA6230, 3NA7230	100	7.4	22	24000	30600
3NA3232, 3NA6232, 3NA7232	125	9.8	27	36000	50000
3NA3236, 3NA6236, 3NA7236	160	12.6	34	58000	85000
3NA3240, 3NA6240, 3NA7240	200	14.9	33	115000	135000
3NA3242, 3NA6242, 3NA7242	224	15.4	31	145000	170000
3NA3244, 3NA6244, 3NA7244	250	17.9	38	205000	230000
3NA3250, 3NA6250	300	19.4	34	361000	433000
3NA3252, 3NA6252, 3NA7252	315	21.4	35	361000	433000
3NA3254, 3NA6254	355	26.0	49	441000	538000
3NA3260, 3NA6260, 3NA7260	400	27.5	52	529000	676000

Type	I^2t_a		
	230 V AC A^2s	400 V AC A^2s	500 V AC A^2s
3NA3214, 3NA6214, 3NA7214	4900	6750	9300
3NA3220, 3NA6220, 3NA7220	9100	11600	16000
3NA3222, 3NA6222, 3NA7222	14200	19000	26500
3NA3224, 3NA6224, 3NA7224	23100	30700	43000
3NA3230, 3NA6230, 3NA7230	40800	56200	80000
3NA3232, 3NA6232, 3NA7232	70000	91300	130000
3NA3236, 3NA6236, 3NA7236	120000	158000	223000
3NA3240, 3NA6240, 3NA7240	218000	285000	400000
3NA3242, 3NA6242, 3NA7242	299000	392000	550000
3NA3244, 3NA6244, 3NA7244	420000	551000	780000
3NA3250, 3NA6250	670000	901000	1275000
3NA3252, 3NA6252, 3NA7252	670000	901000	1275000
3NA3254, 3NA6254	800000	1060000	1500000
3NA3260, 3NA6260, 3NA7260	1155000	1515000	2150000

3NA32..-6, 3NA62..-6, 3NA72..-6 series

Size: 2
Operational class: gG
Rated voltage: 690 V AC¹⁾/440 V DC
Rated current: 80 ... 315 A

Time/current characteristics diagram

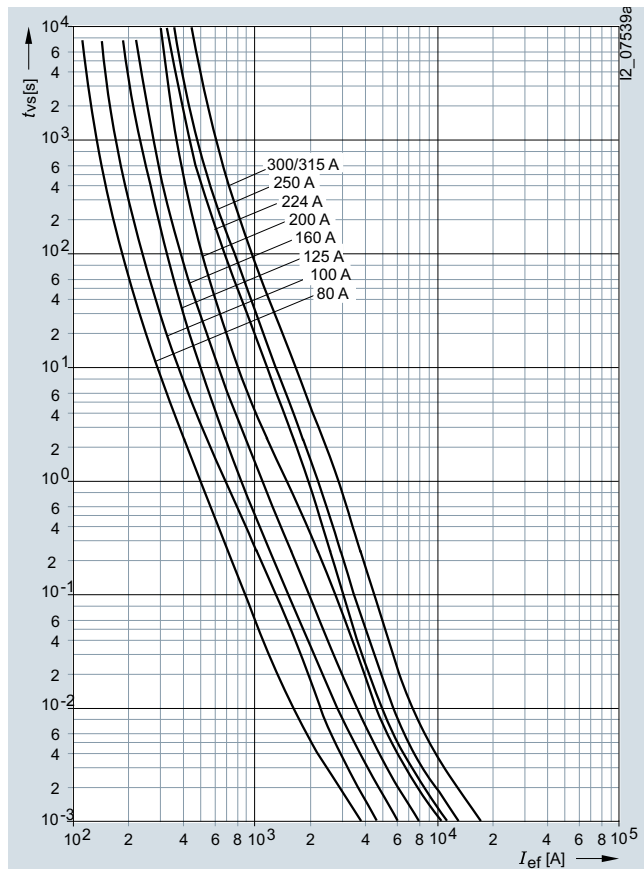

Melting I^2t values diagram

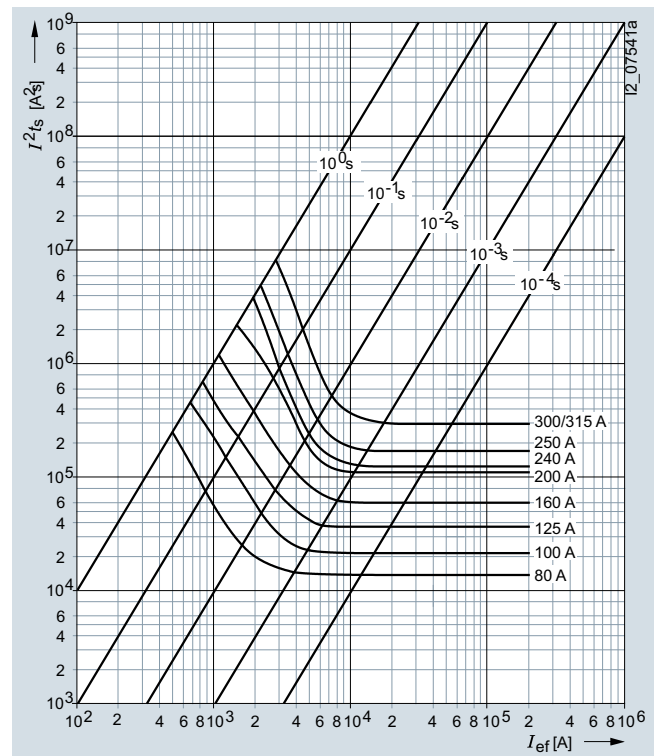

Current limiting diagram

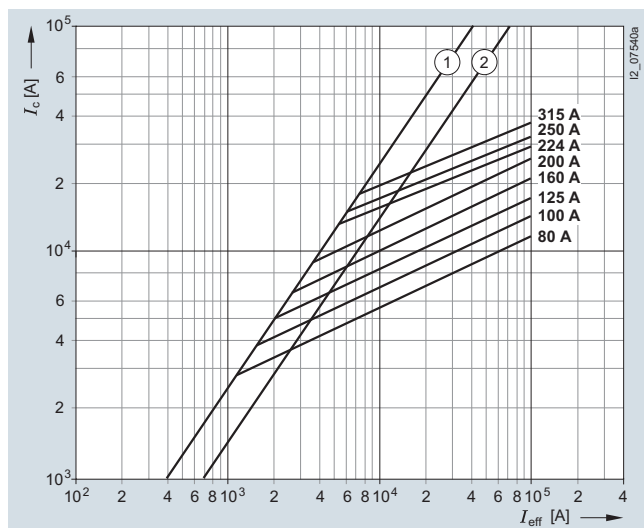

- ① Peak short-circuit current with largest DC component
- ② Peak short-circuit current without DC component

Type	I_n A	P_V W	$\Delta\theta$ K	I^2t_s	
				1 ms A ² s	4 ms A ² s
3NA3224-6, 3NA6224-6, 3NA7224-6	80	6.6	22	13500	17000
3NA3230-6, 3NA6230-6, 3NA7230-6	100	8.5	26	21200	30500
3NA3232-6, 3NA6232-6, 3NA7232-6	125	9.8	29	36000	50000
3NA3236-6, 3NA6236-6, 3NA7236-6	160	13.3	31	58000	85000
3NA3240-6, 3NA6240-6, 3NA7240-6	200	16.1	33	132000	144000
3NA3242-6, 3NA6242-6, 3NA7242-6	224	19.9	38	125000	162000
3NA3244-6, 3NA6244-6, 3NA7244-6	250	23	44	180000	215000
3NA3250-6, 3NA6250-6, 3NA7250-6	300	25.6	38	300000	380000
3NA3252-6, 3NA6252-6, 3NA7252-6	315	28.2	42	300000	380000

Type	I^2t_a		
	230 V AC A ² s	400 V AC A ² s	690 V AC A ² s
3NA3224-6, 3NA6224-6, 3NA7224-6	24300	32000	55000
3NA3230-6, 3NA6230-6, 3NA7230-6	42400	52000	75000
3NA3232-6, 3NA6232-6, 3NA7232-6	69500	82200	130000
3NA3236-6, 3NA6236-6, 3NA7236-6	120000	155000	223000
3NA3240-6, 3NA6240-6, 3NA7240-6	211000	240000	360000
3NA3242-6, 3NA6242-6, 3NA7242-6	300000	300000	450000
3NA3244-6, 3NA6244-6, 3NA7244-6	453000	350000	525000
3NA3250-6, 3NA6250-6, 3NA7250-6	480000	625000	940000
3NA3252-6, 3NA6252-6, 3NA7252-6	480000	625000	940000

¹⁾ Manufacturer's confirmation for 690 V + 10 % rated voltage available on request.

Fuse Systems

3NA, 3ND LV HRC Fuse Systems

LV HRC fuse links

3NA33 series

Size: 3
 Operational class: gG
 Rated voltage: 500 V AC/440 V DC
 Rated current: 200 ... 630 A

Time/current characteristics diagram

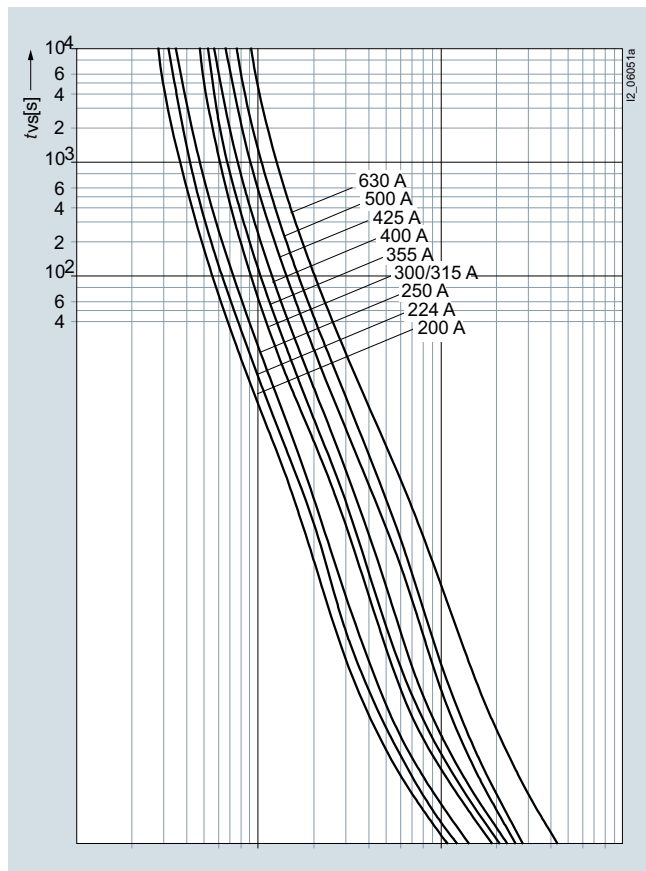

Melting I^2t values diagram

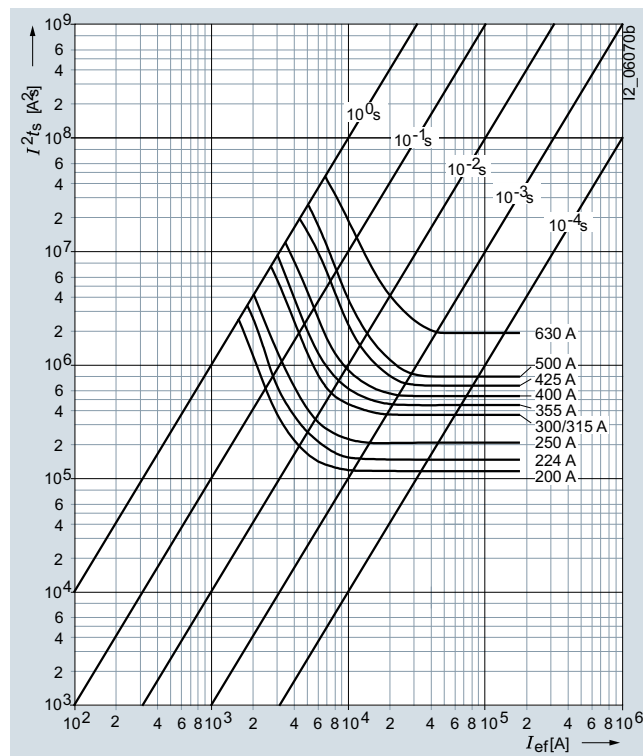

Current limiting diagram

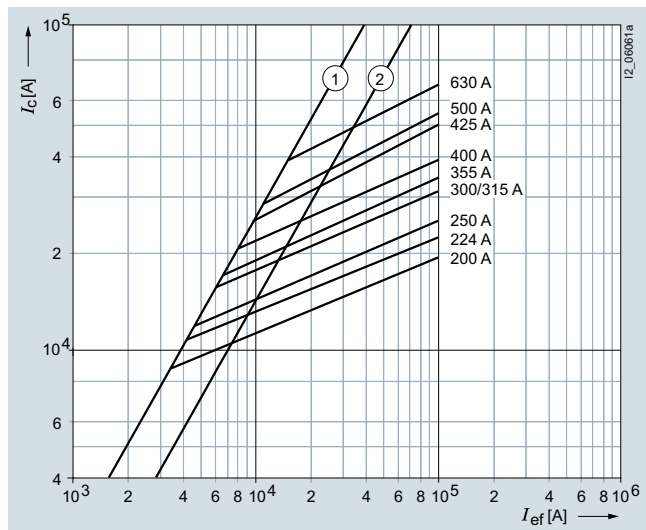

- ① Peak short-circuit current with largest DC component
- ② Peak short-circuit current without DC component

Type	I_n	P_v	$\Delta\theta$	I^2t_s	
	A	W	K	1 ms A ² s	4 ms A ² s
3NA3340	200	14.9	32	115000	135000
3NA3342	224	15.4	31	145000	170000
3NA3344	250	17.9	36	205000	230000
3NA3350	300	19.4	19	361000	433000
3NA3352	315	21.4	22	361000	433000
3NA3354	355	26.0	26	441000	538000
3NA3360	400	27.5	28	529000	676000
3NA3362	425	26.5	34	650000	970000
3NA3365	500	36.5	41	785000	1270000
3NA3372	630	44.0	50	1900000	2700000

Type	I^2t_a		
	230 V AC A ² s	400 V AC A ² s	500 V AC A ² s
3NA3340	218000	285000	400000
3NA3342	299000	392000	550000
3NA3344	420000	551000	780000
3NA3350	670000	901000	1275000
3NA3352	670000	901000	1275000
3NA3354	800000	1060000	1500000
3NA3360	1155000	1515000	2150000
3NA3362	1515000	1856000	2270000
3NA3365	1915000	2260000	2700000
3NA3372	3630000	4340000	5400000

3NA33..-6 series

Size: 3
Operational class: gG
Rated voltage: 690 V AC¹⁾/440 V DC
Rated current: 250 ... 500 A

Time/current characteristics diagram

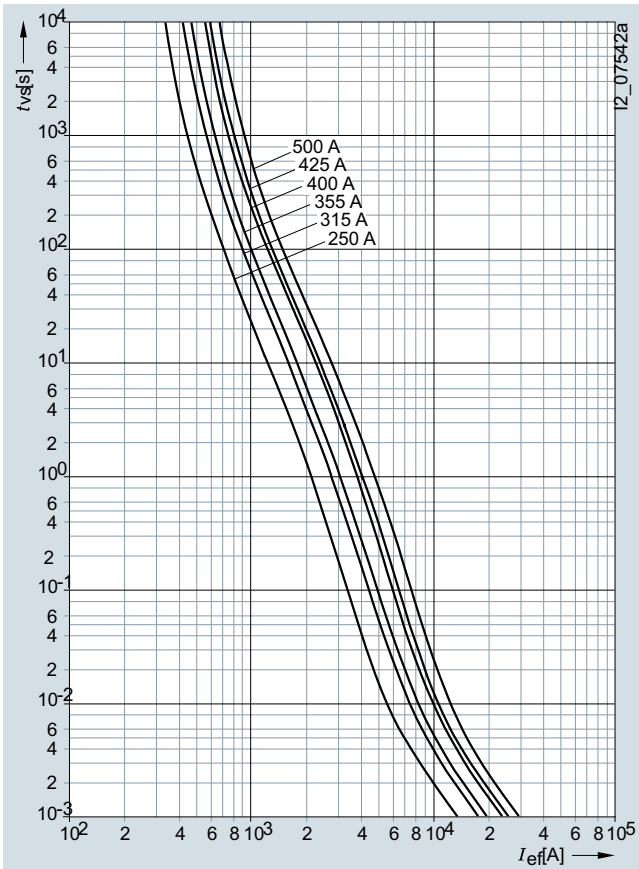

Melting I^2t values diagram

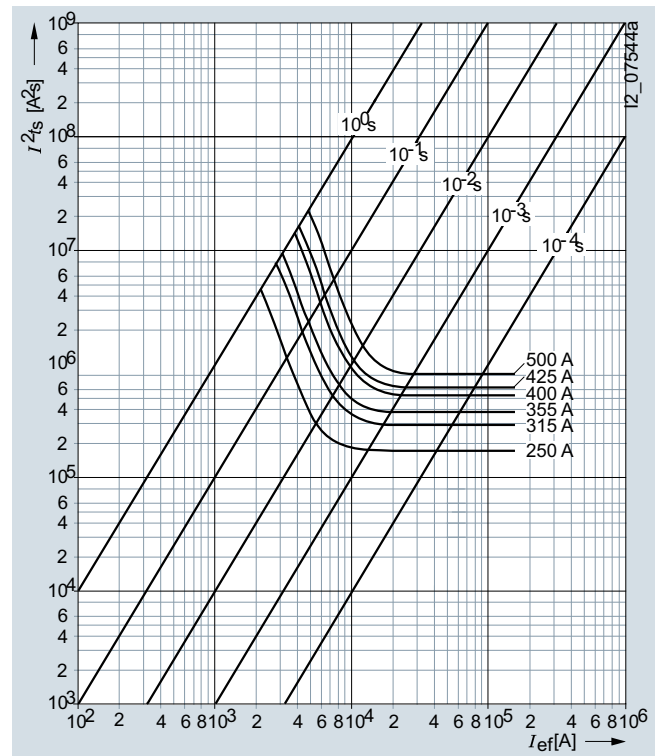

Current limiting diagram

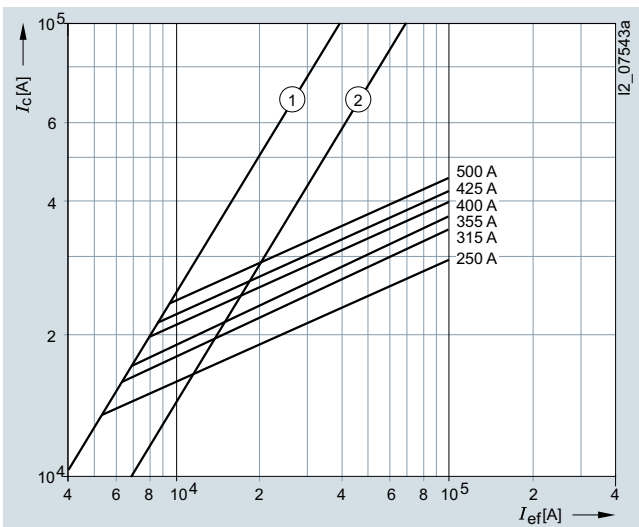

- ① Peak short-circuit current with largest DC component
- ② Peak short-circuit current without DC component

Type	I_n	P_v	$\Delta\theta$	I^2t_s	
	A	W	K	1 ms A ² s	4 ms A ² s
3NA3344-6	250	23	44	180000	215000
3NA3352-6	315	28.2	42	300000	380000
3NA3354-6	355	32.5	40	380000	470000
3NA3360-6	400	33.2	42	540000	675000
3NA3362-6	425	35.3	44	625000	765000
3NA3365-6	500	43.5	52	810000	1000000

Type	I^2t_a		
	230 V AC A ² s	400 V AC A ² s	690 V AC A ² s
3NA3344-6	453000	350000	525000
3NA3352-6	480000	625000	940000
3NA3354-6	585000	760000	1150000
3NA3360-6	847000	1100000	1650000
3NA3362-6	925000	1200000	1800000
3NA3365-6	1300000	1700000	2500000

¹⁾ Manufacturer's confirmation for 690 V + 10 % rated voltage available on request.

Fuse Systems

3NA, 3ND LV HRC Fuse Systems

LV HRC fuse links

3NA34 series

Size: 4 (IEC design)
 Operational class: gG
 Rated voltage: 500 V AC/440 V DC
 Rated current: 630 ... 1250 A

Time/current characteristics diagram

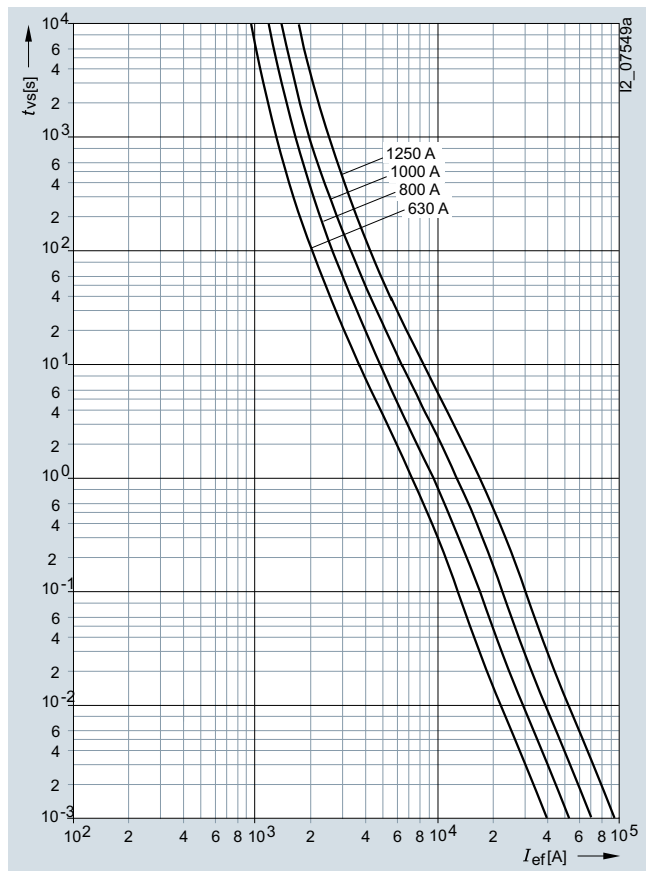

Melting I²t values diagram

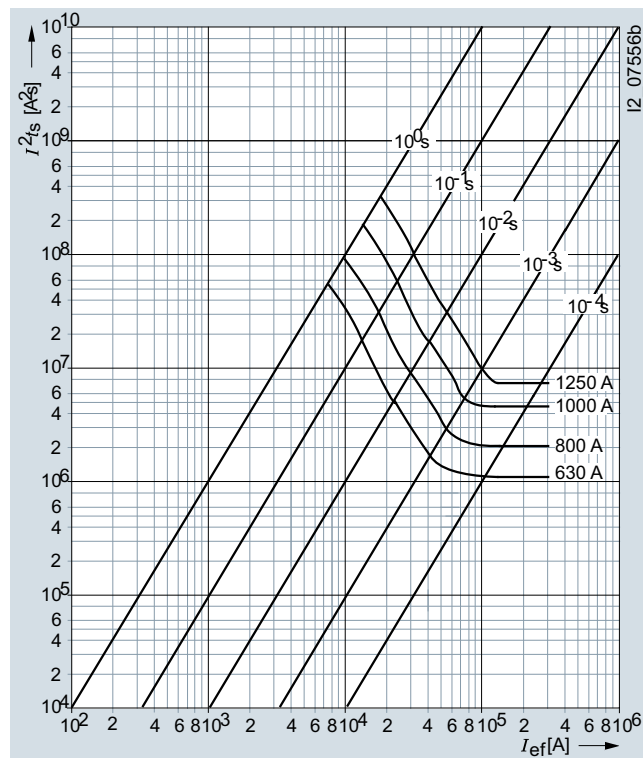

Current limiting diagram

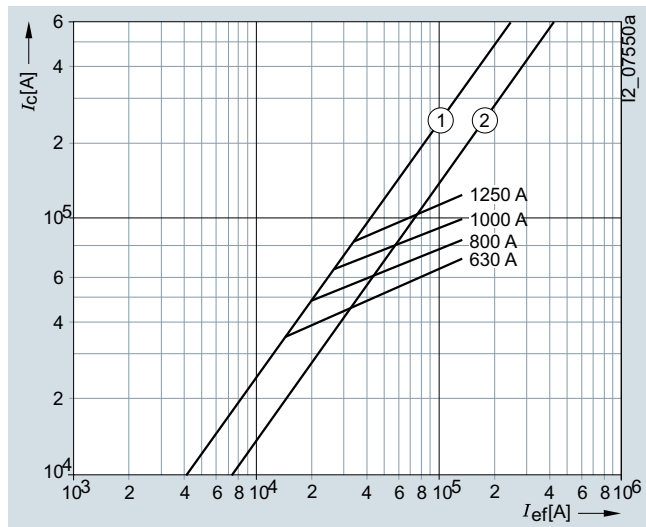

- ① Peak short-circuit current with largest DC component
- ② Peak short-circuit current without DC component

Type	I_n	P_v	$\Delta\theta$	I^2t_s	
	A	W	K	1 ms A ² s	4 ms A ² s
3NA3472	630	47	37	1900000	2700000
3NA3475	800	59	43	3480000	5620000
3NA3480	1000	74	56	7920000	10400000
3NA3482	1250	99	65	11880000	18200000

Type	I^2t_a		
	230 V AC A ² s	400 V AC A ² s	500 V AC A ² s
3NA3472	3630000	4340000	5400000
3NA3475	7210000	8510000	10400000
3NA3480	13600000	16200000	19000000
3NA3482	23900000	29100000	34800000

3NA36 series

Size: 4a
Operational class: gG
Rated voltage: 500 V AC/440 V DC
Rated current: 500 ... 1250 A

Time/current characteristics diagram

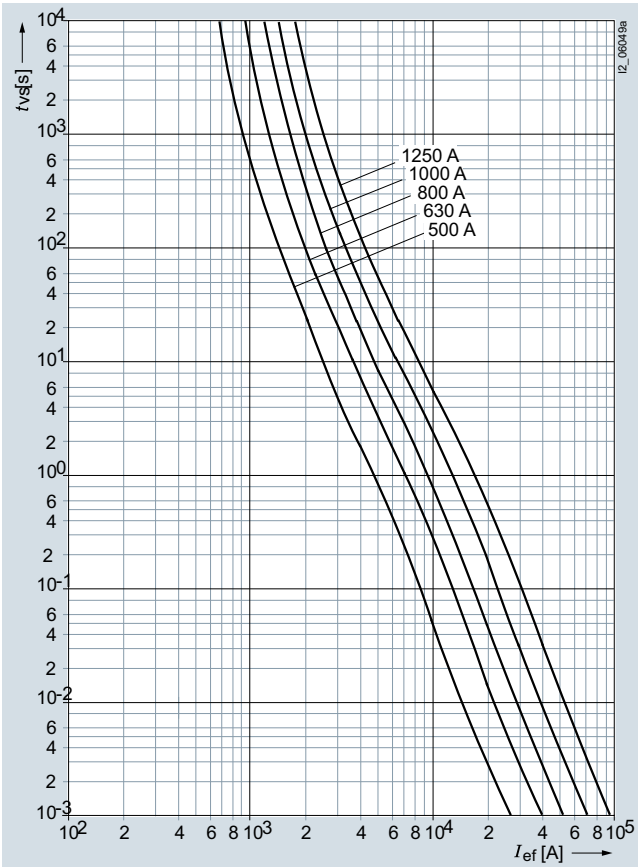

Melting I^2t values diagram

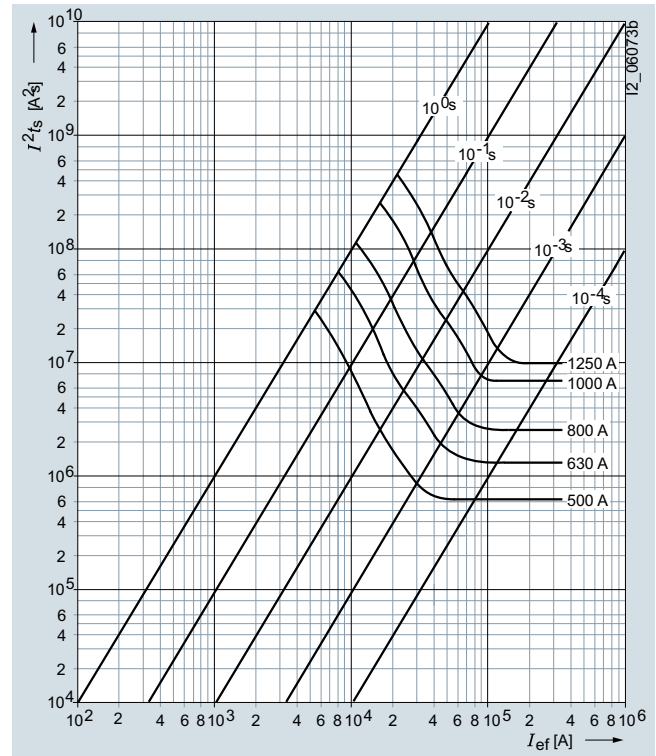

Current limiting diagram

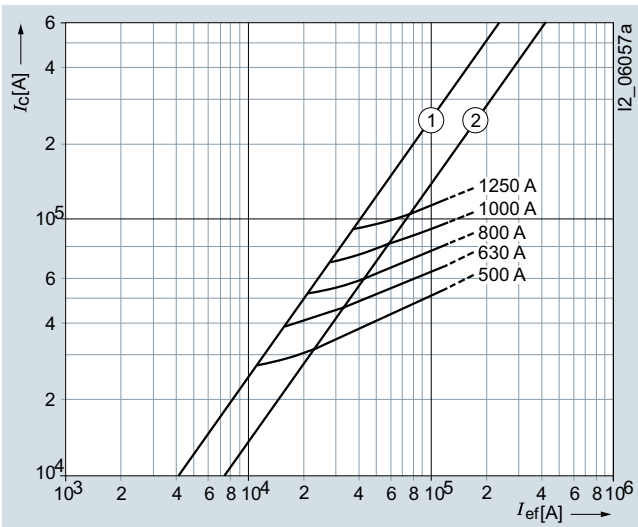

- ① Peak short-circuit current with largest DC component
- ② Peak short-circuit current without DC component

Type	I_n	P_v	$\Delta\theta$	I^2t_s	
	A	W	K	1 ms A ² s	4 ms A ² s
3NA3665	500	43	30	785000	1270000
3NA3672	630	47	37	1900000	2700000
3NA3675	800	59	43	3480000	5620000
3NA3680	1000	74	56	7920000	10400000
3NA3682	1250	99	65	11880000	18200000

Type	I^2t_a		
	230 V AC A ² s	400 V AC A ² s	500 V AC A ² s
3NA3665	1915000	2260000	2700000
3NA3672	3630000	4340000	5400000
3NA3675	7210000	8510000	10400000
3NA3680	13600000	16200000	19000000
3NA3682	23900000	29100000	34800000

Fuse Systems

3NA, 3ND LV HRC Fuse Systems

LV HRC fuse links

3NA38, 3NA68, 3NA78 series

Size: 000, 00
 Operational class: gG
 Rated voltage: 500 V AC/250 V DC
 Rated current: 2 ... 160 A

Time/current characteristics diagram

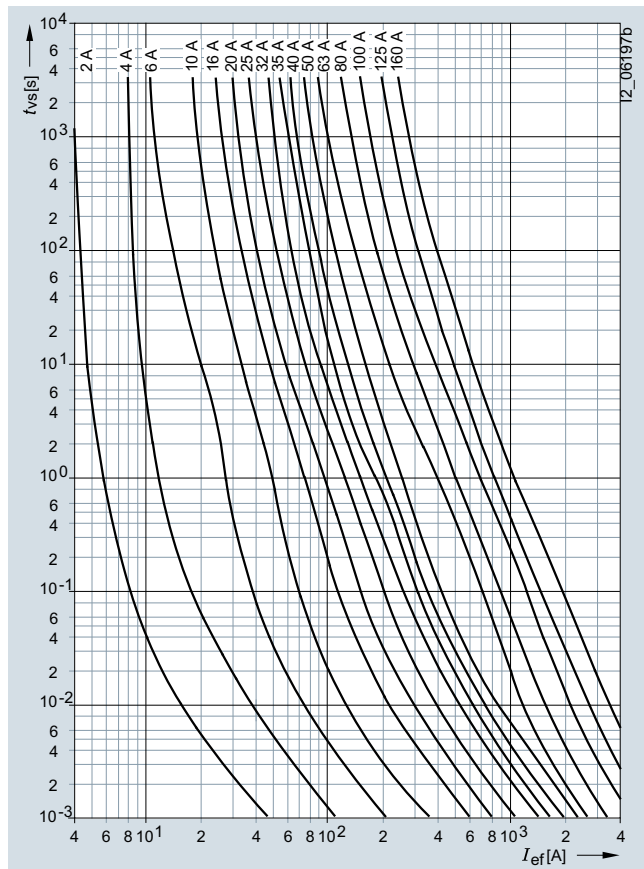

Melting I^2t values diagram

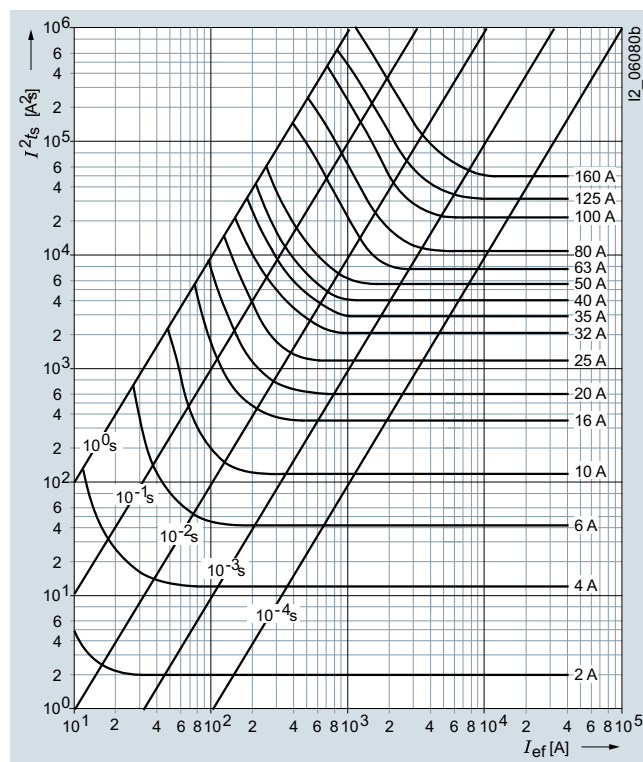
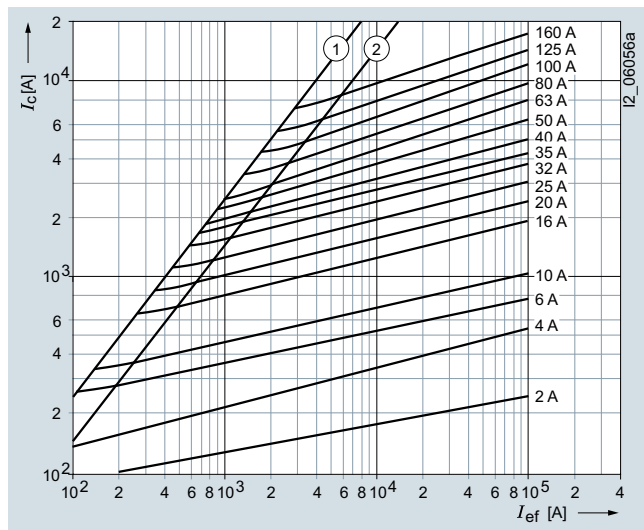

Table see page 57.

Current limiting diagram



- ① Peak short-circuit current with largest DC component
- ② Peak short-circuit current without DC component

3NA38, 3NA68, 3NA78 series

Size: 000, 00
 Operational class: gG
 Rated voltage: 500 V AC/250 V DC
 Rated current: 2 ... 160 A

Type	I_n	P_v	$\Delta 9$	$I^2 t_s$		$I^2 t_a$		
	A	W	K	1 ms A ² s	4 ms A ² s	230 V AC A ² s	400 V AC A ² s	500 V AC A ² s
3NA3802, 3NA6802, 3NA7802	2	1.3	8	2	2	4	6	9
3NA3804, 3NA6804, 3NA7804	4	0.9	6	11	13	18	22	27
3NA3801, 3NA6801, 3NA7801	6	1.3	8	46	50	80	110	150
3NA3803, 3NA6803, 3NA7803	10	1	8	120	130	180	265	370
3NA3805, 3NA6805, 3NA7805	16	1.7	11	370	420	580	750	1000
3NA3807, 3NA6807, 3NA7807	20	2	15	670	750	1000	1370	1900
3NA3810, 3NA6810, 3NA7810	25	2.3	17	1200	1380	1800	2340	3300
3NA3812, 3NA6812, 3NA7812	32	2.6	18	2200	2400	3400	4550	6400
3NA3814, 3NA3814-7, 3NA6814, 3NA7814	35	2.7	21	3000	3300	4900	6750	9300
3NA3817, 3NA6817, 3NA7817	40	3.1	24	4000	4500	6100	8700	12100
3NA3820, 3NA3820-7, 3NA6820, 3NA7820	50	3.8	25	6000	6800	9100	11600	16000
3NA3822, 3NA3822-7, 3NA6822, 3NA7822	63	4.6	28	7700	9800	14200	19000	26500
3NA3824, 3NA3824-7, 3NA6824, 3NA6824-7, 3NA7824, 3NA7824-7	80	5.8	33	12000	16000	23100	30700	43000
3NA3830, 3NA3830-7, 3NA6830, 3NA6830-7, 3NA7830, 3NA7830-7	100	6.6	34	24000	30600	40800	56200	80000
3NA3832, 3NA6832, 3NA7832	125	8.9	44	36000	50000	70000	91300	130000
3NA3832-8	125	7.2	30	46000	45000	97000	117000	134000
3NA3836, 3NA6836, 3NA7836	160	11.3	52	58000	85000	120000	158000	223000
3NA3836-8	160	9	34	89000	84800	137000	166000	--

Fuse Systems

3NA, 3ND LV HRC Fuse Systems

LV HRC fuse links

3NA38..-6, 3NA68..-6, 3NA78..-6 series

Size: 000, 00
 Operational class: gG
 Rated voltage: 690 V AC¹⁾/250 V DC
 Rated current: 2 ... 100 A

Time/current characteristics diagram

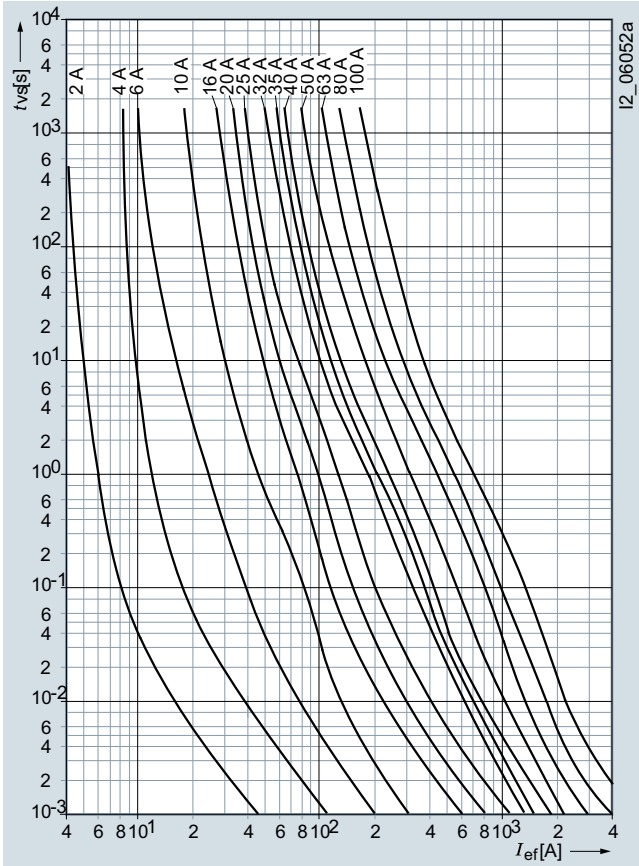

Melting I^2t values diagram

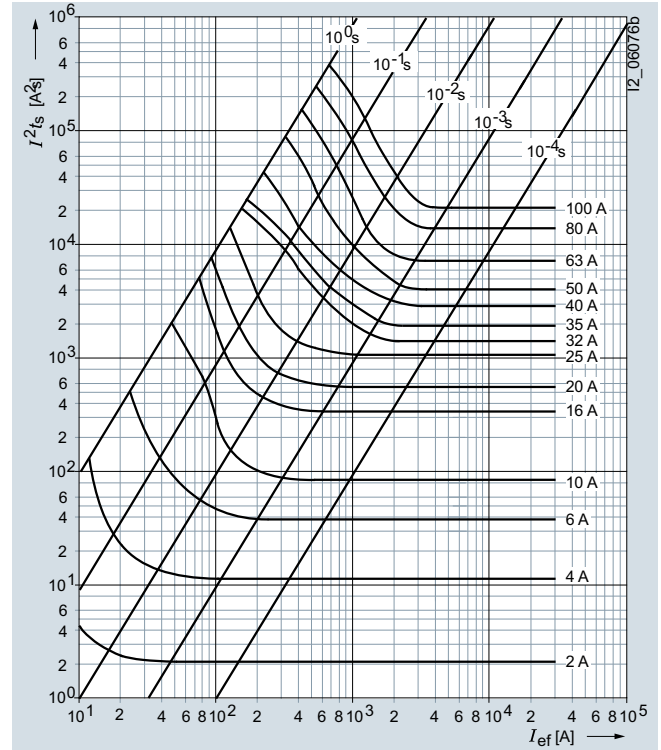

¹⁾ Manufacturer's confirmation for 690 V + 10 % rated voltage available on request.

Current limiting diagram

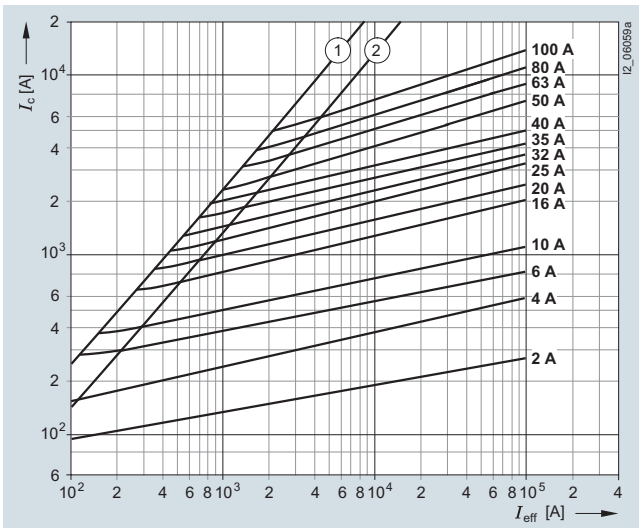

- ① Peak short-circuit current with largest DC component
- ② Peak short-circuit current without DC component

Fuse Systems

3NA, 3ND LV HRC Fuse Systems

LV HRC fuse links

Type	I_n	P_v	$\Delta\theta$	I^2t_s		I^2t_a			
	A	W	K	1 ms A ² s	4 ms A ² s	230 V AC A ² s	400 V AC A ² s	690 V AC A ² s	
3NA3802-6, 3NA6802-6, 3NA7802-6	2	1.3	8	2	2	4	6	9	
3NA3804-6, 3NA6804-6, 3NA7804-6	4	0.9	6	11	13	18	22	27	
3NA3801-6, 3NA6801-6, 3NA7801-6	6	1.3	8	36	44	80	110	150	
3NA3803-6, 3NA6803-6, 3NA7803-6	10	1	8	90	120	180	265	370	
3NA3805-6, 3NA6805-6, 3NA7805-6	16	1.7	11	330	360	580	750	1000	
3NA3807-6, 3NA6807-6, 3NA7807-6	20	2	15	570	690	1000	1370	1900	
3NA3810-6, 3NA6810-6, 3NA7810-6	25	2.3	17	1200	1380	1800	2340	3300	
3NA3812-6, 3NA6812-6, 3NA7812-6	32	3.1	19	1600	2600	3100	4100	5800	
3NA3814-6, 3NA6814-6, 3NA7814-6	35	3.6	23	2100	3100	4000	5000	7800	
3NA3817-6, 3NA6817-6, 3NA7817-6	40	3.6	18	3200	4700	6000	8600	12000	
3NA3817-6KJ, 3NA6817-6KJ, 3NA7817-6KJ	40	3.8	18	3800	4700	6000	8600	15000	
3NA3820-6, 3NA6820-6, 3NA7820-6	50	4.9	28	4400	7400	9100	11200	19000	
3NA3820-6KJ, 3NA6820-6KJ, 3NA7820-6KJ	50	4.9	28	5900	7400	9100	11200	19000	
3NA3822-6, 3NA6822-6, 3NA7822-6	63	5.7	33	7600	10100	13600	17000	24000	
3NA3824-6, 3NA6824-6, 3NA7824-6	80	6.7	38	13500	17000	24300	32000	55000	
3NA3830-6, 3NA6830-6, 3NA7830-6	100	9.1	40	21200	30500	42400	52000	75000	

Fuse Systems

3NA, 3ND LV HRC Fuse Systems

LV HRC fuse links

3NA61..-4 series

Size: 1
 Operational class: gG
 Rated voltage: 400 V AC
 Rated current: 35 ... 250 A

Time/current characteristics diagram

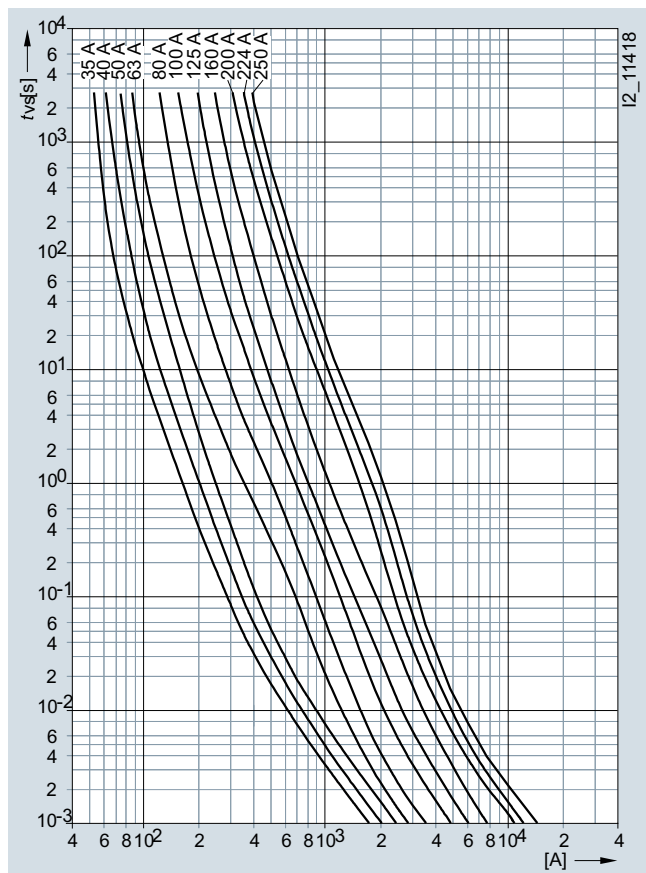

Melting I^2t values diagram

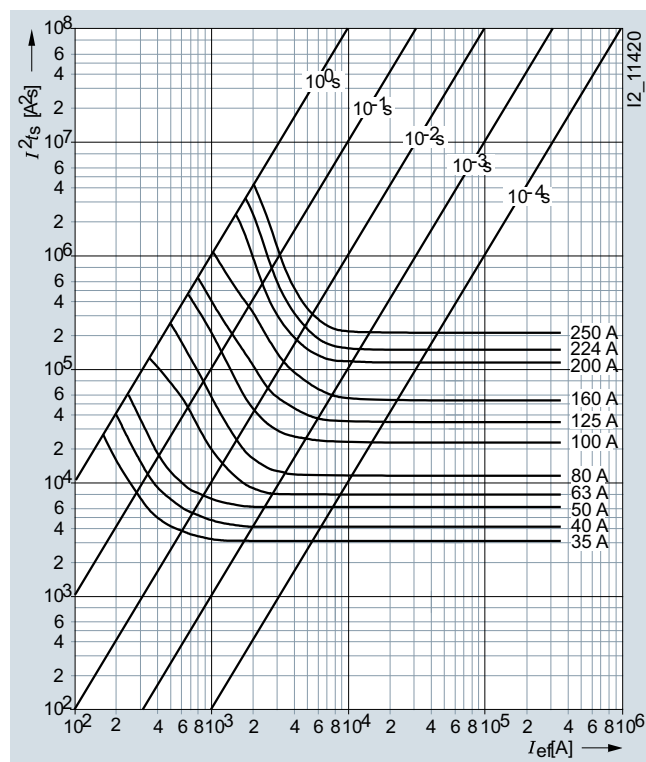

Current limiting diagram

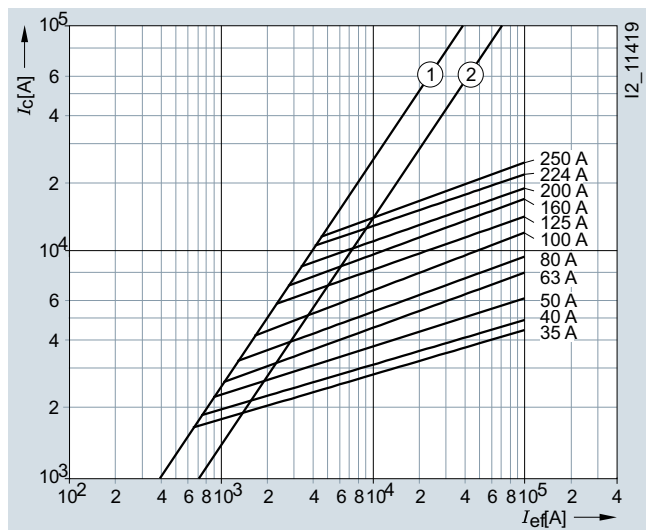

- ① Peak short-circuit current with largest DC component
- ② Peak short-circuit current without DC component

Type	I_n	P_v	$\Delta\theta$
	A	W	K
3NA6114-4	35	3.2	16
3NA6117-4	40	3.6	16
3NA6120-4	50	4.6	20
3NA6122-4	63	6.0	21
3NA6124-4	80	7.5	29
3NA6130-4	100	8.9	30
3NA6132-4	125	10.7	31
3NA6136-4	160	13.9	34
3NA6140-4	200	15.0	36
3NA6142-4	224	16.1	37
3NA6144-4	250	17.3	39

Type	I^2t_s		I^2t_a	
	1 ms A^2s	4 ms A^2s	230 V AC A^2s	400 V AC A^2s
3NA6114-4	3000	3300	4900	6750
3NA6117-4	4000	4500	6100	8700
3NA6120-4	6000	6800	9100	11600
3NA6122-4	7700	9800	14200	19000
3NA6124-4	12000	16000	23100	30700
3NA6130-4	24000	30600	40800	56200
3NA6132-4	36000	50000	70000	91300
3NA6136-4	58000	85000	120000	158000
3NA6140-4	115000	135000	218000	285000
3NA6142-4	145000	170000	299000	392000
3NA6144-4	205000	230000	420000	551000

3NA62..-4 series

Size: 2
Operational class: gG
Rated voltage: 400 V AC
Rated current: 50 ... 400 A

Time/current characteristics diagram

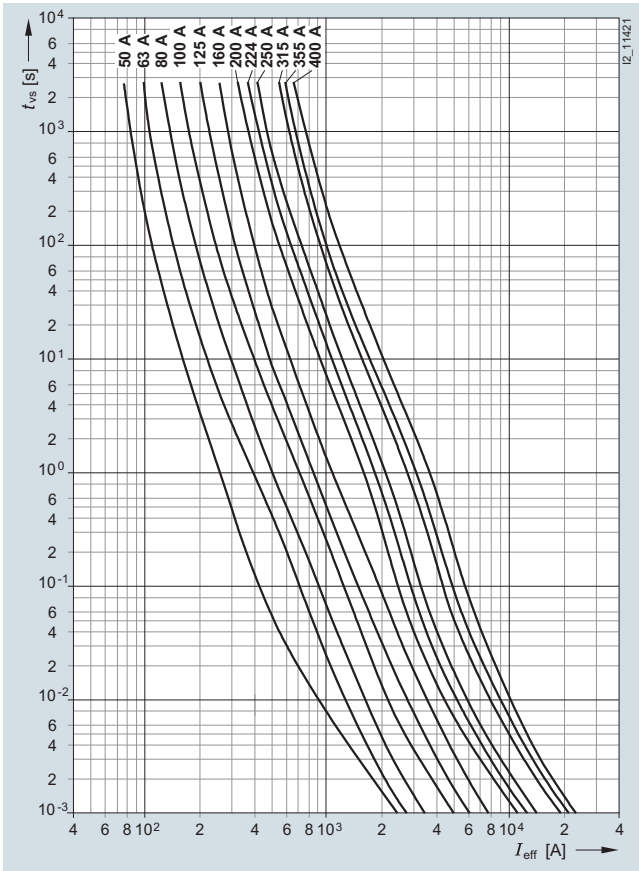

Melting I^2t values diagram

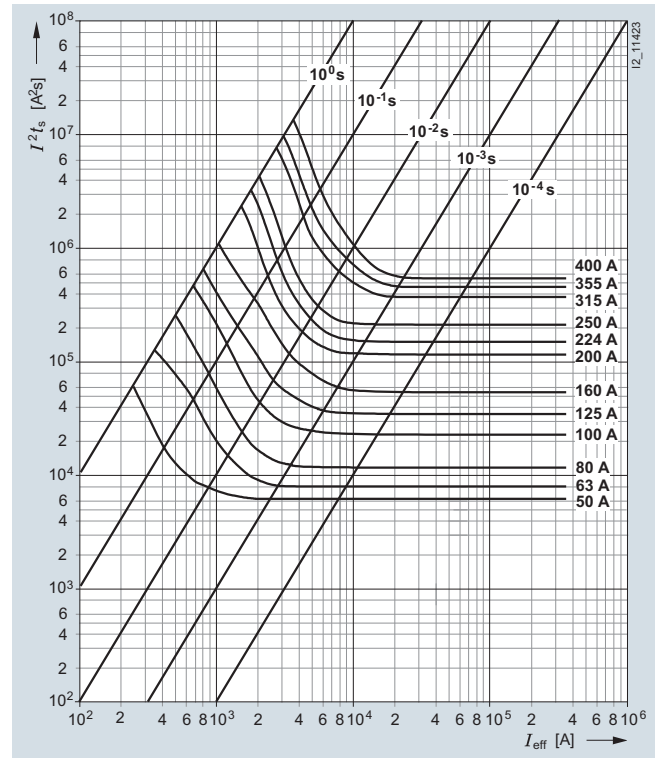

Current limiting diagram

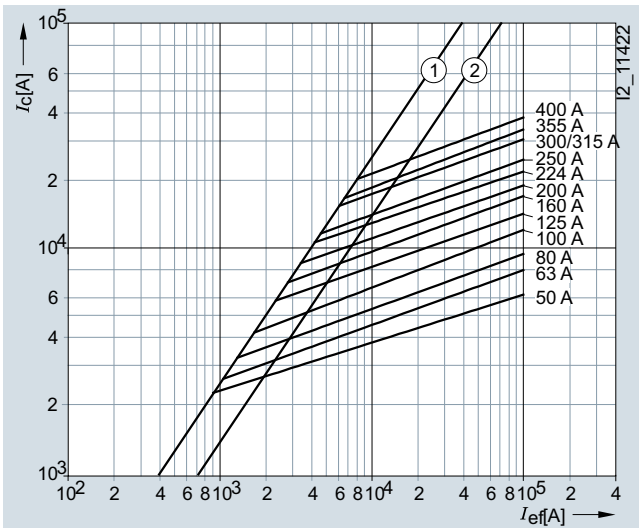

- ① Peak short-circuit current with largest DC component
- ② Peak short-circuit current without DC component

Type	I_n	P_v	$\Delta\theta$
	A	W	K
3NA6220-4	50	4.7	16
3NA6222-4	63	5.9	16
3NA6224-4	80	6.8	21
3NA6230-4	100	7.4	22
3NA6232-4	125	9.8	27
3NA6236-4	160	12.6	34
3NA6240-4	200	14.9	33
3NA6242-4	224	15.4	31
3NA6244-4	250	17.9	38
3NA6250-4	300	19.4	34
3NA6252-4	315	21.4	35
3NA6254-4	355	26.0	49
3NA6260-4	400	27.5	52

Type	I^2t_s		I^2t_a	
	1 ms A^2s	4 ms A^2s	230 V AC A^2s	400 V AC A^2s
3NA6220-4	6000	6800	9100	11600
3NA6222-4	7700	9800	14200	19000
3NA6224-4	12000	16000	23100	30700
3NA6230-4	24000	30600	40800	56200
3NA6232-4	36000	50000	70000	91300
3NA6236-4	58000	85000	120000	158000
3NA6240-4	115000	135000	218000	285000
3NA6242-4	145000	170000	299000	392000
3NA6244-4	205000	230000	420000	551000
3NA6250-4	361000	433000	670000	901000
3NA6252-4	361000	433000	670000	901000
3NA6254-4	441000	538000	800000	1060000
3NA6260-4	529000	676000	1155000	1515000

Fuse Systems

3NA, 3ND LV HRC Fuse Systems

LV HRC fuse links

3NA68..-4/4KK series

Size: 000, 00
 Operational class: gG
 Rated voltage: 400 V AC
 Rated current: 10 ... 160 A

Time/current characteristics diagram

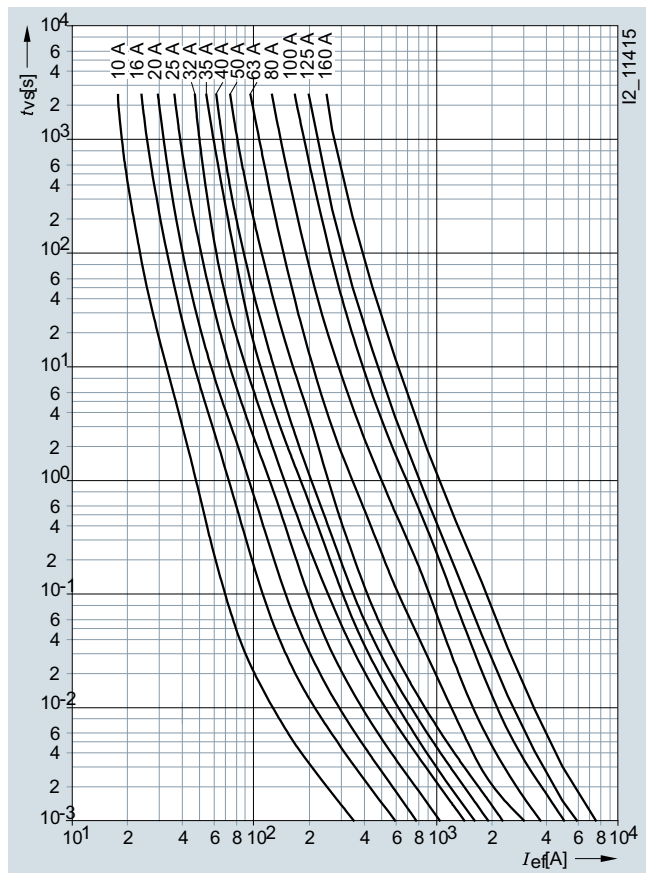

Current limiting diagram

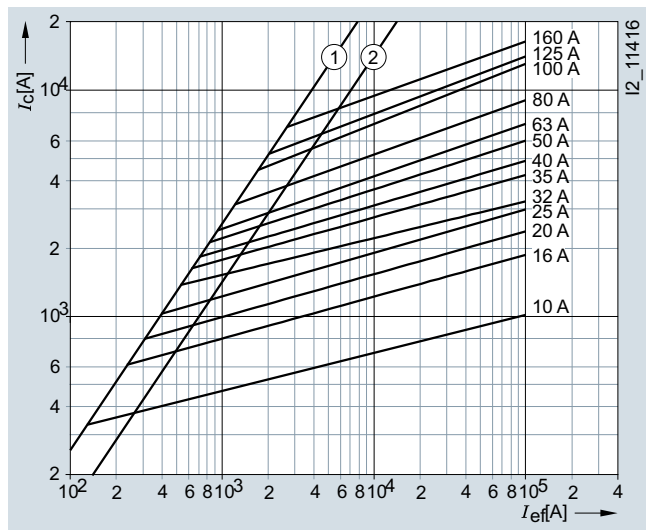

- ① Peak short-circuit current with largest DC component
- ② Peak short-circuit current without DC component

Melting I^2t values diagram

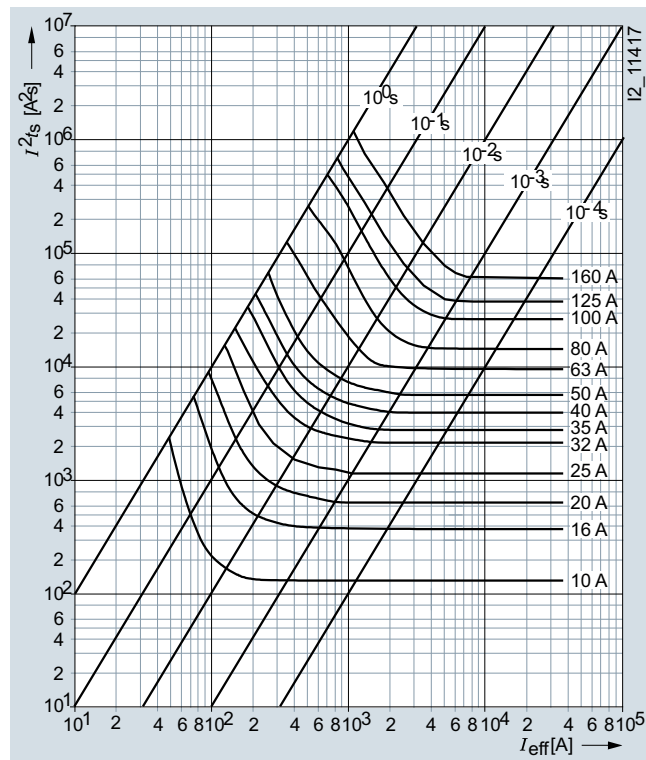

Type	I_n A	P_v W	$\Delta\theta$ K	I^2t_s	
				1 ms A^2s	4 ms A^2s
3NA6803-4	10	1.0	8	120	130
3NA6805-4	16	1.7	11	370	420
3NA6807-4	20	2.0	15	670	750
3NA6810-4	25	2.3	17	1200	1380
3NA6812-4	32	2.6	18	2200	2500
3NA6814-4	35	2.7	21	3000	3300
3NA6817-4	40	3.1	24	4000	4500
3NA6820-4	50	3.8	25	6000	6800
3NA6822-4	63	3.9	23	9300	10250
3NA6824-4, 3NA6824-4KK	80	4.9	26	14200	18300
3NA6830-4, 3NA6830-4KK	100	5.4	29	25600	33600
3NA6832-4	125	8.9	44	36000	50000
3NA6836-4	160	11.3	52	58000	85000

Type	I^2t_a	
	230 V AC A^2s	400 V AC A^2s
3NA6803-4	180	265
3NA6805-4	580	750
3NA6807-4	1000	1370
3NA6810-4	1800	2340
3NA6812-4	3400	4550
3NA6814-4	4900	6750
3NA6817-4	6100	8700
3NA6820-4	9100	11600
3NA6822-4	12400	17900
3NA6824-4, 3NA6824-4KK	27000	38000
3NA6830-4, 3NA6830-4KK	48300	69200
3NA6832-4	70000	91300
3NA6836-4	120000	158000

3ND18 series

Size: 000, 00
Operational class: aM
Rated voltage: 500 V AC
Rated current: 6 ... 160 A

Time/current characteristics diagram

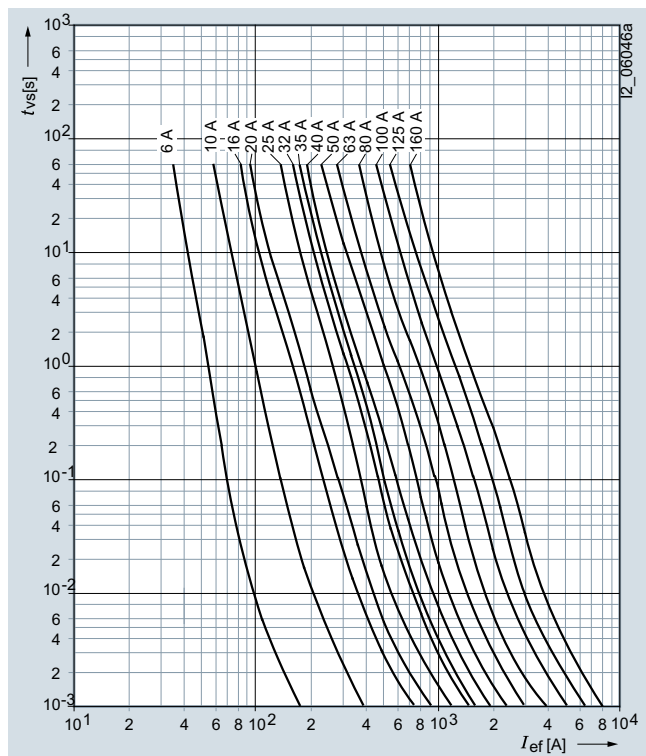

Melting I²t values diagram

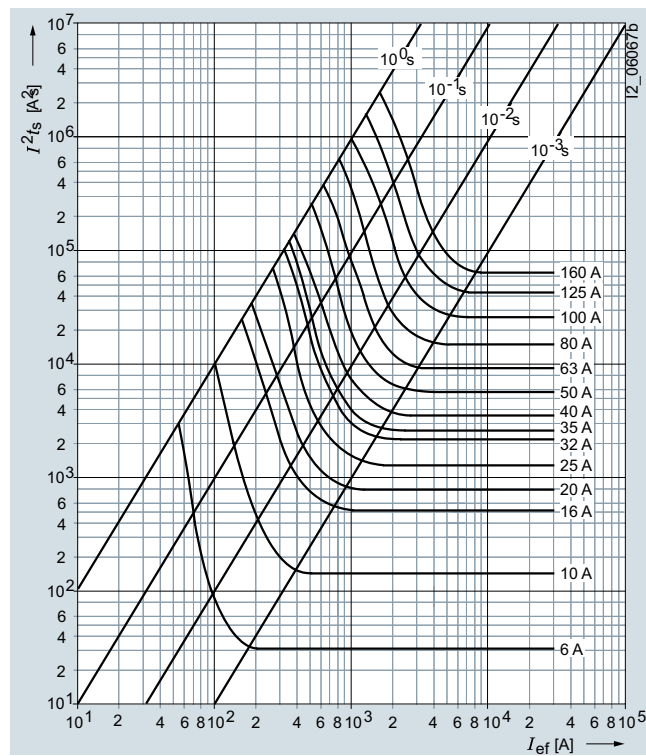

Current limiting diagram

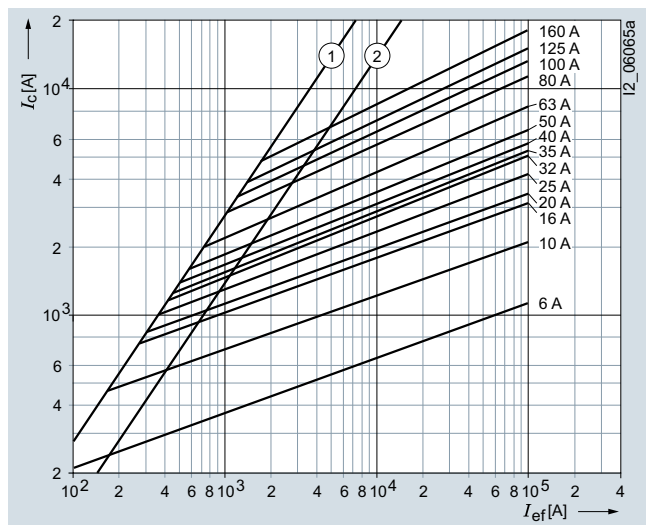

- ① Peak short-circuit current with largest DC component
- ② Peak short-circuit current without DC component

Type	I_n	P_v	$\Delta\theta$	I^2t_s	
	A	W	K	1 ms A ² s	4 ms A ² s
3ND1801	6	0.8	7	32	55
3ND1803	10	0.5	5	150	260
3ND1805	16	0.8	7	570	800
3ND1807	20	1	8	830	1200
3ND1810	25	1.2	9	1400	2000
3ND1812	32	1.5	10	2300	3300
3ND1814	35	1.8	11	2600	3800
3ND1817	40	2	12	3700	5500
3ND1820	50	2.4	14	5800	8400
3ND1822	63	3.3	17	9300	13000
3ND1824	80	4.5	20	15000	21000
3ND1830, 3ND1830-8	100	4.9	18	26000	37000
3ND1832	125	6.3	22	41000	60000
3ND1836	160	9.3	31	64000	92000

Type	I^2t_a		
	230 V AC A ² s	400 V AC A ² s	500 V AC A ² s
3ND1801	60	75	110
3ND1803	280	320	430
3ND1805	1000	1300	1600
3ND1807	1300	1600	2200
3ND1810	2200	2800	3300
3ND1812	3800	4500	5400
3ND1814	4200	5100	6300
3ND1817	5700	7200	9300
3ND1820	5200	10500	12500
3ND1822	15000	16500	21000
3ND1824	21500	27000	34000
3ND1830, 3ND1830-8	44000	56000	76000
3ND1832	76000	98000	135000
3ND1836	105000	130000	170000

Fuse Systems

3NA, 3ND LV HRC Fuse Systems

LV HRC fuse links

3ND13..., 3ND2 series

Size: 1, 2, 3
 Operational class: aM
 Rated voltage: 690 V AC
 Rated current: 63 ... 630 A

Time/current characteristics diagram

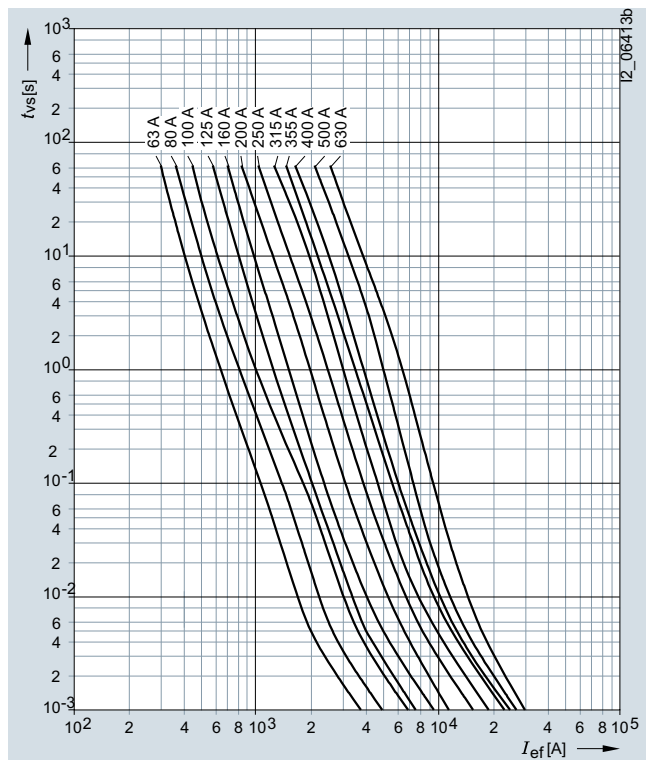

Melting I²t values diagram

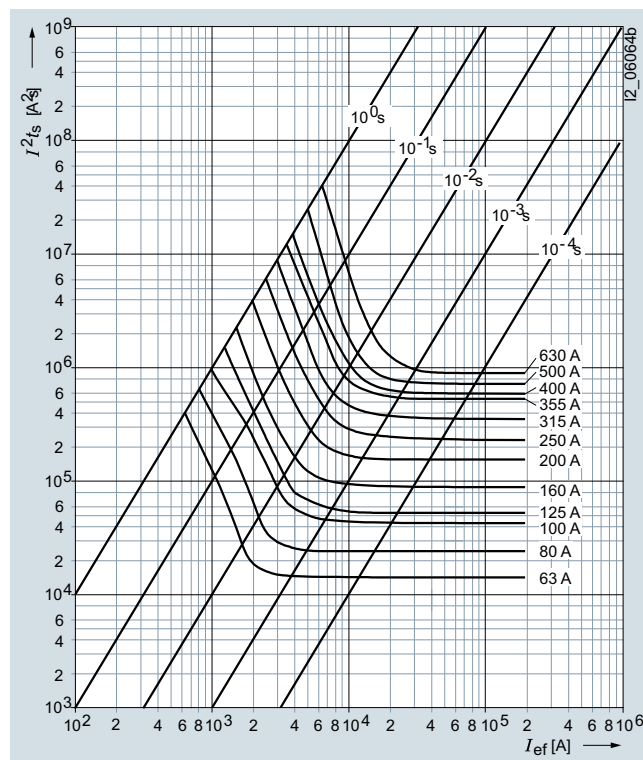

Current limiting diagram

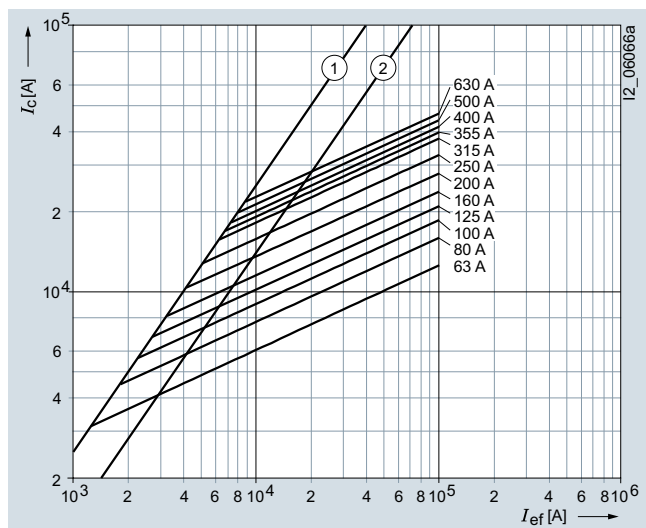

- ① Peak short-circuit current with largest DC component
- ② Peak short-circuit current without DC component

Table see page 65.

3ND13.., 3ND2 series

Size: 1, 2, 3
 Operational class: aM
 Rated voltage: 690 V AC
 Rated current: 63 ... 630 A

Type	I_n	P_v	$\Delta\theta$	I^2t_s		I^2t_a		
	A	W	K	1 ms A ² s	4 ms A ² s	230 V AC A ² s	400 V AC A ² s	690 V AC A ² s
3ND2122	63	4	12.2	14000	17700	19300	25600	42000
3ND2124	80	4.9	13	24200	30800	36500	48000	80000
3ND2130	100	5.8	15	45600	59000	65000	85000	140000
3ND2132	125	8.1	16.5	57000	74300	73000	97000	160000
3ND2136	160	11.4	18	90000	114000	107000	142000	235000
3ND2140	200	14.1	19.5	150000	198000	172000	228000	375000
3ND2144	250	18	22	250000	313000	260000	340000	565000
3ND2232	125	8.1	16.5	57000	74300	73000	97000	160000
3ND2236	160	11.4	18	90000	114000	107000	142000	235000
3ND2240	200	14.1	19.5	150000	198000	172000	228000	375000
3ND2244	250	18	22	250000	313000	260000	340000	565000
3ND2252	315	22.6	30	370000	450000	460000	610000	1000000
3ND2254	355	24.7	29	540000	643000	645000	855000	1400000
3ND2260	400	30.8	35	615000	750000	688000	910000	1500000
3ND2352	315	22.6	30	370000	450000	460000	610000	1000000
3ND2354	355	24.7	29	540000	643000	645000	855000	1400000
3ND2360	400	30.8	26	615000	750000	688000	910000	1500000
3ND1365	500	47	40	730000	933000	876000	1095000	1825000
3ND1372	630	50	43	920000	1375000	1300000	1800000	2600000

Fuse Systems

3NA, 3ND LV HRC Fuse Systems

LV HRC fuse links

Dimensional drawings

LV HRC fuse links, operational class gG

Sizes 000 to 3 and 4a

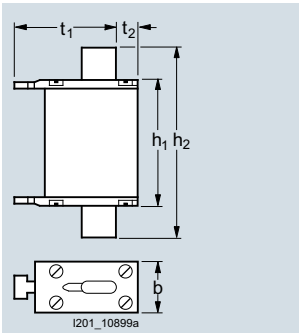

Size 4 (IEC design)

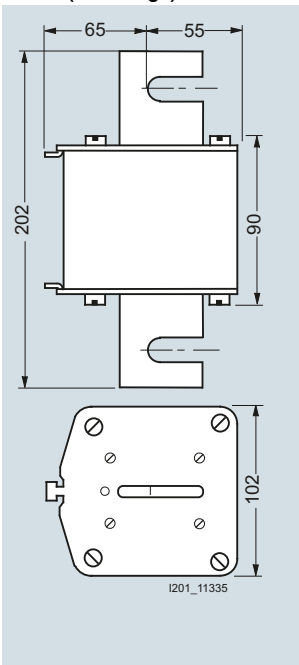

Size	I_n A	U_n V	Type	Dimensions										
				b	h_1	h_2	t_1	t_2						
000	2 ... 35	690 AC/250 DC	3NA38..-6	21	54	80	45	8						
	2 ... 160	500 AC	3NA38../-8											
	2 ... 100	500 AC/250 DC	3NA68..											
	10 ... 100	400 AC	3NA68../-4											
	2 ... 35	690 AC/250 DC	3NA68../-6											
	10 ... 100	500 AC/250 DC	3NA78..											
00	2 ... 35	690 AC/250 DC	3NA78../-6	30	54	80	45	14						
	35 ... 160	500 AC/250 DC	3NA38..											
	40 ... 100	690 AC/250 DC	3NA38../-6											
	80 ... 160	500 AC/250 DC	3NA68../-7											
	80 ... 160	400 AC	3NA68../-4 (KK)											
	40 ... 100	690 AC/250 DC	3NA68../-6											
0	80 ... 160	500 AC/250 DC	3NA78../-7	30	67	126	45	14						
	40 ... 100	690 AC/250 DC	3NA78../-6											
	6 ... 160	500 AC/440 DC	3NA30..											
	1	16 ... 160	500 AC/440 DC						3NA31..	30	75	137	50	15
		50 ... 160	690 AC/440 DC						3NA31../-6					
		16 ... 160	500 AC/440 DC						3NA61..					
35 ... 160		400 AC	3NA61../-4											
50 ... 160		690 AC/440 DC	3NA61../-6											
16 ... 160		500 AC/440 DC	3NA71..											
1	50 ... 160	690 AC/440 DC	3NA71../-6	47	75	137	51	9						
	200 ... 250	500 AC/440 DC	3NA31..											
	200	690 AC/440 DC	3NA31../-6											
	200 ... 250	500 AC/440 DC	3NA61..											
	200 ... 250	400 AC	3NA61../-4											
	200	690 AC/440 DC	3NA61../-6											
2	200 ... 250	500 AC/440 DC	3NA71..	47	75	151	58	10						
	200 ... 250	690 AC/440 DC	3NA71../-6											
	35 ... 250	500 AC/440 DC	3NA32..											
	80 ... 200	690 AC/440 DC	3NA32../-6											
	35 ... 250	500 AC/440 DC	3NA62..											
	50 ... 250	400 AC	3NA62../-4											
2	80 ... 200	690 AC/440 DC	3NA62../-6	58	74	151	59	13						
	35 ... 250	500 AC/440 DC	3NA72..											
	80 ... 200	690 AC/440 DC	3NA72../-6											
	300 ... 400	500 AC/440 DC	3NA32..											
	224 ... 250	690 AC/440 DC	3NA32../-6											
	300 ... 400	500 AC/440 DC	3NA62..											
3	300 ... 400	400 AC	3NA62../-4	71	74	151	70	13						
	224 ... 315	690 AC/440 DC	3NA62../-6											
	300 ... 400	500 AC/440 DC	3NA72..											
	224 ... 315	690 AC/440 DC	3NA72../-6											
	200 ... 400	500 AC/440 DC	3NA33..											
	250, 315	690 AC/440 DC	3NA33../-6											
4	425 ... 630	500 AC/440 DC	3NA33..	71	74	151	70	13						
	355 ... 500	690 AC/440 DC	3NA33../-6											
	630 ... 1250	500 AC/440 DC	3NA34..						See adjacent drawing					
4a	500 ... 1250	500 AC/440 DC	3NA36..	102	97	201	95	20						

LV HRC fuse links, operational class aM

Sizes 000 to 3

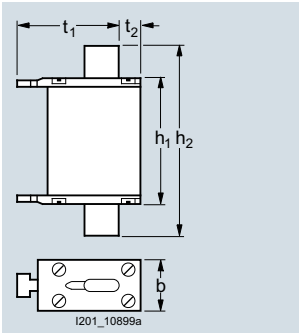

Size	I_n A	U_n V	Type	Dimensions				
				b	h_1	h_2	t_1	t_2
000	6 ... 80	500 AC	3ND18..	21	54	80	45	8
00	100 ... 160			30	54	80	45	14
1	63 ... 100	690 AC	3ND21..	30	75	137	50	15
	125 ... 250			47	75	137	51	9
2	125 ... 250	690 AC	3ND22..	47	75	151	58	10
	315 ... 400			58	74	151	59	13
3	315 ... 400	690 AC	3ND23..	58	74	151	71	13
	500, 630		3ND13..	71	74	151	70	13

Fuse Systems

3NA, 3ND LV HRC Fuse Systems

LV HRC signal detectors

Overview

LV HRC signal detectors are used for remotely indicating that the LV HRC fuse links have been tripped. Three different solutions are available:

- 3NX1021 signal detectors with signal detector link
The LV HRC signal detectors with signal detector link support monitoring of LV HRC fuse links with non-insulated grip lugs of sizes 000 to 4 at 10 A or more. The signal detector link is connected in parallel to the fuse link. In the event of a fault, the LV HRC fuse links are released simultaneously with the LV HRC fuse detector link. A trip pin switches a floating micro-switch

- 3NX1024 signal detector tops
The signal detector top can be used with LV HRC fuse links, sizes 000, 00, 1 and 2, which are equipped with non-insulated grip lugs and have a front indicator or combination alarm. It is simply plugged into the grip lugs
- 5TT3170 fuse monitors
If a fuse is tripped, the front indicator springs open and switches a floating microswitch. This solution should not be used for safety-relevant systems. For this purpose, we recommend our electronic fuse monitors

Dimensional drawings

LV HRC signal detectors

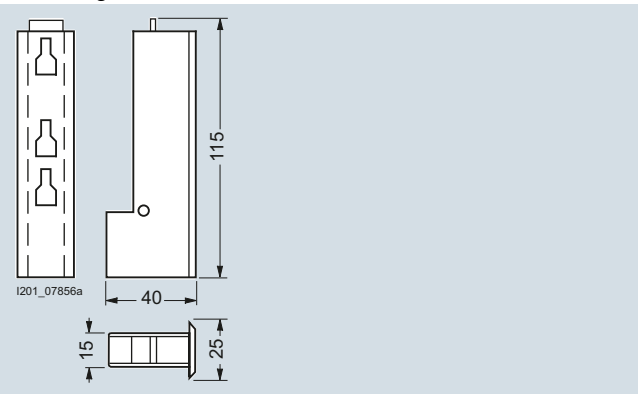

3NX1021

Signal detector links

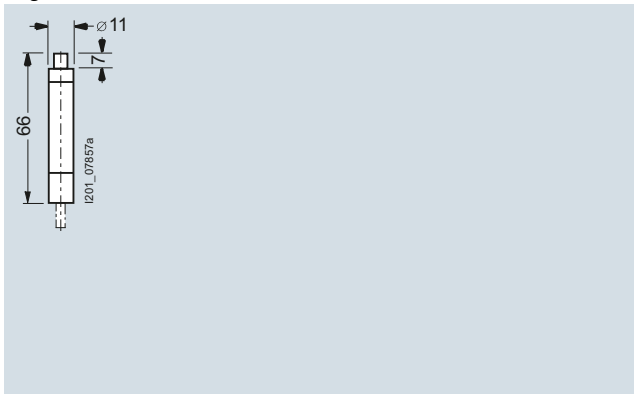

3NX1022, 3NX1023

Signal detector tops

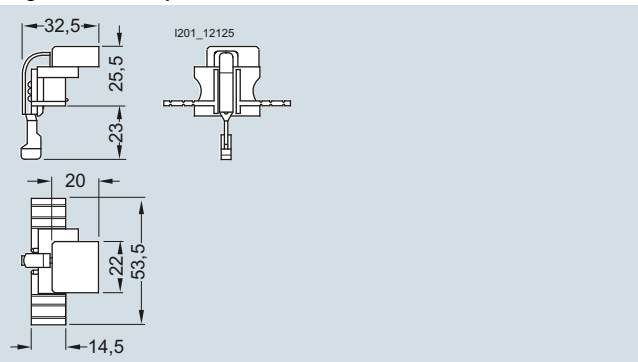

3NX1024

Fuse monitors

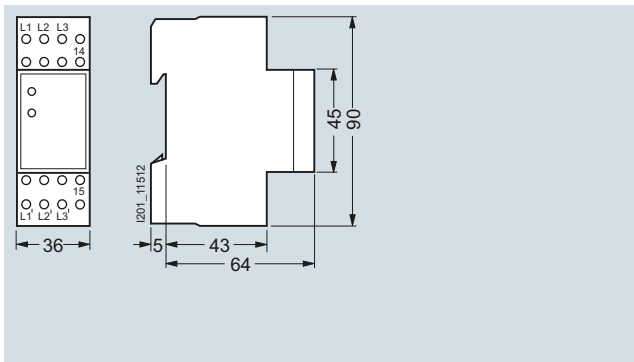

5TT3170

Circuit diagrams

Graphical symbols

LV HRC signal detectors Signal detector tops

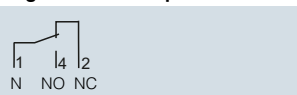
3NX1021
3NX1024

Fuse monitors

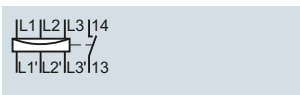

5TT3170

Overview

Terminals for all applications



Flat terminals with screws are suitable for connecting busbars or cable lugs. They have a torsion-proof screw connection with shim, spring washer and nut. When tightening the nut, always ensure compliance with the specified torque due to the considerable leverage effect.

The double busbar terminal differs from the flat terminal in that it supports connection of two busbars, one on the top and one at the bottom of the flat terminal.

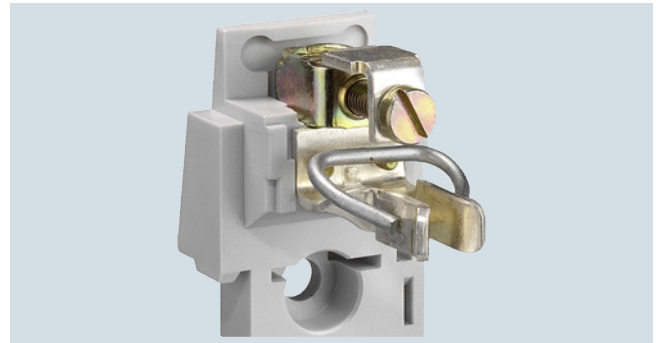

The modern box terminal ensures efficient and reliable connection to the conductors. They support connection of conductors with or without end sleeve.



With the flat terminal with nut, terminal lug of the nut is torsion-proof. When tightening the nut, the torque must be observed because of the considerable leverage effect.



Up to three conductors can be clamped to the terminal strip.



The plug-in terminal is equipped for connecting two conductors.



One conductor can be clamped to the saddle-type terminal.

Fuse Systems

3NA, 3ND LV HRC Fuse Systems

LV HRC fuse bases and accessories

Technical specifications

Size	LV HRC fuse bases, LV HRC bus-mounting bases						
	000/00	0	1	2	3	4	
Standards	IEC 60269-1, -2; EN 60269-1; DIN VDE 0636-2, UL 4248-1 (only downstream from the branch protection)						
Approvals	KEMA, UL File No: E171267-IZLT2						
Rated current I_n	A	160	160	250	400	630	1250
Rated voltage U_n	V AC	690 ¹⁾	690 ¹⁾				690
	V DC	250	440				440
Rated short-circuit strength	kA AC	120					
	kA DC	25					
Max. power dissipation of the fuse link	W	12	25	32	45	60	90
Flat terminal							
Screw		M8		M10		M12	
Nut		M8	--				
Max. tightening torque	Nm	14		38			65
Plug-in terminal							
Conductor cross-section	mm ²	2.5 ... 50		--			
Saddle-type terminal							
Conductor cross-section	mm ²	6 ... 70	--				
Box terminal							
Conductor cross-section	mm ²	2.5 ... 50					
Terminal strips							
Conductor cross-section, 3-wire	mm ²	1.5 ... 16	--				
Max. torque for attachment of LV HRC fuse base	Nm	2		2.5			--

¹⁾ Extended rated voltage up to 1000 V (except LV HRC bus-mounting bases).

Size	LV HRC fuse bases with swivel mechanism				
	000/00	1	3	4a	
Rated voltage U_n	V AC	690			
	V DC	440			
Max. power dissipation of the fuse link	W	12	32	48	110
Flat terminal					
Screw		M8	M10	M12	M16
Nut		M8	--		
Max. tightening torque	Nm	14	38		65

Dimensional drawings

LV HRC fuse bases made of molded plastic

Size 000/00, 1P

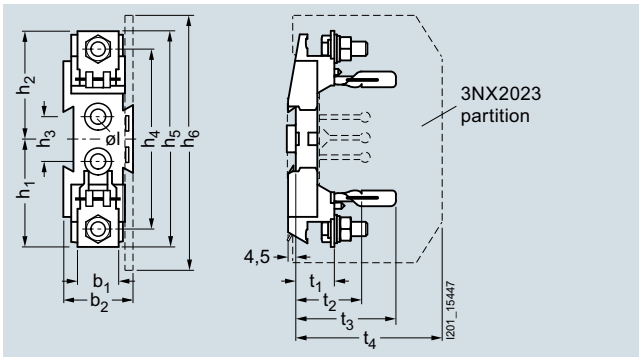

3NH3051 to 3NH3053

Size	I_n A	Poles	Connections	Type	b_1	b_2	h_1	h_2	h_3	h_4	h_5	h_6	$\varnothing l$	t_1	t_2	t_3	t_4
000/00	160	1P	M8 flat terminal, screw	3NH3051	23	39	61	61	25	101	121	139	7.5	26	42	61	86
			Saddle-type terminal	3NH3052	--	39	60	60	25	108	120	139	7.5	26	42	61	86
			Box terminals	3NH3053	--	39	59	50	25	99	117	139	7.5	23	39	61	86

LV HRC fuse bases made of ceramic

Size 000/00
1P

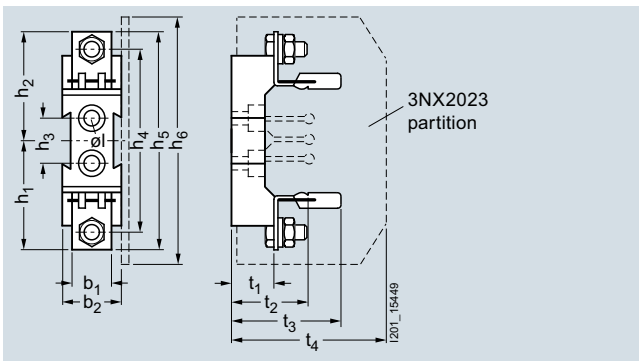

3NH303., 3NH3050

3P

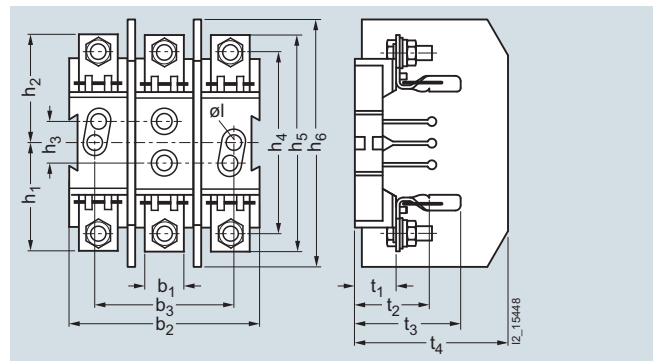

3NH403.

Size	I_n A	Poles	Connections	Type	b_1	b_2	b_3	h_1	h_2	h_3	h_4	h_5	h_6	$\varnothing l$	t_1	t_2	t_3	t_4
000/00	160	1P	Flat terminal, screw	3NH3030	23	34	--	61	61	25	102	122	139	7.5	24	40	60	86
			M8 plug-in terminal	3NH3031	31	34	--	64	64	25	102	128	139	7.5	24	40	60	86
			Saddle-type terminal	3NH3032	29	34	--	61	61	25	109	122	139	7.5	24	40	60	86
			Flat terminal, terminal strip	3NH3035	26	34	--	61	70	25	113	130	139	7.5	24	40	60	86
			Flat terminal, nut	3NH3038	23	34	--	61	61	25	102	122	139	7.5	24	40	60	86
			Flat and saddle-type terminals	3NH3050	29	34	--	61	61	25	102	122	139	7.5	24	40	60	86
000/00	160	3P	Flat terminal	3NH4030	23	102	70	61	61	25	102	122	139	7.5	24	40	60	86
			M8 plug-in terminal	3NH4031	31	102	70	64	64	25	102	128	139	7.5	24	40	60	86
			Saddle-type terminal	3NH4032	29	102	70	61	61	25	102	122	139	7.5	24	40	60	86
			Flat terminal, terminal strip	3NH4035	26	102	70	61	70	25	113	130	139	7.5	24	40	60	86

Fuse Systems

3NA, 3ND LV HRC Fuse Systems

LV HRC fuse bases and accessories

Size 0, 1P

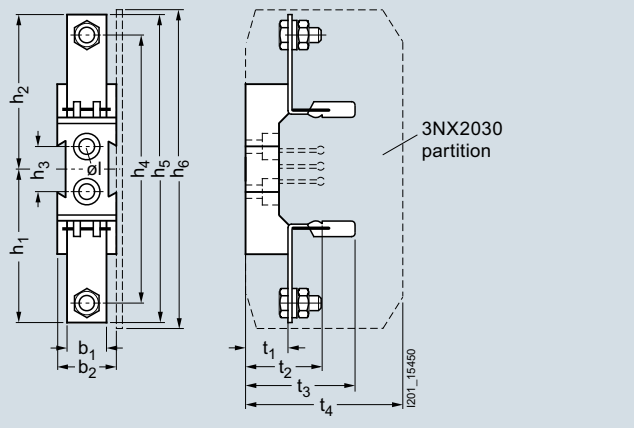

3NH312.

Size	I_n A	Poles	Connections	Type	b_1	b_2	h_1	h_2	h_3	h_4	h_5	h_6	$\varnothing l$	t_1	t_2	t_3	t_4
0	160	1P	Flat terminal	3NH3120	23	38	87	87	25	150	173	179	7.5	24	40	60	88
			Plug-in terminal	3NH3122	31	38	87	87	25	150	173	179	7.5	24	40	60	88

Size 1 1P

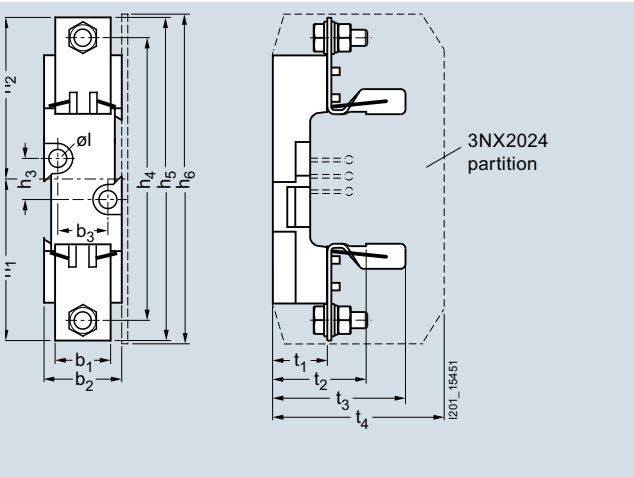

3NH32.0

3P

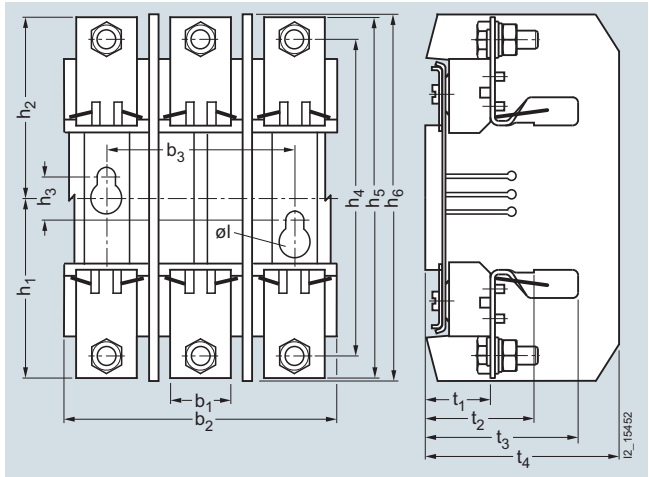

3NH4230

Size	I_n A	Poles	Connections	Type	b_1	b_2	b_3	h_1	h_2	h_3	h_4	h_5	h_6	$\varnothing l$	t_1	t_2	t_3	t_4
1	250	1P	M10 flat terminal	3NH3230	35	49	30	101	101	25	177	202	203	10.5	35	55	84	107
			Double busbar terminal	3NH3220	35	49	30	101	101	25	177	202	203	10.5	35	55	84	107
		3P	M10 flat terminal	3NH4230	35	146	111	101	101	25	177	202	203	10.5	35	55	84	107

Size 2
1P

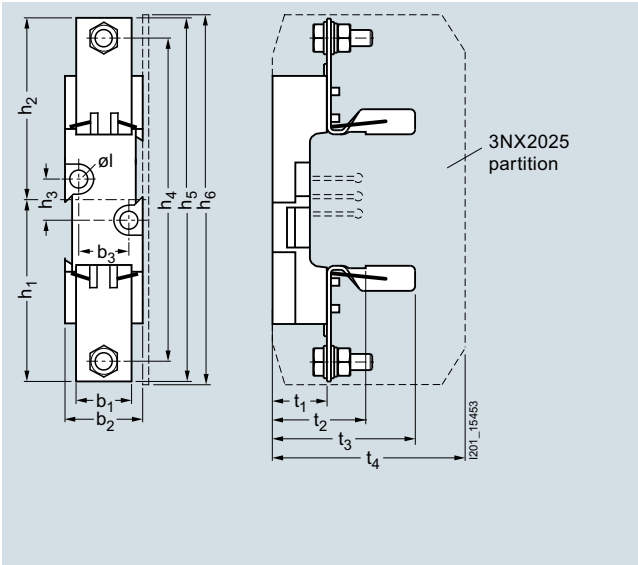

3NH33.0

Size 3
1P

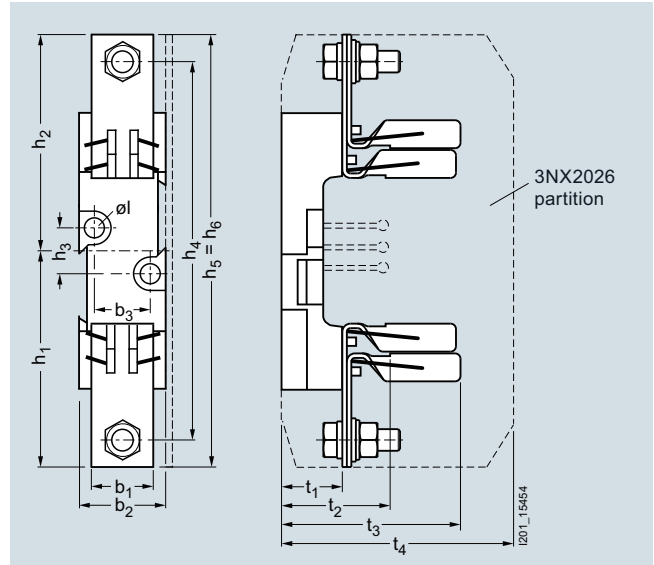

3NH34.0

Size	I_n A	Poles	Connections	Type	b_1	b_2	b_3	h_1	h_2	h_3	h_4	h_5	h_6	$\varnothing l$	t_1	t_2	t_3	t_4
2	400	1P	M10 flat terminal	3NH3330	35	49	30	113	113	25	202	227	228	10.5	35	55	90	115
			Double busbar terminal	3NH3320	35	49	30	113	113	25	202	227	228	10.5	35	55	90	115
3	630	1P	M12 flat terminal	3NH3430	35	49	30	121	121	25	212	242	242	10.5	35	57	101	130
			Double busbar terminal	3NH3420	35	49	30	121	121	25	212	242	242	10.5	35	57	101	130

Size 4, 1P

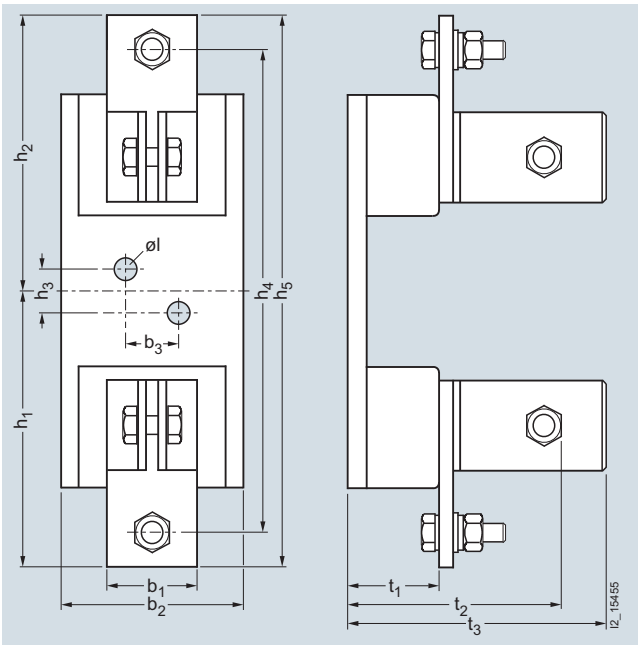

3NH3530

Size	I_n A	Poles	Connections	Type	b_1	b_2	b_3	h_1	h_2	h_3	h_4	h_5	$\varnothing l$	t_1	t_2	t_3
4 ¹⁾	1250	1P	M12 flat terminal	3NH3530	50	102	30	156	156	25	270	312	13	51	116	144
4a	Can only be used in bases with swivel mechanism															

¹⁾ Size 4 LV HRC fuse links are also screwed onto the base.

Fuse Systems

3NA, 3ND LV HRC Fuse Systems

LV HRC fuse bases and accessories

LV HRC fuse bases with swivel mechanism

Sizes 000/00, 1, 3 and 4a

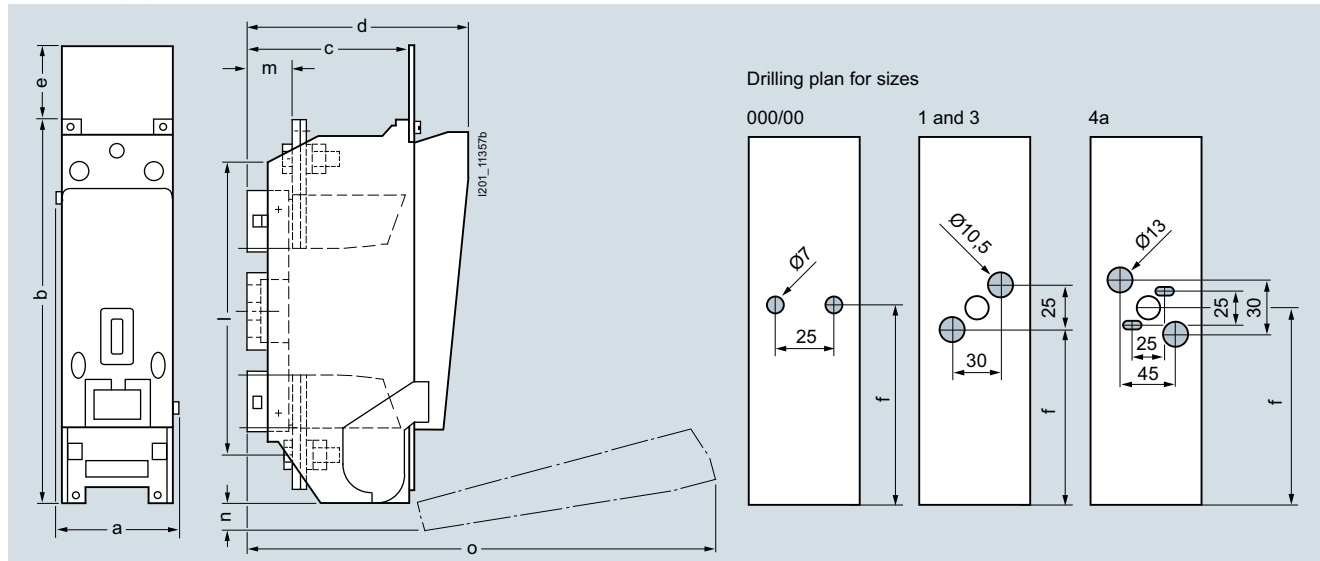

3NH703., 3NH723., 3NH733., 3NH7520

Size	I_n A	Type	a	b	c	d	e	f	l	m	n	o
000/00	160	3NH7030, 3NH7031, 3NH7032	49	149	45	86		79	120	17	20	
1	250	3NH7230, 3NH7231, 3NH7232	69	230	68	119		102.5	177	25	38	
3	630	3NH7330, 3NH7331, 3NH7332	91	270	96	147		122.5	220.5	30.5	35	
4a	1250	3NH7520	116	350	155	218	69	172.5	270	40	18	439

LV HRC contact covers for LV HRC fuse bases and LV HRC bus-mounting bases¹⁾

Sizes 000/00 to 3

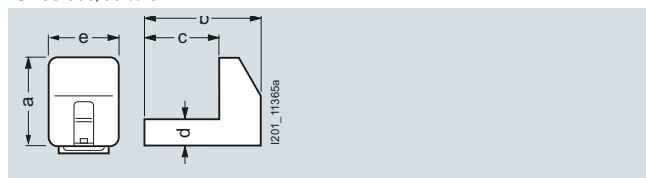

3NX3105 to 3NX3108, 3NX3114

Size	Type	a	b	c	d	e
000/00	3NX3105 ¹⁾	38	47.5	34	11.5	30
0	3NX3114	51.5	47.5	34	11.5	30
1	3NX3106	61.5	57	42.5	35	46
2	3NX3107	74	65	51	35	46
3	3NX3108	81.5	77.5	57.5	35	46

¹⁾ The 3NX3105 LV HRC contact covers can be used for both LV HRC fuse bases and LV HRC bus-mounting bases.

LV HRC contact covers for LV HRC bus-mounting bases



3NX3113 for the incoming terminal, dimensional drawing 3NX3105 for the outgoing terminal, see dimensional drawing above

3NX3115 LV HRC protective covers, with 3NX3116 LV HRC covers

Size 000/00, degree of protection IP2X

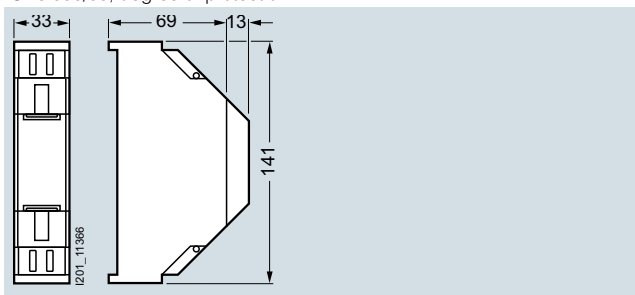

LV HRC partitions for LV HRC fuse bases

Size 000/00

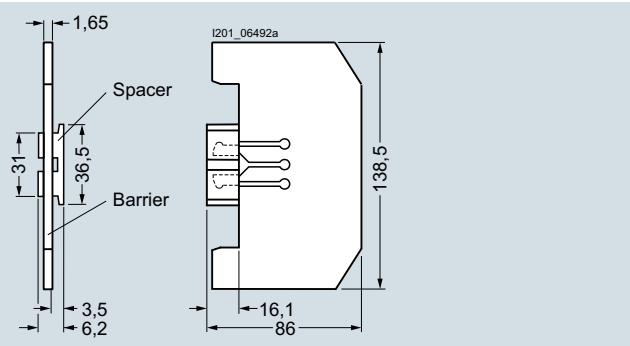

3NX2023

Sizes 0 to 3

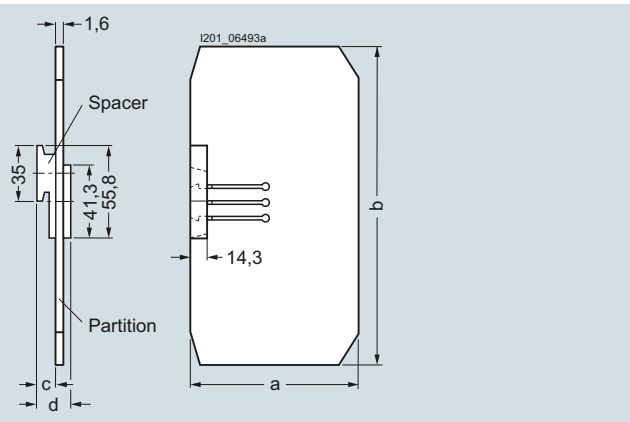

3NX2030, 3NX2024 to 3NX2026

Size	Type	a	b	c	d
0	3NX2030	87.6	178.5	7.7	12.3
1	3NX2024	107.3	202.5	7.7	12.3
2	3NX2025	115.3	227.5	14.2	25.1
3	3NX2026	129.8	242	20.2	37.2

LV HRC partitions for LV HRC bus-mounting bases

Size 000/00

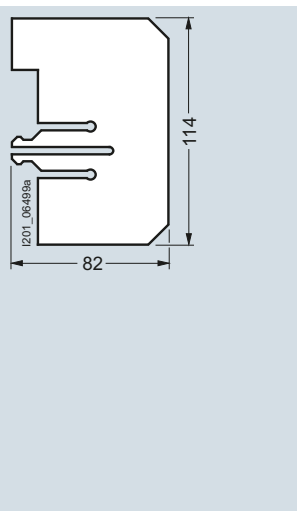

Phase barrier
3NX2027

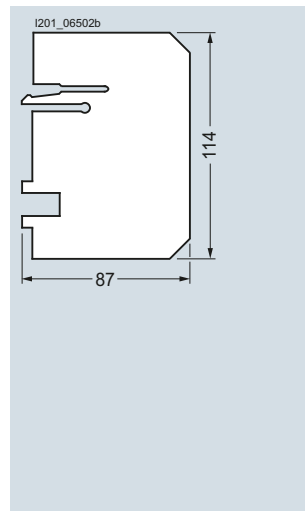

End barrier
3NX2028

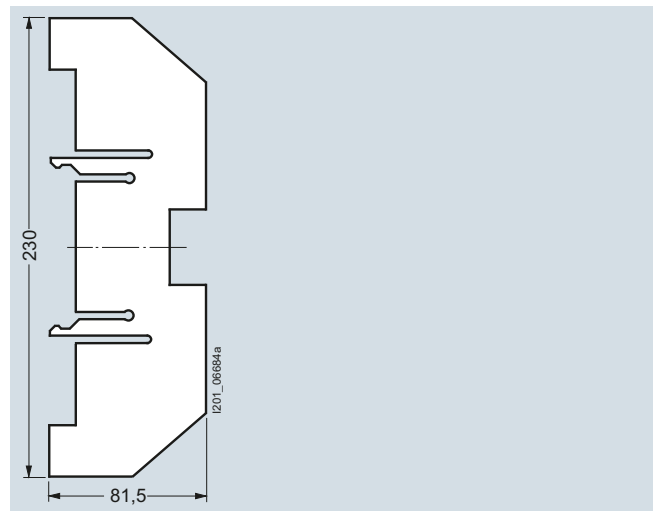

For LV HRC bus-mounting bases in tandem design
3NX2031

Fuse Systems

3NA, 3ND LV HRC Fuse Systems

LV HRC fuse bases and accessories

Fuse pullers

Sizes 000 to 4

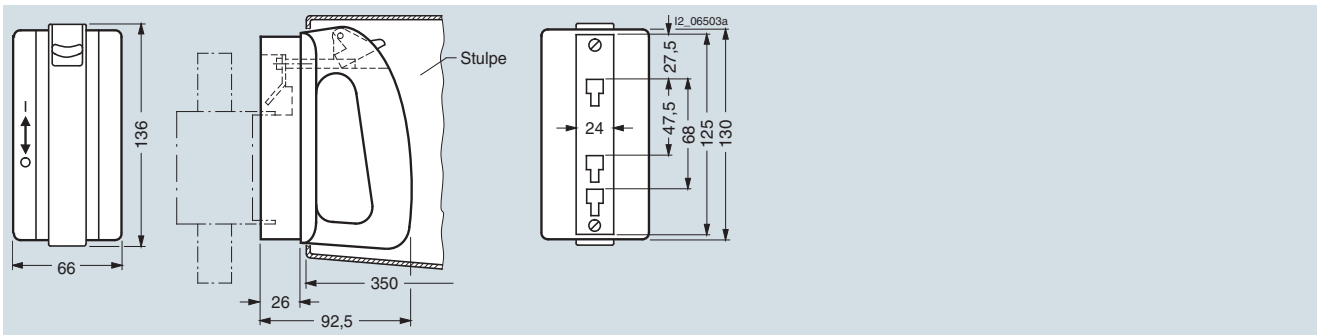

3NX1013 (without sleeve), 3NX1014 (with sleeve)

Isolating blades with insulated grip lugs

Sizes 000/00 to 3

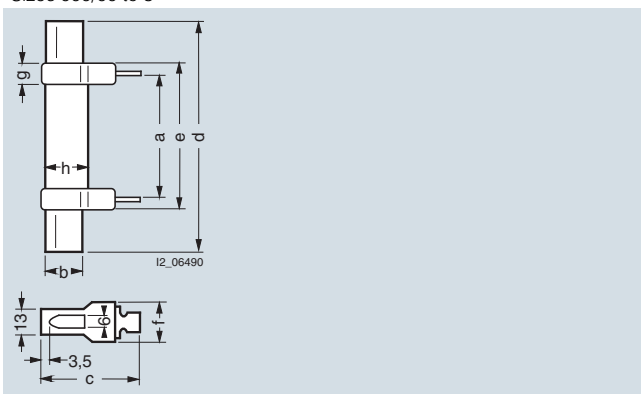

3NG1.02

Size	Type	a	b	c	d	e	f	g	h
000/00	3NG1002	44	15	48	78	54	20.5	8	19
0	3NG1102	60.5	15	48	125	68	20.5	8	19
1	3NG1202	61	20	53	135	72	23	9	24
2	3NG1302	61	26	61	150	72	23	9	29
3	3NG1402	61	32	73	150	72	23	9	36

Isolating blades with non-insulated grip lugs

Size 4

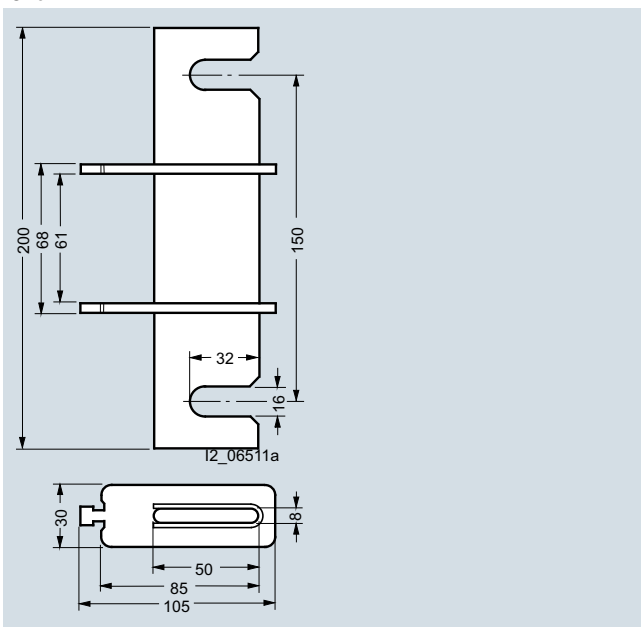

3NG1503

Size 4a

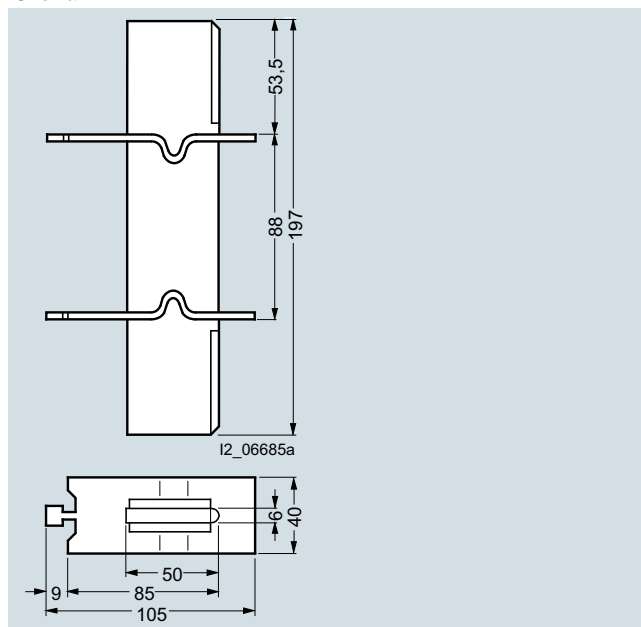

3NG1505

More information

Space requirements when installing LV HRC fuse bases

1 LV HRC fuse base, 3P

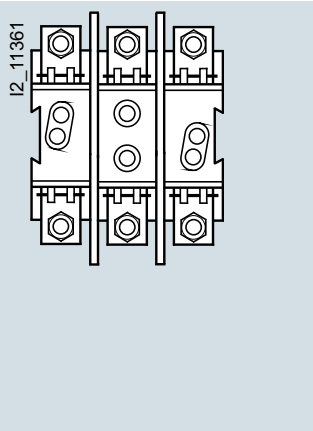

3 LV HRC fuse base, 1P

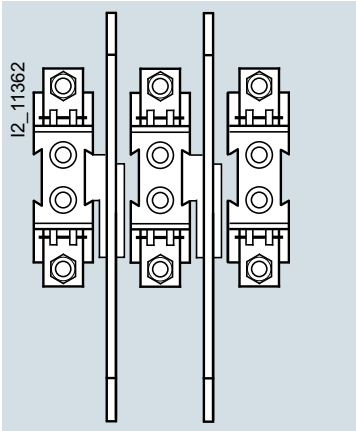

LV HRC partition

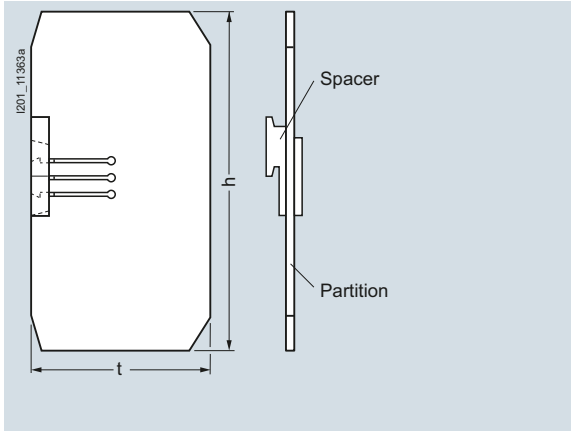

Size	Mounting width (mm) of LV HRC fuse bases				Distance through spacer	Mounting height (mm)		Mounting depth (mm)	
	1 unit, 3P		3 units, 1P			h	3NX20.. partitions with matching bases ¹⁾		
	Bases with phase barrier, without end barrier	Bases with phase barrier and 2 end barriers	Bases with phase barrier, without end barrier	Bases with phase barrier and 2 end barriers			t	t	
000/00	102	106	100	104 ²⁾	2	138	86		
0	--	--	128	142	7	178	90		
1	163	177	158	172	7	202	110		
2	--	--	184	224	20 ³⁾	227	118		
3	--	--	208	272	32 ³⁾	242	132		
4	Installation without barriers; for mounting, see page 75						Not available		
4a	Can only be used in bases with swivel mechanism						Not available		

¹⁾ This measurement specifies the required overall mounting depth with base d and the overall mounting height h.

²⁾ Placing an additional base on the barrier and plug-on part does not increase the distance, rather the bases lie flat directly on top of one another.

³⁾ If the bases are installed directly on a side wall in the distribution board, one spacer part can be broken off. This would reduce the distance measurement.

SITOR semiconductor fuses for 3NH bases:

3NH bases are generally suitable for all LV HRC type fuses. SITOR semiconductor fuses in LV HRC design can also be used, although it must be noted that, compared to cable and line protection fuses, these get much hotter during operation. The following table shows the permissible load currents of the SITOR semiconductor fuses for installation in 3NH. For this reason, the fuse must be operated below I_n when installed in a base (derating).

The values were determined using the conductor cross-sections specified in the table. If using smaller cross-sections, a considerably higher derating is required due to the lower heat dissipation.

For further information on the assignment of SITOR semiconductor fuses to the fuse bases and safety switching devices, please refer to the tables on page 85 ff.

Fuse Systems

SITOR Semiconductor Fuses

LV HRC design

Overview

SITOR semiconductor fuses protect power semiconductors from the effects of short circuits because the super quick-response disconnect characteristic is far quicker than with conventional LV HRC fuses. They protect high-quality devices and system components, such as converters with fuses in the input and the DC link, UPS systems and soft starters for motors.

Panel mounting requirements have given rise to various connection versions and designs.

The fuses with blade contacts comply with IEC 60269-2 and are suitable for installation in LV HRC fuse bases, in LV HRC fuse switch disconnectors and switch disconnectors with fuses. They also include fuses with slotted blade contacts for screw fixing with 110 mm mounting dimension, whose sizes are according to IEC 60269-4.

Fuses with slotted blade contacts for screw fixing with 80 mm or 110 mm mounting dimension are often screwed directly onto busbars for optimum heat dissipation. Even better heat transmission is provided by the compact fuses with M10 or M12 female thread, which are also mounted directly onto busbars.

Bolt-on links with 80 mm mounting dimension are another panel-mounting version for direct busbar mounting.

The fuses for SITOR thyristor sets, railway rectifiers or electrolysis systems were developed specially for these applications.

LV HRC bases suitable for use with SITOR semiconductor fuses and safety switching devices [can be found on page 69 ff.](#)

Fuse characteristics, configuration notes and the assignments of SITOR semiconductor fuses to the fuse bases and 3NP and 3KL safety switching devices can be found in the Configuration Manual, "Fuse Systems" at: www.siemens.com/lowvoltage/manuals

The new size 3 type ranges have a round ceramic body instead of a square one. These series are characterized by small I^2t values with low power dissipation and high capability under alternating load. The dimensions and functional values correspond to the current standards IEC 60269-4/EN 60269-4 (VDE 0636-4).

Note:

The ordering data of the fuses are listed in ascending order of the rated voltage in the selection tables.

Benefits

- SITOR semiconductor fuses have a high varying load factor, which ensures a high level of operational safety and plant availability – even when subject to constant load change
- The use of SITOR semiconductor fuses in LV HRC bases or Siemens switch disconnectors has been tested with regard to heat dissipation and maximum current loading. This makes planning and dimensioning easier and prevents consequential damage
- Our high standard of quality ensures good compliance with the characteristic curve and accuracy. This ensures long-term protection of devices

Operational classes

Fuses are categorized according to function and operational classes. SITOR semiconductor fuses, in LV HRC design, are available in the following operational classes:

- aR: for the short-circuit protection of power semiconductors (partial range protection)
- gR: for the protection of power semiconductors (full range protection)
- gS: The operational class gS combines cable and line protection with semiconductor protection (full range protection)

Parallel-connected fuses

Parallel-connected fuses offer maximum current and energy limiting that is clearly better than in the case of comparable single fuses. They also fulfill the special requirements for UL-certified fuses according to which fuses must be connected in parallel at the factory. *Here is the original wording of the NEC document: 240.8 Fuses and circuit breakers shall be permitted to be connected in parallel where they are factory assembled in parallel and listed as a unit. Individual fuses, circuit breakers, or combinations thereof shall not otherwise be connected in parallel.*

Application

Features

SITOR fuse links protect converter equipment against short circuits.

The power semiconductors used in these devices (diodes, thyristors, GTOs and others) require fast-switching elements for protection due to their low thermal capacity. SITOR fuse links (super quick-response fuse links for semiconductor protection) are ideal for this type of application.

The following types of short-circuit faults can occur:

- **Internal short circuit:**
A faulty semiconductor device causes a short circuit within the power converter
- **External short circuit:**
A fault in the load causes a short circuit on the output side of the power converter
- **Inverter shoot-through:**
In the event of a failure of the chassis converter control system during inverter operation (commutation failure), the converter connection forms a short-circuit type connection between the DC and AC power supply system.

Fuse links can be arranged in a number of ways within the converter connection. A distinction is made between phase fuses in three-phase incoming feeders and, if applicable, DC fuses and branch fuses in the branches of the converter circuit (see adjacent diagrams). In the case of center tap connections, fuse links can only be arranged as phase fuses in three-phase incoming feeders.

When using SITOR fuse links of operational class aR, the overload protection of converter equipment, up to approx. 3.5 times the rated current of the fuse link, is taken from conventional protective devices (for example, thermally-delayed overload relays) or, in the case of controlled power converters, from the current limiter (exception: full range fuses).

SITOR fuse links of the 3NE1...-0 series with operational class gS are also suitable for overload and short-circuit protection of cables, lines and busbars. All other dual-function fuses of the SITOR series have a gR characteristic. Overload protection is ensured as long as the rated current of the SITOR fuse links of the series 3NE1...-0 is selected as $I_n \leq I_z$ (DIN VDE 0100 Part 430).

The rules of DIN VDE 0100 Part 430 must be applied when rating short-circuit protection for cables, lines and busbars.

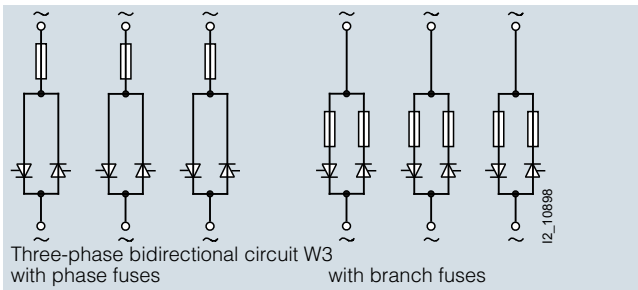

Configuration options

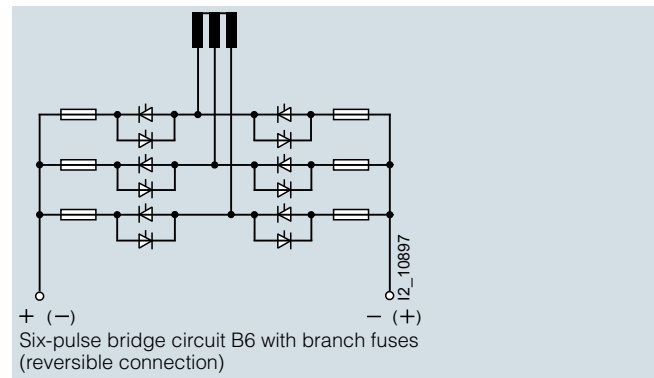
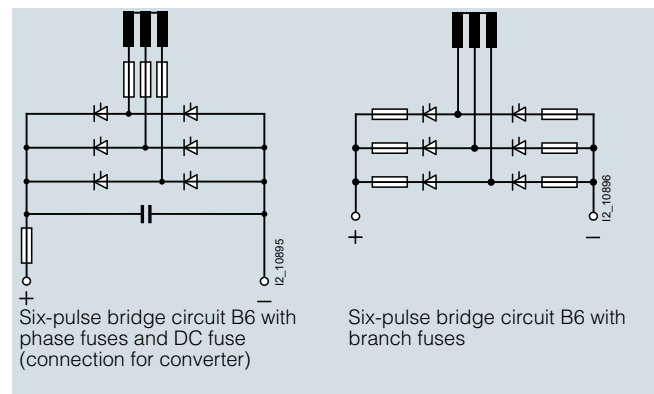
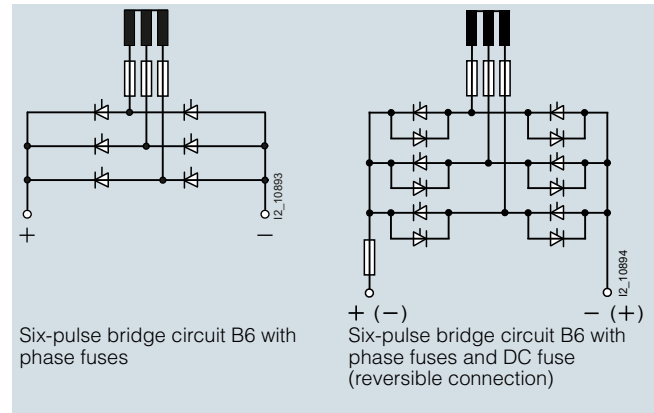

Fuse Systems

SITOR Semiconductor Fuses

LV HRC design

Technical specifications

MLFB	Operational class (IEC 60269)	Rated voltage U_n	Rated breaking capacity I_{1n}	Rated current I_n	Melting I^2t value I^2t_s ($t_{vs} = 1$ ms)	Breaking I^2t value I^2t_a at U_n	Temperature rise at I_n body center ²⁾	Power dissipation at I_n ²⁾	Varying load factor VL
		V AC / V DC	kA	A	A ² s	A ² s	K	W	
3NB1234-3KK20	gR	--/900 ¹⁵⁾	100	400	96000	240000 ¹⁵⁾	56	75	--
3NB1126-4KK11	aR	--/1250 ¹⁵⁾	100	200	10700	39000 ¹⁵⁾	53	50	--
3NB1128-4KK11	aR	--/1250 ¹⁵⁾	100	250	24500	80500 ¹⁵⁾	53	51	--
3NB1231-4KK11	aR	--/1250 ¹⁵⁾	100	315	41000	129000 ¹⁵⁾	55	63	--
3NB1234-4KK11	aR	--/1250 ¹⁵⁾	100	400	96000	290000 ¹⁵⁾	56	68	--
3NB1337-4KK11	aR	--/1250 ¹⁵⁾	100	500	195000	600000 ¹⁵⁾	55	89	--
3NB1345-4KK11	aR	--/1250 ¹⁵⁾	100	800	770000	1910000 ¹⁵⁾	76	135	--
3NB2345-4KK16	aR	--/1250 ¹⁵⁾	150	800	375000	1150000 ¹⁵⁾	74	160	--
3NB2350-4KK16	aR	--/1250 ¹⁵⁾	150	1000	7870000	2250000 ¹⁵⁾	87	195	--
3NB2355-4KK16	aR	--/1250 ¹⁵⁾	150	1400	2150000	5100000 ¹⁵⁾	89	250	--
3NB2357-4KK16	aR	--/1250 ¹⁵⁾	150	1600	3500000	7450000 ¹⁵⁾	76	275	--
3NB2364-4KK17	aR	--/1250 ¹⁵⁾	150	2100	5750000	1950000 ¹⁵⁾	77	365	--
3NB2366-4KK17	aR	--/1250 ¹⁵⁾	150	2400	9050000	18100000 ¹⁵⁾	89	445	--
3NB3350-1KK26	gR	690/ ¹³⁾	100	1000	298000	1400000	101	138	1
3NB3351-1KK26	gR	690/ ¹³⁾	100	1100	680000	3000000	96	110	1
3NB3352-1KK26	gR	690/ ¹³⁾	100	1250	897000	4100000	38	104	1
3NB3354-1KK26	gR	690/ ¹³⁾	100	1350	1100000	4800000	44	126	1
3NB3355-1KK26	gR	690/ ¹³⁾	100	1400	1150000	5200000	48	127	1
3NB3357-1KK26	gR	690/ ¹³⁾	100	1600	1550000	6900000	57	152	1
3NB3358-1KK26	gR	690/ ¹³⁾	100	1700	2370000	10000000	57	143	1
3NB3358-1KK27	gR	690/ ¹³⁾	100	1700	1550000	6400000	64	179	1
3NB3362-1KK27	gR	690/ ¹³⁾	100	1900	1850000	8200000	70	196	1
3NC2423-0C	gR	500/ ¹³⁾	50 ¹⁴⁾	150 ³⁾	7000	33000	26	35	0.85
3NC2423-3C	gR	500/ ¹³⁾	50 ¹⁴⁾	150 ³⁾	7000	33000	26	35	0.85
3NC2425-0C	gR	500/ ¹³⁾	50 ¹⁴⁾	200 ³⁾	13600	64000	25	40	0.85
3NC2425-3C	gR	500/ ¹³⁾	50 ¹⁴⁾	200 ³⁾	13600	64000	25	40	0.85
3NC2427-0C	gR	500/ ¹³⁾	50 ¹⁴⁾	250 ³⁾	21000	99000	30	50	0.85
3NC2427-3C	gR	500/ ¹³⁾	50 ¹⁴⁾	250 ³⁾	21000	99000	30	50	0.85
3NC2428-0C	gR	500/ ¹³⁾	50 ¹⁴⁾	300 ³⁾	28000	132000	40	65	0.85
3NC2428-3C	gR	500/ ¹³⁾	50 ¹⁴⁾	300 ³⁾	28000	132000	40	65	0.85
3NC2431-0C	gR	500/ ¹³⁾	50 ¹⁴⁾	350 ³⁾	53000	249000	35	60	0.85
3NC2431-3C	gR	500/ ¹³⁾	50 ¹⁴⁾	350 ³⁾	53000	249000	35	60	0.85
3NC2432-0C	aR	500/ ¹³⁾	50 ¹⁴⁾	400 ³⁾	83000	390000	30	50	0.85
3NC2432-3C	aR	500/ ¹³⁾	50 ¹⁴⁾	400 ³⁾	83000	390000	30	50	0.85
3NC3236-1U	aR	690/ ¹³⁾	100	630	32500	244000	120	120	0.85
3NC3236-6U	aR	690/ ¹³⁾	100	630	32500	244000	125	125	0.9
3NC3237-1U	aR	690/ ¹³⁾	100	710	46100	346000	125	130	0.85
3NC3237-6U	aR	690/ ¹³⁾	100	710	46100	346000	125	130	0.9
3NC3238-1U	aR	690/ ¹³⁾	100	800	66400	498000	125	135	0.9
3NC3238-6U	aR	690/ ¹³⁾	100	800	66400	498000	120	135	0.95
3NC3240-1U	aR	690/ ¹³⁾	100	900	90300	677000	130	145	0.9
3NC3240-6U	aR	690/ ¹³⁾	100	900	90300	677000	125	140	0.95
3NC3241-1U	aR	690/ ¹³⁾	100	1000	130000	975000	125	155	0.95
3NC3241-6U	aR	690/ ¹³⁾	100	1000	130000	975000	120	145	1
3NC3242-1U	aR	690/ ¹³⁾	100	1100	184000	1382000	125	165	0.95
3NC3242-6U	aR	690/ ¹³⁾	100	1100	184000	1382000	115	150	1
3NC3243-1U	aR	690/ ¹³⁾	100	1250	265000	1990000	130	175	0.95
3NC3243-6U	aR	690/ ¹³⁾	100	1250	265000	1990000	110	155	1
3NC3244-1U	aR	500/ ¹³⁾	100	1400	382000	2100000	140	200	0.95
3NC3244-6U	aR	500/ ¹³⁾	100	1400	382000	2100000	115	175	1
3NC3245-1U	aR	500/ ¹³⁾	100	1600	520000	2860000	160	240	0.9
3NC3245-6U	aR	500/ ¹³⁾	100	1600	520000	2860000	120	195	0.95
3NC3336-1U	aR	1000/ ¹³⁾	100	630	66400	418000	160	145	0.85
3NC3336-6U	aR	1000/ ¹³⁾	100	630	66400	418000	140	130	0.9
3NC3337-1U	aR	1000/ ¹³⁾	100	710	90300	569000	160	150	0.85
3NC3337-6U	aR	1000/ ¹³⁾	100	710	90300	569000	140	140	0.9
3NC3338-1U	aR	1000/ ¹³⁾	100	800	130000	819000	150	155	0.85
3NC3338-6U	aR	1000/ ¹³⁾	100	800	130000	819000	130	150	0.9
3NC3340-1U	aR	1000/ ¹³⁾	100	900	184000	1160000	145	165	0.9
3NC3340-6U	aR	1000/ ¹³⁾	100	900	184000	1160000	130	160	0.95
3NC3341-1U	aR	1000/ ¹³⁾	100	1000	265000	1670000	140	170	0.9
3NC3341-6U	aR	1000/ ¹³⁾	100	1000	265000	1670000	125	165	0.95
3NC3342-1U	aR	800/ ¹³⁾	100	1100	382000	1910000	150	185	0.9
3NC3342-6U	aR	800/ ¹³⁾	100	1100	382000	1910000	130	175	0.95
3NC3343-1U	aR	800/ ¹³⁾	100	1250	520000	2600000	165	210	0.9
3NC3343-6U	aR	800/ ¹³⁾	100	1250	520000	2600000	135	185	0.95
3NC3430-1U	aR	1250/ ¹³⁾	100	315	10600	72500	60	80	0.95
3NC3430-6U	aR	1250/ ¹³⁾	100	315	10600	72500	60	80	0.95

For footnotes, see page 84.

MLFB	Operational class (IEC 60269)	Rated voltage U_n	Rated breaking capacity I_{1n}	Rated current I_n	Melting I^2t value I^2t_s ($t_{vs} = 1$ ms)	Breaking I^2t value I^2t_a at U_n	Temperature rise at I_n body center	Power dissipation at I_n	Varying load factor VL
		V AC / V DC	kA	A	A ² s	A ² s	K	W	
3NC3432-1U	aR	1250 ⁽¹³⁾	100	400	23900	163000	95	95	0.95
3NC3432-6U	aR	1250 ⁽¹³⁾	100	400	23900	163000	95	95	0.95
3NC3434-1U	aR	1250 ⁽¹³⁾	100	500	42500	290000	115	115	0.9
3NC3434-6U	aR	1250 ⁽¹³⁾	100	500	42500	290000	115	115	0.9
3NC3436-1U	aR	1250 ⁽¹³⁾	100	630	96600	650000	120	120	0.95
3NC3436-6U	aR	1250 ⁽¹³⁾	100	630	96600	650000	120	120	0.95
3NC3438-1U	aR	1100 ⁽¹³⁾	100	800	184000	985000	115	145	0.90
3NC3438-6U	aR	1100 ⁽¹³⁾	100	800	184000	985000	109	145	0.95
3NC5531 ⁽⁴⁾	aR	800 ⁽¹³⁾	50 ⁽¹⁴⁾	350 ⁽⁵⁾	66000	260000	200	80	0.9
3NC5838 ⁽⁴⁾	aR	1000 ⁽¹³⁾	50 ⁽¹⁴⁾	800 ⁽⁵⁾	360000	1728000	130	170	0.9
3NC5840 ⁽⁴⁾	aR	1000 ⁽¹³⁾	50 ⁽¹⁴⁾	600 ⁽⁵⁾	185000	888000	110	150	0.9
3NC5841 ⁽⁴⁾	aR	800 ⁽¹³⁾	50 ⁽¹⁴⁾	630 ⁽⁵⁾	185000	888000	110	145	0.9
3NC7327-2	aR	680 ⁽¹³⁾	50 ⁽¹⁴⁾	250	244000	635000	45	25	0.9
3NC7331-2	aR	680 ⁽¹³⁾	50 ⁽¹⁴⁾	350	550000	1430000	66	32	0.9
3NC8423-0C	gR	690 ⁽¹³⁾	50 ⁽¹⁴⁾	150 ⁽³⁾	1100	17600	33	40	0.85
3NC8423-3C	gR	690 ⁽¹³⁾	50 ⁽¹⁴⁾	150 ⁽³⁾	1100	17600	33	40	0.85
3NC8425-0C	gR	690 ⁽¹³⁾	50 ⁽¹⁴⁾	200 ⁽³⁾	2400	38400	46	55	0.85
3NC8425-3C	gR	690 ⁽¹³⁾	50 ⁽¹⁴⁾	200 ⁽³⁾	2400	38400	46	55	0.85
3NC8427-0C	gR	690 ⁽¹³⁾	50 ⁽¹⁴⁾	250 ⁽³⁾	4400	70400	95	72	0.85
3NC8427-3C	gR	690 ⁽¹³⁾	50 ⁽¹⁴⁾	250 ⁽³⁾	4400	70400	95	72	0.85
3NC8431-0C	gR	690 ⁽¹³⁾	50 ⁽¹⁴⁾	350 ⁽³⁾	11000	176000	65	95	0.85
3NC8431-3C	gR	690 ⁽¹³⁾	50 ⁽¹⁴⁾	350 ⁽³⁾	1000	176000	65	95	0.85
3NC8434-0C	gR	690 ⁽¹³⁾	50 ⁽¹⁴⁾	500 ⁽³⁾	28000	448000	75	130	0.85
3NC8434-3C	gR	690 ⁽¹³⁾	50 ⁽¹⁴⁾	500 ⁽³⁾	28000	448000	75	130	0.85
3NC8444-3C	aR	600 ⁽¹³⁾	50 ⁽¹⁴⁾	1000	400000	2480000	110	140	0.9
3NE1020-2	gR	690 ⁽¹³⁾	100	80	780	5800	45	10	1
3NE1021-0	gS	690 ⁽¹³⁾	100	100	3100	33000	36	10	1
3NE1021-2	gR	690 ⁽¹³⁾	100	100	1490	11000	49	12	1
3NE1022-0	gS	690 ⁽¹³⁾	100	125	6000	63000	40	11	1
3NE1022-2	gR	690 ⁽¹³⁾	100	125	3115	23000	55	13	1
3NE1224-0	gS	690 ⁽¹³⁾	100	160	7400	60000	60	24	1
3NE1224-2	gR	690 ⁽¹³⁾	100	160	2650	18600	70	32	1
3NE1224-3	gR	690 ⁽¹³⁾	100	160	2650	18600	70	32	1
3NE1225-0	gS	690 ⁽¹³⁾	100	200	14500	100000	65	27	1
3NE1225-2	gR	690 ⁽¹³⁾	100	200	5645	51800	62	35	1
3NE1225-3	gR	690 ⁽¹³⁾	100	200	5645	51800	62	35	1
3NE1227-0	gS	690 ⁽¹³⁾	100	250	29500	200000	75	30	1
3NE1227-2	gR	690 ⁽¹³⁾	100	250	11520	80900	70	37	1
3NE1227-3	gR	690 ⁽¹³⁾	100	250	11520	80900	70	37	1
3NE1230-0	gS	690 ⁽¹³⁾	100	315	46100	310000	80	38	1
3NE1230-2	gR	690 ⁽¹³⁾	100	315	22580	168000	75	40	1
3NE1230-3	gR	690 ⁽¹³⁾	100	315	22580	168000	75	40	1
3NE1331-0	gS	690 ⁽¹³⁾	100	350	58000	430000	75	42	1
3NE1331-2	gR	690 ⁽¹³⁾	100	350	29500	177000	82	43	1
3NE1331-3	gR	690 ⁽¹³⁾	100	350	29500	177000	82	43	1
3NE1332-0	gS	690 ⁽¹³⁾	100	400	84000	590000	85	45	1
3NE1332-2	gR	690 ⁽¹³⁾	100	400	37300	177000	100	50	1
3NE1332-3	gR	690 ⁽¹³⁾	100	400	37300	177000	100	50	1
3NE1333-0	gS	690 ⁽¹³⁾	100	450	104000	750000	85	53	1
3NE1333-2	gR	690 ⁽¹³⁾	100	450	46100	276500	100	58	1
3NE1333-3	gR	690 ⁽¹³⁾	100	450	46100	276500	100	58	1
3NE1334-0	gS	690 ⁽¹³⁾	100	500	149000	950000	90	56	1
3NE1334-2	gR	690 ⁽¹³⁾	100	500	66400	398000	100	64	1
3NE1334-3	gR	690 ⁽¹³⁾	100	500	66400	398000	100	64	1
3NE1435-0	gS	690 ⁽¹³⁾	100	560	215000	1700000	65	50	1
3NE1435-2	gR	690 ⁽¹³⁾	100	560	130000	890000	80	60	1
3NE1435-3	gR	690 ⁽¹³⁾	100	560	130000	890000	80	60	1
3NE1436-0	gS	690 ⁽¹³⁾	100	630	293000	2350000	70	55	1
3NE1436-2	gR	690 ⁽¹³⁾	100	630	203000	1390000	82	60	1
3NE1436-3	gR	690 ⁽¹³⁾	100	630	203000	1390000	82	60	1
3NE1437-0	gS	690 ⁽¹³⁾	100	710	437000	3400000	68	58	1
3NE1437-1	gR	600 ⁽¹³⁾	100	710	321000	2460000	85	65	1
3NE1437-2	gR	690 ⁽¹³⁾	100	710	265000	1818000	90	72	1
3NE1437-3	gR	690 ⁽¹³⁾	100	710	265000	1818000	90	72	1

For footnotes, see page 84.

Fuse Systems

SITOR Semiconductor Fuses

LV HRC design

MLFB	Operational class (IEC 60269)	Rated voltage U_n	Rated breaking capacity I_{1n}	Rated current I_n	Melting I^2t value I^2t_s ($t_{vs} = 1$ ms)	Breaking I^2t value I^2t_a at U_n	Temperature rise at I_n body center	Power dissipation at I_n	Varying load factor VL
		V AC / V DC	kA	A	A ² s	A ² s	K	W	
3NE3201-OMK	gR	1000/600	50/50	32	45	4500	32	9	On request
3NE3202-OMK	gR	1000/600	50/50	40	75	6000	35	13	On request
3NE3217-OMK	gR	1000/600	50/50	50	110	8000	45	18	On request
3NE3218-OMK	gR	1000/600	50/50	63	170	9000	62	25	On request
3NE3234-OMK08	aR	1000/600	50/50	500	46000	500000	100	105	On request
3NE3235-OMK08	aR	1000/600	50/50	550	68000	700000	107	110	On request
3NE3236-OMK08	aR	1000/600	50/50	630	90000	850.000	110	127	On request
3NE5302-OMK06	gR	1800/1100	30/45	40	45	900	45	26	On request
3NE5317-OMK06	gR	1800/1100	30/45	50	100	1800	45	27	On request
3NE5318-OMK06	gR	1800/1100	30/45	63	200	3100	55	34	On request
3NE5320-OMK06	aR	1800/1100	30/45	80	300	3900	58	42	On request
3NE5321-OMK06	aR	1800/1100	30/45	100	550	8700	58	45	On request
3NE5322-OMK06	aR	1800/1100	30/45	125	900	11800	68	59	On request
3NE5324-OMK06	aR	1800/1100	30/45	160	2500	37000	62	54	On request
3NE5325-OMK06	aR	1800/1100	30/45	200	6000	70000	62	56	On request
3NE5327-OMK06	aR	1800/1100	30/45	250	15000	165000	62	59	On request
3NE5330-OMK06	aR	1800/1100	30/45	315	28000	250000	66	76	On request
3NE5332-OMK06	aR	1500/1000	30/45	400	58000	470000	72	89	On request
3NE5334-OMK06	aR	1500/1000	30/45	500	110000	800000	81	109	On request
3NE5336-OMK06	aR	1500/1000	30/45	630	170000	1100000	88	163	On request
3NE5336-OMK66	aR	1500/1000	30/45	630	170000	1100000	85	163	On request
3NE8221-OMK	aR	690/440	100/50	100	540	3200	55	25	On request
3NE8222-OMK	aR	690/440	100/50	125	1000	6000	57	28.0	On request
3NE8224-OMK	aR	690/440	100/50	160	1800	10500	68	35.0	On request
3NE8225-OMK	aR	690/440	100/50	200	3000	17500	69	42	On request
3NE8227-OMK	aR	690/440	100/50	250	5000	28.500	77	53.5	On request
3NE8230-OMK	aR	690/440	100/50	315	19200	120000	65	68	On request
3NE8331-OMK	aR	690/440	100/50	350	17500	83500	55	68.6	On request
3NE8332-OMK	aR	690/440	100/50	400	27200	136000	60	72.8	On request
3NE8333-OMK	aR	690/440	100/50	450	38000	207000	58	80.1	On request
3NE8334-OMK	aR	690/440	100/50	500	59000	318000	58	77.5	On request
3NE8335-OMK	aR	690/440	100/50	550	76000	399000	65	86.4	On request
3NE8336-OMK	aR	690/440	100/50	630	122000	740000	67	90.7	On request
3NE8801-OMK	gR	690/440	100/50	32	40	350	53	10.5	On request
3NE8802-OMK	gR	690/440	100/50	40	50	480	53	12	On request
3NE8810-OMK	gR	690/440	100/50	6	1.5	37	17	2.7	On request
3NE8812-OMK	gR	690/440	100/50	10	4	50	30	4.5	On request
3NE8813-OMK	gR	690/440	100/50	16	8.5	73	38	6.7	On request
3NE8814-OMK	gR	690/440	100/50	20	15	90	45	8	On request
3NE8815-OMK	gR	690/440	100/50	25	25	150	40	8.1	On request
3NE8817-OMK	gR	690/440	100/50	50	65	1050	65	14.5	On request
3NE8818-OMK	gR	690/440	100/50	63	90	1960	74	23.0	On request
3NE8820-OMK	aR	690/440	100/50	80	450	2,200	70	23.3	On request
3NE8821-OMK	aR	690/440	100/50	100	820	3,650	73	27	On request
3NE8822-OMK	aR	690/440	100/50	125	1700	7,800	60	30	On request
3NE8824-OMK	aR	500/440	100/50	160	3300	14000	70	34	On request
3NE9330-OMK07	aR	-/3000	-/45	315	65000	300000	95	245	On request
3NE1438-0	gS	690/ ¹³	100	800	723000	5000000	70	58	1
3NE1438-1	gR	600/ ¹³	100	800	437000	3350000	95	72	1
3NE1438-2	gR	690/ ¹³	100	800	361000	2475000	95	84	1
3NE1438-3	gR	690/ ¹³	100	800	361000	2475000	95	84	1
3NE1447-2	gR	690/ ¹³	100	670	240000	1640000	90	64	1
3NE1447-3	gR	690/ ¹³	100	670	240000	1640000	90	64	1
3NE1448-2	gR	690/ ¹³	100	850	520000	3640000	95	76	1
3NE1448-3	gR	690/ ¹³	100	850	520000	3640000	95	76	1
3NE1802-0	gS	690/ ¹³	100	40	295	3000	30	3	1
3NE1803-0	gS	690/ ¹³	100	35	166	1700	35	3.5	1
3NE1813-0	gS	690/ ¹³	100	16	18	200	25	4	1
3NE1814-0	gS	690/ ¹³	100	20	41	430	25	5	1
3NE1815-0	gS	690/ ¹³	100	25	74	780	30	5	1
3NE1817-0	gS	690/ ¹³	100	50	461	4400	35	6	1
3NE1818-0	gS	690/ ¹³	100	63	903	9000	40	7	1
3NE1820-0	gS	690/ ¹³	100	80	1843	18000	40	8	1
3NE3221	aR	1000/ ¹³	100	100	665	4800	65	28	0.95
3NE3222	aR	1000/ ¹³	100	125	1040	7200	70	36	0.95
3NE3224	aR	1000/ ¹³	100	160	1850	13000	90	42	1
3NE3225	aR	1000/ ¹³	100	200	4150	30000	80	42	1
3NE3227	aR	1000/ ¹³	100	250	6650	48000	90	50	1
3NE3230-0B	aR	1000/ ¹³	100	315	13400	80000	100	60	0.95
3NE3231	aR	1000/ ¹³	100	350	16600	100000	120	75	0.9
3NE3232-0B	aR	1000/ ¹³	100	400	22600	135000	140	85	0.9
3NE3233	aR	1000/ ¹³	100	450	29500	175000	130	95	0.9

For footnotes, see page 84.

MLFB	Operational class (IEC 60269)	Rated voltage U_n	Rated breaking capacity I_{1n}	Rated current I_n	Melting I^2t value I^2t_s ($t_{vs} = 1$ ms)	Breaking I^2t value I^2t_a at U_n	Temperature rise at I_n body center	Power dissipation at I_n	Varying load factor VL
		V AC / V DC	kA	A	A ² s	A ² s	K	W	
3NE3332-0B	aR	1000 ⁽¹³⁾	100	400	22600	135000	120	80	1
3NE3333	aR	1000 ⁽¹³⁾	100	450	29500	75000	125	90	1
3NE3334-0B	aR	1000 ⁽¹³⁾	100	500	46100	260000	115	90	1
3NE3335	aR	1000 ⁽¹³⁾	100	560	66500	60000	120	95	1
3NE3336	aR	1000 ⁽¹³⁾	100	630	104000	600000	110	100	1
3NE3337-8	aR	900 ⁽¹³⁾	100	710	149000	800000	125	105	1
3NE3338-8	aR	800 ⁽¹³⁾	100	800	184000	850000	140	130	0.95
3NE3340-8	aR	690 ⁽¹³⁾	100	900	223000	920000	160	165	0.95
3NE3421-0C	aR	1000 ⁽¹³⁾	50 ⁽¹⁴⁾	100	1800	13500	45	25	1
3NE3430-0C	aR	1000 ⁽¹³⁾	50 ⁽¹⁴⁾	315	29000	218000	120	80	1
3NE3432-0C	aR	1000 ⁽¹³⁾	50 ⁽¹⁴⁾	400	48500	364000	130	110	1
3NE3434-0C	aR	1000 ⁽¹³⁾	50 ⁽¹⁴⁾	500	116000	870000	120	95	1
3NE3525-5 ⁶⁾	aR	1000 ⁽¹³⁾	50 ⁽¹⁴⁾	200 ⁽⁷⁾	7150	44000	75	50	0.85
3NE3535-5 ⁶⁾	aR	1000 ⁽¹³⁾	50 ⁽¹⁴⁾	450 ⁽⁷⁾	64500	395000	130	90	0.85
3NE3626-0C	aR	1000 ⁽¹³⁾	50 ⁽¹⁴⁾	224	7200	54000	140	85	1
3NE3635-0C	aR	1000 ⁽¹³⁾	50 ⁽¹⁴⁾	450	65000	488000	150	110	1
3NE3635-6	aR	1000 ⁽¹³⁾	50 ⁽¹⁴⁾	450	65000	488000	150	110	1
3NE3636-0C	aR	1000 ⁽¹³⁾	50 ⁽¹⁴⁾	630	170000	1280000	136	132	1
3NE3637-0C	aR	1000 ⁽¹³⁾	50 ⁽¹⁴⁾	710	260000	1950000	170	145	1
3NE3637-1C ⁸⁾	aR	1000 ⁽¹³⁾	50 ⁽¹⁴⁾	710	260000	1950000	170	145	1
3NE4101	gR	1000 ⁽¹³⁾	100	32	40	280	45	12	0.9
3NE4102	gR	1000 ⁽¹³⁾	100	40	75	500	50	13	0.9
3NE4117	gR	1000 ⁽¹³⁾	100	50	120	800	65	16	0.9
3NE4117-5	gR	1000 ⁽¹³⁾	50 ⁽¹⁴⁾	50	135	1100	95	20	0.85
3NE4118	aR	1000 ⁽¹³⁾	100	63	230	1500	78	20	0.9
3NE4120	aR	1000 ⁽¹³⁾	100	80	450	3000	82	22	0.9
3NE4121	aR	1000 ⁽¹³⁾	100	100	900	6000	85	24	0.9
3NE4121-5	aR	1000 ⁽¹³⁾	50 ⁽¹⁴⁾	100	900	7400	135	35	0.85
3NE4122	aR	1000 ⁽¹³⁾	100	125	1800	14000	100	30	0.9
3NE4124	aR	1000 ⁽¹³⁾	100	160	3600	29000	120	35	0.9
3NE4146-5	aR	800 ⁽¹³⁾	50 ⁽¹⁴⁾	170	7370	60500	142	43	0.85
3NE4327-0B	aR	800 ⁽¹³⁾	50 ⁽¹⁴⁾	250	3600	29700	175	105	0.85
3NE4327-6B ⁶⁾	aR	800 ⁽¹³⁾	50 ⁽¹⁴⁾	250	3600	29700	175	105	0.85
3NE4330-0B	aR	800 ⁽¹³⁾	50 ⁽¹⁴⁾	315	7400	60700	170	120	0.85
3NE4330-6B ⁶⁾	aR	800 ⁽¹³⁾	50 ⁽¹⁴⁾	315	7400	60700	170	120	0.85
3NE4333-0B	aR	800 ⁽¹³⁾	50 ⁽¹⁴⁾	450	29400	191000	190	140	0.85
3NE4333-6B ⁶⁾	aR	800 ⁽¹³⁾	50 ⁽¹⁴⁾	450	29400	191000	190	140	0.85
3NE4334-0B	aR	800 ⁽¹³⁾	50 ⁽¹⁴⁾	500	42500	276000	195	155	0.85
3NE4334-6B ⁶⁾	aR	800 ⁽¹³⁾	50 ⁽¹⁴⁾	500	42500	276000	195	155	0.85
3NE4337	aR	800 ⁽¹³⁾	50 ⁽¹⁴⁾	710	142000	923000	170	155	0.95
3NE4337-6 ⁶⁾	aR	800 ⁽¹³⁾	50 ⁽¹⁴⁾	710	142000	923000	170	155	0.95
3NE5424-0C	aR	1500 ⁽¹³⁾	50 ⁽¹⁴⁾	160	7200	54000	75	56	1
3NE5426-0C	aR	1500 ⁽¹³⁾	50 ⁽¹⁴⁾	224	18400	138000	100	80	1
3NE5430-0C	aR	1500 ⁽¹³⁾	50 ⁽¹⁴⁾	315	41500	11000	125	115	1
3NE5431-0C	aR	1500 ⁽¹³⁾	50 ⁽¹⁴⁾	350	57000	428000	150	135	1
3NE5433-0C	aR	1500 ⁽¹³⁾	50 ⁽¹⁴⁾	450	116000	870000	150	145	0.95
3NE5433-1C ¹¹⁾	aR	1500 ⁽¹³⁾	50 ⁽¹⁴⁾	450	116000	870000	150	145	0.95
3NE5627-0C	aR	1500 ⁽¹³⁾	50 ⁽¹⁴⁾	250	11200	84000	170	130	1
3NE5633-0C	aR	1500 ⁽¹³⁾	50 ⁽¹⁴⁾	450	78500	590000	170	160	1
3NE5643-0C	aR	1500 ⁽¹³⁾	50 ⁽¹⁴⁾	600	260000	1950000	160	145	1
3NE6437	aR	900 ⁽¹³⁾	50 ⁽¹⁴⁾	710 ⁹⁾	100000	620000	80	150	0.9
3NE6437-7	aR	900 ⁽¹³⁾	50 ⁽¹⁴⁾	710 ¹⁰⁾	100000	620000	110	150	0.9
3NE6444	aR	900 ⁽¹³⁾	50 ⁽¹⁴⁾	900 ⁹⁾	400000	1920000	80	170	0.9
3NE7425-0U	aR	2000 ⁽¹³⁾	100	200	18400	138000	85	75	1
3NE7427-0U	aR	2000 ⁽¹³⁾	100	250	29000	218000	110	110	1
3NE7431-0U	aR	2000 ⁽¹³⁾	100	350	74000	555000	105	120	1
3NE7432-0U	aR	2000 ⁽¹³⁾	100	400	116000	870000	130	150	1
3NE7633-0U	aR	2000 ⁽¹³⁾	100	450	128000	960000	165	160	1
3NE7633-1U ¹¹⁾	aR	2000 ⁽¹³⁾	100	450	128000	960000	165	160	1
3NE7636-0U	aR	2000 ⁽¹³⁾	100	630	260000	1950000	200	220	1
3NE7636-1U ¹¹⁾	aR	2000 ⁽¹³⁾	100	630	260000	1950000	200	220	1
3NE7637-1U ¹¹⁾	aR	2000 ⁽¹³⁾	100	710	415000	3110000	230	275	1
3NE7648-1U ¹¹⁾	aR	2000 ⁽¹³⁾	100	525	149000	1120000	210	210	1
3NE8003-1	gR	690 ⁽¹³⁾	100	35	70	400	45	9	0.95
3NE8015-1	gR	690 ⁽¹³⁾	100	25	30	180	35	7	0.95
3NE8017-1	gR	690 ⁽¹³⁾	100	50	120	700	65	14	0.9
3NE8018-1	gR	690 ⁽¹³⁾	100	63	260	1400	70	16	0.95
3NE8020-1	aR	690 ⁽¹³⁾	100	80	450	2400	80	19	0.95
3NE8021-1	aR	690 ⁽¹³⁾	100	100	850	4200	90	22	0.95
3NE8022-1	aR	690 ⁽¹³⁾	100	125	1400	6500	110	28	0.95
3NE8024-1	aR	690 ⁽¹³⁾	100	160	2800	13000	130	38	0.95

For footnotes, see page 84.

Fuse Systems

SITOR Semiconductor Fuses

LV HRC design

MLFB	Operational class (IEC 60269)	Rated voltage U_n	Rated breaking capacity I_{1n}	Rated current I_n	Melting I^2t value I^2t_s ($t_{vs} = 1$ ms)	Breaking I^2t value I^2t_a at U_n	Temperature rise at I_n body center ²⁾	Power dissipation at I_n ²⁾	Varying load factor VL
		V AC / V DC	kA	A	A ² s	A ² s	K	W	
3NE8701-1	gR	690/700 ¹²⁾	50 ¹⁴⁾	32	40	285	45	10	0.9
3NE8702-1	gR	690/700 ¹²⁾	50 ¹⁴⁾	40	69	490	55	12	0.9
3NE8714-1	gR	690/700 ¹²⁾	50 ¹⁴⁾	20	12	83	40	7	0.9
3NE8715-1	gR	690/700 ¹²⁾	50 ¹⁴⁾	25	19	140	40	9	0.9
3NE8717-1	gR	690/700 ¹²⁾	50 ¹⁴⁾	50	115	815	60	15	0.9
3NE8718-1	gR	690/700 ¹²⁾	50 ¹⁴⁾	63	215	1550	70	16	0.95
3NE8720-1	aR	690/700 ¹²⁾	50 ¹⁴⁾	80	380	2700	80	18	0.9
3NE8721-1	aR	690/700 ¹²⁾	50 ¹⁴⁾	100	695	4950	75	19	0.95
3NE8722-1	aR	690/700 ¹²⁾	50 ¹⁴⁾	125	1250	9100	80	23	0.95
3NE8724-1	aR	690/700 ¹²⁾	50 ¹⁴⁾	160	2350	17000	100	31	0.9
3NE8725-1	aR	690/700 ¹²⁾	50 ¹⁴⁾	200	4200	30000	120	36	0.9
3NE8727-1	aR	690/700 ¹²⁾	50 ¹⁴⁾	250	7750	55000	125	42	0.9
3NE8731-1	aR	690/700 ¹²⁾	50 ¹⁴⁾	315	12000	85500	150	54	0.85
3NE9440-6	gR	600 ¹³⁾	50 ¹⁴⁾	850	400000	2480000	74	85	1
3NE9450	aR	600 ¹³⁾	50 ¹⁴⁾	1250 ⁹⁾	400000	2480000	80	210	0.9
3NE9450-7	aR	600 ¹³⁾	50 ¹⁴⁾	1250 ¹⁰⁾	400000	2480000	105	210	0.9
3NE9632-1C¹¹⁾	aR	2500 ¹³⁾	50 ¹⁴⁾	00	81000	620000	160	205	1
3NE9634-1C¹¹⁾	aR	2500 ¹³⁾	50 ¹⁴⁾	500	170000	1270000	180	235	1
3NE9636-1C¹¹⁾	aR	2500 ¹³⁾	50 ¹⁴⁾	630	385000	2800000	198	275	1

- 1) Maximum tightening torque: M10 capped thread: 35 Nm, screw penetration depth ≥ 9 mm.
- 2) Temperature rise and power dissipation for operation in LV HRC fuse base.
- 3) Cooling air speed 1 m/s. In the case of natural air cooling, reduction of 5 %.
- 4) Maximum tightening torque:
 - M10 thread (with indicator): 40 Nm
 - M10 capped thread: 50 Nm, screw penetration depth ≥ 9 mm.
 - M24 \times 1.5 thread: 60 Nm.
- 5) Temperature of water-cooled busbar max. +45 °C.
- 6) Maximum tightening torque: M10 capped thread: 35 Nm, screw penetration depth ≥ 9 mm.
- 7) Cooling air speed ≥ 0.5 m/s. In the case of natural air cooling, reduction of 5 %.
- 8) Gauge 140 mm, M12 screw connection.
- 9) Cooling air speed ≥ 2 m/s.
- 10) Bottom (cooled) connection max. +60 °C, top connection (M10) max. +110 °C.
- 11) M12 screw connection.
- 12) Rated voltage according to UL.
- 13) DC rated voltage: [See page 179, "Use with direct current"](#).
- 14) Minimum 50 kA, higher values on request.
- 15) I^2t at U_{VSI} 1500 V, at U_n 1250 V is $k = 0.79$. In the case of 3NB1234-3KK20 I^2t at U_{VSI} 1400 V, at U_n 900 V is I^2t 180000 A²s.

Load rating of SITOR fuse links with 3NH LV HRC fuse bases

Use in switch disconnectors and fuse bases

When using SITOR semiconductor fuses in 3KL and 3KM switch disconnectors with fuses and with 3NP fuse switch disconnectors and 3NH LV HRC fuse bases, the rated current of the fuse must sometimes be reduced due to the higher power loss compared with LV HRC fuses for line protection. Sometimes when using SITOR semiconductor fuses, the currents designated can be higher than the rated currents of the switches and fuse bases. These higher currents only apply when using SITOR semiconductor fuses and cannot be used when using the devices with standard LV HRC fuses. You will find further details in the following selection tables.

When using SITOR semiconductor fuses of the 3NC24, 3NC84, 3NE33 and 3NE43 series, the standard switching capacity of the fuse must not be used as the blades of these fuses (in contrast to LV HRC fuses) are slit. Occasional switching of currents up to the rated current of the fuses is permissible.

The use of SITOR semiconductor fuses > 63 A for overload protection is not permitted – even if gR fuses are used (exception: 3NE1).

The operational voltage is limited by the rated voltage of the switch disconnector or the fuse. If switching without load, the limit value is the rated insulation voltage of the switch disconnector.

The 3NE1 "double protection fuses" can be used as full range fuses (gS) both for semiconductor and line protection.

For further information on the assignment of SITOR semiconductor fuses to the fuse bases and safety switching devices, please refer to the tables on [page 85 ff.](#)

SITOR fuse links						3NH LV HRC fuse bases				
Article No.	I_n	U_n	Operational class	Size	VL	\emptyset min Cu	Article No.	Size	I_{max}	I_{VL}
	A	V AC				mm ²			A	
3NC2423-0C/3C	150	500	gR	3	0.85	70	3NH3430/20	3	150	128
3NC2425-0C/3C	200	500	gR	3	0.85	95		3	190	162
3NC2427-0C/3C	250	500	gR	3	0.85	120		3	240	204
3NC2428-0C/3C	300	500	gR	3	0.85	185		3	285	242
3NC2431-0C/3C	350	500	gR	3	0.85	240		3	330	281
3NC2432-0C/3C	400	500	aR	3	0.85	240		3	400	340
3NC3336-1U	630	1000	aR	3	0.85	2 x (40 x 5)	3NH3430/20	3	560	476
3NC3337-1U	710	1000	aR	3	0.85	2 x (50 x 5)		3	600	510
3NC3338-1U	800	1000	aR	3	0.85	2 x (40 x 8)		3	660	561
3NC3340-1U	900	1000	aR	3	0.90	2 x (40 x 8)		3	750	675
3NC3341-1U	1000	1000	aR	3	0.90	2 x (50 x 8)		3	850	765
3NC3342-1U	1100	800	aR	3	0.90	2 x (50 x 8)		3	900	810
3NC3343-1U	1250	800	aR	3	0.90	2 x (50 x 8)	3	950	855	
3NC3430-1U	315	1250	aR	3	0.95	2 x 95	3NH3430/20	3	310	295
3NC3432-1U	400	1250	aR	3	0.95	2 x 120		3	390	371
3NC3434-1U	500	1250	aR	3	0.90	2 x 150		3	460	414
3NC3436-1U	630	1250	aR	3	0.95	2 x (40 x 5)		3	560	532
3NC3438-1U	800	1100	aR	3	0.90	2 x (40 x 8)	3	690	656	
3NC8423-0C/-3C	150	690	gR	3	0.85	70	3NH3430/20	3	135	115
3NC8425-0C/-3C	200	690	gR	3	0.85	95		3	180	153
3NC8427-0C/-3C	250	690	gR	3	0.85	120		3	250	213
3NC8431-0C/-3C	350	690	gR	3	0.85	240		3	315	268
3NC8434-0C/-3C	500	690	gR	3	0.85	2 x 150		3	450	383
3NC8444-3C	1000	600	aR	3	0.95	2 x (60 x 6)		3	800	800
3NE1020-2	80	690	gR	00	1.0	25	3NH3030/4030	00	80	80
3NE1021-0	100	690	gS	00	1.0	35		00	100	100
3NE1021-2	100	690	gR	00	1.0	35		00	100	100
3NE1022-0	125	690	gS	00	1.0	50		00	125	125
3NE1022-2	125	690	gR	00	1.0	50	00	125	125	
3NE1224-0	160	690	gS	1	1.0	70	3NH3230/4230	1	160	160
3NE1224-2/-3	160	690	gR	1	1.0	70		1	160	160
3NE1225-0	200	690	gS	1	1.0	95		1	200	200
3NE1225-2/-3	200	690	gR	1	1.0	95		1	200	200
3NE1227-0	250	690	gS	1	1.0	120	3NH3330/20	1	250	250
3NE1227-2/-3	250	690	gR	1	1.0	120		1	250	250
3NE1230-0	315	690	gS	1	1.0	2 x 70	3NH3330/20	2	315	315
3NE1230-2/-3	315	690	gR	1	1.0	2 x 70		2	315	315
3NE1331-0	350	690	gS	2	1.0	2 x 95	3NH3330/20	2	350	350
3NE1331-2/-3	350	690	gR	2	1.0	2 x 95		2	350	350
3NE1332-0	400	690	gS	2	1.0	2 x 95	3NH3330/20	2	400	400
3NE1332-2/-3	400	690	gR	2	1.0	2 x 95		2	400	400
3NE1333-0	450	690	gS	2	1.0	2 x 120	3NH3430/20	3	450	450
3NE1333-2/-3	450	690	gR	2	1.0	2 x 120		3	450	450
3NE1334-0	500	690	gS	2	1.0	2 x 120	3NH3430/20	3	500	500
3NE1334-2/-3	500	690	gR	2	1.0	2 x 120		3	500	500
3NE1435-0	560	690	gS	3	1.0	2 x 150	3NH3430/20	3	560	560
3NE1435-2/-3	560	690	gR	3	1.0	2 x 150		3	560	560

Fuse Systems

SITOR Semiconductor Fuses

LV HRC design

SITOR fuse links						Ø min Cu mm ²	3NH LV HRC fuse bases				
Article No.	I_n A	U_n V AC	Operational class	Size	VL		Article No.	Size	I_{max} A	I_{VL}	
3NE1436-0	630	690	gS	3	1.0	2 x 185		3	630	630	
3NE1436-2/3	630	690	gR	3	1.0	2 x 185		3	630	630	
3NE1437-0	710	690	gS	3	1.0	2 x (40 x 5)		3	710	710	
3NE1437-1	710	600	gR	3	1.0	2 x (40 x 5)		3	690	690	
3NE1437-2/3	710	690	gR	3	1.0	2 x (40 x 5)		3	710	710	
3NE1438-0	800	690	gS	3	1.0	2 x (50 x 5)	3NH3430/20	3	800	800	
3NE1438-1	800	600	gR	3	1.0	2 x (50 x 5)		3	750	750	
3NE1438-2/3	800	690	gR	3	1.0	2 x (50 x 5)		3	800	800	
3NE1447-2/3	670	690	gR	3	1.0	2 x (40 x 5)		3	670	670	
3NE1448-2/3	850	690	gR	3	1.0	2 x (40 x 8)		3	850	850	
3NE1802-0	40	690	gS	000	1.0	10	3NH3030/4030	00	40	40	
3NE1803-0	35	690	gS	000	1.0	6		00	35	35	
3NE1813-0	16	690	gS	000	1.0	1.5		00	16	16	
3NE1814-0	20	690	gS	000	1.0	2.5		00	20	20	
3NE1815-0	25	690	gS	000	1.0	4		00	25	25	
3NE1817-0	50	690	gS	000	1.0	10		00	50	50	
3NE1818-0	63	690	gS	000	1.0	16		00	63	63	
3NE1820-0	80	690	gS	000	1.0	25		00	80	80	
3NE3221	100	1000	aR	1	0.95	35		3NH3230/4230	1	100	95
3NE3222	125	1000	aR	1	0.95	50			1	125	119
3NE3224	160	1000	aR	1	1.0	70	1		160	160	
3NE3225	200	1000	aR	1	1.0	95	1		200	200	
3NE3227	250	1000	aR	1	1.0	120		1	250	250	
3NE3230-0B	315	1000	aR	1	0.95	185		2	305	290	
3NE3231	350	1000	aR	1	0.95	240	3NH3330/20	2	335	318	
3NE3232-0B	400	1000	aR	1	0.90	240		2	380	342	
3NE3233	450	1000	aR	1	0.90	2x 150		2	425	383	
3NE3332-0B	400	1000	aR	2	1.0	240	3NH3430/20	3	400	400	
3NE3333	450	1000	aR	2	1.0	2 x 150		3	450	450	
3NE3334-0B	500	1000	aR	2	1.0	2 x 150		3	500	500	
3NE3335	560	1000	aR	2	1.0	2 x 185		3	560	560	
3NE3336	630	1000	aR	2	1.0	2 x 185		3	630	630	
3NE3337-8	710	900	aR	2	1.0	2 x (40 x 5)		3	680	680	
3NE3338-8	800	800	aR	2	0.95	2 x 240		3	700	665	
3NE3340-8	900	690	aR	2	0.95	2 x (40 x 8)		3	750	713	
3NE4101	32	1000	gR	0	0.9	6		3NH3120/4230	0/1	32	29
3NE4102	40	1000	gR	0	0.9	10			0/1	40	36
3NE4117	50	1000	gR	0	0.9	10	0/1		50	45	
3NE4118	63	1000	aR	0	0.9	16	0/1		63	57	
3NE4120	80	1000	aR	0	0.9	25	0/1		80	72	
3NE4121	100	1000	aR	0	0.9	35	0/1		100	90	
3NE4122	125	1000	aR	0	0.9	50	0/1		125	113	
3NE4124	160	1000	aR	0	0.9	70	0/1		160	144	
3NE4327-0B	250	800	aR	2	0.85	150	3NH3330/20		2	240	204
3NE4330-0B	315	800	aR	2	0.85	240			2	300	255
3NE4333-0B	450	800	aR	2	0.85	2 x (30 x 5)	3NH3430/20		3	425	361
3NE4334-0B	500	800	aR	2	0.85	2 x (30 x 5)			3	475	404
3NE4337	710	800	aR	2	0.95	2 x (50 x 5)		3	630	599	
3NE8015-1	25	690	gR	00	0.95	4	3NH3030/4030	00	25	24	
3NE8003-1	35	690	gR	00	0.95	6		00	35	33	
3NE8017-1	50	690	gR	00	0.90	10		00	50	45	
3NE8018-1	63	690	gR	00	0.95	16		00	63	60	
3NE8020-1	80	690	aR	00	0.95	25		00	80	76	
3NE8021-1	100	690	aR	00	0.95	35	3NH3030/4030	00	100	95	
3NE8022-1	125	690	aR	00	0.95	50		00	125	119	
3NE8024-1	160	690	aR	00	0.95	70		00	160	152	

 U_n = Rated voltage I_n = Rated current

VL = Varying load factor

 \varnothing_{min} Cu = Required conductor cross-section Cu I_{max} = Maximum permissible current I_{VL} = Maximum permissible current with varying load

Load rating of SITOR fuse links with 3NP LV HRC fuse switch disconnectors

SITOR fuse links					Ø min Cu mm ²	3NP LV HRC fuse switch disconnectors																	
Article No.	I_n A	U_n V AC	Size	VL		Add-on units																	
					Article No.	Size	I_{max} A	I_{VL}	Article No.	Size	I_{max} A	I_{VL}	Article No.	Size	I_{max} A	I_{VL}	Article No.	Size	I_{max} A	I_{VL}			
3NC2423-0C/ 3NC2423-3C	150	500	3	0.85	70	3NP54	3	145	125	3NP4470	3	140	120	3NP1163	3	140	119						
3NC2425-0C/ 3NC2425-3C	200	500	3	0.85	95		3	180	165		3	175	160		3	175	149						
3NC2427-0C/ 3NC2427-3C	250	500	3	0.85	120		3	225	205		3	220	200		3	220	187						
3NC2428-0C/ 3NC2428-3C	300	500	3	0.85	185		3	255	240		3	250	235		3	250	213						
3NC2431-0C/ 3NC2431-3C	350	500	3	0.85	240		3	330	295		3	320	290		3	320	272						
3NC2432-0C/ 3NC2432-3C	400	500	3	0.85	240	3	400	380	3	370	370	3	370	315									
3NC3336-1U	630	1000	3	0.85	2 x (40 x 5)	3NP54	3	530	451	3NP4470	3	500	425	3NP1163	3	500	425						
3NC3337-1U	710	1000	3	0.85	2 x (50 x 5)		3	570	485		3	570	485		3	570	485						
3NC3338-1U	800	1000	3	0.85	2 x (40 x 8)		3	630	536		3	630	536		3	630	536						
3NC3340-1U	900	1000	3	0.90	2 x (40 x 8)		3	700	630		3	700	630		3	700	630						
3NC3341-1U	1000	1000	3	0.90	2 x (50 x 8)		3	770	693		3	770	693		3	770	693						
3NC3342-1U	1100	800	3	0.90	2 x (50 x 8)	3	800	720	3	800	720	3	800	720									
3NC3343-1U	1250	800	3	0.90	2 x (50 x 8)	3	850	765	3	850	765	3	850	765									
3NC3430-1U	315	1250	3	0.95	2 x 95	3NP54	3	295	280	3NP4470	3	280	266	3NP1163	3	280	266						
3NC3432-1U	400	1250	3	0.95	2 x 120		3	355	337		3	340	323		3	340	323						
3NC3434-1U	500	1250	3	0.90	2 x 150		3	440	396		3	400	360		3	400	360						
3NC3436-1U	630	1250	3	0.95	2 x (40 x 5)		3	520	494		3	460	437		3	460	437						
3NC3438-1U	800	1100	3	0.90	2 x (40 x 8)		3	625	594		3	625	594		3	625	594						
3NC8423-0C/ 3NC8423-3C	150	690	3	0.85	70	3NP54	3	135	125	3NP4470	3	120	120	3NP1163	3	120	102						
3NC8425-0C/ 3NC8425-3C	200	690	3	0.85	95		3	180	165		3	160	160		3	160	136						
3NC8427-0C/ 3NC8427-3C	250	690	3	0.85	120		3	225	205		3	200	200		3	200	170						
3NC8431-0C/ 3NC8431-3C	350	690	3	0.85	240		3	300	275		3	270	270		3	270	230						
3NC8434-0C/ 3NC8434-3C	500	690	3	0.85	2 x 150		3	425	400		3	385	385		3	385	327						
3NC8444-3C	1000	600	3	0.95	2 x (60 x 6)	3	800	760	3	800	760	3	800	760									
3NE1020-2	80	690	00	1.0	25	3NP50	00	80	80	3NP4070	00	80	80	3NP1133	00	80	80						
3NE1021-0	100	690	00	1.0	35		00	100	100		00	100	100		00	100	100						
3NE1021-2	100	690	00	1.0	35		00	100	100		00	98	98		00	95	95						
3NE1022-0	125	690	00	1.0	50		00	125	125		00	125	125		00	120	120						
3NE1022-2	125	690	00	1.0	50		00	125	125		00	120	120		00	115	115						
3NE1224-0	160	690	1	1.0	70	3NP52/42	1	160	160	3NP53/43	2	160	160	3NP1143	1	160	160	3NP1153	2	160	160		
3NE1224-2/-3	160	690	1	1.0	70		1	160	160		2	160	160		1	150	150		2	160	160		
3NE1225-0	200	690	1	1.0	95	1	200	200	1	190	190	1	190	190	2	200	200						
3NE1225-2/-3	200	690	1	1.0	95	1	200/190	200/190	2	200	200	1	180	180	2	190	190						
3NE1227-0	250	690	1	1.0	120	1	250	250	2	250	250	1	235	235	2	250	250						
3NE1227-2/-3	250	690	1	1.0	120	1	250/235	250/235	2	250	250	1	220	220	2	235	235						
3NE1230-0	315	690	1	1.0	2 x 70	3NP53/43	2	315	315	3NP1153	2	290	290										
3NE1230-2/-3	315	690	1	1.0	2 x 70		2	315	315		2	278	278										
3NE1331-0	350	690	2	1.0	2 x 95	3NP53/43	2	350	350	3NP54/44	3	350	350	3NP1153	2	315	315	3NP1163	3	340	340		
3NE1331-2/-3	350	690	2	1.0	2 x 95		2	350	350		3	350	350		2	300	300		3	330	330		
3NE1332-0	400	690	2	1.0	2 x 95		2	400	400		3	400	400		2	340	340		3	380	380		
3NE1332-2/-3	400	690	2	1.0	2 x 95	2	400	400	3	400	400	2	328	328	3	370	370						
3NE1333-0	450	690	2	1.0	2 x 120	3NP54/44	3	450	450	3NP4470	3	425	425	3NP1163	3	450	450						
3NE1333-2/-3	450	690	2	1.0	2 x 120		3NP54	3	450		450	3	425		425	3	430	430					
3NE1334-0	500	690	2	1.0	2 x 120	3NP54/44	3	500	500				3	500	500								
3NE1334-2/-3	500	690	2	1.0	2 x 120	3NP54	3	500	500	3NP4470	3	465	465	3	475	475							
3NE1435-0	560	690	3	1.0	2 x 150	3NP54/44	3	560	560	3NP4470	3	540	540	3NP1163	3	560	560						
3NE1435-2/-3	560	690	3	1.0	2 x 150		3NP54	3	560		560	3	540		540	3	555	555					
3NE1436-0	630	690	3	1.0	2 x 185	3	630	630	3	620	620	3	630	630									
3NE1436-2/-3	630	690	3	1.0	2 x 185	3	625	625	3	600	600	3	620	620									
3NE1437-0	710	690	3	1.0	2 x (40 x 5)	3	710	710	3	690	650	-	-	-									
3NE1437-1	710	600	3	1.0	2 x (40 x 5)	3	690	690	3	670	630	-	-	-									
3NE1437-2/-3	710	690	3	1.0	2 x (40 x 5)	3	685	685	-	-	-	-	-	-									
3NE1438-0	800	690	3	1.0	2 x (50 x 5)	3NP54	3	800	800	3NP4470	3	750	700	-	-	-	-	-	-	-			
3NE1438-1	800	600	3	1.0	2 x (50 x 5)		3	750	750		3	710	630	-	-	-	-	-	-	-			
3NE1438-2/-3	800	690	3	1.0	2 x (50 x 5)		3	770	770		-	-	-	-	-	-	-	-	-	-			
3NE1447-2/-3	670	690	3	1.0	2 x (40 x 5)	3	655	655	-	-	-	-	-	-	-	-	-	-	-				
3NE1448-2/-3	850	690	3	1.0	2 x (40 x 8)	3	820	820	-	-	-	-	-	-	-	-	-	-	-				

Fuse Systems

SITOR Semiconductor Fuses

LV HRC design

SITOR fuse links					Ø min Cu mm ²	3NP LV HRC fuse switch disconnectors																		
Article No.	I _n A	U _n V AC	Size	VL		Add-on units																		
					Article No.	Size	I _{max} A	I _{VL}	Article No.	Size	I _{max} A	I _{VL}	Article No.	Size	I _{max} A	I _{VL}	Article No.	Size	I _{max} A	I _{VL}				
3NE1802-0	40	690	000	1.0	10	3NP35/ 3NP4010	000	40	40	3NP50/ 3NP4070	00	40	40	3NP1123	000	40	40	3NP1133	00	40	40			
3NE1803-0	35	690	000	1.0	6		000	35	35		00	35	35		00	35	35		00	35	35			
3NE1813-0	16	690	000	1.0	1.5		000	16	16		00	16	16		00	16	16		00	16	16			
3NE1814-0	20	690	000	1.0	2.5		000	20	20		00	20	20		00	20	20		00	20	20			
3NE1815-0	25	690	000	1.0	4		000	25	25		00	25	25		00	25	25		00	25	25			
3NE1817-0	50	690	000	1.0	10		000	50	50		00	50	50		00	50	50		00	50	50			
3NE1818-0	63	690	000	1.0	16		000	63	63		00	63	63		00	63	63		00	63	63			
3NE1820-0	80	690	000	1.0	25		000	80	80		00	80	80		00	80	80		00	80	80			
3NE3221	100	1000	1	0.95	35	3NP52/42	1	95	90	3NP53/ 3NP43	2	100	95	3NP1143	1	88	84	3NP1153	2	95	90			
3NE3222	125	1000	1	0.95	50		1	110	110		2	120	114		1	102	97		2	110	105			
3NE3224	160	1000	1	1.0	70		1	140	140		2	150	150		1	130	130		2	140	140			
3NE3225	200	1000	1	1.0	95		1	175	175		2	190	190		1	163	163		2	175	175			
3NE3227	250	1000	1	1.0	120		1	210	210		2	230	230		1	195	195		2	210	210			
3NE3230-0B	315	1000	1	0.95	185		3NP53	2	285		280	3NP4370	2		270	270						2	270	257
3NE3231	350	1000	1	0.95	240			2	310		300		2		290	290					2	290	276	
3NE3232-0B	400	1000	1	0.90	240			2	330		320		2		310	310					2	320	288	
3NE3233	450	1000	1	0.90	2 x 150	2		360	340	2	330		330				2	360	324					
3NE3332-0B	400	1000	2	1.0	240	3NP54		3	360	345	3NP4470		3	345	345	3NP1153	2	330	330	3NP1163	3	360	360	
3NE3333	450	1000	2	1.0	2 x 150		3	400	385	3		385	385					3	375		375			
3NE3334-0B	500	1000	2	1.0	2 x 150		3	450	450	3		430	430					3	420		420			
3NE3335	560	1000	2	1.0	2 x 185		3	510	510	3		490	490					3	475		475			
3NE3336	630	1000	2	1.0	2 x 185		3	580	580	3		560	560					3	540		540			
3NE3337-8	710	900	2	1.0	2 x (40 x 5)		3	630	630	3		590	590					3	580		580			
3NE3338-8	800	800	2	0.95	2 x 240		3	630	630	3		605	605					3	605		575			
3NE3340-8	900	690	2	0.95	2 x (40 x 8)		3	630	630	3		630	630					3	630		599			
3NE4101	32	1000	0	0.9	6	3NP52	1	32	29	3NP4270	1	32	29				3NP1143	1	30	27				
3NE4102	40	1000	0	0.9	10		1	40	36		1	38	34					1	35	32				
3NE4117	50	1000	0	0.9	10		1	50	45		1	45	41					1	42	38				
3NE4118	63	1000	0	0.9	16		1	63	57		1	59	53					1	55	50				
3NE4120	80	1000	0	0.9	25		1	80	72		1	76	68					1	71	64				
3NE4121	100	1000	0	0.9	35		1	95	86		1	90	81					1	84	76				
3NE4122	125	1000	0	0.9	50		1	120	108		1	115	104					1	107	96				
3NE4124	160	1000	0	0.9	70		1	150	135		1	144	130					1	134	121				
3NE4327-0B	250	800	2	0.85	150	3NP53/54	2/3	210/	205/	3NP4470	3	205	200	3NP1153	2	195	166	3NP1163	3	215	183			
3NE4330-0B	315	800	2	0.85	240		2/3	270/	255/		3	260	250		2	240	204		3	270	230			
3NE4333-0B	450	800	2	0.85	2 x (30 x 5)		2/3	400/	370/		3	375	360						3	370	315			
3NE4334-0B	500	800	2	0.85	2 x (30 x 5)		3NP54	3	450		400	3	410		395					3	410	349		
3NE4337	710	800	2	0.95	2 x (50 x 5)	3		600	570	3	540	540				3	540	513						
3NE8015-1	25	690	00	0.95	4	3NP50/ 3NP4070	00	25	24				3NP1133	00	25	24								
3NE8003-1	35	690	00	0.95	6		00	33	31					00	32	30								
3NE8017-1	50	690	00	0.90	10		00	45	41					00	43	39								
3NE8018-1	63	690	00	0.95	16		00	54	51					00	52	49								
3NE8020-1	80	690	00	0.95	25		00	68	65					00	65	62								
3NE8021-1	100	690	00	0.95	35	3NP50/ 3NP4070	00	89	85				3NP1133	00	85	81								
3NE8022-1	125	690	00	0.95	50		00	106	101					00	100	95								
3NE8024-1	160	690	00	0.95	70		00	130	124					00	120	114								

U_n = Rated voltageI_n = Rated current

VL = Varying load factor

Ø_{min} Cu = Required conductor cross-section CuI_{max} = Maximum permissible currentI_{VL} = Maximum permissible current with varying load

SITOR fuse links					Ø min Cu mm ²	3NP LV HRC fuse switch disconnectors															
Article No.	I_n A	U_n V AC	Size	VL		Busbar devices															
					Article No.	Size	I_{max} A	I_{VL}	Article No.	Size	I_{max} A	I_{VL}	Article No.	Size	I_{max} A	I_{VL}	Article No.	Size	I_{max} A	I_{VL}	
3NC2423-0C/ 3NC2423-3C	150	500	3	0.85	70	3NP4476	3	140	120				3NP1163	3	150	128					
3NC2425-0C/ 3NC2425-3C	200	500	3	0.85	95		3	175	160					3	190	162					
3NC2427-0C/ 3NC2427-3C	250	500	3	0.85	120		3	215	195					3	237	201					
3NC2428-0C/ 3NC2428-3C	300	500	3	0.85	185		3	245	230					3	285	242					
3NC2431-0C/ 3NC2431-3C	350	500	3	0.85	240		3	315	285					3	332	282					
3NC2432-0C/ 3NC2432-3C	400	500	3	0.85	240		3	360	360					3	380	323					
3NC3336-1U	630	1000	3	0.85	2 x (40 x 5)								3NP1163	3	500	425					
3NC3337-1U	710	1000	3	0.85	2 x (50 x 5)									3	560	476					
3NC3338-1U	800	1000	3	0.85	2 x (40 x 8)									3	630	536					
3NC3340-1U	900	1000	3	0.90	2 x (40 x 8)									3	630	567					
3NC3341-1U	1000	1000	3	0.90	2 x (50 x 8)									3	630	567					
3NC3342-1U	1100	800	3	0.90	2 x (50 x 8)									3	630	567					
3NC3343-1U	1250	800	3	0.90	2 x (50 x 8)									3	630	567					
3NC3430-1U	315	1250	3	0.95	2 x 95	3NP4476	3	280	266				3NP1163	3	285	271					
3NC3432-1U	400	1250	3	0.95	2 x 120		3	340	323					3	340	323					
3NC3434-1U	500	1250	3	0.90	2 x 150		3	400	360					3	425	383					
3NC3436-1U	630	1250	3	0.95	2 x (40 x 5)		3	460	437					3	535	508					
3NC3438-1U	800	1100	3	0.90	2 x (40 x 8)									3	520	494					
3NC8423-0C/ 3NC8423-3C	150	690	3	0.85	70	3NP4476	3	120	120				3NP1163	3	140	120					
3NC8425-0C/ 3NC8425-3C	200	690	3	0.85	95		3	155	155					3	190	155					
3NC8427-0C/ 3NC8427-3C	250	690	3	0.85	120		3	195	195					3	240	195					
3NC8431-0C/ 3NC8431-3C	350	690	3	0.85	240		3	260	260					3	300	260					
3NC8434-0C/ 3NC8434-3C	500	690	3	0.85	2 x 150		3	375	375					3	385	375					
3NC8444-3C	1000	600	3	0.95	2 x (60 x 6)		3	630	630					3	600	630					
3NE1020-2	80	690	00	1.0	25	3NP4076	00	80	80				3NP1133	00	80	80					
3NE1021-0	100	690	00	1.0	35		00	100	100					00	100	100					
3NE1021-2	100	690	00	1.0	35		00	98	98					00	95	95					
3NE1022-0	125	690	00	1.0	50		00	125	125					00	120	120					
3NE1022-2	125	690	00	1.0	50		00	120	120					00	115	115					
3NE1224-0	160	690	1	1.0	70	3NP4276	1	160	160	3NP4376	2	160	160	3NP1143	1	160	160	3NP1153	2	160	160
3NE1224-2/-3	160	690	1	1.0	70		1	160	160		2	160	160		1	152	152		2	160	160
3NE1225-0	200	690	1	1.0	95		1	200	200		2	200	200		1	200	200		2	200	200
3NE1225-2/-3	200	690	1	1.0	95		1	190	190		2	200	200		1	180	180		2	190	190
3NE1227-0	250	690	1	1.0	120		1	250	250		2	250	250		1	238	238		2	250	250
3NE1227-2/-3	250	690	1	1.0	120		1	235	235		2	250	250		1	213	213		2	235	235
3NE1230-0	315	690	1	1.0	2 x 70						2	315	315						2	315	315
3NE1230-2/-3	315	690	1	1.0	2 x 70						2	315	315						2	315	315
3NE1331-0	350	690	2	1.0	2 x 95	3NP4376	2	350	350	3NP4476	3	350	350	3NP1153	2	350	350	3NP1163	3	350	350
3NE1331-2/-3	350	690	2	1.0	2 x 95		2	350	350		3	350	350		2	330	330		3	350	350
3NE1332-0	400	690	2	1.0	2 x 95		2	400	400		3	400	400		2	380	380		3	400	400
3NE1332-2/-3	400	690	2	1.0	2 x 95		2	400	400		3	400	400		2	360	360		3	400	400
3NE1333-0	450	690	2	1.0	2 x 120						3	450	450						3	430	430
3NE1333-2/-3	450	690	2	1.0	2 x 120						3	425	425						3	420	420
3NE1334-0	500	690	2	1.0	2 x 120						3	480	480						3	450	450
3NE1334-2/-3	500	690	2	1.0	2 x 120						3	450	450						3	450	450
3NE1435-0	560	690	3	1.0	2 x 150	3NP4476	3	510	510				3NP1163	3	520	520					
3NE1435-2/-3	560	690	3	1.0	2 x 150		3	500	500					3	510	510					
3NE1436-0	630	690	3	1.0	2 x 185		3	535	535					3	585	585					
3NE1436-2/-3	630	690	3	1.0	2 x 185		3	520	520					3	570	570					
3NE1437-0	710	690	3	1.0	2 x (40 x 5)		3	600	600					3	605	605					
3NE1437-1	710	600	3	1.0	2 x (40 x 5)		3	570	570					3	590	590					
3NE1437-2/-3	710	690	3	1.0	2 x (40 x 5)		3	540	540					3	580	580					
3NE1438-0	800	690	3	1.0	2 x (50 x 5)	3NP4476	3	640	630				3NP1163	3	630	630					
3NE1438-1	800	600	3	1.0	2 x (50 x 5)		3	600	600					3	610	610					
3NE1438-2/-3	800	690	3	1.0	2 x (50 x 5)		3	580	580					3	600	600					
3NE1447-2/-3	670	690	3	1.0	2 x (40 x 5)		3	530	530					3	575	575					
3NE1448-2/-3	850	690	3	1.0	2 x (40 x 8)		3	630	630					3	630	630					

Fuse Systems

SITOR Semiconductor Fuses

LV HRC design

SITOR fuse links					Ø min Cu mm ²	3NP LV HRC fuse switch disconnectors															
Article No.	I _n A	U _n V AC	Size	VL		Busbar devices															
					Article No.	Size	I _{max} A	I _{VL}	Article No.	Size	I _{max} A	I _{VL}	Article No.	Size	I _{max} A	I _{VL}	Article No.	Size	I _{max} A	I _{VL}	
3NE1802-0	40	690	000	1.0	10	3NP4015/ 3NP4016	000	40	40	3NP4075/ 3NP4076	00	40	40	3NP1123	000	40	40	3NP1133	00	40	40
3NE1803-0	35	690	000	1.0	6		000	35	35		00	35	35		000	35	35		00	35	35
3NE1813-0	16	690	000	1.0	1.5		000	16	16		00	16	16		000	16	16		00	16	16
3NE1814-0	20	690	000	1.0	2.5		000	20	20		00	20	20		000	20	20		00	20	20
3NE1815-0	25	690	000	1.0	4		000	25	25		00	25	25		000	25	25		00	25	25
3NE1817-0	50	690	000	1.0	10		000	50	50		00	50	50		000	50	50		00	50	50
3NE1818-0	63	690	000	1.0	16	000	63	63	00	63	63	000	63	63	00	63	63				
3NE1820-0	80	690	000	1.0	25	000	80	80	00	80	80	000	80	80	00	80	80				
3NE3221	100	1000	1	0.95	35	3NP4276	1	95	90	3NP4376	2	100	95	3NP1143	1	95	90	3NP1153	2	100	95
3NE3222	125	1000	1	0.95	50		1	115	109		2	125	119		1	113	107		2	125	119
3NE3224	160	1000	1	1.0	70		1	150	150		2	160	160		1	140	140		2	150	150
3NE3225	200	1000	1	1.0	95		1	185	185		2	200	200		1	170	170		2	180	180
3NE3227	250	1000	1	1.0	120		1	225	225		2	250	250		1	200	200		2	215	215
3NE3230-0B	315	1000	1	0.95	185						2	285	285						2	265	252
3NE3231	350	1000	1	0.95	240				2	310	310				2	280	266				
3NE3232-0B	400	1000	1	0.90	240				2	330	330				2	310	279				
3NE3233	450	1000	1	0.90	2 x 150				2	360	360				2	330	297				
3NE3332-0B	400	1000	2	1.0	240				3NP4476	3	340	340				3NP1163	3	360	360		
3NE3333	450	1000	2	1.0	2 x 150					3	370	370					3	390	390		
3NE3334-0B	500	1000	2	1.0	2 x 150					3	410	410					3	415	415		
3NE3335	560	1000	2	1.0	2 x 185					3	450	450					3	460	460		
3NE3336	630	1000	2	1.0	2 x 185					3	500	500					3	500	500		
3NE3337-8	710	900	2	1.0	2 x (40 x 5)					3	510	510					3	500	500		
3NE3338-8	800	800	2	0.95	2 x 240				3	520	520				3	500	475				
3NE3340-8	900	690	2	0.95	2 x (40 x 8)				3	530	530				3	500	475				
3NE4101	32	1000	0	0.9	6				3NP4276	1	32	29				3NP1143	1	32	29		
3NE4102	40	1000	0	0.9	10					1	38	34					1	40	36		
3NE4117	50	1000	0	0.9	10					1	45	41					1	50	45		
3NE4118	63	1000	0	0.9	16					1	59	53					1	60	54		
3NE4120	80	1000	0	0.9	25					1	76	68					1	76	68		
3NE4121	100	1000	0	0.9	35					1	90	81					1	93	84		
3NE4122	125	1000	0	0.9	50				1	115	104				1	115	104				
3NE4124	160	1000	0	0.9	70				1	144	130				1	144	130				
3NE4327-0B	250	800	2	0.85	150				3NP4476	3	235	210				3NP1163	3	220	187		
3NE4330-0B	315	800	2	0.85	240					3	280	260					3	255	217		
3NE4333-0B	450	800	2	0.85	2 x (30 x 5)					3	390	370					3	355	302		
3NE4334-0B	500	800	2	0.85	2 x (30 x 5)					3	415	400					3	390	332		
3NE4337	710	800	2	0.95	2 x (50 x 5)					3	480	480					3	500	475		
3NE8015-1	25	690	00	0.95	4	3NP4075/ 3NP4076	00	25		24				3NP1133	00		25	24			
3NE8003-1	35	690	00	0.95	6		00	33	31				00		35	33					
3NE8017-1	50	690	00	0.90	10		00	45	41				00		50	45					
3NE8018-1	63	690	00	0.95	16		00	53	50				00		60	57					
3NE8020-1	80	690	00	0.95	25		00	68	65				00		72	68					
3NE8021-1	100	690	00	0.95	35		00	85	81				00		85	81					
3NE8022-1	125	690	00	0.95	50	00	100	95				00	100	95							
3NE80s24-1	160	690	00	0.95	70	00	125	120				00	115	109							

U_n = Rated voltageI_n = Rated current

VL = Varying load factor

Ø_{min} Cu = Required conductor cross-section CuI_{max} = Maximum permissible currentI_{VL} = Maximum permissible current with varying load

Load rating of SITOR fuse links with 3KL/3KM LV HRC fuse switch disconnectors

SITOR fuse links					Ø min Cu mm ²	3KL/3KM switch disconnectors with fuses								3KM... busbar devices															
Article No.	I _n A	U _n V AC	Size	VL		3KL... add-on devices				3KM... busbar devices																			
					Article No.	Size	I _{max} A	I _{VL}	Article No.	Size	I _{max} A	I _{VL}	Article No.	Size	I _{max} A	I _{VL}													
3NC2423-0C/ 3NC2423-3C	150	500	3	0.85	70	3KL61	3	145	123	3KL62	3	150	128																
3NC2425-0C/ 3NC2425-3C	200	500	3	0.85	95		3	180	153		3	190	162																
3NC2427-0C/ 3NC2427-3C	250	500	3	0.85	120		3	225	191		3	240	204																
3NC2428-0C/ 3NC2428-3C	300	500	3	0.85	185		3	255	217		3	270	230																
3NC2431-0C/ 3NC2431-3C	350	500	3	0.85	240		3	330	281		3	345	293																
3NC2432-0C/ 3NC2432-3C	400	500	3	0.85	240		3	400	340		3	400	340																
3NC3336-1U 3NC3337-1U 3NC3338-1U	630 710 800	1000	3	0.85	2 x (40 x 5) 2 x (50 x 5) 2 x (40 x 8)	3KL62	3	500	425	3KL61	3	480	408																
3NC3340-1U 3NC3341-1U 3NC3342-1U 3NC3343-1U	900 1000 1100 1250	1000	3	0.90	2 x (40 x 8) 2 x (50 x 8) 2 x (50 x 8) 2 x (50 x 8)		3 3 3 3	650 720 800 800	585 648 720 720		3 3 3 3	480 459 510 510	408																
3NC3430-1U 3NC3432-1U	315 400	1250	3	0.95	2 x 95 2 x 120		3KL61	3	285		271	3KL62	3	300	285														
3NC3434-1U 3NC3436-1U 3NC3438-1U	500 630 800	1250	3	0.90	2 x 150 2 x (40 x 5) 2 x (40 x 8)			3 3 3	425 500 650		383 475 618		3 3 3	450 540 618	405 513														
3NC8423-0C/ 3NC8423-3C	150	690	3	0.85	70			3KL61	3		135		115	3KL62	3	140	119												
3NC8425-0C/ 3NC8425-3C	200	690	3	0.85	95				3		180		153		3	190	162												
3NC8427-0C/ 3NC8427-3C	250	690	3	0.85	120	3	225		191	3	240	204																	
3NC8431-0C/ 3NC8431-3C	350	690	3	0.85	240	3	300		255	3	315	268																	
3NC8434-0C/ 3NC8434-3C	500	690	3	0.85	2 x 150	3	425		361	3	450	383																	
3NC8444-3C	1000	600	3	0.95	2 x (60 x 6)	3KL62	3		800	760	3KL61	3	630		630														
3NE1020-2 3NE1021-0 3NE1021-2	80 100 100	690	00	1.0	25 35 35	3KL52	00	80	80	3KL53	00	80	80	3KM52	00	80	80	3KM53	00	80	80								
3NE1022-0 3NE1022-2	125 125	690	00	1.0	50 50		00	100 100	100 100		00	100 100	100 100		00	100 100	100 100		00	100 100	100 100								
3NE1224-0 3NE1224-2/-3	160 160	690	1	1.0	70 70		3KL55	1	160		160	3KL57	2		160	160	3KM55		1	160	160	3KM57	00	125	125				
3NE1225-0 3NE1225-2/-3	200 200	690	1	1.0	95 95			1	200 200		200 200		2		200 200	200 200			1	200 200	200 200		2	160 200	160 200				
3NE1227-0 3NE1227-2/-3	250 250	690	1	1.0	120 120	1		250 245	250 245	2	250 250		250 250	1	250 245	250 245		2	200 250	200 250									
3NE1230-0 3NE1230-2/-3	315 315	690	1	1.0	2 x 70 2 x 70	3KL57		2	315	315	3KM57		2	315	315	3KM57		2	315	315	3KM57		2	250	250				
3NE1331-0 3NE1331-2/-3	350 350	690	2	1.0	2 x 95 2 x 95			3KL57	2	330			330	3KL61	3			350	350	3KM57			2	330	330	3KM57	2	300	300
3NE1332-0 3NE1332-2/-3	400 400	690	2	1.0	2 x 95 2 x 95	2			375 340	375 340	3		400 400		400 400	2		375 315	375 315		2		375 315	375 315					
3NE1333-0 3NE1333-2/-3	450 450	690	2	1.0	2 x 120 2 x 120	3KL61	3		450	450	3KL62	3	450		450	3KM57	2	400	400		3KM57	2	325	325					
3NE1334-0 3NE1334-2/-3	500 500	690	2	1.0	2 x 120 2 x 120		3		500 500	500 500		3	500 500		500 500		2	400 350	400 350			2	400 350	400 350					
3NE1435-0 3NE1435-2/-3	560 560	690	3	1.0	2 x 150 2 x 150		3KL61		3	560		560	3KL62		3		560	560	3KM57			3	560	560	3KM57		3	560	560
3NE1436-0 3NE1436-2/-3	630 630	690	3	1.0	2 x 185 2 x 185				3	630 615		630 615			3		630 630	630 630				3	630 630	630 630			3	630 630	630 630
3NE1437-0 3NE1437-1 3NE1437-2/-3	710 710 710	690	3	1.0	2 x (40 x 5) 2 x (40 x 5) 2 x (40 x 5)	3 3 3		630 630 630	630 630 630	3 3 3	710 710 700	710 710 700		3	710 710 700	710 710 700	3	710 710 700		710 710 700									
3NE1438-0 3NE1438-1 3NE1438-2/-3	800 800 800	690	3	1.0	2 x (50 x 5) 2 x (50 x 5) 2 x (50 x 5)	3KL61		3	630	630	3KL62	3		800	800	3KM57	3	800		800	3KM57	3	800	800					
3NE1447-2/-3 3NE1448-2/-3	670 850	690	3	1.0	2 x (40 x 5) 2 x (40 x 8)			3 3	630 630	630 630		3 3		670 790	670 790		3	670 790		670 790		3	670 790	670 790					

Fuse Systems

SITOR Semiconductor Fuses

LV HRC design

SITOR fuse links					Ø min Cu mm ²	3KL/3KM switch disconnectors with fuses								3KM... busbar devices										
Article No.	I_n A	U_n V AC	Size	VL		3KL... add-on devices								3KM... busbar devices										
					Article No.	Size	I_{max} A	I_{VL}	Article No.	Size	I_{max} A	I_{VL}	Article No.	Size	I_{max} A	I_{VL}	Article No.	Size	I_{max} A	I_{VL}				
3NE1802-0	40	690	000	1.0	10	3KL50	00	40	40	3KL52	00	40	40	3KM50	00	40	40	3KM52	00	40	40			
3NE1803-0	35	690	000	1.0	6		00	35	35		00	35	35		00	35	35		00	35	35	00	35	35
3NE1813-0	16	690	000	1.0	1.5		00	16	16		00	16	16		00	16	16		00	16	16	00	16	16
3NE1814-0	20	690	000	1.0	2.5		00	20	20		00	20	20		00	20	20		00	20	20	00	16	16
3NE1815-0	25	690	000	1.0	4		00	25	25		00	25	25		00	25	25		00	25	25	00	20	20
3NE1817-0	50	690	000	1.0	10		00	50	50		00	50	50		00	50	50		00	50	50	00	25	25
3NE1818-0	63	690	000	1.0	16	00	63	63	00	63	63	00	63	63	00	63	63	00	50	50				
3NE1820-0	80	690	000	1.0	25	3KL52	00	80	80				3KM52	00	80	80				00	63	63		
3NE3221	100	1000	1	0.95	35	3KL55	1	90	86	3KL57	2	95	90	3KM55	1	90	86	3KM57	2	95	90			
3NE3222	125	1000	1	0.95	50		1	110	105		2	115	109		1	110	105		2	115	109			
3NE3224	160	1000	1	1.0	70		1	140	140		2	150	150		1	140	140		2	150	150			
3NE3225	200	1000	1	1.0	95		1	175	175		2	180	180		1	175	175		2	180	180			
3NE3227	250	1000	1	1.0	120		1	210	210		2	220	220		1	210	210		2	220	220			
3NE3230-0B	315	1000	1	0.95	185						2	240	228						2	240	228			
3NE3231	350	1000	1	0.95	240				2	265	252				2	265	252							
3NE3232-0B	400	1000	1	0.90	240				2	290	261				2	290	261							
3NE3233	450	1000	1	0.90	2 x 150				2	320	288				2	320	288							
3NE3332-0B	400	1000	2	1.0	240	3KL61	3	340	340	3KL62	3	360	360	3KM57	2	290	290	3KM57	2	320	288			
3NE3333	450	1000	2	1.0	2 x 150		3	380	380		3	400	400		2	320	320		2	360	360			
3NE3334-0B	500	1000	2	1.0	2 x 150		3	440	440		3	470	470		2	360	360		2	400	400			
3NE3335	560	1000	2	1.0	2 x 185		3	500	500		3	530	530		2	400	400		2	400	400			
3NE3336	630	1000	2	1.0	2 x 185		3	540	540		3	580	580		2	400	400		2	400	400			
3NE3337-8	710	900	2	1.0	2 x (40 x 5)		3	600	600		3	640	640		2	400	400		2	400	400			
3NE3338-8	800	800	2	0.95	2 x 240	3	630	630	3	720	680	2	400	400	2	400	400							
3NE3340-8	900	690	2	0.95	2 x (40 x 8)	3	630	630	3	800	750	2	400	400	2	400	400							
3NE4101	32	1000	0	0.9	6				3KL55	1	32	29	3KM55	1	32	29								
3NE4102	40	1000	0	0.9	10					1	40	36		1	40	36								
3NE4117	50	1000	0	0.9	10					1	50	45		1	50	45								
3NE4118	63	1000	0	0.9	16					1	63	57		1	63	57								
3NE4120	80	1000	0	0.9	25					1	80	72		1	80	72								
3NE4121	100	1000	0	0.9	35					1	95	86		1	95	86								
3NE4122	125	1000	0	0.9	50				1	120	108	1	120	108										
3NE4124	160	1000	0	0.9	70				1	150	135	1	150	135										
3NE4327-0B	250	800	2	0.85	150	3KL57	2	175	149	3KL61	3	200	170	3KM57	2	175	149							
3NE4330-0B	315	800	2	0.85	240		2	230	196		3	260	221		2	230	196							
3NE4333-0B	450	800	2	0.85	2 x (30 x 5)		2	340	289		3	370	315		2	340	289							
3NE4334-0B	500	800	2	0.85	2 x (30 x 5)	3KL61	3	425	361	3KL62	3	450	375		2	380	323							
3NE4337	710	800	2	0.95	2 x (50 x 5)		3	600	570		3	630	600		2	400	400							
3NE8015-1	25	690	00	0.95	4	3KL50	00	25	24	3KL52	00	25	24	3KM50	00	25	24	3KM52	00	25	24			
3NE8003-1	35	690	00	0.95	6		00	33	31		00	35	33		00	33	31		00	35	33	00	35	33
3NE8017-1	50	690	00	0.90	10		00	45	41		00	50	45		00	45	41		00	50	45	00	35	33
3NE8018-1	63	690	00	0.95	16		00	54	51		00	60	57		00	54	51		00	50	45			
3NE8020-1	80	690	00	0.95	25	3KL52	00	68	65	3KL53	00	68	65	3KM52	00	68	65		00	60	57			
3NE8021-1	100	690	00	0.95	35	3KL52	00	89	85	3KL53	00	89	85	3KM52	00	89	85	3KM53	00	68	65			
3NE8022-1	125	690	00	0.95	50		00	106	101		00	106	101		00	106	101		00	106	101	00	89	85
3NE8024-1	160	690	00	0.95	70		00	130	124		00	130	124		00	130	124		00	130	124	00	106	101

 U_n = Rated voltage I_n = Rated current

VL = Varying load factor

 \varnothing_{min} Cu = Required conductor cross-section Cu I_{max} = Maximum permissible current I_{VL} = Maximum permissible current with varying load

Dimensional drawings

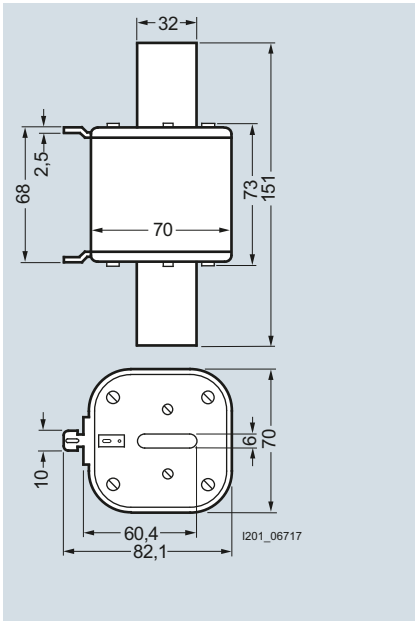

3NE143.-0, 3NE143.-1

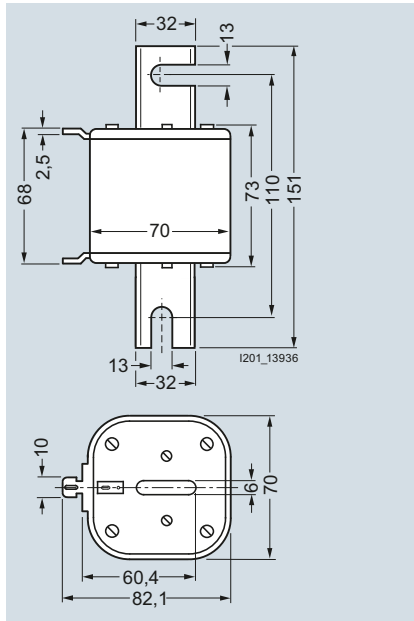

3NE14...-3

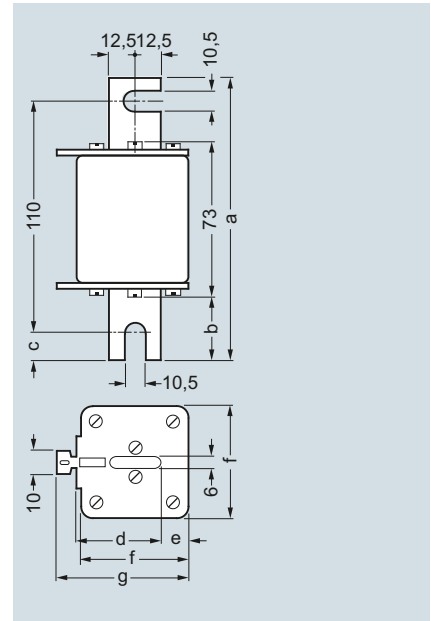

3NE12...-3, 3NE13...-3

Type	Dimensions (mm)						
	a	b	c	d	e	f	g
3NE12...-3	135	31	12.5	40.5	13.5	52	63.5
3NE13...-3	149	38	19.5	47.5	15	60	72

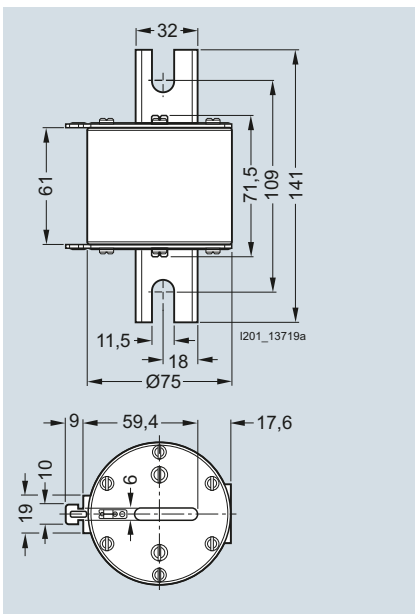

3NC24...-0C, 3NC84...-0C

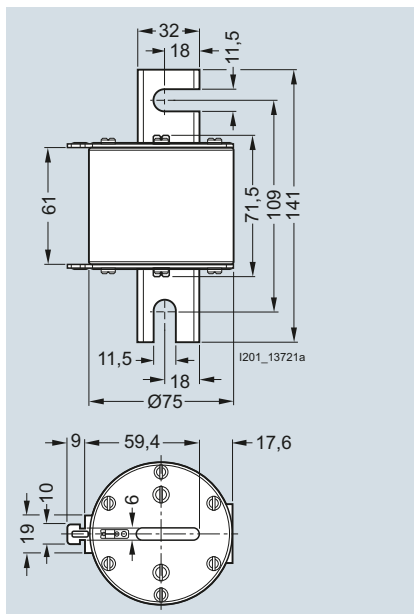

3NC24...-3C, 3NC84...-3C

Fuse Systems

SITOR Semiconductor Fuses

LV HRC design

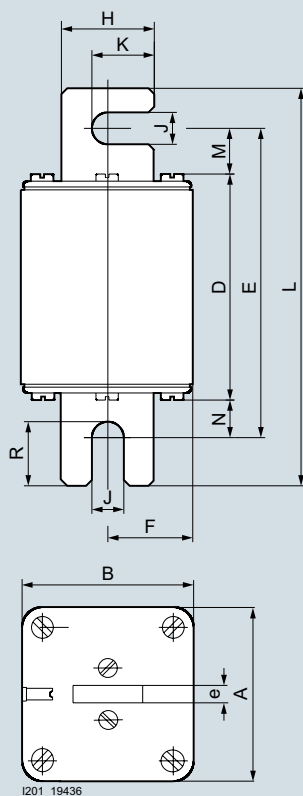

Type	Dimensions												
	A	B	D	E	F	H	J	K	L	M	N	R	e
3NE32..-0MK	52	52	78,4	106,6	26	25	11	18	137	15,7	12,5	22,3	6
3NE32..-0MK08	52	52	78,4	106,6	26	25	11	18	137	15,7	12,5	22,3	6
3NE53..-0MK06	60	60	137	165,5	30	32	11	21,5	196	15,8	12,8	22,1	6

3NE32..-0MK, 3NE323..-0MK08

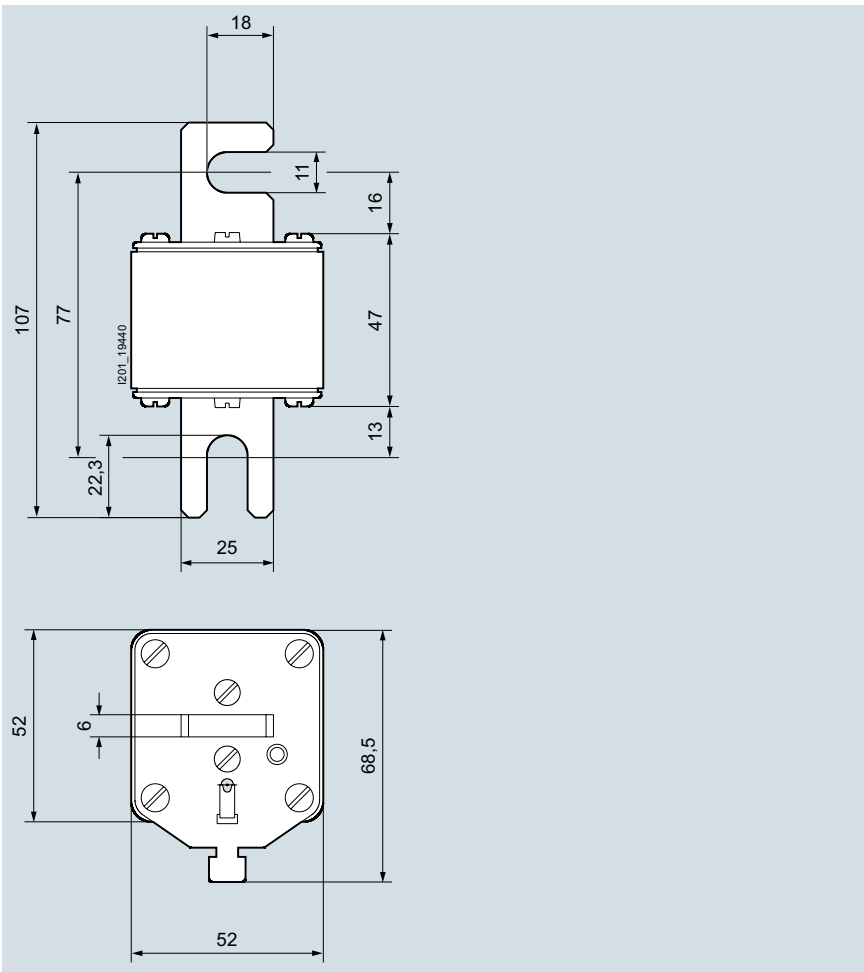

3NE82..-3MK:

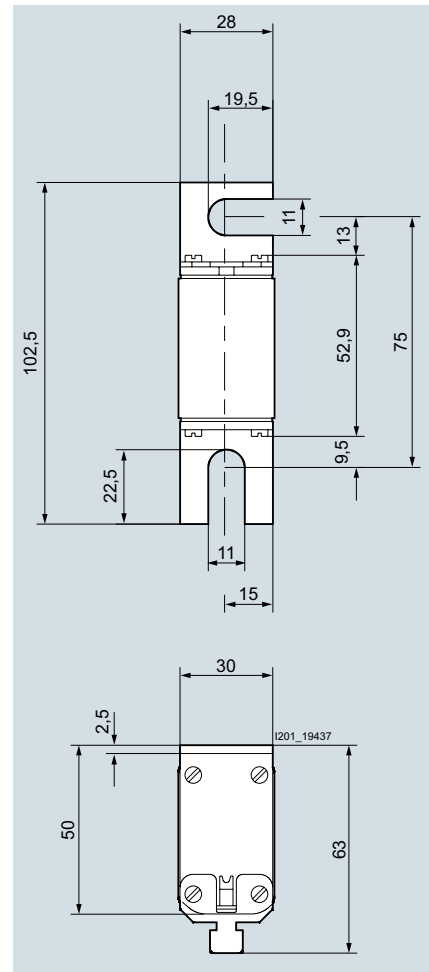

3NE80..-3MK:

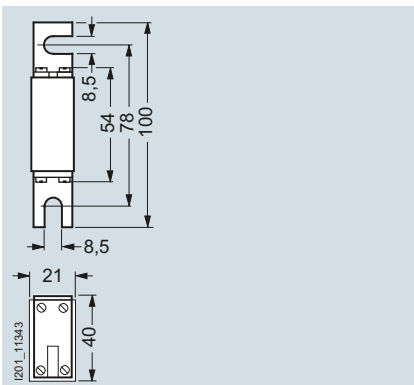

3NE87...-1

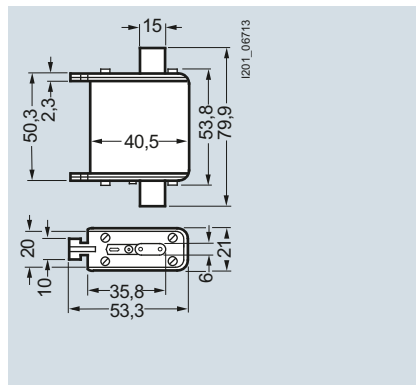

3NE18...-0

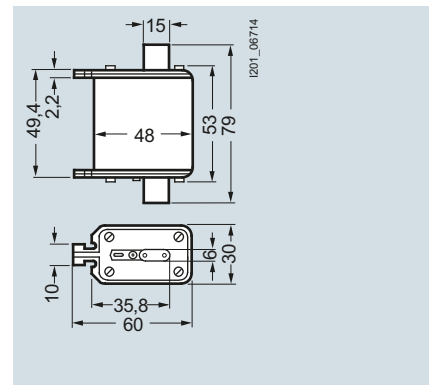

3NE102..-0, 3NE102..-2, 3NE80...-1

Fuse Systems

SITOR Semiconductor Fuses

LV HRC design

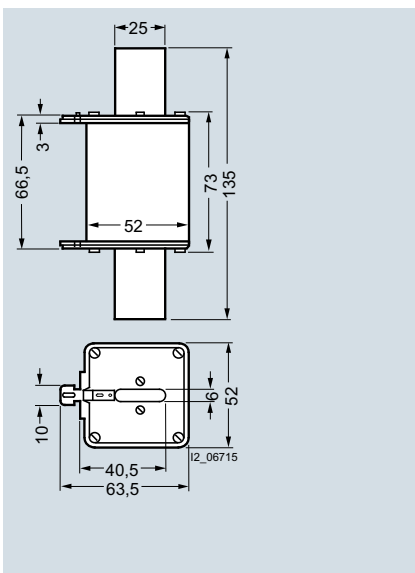

3NE12...-0, 3NE12...-2

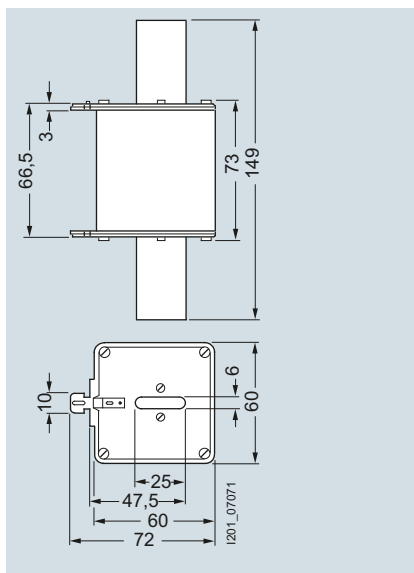

3NE133...-0, 3NE133...-2

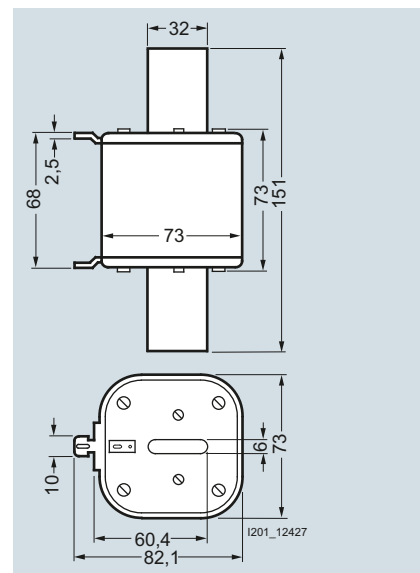

3NE14...-2

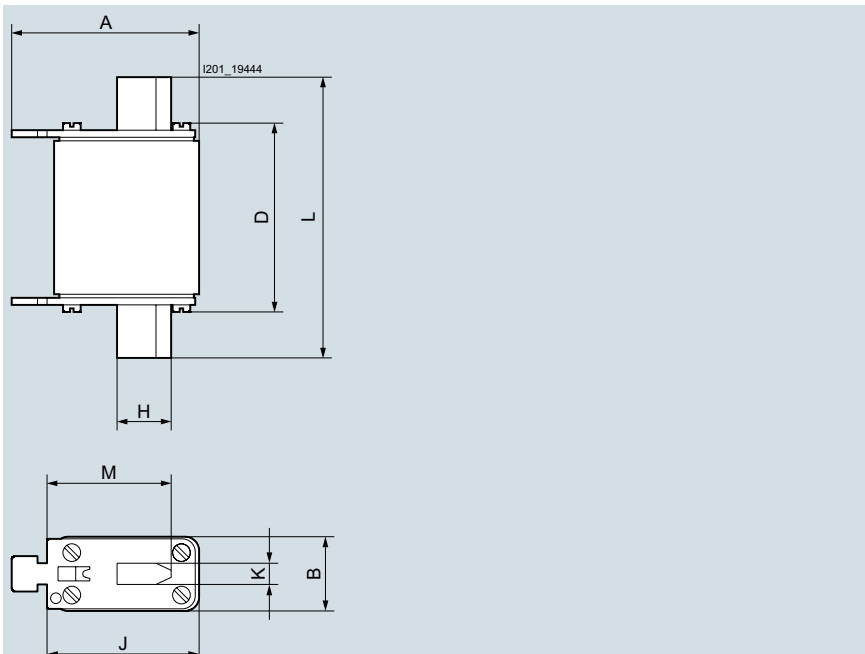

Type	Dimensions							
	A	B	D	H	J	K	M	L
3NE88...-0MK	53	21	51,5	15	43	6	35	78,5
3NE82...-0MK	62,5	44	70,5	20	53	6	40	135
3NE83...-0MK	68	50	70,5	25	61	6	48	150

3NE82...-0MK, 3NE83...-0MK, 3NE88...-0MK

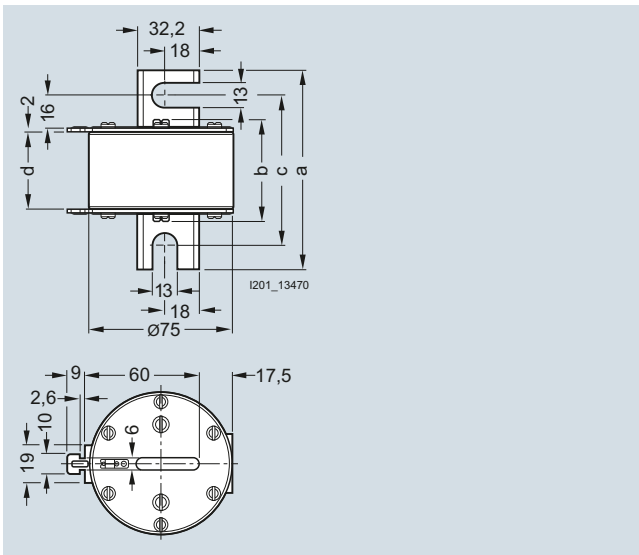

3NC32...-1U, 3NC33...-1U, 3NC34...-1U

Type	Dimensions (mm)			
	a	b	c	d
3NC32...-1U	102	51	78	40
3NC33...-1U	139	72	108	61
3NC34...-1U	139	72	108	61

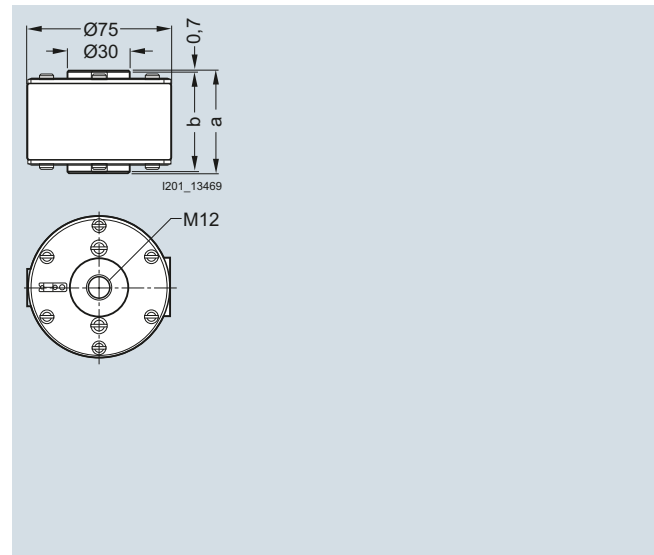

3NC32...-6U, 3NC33...-6U, 3NC34...-6U

Type	Dimensions (mm)	
	a	b
3NC32...-6U	52	50
3NC33...-6U	73	71
3NC34...-6U	73	71

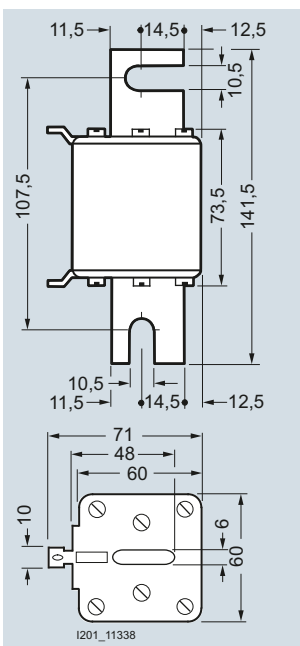

3NE43...-0B, 3NE4337

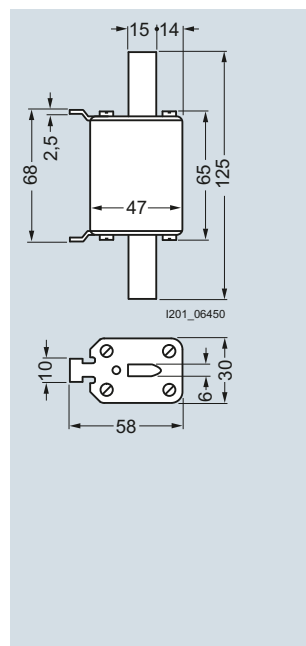

3NE41..

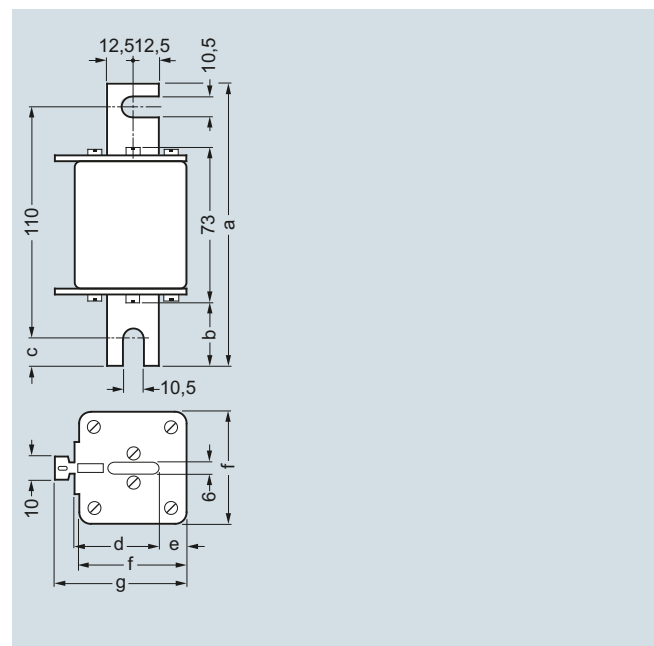

3NE322., 3NE323., 3NE33..

Type	Dimensions (mm)						
	a	b	c	d	e	f	g
3NE322.	135	31	12.5	40.5	13.5	52	63.5
3NE323.	135	31	12.5	40.5	13.5	52	63.5
3NE33..	149	38	19.5	47.5	15	60	72

Fuse Systems

SITOR Semiconductor Fuses

LV HRC design

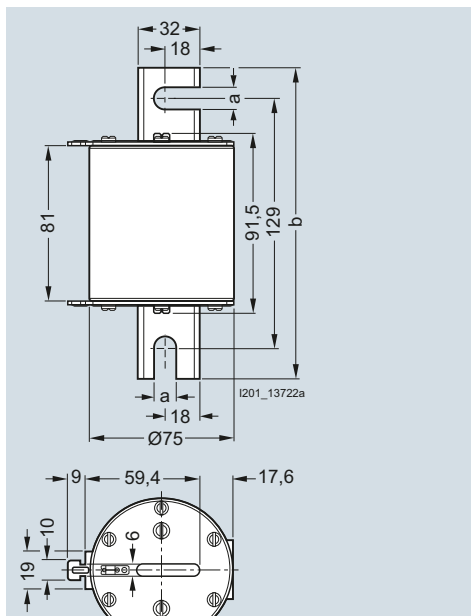

3NE3...-0C, 3NE36...-1C

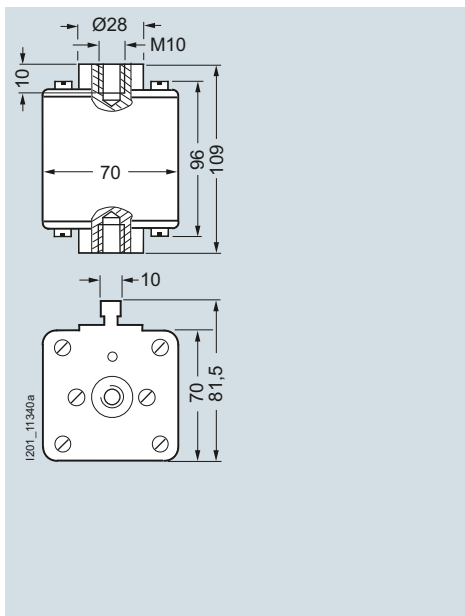

3NE3635-6

Type	Dimensions (mm)	
	a	b
3NE3...-0C	11.5	161
3NE36...-1C	13	171

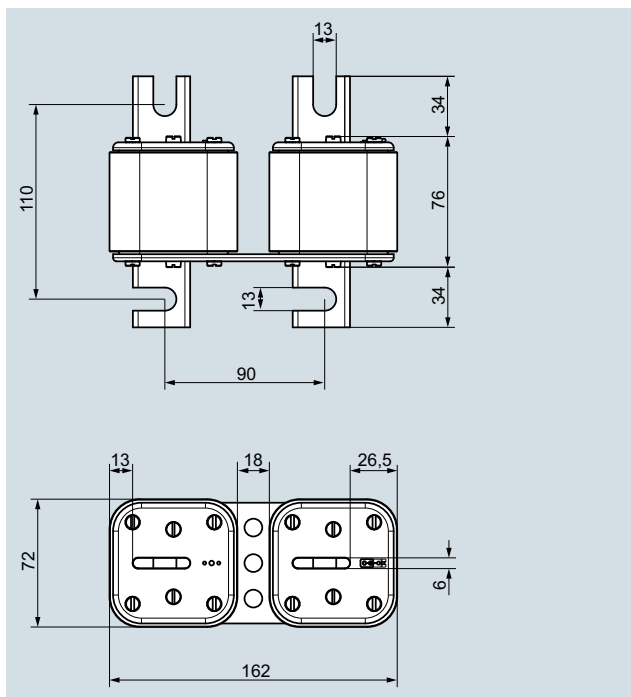

3NB335-1KK26

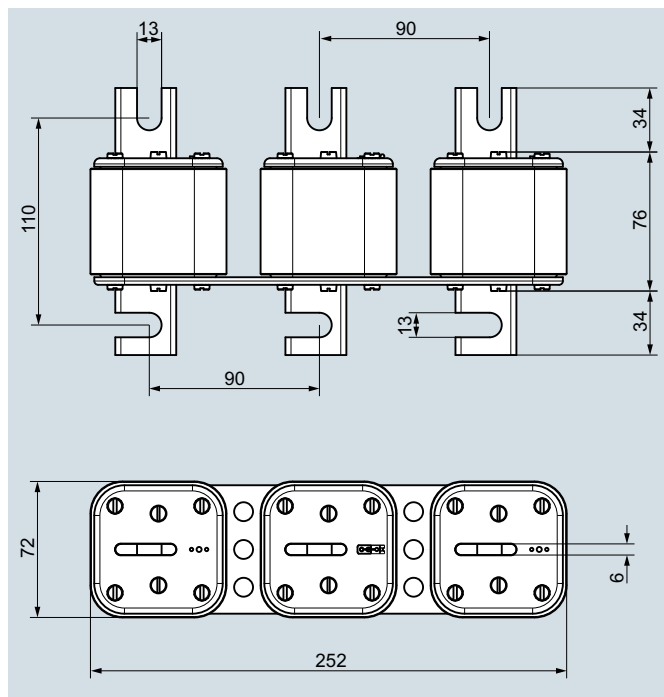

3NB3358-1KK27, 3NB3362-1KK27

Type	I_n A	U_n V AC	Operational class Characteristic
3NB3350-1KK26	1000	690	gR
3NB3351-1KK26	1100	690	gR
3NB3352-1KK26	1250	690	gR
3NB3354-1KK26	1350	690	gR
3NB3355-1KK26	1400	690	gR
3NB3357-1KK26	1600	690	gR
3NB3358-1KK26	1700	690	gR

Type	I_n A	U_n V AC	Operational class Characteristic
3NB3358-1KK27	1700	690	gR
3NB3362-1KK27	1900	690	gR

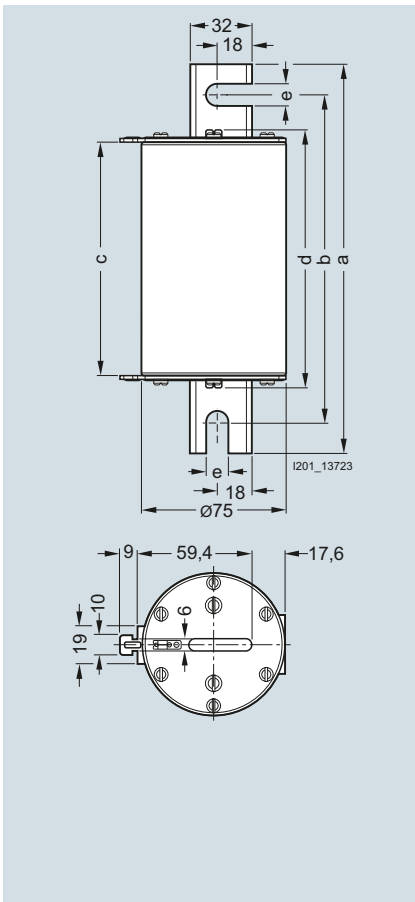

3NE56...-0C

Type	Dimensions (mm)				
	a	b	c	d	e
3NE56...-0C	201	169	121	131.5	11.5

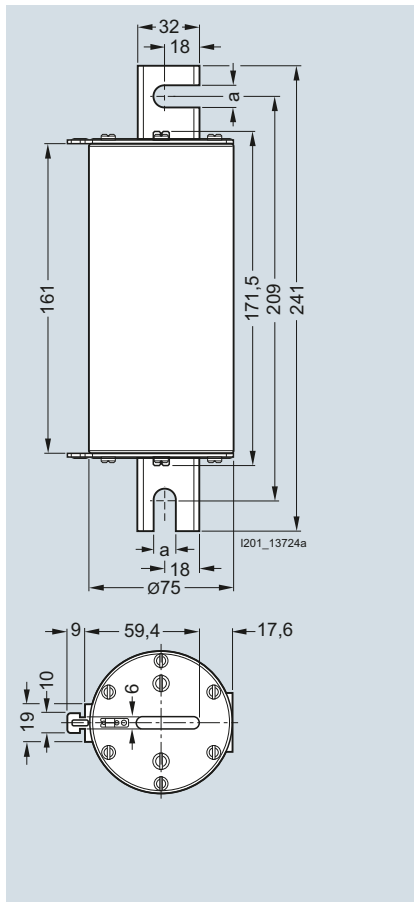

3NE54...-0C, 3NE54...-1C;
3NE7...-0U, 3NE7...-1U

Type	Dimensions (mm)
	a
3NE54...-0C	11.5
3NE54...-1C	13
3NE7...-0U	11.5
3NE7...-1U	13

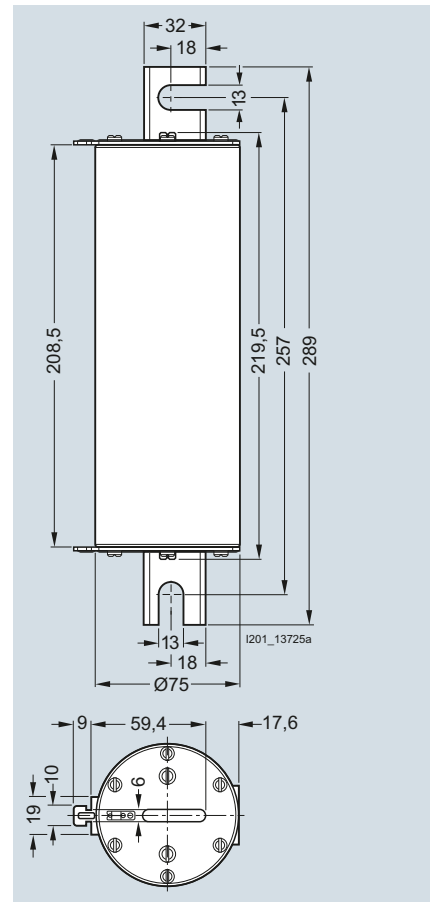

3NE96...-1C

Fuse Systems

SITOR Semiconductor Fuses

LV HRC design

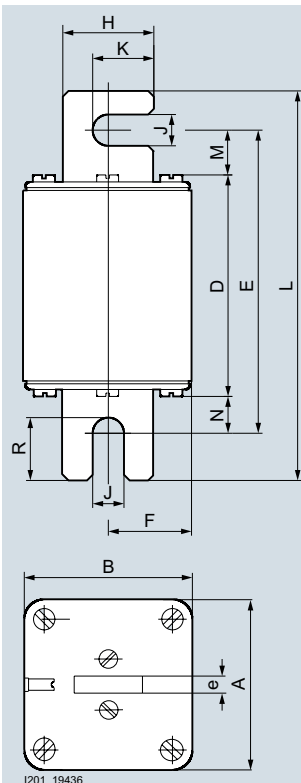

Type	Dimensions											
	A	B	D	E	F	H	J	K	L	M	N	R
3NE32..-OMK	52	52	78,4	106,6	26	25	11	18	137	15,7	12,5	22,3
3NE32..-OMK08	52	52	78,4	106,6	26	25	11	18	137	15,7	12,5	22,3

3NE53..-OMK06

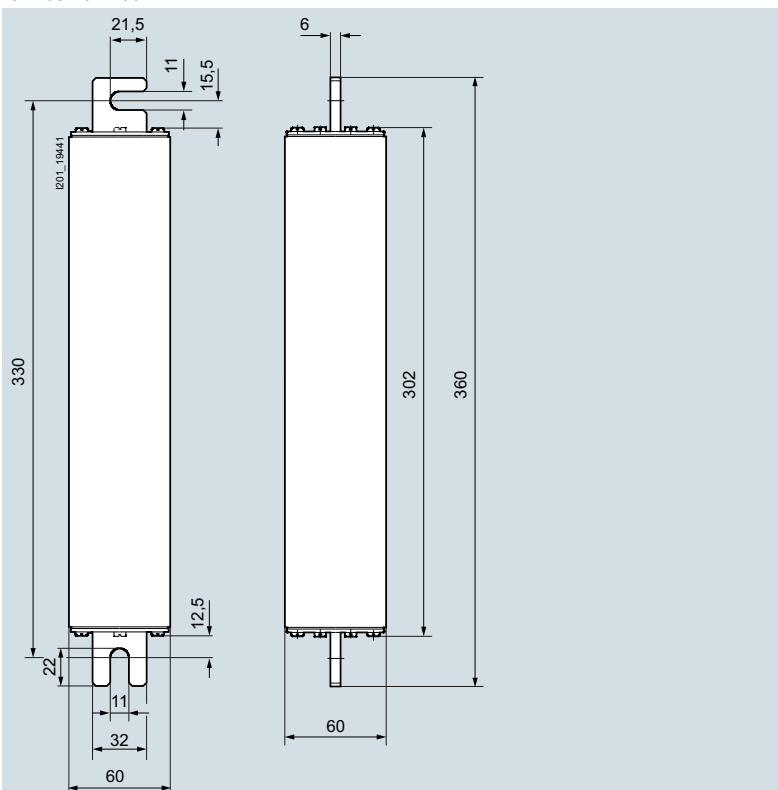

3NE9330-OMK07

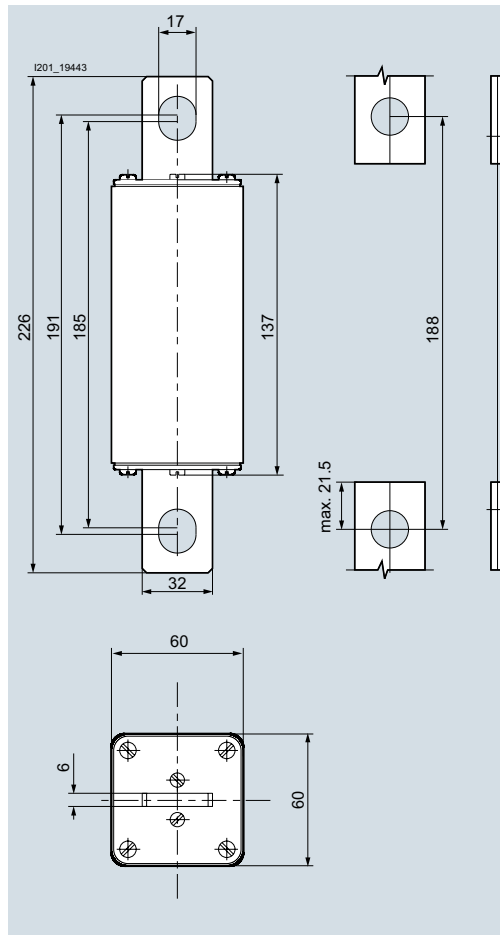

3NE5336-OMK66

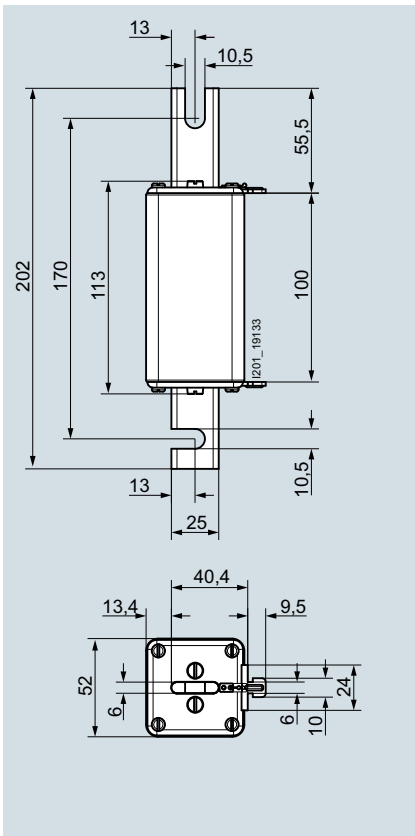

3NB1126-4KK11
3NB1128-4KK11

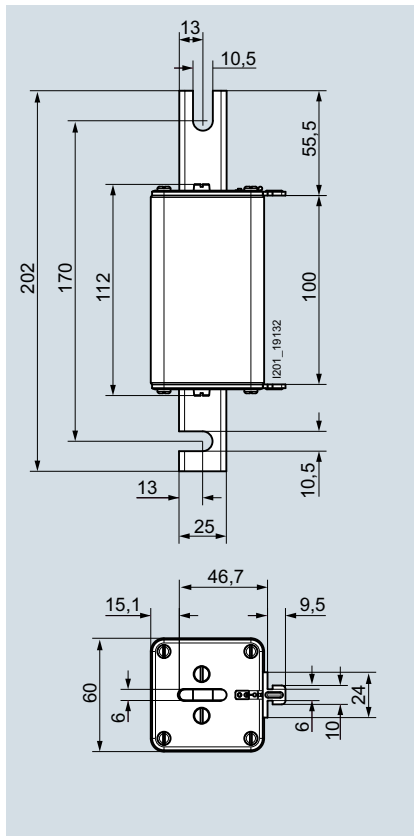

3NB1231-4KK11
3NB1234-4KK11

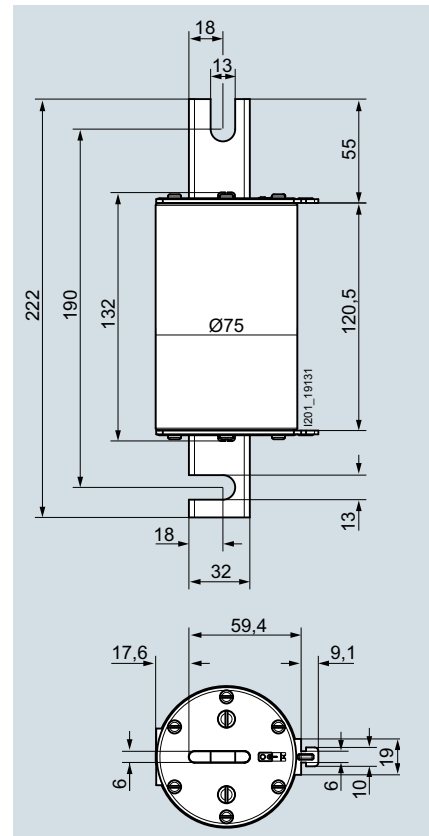

3NB1337-4KK11
3NB1345-4KK11

Type	I_n A	U_n V DC	Operational class Characteristic
3NB1126-4KK11	200	1250	aR
3NB1128-4KK11	250	1250	aR

Type	I_n A	U_n V DC	Operational class Characteristic
3NB1231-4KK11	315	1250	aR
3NB1234-4KK11	400	1250	aR

Type	I_n A	U_n V DC	Operational class Characteristic
3NB1337-4KK11	500	1250	aR
3NB1345-4KK11	800	1250	aR

Fuse Systems

SITOR Semiconductor Fuses

LV HRC design

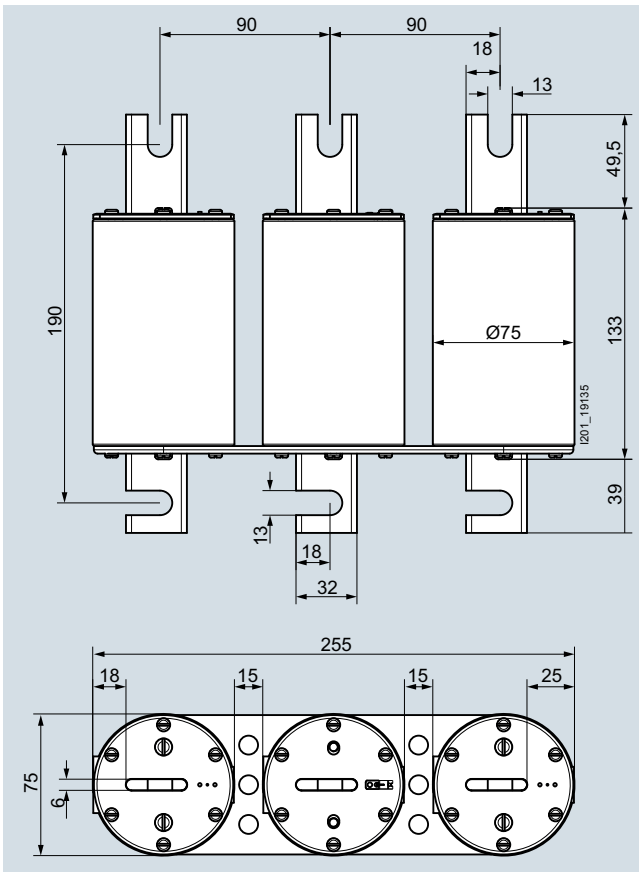

3NB2364-4KK17, 3NB2366-4KK17

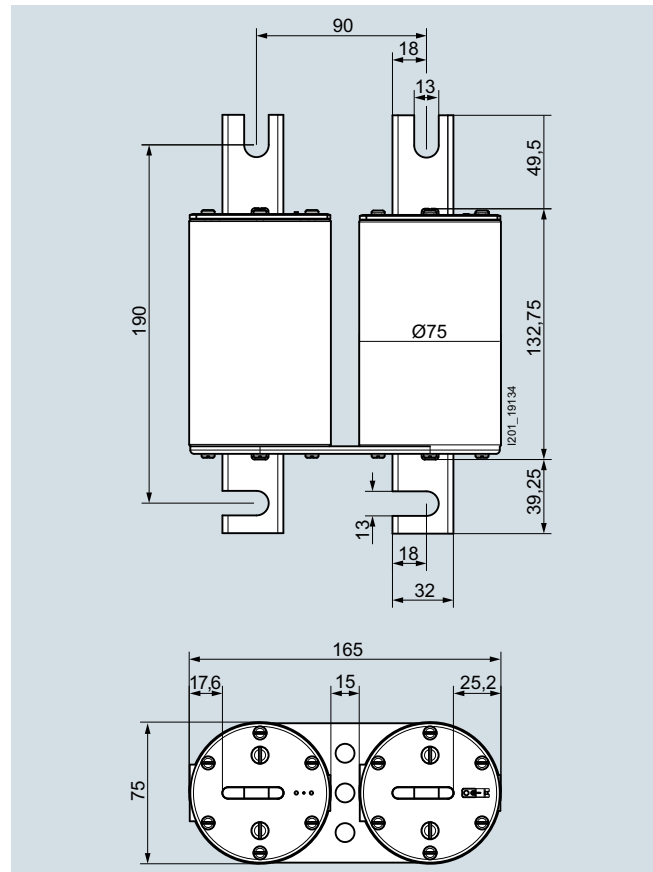

3NB2345-4KK16,
3NB2350-4KK16,
3NB2355-4KK16,
3NB2357-4KK16

Type	I_n A	U_n V DC	Operational class Characteristic
3NB2364-4KK17	2100	1250	aR
3NB2366-4KK17	2400	1000	aR

Type	I_n A	U_n V DC	Operational class Characteristic
3NB2345-4KK16	800	1250	aR
3NB2350-4KK16	1000	1250	aR
3NB2355-4KK16	1400	1250	aR
3NB2357-4KK16	1600	1250	aR

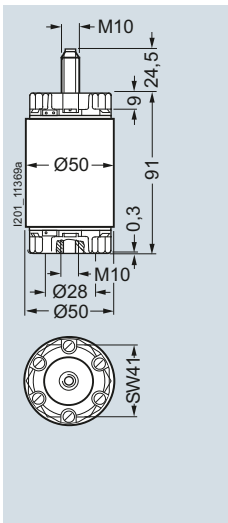

3NC5531

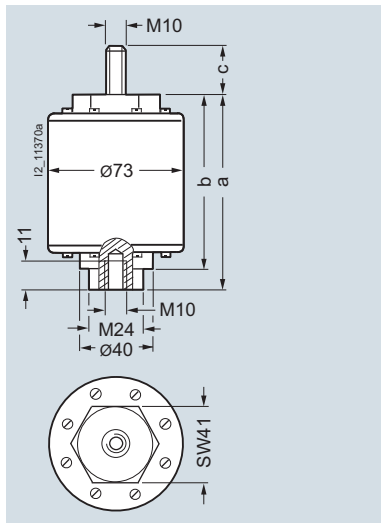

3NC58..

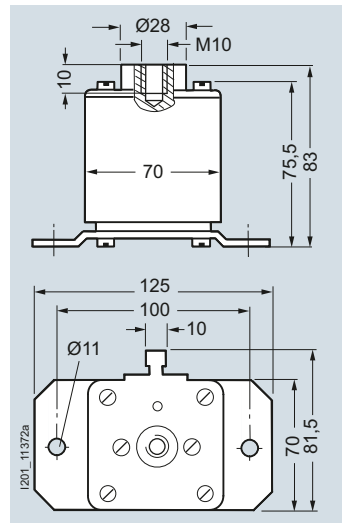

3NE64..-7, 3NE94..-7

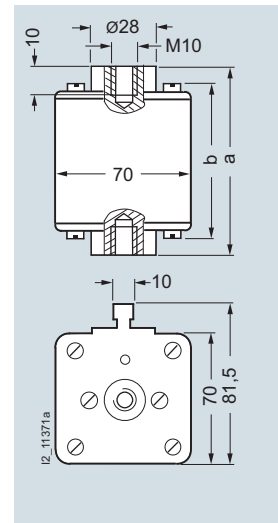

3NE64.., 3NE94..

Type	Dimensions (mm)		
	a	b	c
3NC5838	98	88.5	25
3NC5841	98	88.5	25
3NC5840	119	109.5	20.5

Type	Dimensions (mm)	
	a	b
3NE6437	89	76
3NE9450	89	76
3NE9440-6	89	76
3NE6444	99	86

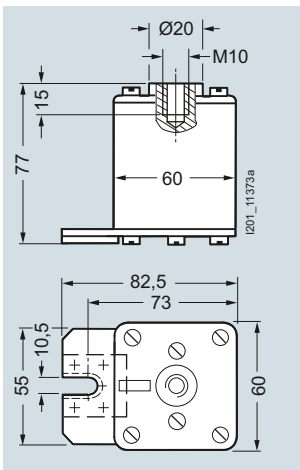

3NE3...-5

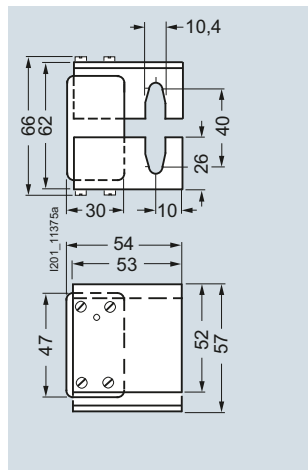

3NE41...-5

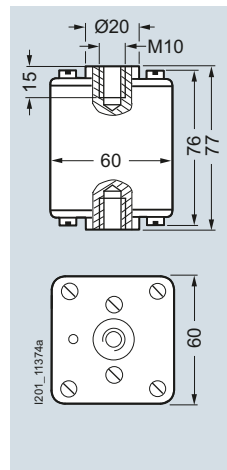

3NE43...-6B, 3NE4337-6

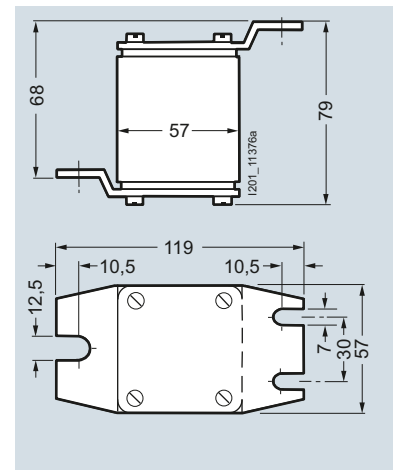

3NC73...-2

Fuse Systems

SITOR Semiconductor Fuses

LV HRC design

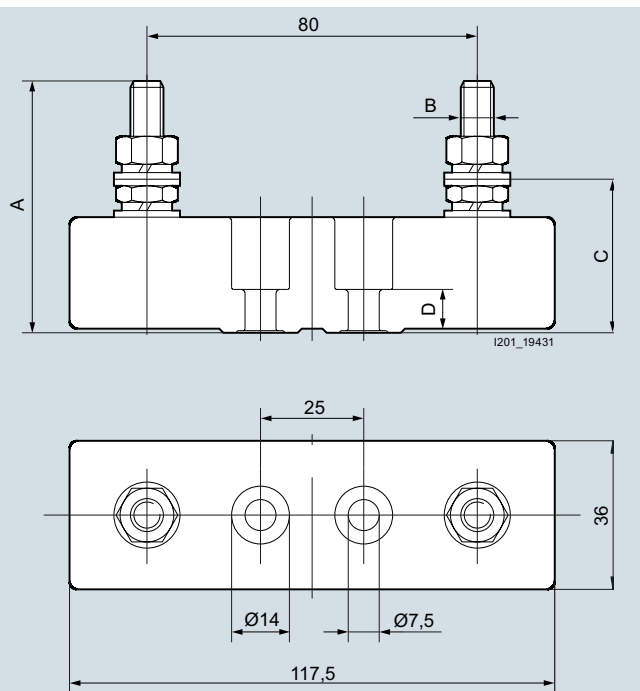

Type	Dimensions			
	A	B	C	D
3NH5023	59	M8	35,5	11
3NH5323	64	M10	38	11

3NH5023, 3NH5323

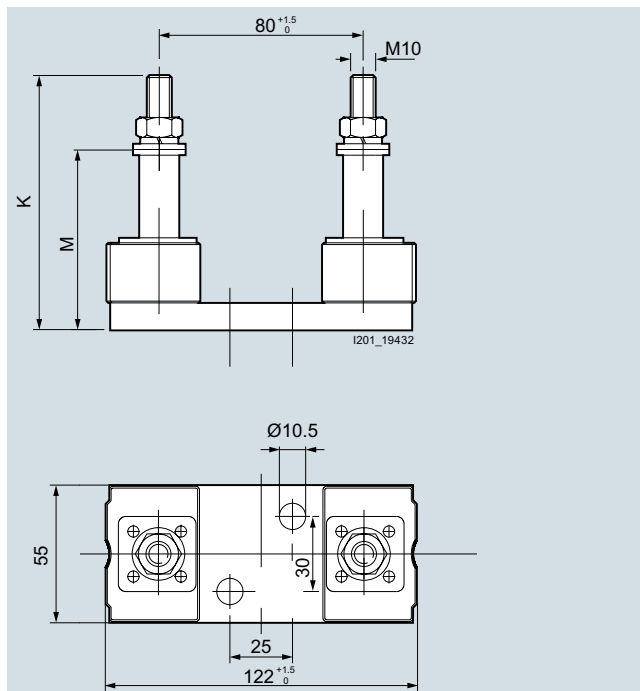

3NH5423

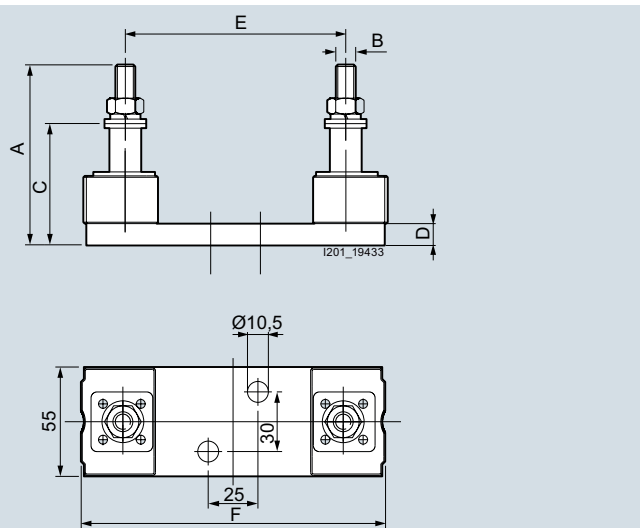

Type	Dimensions					
	A	B	C	D	E	F
3NH5463	94	M10	65	11	110	153
3NH5473	101	M10	72	11	170	211

3NH5463, 3NH5473

Characteristic curves

3NC24.. series

Size: 3
 Operational class: gR or aR
 Rated voltage: 500 V AC
 Rated current: 150 ... 400 A

Time/current characteristics diagram

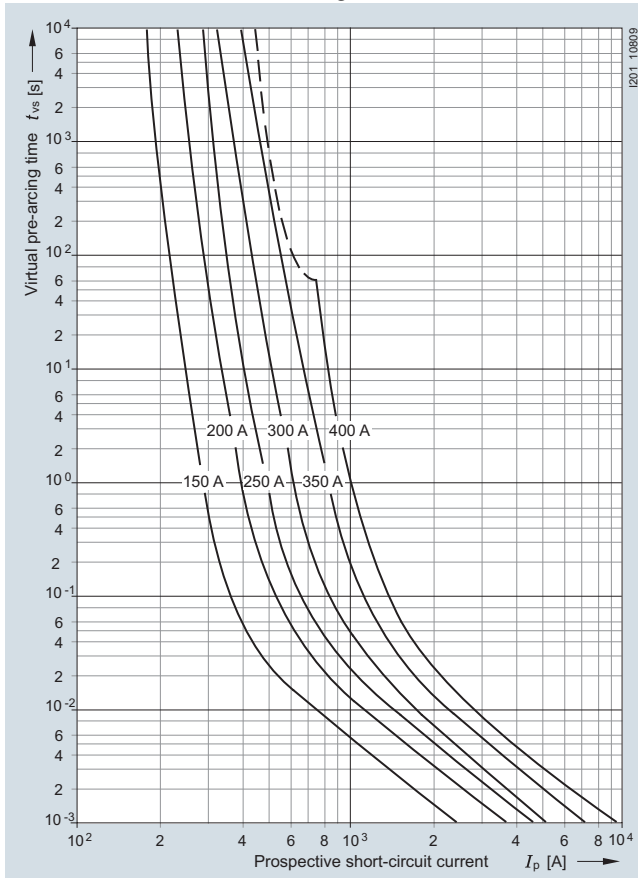

Let-through characteristics (current limitation at 50 Hz)

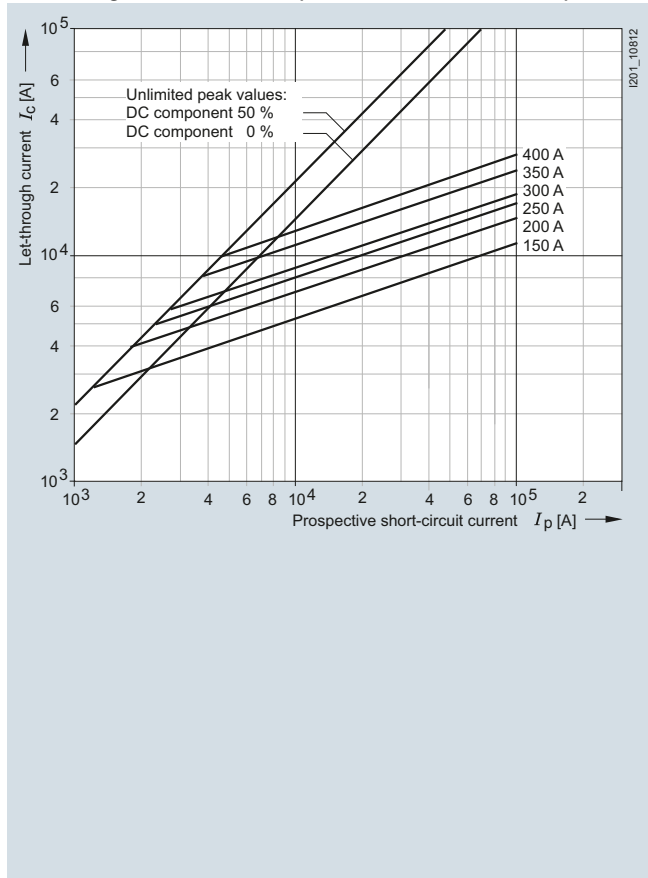

Correction factor k_A for breaking I^2t value

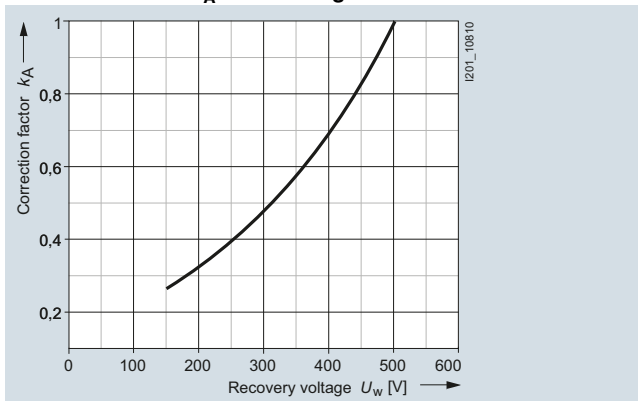

Peak arc voltage

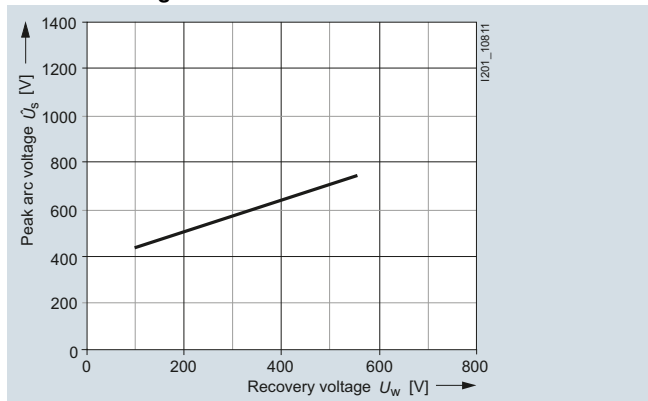

Fuse Systems

SITOR Semiconductor Fuses

LV HRC design

3NB33 series..

Size: 2 x 3, 3 x 3
 Operational class: gR
 Rated voltage: 690 V AC
 Rated current: 1000 ... 1900 A

Time/current characteristics diagram

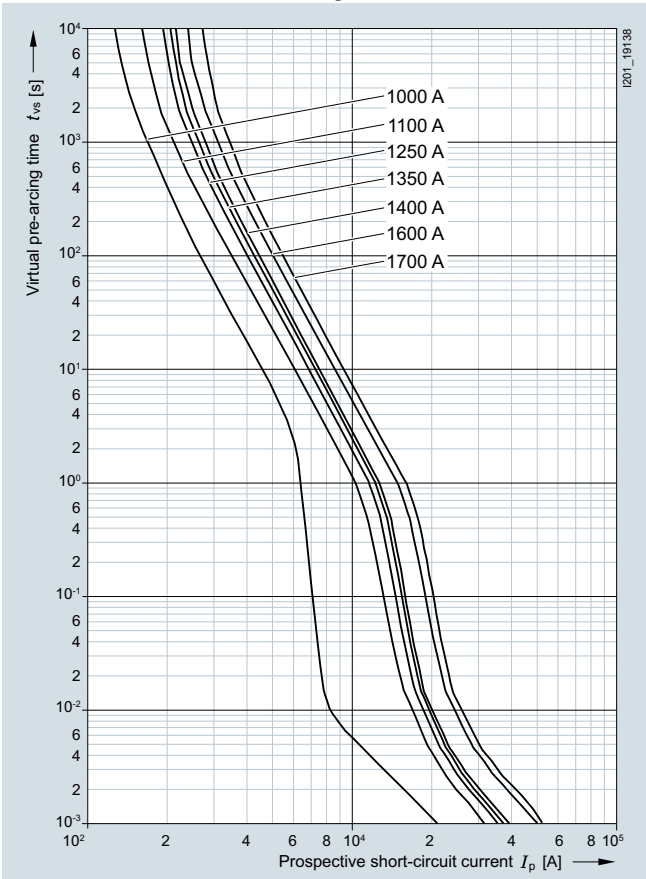

3NB33.-1KK26

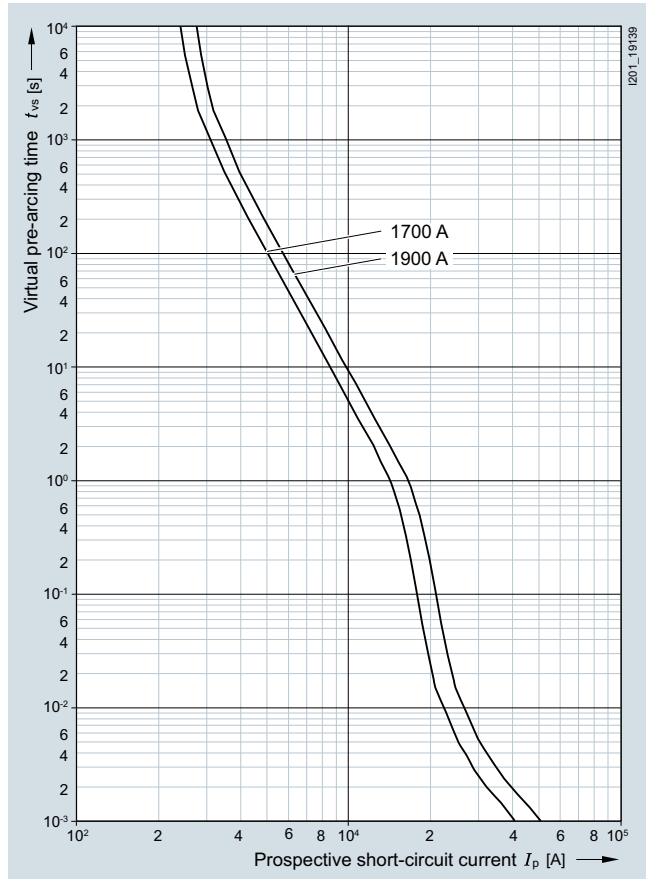

3NB33.-1KK27

Let-through characteristics (current limitation at 50 Hz)

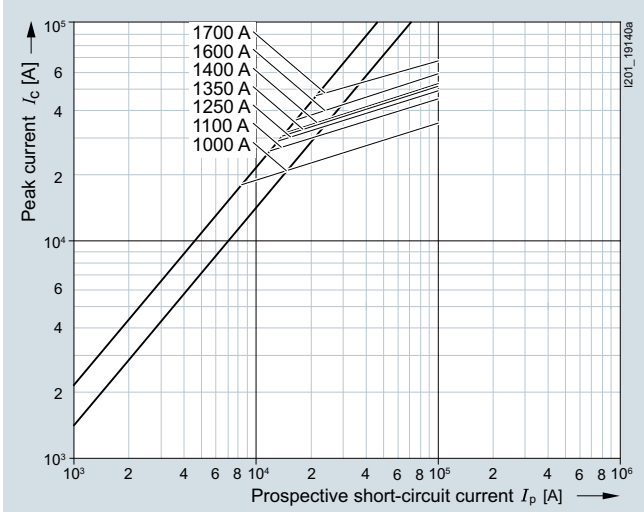

3NB33..-1KK26

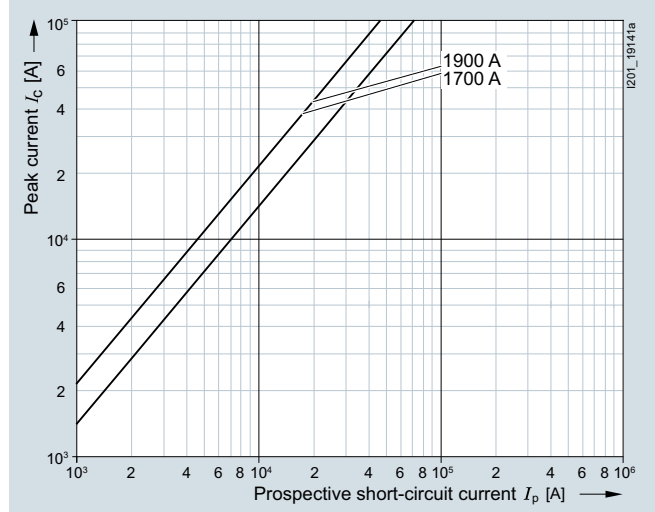

3NB33..-1KK27

Correction factor k_A for breaking I^2t value

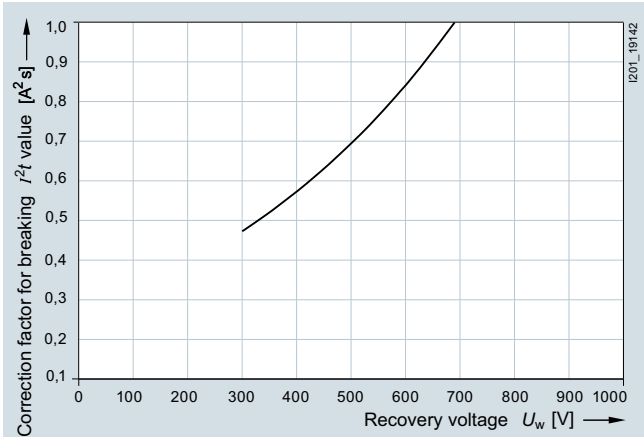

3NB33..-1KK.

Peak arc voltage

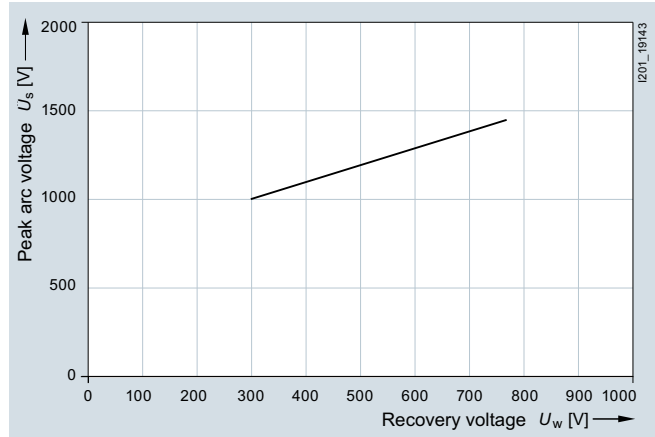

3NB33..-1KK.

Fuse Systems

SITOR Semiconductor Fuses

LV HRC design

3NC32 series

Size: 3
 Operational class: aR
 Rated voltage: 690 V AC (630 ... 1250 A),
 500 V AC (1400 ... 1600 A)
 Rated current: 630 ... 1600 A

Time/current characteristics diagram

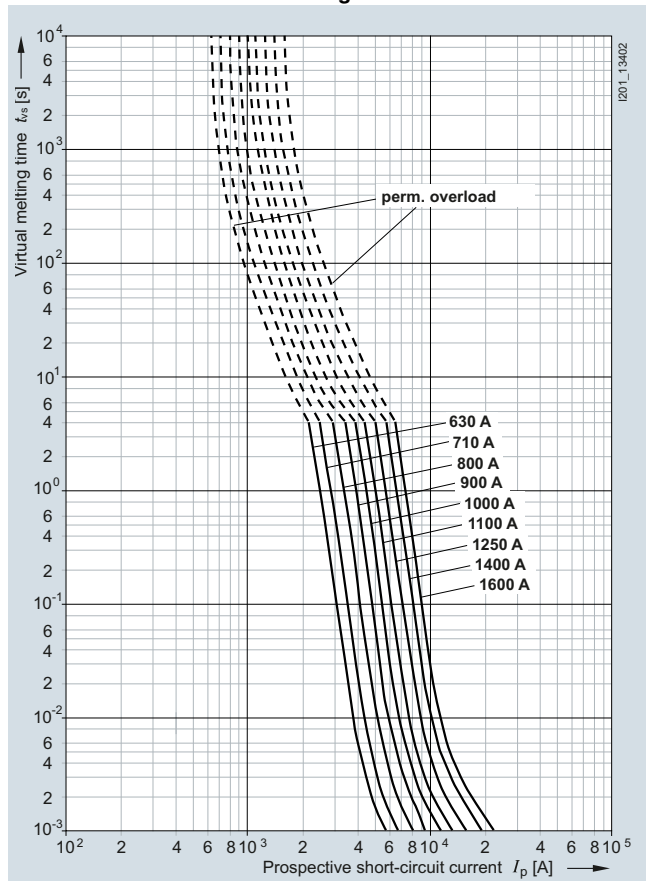

Let-through characteristic curves

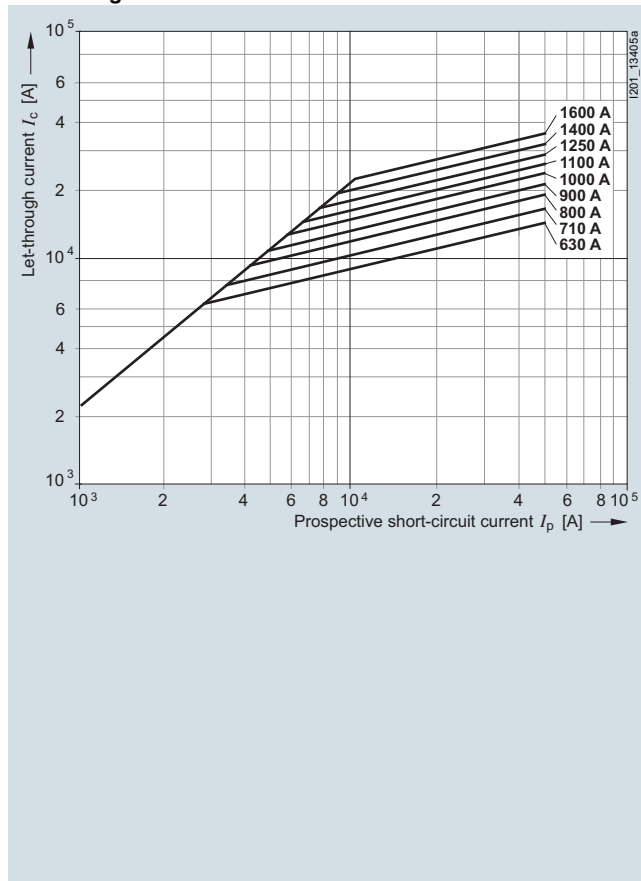

Correction factor k_A for breaking I^2t value

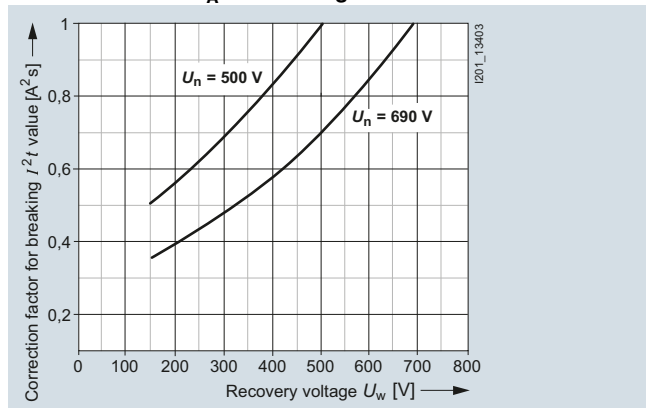

Peak arc voltage

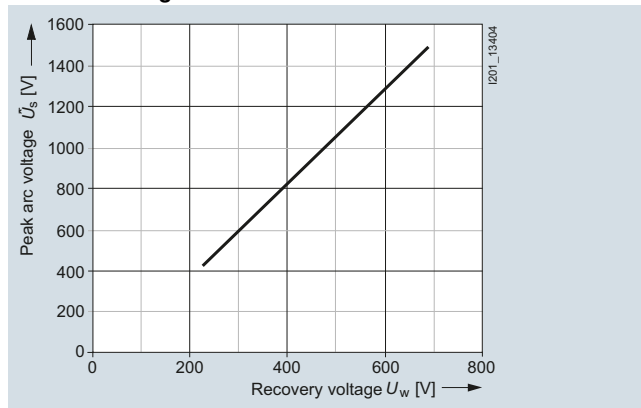

3NC33 series

Size: 3
Operational class: aR
Rated voltage: 1000 V AC (630 ... 1000 A),
800 V AC (1100 ... 1250 A)
Rated current: 630 ... 1250 A

Time/current characteristics diagram

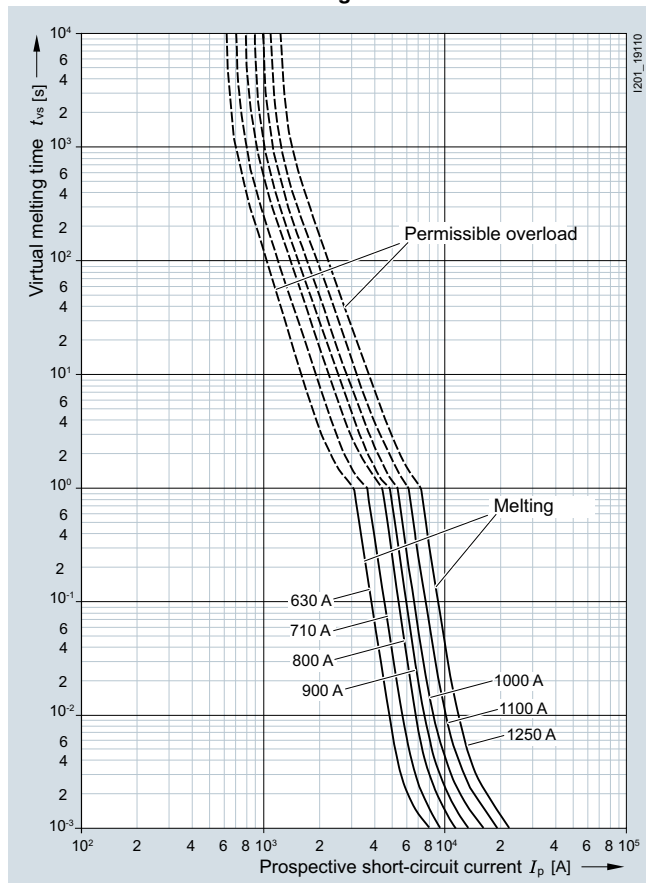

Let-through characteristic curves

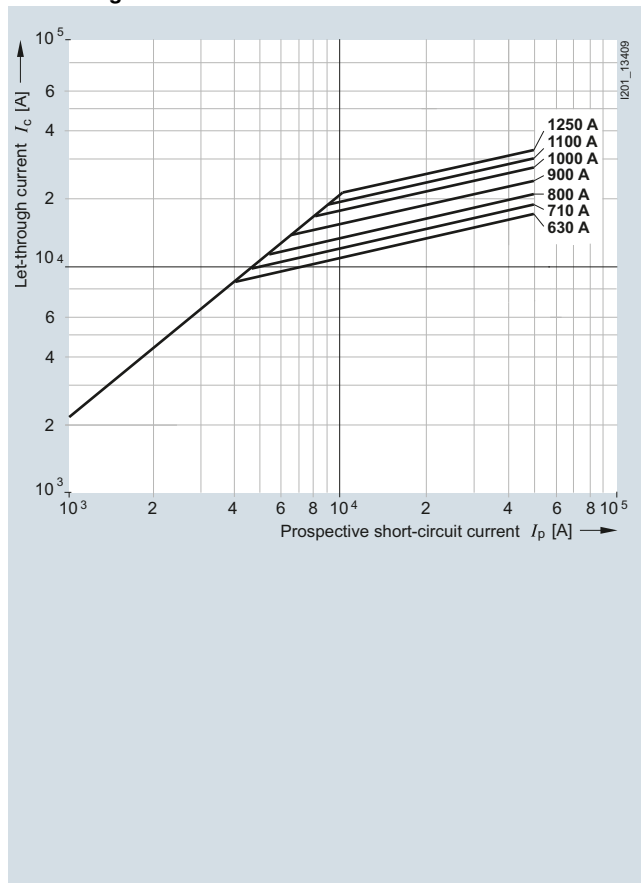

Correction factor k_A for breaking I^2t value

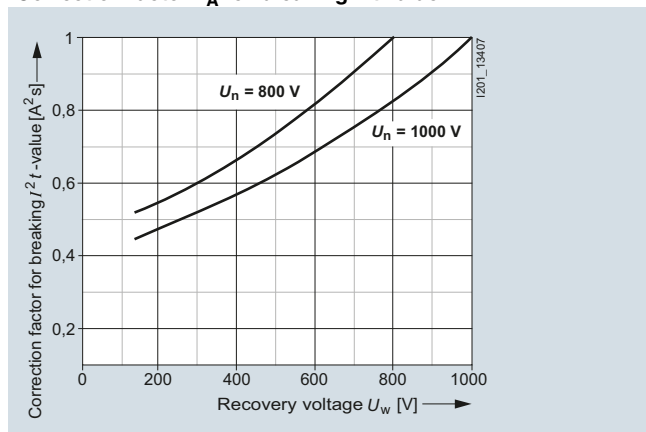

Peak arc voltage

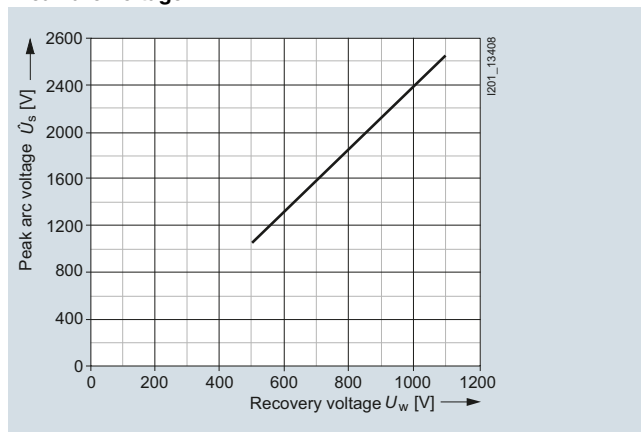

Fuse Systems

SITOR Semiconductor Fuses

LV HRC design

3NC34 series

Size: 3
 Operational class: aR
 Rated voltage: 1250 V AC (315 ... 630 A),
 1100 V AC (800 A)
 Rated current: 315 ... 800 A

Time/current characteristics diagram

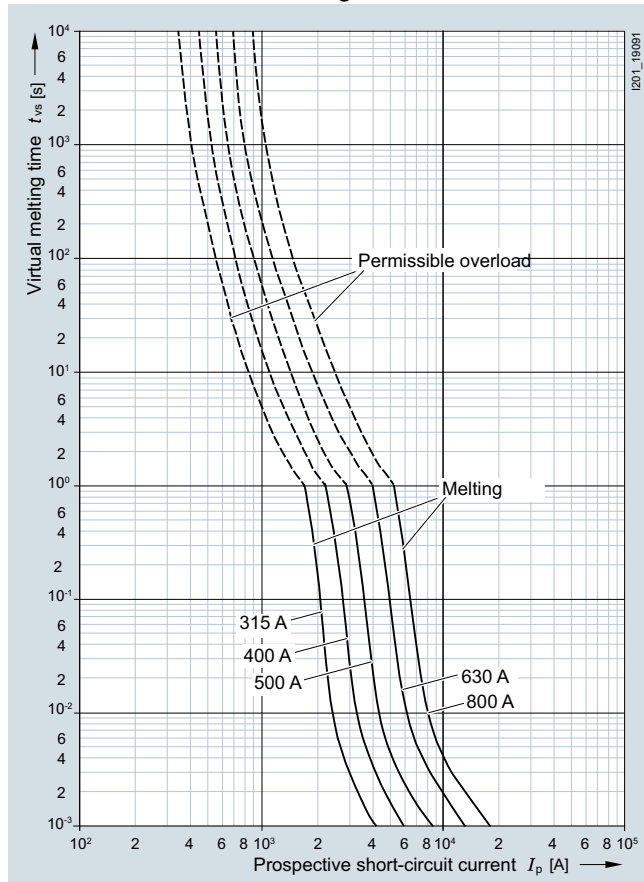

Let-through characteristic curves

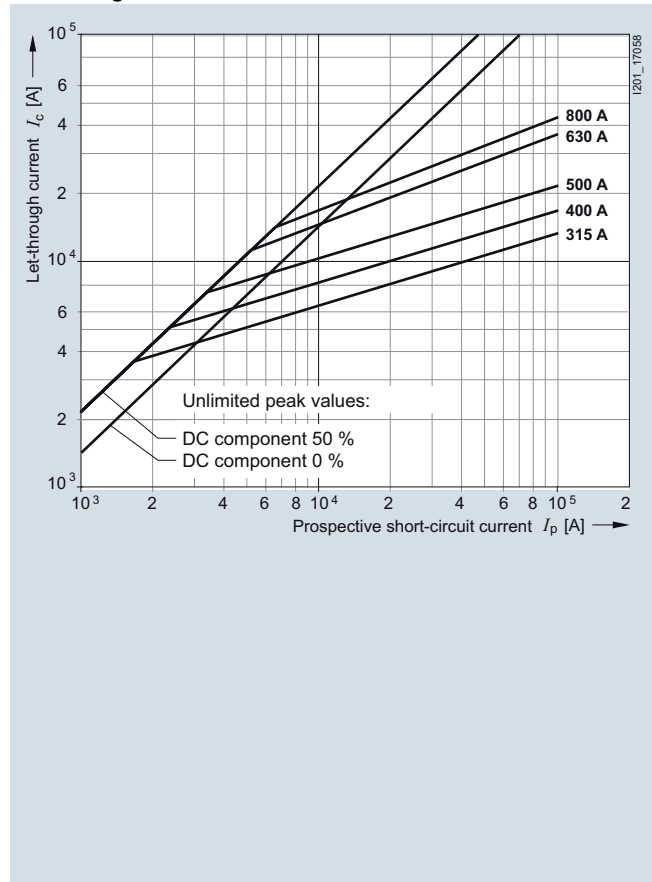

Correction factor k_A for breaking I^2t value

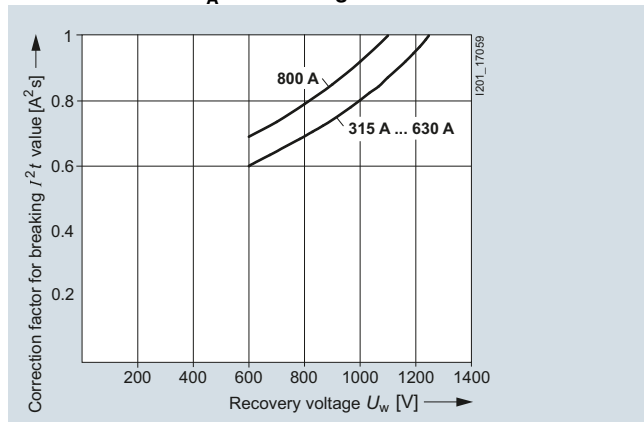

Peak arc voltage

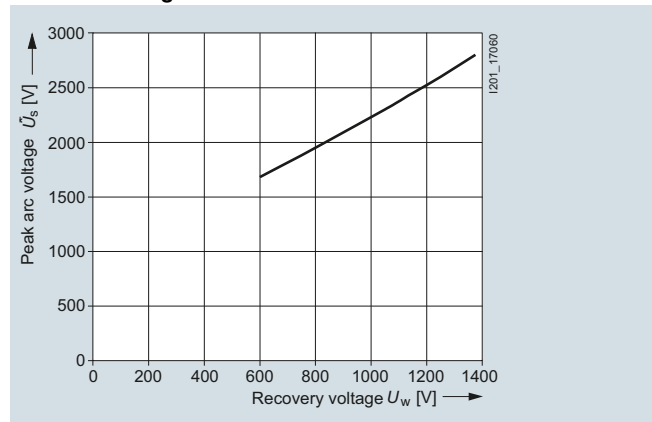

3NC5531, 3NC58.. series

Operational class: aR
 Rated voltage: 800 V AC (350 A, 630 A),
 1000 V AC (600 A, 800 A)
 Rated current: 350 ... 800 A

Time/current characteristics diagram

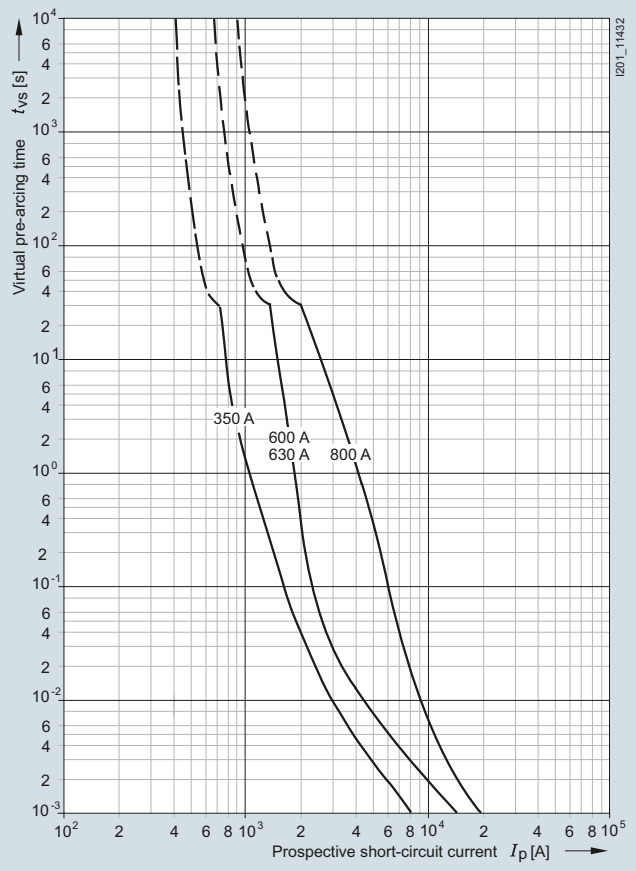

Let-through characteristics (current limitation at 50 Hz)

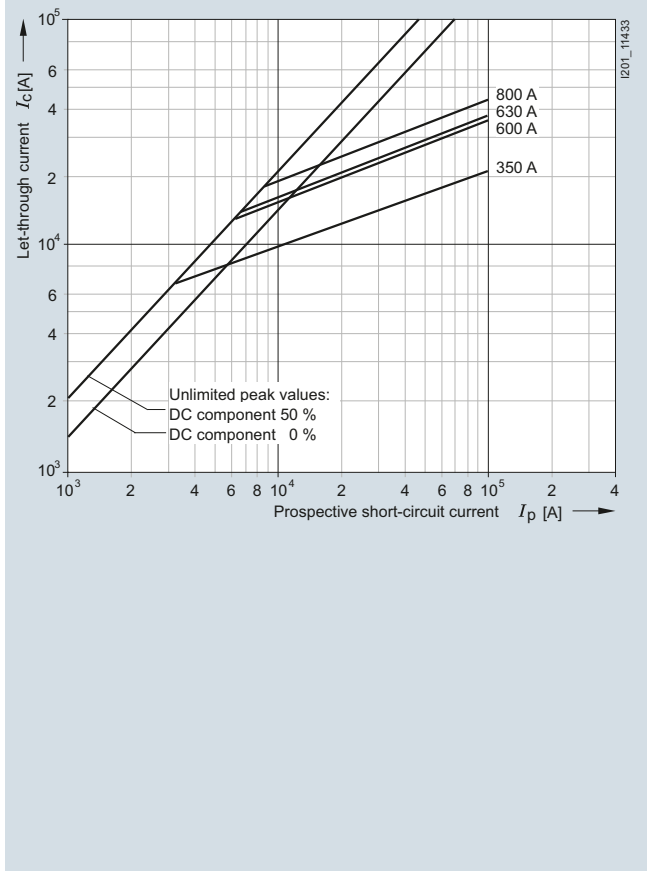

Correction factor k_A for breaking I^2t value

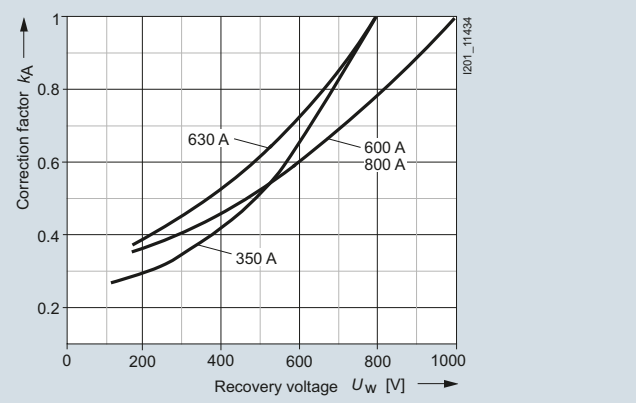

Peak arc voltage

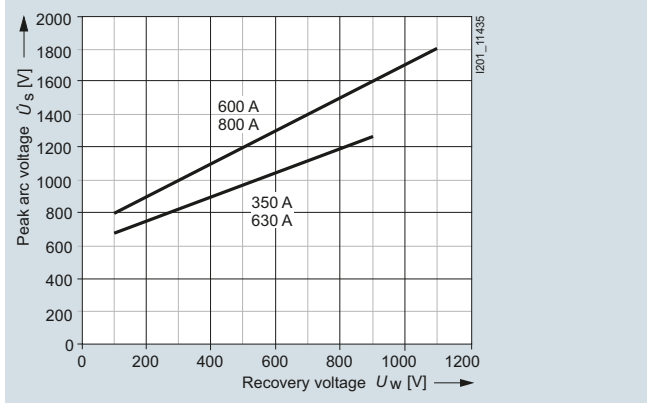

Fuse Systems

SITOR Semiconductor Fuses

LV HRC design

3NC73..-2 series

Operational class: aR
 Rated voltage: 680 V AC
 Rated current: 250 A, 350 A

Time/current characteristics diagram

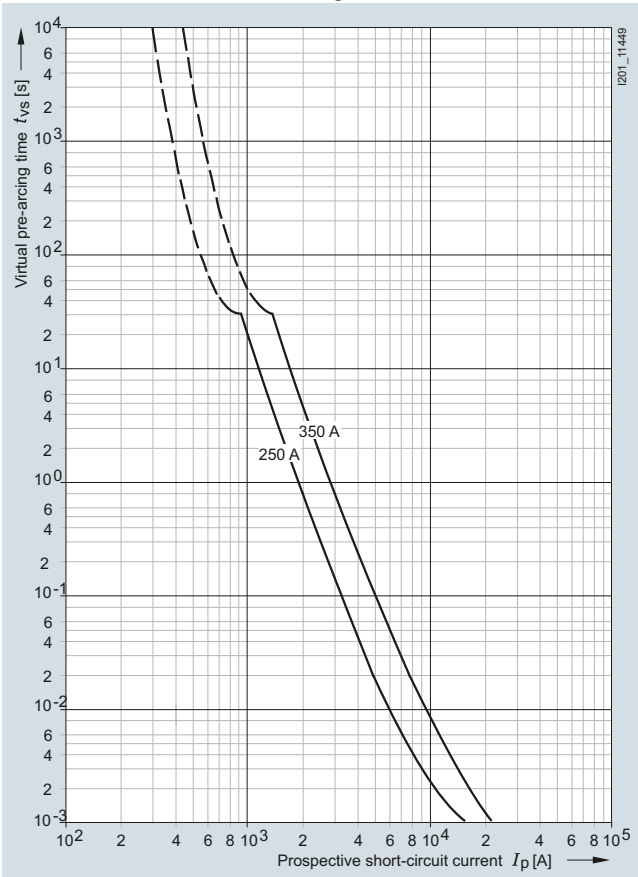

Let-through characteristics (current limitation at 50 Hz)

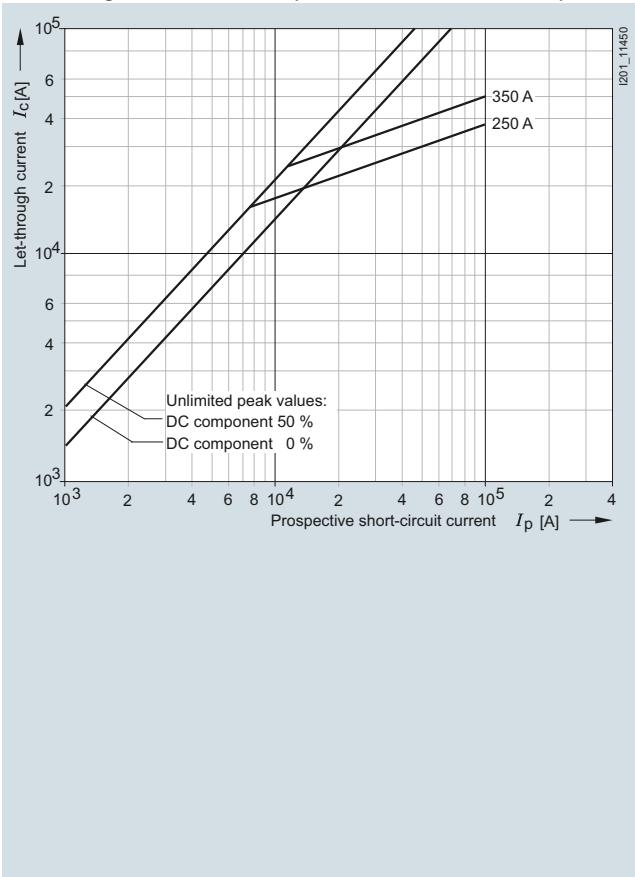

Correction factor k_A for breaking I^2t value

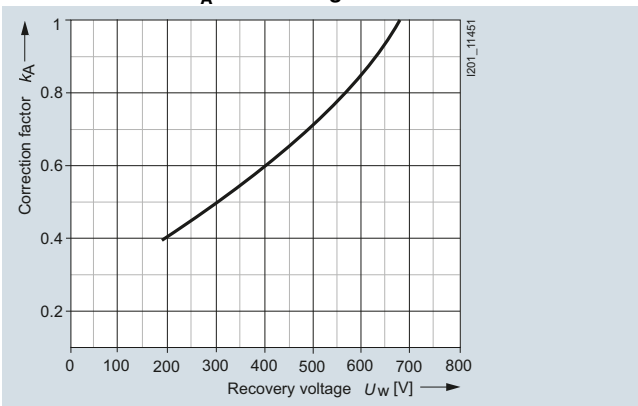

Peak arc voltage

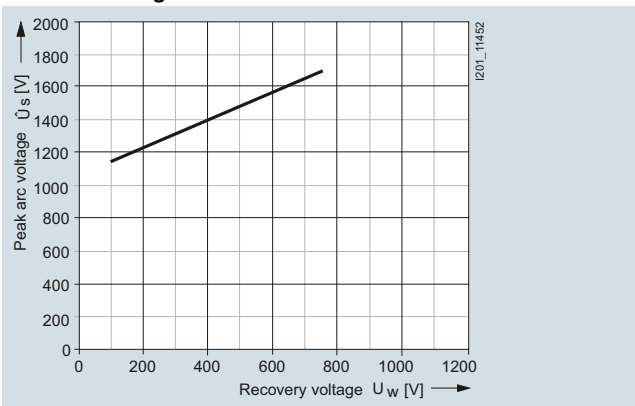

3NC84.. series

Size: 3
Operational class: gR or aR
Rated voltage: 660 V AC
Rated current: 150 ... 1000 A

Time/current characteristics diagram

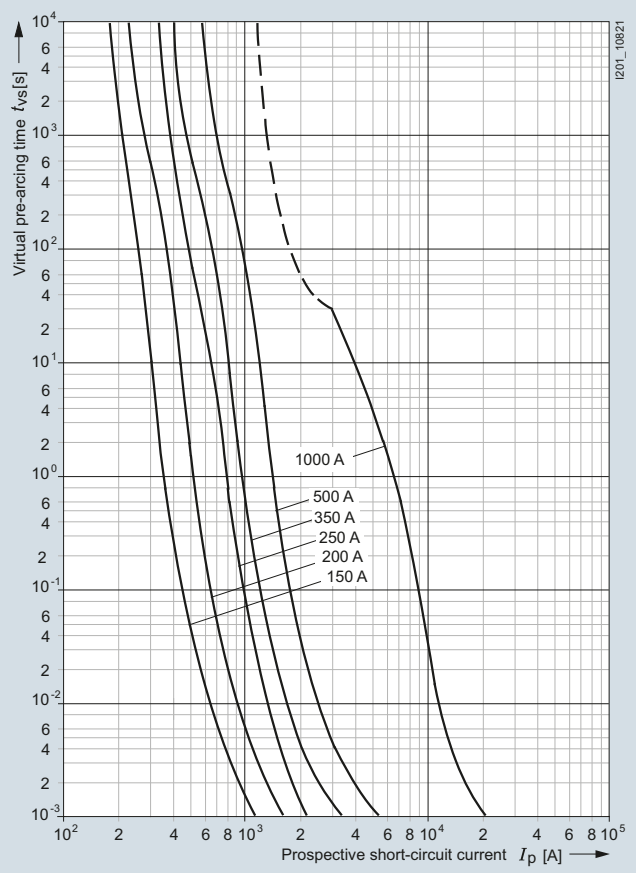

Let-through characteristics (current limitation at 50 Hz)

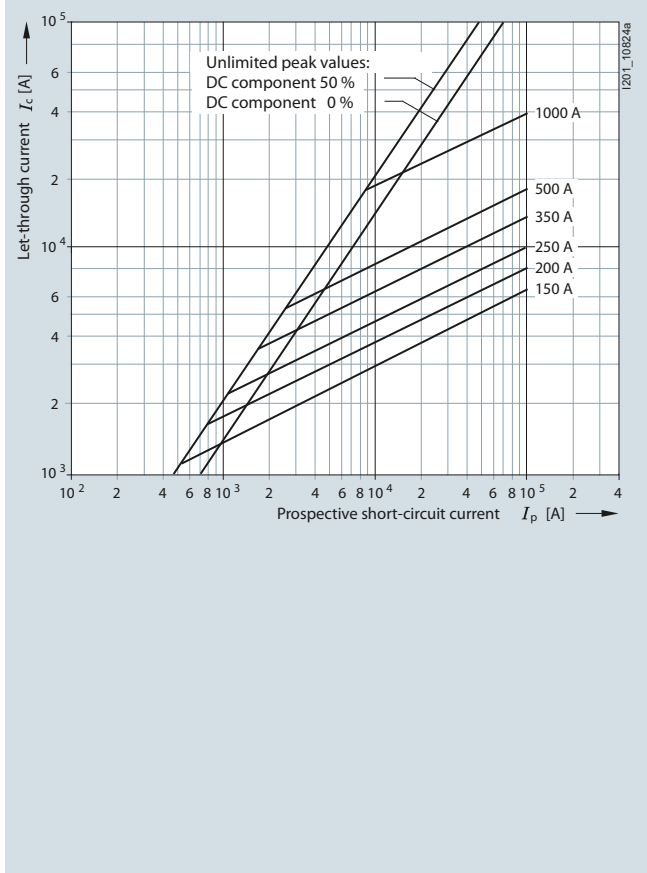

Correction factor k_A for breaking I^2t value

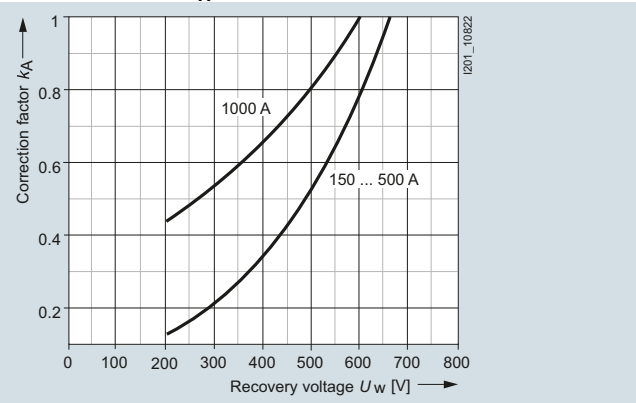

Peak arc voltage

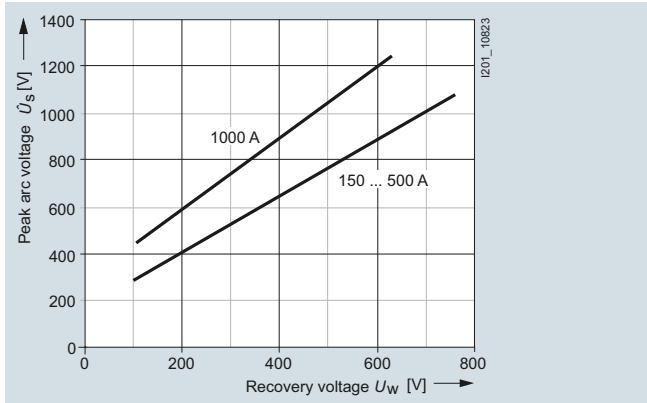

Fuse Systems

SITOR Semiconductor Fuses

LV HRC design

3NE102.-0, 3NE12.-0 series

Size: 00, 1
 Operational class: gS
 Rated voltage: 690 V AC
 Rated current: 100 ... 315 A

Time/current characteristics diagram

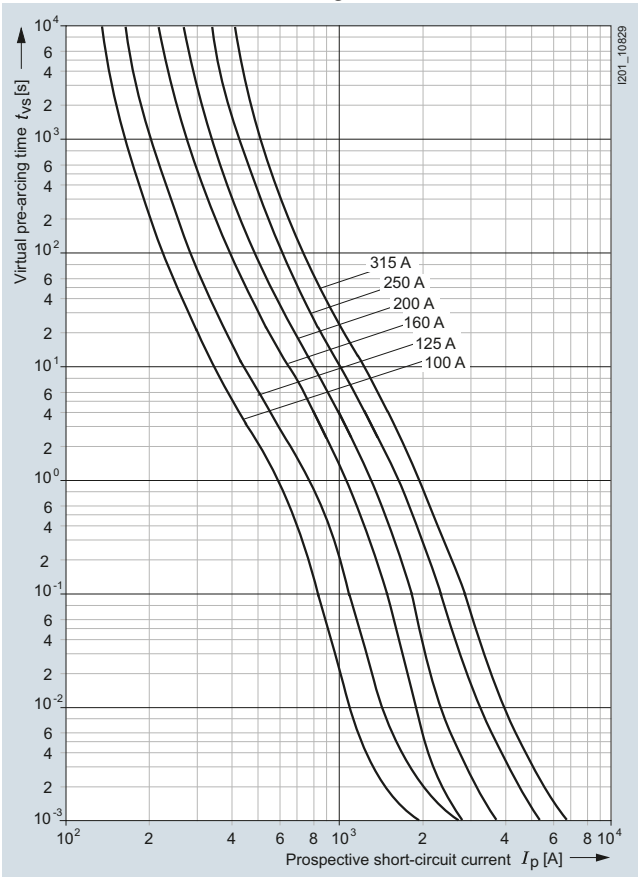

Let-through characteristics (current limitation at 50 Hz)

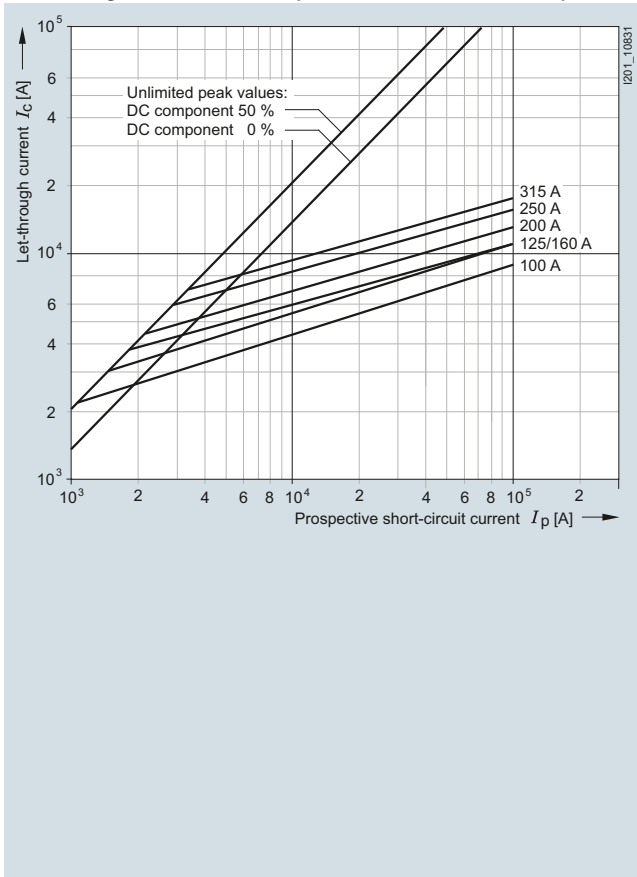

Correction factor k_A for breaking I^2t value

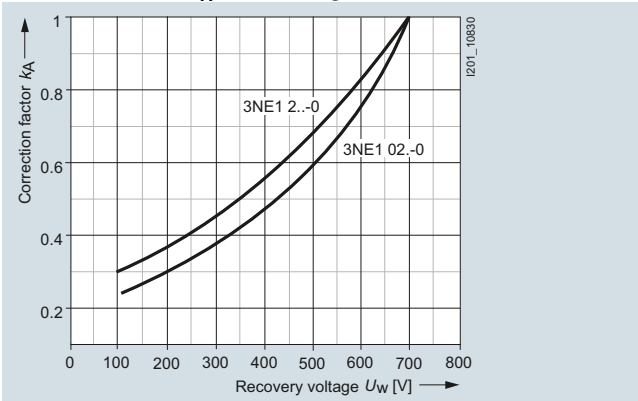

Peak arc voltage

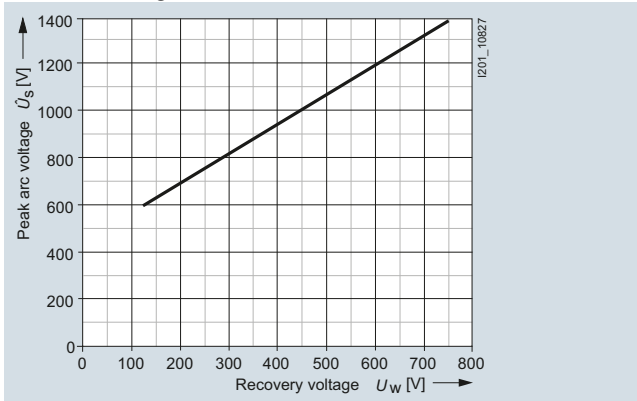

3NE102.-2, 3NE12.-2, 3NE12.-3, 3NE13.-2, 3NE13.-3 series

Size: 00, 1, 2
Operational class: gR
Rated voltage: 690 V AC
Rated current: 80 ... 500 A

Time/current characteristics diagram

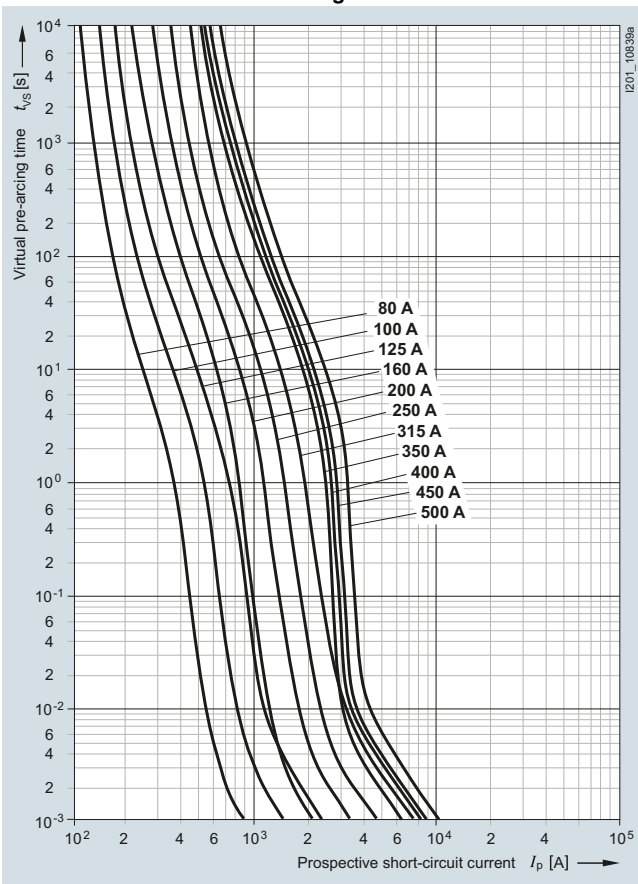

Let-through characteristics (current limitation at 50 Hz)

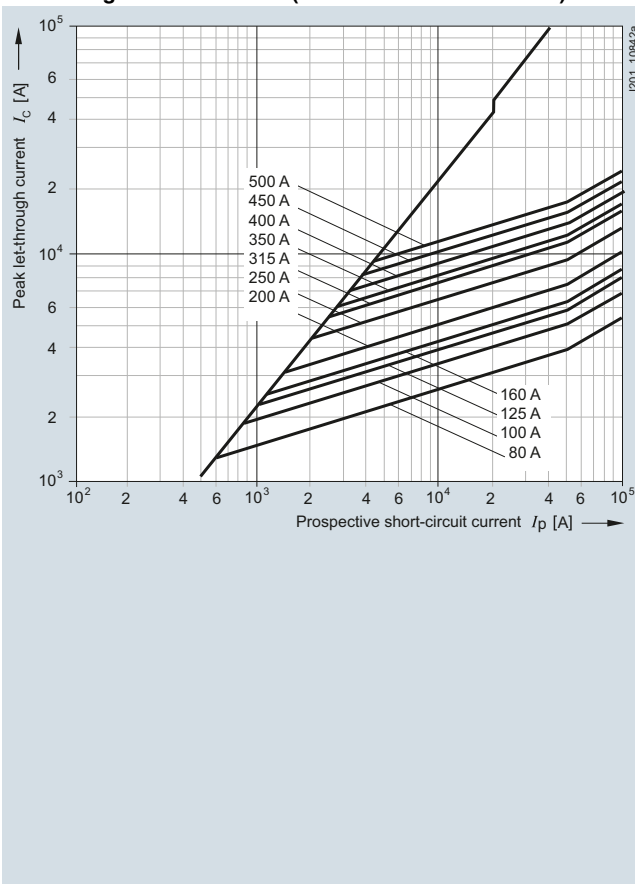

Correction factor k_A for breaking I^2t value

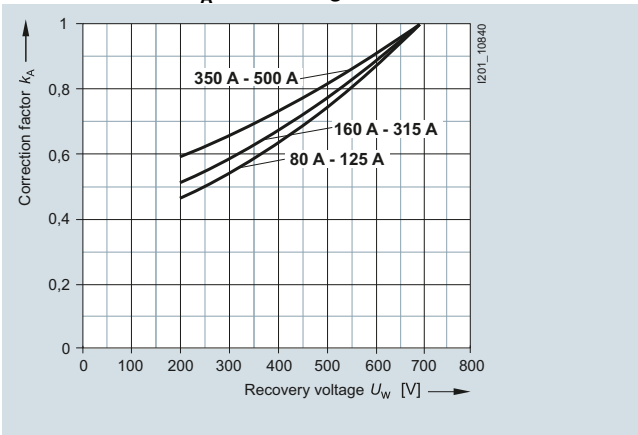

Peak arc voltage

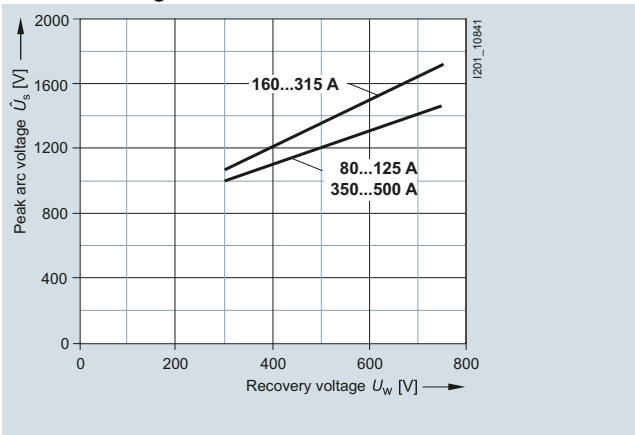

Fuse Systems

SITOR Semiconductor Fuses

LV HRC design

3NE133.-0, 3NE143.-0 series

Size: 2, 3
 Operational class: gS
 Rated voltage: 690 V AC
 Rated current: 350 ... 800 A

Time/current characteristics diagram

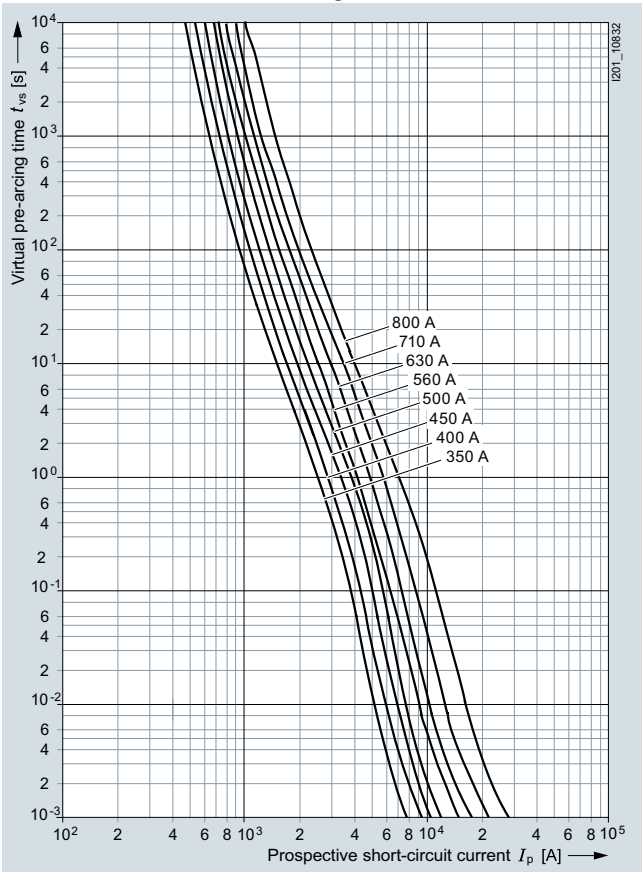

Let-through characteristics (current limitation at 50 Hz)

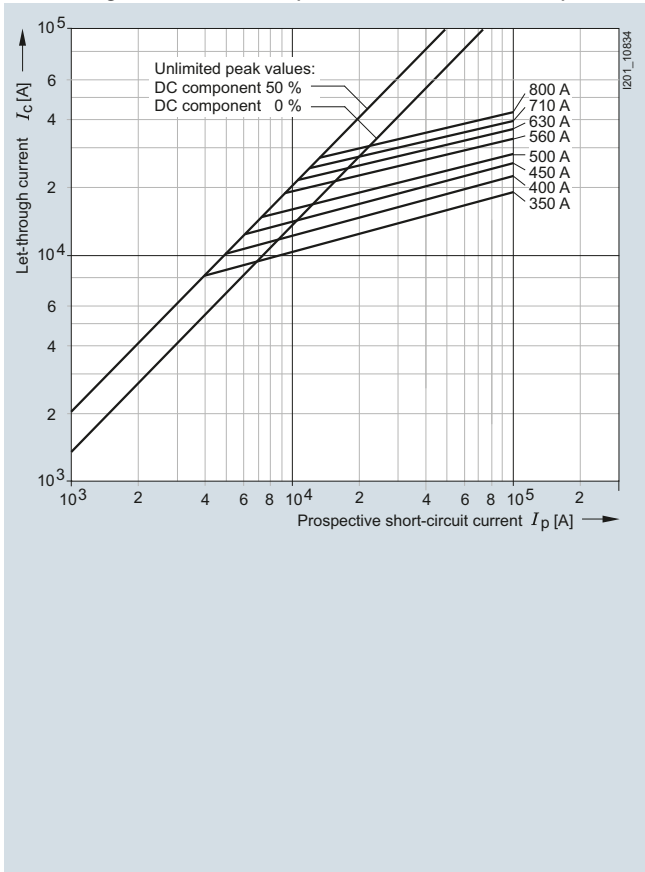

Correction factor k_A for breaking I^2t value

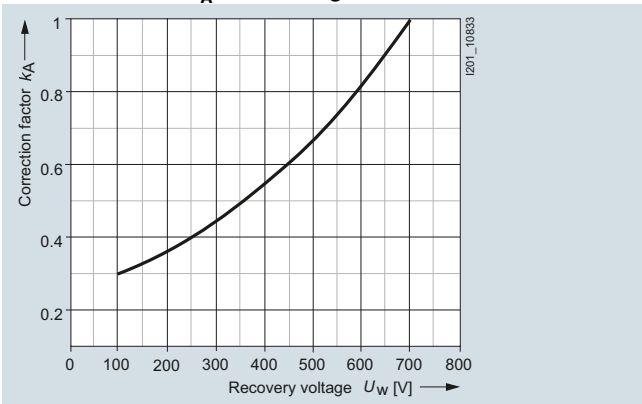

Peak arc voltage

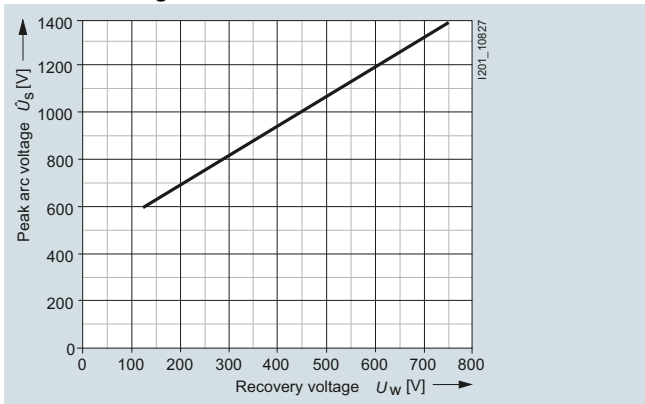

3NE14..-2, 3NE14..-3 series

Size: 3
Operational class: gR
Rated voltage: 690 V AC
Rated current: 560 ... 850 A

Time/current characteristics diagram

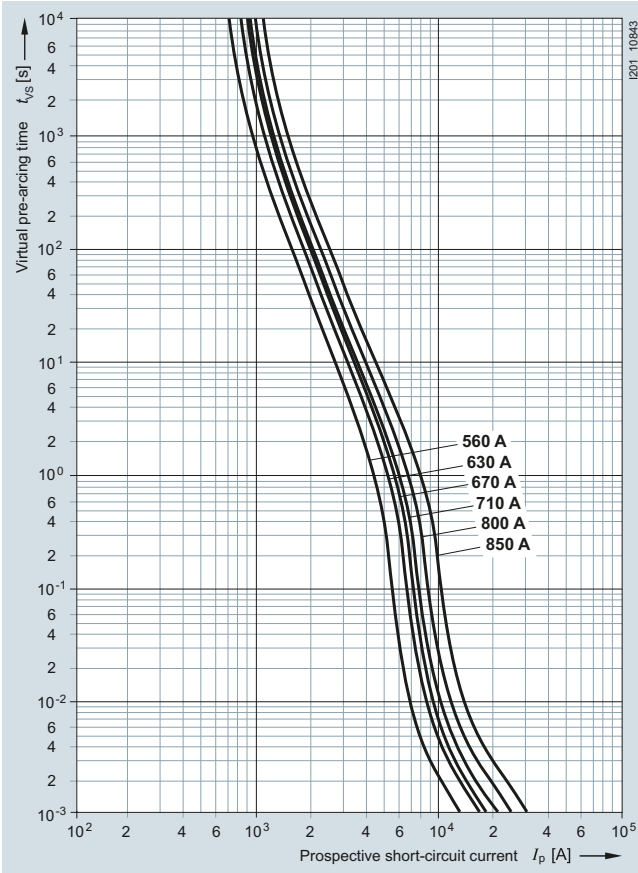

Let-through characteristics (current limitation at 50 Hz)

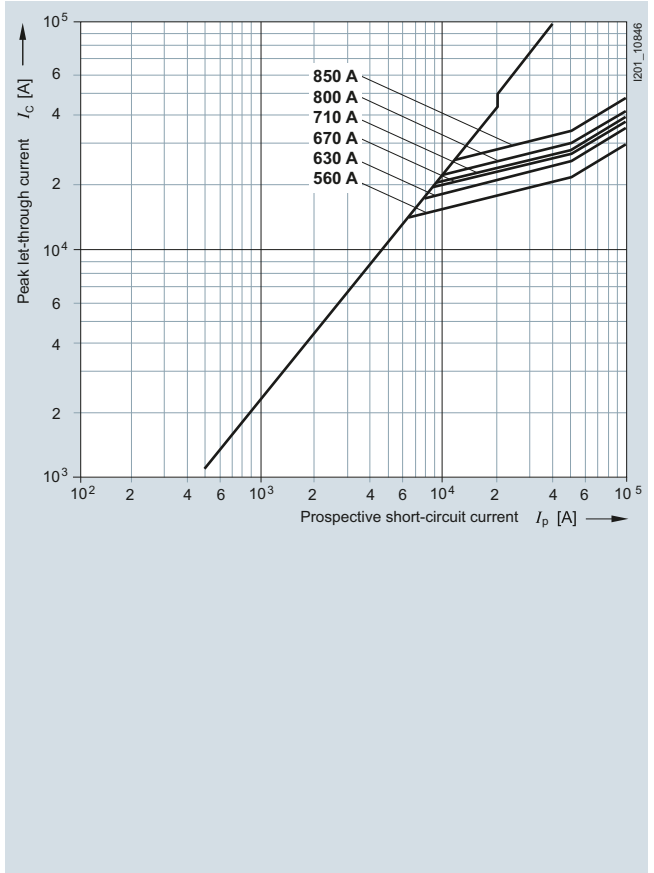

Correction factor k_A for breaking I^2t value

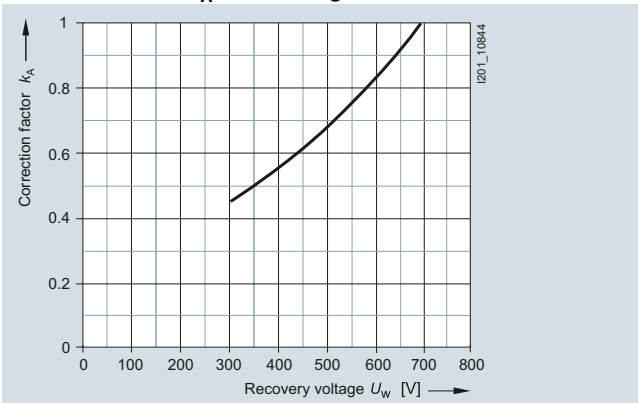

Peak arc voltage

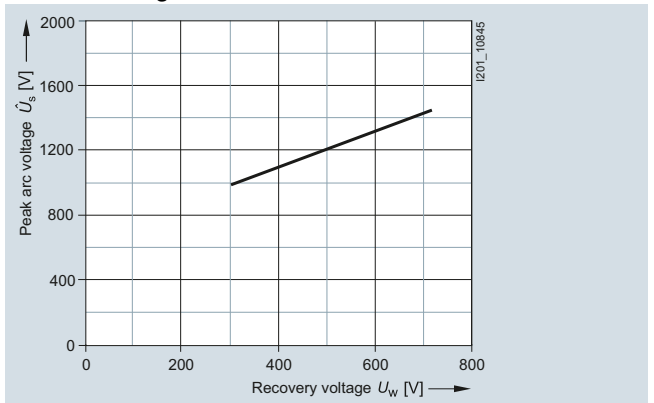

Fuse Systems

SITOR Semiconductor Fuses

LV HRC design

3NE1437-1, 3NE1438-1 series

Size: 3
 Operational class: gR
 Rated voltage: 600 V AC
 Rated current: 710 and 800 A

Time/current characteristics diagram

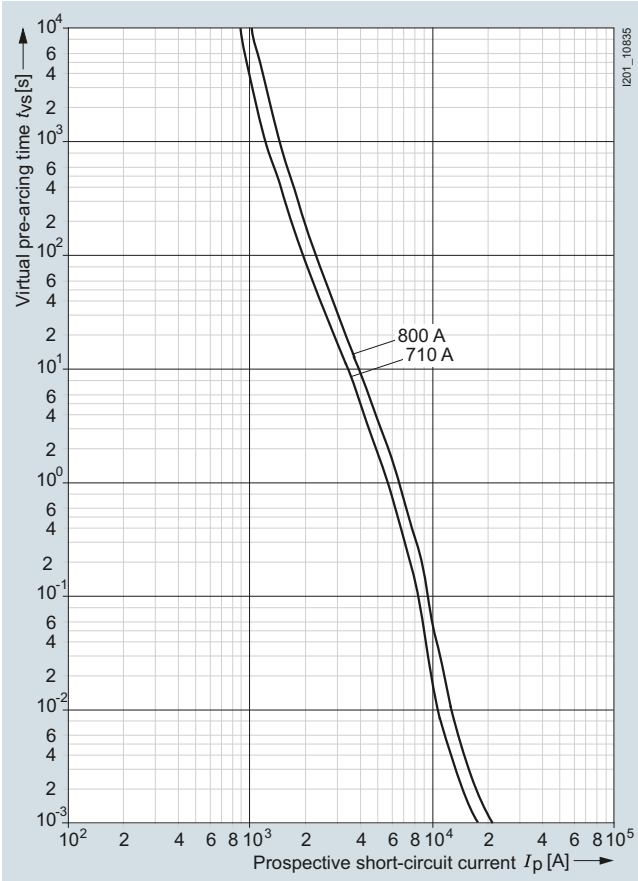

Let-through characteristics (current limitation at 50 Hz)

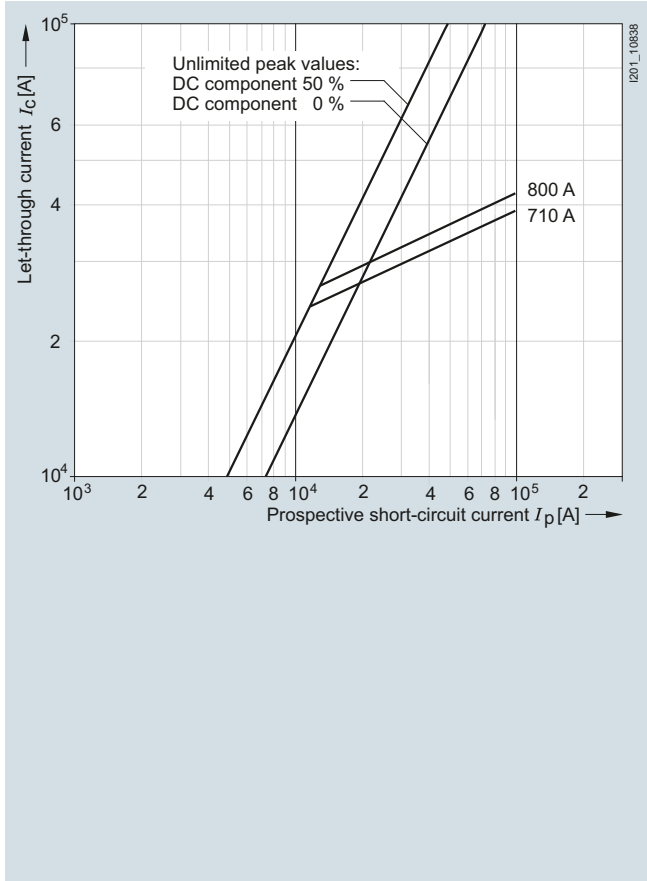

Correction factor k_A for breaking I^2t value

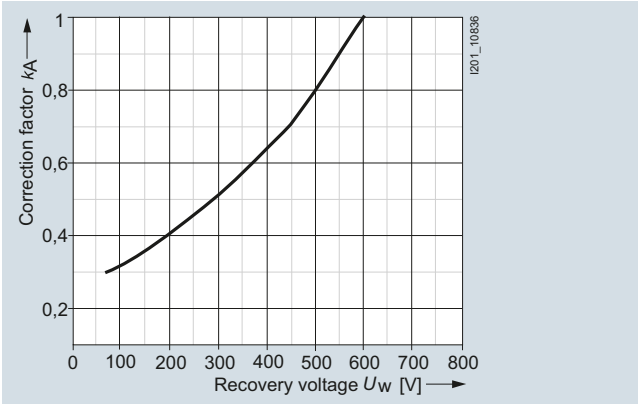

Peak arc voltage

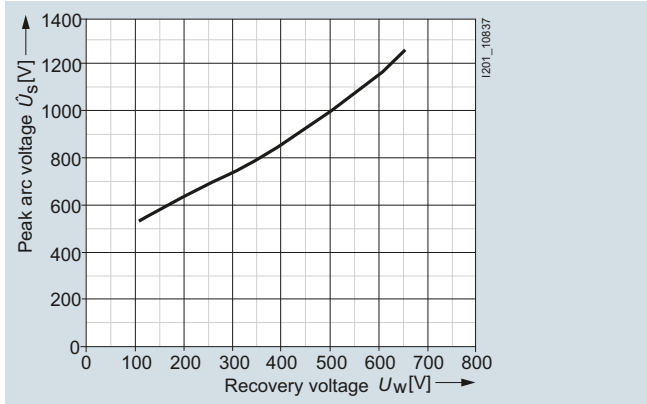

3NE18..-0 series

Size: 000
Operational class: gS
Rated voltage: 690 V AC
Rated current: 16 ... 80 A

Time/current characteristics diagram

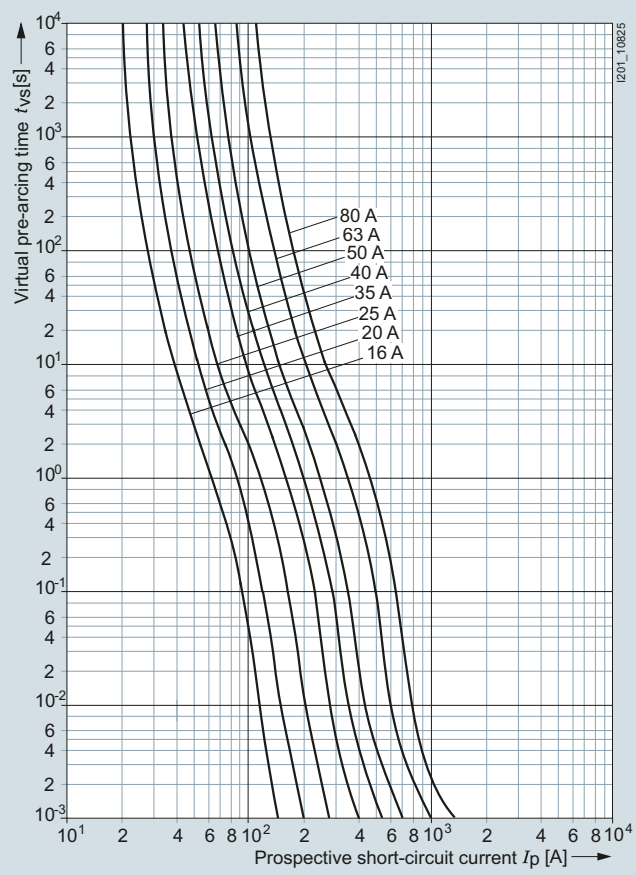

Let-through characteristics (current limitation at 50 Hz)

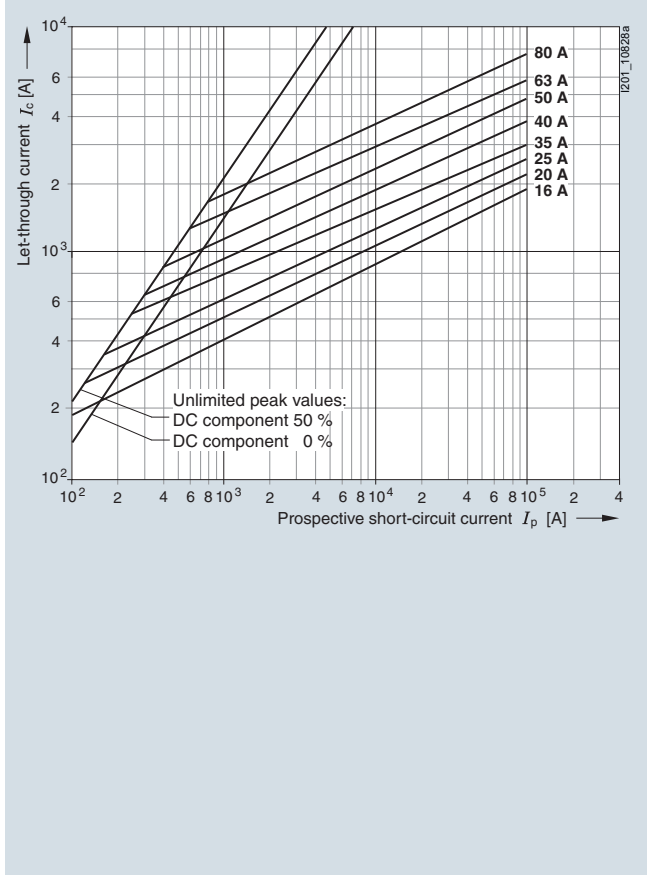

Correction factor k_A for breaking I^2t value

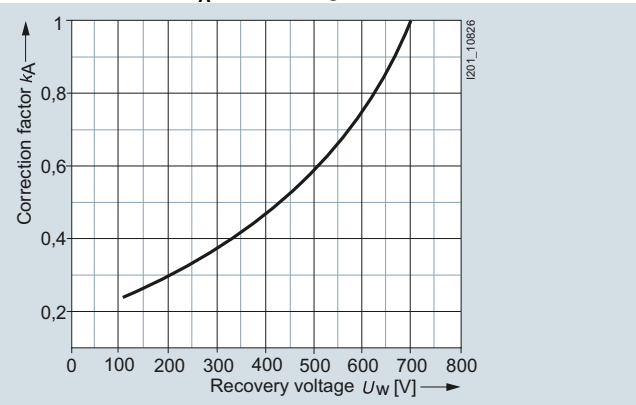

Peak arc voltage

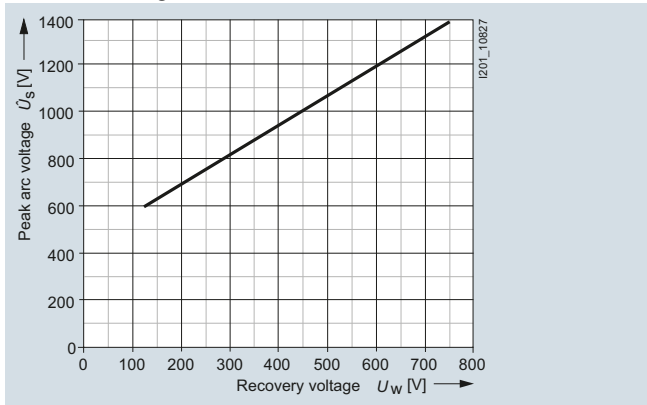

Fuse Systems

SITOR Semiconductor Fuses

LV HRC design

3NE32..-0MK series

Size: 1
 Operational class: gR
 Rated voltage: 1000 V AC/600 V DC
 Rated current: 32 ... 63 A

Time/current characteristics diagram

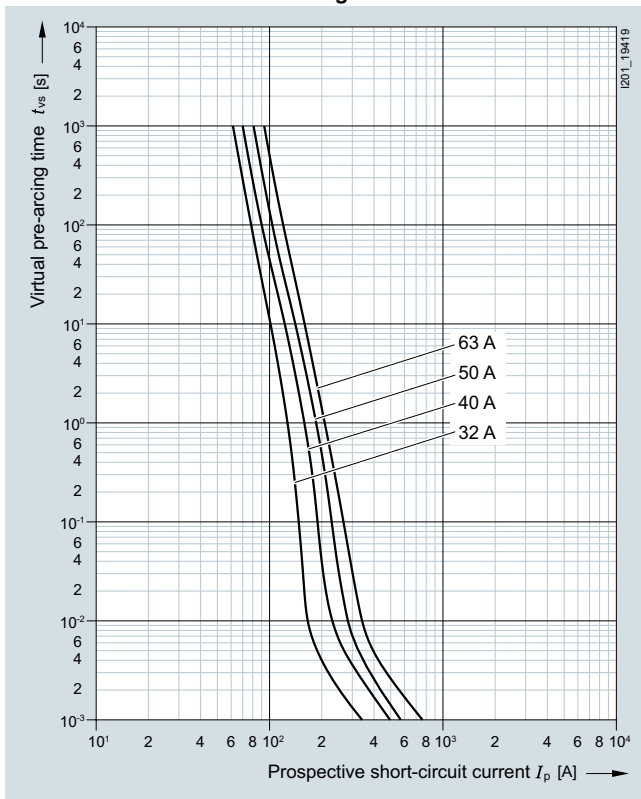

Let-through characteristics (current limitation at 50 Hz)

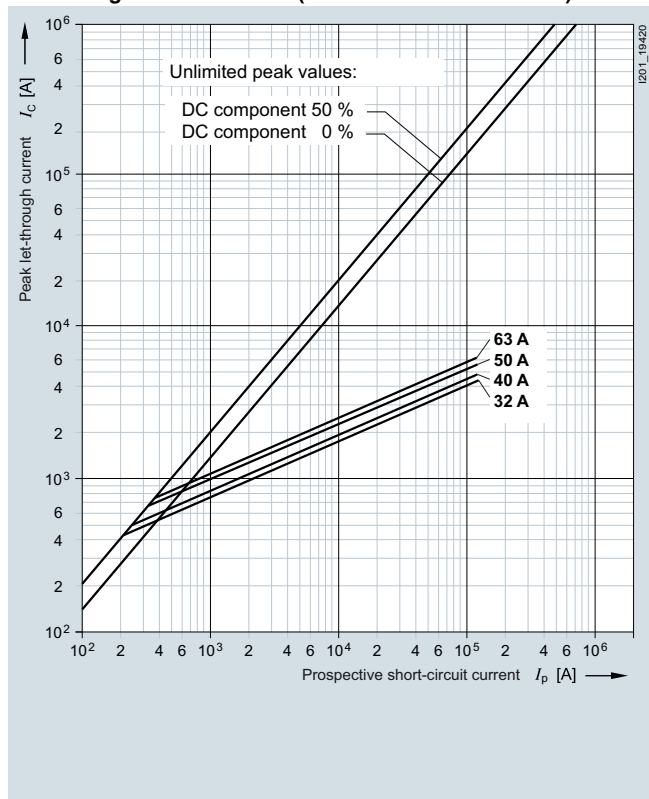

Correction factor k_A for breaking I^2t value

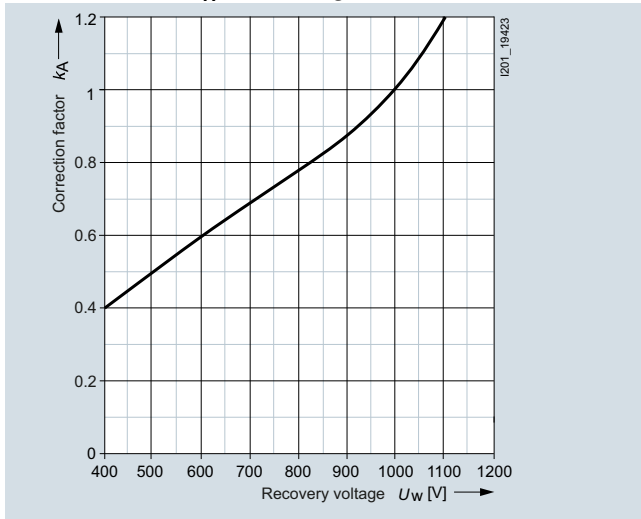

Peak arc voltage

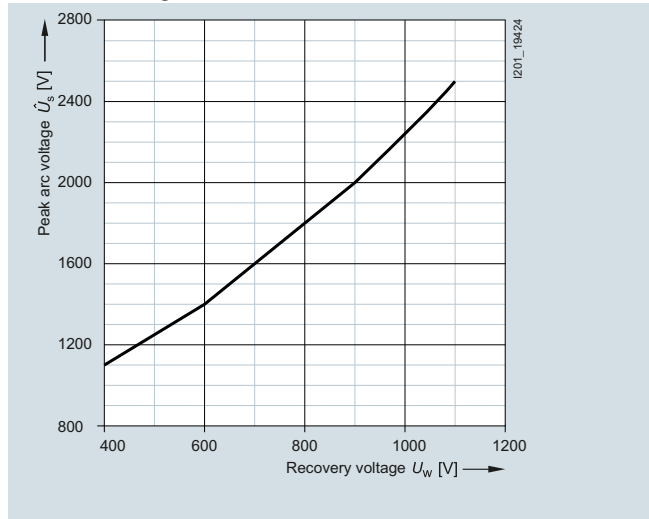

3NE322. series

Size: 1
Operational class: aR
Rated voltage: 1000 V AC
Rated current: 100 ... 250 A

Time/current characteristics diagram

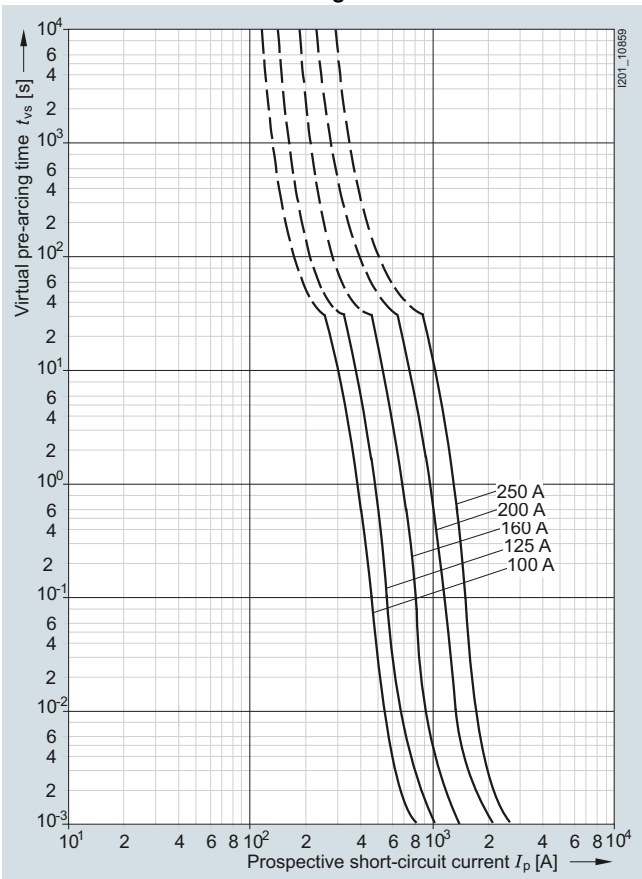

Let-through characteristics (current limitation at 50 Hz)

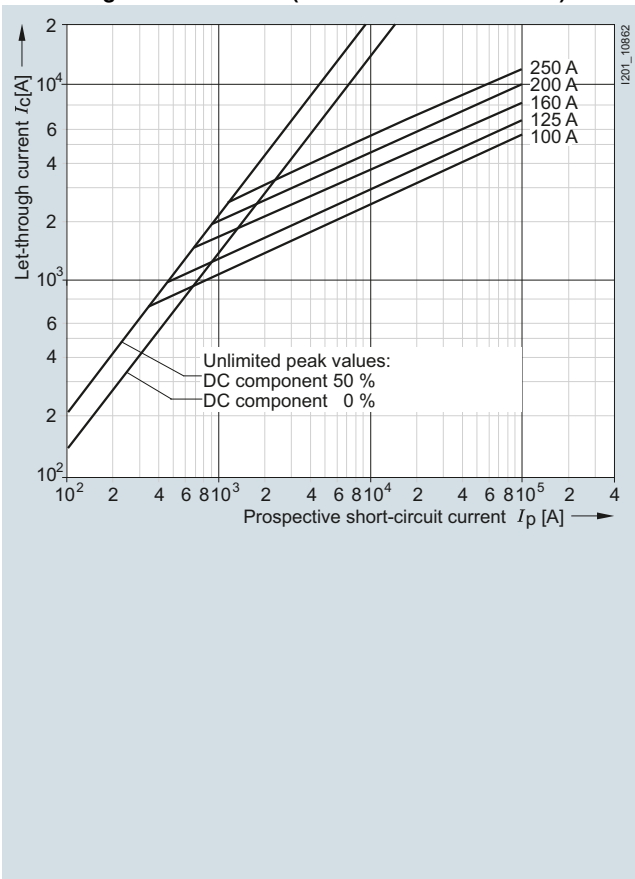

Correction factor k_A for breaking I^2t value

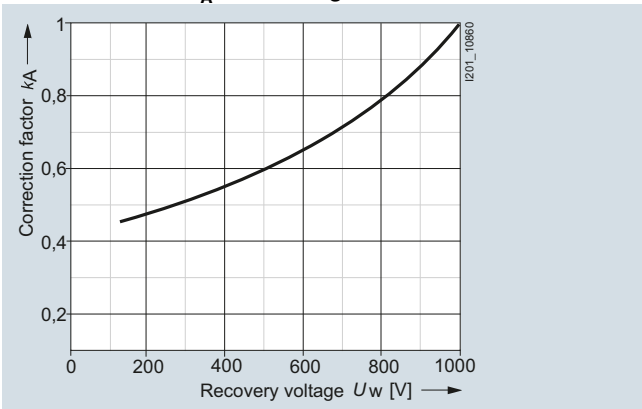

Peak arc voltage

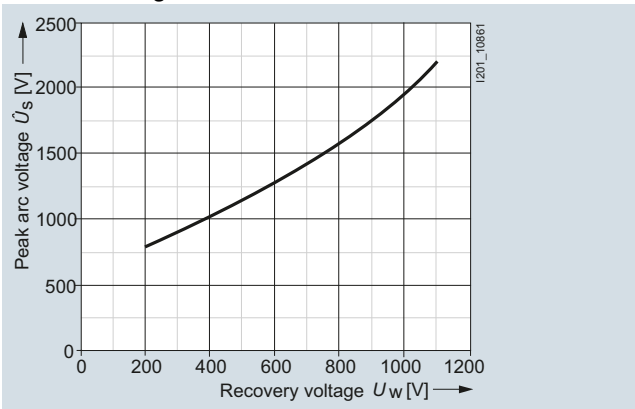

Fuse Systems

SITOR Semiconductor Fuses

LV HRC design

3NE323. series

Size: 1
 Operational class: aR
 Rated voltage: 1000 V AC
 Rated current: 315 ... 450 A

Time/current characteristics diagram

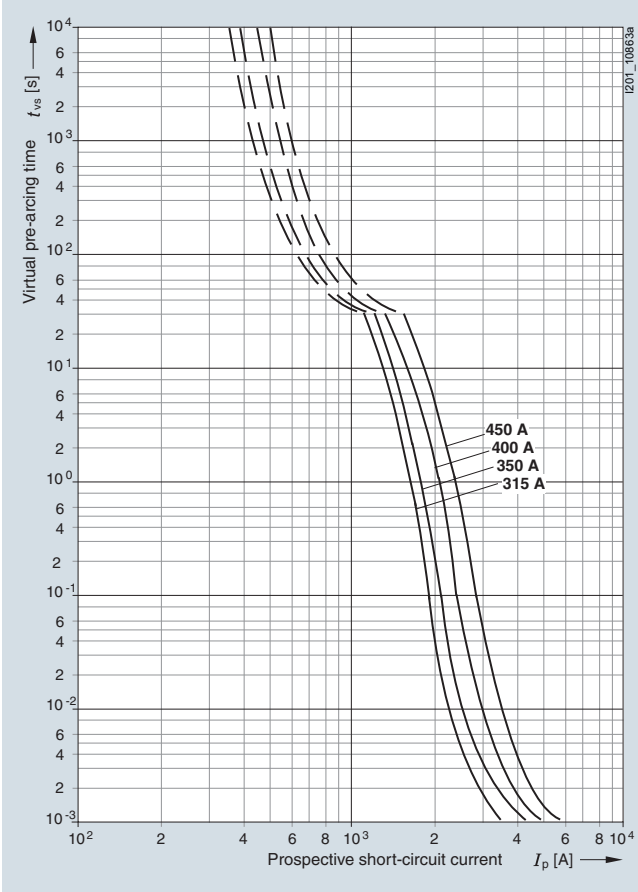

Let-through characteristics (current limitation at 50 Hz)

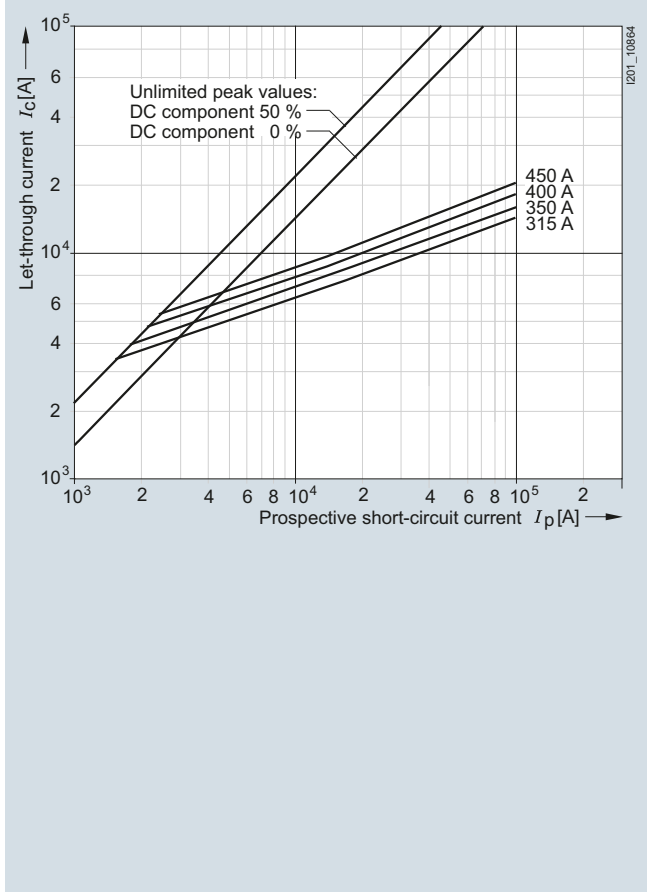

Correction factor k_A for breaking I^2t value

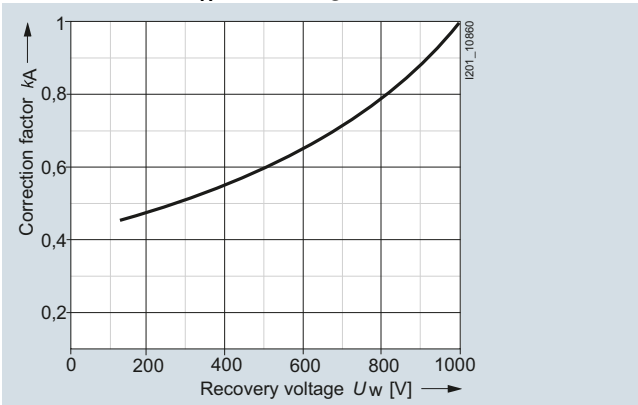

Peak arc voltage

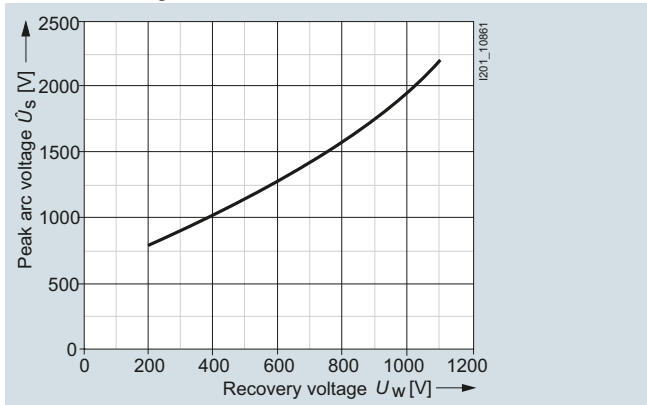

3NE323.-0MK08 series

Size: 1
Operational class: aR
Rated voltage: 1000 V AC/600 V DC
Rated current: 500 ... 630 A

Time/current characteristics diagram

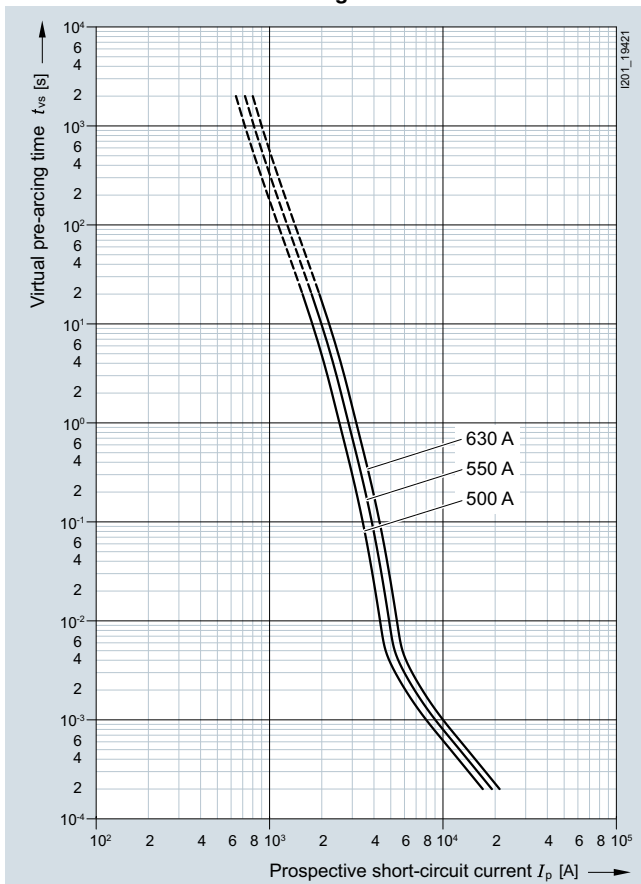

Let-through characteristics (current limitation at 50 Hz)

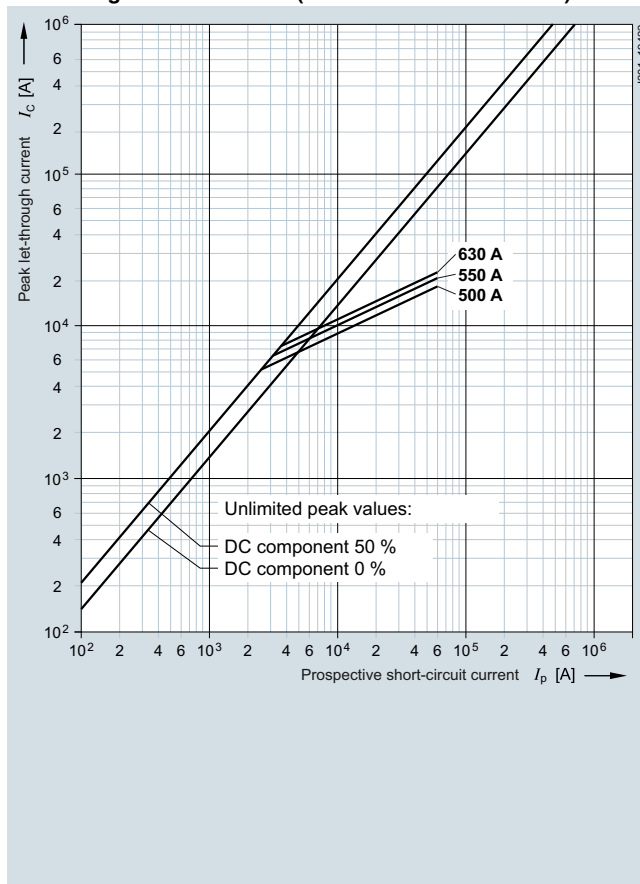

Correction factor k_A for breaking I^2t value

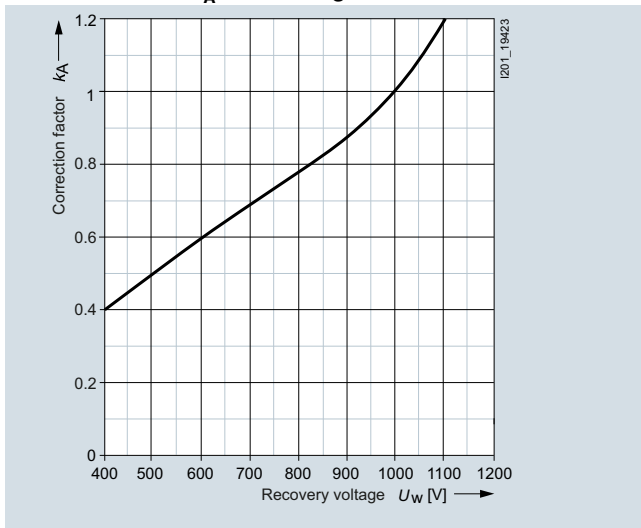

Peak arc voltage

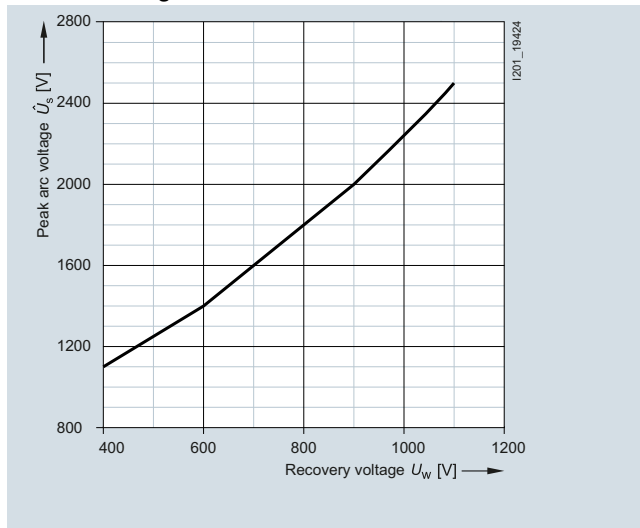

Fuse Systems

SITOR Semiconductor Fuses

LV HRC design

3NE33.. series

Size: 2
 Operational class: aR
 Rated voltage: 1000 V AC (up to 630 A)
 900 V AC (710 A)
 800 V AC (800 A)
 690 V AC (900 A)
 Rated current: 400 ... 900 A

Time/current characteristics diagram

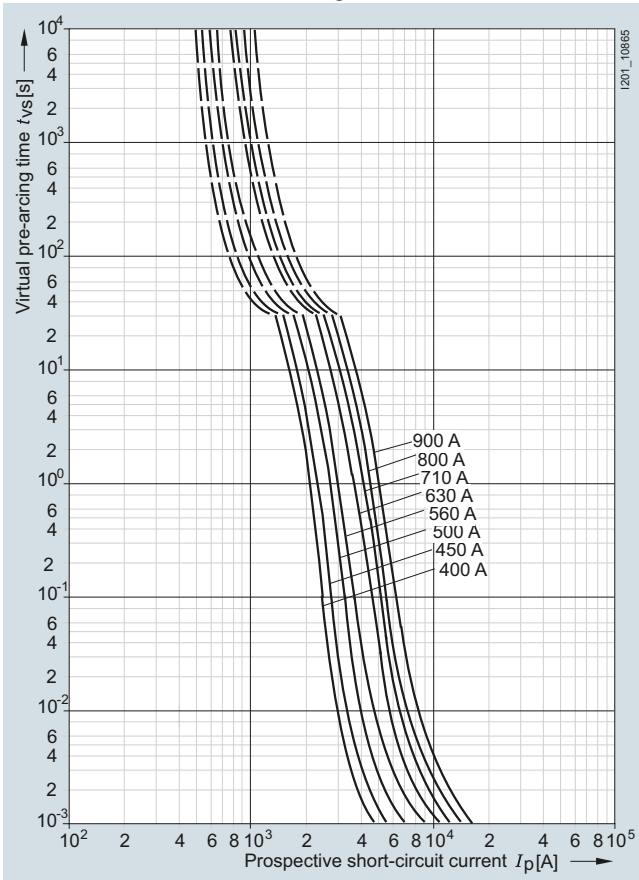

Let-through characteristics (current limitation at 50 Hz)

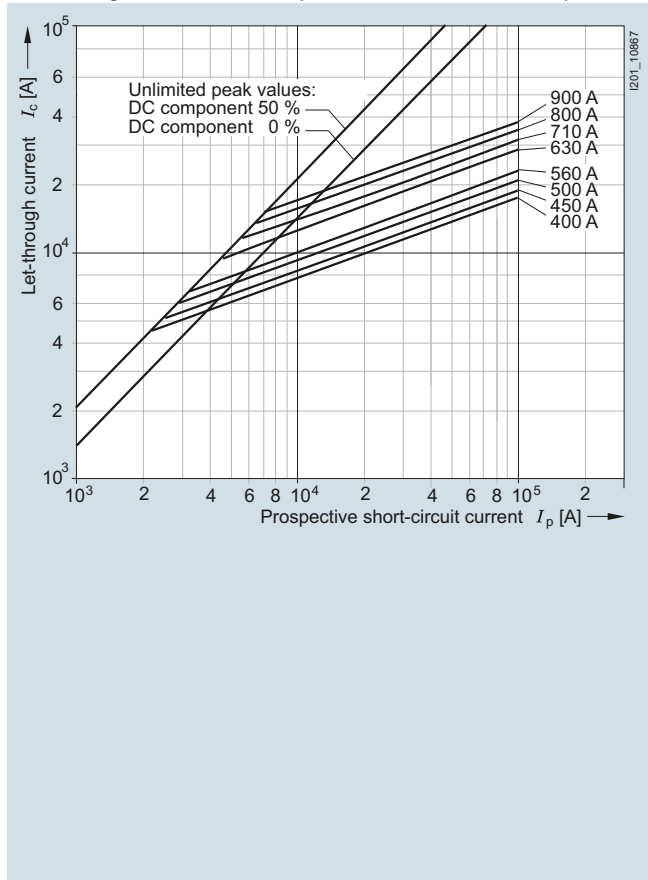

Correction factor k_A for breaking I^2t value

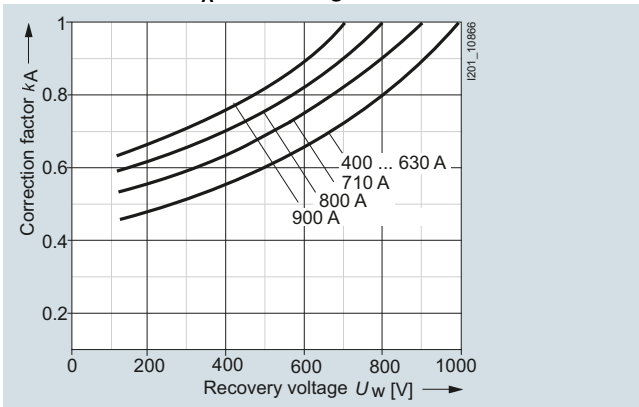

Peak arc voltage

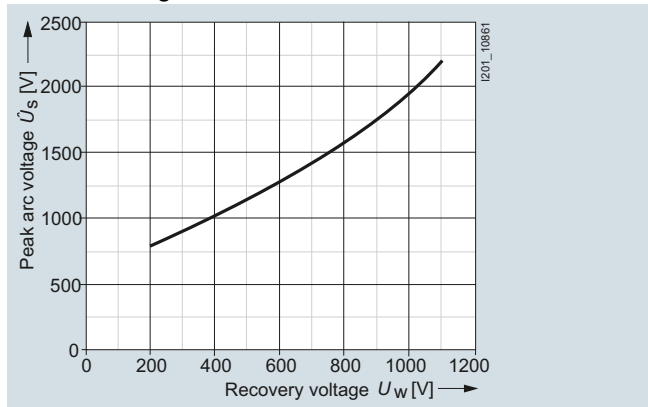

3NE34.., 3NE36.. series

Size: 3
Operational class: aR
Rated voltage: 1000 V AC
Rated current: 100 ... 710 A

Time/current characteristics diagram

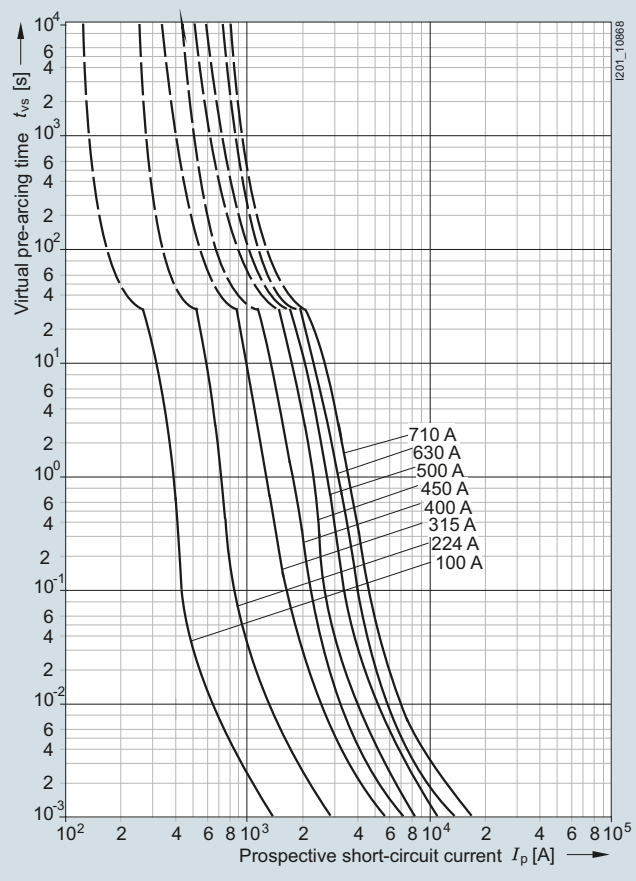

Let-through characteristics (current limitation at 50 Hz)

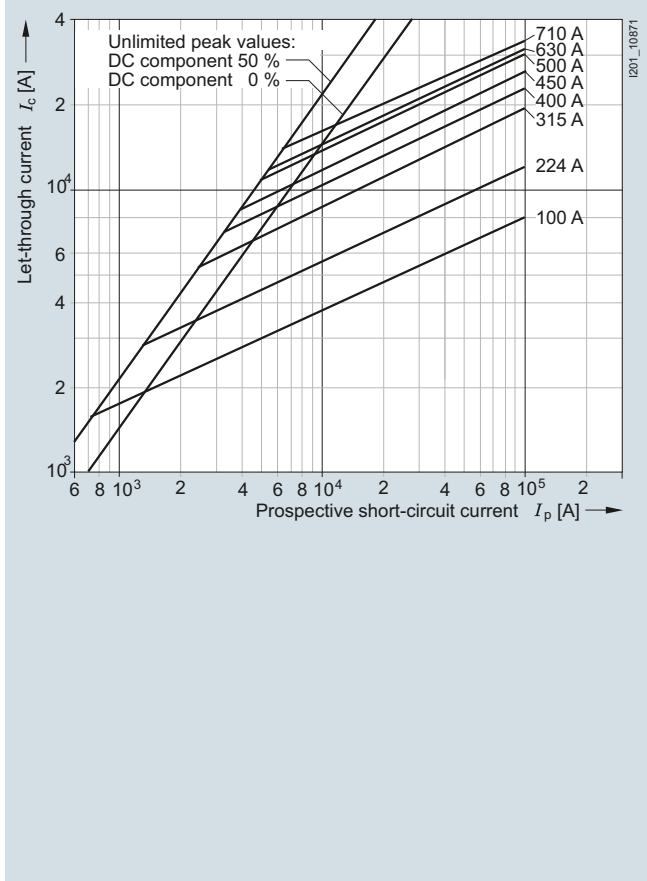

Correction factor k_A for breaking I^2t value

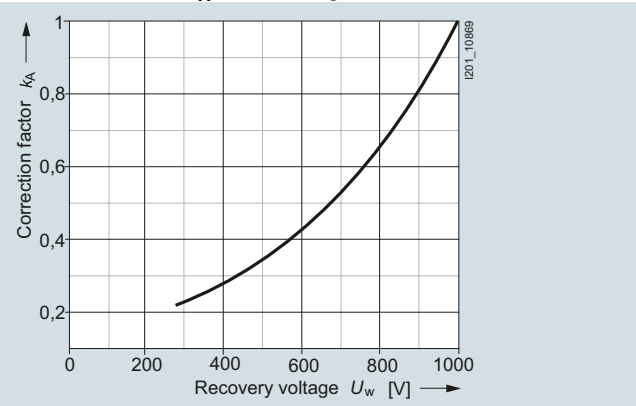

Peak arc voltage

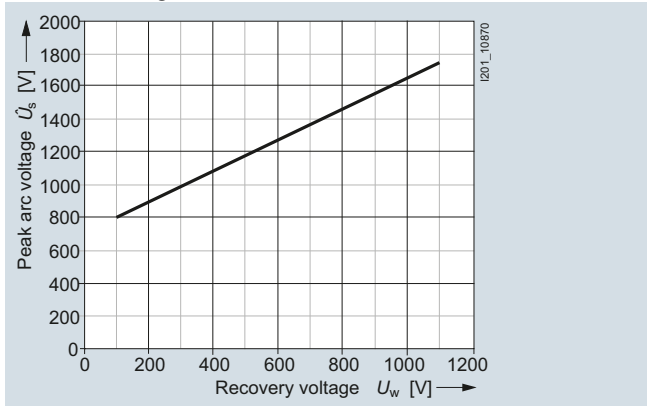

Fuse Systems

SITOR Semiconductor Fuses

LV HRC design

3NE35.5-5, 3NE41..-5 series

Operational class: aR, gR
 Rated voltage: 800 V AC (170 A)
 1000 V AC (50 A, 100 A, 200 A, 450 A)
 Rated current: 50 ... 450 A

Time/current characteristics diagram

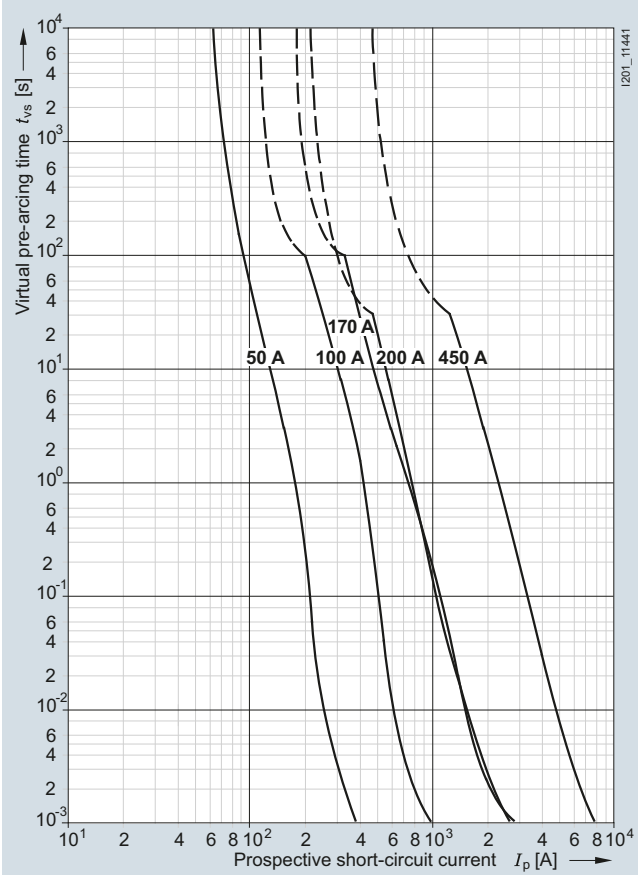

Let-through characteristics (current limitation at 50 Hz)

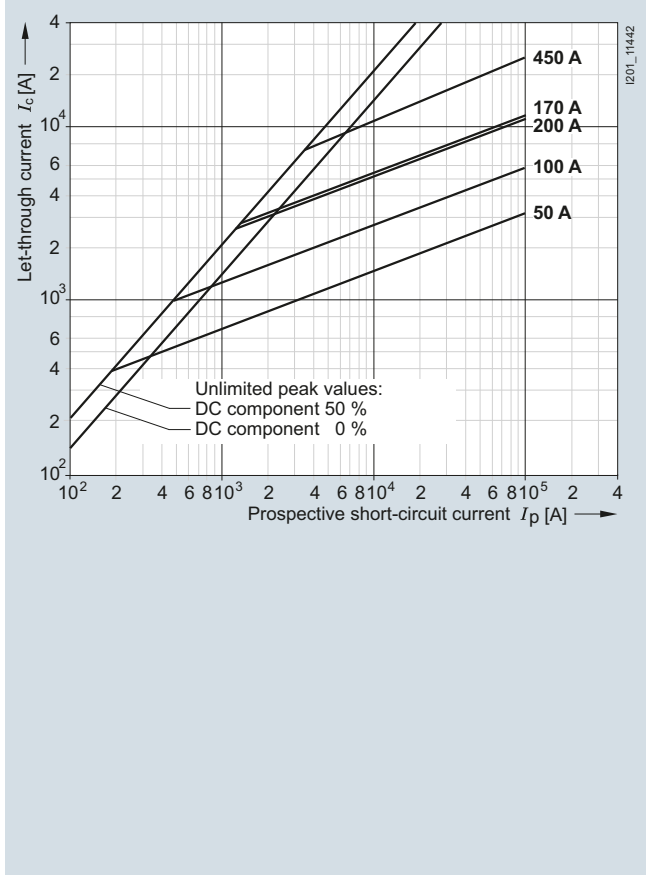

Correction factor k_A for breaking I^2t value

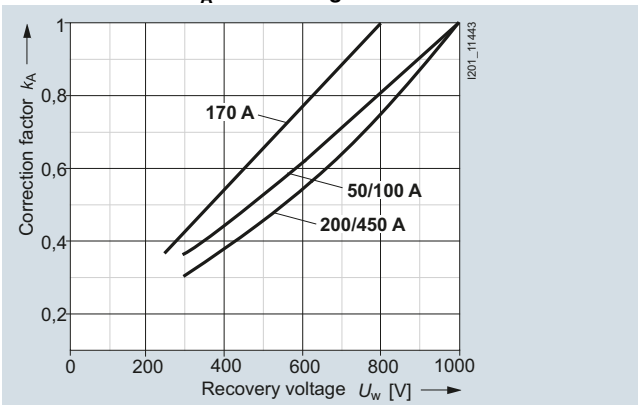

Peak arc voltage

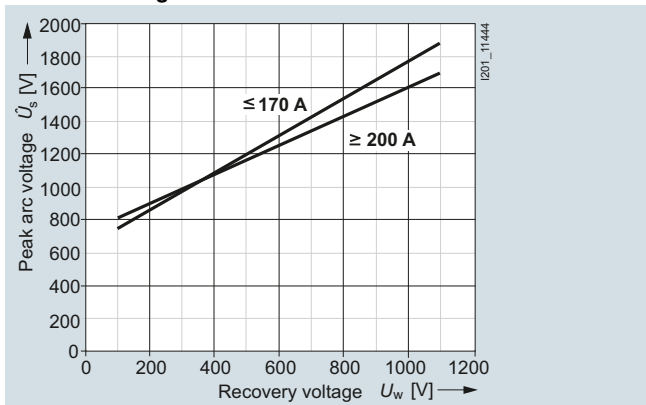

3NE41.. series

Size: 0
Operational class: gR or aR
Rated voltage: 1000 V AC
Rated current: 32 ... 160 A

Time/current characteristics diagram

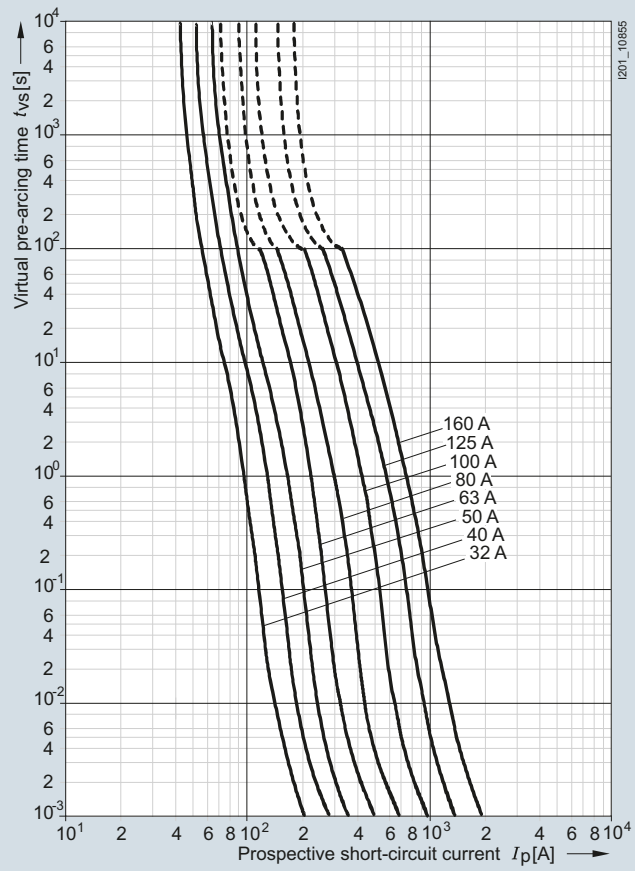

Let-through characteristics (current limitation at 50 Hz)

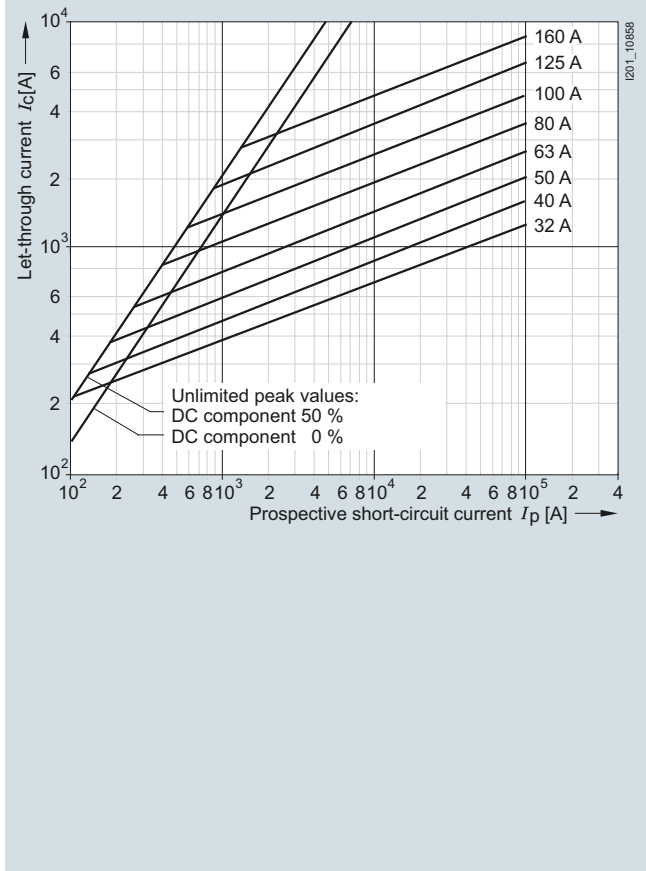

Correction factor k_A for breaking I^2t value

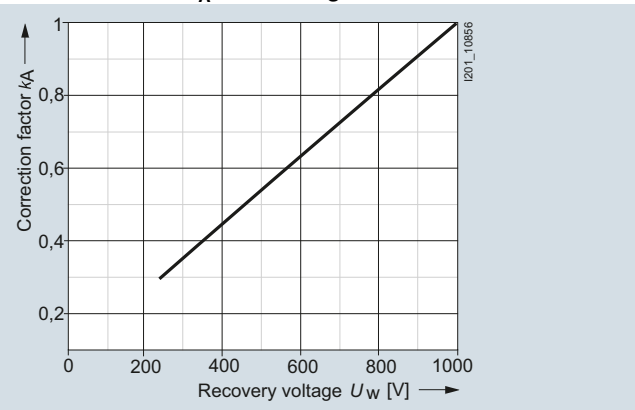

Peak arc voltage

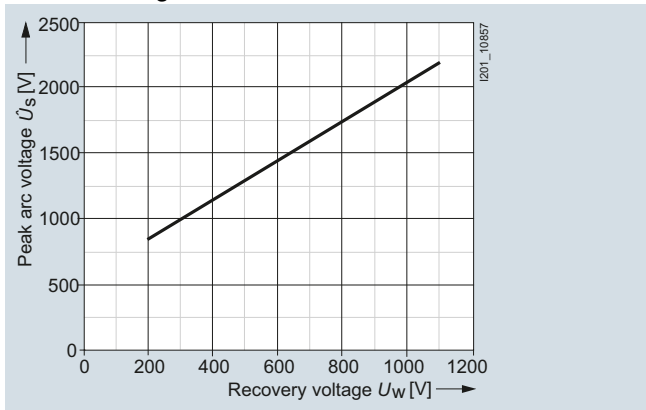

Fuse Systems

SITOR Semiconductor Fuses

LV HRC design

3NE43...-0B, 3NE43...-6B, 3NE4337, 3NE4337-6 series

Size: 2
 Operational class: aR
 Rated voltage: 800 V AC
 Rated current: 250 ... 710 A

Time/current characteristics diagram

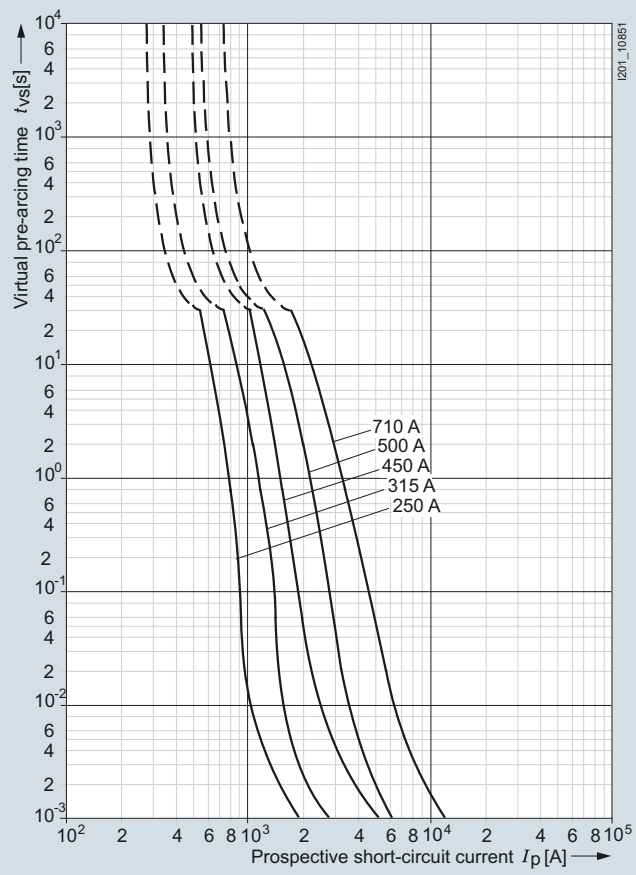

Let-through characteristics (current limitation at 50 Hz)

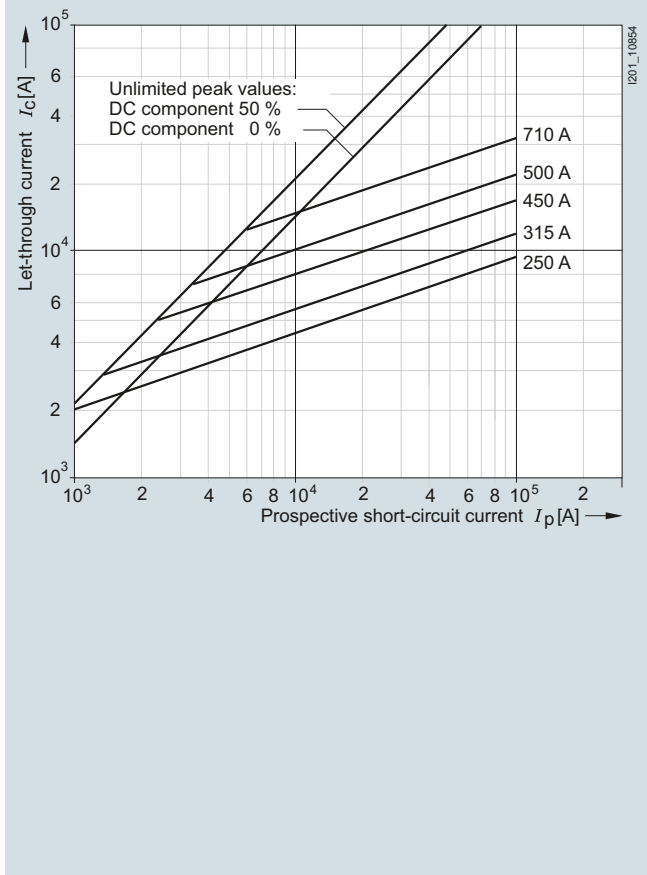

Correction factor k_A for breaking I^2t value

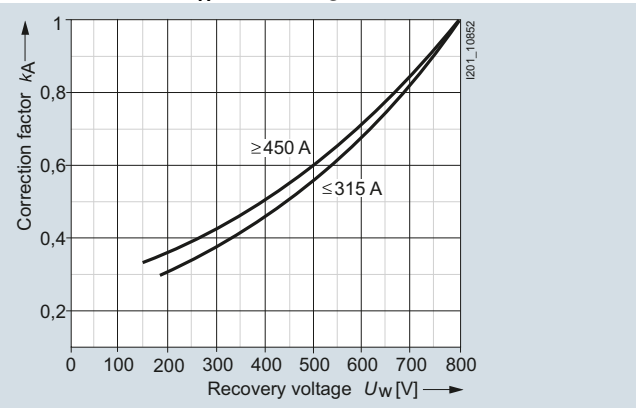

Peak arc voltage

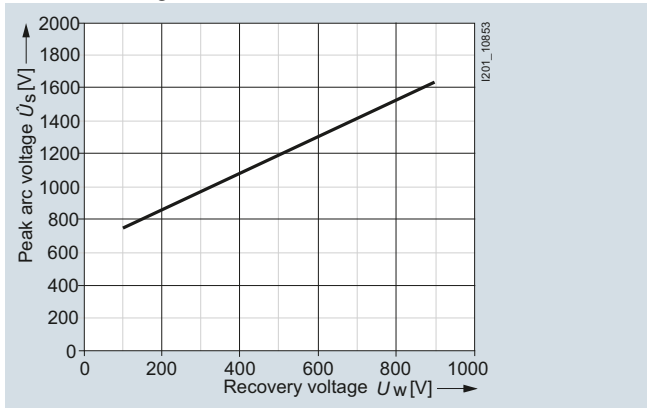

3NE53..-0MK06, -MK66 series

Size: 2
Operational class: gR, aR
Rated voltage: 1500 V AC/1000 V DC
Rated current: 40 ... 630 A

Time/current characteristics diagram

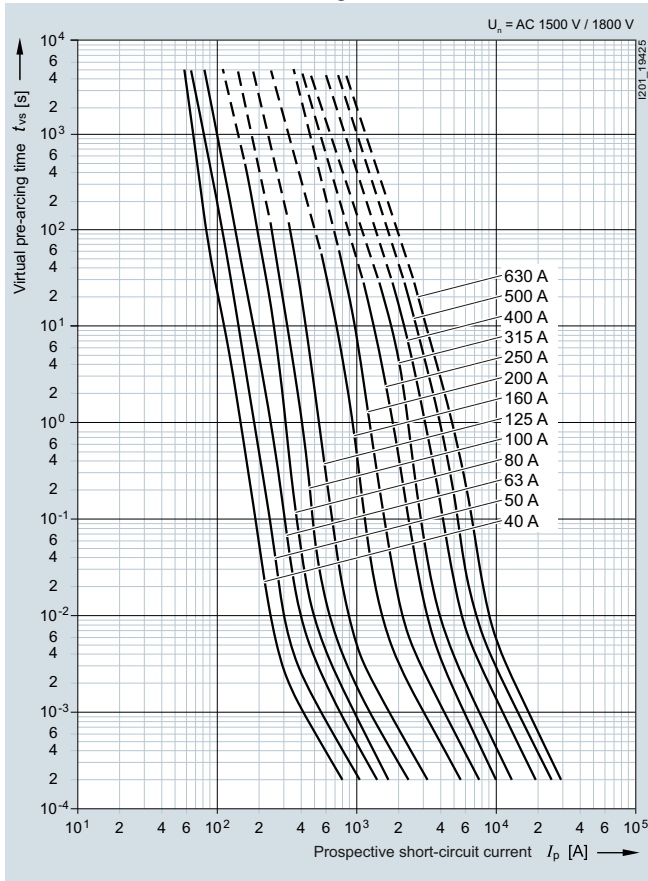

Let-through characteristics (current limitation at 50 Hz)

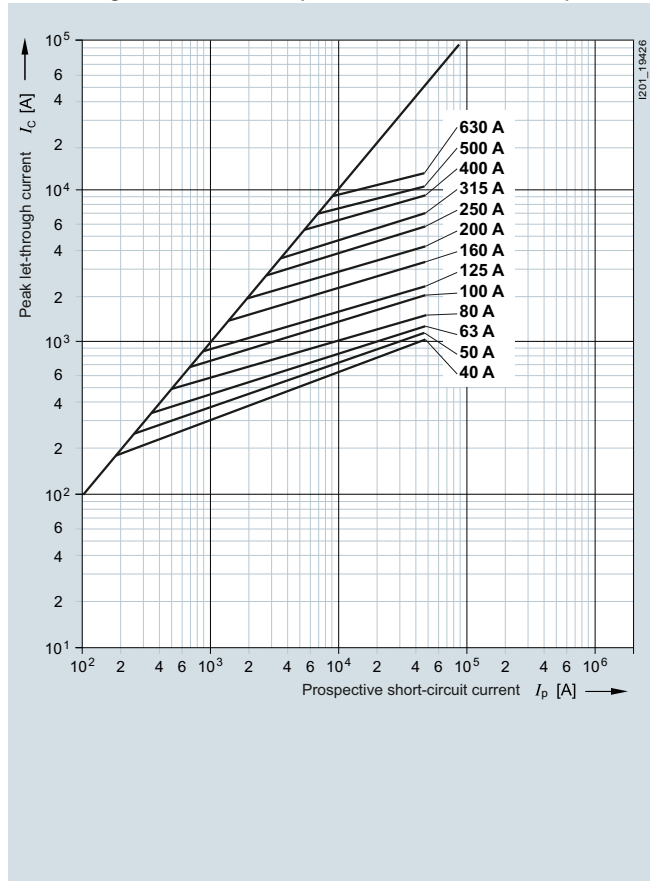

Fuse Systems

SITOR Semiconductor Fuses

LV HRC design

3NE54.. series

Size: 3
 Operational class: aR
 Rated voltage: 1500 V AC
 Rated current: 160 ... 450 A

Time/current characteristics diagram

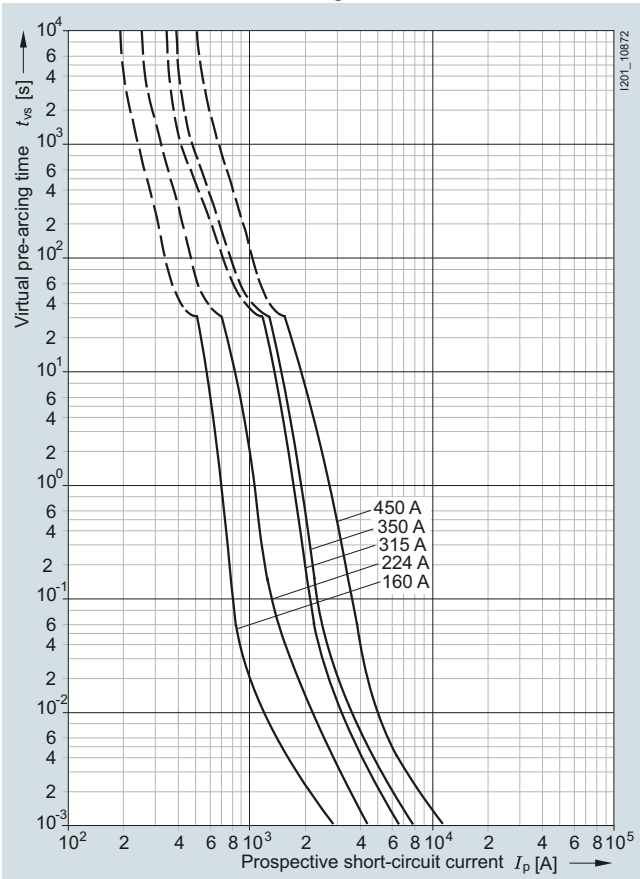

Let-through characteristics (current limitation at 50 Hz)

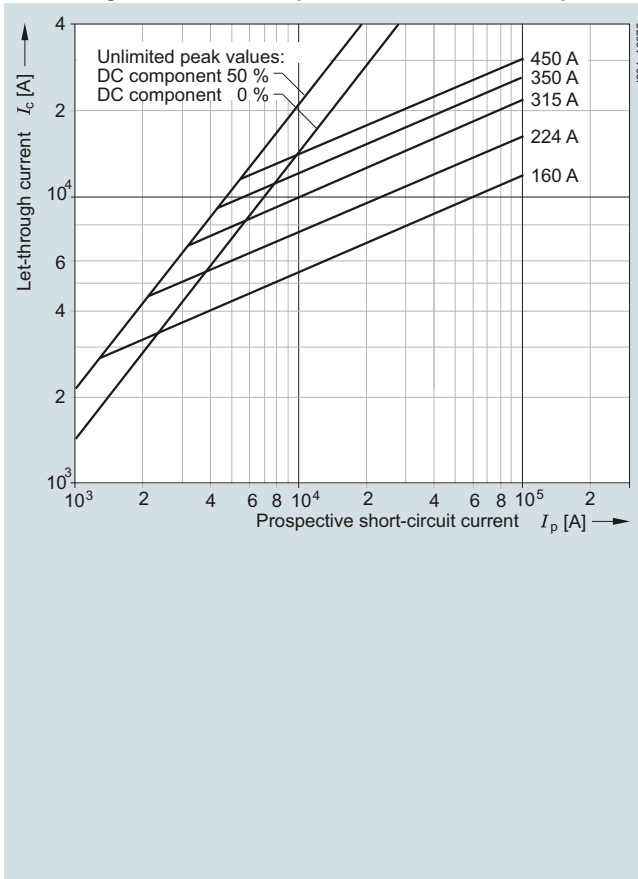

Correction factor k_A for breaking I^2t value

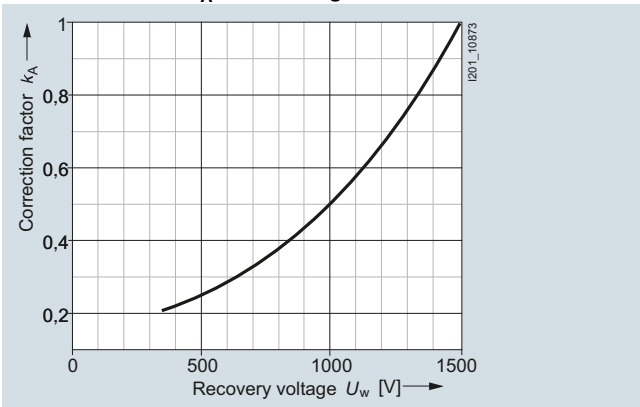

Peak arc voltage

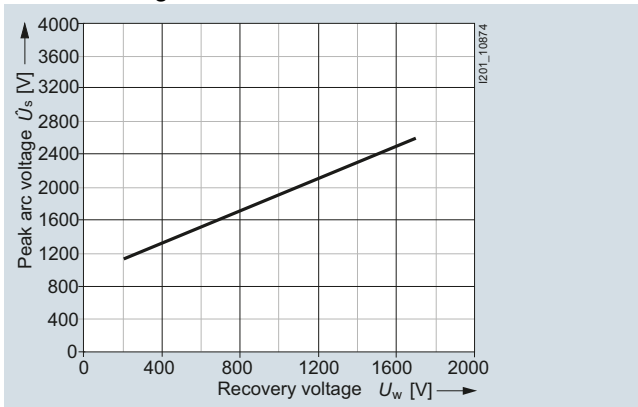

3NE56.. series

Size: 3
Operational class: aR
Rated voltage: 1500 V AC
Rated current: 250 ... 600 A

Time/current characteristics diagram

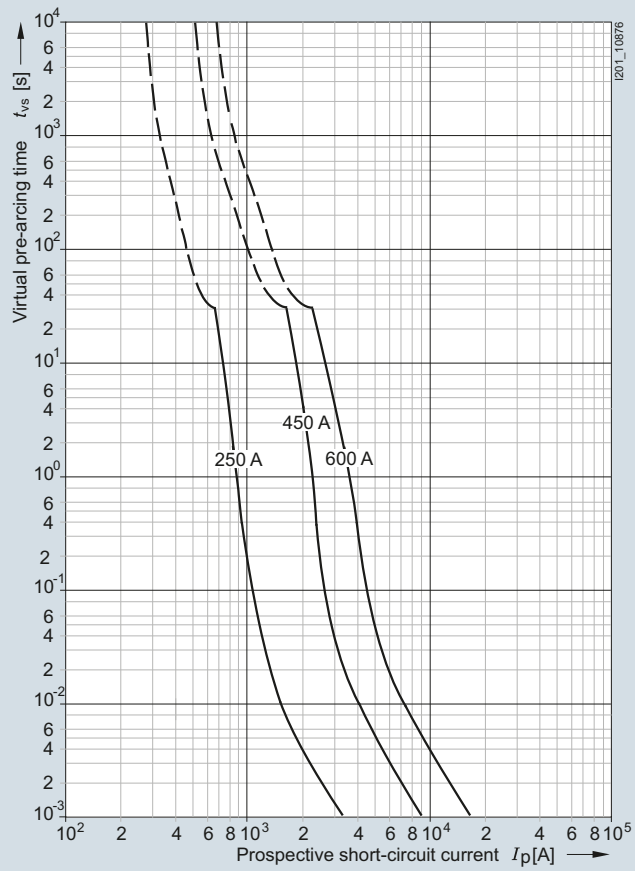

Let-through characteristics (current limitation at 50 Hz)

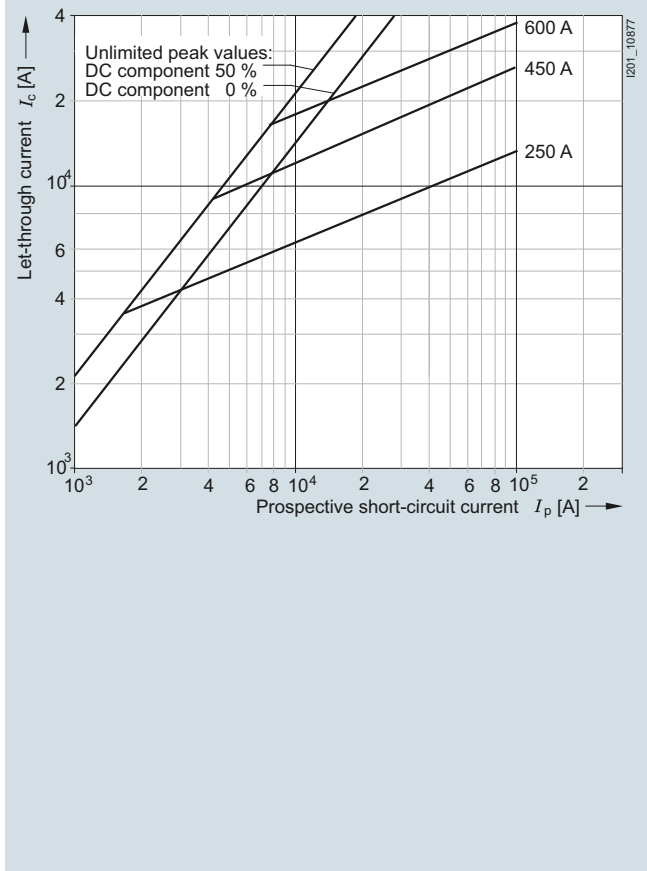

Correction factor k_A for breaking I^2t value

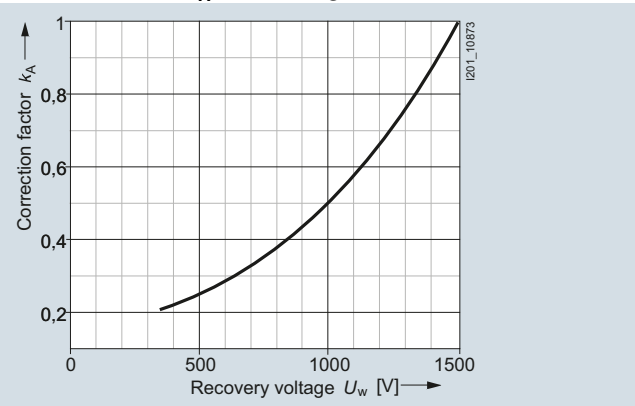

Peak arc voltage

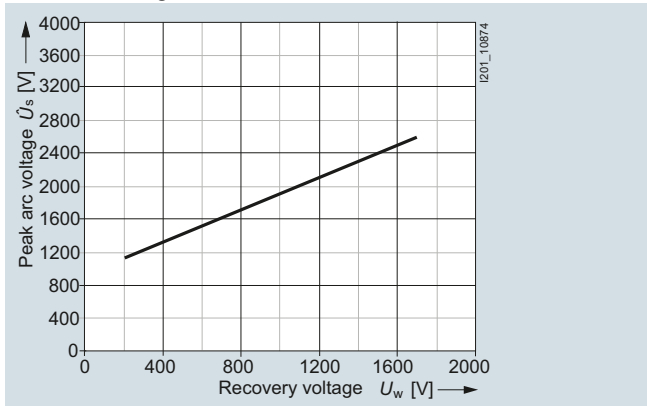

Fuse Systems

SITOR Semiconductor Fuses

LV HRC design

3NE64.., 3NE94.. series

Operational class: aR, gR
 Rated voltage: 600 V AC (850 A, 1250 A),
 900 V AC (710 A, 900 A)
 Rated current: 710 ... 1250 A

Time/current characteristics diagrams

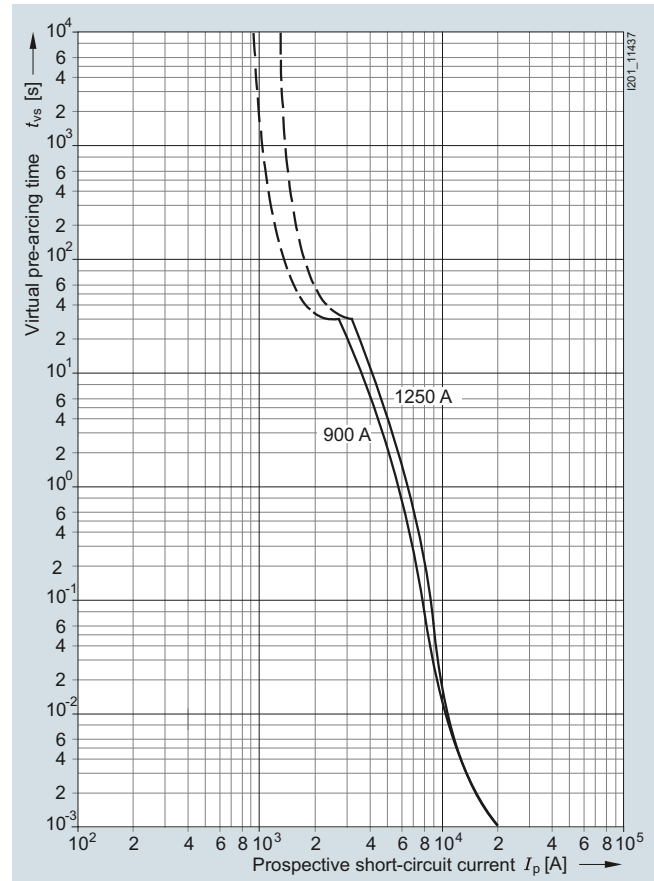
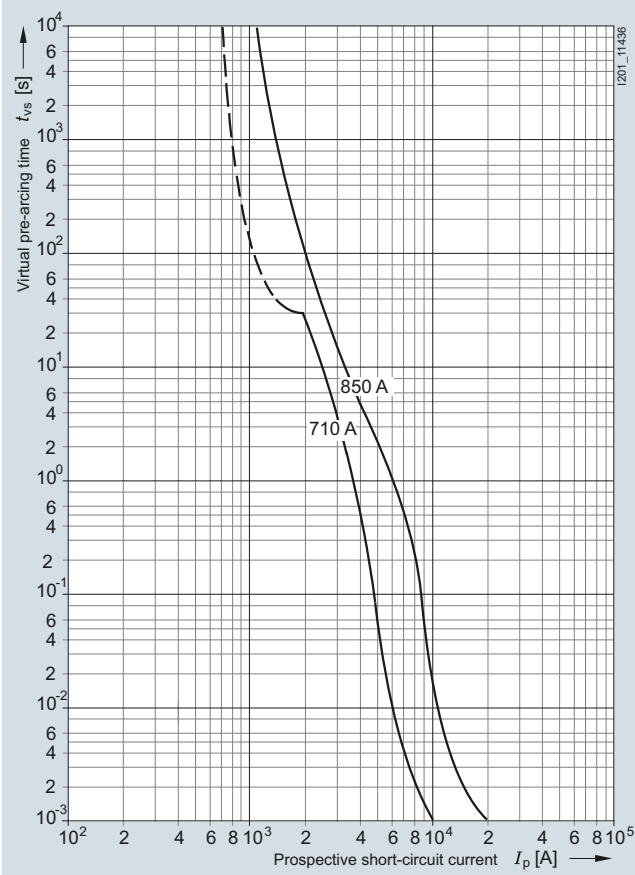

Series 3NB1..., 3NB2..

Size: 1L, 2L, 3L, 2 x 2L, 2 x 3L, 3 x 3L,
Operational class: aR
Rated voltage: 1250 V DC
Rated current: 200 ... 2400 A

Time/current characteristics diagram

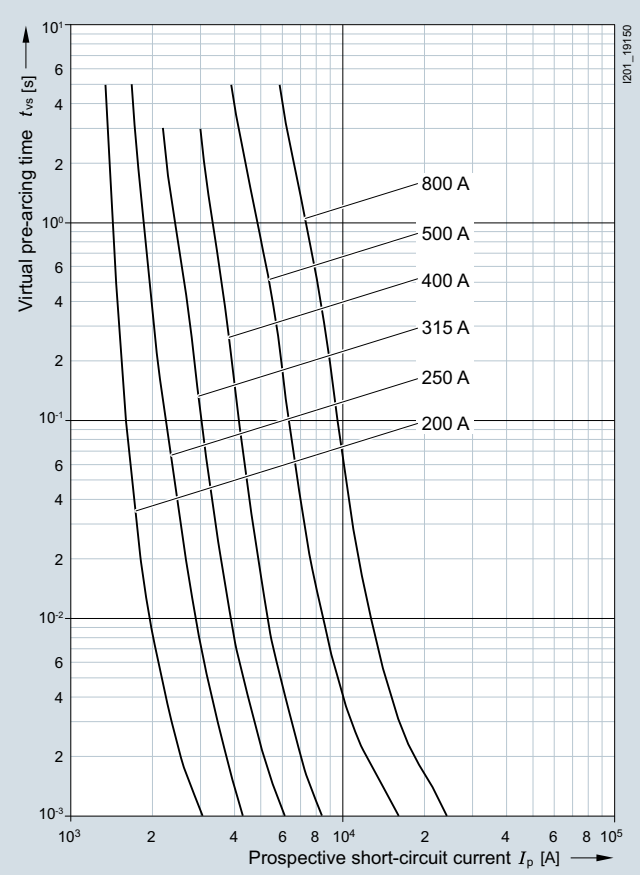

3NB1...-4KK11

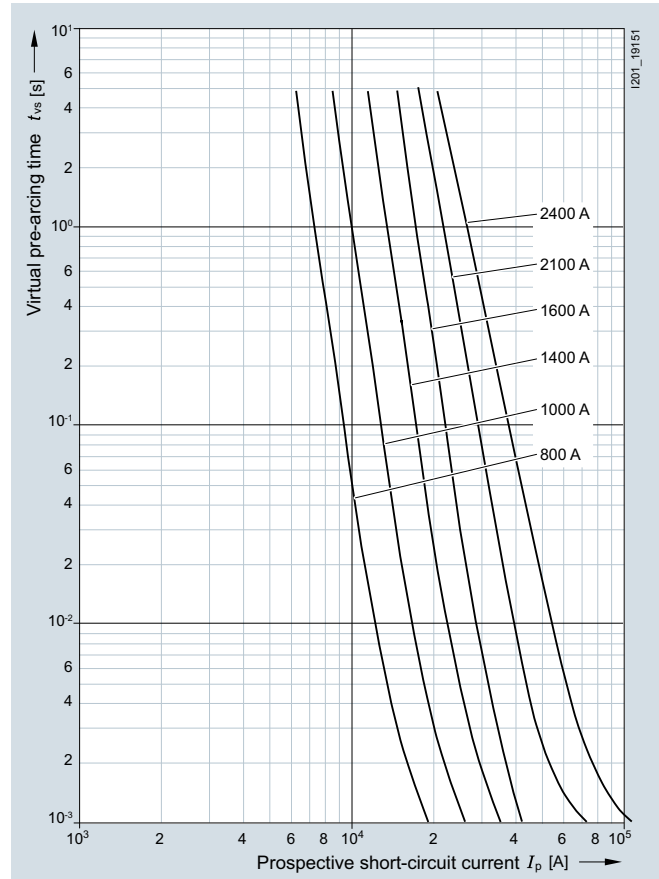

3NB2...-4KK1.

Let-through characteristic curves

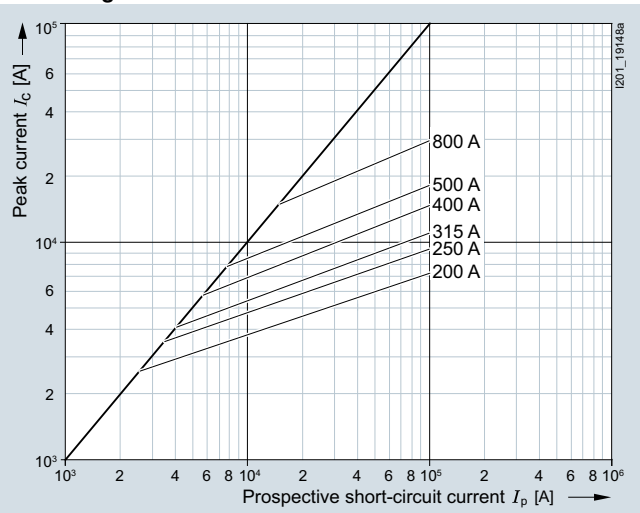

3NB1...-4KK11

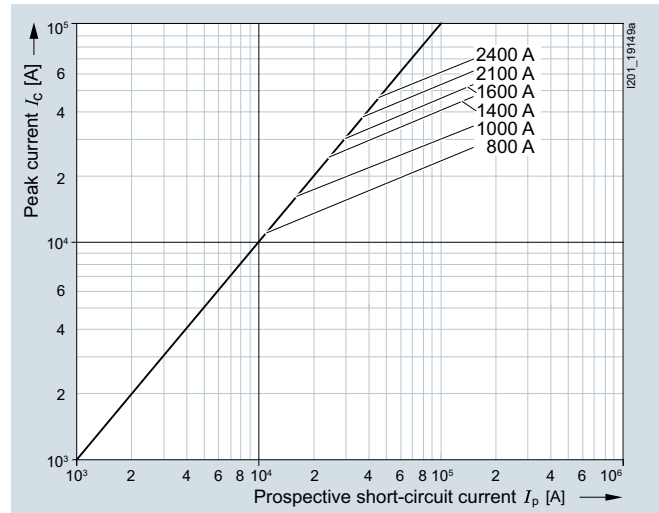

3NB2...-4KK1.

Fuse Systems

SITOR Semiconductor Fuses

LV HRC design

Correction factor k_A for breaking I^2t value

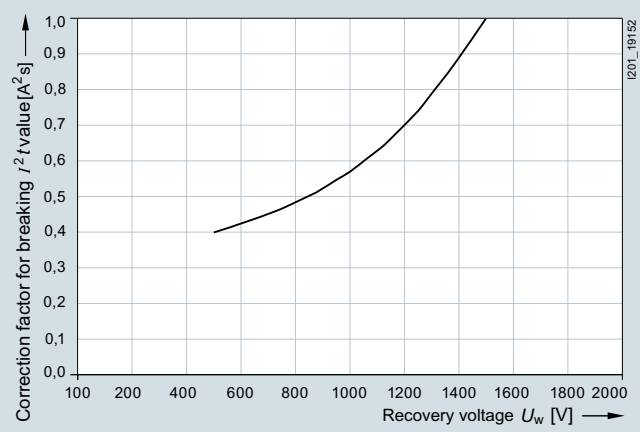

3NB1...-4KK11
3NB2...-4KK1.

Peak arc voltage

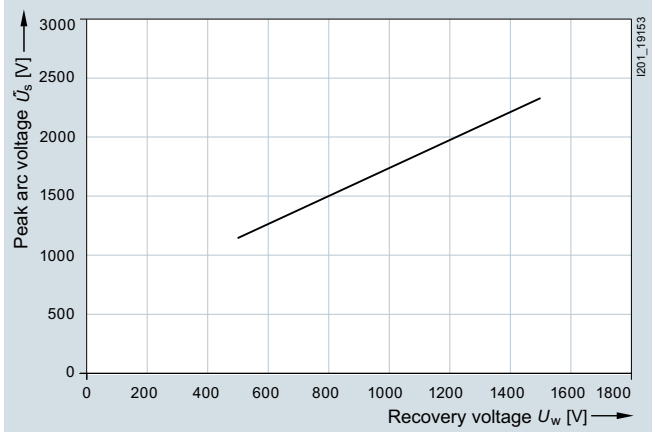

3NB1...-4KK11
3NB2...-4KK1.

3NE64.., 3NE94.. series

Operational class: aR, gR
 Rated voltage: 600 V AC (850 A, 1250 A),
 900 V AC (710 A, 900 A)
 Rated current: 710 ... 1250 A

Let-through characteristics (current limitation at 50 Hz)

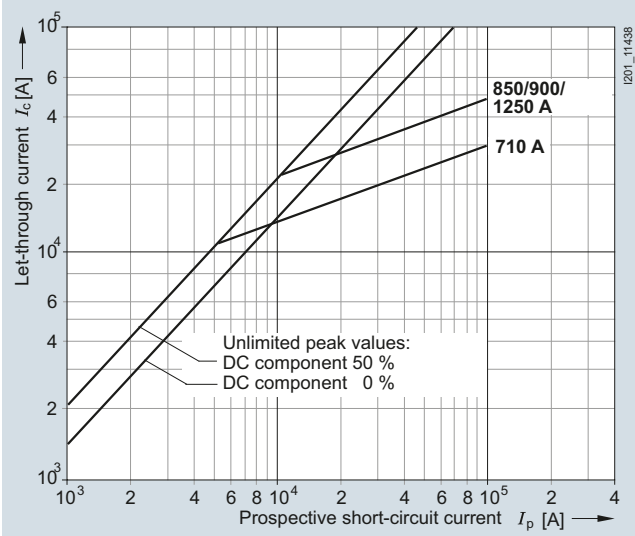

Correction factor k_A for breaking I^2t value

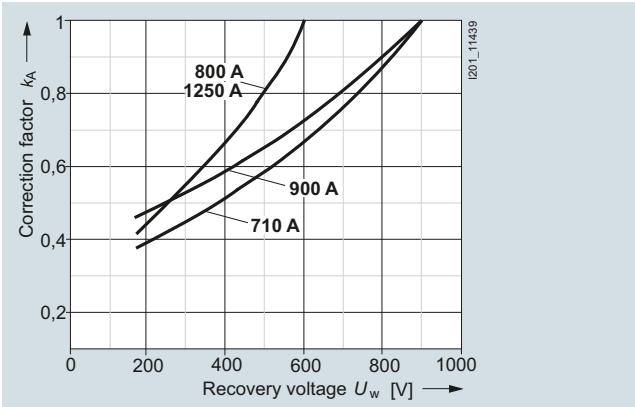

Peak arc voltage

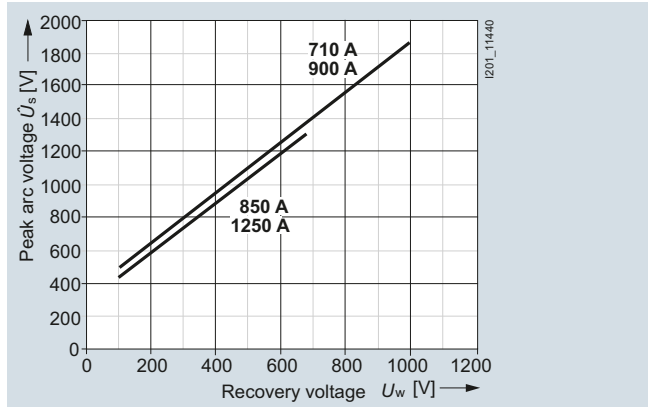

Fuse Systems

SITOR Semiconductor Fuses

LV HRC design

3NE74.., 3NE76.. series

Size: 3
 Operational class: aR
 Rated voltage: 2000 V AC
 Rated current: 200 ... 710 A

Time/current characteristics diagram

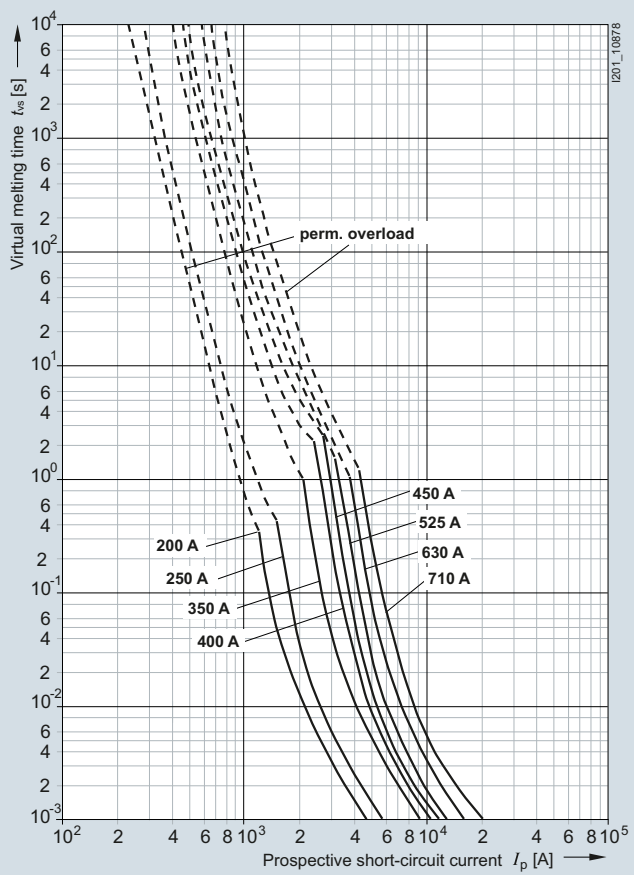

Let-through characteristics (current limitation at 50 Hz)

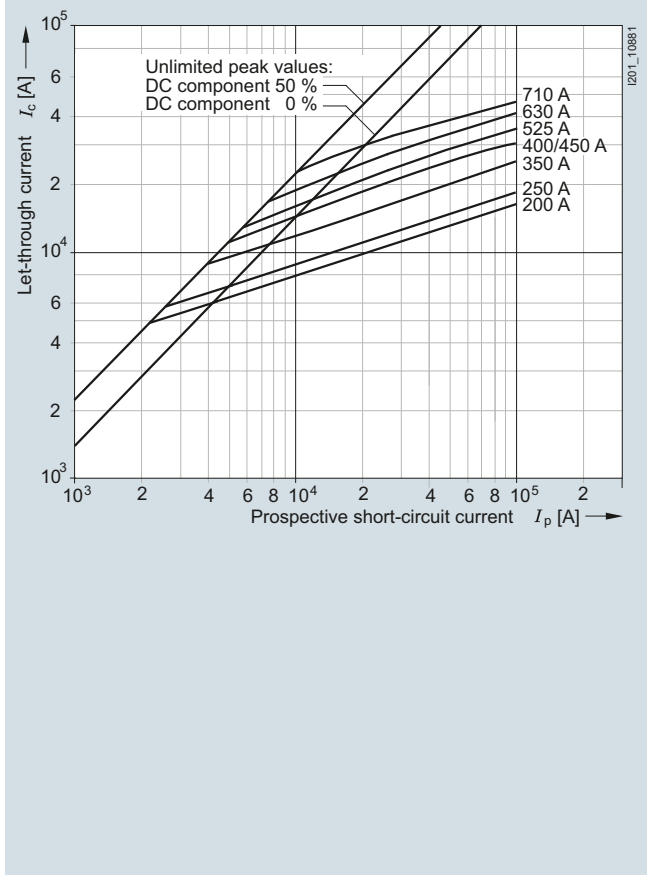

Correction factor k_A for breaking I^2t value

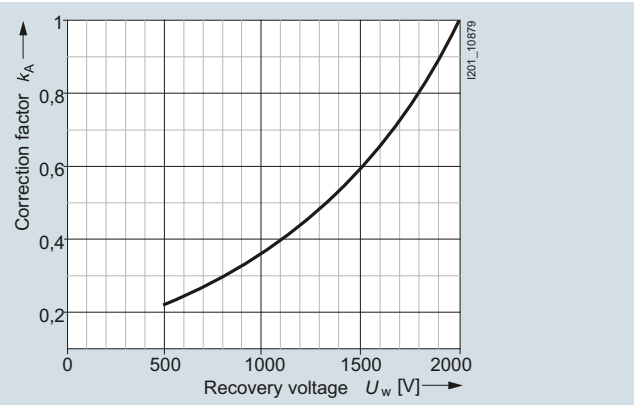

Peak arc voltage

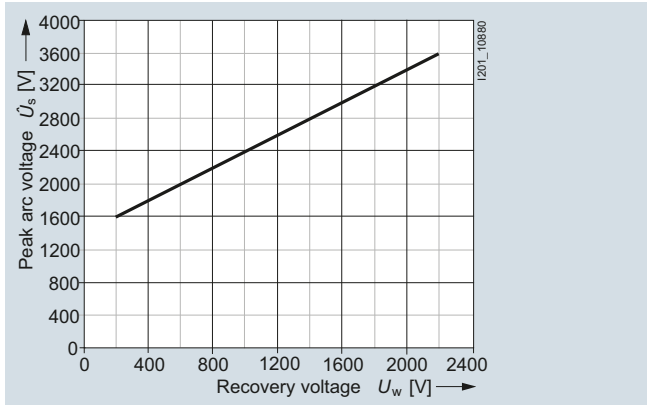

3NE80..-1 series

Size: 00
Operational class: gR or aR
Rated voltage: 690 V AC
Rated current: 25 ... 160 A

Time/current characteristics diagram

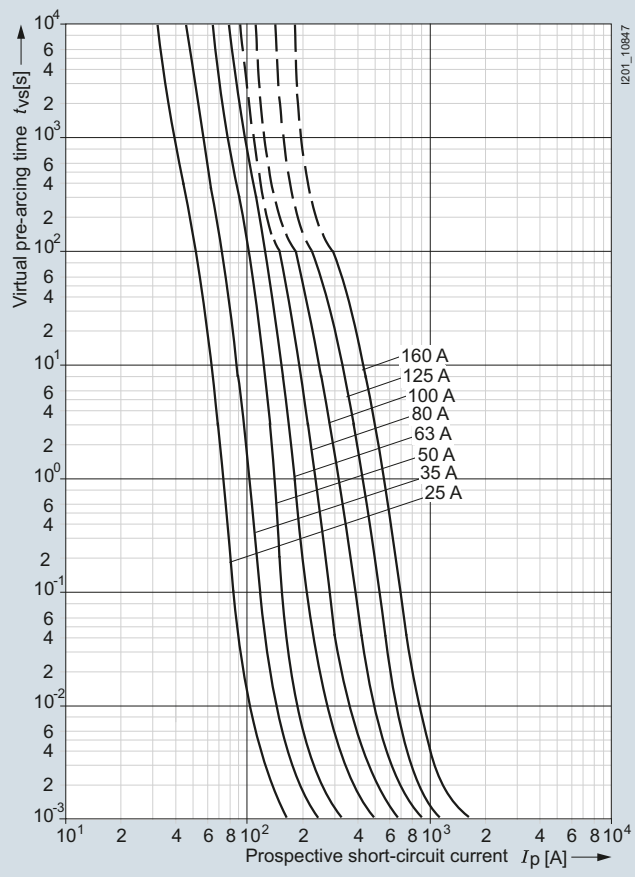

Let-through characteristics (current limitation at 50 Hz)

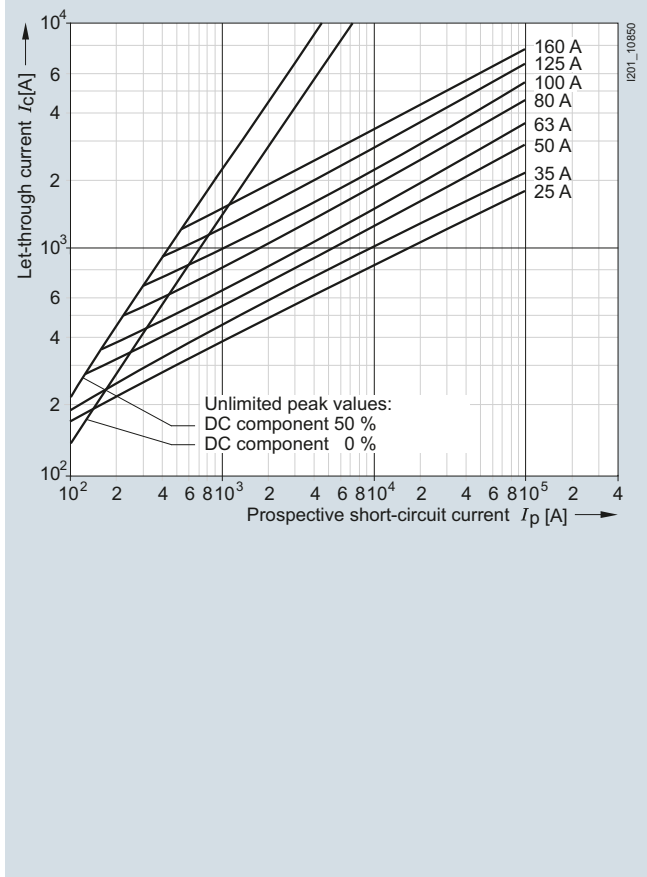

Correction factor k_A for breaking I^2t value

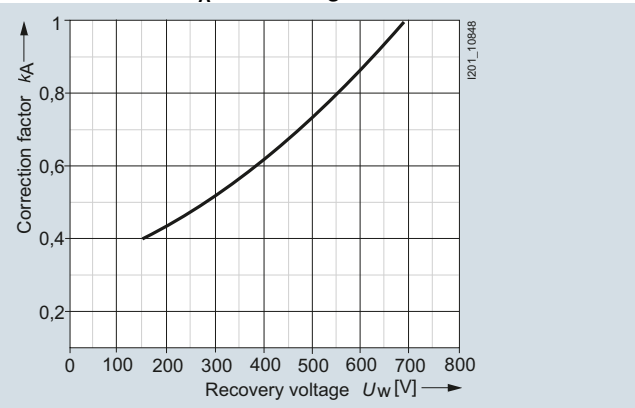

Peak arc voltage

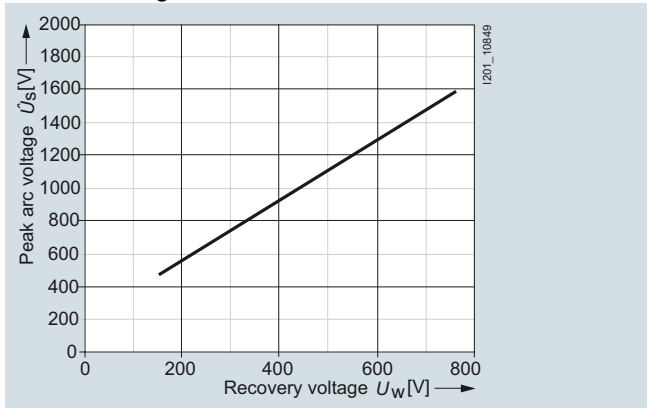

Fuse Systems

SITOR Semiconductor Fuses

LV HRC design

3NE80..-3MK series

Size: 00
 Operational class: gR/aR
 Rated voltage: 690 V AC/440 V DC
 Rated current: 80 A, 100 A, 350 A, 400 A

Time/current characteristics diagram

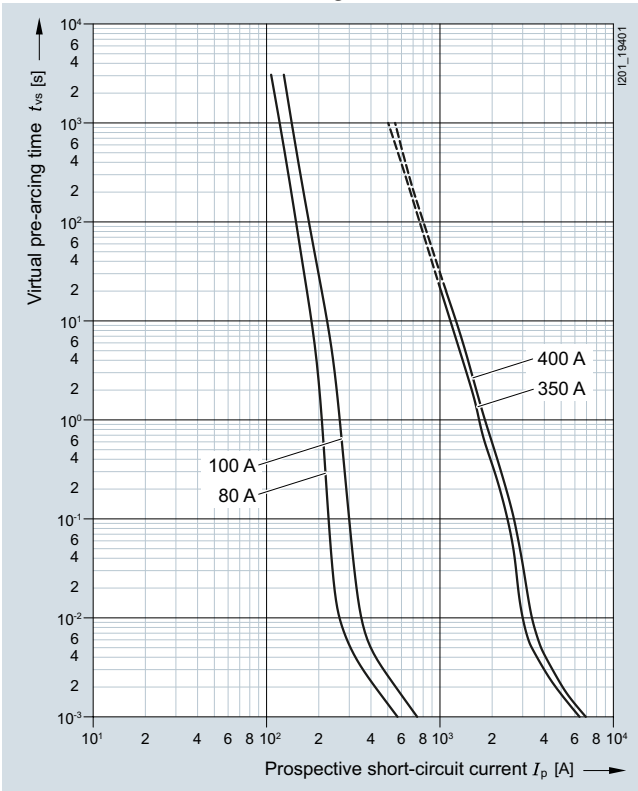

Let-through characteristics (current limitation at 50 Hz)

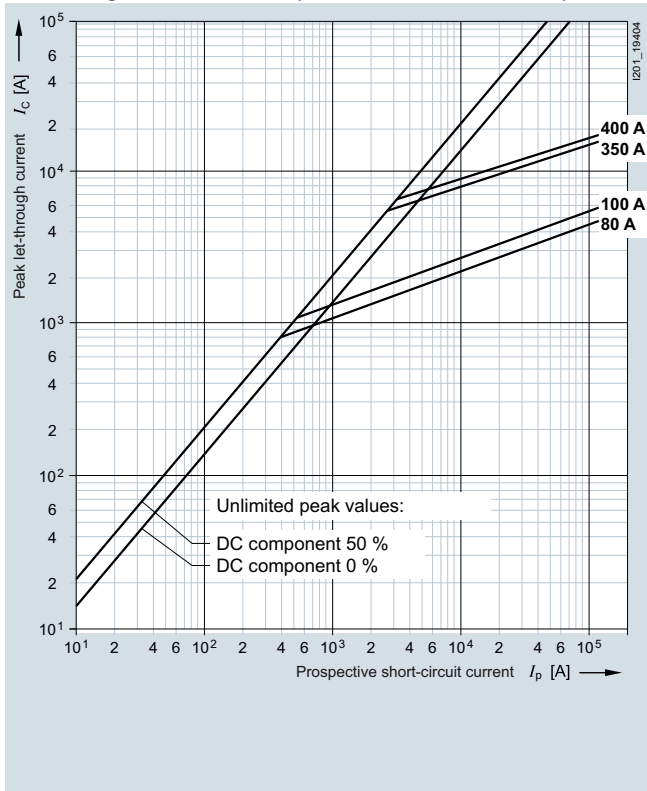

Correction factor k_A for breaking I^2t value

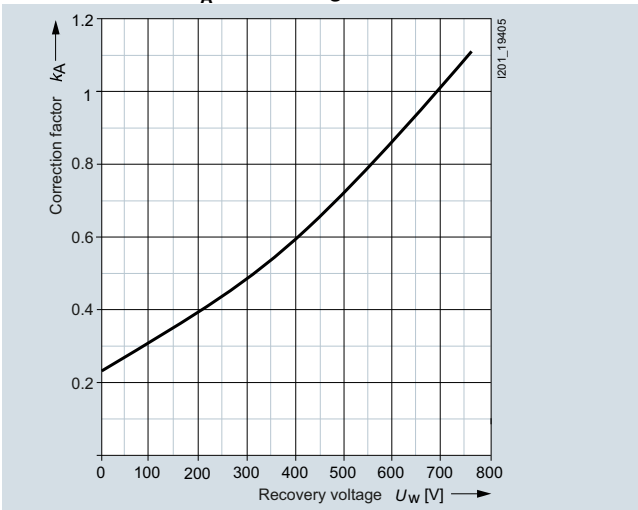

Peak arc voltage

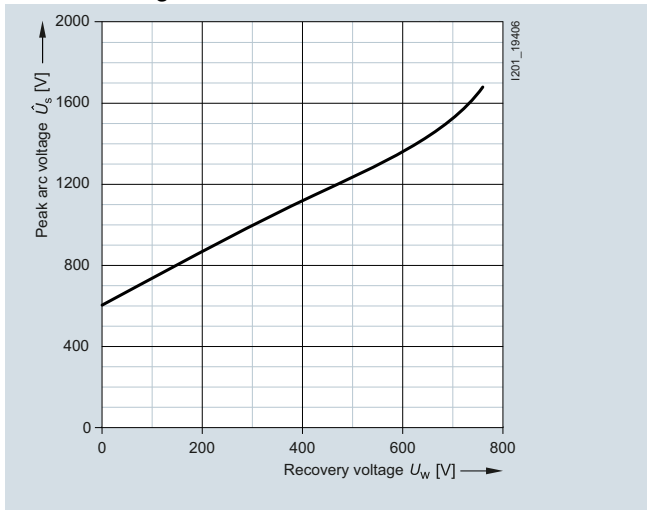

3NE82..-0MK series

Size: 1
Operational class: aR
Rated voltage: 690 V AC/440 V DC
Rated current: 100 ... 315 A

Time/current characteristics diagram

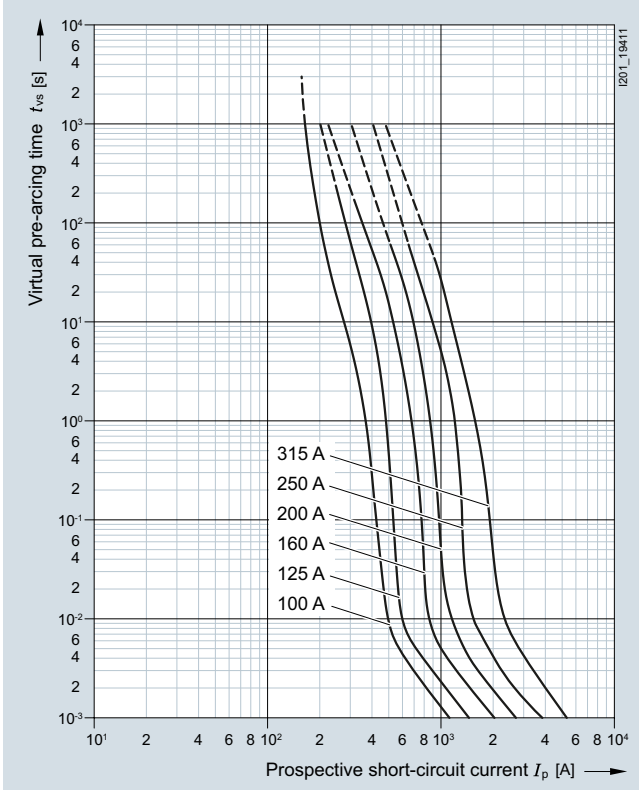

Let-through characteristics (current limitation at 50 Hz)

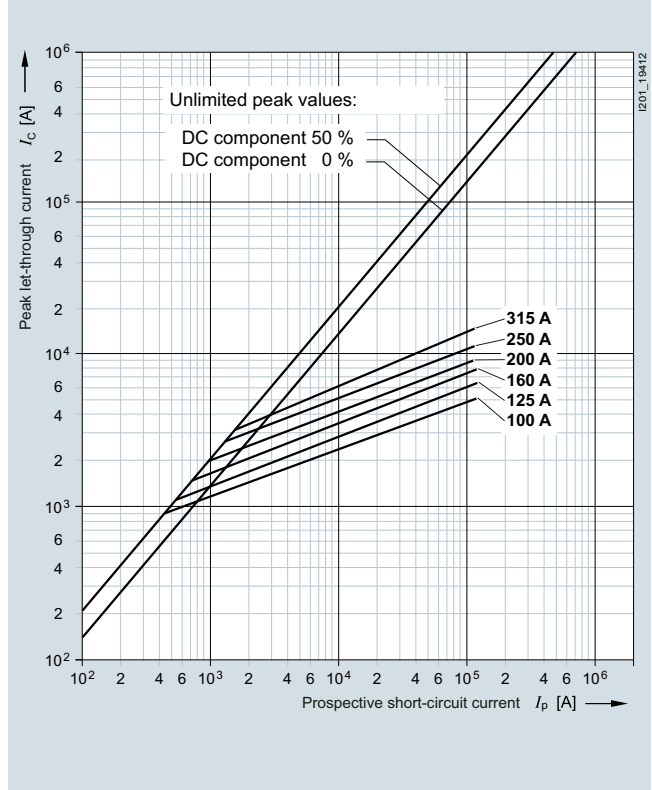

Correction factor k_A for breaking I^2t value

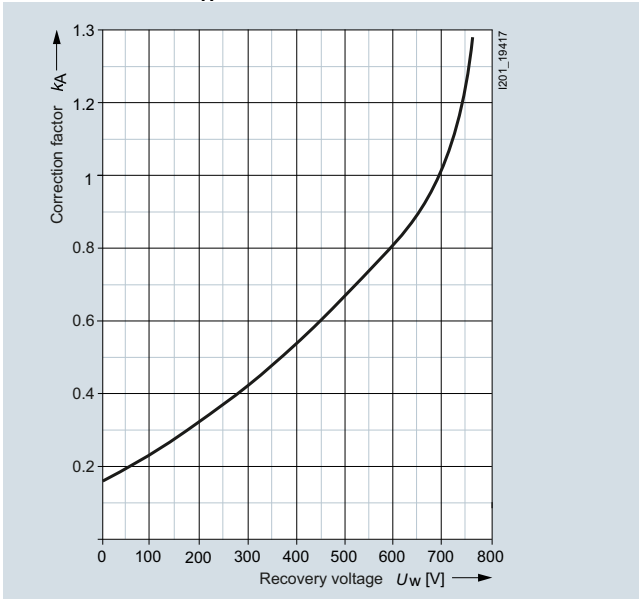

Peak arc voltage

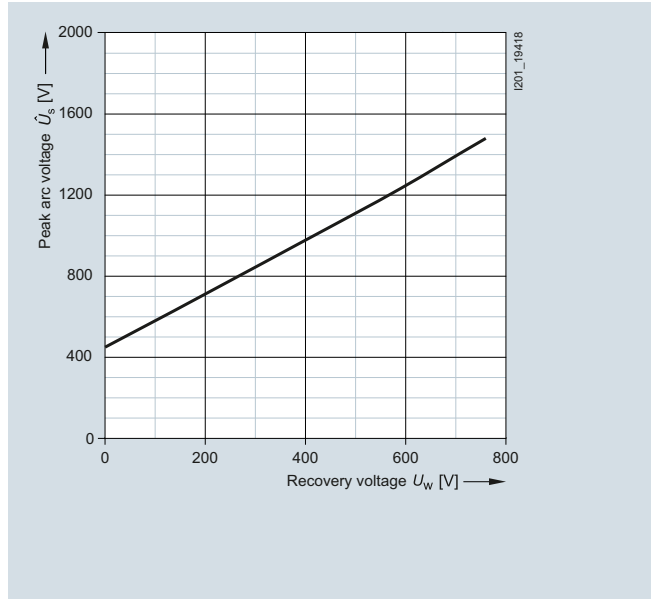

Fuse Systems

SITOR Semiconductor Fuses

LV HRC design

3NE82..-3MK series

Size: 1
 Operational class: aR
 Rated voltage: 690 V AC/440 V DC
 Rated current: 100 ... 630 A

Time/current characteristics diagram

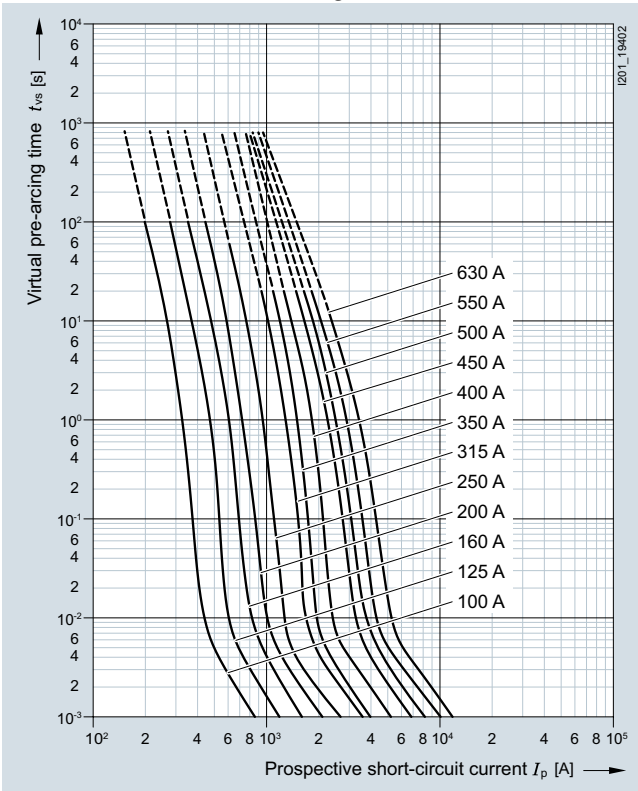

Let-through characteristics (current limitation at 50 Hz)

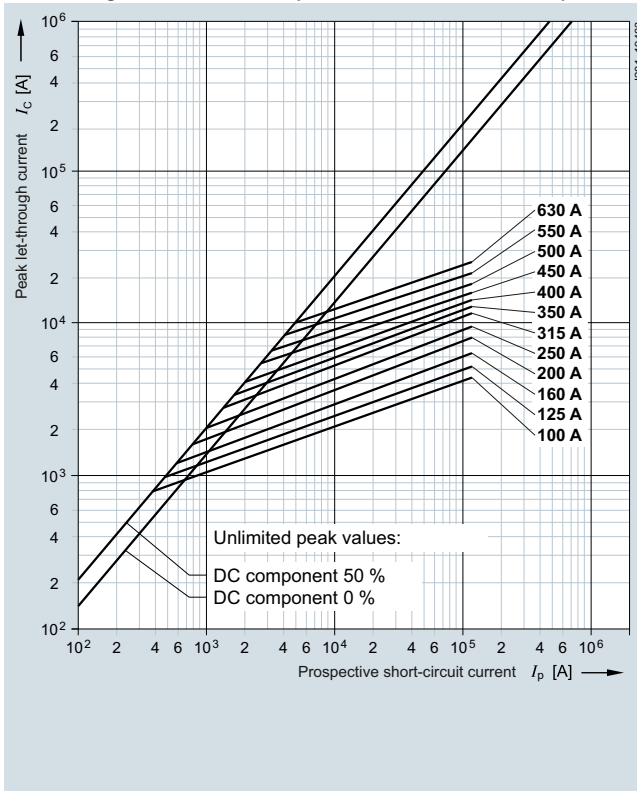

Correction factor k_A for breaking I^2t value

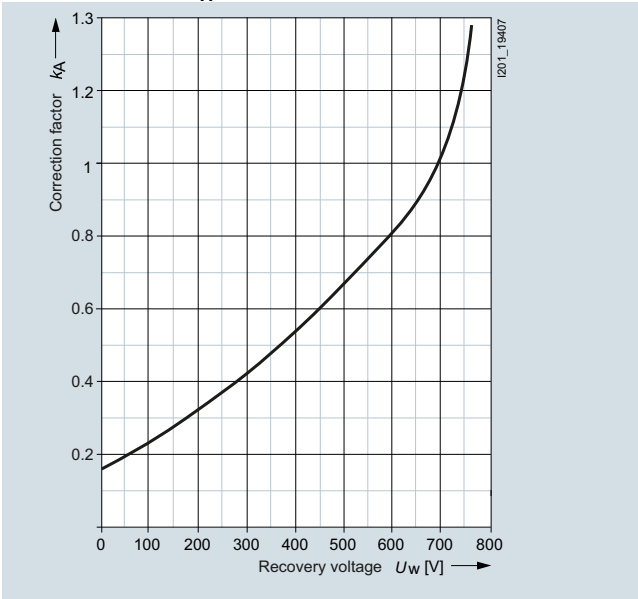

Peak arc voltage

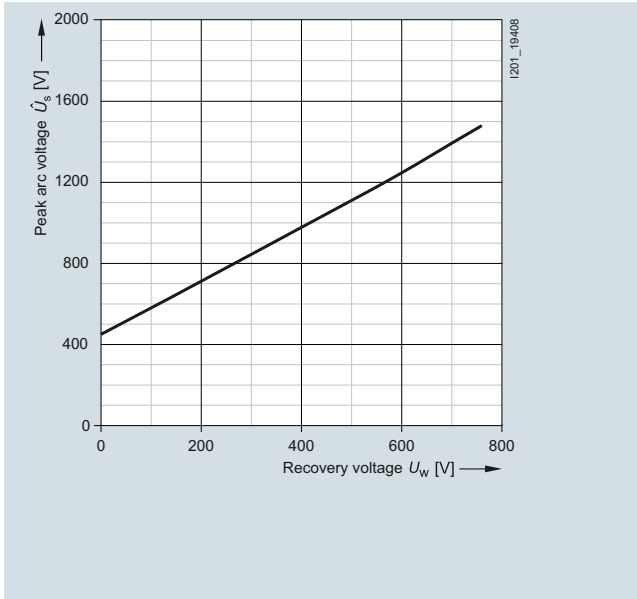

3NE83..-0MK series

Size: 2
Operational class: aR
Rated voltage: 690 V AC/440 V DC
Rated current: 350 ... 630 A

Time/current characteristics diagram

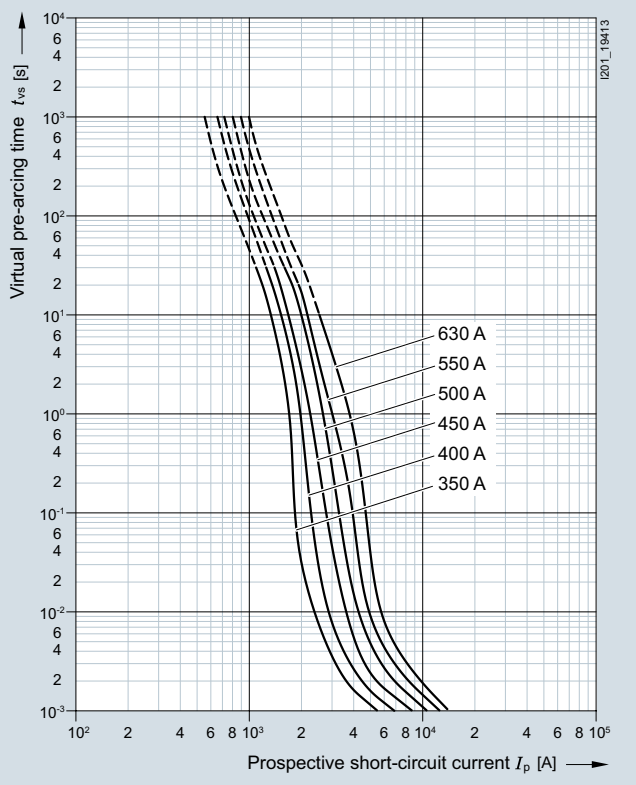

Let-through characteristics (current limitation at 50 Hz)

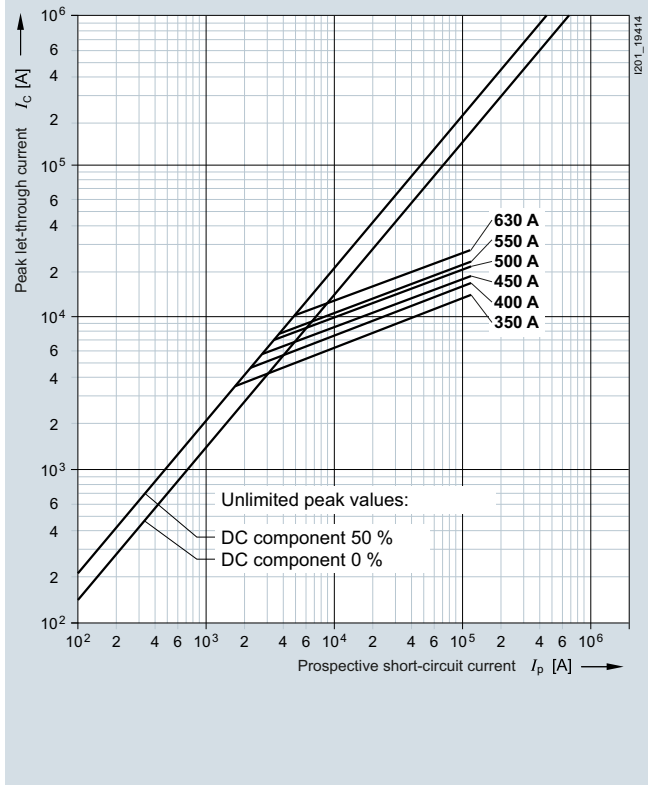

Correction factor k_A for breaking I^2t value

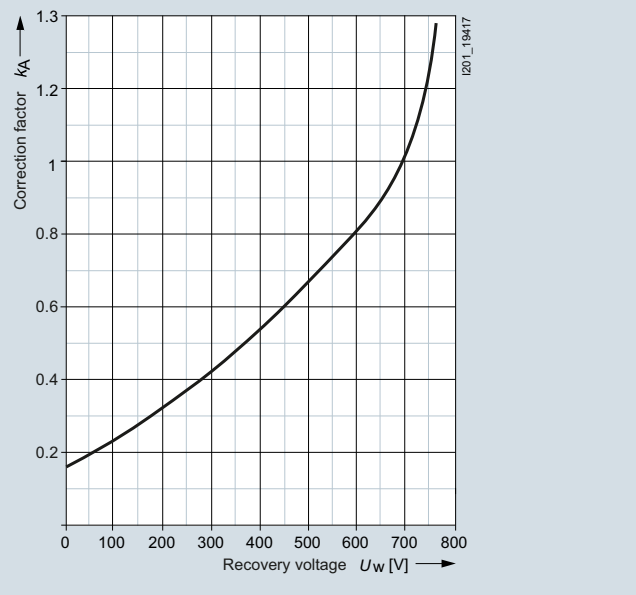

Peak arc voltage

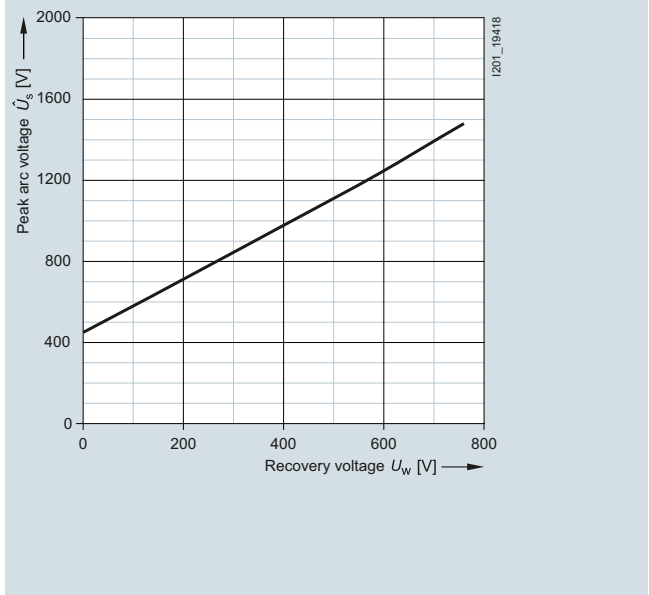

Fuse Systems

SITOR Semiconductor Fuses

LV HRC design

3NE870.-1, 3NE871.-1 series

Size: 000
 Operational class: gR or aR
 Rated voltage: 690 V AC/700 V DC
 Rated current: 20 ... 63 A

Time/current characteristics diagram

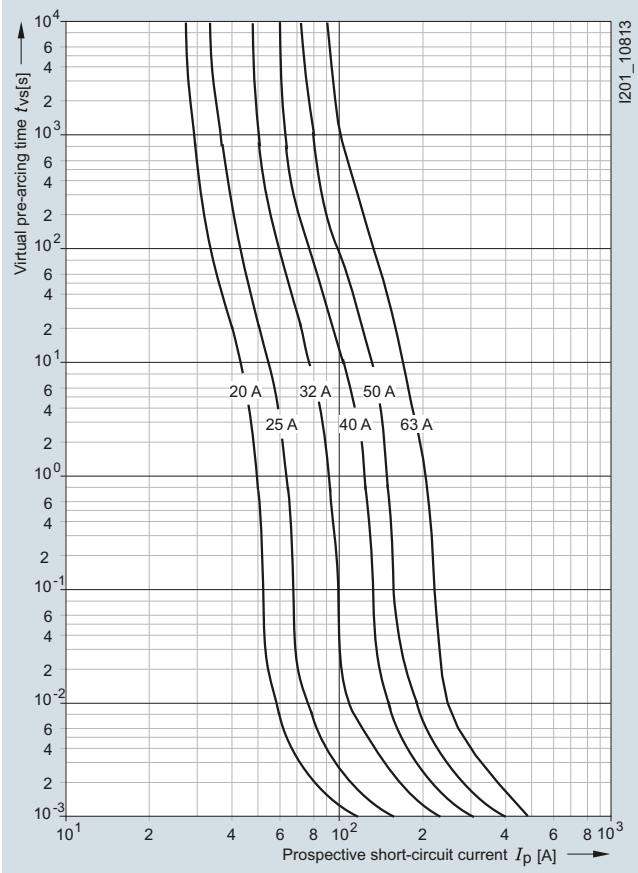

Let-through characteristics (current limitation at 50 Hz)

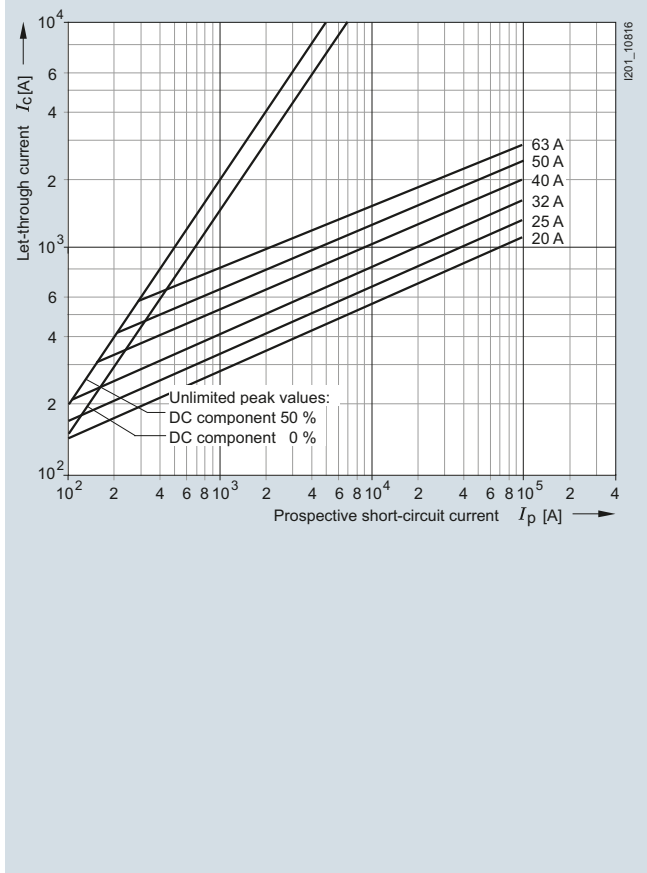

Correction factor k_A for breaking I^2t value

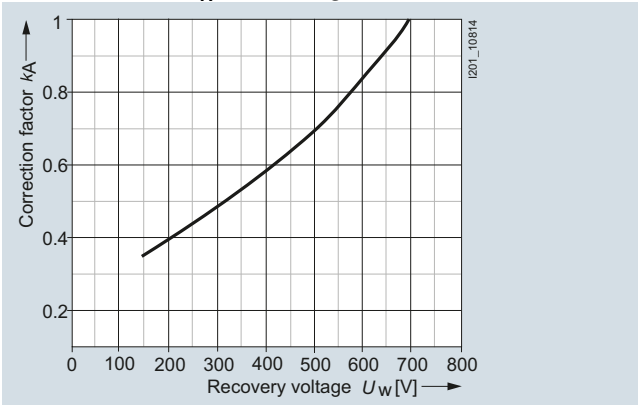

Peak arc voltage

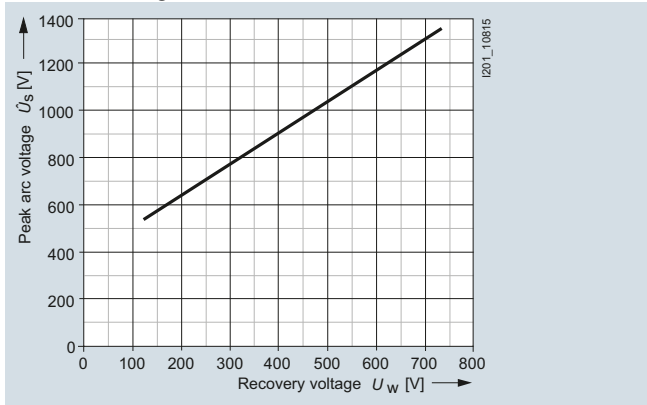

3NE872.-1, 3NE8731-1 series

Size: 000
Operational class: aR
Rated voltage: 690 V AC/700 V DC according to UL
Rated current: 80 ... 315 A

Time/current characteristics diagram

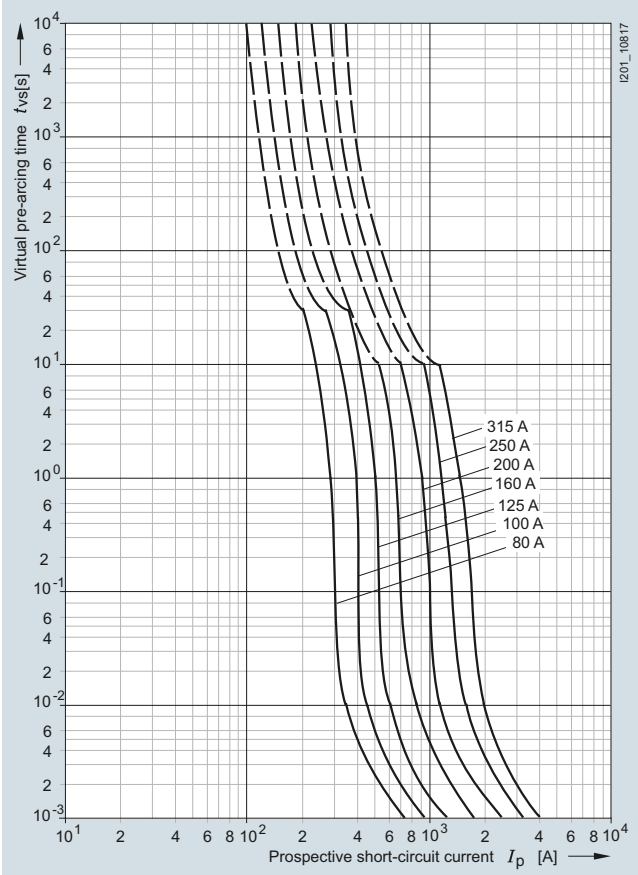

Let-through characteristics (current limitation at 50 Hz)

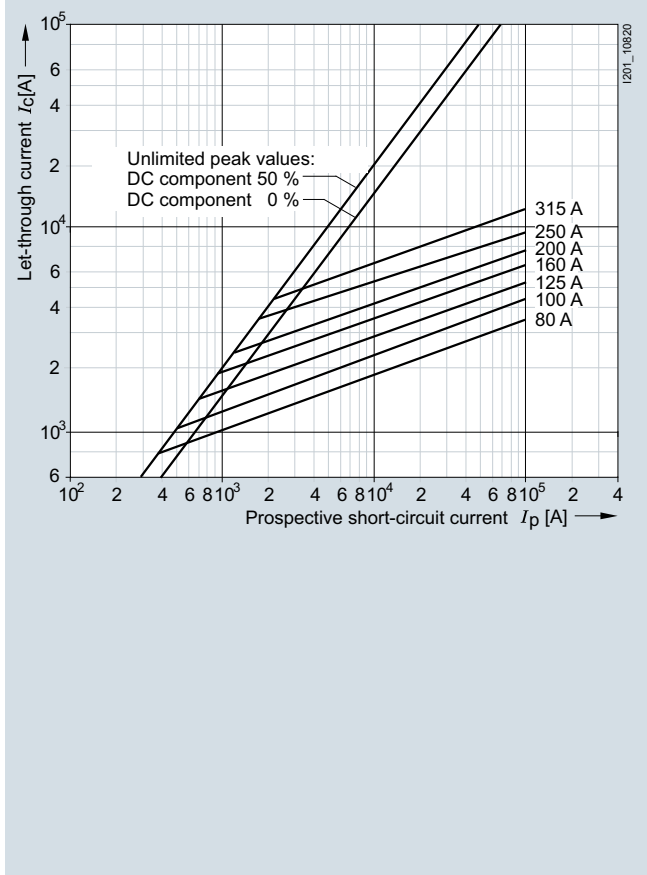

Correction factor k_A for breaking I^2t value

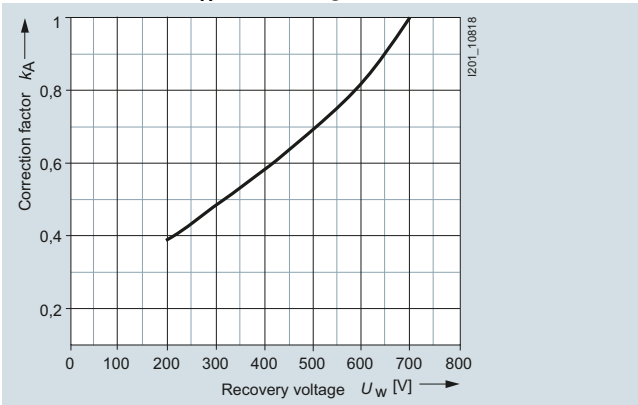

Peak arc voltage

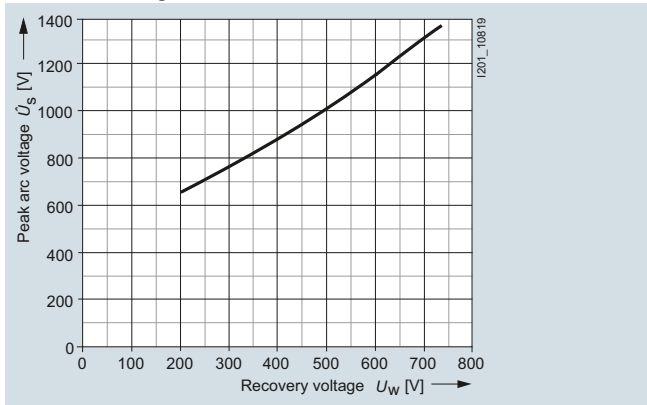

Fuse Systems

SITOR Semiconductor Fuses

LV HRC design

3NE88..-0MK series

Size: 000
 Operational class: gR/aR
 Rated voltage: 500 ... 690 V AC/440 V DC
 Rated current: 6 ... 160 A

Time/current characteristics diagram

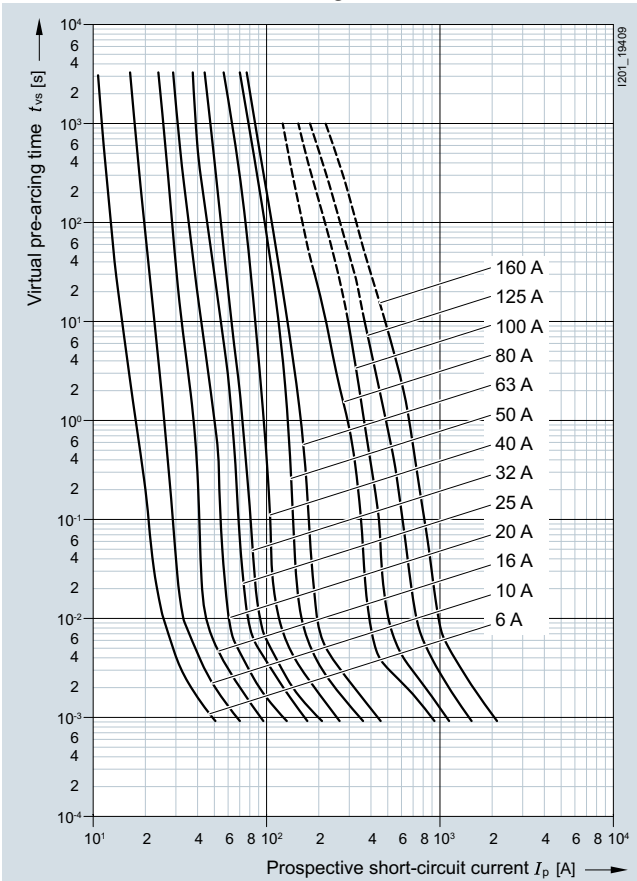

Let-through characteristics (current limitation at 50 Hz)

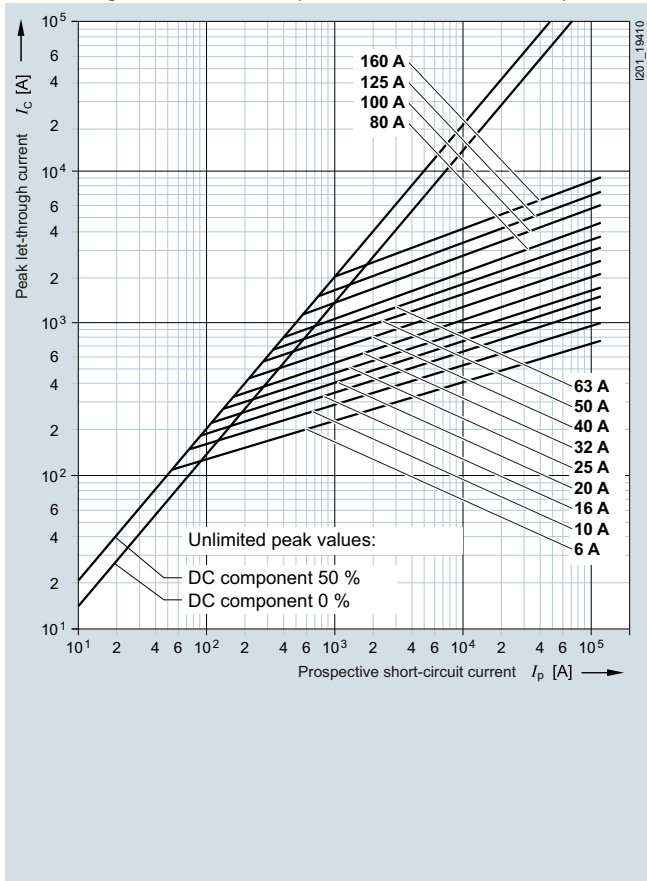

Correction factor k_A for breaking I^2t value

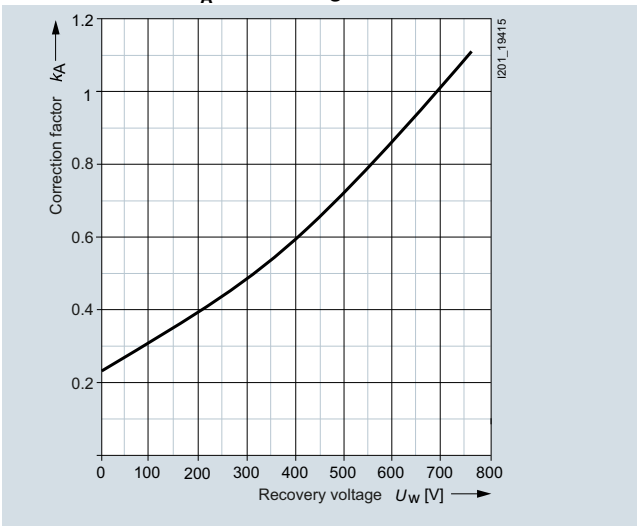

Peak arc voltage

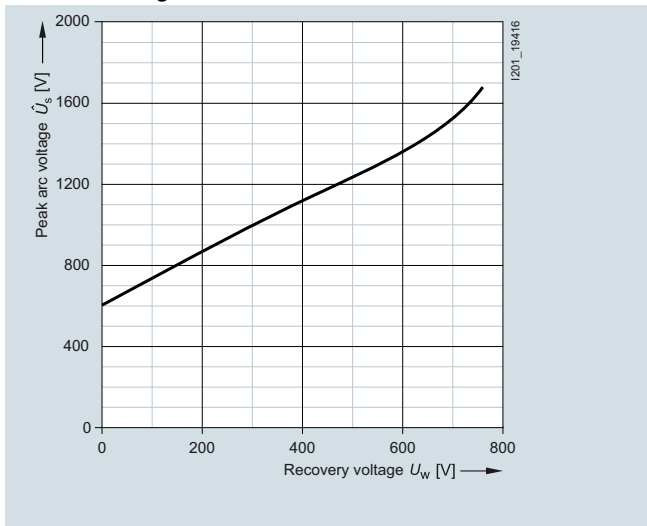

3NE93..-0MK07 series

Size: 2
Operational class: aR
Rated voltage: 3000 V DC
Rated current: 315 A

Time/current characteristics diagram

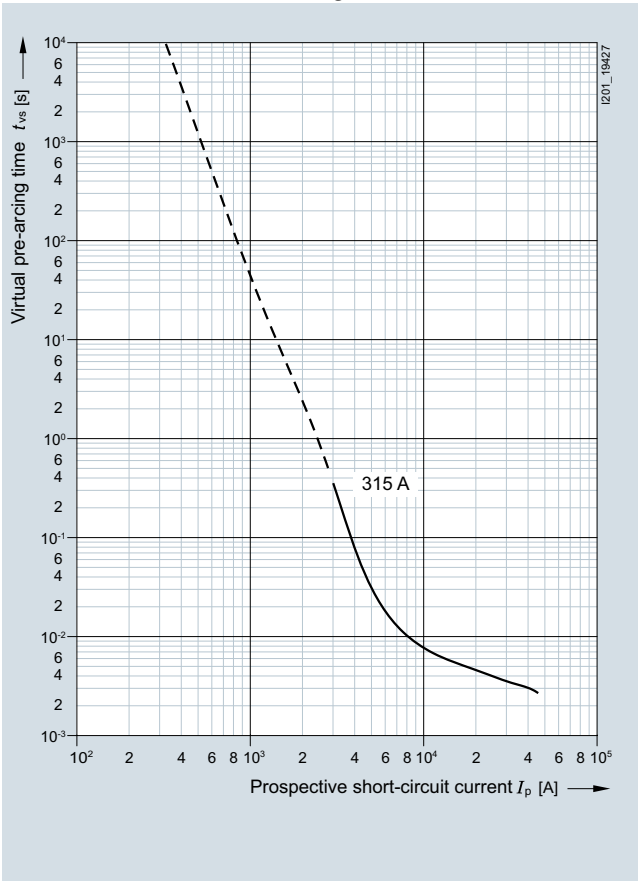

Let-through characteristics (current limitation at 50 Hz)

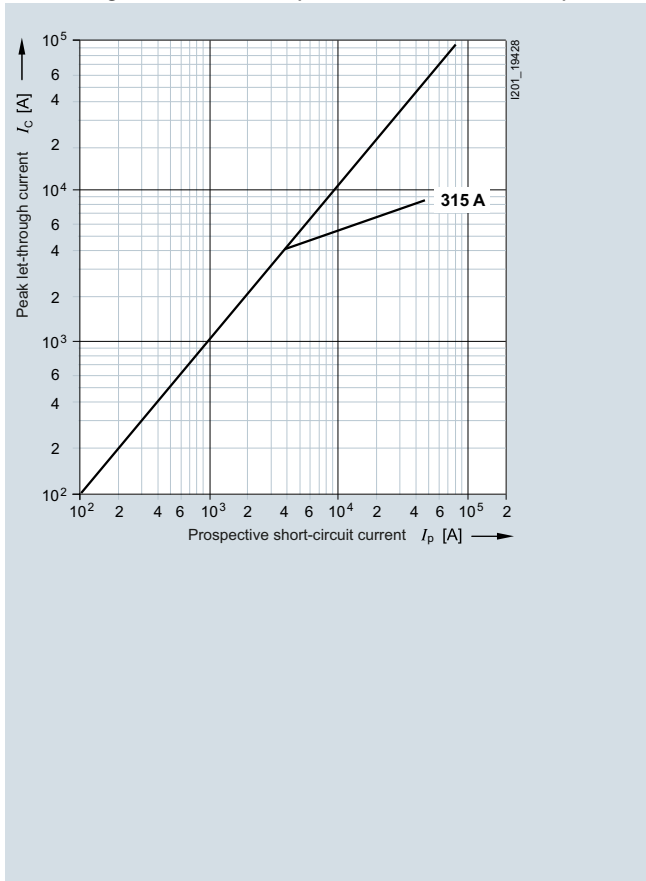

Fuse Systems

SITOR Semiconductor Fuses

LV HRC design

3NE963. series

Size: 3
 Operational class: aR
 Rated voltage: 2500 V AC
 Rated current: 400 ... 630 A

Time/current characteristics diagram

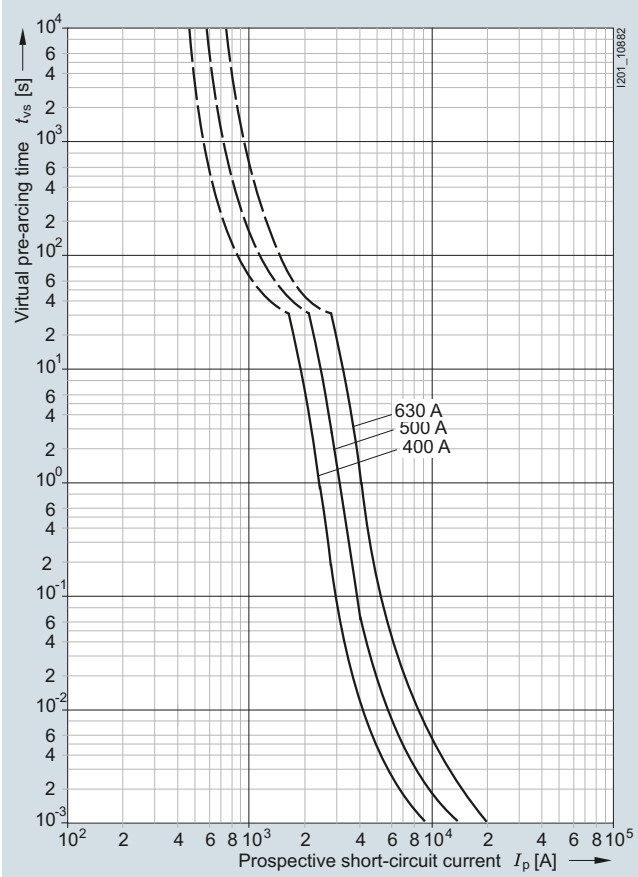

Let-through characteristics (current limitation at 50 Hz)

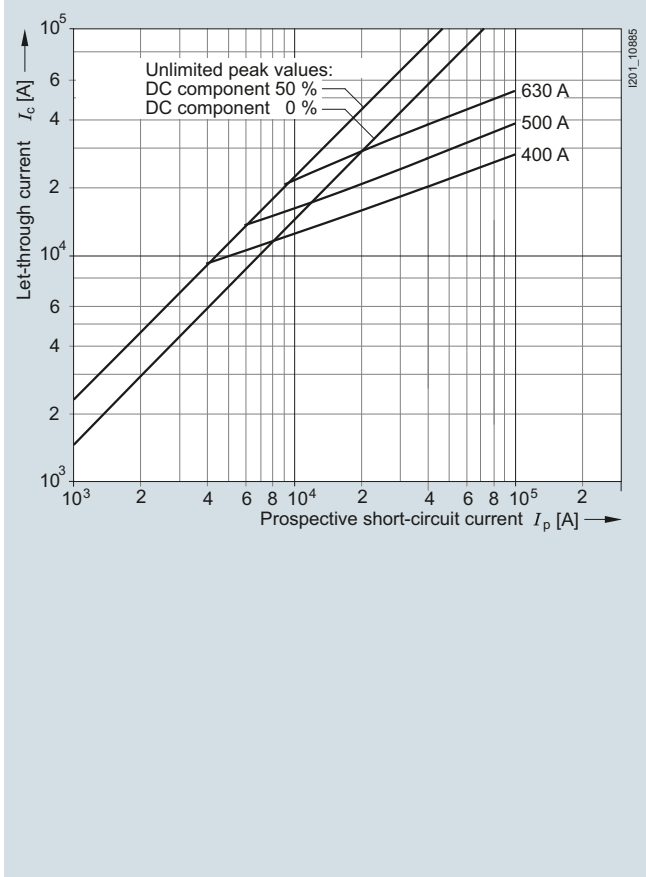

Correction factor k_A for breaking I^2t value

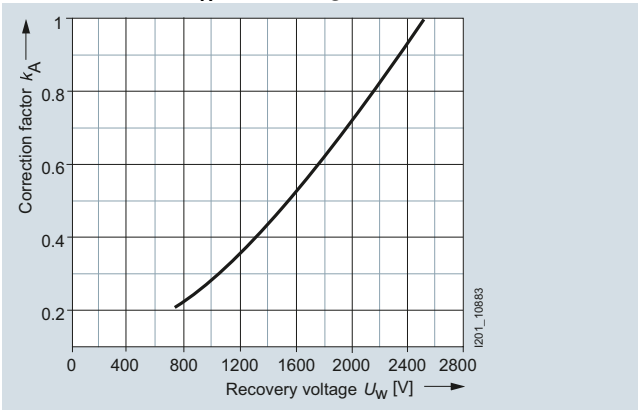

Peak arc voltage

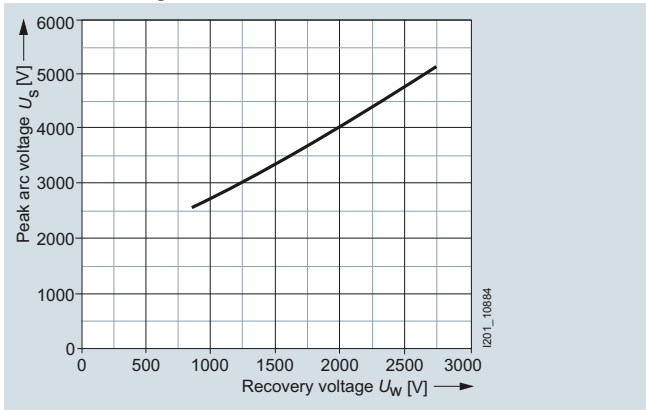

Overview

SITOR cylindrical fuses protect power semiconductors from the effects of short-circuits because the super quick-response disconnect characteristic is far quicker than that of conventional fuses. They protect expensive devices and system components such as solid-state contactors, electronic relays (solid state), converters with fuses in the input and in the DC link, UPS systems and soft starters for motors up to 100 A.

The cylindrical design is approved for industrial applications. The cylindrical fuse links comply with IEC 60269.

Cylindrical fuse holders also comply with IEC 60269 and UL 512. The cylindrical fuse holders for 10 x 38 mm and 14 x 51 mm have been tested and approved as fuse switch disconnectors and the cylindrical fuse holders for 22 x 58 mm as fuse disconnectors according to the switching device standard IEC 60947-3. The utilization category and the tested current and voltage values are specified in the Table "Technical Specifications".

The cylindrical fuse holders have been specially developed for the application of SITOR fuse links with regard to heat tolerance and heat dissipation and are therefore not recommended for standard applications.

Cylindrical fuse bases do not offer the same comprehensive touch protection as the fuse holders, but have better heat dissipation. The single-pole cylindrical fuse bases for 14 x 51 mm and 22 x 58 mm allow modular expansion to multi-pole bases.

Benefits

- Cylindrical fuses have an extremely compact design and a correspondingly small footprint
- The cylindrical fuses have IEC and UL approval and are suitable for universal use worldwide
- The use of SITOR cylindrical fuses in the cylindrical fuse holders and bases has been tested with regard to heat dissipation and maximum current loading. This makes planning and dimensioning easier and prevents consequential damage
- The use of fuse holders as switch disconnectors expands the area of application of these devices and increases operating safety

Technical specifications

	mm × mm	Cylindrical fuse holders		
		3NC10	3NC14	3NC22
Size		10 × 38	14 × 51	22 × 58
Standards		UL 4248-1; CSA C22.2; IEC 60269-2; IEC 60947-3		
Approvals		UL 4248-1; UL File Number E171267; CSA C22.2 No. 39-M, CCC		
Rated voltage U_n	V AC	690; 600 acc. to UL/CSA		
Rated current I_n	A AC	32 30 acc. to UL/CSA	50 50 acc. to UL 40 acc. to CSA	100 80 acc. to UL/CSA
Rated conditional short-circuit current	kA	50	50 (100 at 400 V)	50 (100 at 500 V)
Breaking capacity				
• Utilization category		AC-22B (400 V)	AC-22B (400 V)	AC-20B (690 V)
Max. power dissipation of the fuse link (conductor cross-section used)	W	3 (6 mm ²) 4.3 (10 mm ²)	5 (10 mm ²) 6.5 (25 mm ²)	9.5 (35 mm ²) 11 (50 mm ²)
Rated impulse withstand voltage	kV	6		
Overvoltage category		II		
Pollution degree		2		
No-voltage changing of fuse links		Yes		
Sealable when installed		Yes		
Mounting position		Any		
Current direction		Any		
Degree of protection acc. to IEC 60529		IP20		
Terminals with touch protection acc. to BGV A3 incoming and outgoing feeder		Yes		
Ambient temperature	°C	45		
Conductor cross-sections				
• Finely stranded, with end sleeve	mm ²	1.5 ... 16	1.5 ... 35	4 ... 50
• AWG (American Wire Gauge)	AWG	15 ... 5	14 ... 2	10 ... 1/0
Tightening torque				
	Nm	2.5	2.5 ... 3	3.5 ... 4
	lb.in	22	22 ... 26	31 ... 35

Fuse Systems

SITOR Semiconductor Fuses

Cylindrical fuse design

Load rating of SITOR cylindrical fuses

Cylinder	Operational class (IEC 60269)	Rated voltage U_n		Rated current I_n A	Melting I^2t value I^2t_s ($t_{vs} = 1$ ms) A ² s	Breaking I^2t value I^2t_a at U_n A ² s	Temperature rise at I_n body center K	Power dissipation at I_n W	Weight approx. kg
		V AC	V DC						
3NC1003	aR	600	700	3	3	8	30	1.2	0.01
3NC1006	aR	600	700	6	4	20	30	1.5	0.01
3NC1008	aR	600	700	8	6	30	25	2	0.01
3NC1010	aR	600	700	10	9	60	40	2.5	0.01
3NC1012	aR	600	700	12	15	110	50	3	0.01
3NC1016	aR	600	700	16	25	150	60	3.5	0.01
3NC1020	aR	600	700	20	34	200	80	4.8	0.01
3NC1025	aR	600	700	25	60	250	90	6	0.01
3NC1032	aR	600	--	32	95	500	110	7.5	0.01
3NC1401	aR	660	--	1	--	1.2	90	5	0.02
3NC1402	aR	660	--	2	--	10	30	3	0.02
3NC1403	aR	660	--	3	--	15	40	2.5	0.02
3NC1404	aR	660	--	4	--	25	50	3	0.02
3NC1405	aR	690	800	5	1.6	9	20	1.5	0.02
3NC1406	aR	690	800	6	1.4	15	47	1.5	0.02
3NC1410	aR	690	800	10	3.6	20	50	4	0.02
3NC1410-5	aR	690	600	10	3.6	90	50	4	0.02
3NC1415	aR	690	800	15	10	75	60	5.5	0.02
3NC1415-5	aR	690	600	15	9	100	60	5.5	0.02
3NC1420	aR	690	800	20	26	120	70	6	0.02
3NC1420-5	aR	690	600	20	26	500	70	6	0.02
3NC1425	aR	690	800	25	44	250	80	7	0.02
3NC1425-5	aR	690	600	25	47	400	80	7	0.02
3NC1430	aR	690	800	30	58	300	80	9	0.02
3NC1430-5	aR	690	600	30	58	500	80	9	0.02
3NC1432	aR	690	800	32	95	700	80	7.6	0.02
3NC1432-5	aR	690	600	32	68	600	80	7.6	0.02
3NC1440	aR	690	800	40	110	900	100	8	0.02
3NC1440-5	aR	690	600	40	84	900	100	8	0.02
3NC1450	aR	690	800	50	220	1800	110	9	0.02
3NC1450-5	aR	690	600	50	200	2000	110	9	0.02
3NC2200	aR	600	500	100	1250	8000	110	16	0.06
3NC2200-5	aR	600	500	100	1100	8500	110	16	0.06
3NC2220	aR	690	500	20	34	220	41	4.6	0.06
3NC2220-5	aR	690	500	20	19	240	40	5	0.06
3NC2225	aR	690	500	25	50	300	50	5.6	0.06
3NC2225-5	aR	690	500	25	34	350	50	6	0.06
3NC2232	aR	690	500	32	80	450	65	7	0.06
3NC2232-5	aR	690	500	32	54	500	65	8	0.06
3NC2240	aR	690	500	40	100	700	80	8.5	0.06
3NC2240-5	aR	690	500	40	68	800	80	9	0.06
3NC2250	aR	690	500	50	185	1350	90	9.5	0.06
3NC2250-5	aR	690	500	50	135	1500	90	9.5	0.06
3NC2263	aR	690	500	63	310	2600	100	11	0.06
3NC2263-5	aR	690	500	63	280	3000	100	11	0.06
3NC2280	aR	690	500	80	620	5500	110	13.5	0.06
3NC2280-5	aR	690	500	80	600	6000	110	13.5	0.06

MLFB	Operational class (IEC 60269)	Rated voltage U_n		Rated breaking capacity I_{1n} kA	Rated current I_n 1) A	Melting I^2t value I^2t_s ($t_{vs} = 1$ ms) A ² s	Breaking I^2t value I^2t_a at U_n A ² s	Temperature rise at I_n body center 2) K	Power dissipation at I_n 2) W	Varying load factor VL
		V AC / V DC								
3NC1006-OMK	gR	690/440	100/50	6	6	0.5	6.5	33	2.5	On request
3NC1010-OMK	gR	690/440	100/50	10	10	1.3	18	37	3.3	On request
3NC1012-OMK	gR	690/440	100/50	12	12	1.9	35	45	4	On request
3NC1016-OMK	gR	690/440	100/50	16	16	3	45	57	6	On request
3NC1020-OMK	gR	690/250	100/50	20	20	5.9	110	70	7.8	On request
3NC1025-OMK	gR	690/250	100/50	25	25	12	140	76	8.7	On request
3NC1032-OMK	gR	690/250	100/50	32	32	50	450	90	12	On request
3NC1406-OMK	gR	690/700	100/50	6	6	0.5	3.5	31	3.1	On request
3NC1410-OMK	gR	690/700	100/50	10	10	1.4	15	47	4.6	On request
3NC1416-OMK	gR	690/600	100/50	16	16	3.2	32	56	6.7	On request
3NC1420-OMK	gR	690/600	100/50	20	20	6.3	68	62	7.4	On request
3NC1425-OMK	gR	690/600	100/50	25	25	13	108	71	8.4	On request
3NC1432-OMK	gR	690/600	100/50	32	32	19	175	100	12.3	On request
3NC1440-OMK	gR	690/440	100/50	40	40	43	470	87	11.7	On request
3NC1450-OMK	gR	690/250	100/50	50	50	140	830	115	16.3	On request
3NC1463-OMK	aR	690/250	100/50	63	63	330	2.100	110	16.7	On request

MLFB	Operational class (IEC 60269)	Rated voltage U_n	Rated breaking capacity I_{1n} kA	Rated current I_n 1) A	Melting I^2t value I^2t_s ($t_{vs} = 1$ ms)	Breaking I^2t value I^2t_a at U_n	Temperature rise at I_n body center 2) K	Power dissipation at I_n 2) W	Varying load factor VL
		V AC / V DC			A ² s	A ² s			
3NC18100-OMK	gR	690/440	100/50	10	0.9	17	33	4.6	0.06
3NC18160-OMK	gR	690/440	100/50	16	3	52	31	5.2	0.06
3NC18200-OMK	gR	690/440	100/50	20	5.3	90	35	6.8	0.06
3NC18250-OMK	gR	690/440	100/50	25	8.3	160	43	8.7	0.06
3NC18320-OMK	gR	690/440	100/50	32	21	400	49	9.8	0.06
3NC18400-OMK	gR	690/440	100/50	40	33	600	52	11	0.06
3NC18500-OMK	gR	690/440	100/50	50	65	1.250	53	1 3.8	0.06
3NC2200-OMK	gR	690/700	100/50	25	13	180	38	8.1	On request
3NC2211-OMK	gR	690/600	100/50	32	25	420	41	9	On request
3NC2225-OMK	gR	690/440	100/50	40	42	700	50	12.5	On request
3NC2232-OMK	gR	690/250	100/50	50	74	1.250	63	15.2	On request
3NC2240-OMK	gR	690/250	100/50	63	94	2400	64	17.5	On request
3NC2250-OMK	gR	690/250	100/50	80	320	4400	72	23	On request
3NC2263-OMK	gR	690/250	100/50	100	850	11500	79	28.1	On request
3NC2280-OMK	aR	690/250	100/50	125	1500	29000	88	35.3	On request
3NC2301-OMK	gS	1500/1000	30/50	1	0.1	2	9	2	On request
3NC2302-OMK	gS	1500/1000	30/50	2	1	4.4	14	2.5	On request
3NC2304-OMK	gS	1500/1000	30/50	4	7	55	21	5.3	On request
3NC2306-OMK	gS	1500/1000	30/50	6	8	150	26	6.4	On request
3NC2310-OMK	gS	1500/1000	30/50	10	90	540	17	3.1	On request
3NC2316-OMK	gS	1500/1000	30/50	16	310	1120	1	4.7	On request
3NC2320-OMK	gS	1500/1000	30/50	20	570	2850	25	5.4	On request
3NC2325-OMK	gS	1500/1000	30/50	25	910	3300	33	6.9	On request
3NC2332-OMK	gS	1500/1000	30/50	32	2650	9050	31	6.7	On request
3NC2340-OMK	gR	1500/1000	30/50	40	3260	12800	38	9.4	On request
3NC2350-OMK	gR	1500/1000	30/50	50	6480	26000	46	11.6	On request
3NC26250MK	gR	690/440	100/50	25	8	120	40	9.5	On request
3NC26320MK	gR	690/440	100/50	32	14.5	190	54	12.3	On request
3NC26400MK	gR	690/440	100/50	40	21	400	64	14.8	On request
3NC26500MK	gR	690/440	100/50	50	48	950	66	17.5	On request
3NC26630MK	gR	690/440	100/50	63	108	2,050	68	18.8	On request
3NC26800MK	aR	690/440	100/50	80	205	3500	62	22.5	On request
3NC26000MK	aR	690/440	100/50	100	340	5400	70	31.5	On request
3NC26110MK	aR	690/440	100/50	125	645	11800	88	39	On request

Fuse Systems

SITOR Semiconductor Fuses

Cylindrical fuse design

Load rating of SITOR cylindrical fuses without strikers in fuse holders - can be used as fuse switch disconnectors ¹⁾

For SITOR fuse links	Rated voltage	Rated current	Required conductor cross-section	Fuse holders – can be used as fuse switch disconnectors ¹⁾					
				1-pole Type	$I_{max}^{2)}$	2-pole Type	$I_{max}^{2)}$	3-pole Type	$I_{max}^{2)}$
	V AC/V DC	A	Cu mm ²		A		A		A
Size 10 x 38 mm									
3NC1003	600/700	3	1	3NC1091	3	3NC1092/ 2 x 3NC1091	3	3NC1093/ 3 x 3NC1091	3
3NC1006		6	1		6		6		6
3NC1008		8	1		8		8		8
3NC1010		10	1.5		10		10		10
3NC1012		12	1.5		12		12		12
3NC1016		16	2.5		16		16		16
3NC1020		20	2.5		20		20		20
3NC1025		25	4		25		24		22
3NC1032	600/--	32	6		32		30		28

For footnotes, see next page.

For SITOR fuse links	Rated voltage V AC/V DC	Rated current I_n A	Required conductor cross-section Cu mm ²	Fuse holders – can be used as fuse switch disconnectors ¹⁾						
				1-pole		2-pole		3-pole		
				Type	$I_{max}^{2)}$ A	Type	$I_{max}^{2)}$ A	Type	$I_{max}^{2)}$ A	
Size 14 × 51 mm										
3NC1401	660	1	1	3NC1491	1	3NC1492/ 2 × 3NC1491	1	3NC1493/ 3 × 3NC1491	1	
3NC1402		2	1		2		2			
3NC1403		3	1		3		3			
3NC1404		4	1		4		4			
3NC1405	690/800	5	1	5	5	5				
3NC1406		6	1	6	6					
3NC1410		10	1.5	10	10					
3NC1415		15	1.5	15	15					
3NC1420		20	2.5	20	20					
3NC1425		25	4	25	24					
3NC1430	30	6	28	27						
3NC1432	32	6	32	32						
3NC1440	40	10	40	39						
3NC1450	50	10	48	46						
Size 22 × 58 mm										
3NC2220	690/500	20	2.5	3NC2291	20	3NC2292/ 2 × 3NC2291	20	3NC2293/ 3 × 3NC2291	20	
3NC2225		25	4		25		25			
3NC2232		32	6		32		32			
3NC2240		40	10		40		39			
3NC2250		50	10		50		48			
3NC2263		63	16		60		58			
3NC2280	80	25	74	71						
3NC2200	600/500	100	35	95	90	85				

Fuse tongs: 3NC1000.

- ¹⁾ Fuse holders acc. to IEC 60269-3, UL 512
 Fuse switch disconnectors (10 × 38, 14 × 51 mm) acc. to IEC 60947-3
 Fuse switch disconnectors (22 × 58 mm) acc. to IEC 60947-3

- ²⁾ The I_{max} values apply to "stand-alone operation". If several devices are butt-mounted and/or subject to unfavorable cooling conditions, these values may be reduced still further. With a larger conductor cross-section, values higher than I_{max} are possible.

Load rating of SITOR cylindrical fuses with strikers in fuse holders – can be used as fuse switch disconnectors ¹⁾

For SITOR fuse links	Rated voltage V AC	Rated current I_n A	Required conductor cross-section Cu mm ²	Fuse holders – can be used as fuse switch disconnectors ¹⁾					
				1-pole		2-pole		3-pole	
				Type	$I_{max}^{2)}$ A	Type	$I_{max}^{2)}$ A	Type	$I_{max}^{2)}$ A
Size 14 × 51 mm									
3NC1410-5	690/600	10	1.5	3NC1491	10	3NC1492/ 2 × 3NC1491-5	10	3NC1493/ 3 × 3NC1491-5	10
3NC1415-5		15	1.5		15		15		
3NC1420-5		20	2.5		20		20		
3NC1425-5		25	4		25		25		
3NC1430-5		30	6		30		30		
3NC1432-5		32	6		32		32		
3NC1440-5		40	10		38		35		
3NC1450-5		50	10		48		46		
Size 22 × 58 mm									
3NC2220-5	690/500	20	2.5	3NC2291	20	3NC2292/ 2 × 3NC2291-5	20	3NC2293/ 3 × 3NC2291-5	20
3NC2225-5		25	4		25		25		
3NC2232-5		32	6		32		31		
3NC2240-5		40	10		40		39		
3NC2250-5		50	10		45		43		
3NC2263-5		63	16		59		55		
3NC2280-5	80	25	71	69					
3NC2200-5	600/500	100	35	94	90	85			

- ¹⁾ Fuse holders acc. to IEC 60269-3, UL 512
 Fuse switch disconnectors (10 × 38, 14 × 51 mm) acc. to IEC 60947-3
 Fuse switch disconnectors (22 × 58 mm) acc. to IEC 60947-3

- ²⁾ The I_{max} values apply to "stand-alone operation". If several devices are butt-mounted and/or subject to unfavorable cooling conditions, these values may be reduced still further. With a larger conductor cross-section, values higher than I_{max} are possible.

Fuse Systems

SITOR Semiconductor Fuses

Cylindrical fuse design

Dimensional drawings

Cylindrical fuse links

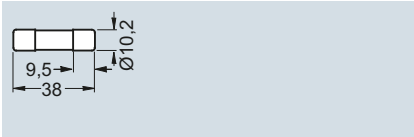

3NC10..., 3NC10...-0MK

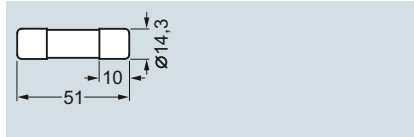

3NC14..., 3NC14...-0MK

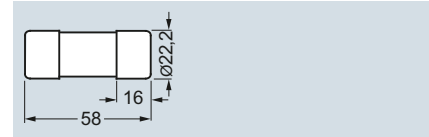

3NC22..., 3NC22...-0MK

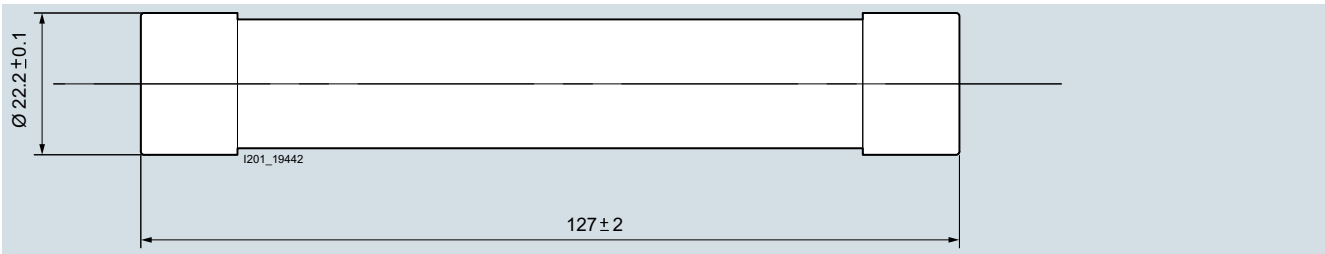

3NC23...-0MK

Cylindrical fuse holders

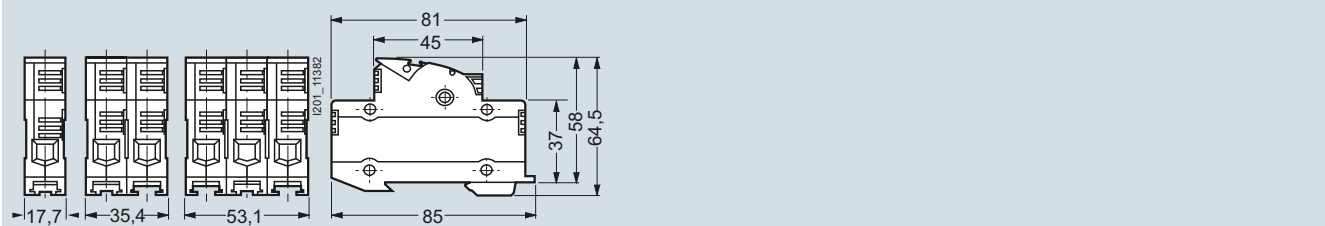

3NC109.

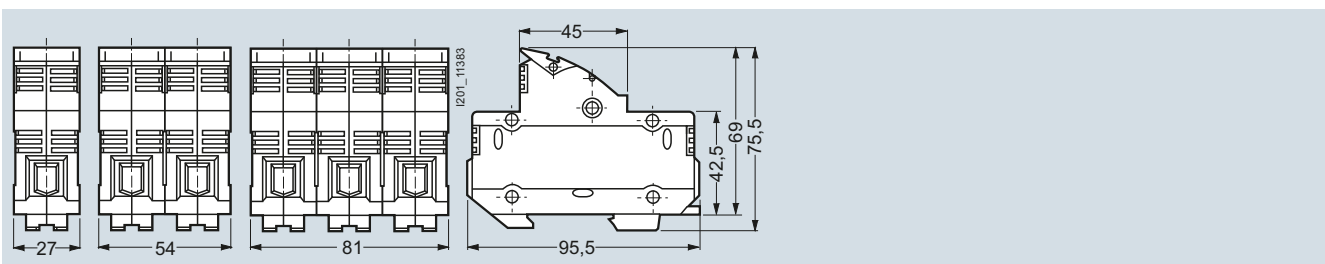

3NC149.

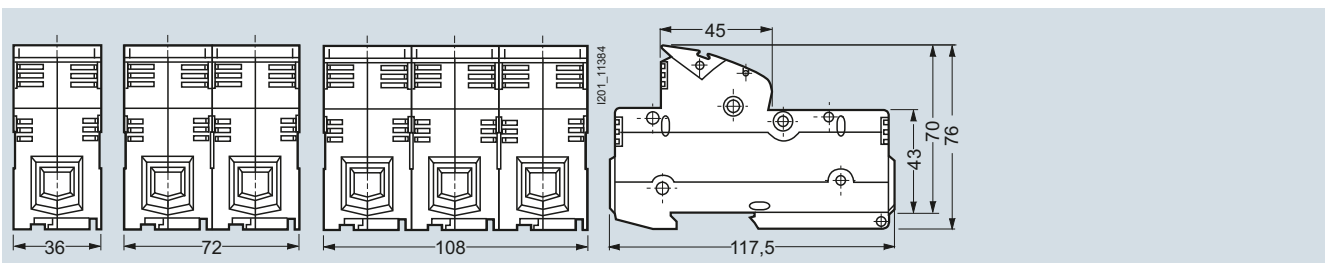

3NC129.

Cylindrical fuse holders with signaling switch

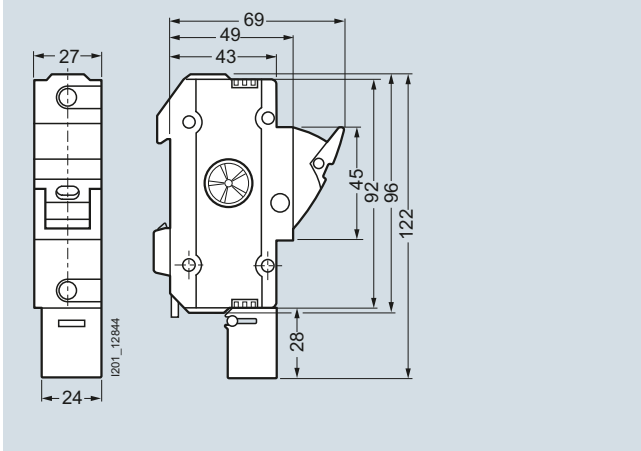

3NC1491-5

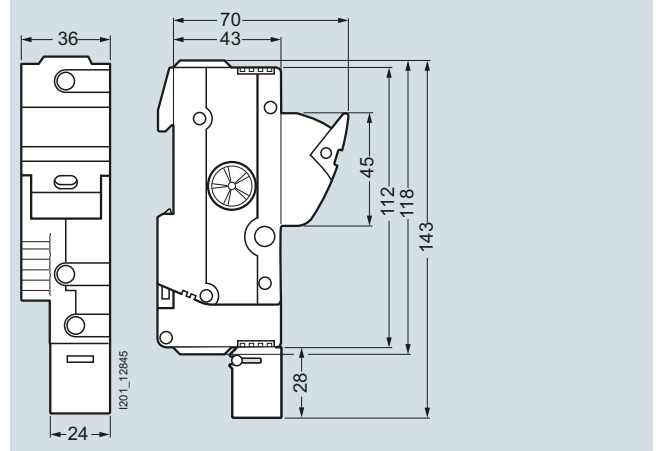

3NC1291-5

Cylindrical fuse bases

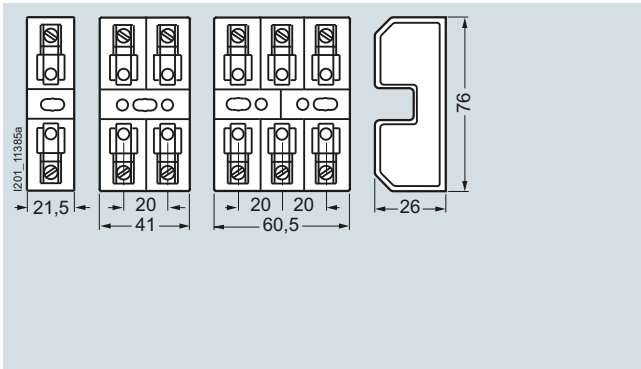

3NC1038-1 to 3NC1038-3

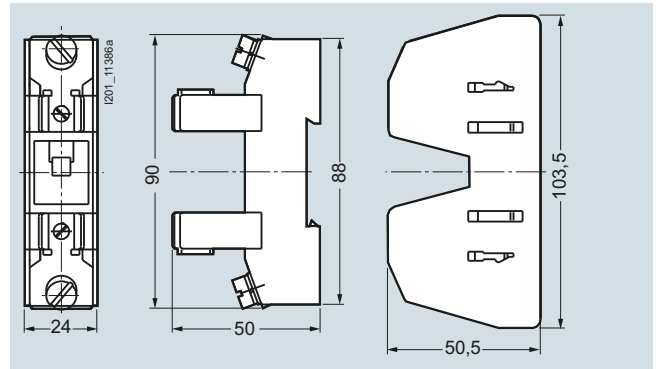

3NC1451-1

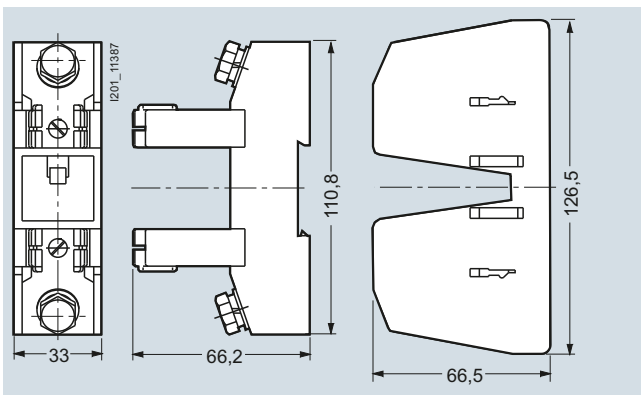

3NC2258-1

Fuse Systems

SITOR Semiconductor Fuses

Cylindrical fuse design

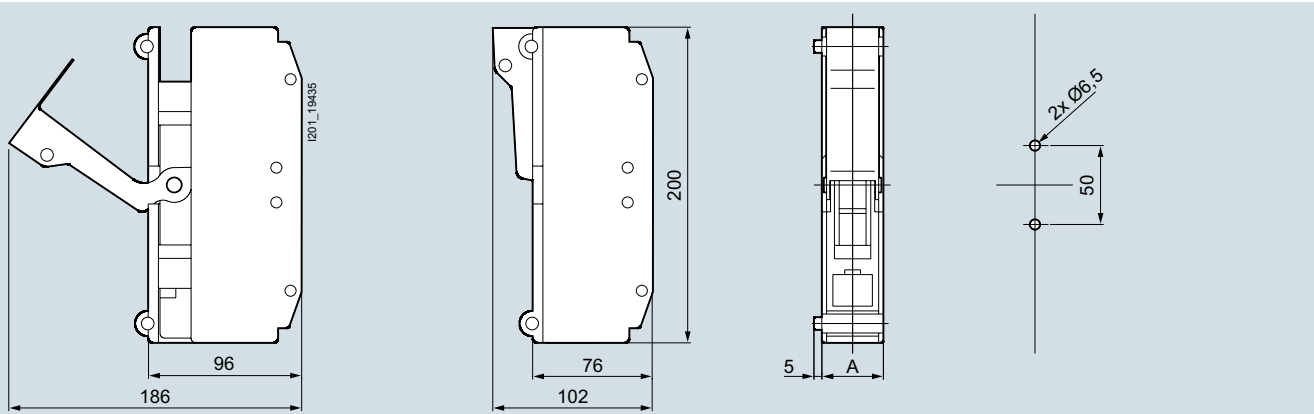

Type	Dimensions
	A
3NC2391-0MK	40
3NC2392-0MK	80
3NC2393-0MK	120

3NC239.-0MK

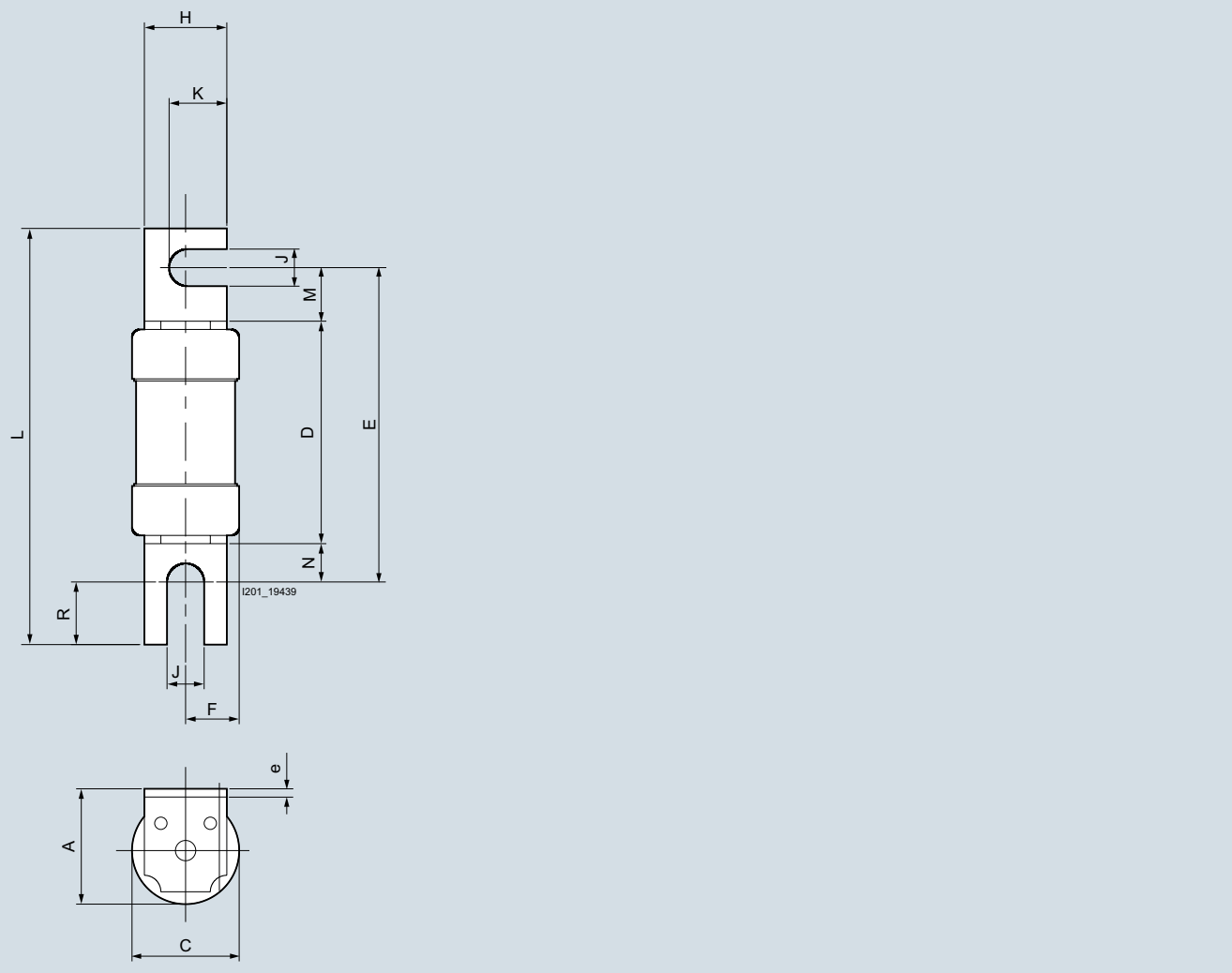

Type	Dimensions												
	ØC	A	D	E	F	H	K	L	M	N	R	e	
3NC18.-0MK	18	19	52,2	71,5	9	12	9	88	12	7	14	1,4	
3NC26.-0MK	26	29	53,5	75,8	13	19	14	103	13	9,3	19,7	2	

3NC18.-0MK, 3NC26.-0MK

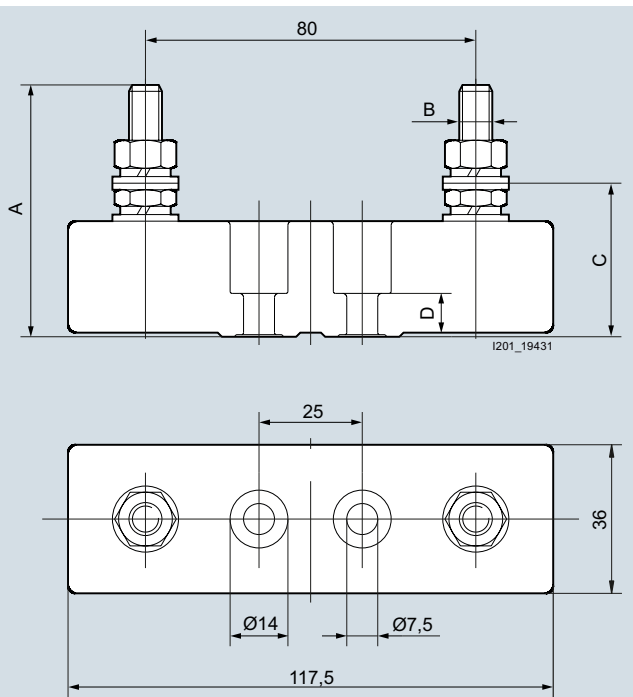

Type	Dimensions			
	A	B	C	D
3NH5023	59	M8	35,5	11
3NH5323	64	M10	38	11

3NH5023

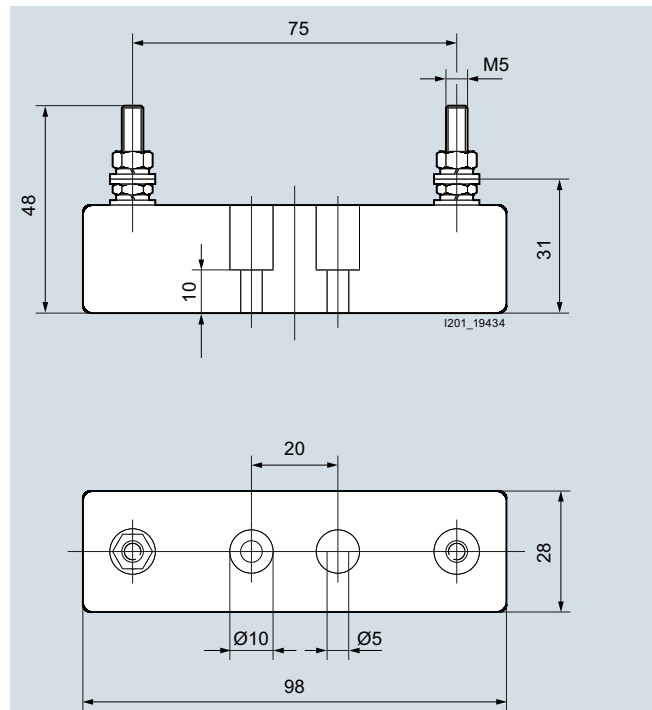

3NH5723

Fuse Systems

SITOR Semiconductor Fuses

Cylindrical fuse design

Characteristic curves

3NC10 series

Size: 10 × 38 mm
 Operational class: aR
 Rated voltage: 600 V AC/700 V DC, 3 ... 25 A
 600 V AC, 32 A
 Rated current: 3 ... 32 A

Time/current characteristics diagram

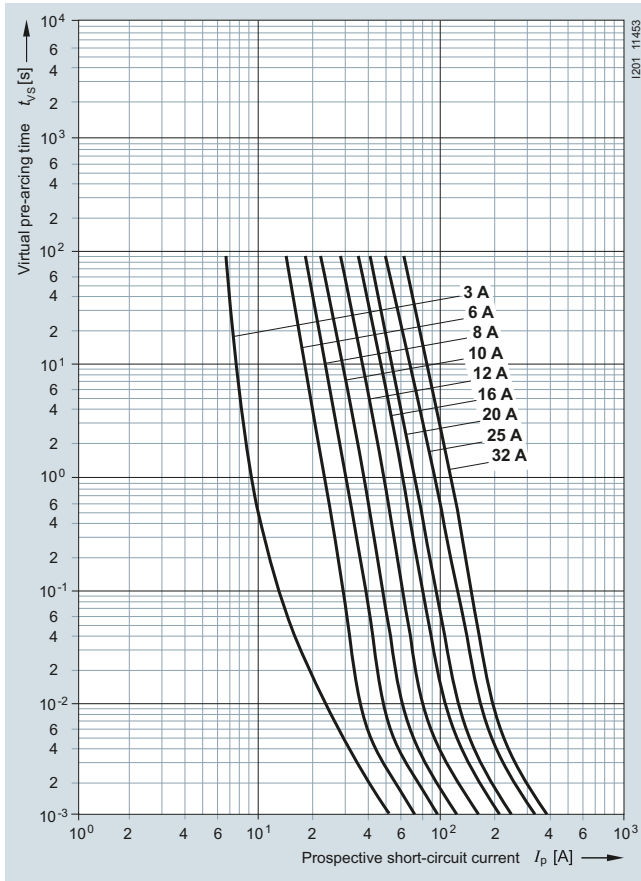

Let-through characteristics (current limitation at 50 Hz)

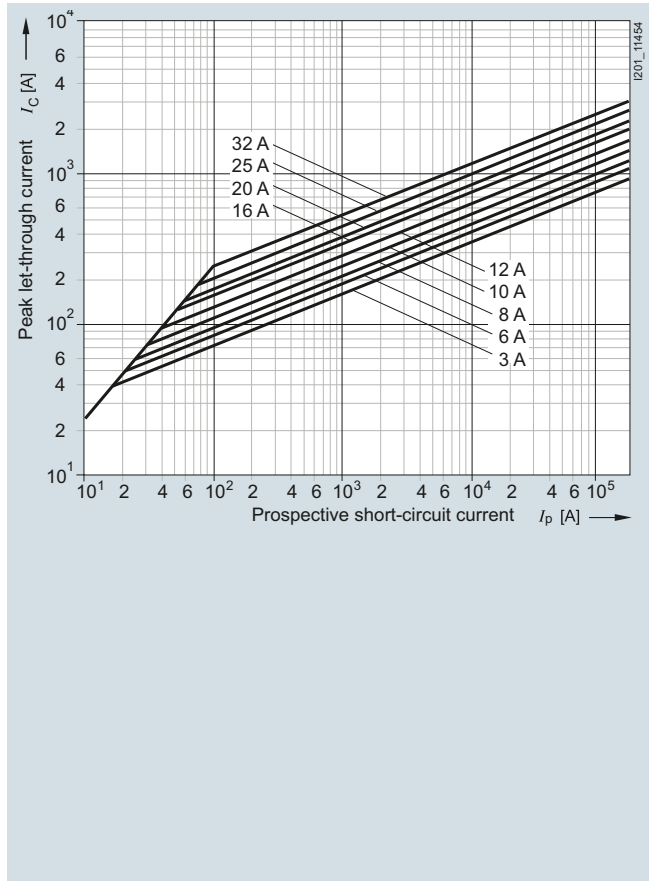

Correction factor k_A for breaking I^2t value

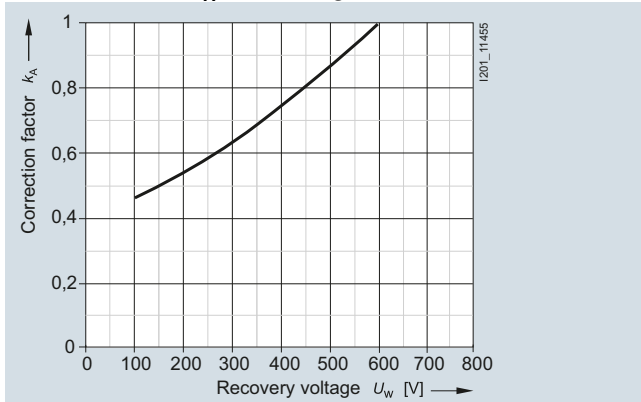

Peak arc voltage

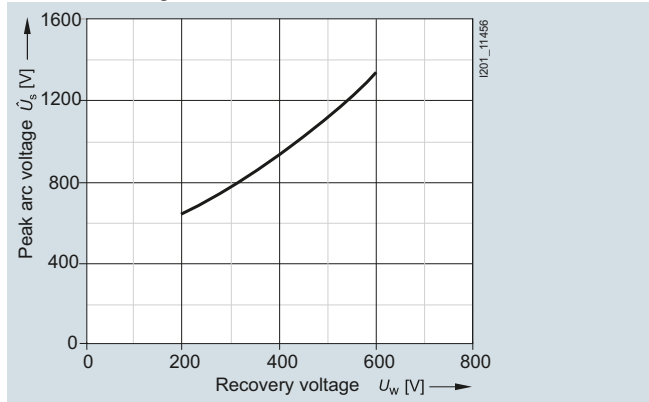

3NC10..-0MK series

Size: 10 × 38 mm
Operational class: gR
Rated voltage: 690 V AC; 250 ... 400 V DC
Rated current: 6 ... 32 A

Time/current characteristics diagram

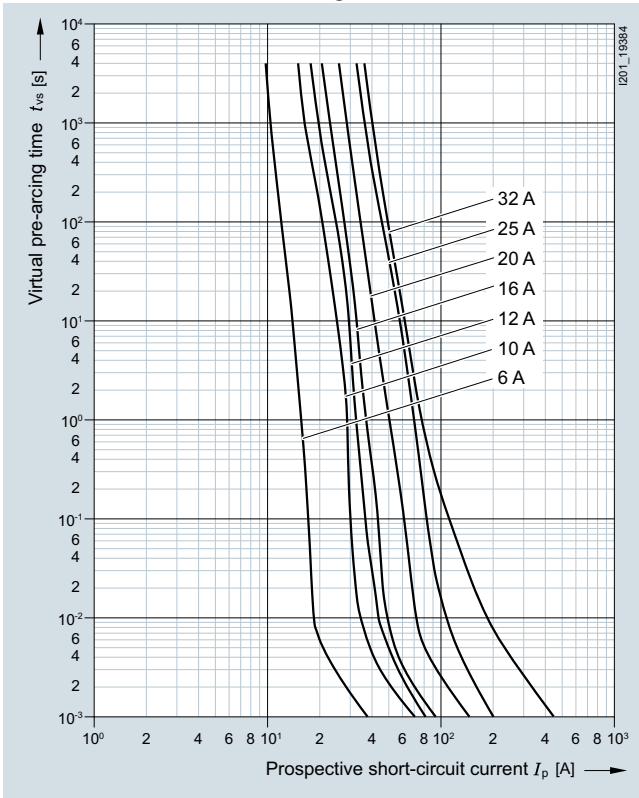

Let-through characteristics (current limitation at 50 Hz)

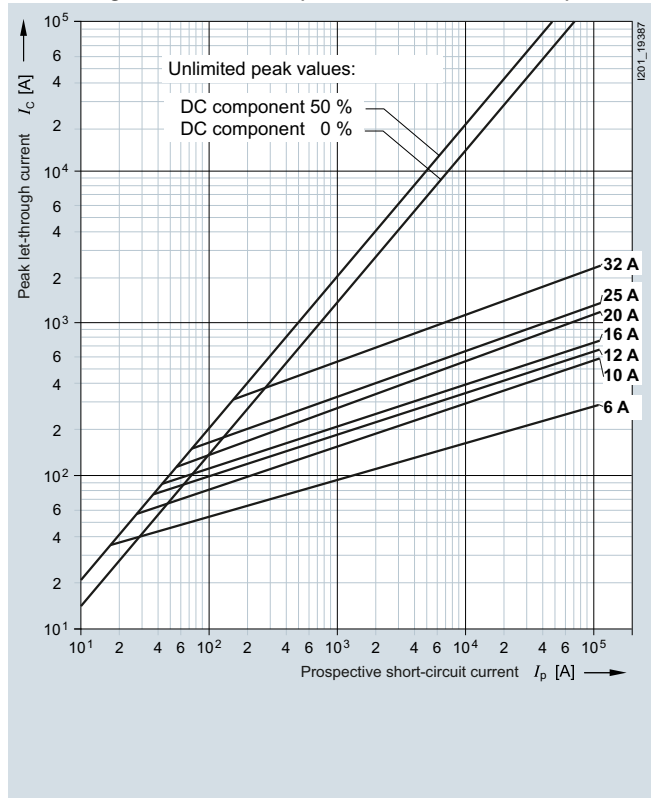

Correction factor k_A for breaking I^2t value

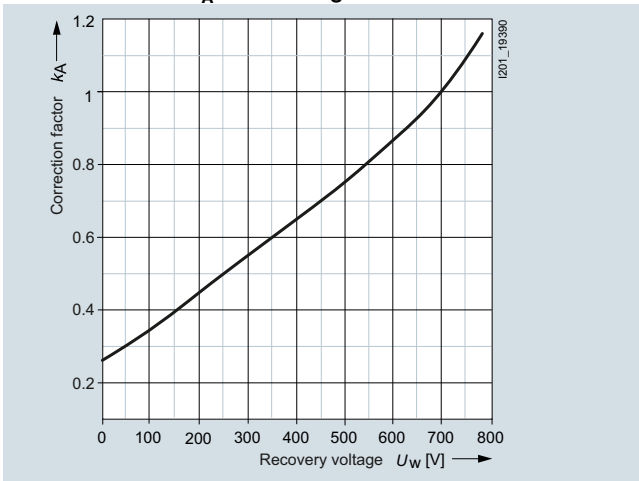

Peak arc voltage

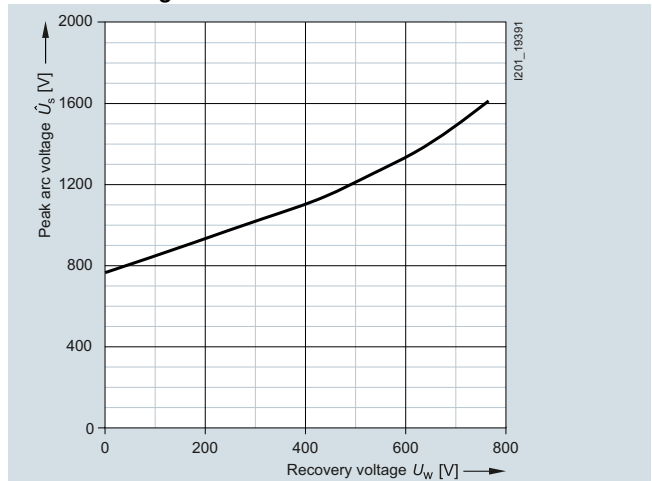

Fuse Systems

SITOR Semiconductor Fuses

Cylindrical fuse design

3NC14 series

Size: 14 × 51 mm
 Operational class: aR
 Rated voltage: 660 V AC (1 ... 4 A);
 690 V AC/800 V DC (5 ... 50 A)
 Rated current: 1 ... 10 A

Time/current characteristics diagram

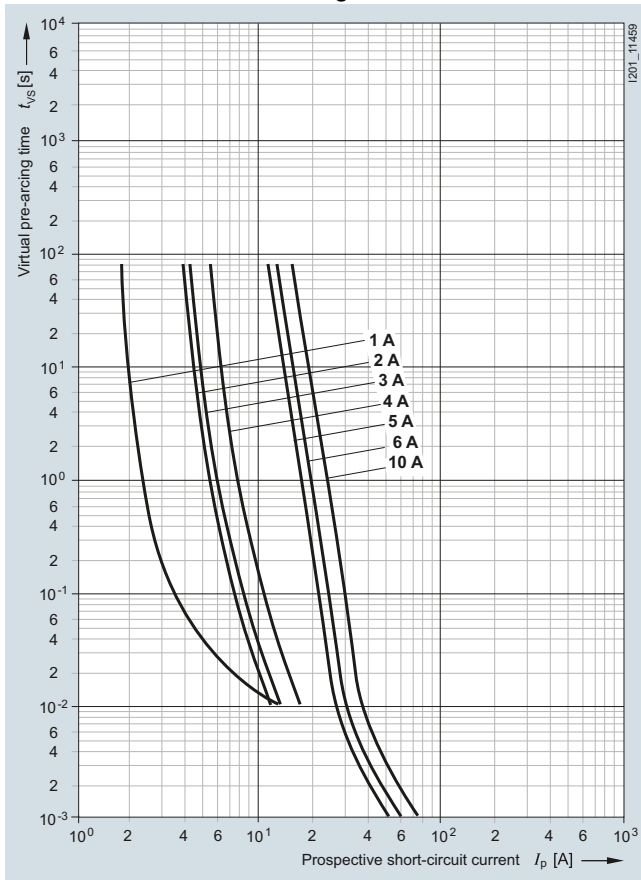

Let-through characteristics (current limitation at 50 Hz)

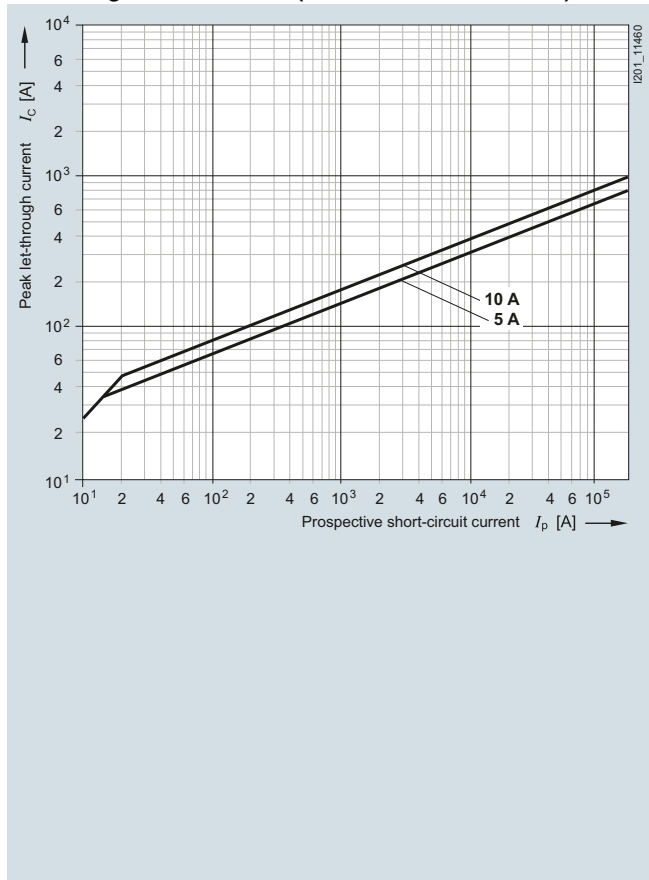

Correction factor k_A for breaking I^2t value

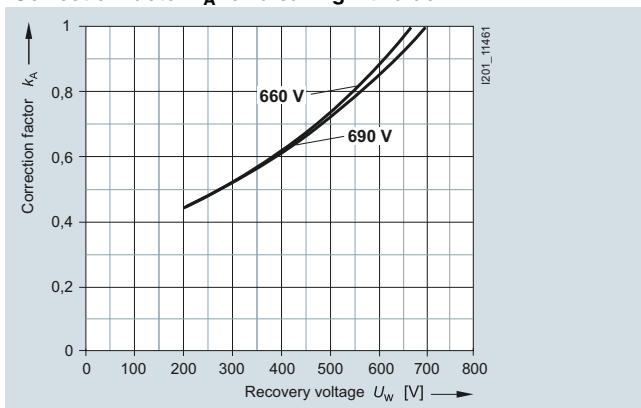

Peak arc voltage

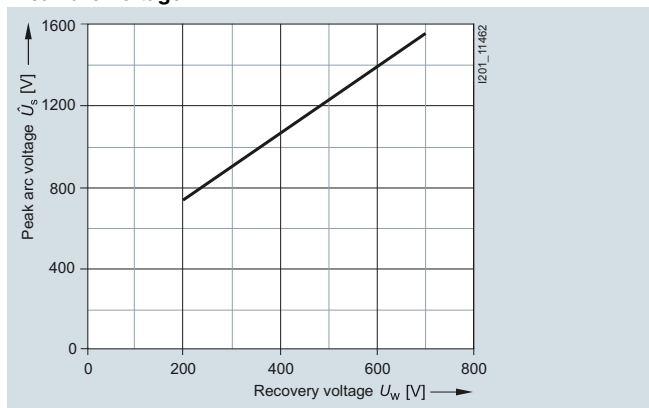

3NC14 series

Size: 14 × 51 mm
 Operational class: aR
 Rated voltage: 660 V AC (1 ... 4 A);
 690 V AC/800 V DC (5 ... 50 A)
 Rated current: 15 ... 50 A

Time/current characteristics diagram

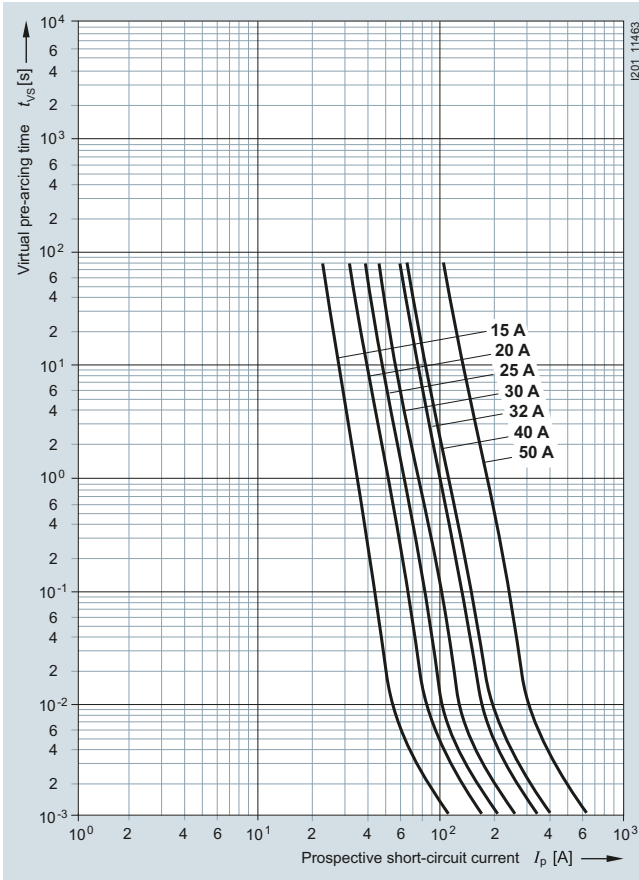

Let-through characteristics (current limitation at 50 Hz)

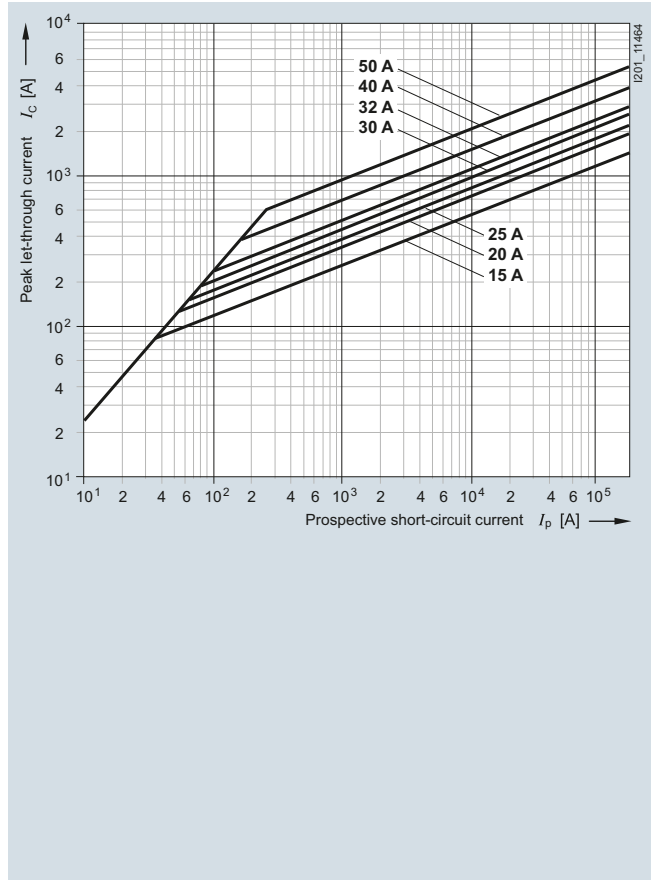

Correction factor k_A for breaking I^2t value

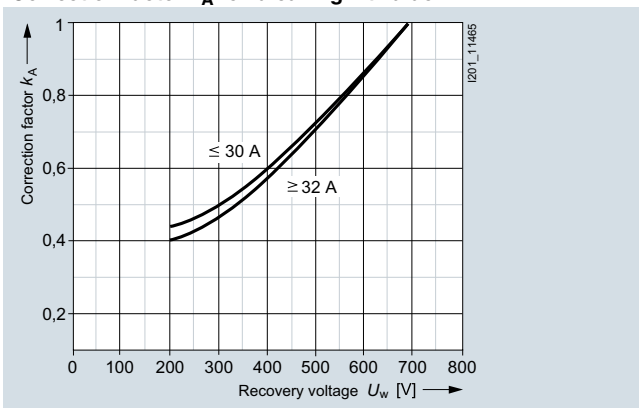

Peak arc voltage

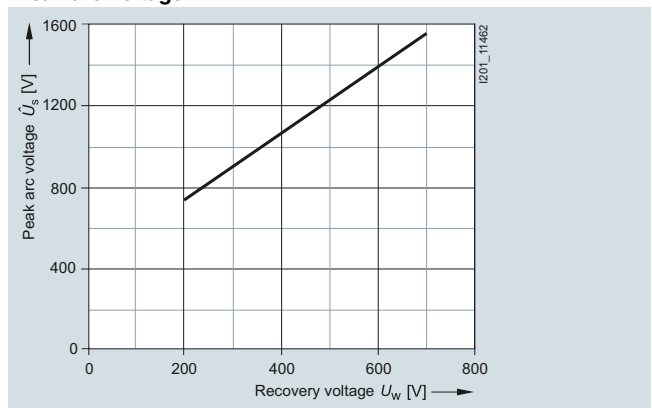

Fuse Systems

SITOR Semiconductor Fuses

Cylindrical fuse design

3NC14..-0MK series

Size: 14 × 51 mm
 Operational class: gR, aR
 Rated voltage: 690 V AC; 250 ... 700 V DC
 Rated current: 6 ... 63 A

Time/current characteristics diagram

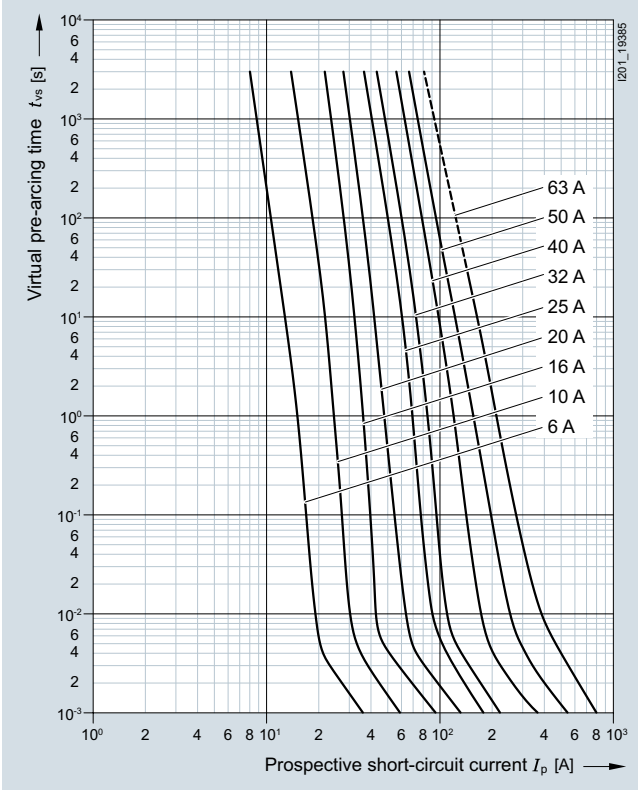

Let-through characteristics (current limitation at 50 Hz)

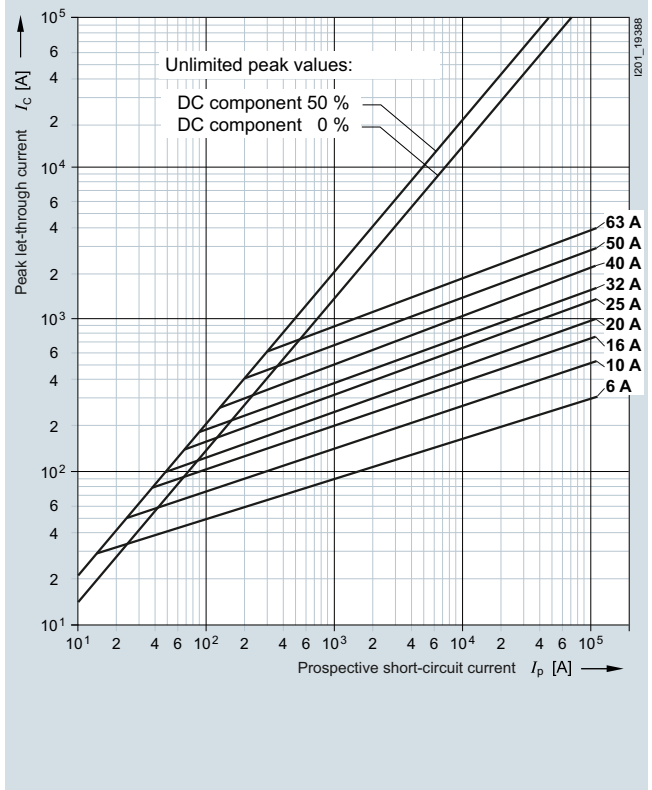

Correction factor k_A for breaking I^2t value



Peak arc voltage

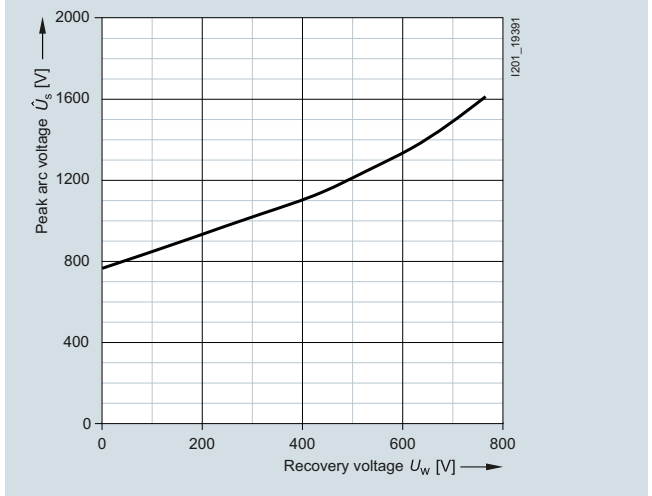

3NC14..-5 series with striking pin

Size: 14 × 51 mm
Operational class: aR
Rated voltage: 690 V AC/600 V DC
Rated current: 10 ... 50 A

Time/current characteristics diagram

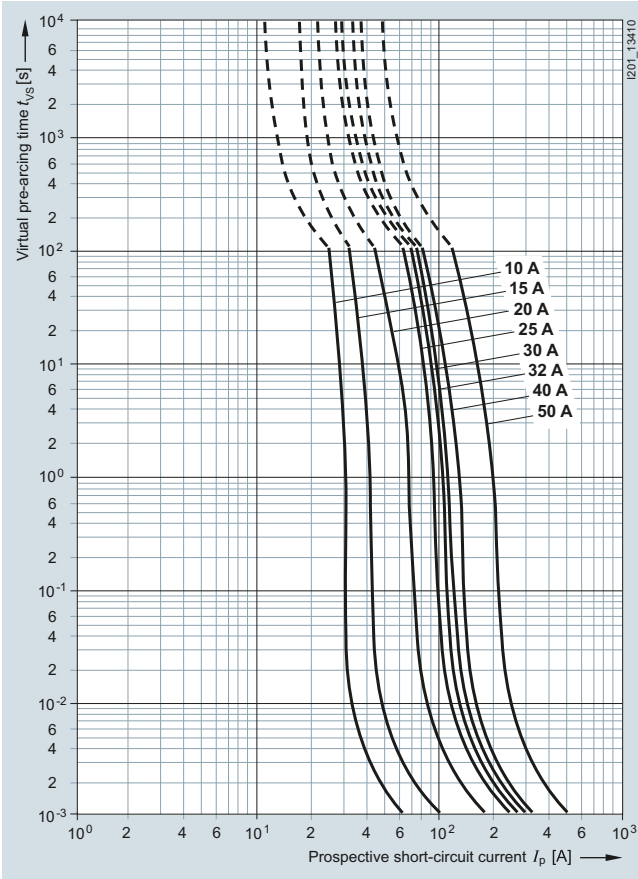

Let-through characteristics (current limitation at 50 Hz)

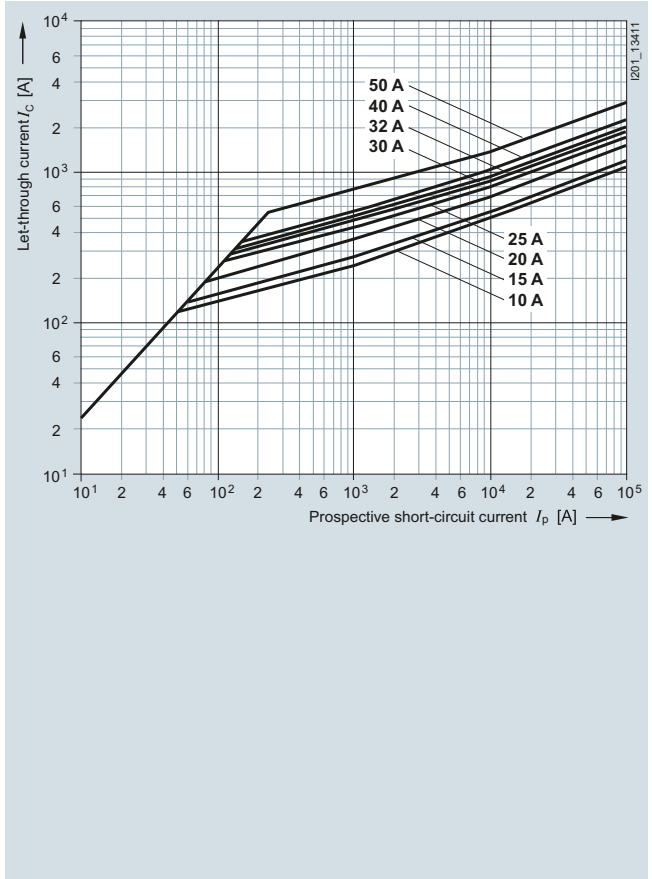

Correction factor k_A for breaking I^2t value

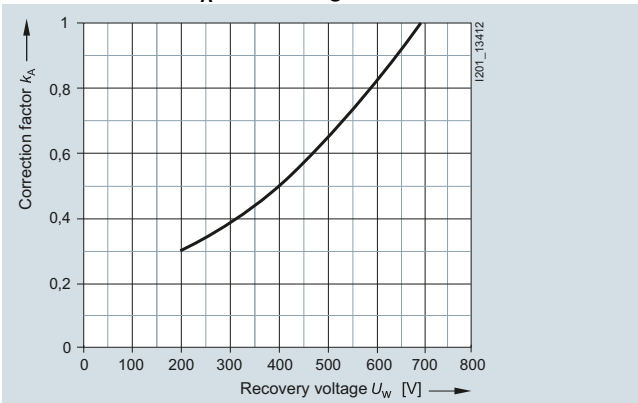

Peak arc voltage

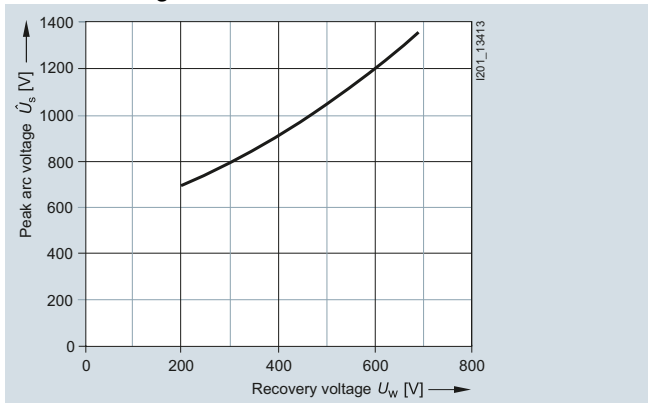

Fuse Systems

SITOR Semiconductor Fuses

Cylindrical fuse design

3NC18..-0MK series

Size: 18 × 88 mm
 Operational class: gR
 Rated voltage: 690 V AC/440 V DC
 Rated current: 10 ... 50 A

Time/current characteristics diagram

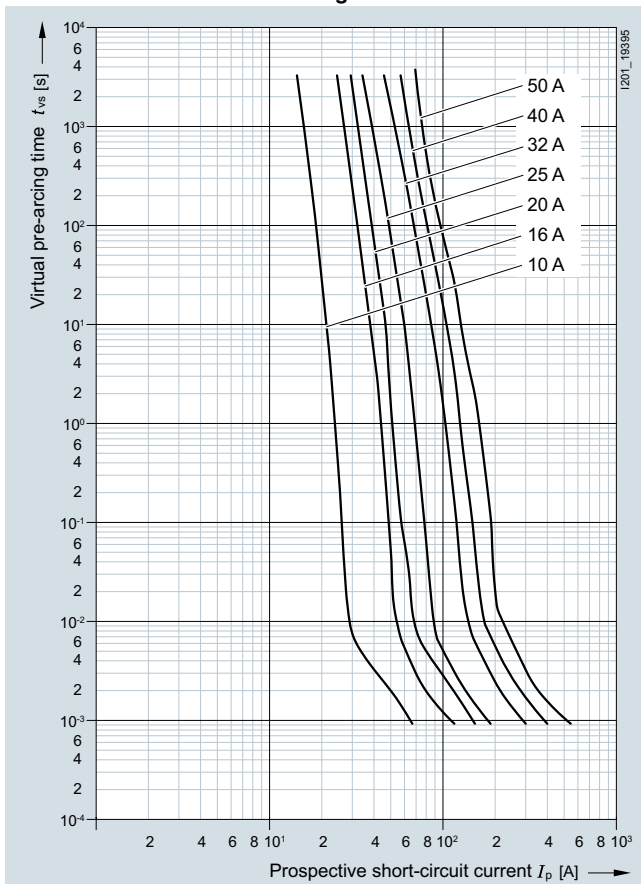

Let-through characteristics (current limitation at 50 Hz)

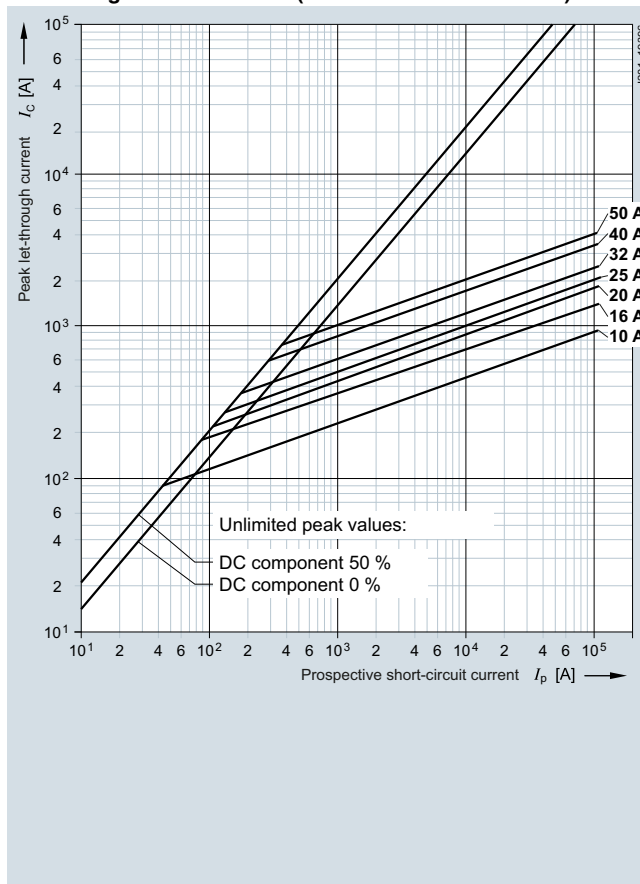

Correction factor k_A for breaking I^2t value

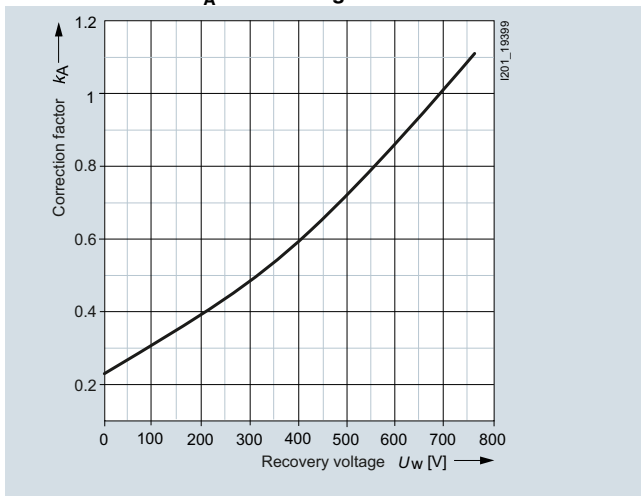

Peak arc voltage

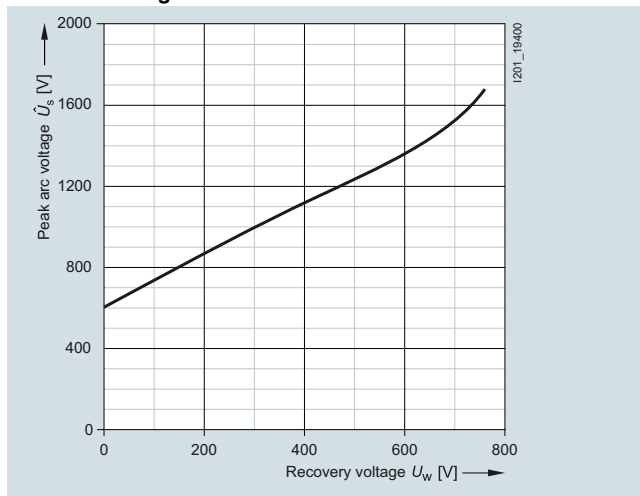

3NC22 series

Size: 22 × 58 mm
 Operational class: aR
 Rated voltage: 690 V AC/500 V DC (20 ... 80 A);
 600 V AC/500 V DC (100 A)
 Rated current: 20 ... 100 A

Time/current characteristics diagram

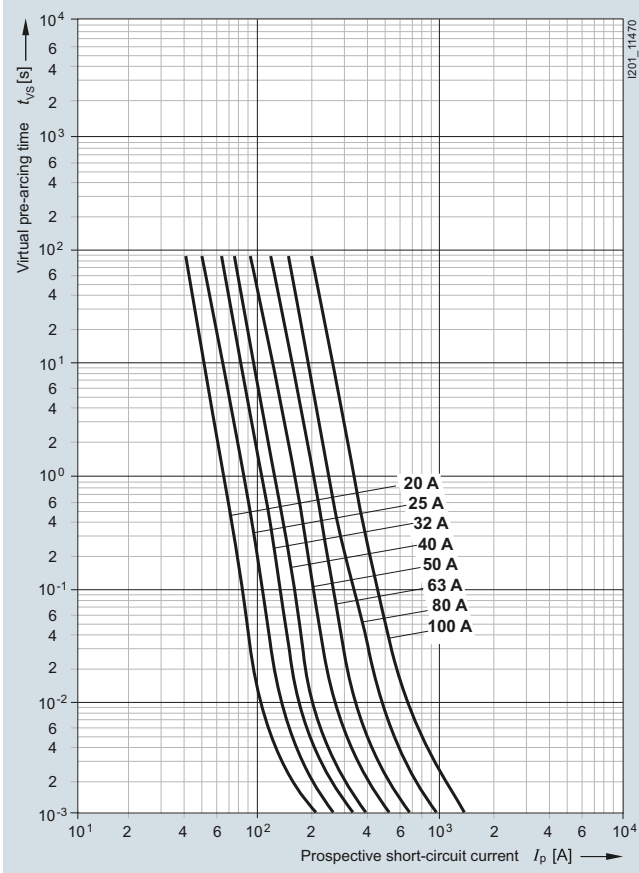

Let-through characteristics (current limitation at 50 Hz)

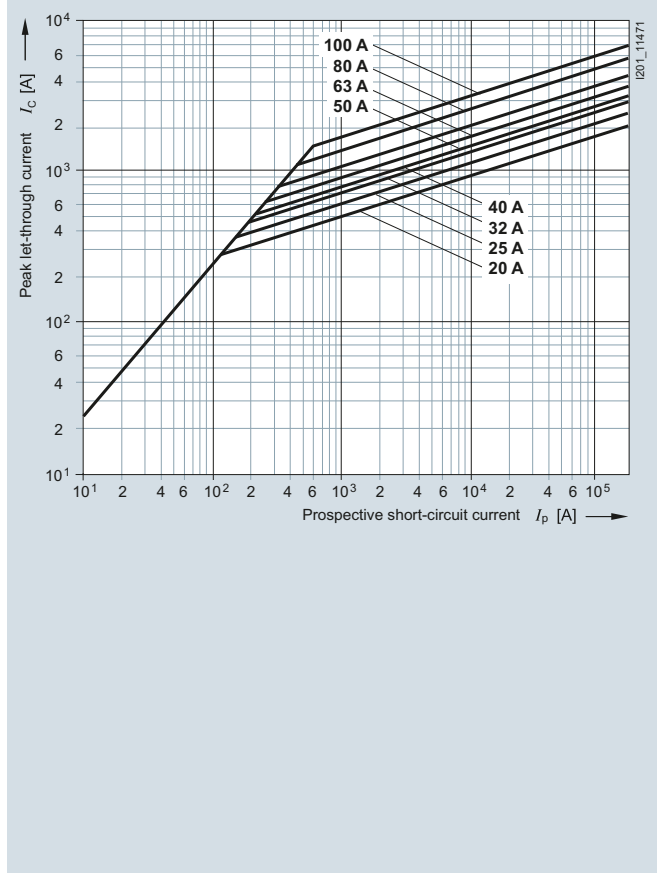

Correction factor k_A for breaking I^2t value

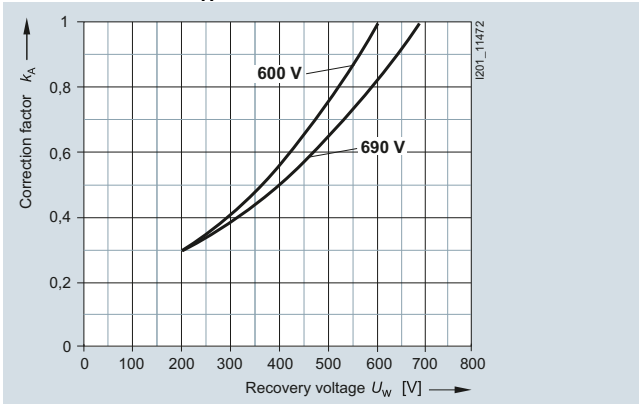

Peak arc voltage

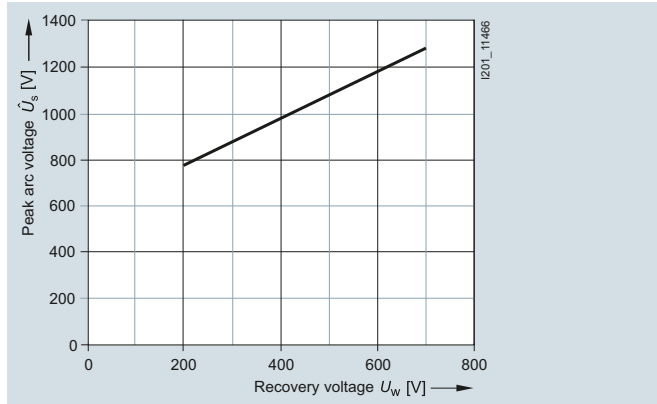

Fuse Systems

SITOR Semiconductor Fuses

Cylindrical fuse design

3NC22..-0MK series

Size: 22 × 58 mm
 Operational class: gR, aR
 Rated voltage: 690 V AC; 250 ... 700 V DC
 Rated current: 25 ... 125 A

Time/current characteristics diagram

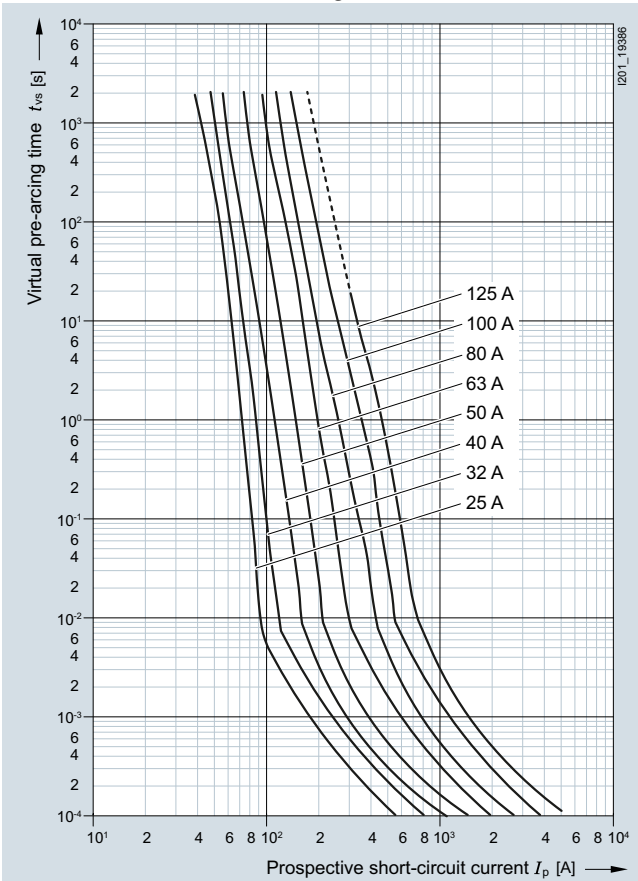

Let-through characteristics (current limitation at 50 Hz)

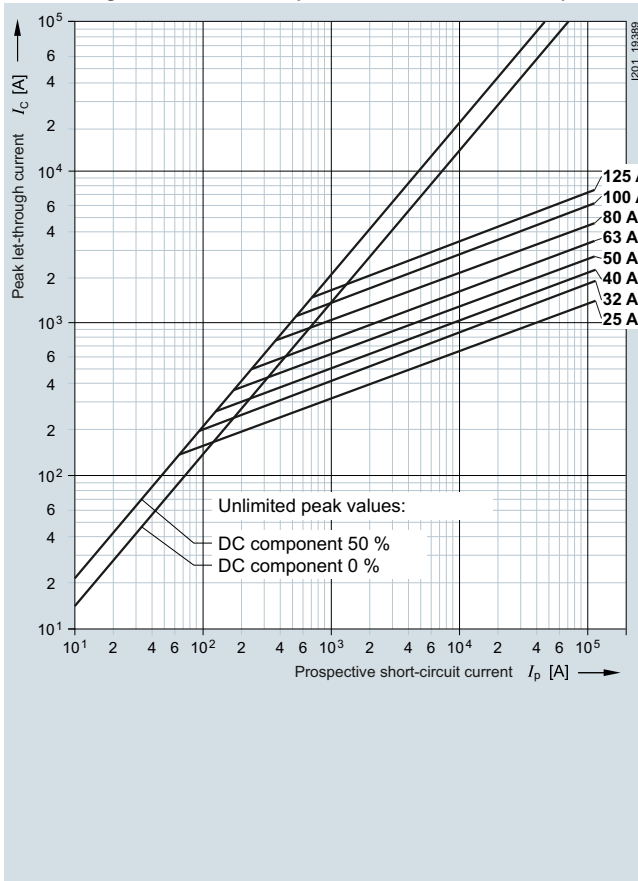

Correction factor k_A for breaking I^2t value

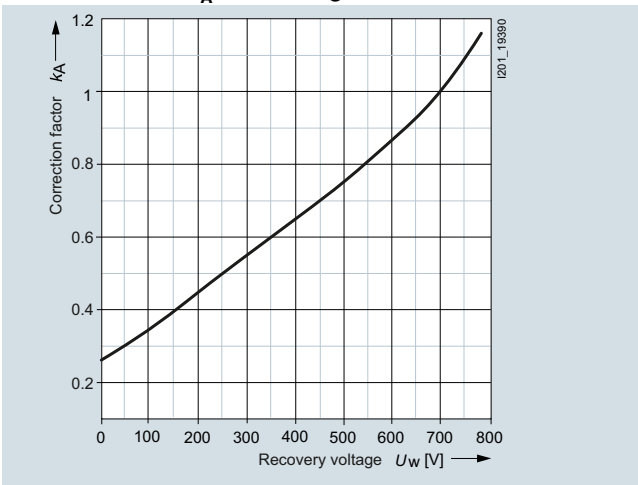

Peak arc voltage

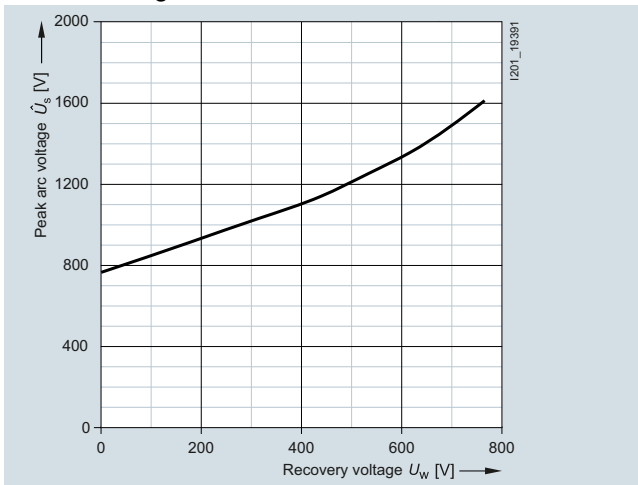

3NC22..-5 series with striking pin

Size: 22 × 58 mm
 Operational class: aR
 Rated voltage: 690 V AC/500 V DC (20 ... 80 A);
 600 V AC/500 V DC (100 A)
 Rated current: 20 ... 100 A

Time/current characteristics diagram

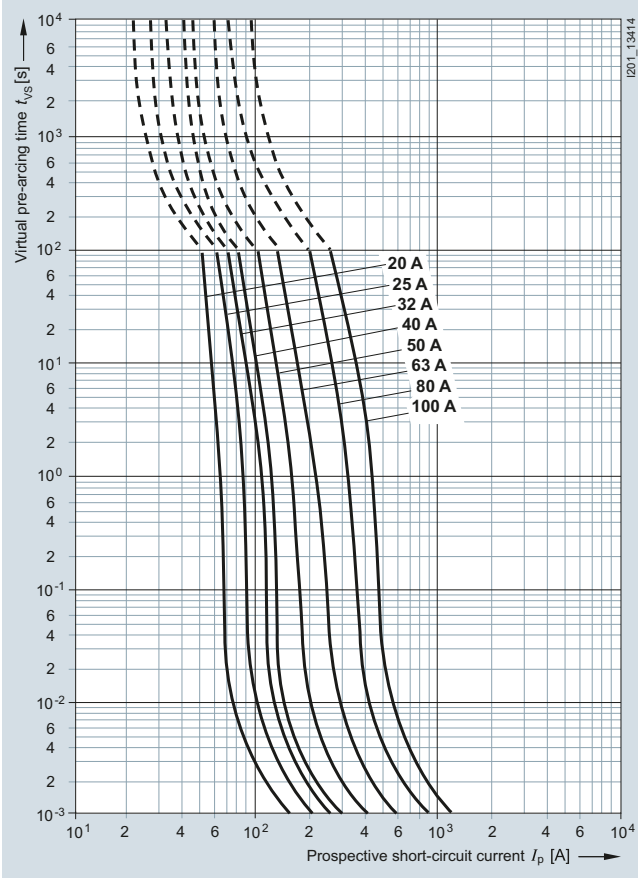

Let-through characteristics (current limitation at 50 Hz)

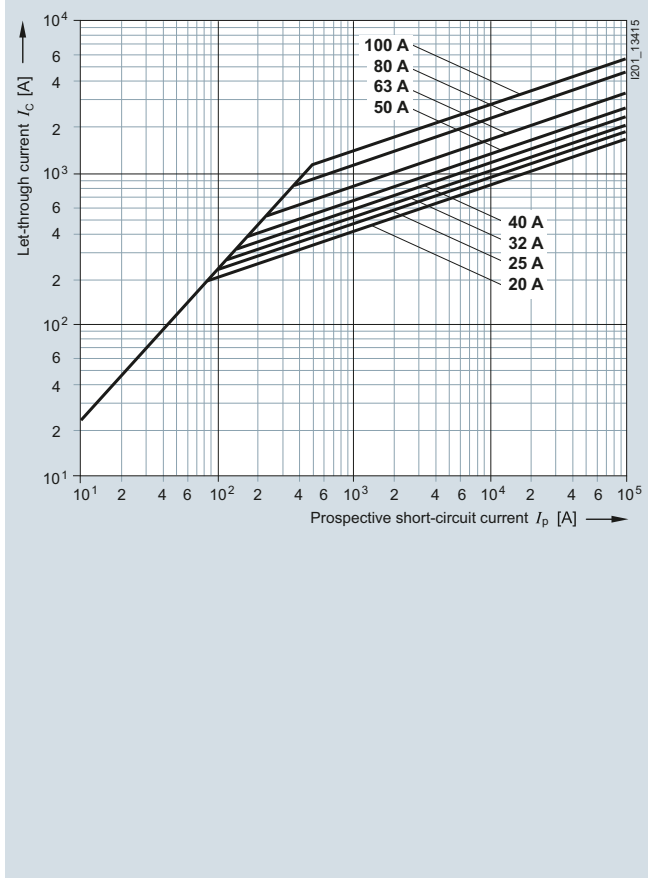

Correction factor k_A for breaking I^2t value

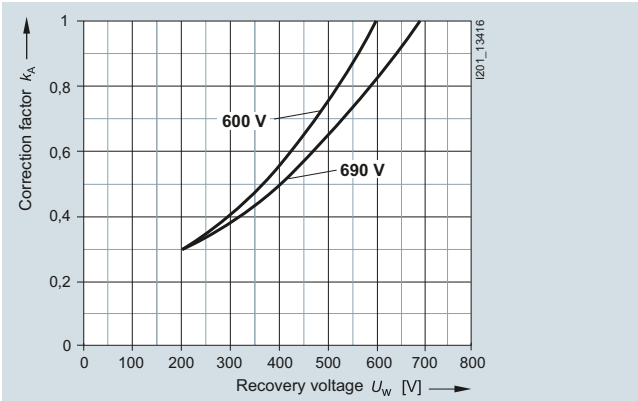

Peak arc voltage

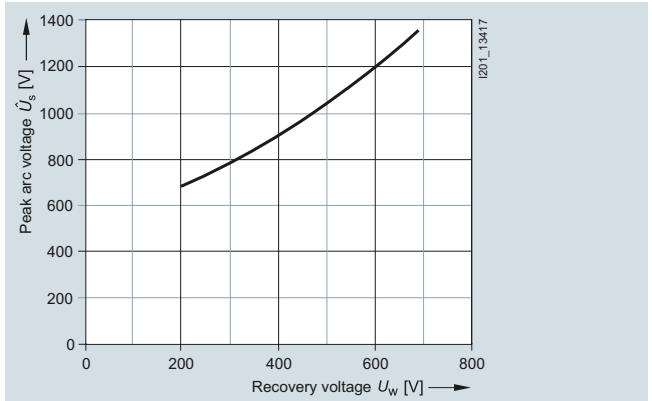

Fuse Systems

SITOR Semiconductor Fuses

Cylindrical fuse design

3NC23..-0MK series

Size: 22 × 127 mm
 Operational class: gS, gR, aR

Rated voltage: 1500 V AC/1000 V DC
 Rated current: 1 ... 50 A

Time/current characteristics diagram

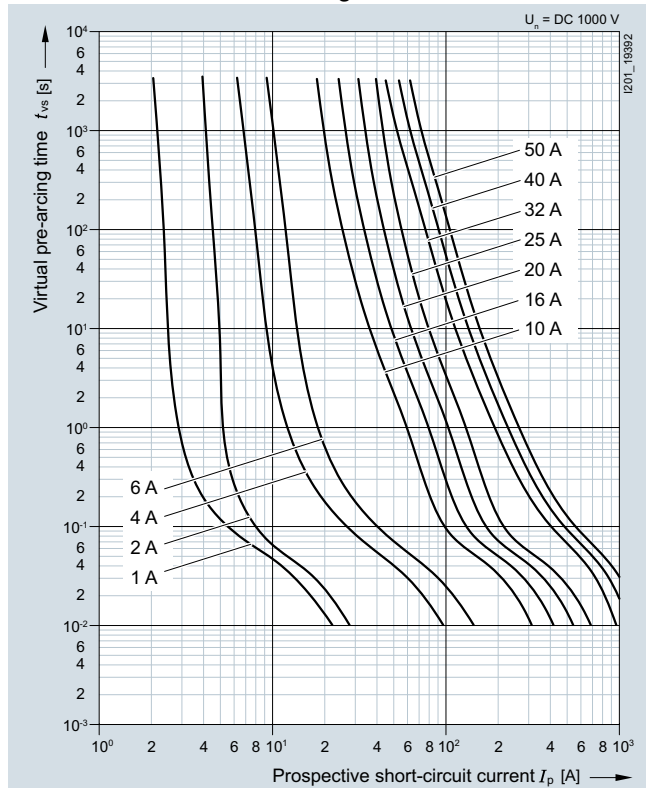

Let-through characteristics (current limitation at 50 Hz)

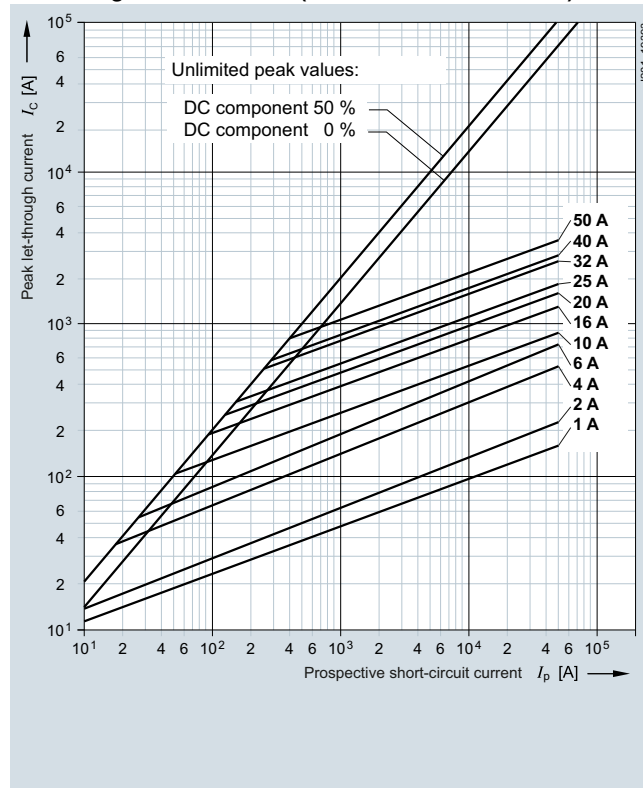

I^2t characteristic

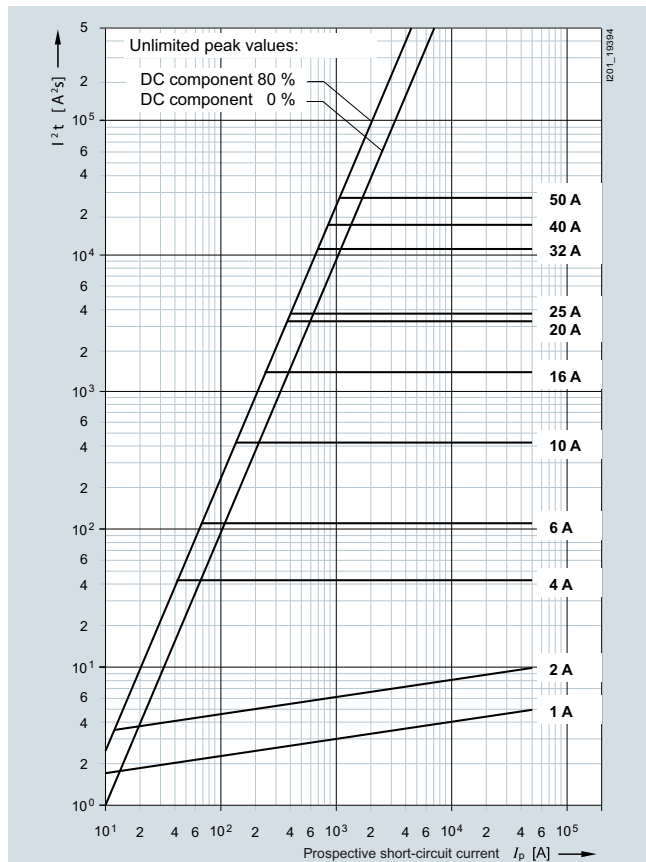

3NC26..-0MK series

Size: 26 × 103 mm
Operational class: gR, aR
Rated voltage: 690 V AC/440 V DC
Rated current: 25 ... 125 A

Time/current characteristics diagram

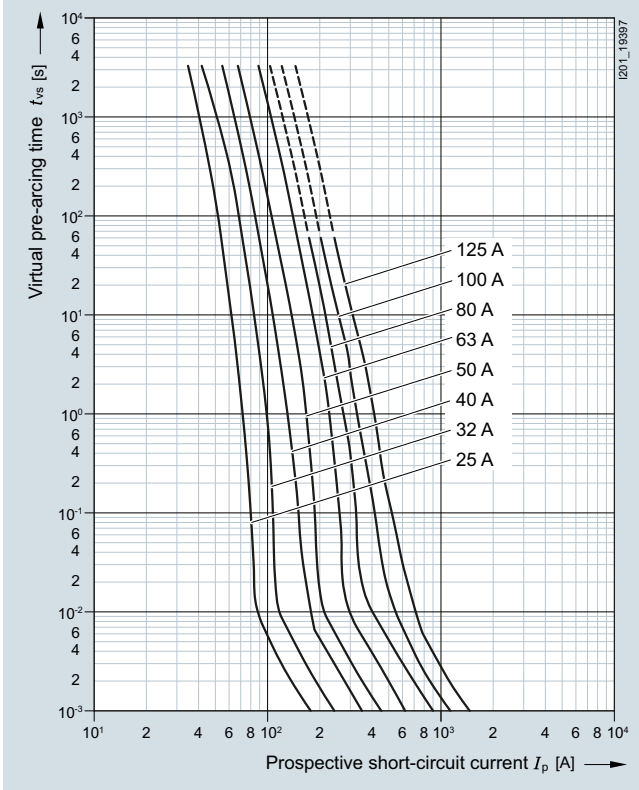

Let-through characteristics (current limitation at 50 Hz)

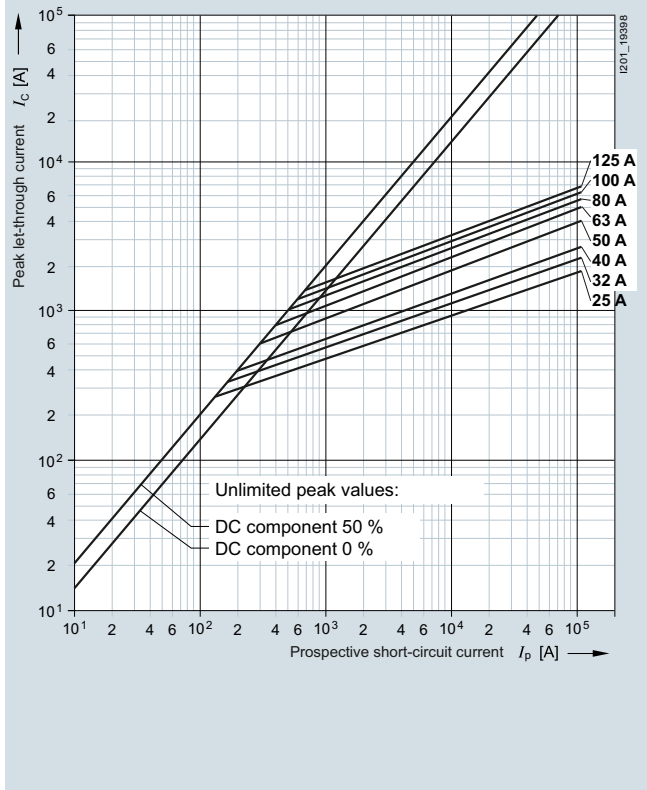

Correction factor k_A for breaking I^2t value

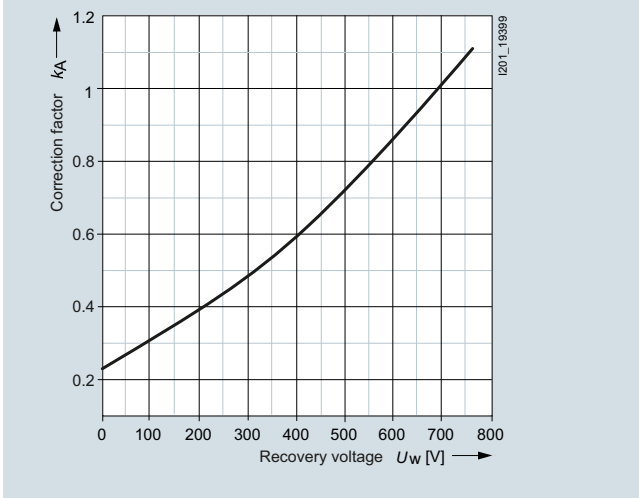

Peak arc voltage

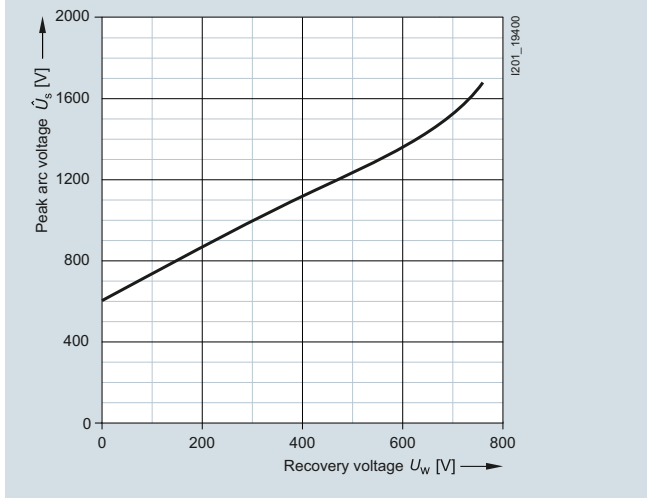

Fuse Systems

SITOR Semiconductor Fuses

NEOZED and DIAZED design

Overview

SILIZED is the brand name for the NEOZED fuses (D0 fuses) and the DIAZED fuses (D fuses) with quick-acting characteristic for semiconductor protection.

The fuses are used in combination with fuse bases, fuse screw caps and accessory parts of the standard fuse system.

SILIZED semiconductor fuses protect power semiconductors from the effects of short circuits because the super quick disconnect characteristic is far quicker than that of conventional fuses. They protect expensive devices and system components, such as semiconductor contactors, static relays, converters with fuses in the input and in the DC link, UPS systems and soft starters for motors up to 100 A.

When using fuse bases and fuse screw caps made of molded plastic, always heed the maximum permissible power loss values due to the high power loss (power dissipation) of the SILIZED fuses.

When using these components, the following maximum permissible power loss applies:

- NEOZED D02: 5.5 W
- DIAZED DII: 4.5 W
- DIAZED DIII: 7.0 W

This enables a partial thermal permanent load of only 50 %.

The DIAZED screw adapter DII for 25 A is used for the 30 A fuse link.

Benefits

- SILIZED semiconductor fuses have an extremely compact design. This means they have a very small footprint – particularly the NEOZED version
- The rugged and well-known DIAZED design complies with IEC 60269-3. It is globally renowned and can be used in many countries
- A wide range of fuse bases and accessories is available for the NEOZED and DIAZED versions of the SILIZED semiconductor fuses. This increases the application options in many devices

Technical specifications

		Fuse links, NEOZED design 5SE13	Fuse links, DIAZED design 5SD4
Standards		DIN VDE 0636-3; IEC 60269-3; EN 60269-4 (VDE 0636-4); IEC 60269-4	
Operational class		gR	
Characteristic		Quick-acting	
Rated voltage U_n	V AC V DC	400 250	500 500
Rated current I_n	A	10 ... 63	16 ... 100
Rated breaking capacity	kA AC kA DC	50 8	
Mounting position		Any, preferably vertical	
Non-interchangeability		Using adapter sleeves	Using screw adapter or adapter sleeves
Resistance to climate	°C	Up to 45 at 95 % rel. humidity	
Ambient temperature	°C	-5 to +40, humidity 90 % at 20	

Dimensional drawings

5SE1

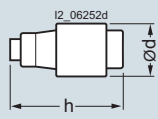

5SD420, 5SD430, 5SD440, 5SD480

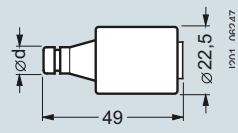

5SD450, 5SD460, 5SD470

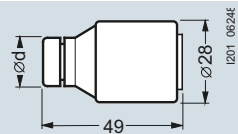

5SD510, 5SD520

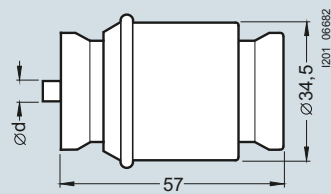

Size	D01	D02
Rated current in A	10 ... 16	20 ... 63
Dimension d	11	15.3
Dimension h	36	36

Size/thread	DII/E27			
Rated current in A	16	20	25	30
Dimension d	10	12	14	14

Size/thread	DIII/E33		
Rated current in A	35	50	63
Dimension d	16	18	20

Size/thread	DIV/R1¼"	
Rated current in A	80	100
Dimension d	5	7

Technical specifications

Type	Size	NEOZED design						
		I_n	P_v	Δg	$I^2 t_s$		$I^2 t_a$	
		A	W	K	1 ms A ² s	4 ms A ² s	230 V AC A ² s	400 V AC A ² s
5SE1310	D01	10	6.9	64	30	30	56	73
5SE1316		16	6.2	61	31	34	92	120
5SE1320	D02	20	8.1	64	50	56	146	190
5SE1325		25	8.2	63	120	120	166	215
5SE1335		35	16.7	100	145	182	361	470
5SE1350	D02	50	12.0	80	460	540	1510	1960
5SE1363		63	15.5	96	845	932	3250	4230

Type	Size	DIAZED design				
		I_n	P_v	Δg	$I^2 t_s$	$I^2 t_a$
		A	W	K	1 ms A ² s	500 V AC A ² s
5SD420	DII	16	12.1	63	16.2	60
5SD430		20	12.3	69	35.8	139
5SD440		25	12.5	61	48.9	205
5SD480		30	13.4	65	85	310
5SD450	DIII	35	14.8	62	135	539
5SD460		50	18.5	66	340	1250
5SD470		63	28	84	530	1890
5SD510	DIV	80	34.3	77	980	4200
5SD520		100	41.5	83	1950	8450

Fuse Systems

SITOR Semiconductor Fuses

NEOZED and DIAZED design

Characteristic curves

5SE13.. series

Size: D01, D02
 Operational class: gR
 Rated voltage: 400 V AC/250 V DC
 Rated current: 10 ... 63 A

Time/current characteristics diagram

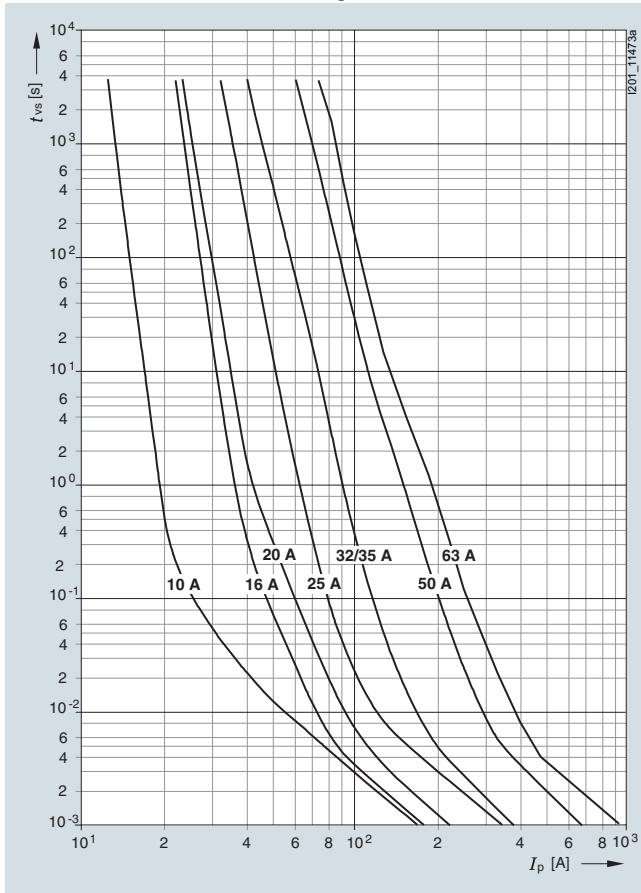

Melting I^2t values diagram

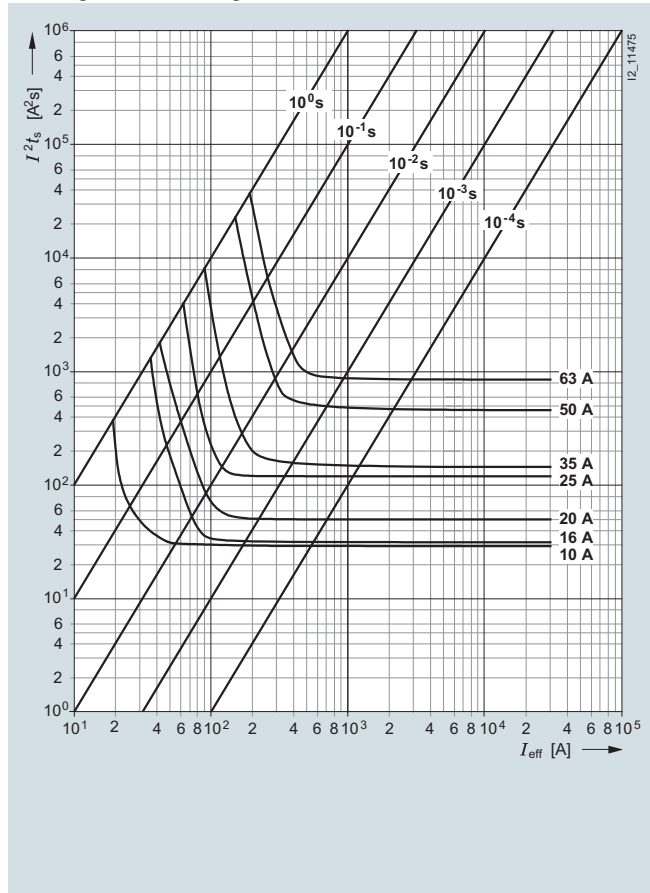

Current limiting diagram

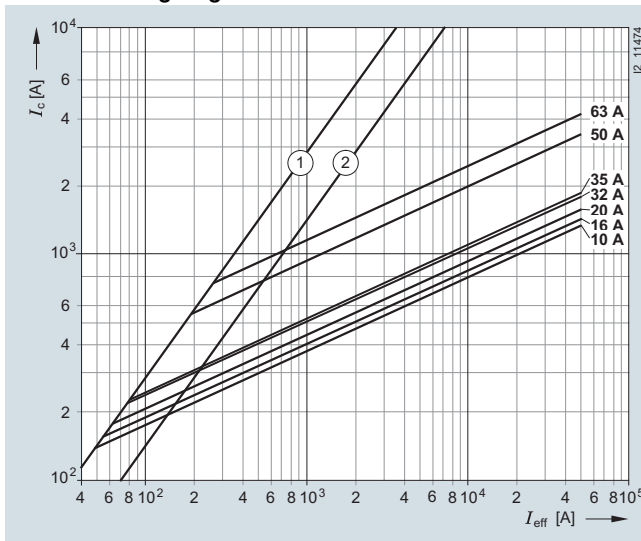

- ① Peak short-circuit current with largest DC component
- ② Peak short-circuit current without DC component

5SD4, 5SD5 series

Size: DII, DIII, DIV
Operational class: gR
Characteristic: Super quick
Rated voltage: 500 V AC/500 V DC
Rated current: 16 ... 100 A

Time/current characteristics diagram

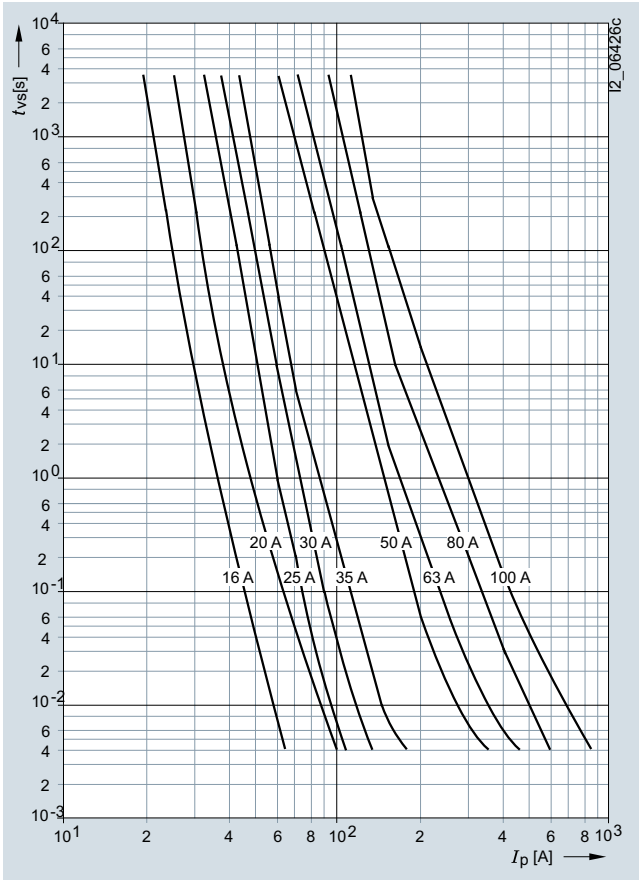

Melting I^2t values diagram

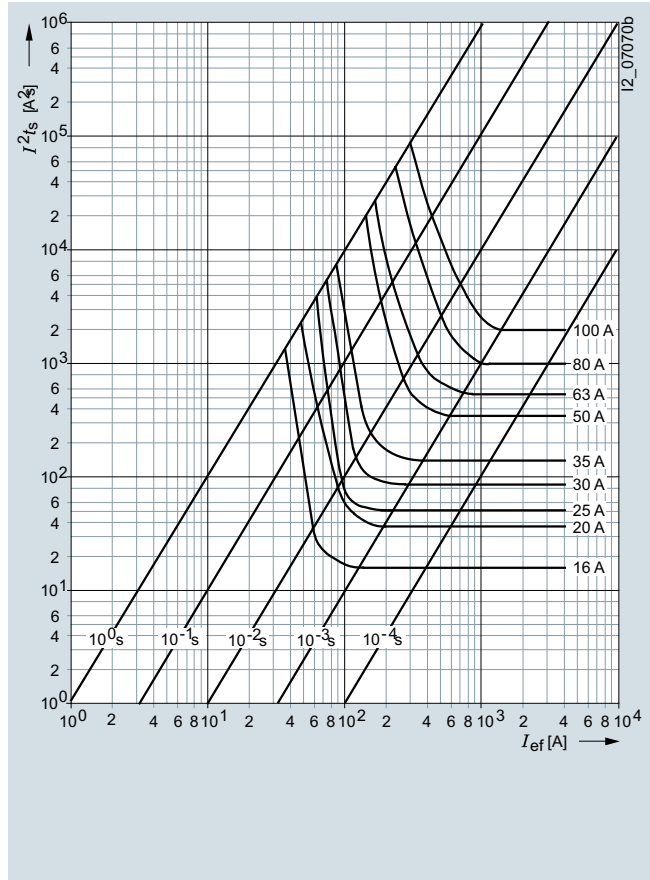

Current limiting diagram

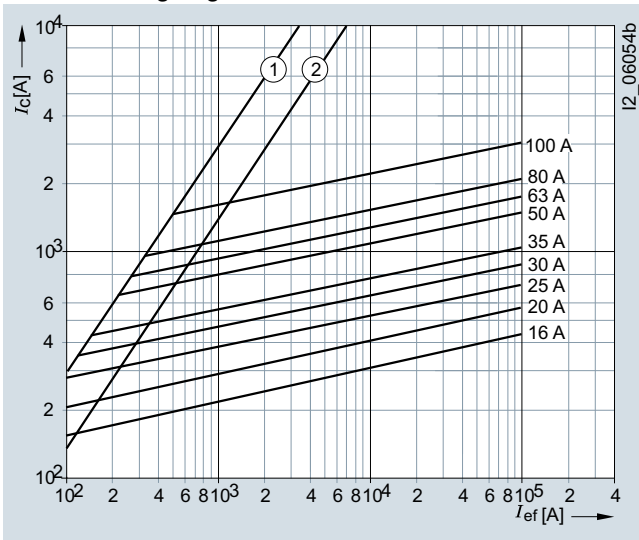

- ① Peak short-circuit current with largest DC component
- ② Peak short-circuit current without DC component

Fuse Systems

SITOR Semiconductor Fuses

Configuration

Overview

Parameters

The fuse links are selected according to rated voltage, rated current, breaking I^2t value I^2t_a and varying load factor, taking into consideration other specified conditions. All of the following data refers, unless otherwise specified, to use of alternating current from 45 Hz to 62 Hz.

Rated voltage U_n

The rated voltage of a SITOR fuse link is the voltage specified as the rms value of the AC voltage on the fuse link and in the ordering and configuration data and the characteristics.

Always ensure that the rated voltage of the fuse link you select is such that the fuse link will reliably quench the voltage driving the short-circuit current. The driving voltage must not exceed the value $U_n + 10\%$. Please note that the supply voltage U_{V0} of a power converter can also be increased by 10%. If, in the shorted circuit, two branches of a converter circuit are connected in series, and if the short-circuit current is sufficiently high, it can be assumed that voltage sharing is uniform. It is essential to observe the instructions in "Series connection of fuse links" on page 179.

Rectifier operation

The supply voltage U_{V0} is the driving voltage with converter equipment that can only be used for rectifier operation.

Inverter operation

With converter equipment that can also be used for inverter operation, inverter shoot-through may occur as faults. In this case, the driving voltage U_{WK} in the shorted circuit is the sum of the infeed direct voltage (e.g. the e.m.f. of the DC generator) and the AC-line supply voltage. When rating a fuse link, this sum can be replaced by an AC voltage whose rms value is 1.8 times that of the AC-line supply voltage ($U_{WK} = 1.8 U_{V0}$). The fuse links must be rated so that they reliably quench the voltage U_{WK} .

VSI voltage

VSI is the abbreviation for Voltage Sourced Inverter. The VSI voltage U_{VSI} is a DC test voltage defined in IEC 60269-4 specially for use in applications with energy stores. The characteristic feature of such applications is the extremely steep rise in current in the event of a fault. The VSI voltage and the corresponding I^2t value for SITOR fuses 3NB1 and 3NB2 is specified in the "Technical Specifications" table; the values for all other SITOR fuses are available on request.

Rated current I_n , load rating

The rated current of a SITOR fuse link is the current specified in the "Selection and ordering data", in the "Characteristic curves" and on the fuse link as the rms value of an alternating current for the 45 Hz to 62 Hz frequency range.

When operating fuse links with rated current, the following are considered normal operating conditions:

- Natural air cooling with an ambient temperature of +45 °C
- Conductor cross-sections equal test cross-sections (see table "Test cross-sections"), for operation in LV HRC fuse bases and switch disconnectors, see "Selection and ordering data" in Catalog LV 10.
- Conduction angle of a half-period 120°el
- Continuous load maximum with rated current

For operating conditions that deviate from the above, the permissible load current I_n' of the SITOR fuse link can be determined using the following formula:

$$I_n' = k_U \times k_Q \times k_\lambda \times k_1 \times VL \times I_n$$

with

I_n Rated current of the fuse link¹⁾

k_U Correction factor for ambient temperature (page 173)

k_Q Correction factor for conductor cross-section (page 173)

k_λ Correction factor for conduction angle (page 173)

k_1 Correction factor for forced-air cooling (page 173)

VL Varying load factor (page 174).

Test cross-sections

Rated current I_n	Test cross-sections	
	(3NC10, 3NC11, 3NC14, 3NC15, 3NC22, 3NE1..., 3NE80..., 3NE4 series) ¹⁾	(all other series)
A	Cu mm ²	Cu mm ²
10	1.0	--
16	1.5	--
20	2.5	45
25	4	45
35	6	45
40	10	45
50	10	45
63	16	45
80	25	45
100	35	60
125	50	80
160	70	100
200	95	125
224	--	150
250	120	185
315	2 × 70	240
350	2 × 95	260
400	2 × 95	320
450	2 × 120	320
500	2 × 120	400
560	2 × 150	400
630	2 × 185	480
710	2 × (40 × 5)	560
800	2 × (50 × 5)	560
900	2 × (80 × 4)	720
1000	--	720
1100	--	880
1250	--	960
1400	--	1080
1600	--	1200

¹⁾ When using SITOR fuse links in LV HRC fuse bases according to IEC/EN 60269-2-1 and in fuse switch disconnectors and switch disconnectors with fuses, please also refer to the information in the "Selection and ordering data" in Catalog LV 10.

Correction factor for ambient temperature k_u

The influence of the ambient temperature on the permissible load of the SITOR fuse link is taken into account using the correction factor k_u as shown in the following diagram.

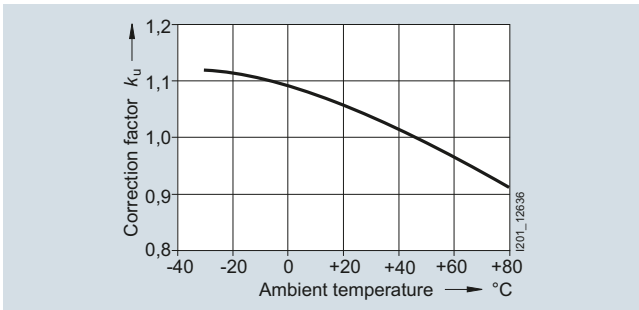

Correction factor for conductor cross-section k_q

The rated current of the SITOR fuse links applies to operation with conductor cross-sections that correspond to the respective test cross-section (see the table on page 172).

In the case of reduced conductor cross-sections, the correction factor k_q must be used, as shown in the following diagram:

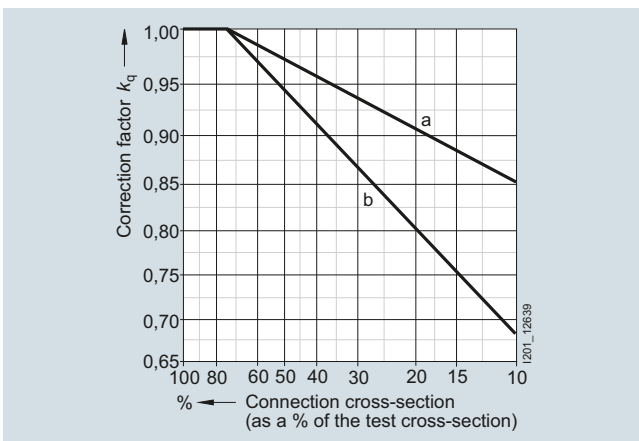

- a = Reduction of cross-section of one connection
- b = Reduction of cross-section of both connections

Correction factor for conduction angle k_λ

The rated current of the SITOR fuse links is based on a sinusoidal alternating current (45 Hz to 62 Hz). However, in converter operation, the branch fuses are loaded with an intermittent current, whereby the conduction angle is generally 180°el or 120°el. With this load current wave form, the fuse link can still carry the full rated current. In the case of smaller conduction angles, the current must be reduced in accordance with the following diagram.

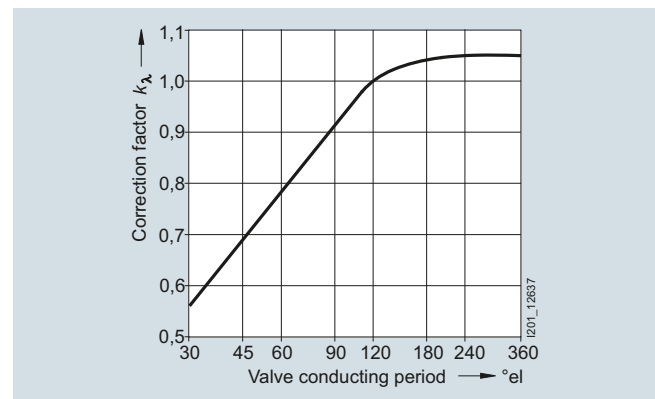

Correction factor for forced-air cooling k_l

In the case of increased air cooling, the current carrying capacity of the fuse links increase with the air speed, air speeds > 5 m/s do not produce any significant further increase in current carrying capacity.

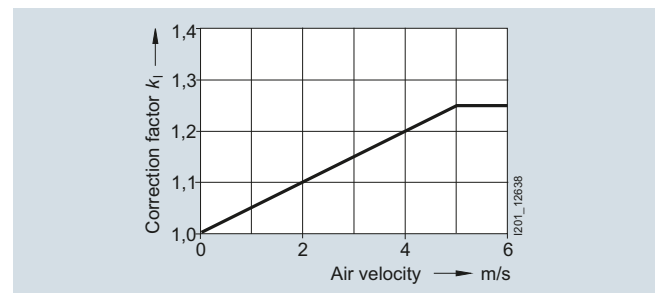

Fuse Systems

SITOR Semiconductor Fuses

Configuration

Varying load factor V_L

The varying load factor V_L is a reduction factor by which the non-aging current carrying capacity of the fuse links can be determined for any load cycles. Due to their design, the SITOR fuse links have different varying load factors. In the characteristic curves of the fuse links, the respective varying load factor V_L for >10000 load changes (1 hour "ON", 1 hour "OFF") is specified for the expected operating time of the fuse links. In the event of a smaller number of load changes during

the expected operating time, it may be possible to use a fuse link with a smaller varying load factor V_L as shown in the following diagram.

In the case of uniform loads (no load cycles and no shutdowns), the varying load factor can be taken as $V_L = 1$. For load cycles and shutdowns that last longer than 5 min. and are more frequent than once a week, you need to select the varying load factor V_L specified in the characteristic curves of the individual fuse links.

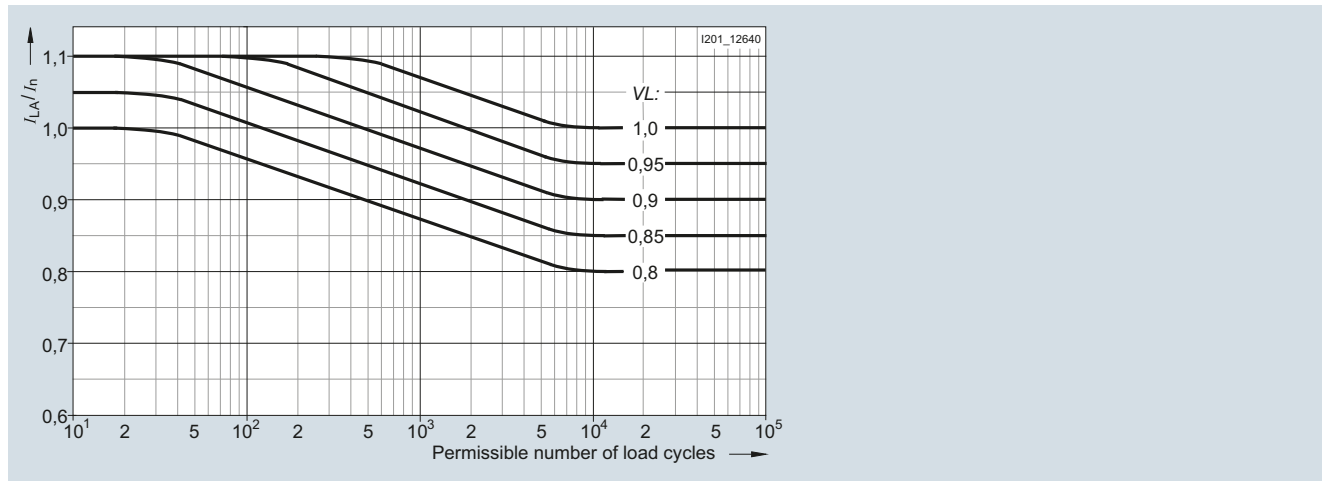

Waveform of the varying load factor V_L for load cycles

Fuse currents for operation in power converter

The rms value of the fuse current can be calculated for the most common converter circuits from the (smoothed) direct current I_d or the conductor current I_L according to the following table:

Converter circuit		Rms value of the conductor current (phase fuse)	Rms value of the branch current (branch fuse)
Single-pulse center tap connection	(M1)	$1.57 I_d$	--
Double-pulse center tap connection	(M2)	$0.71 I_d$	--
Three-pulse center tap connection	(M3)	$0.58 I_d$	--
Six-pulse center tap connection	(M6)	$0.41 I_d$	--
Double three-pulse center tap connection (parallel)	(M3.2)	$0.29 I_d$	--
Two-pulse bridge circuit	(B2)	$1.0 I_d$	$0.71 I_d$
Six-pulse bridge circuit	(B6)	$0.82 I_d$	$0.58 I_d$
Single-phase bidirectional circuit	(W1)	$1.0 I_L$	$0.71 I_L$

I^2t values

In the event of a short circuit, the current of the fuse link increases during the melting time t_s up to let-through current I_c (melting current peak).

During the arc quenching time t_L , the electric arc develops and the short-circuit current is quenched (see the diagram below).

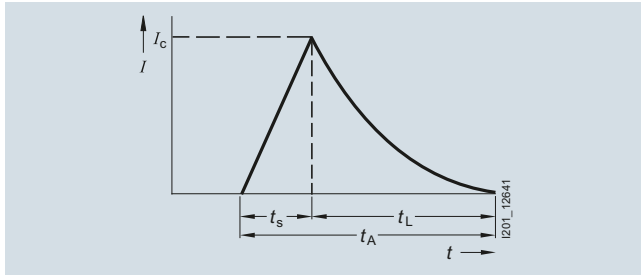

Current path when switching fuse links

The integral of the current squared ($\int I^2 dt$) over the total operating time ($t_s + t_L$), known as the breaking I^2t value, determines the heat to be fed to the semiconductor device that is to be protected during the breaking operation.

To ensure adequate protection, the breaking I^2t value of the fuse link must be smaller than the I^2t value of the semiconductor device. As the temperature increases, i.e. preloading increases, the breaking I^2t value of the fuse link decreases almost in the same way as the I^2t value of a semiconductor device, so that it is sufficient to compare the I^2t values in a non-loaded (cold) state.

The breaking I^2t value (I^2t_a) is the sum of the melting I^2t value (I^2t_s) and the quenching I^2t value (I^2t_L).

$$\left(\int I^2 dt\right) (\text{semiconductor, } t_{vj} = 25 \text{ °C, } t_p = 10 \text{ ms}) > \left(\int I^2 dt_A\right) (\text{fuse link})$$

Melting I^2t value I^2t_s

The melting I^2t value can be calculated from the value pairs of the time/current characteristic curve of the fuse link for any periods.

As the melting time decreases, the melting I^2t value tends towards a lower limit value at which almost no heat is dissipated from the bottleneck of the fuse element to the environment during the melting process. The melting I^2t values specified in the selection and ordering data and in the characteristic curves correspond to the melting time $t_{vs} = 1 \text{ ms}$.

Quenching I^2t value I^2t_L

Whereas the melting I^2t value is a characteristic of the fuse link, the quenching I^2t value depends on circuit data, such as:

- The recovery voltage U_w
- The power factor p.f. of the shorted circuit
- The prospective current I_p (current at the installation position of the fuse link if this is jumpered)

The maximum quenching I^2t value is reached at a current of $10 \times I_n$ to $30 \times I_n$ depending on the fuse type.

Breaking I^2t value I^2t_a , correction factor k_A

The breaking I^2t values of the fuse links are specified in the characteristic curves for the rated voltage U_n . To determine the breaking I^2t value for recovery voltage U_w the correction factor k_A must be taken into account.

$$I^2t_a (\text{at } U_w) = I^2t_a (\text{at } U_n) \times k_A$$

The "correction factor k_A " characteristic (see the following diagram) is specified in the characteristic curves for the individual fuse series. The breaking I^2t values determined in this way apply to prospective currents $I_p \geq 10 \times I_n$ and p.f. = 0.35.

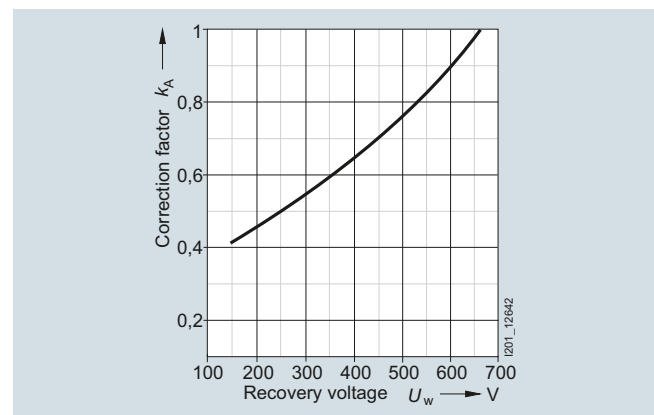

Correction factor k_A for breaking I^2t value
Example: Series 3NE8 0..

Fuse Systems

SITOR Semiconductor Fuses

Configuration

Taking into account the recovery voltage U_w

The recovery voltage U_w is derived from the voltage driving the short-circuit current. For most faults, the driving voltage is equal to the supply voltage U_{V0} ; however, for shoot-throughs it is 1.8 times the value for the supply voltage U_{V0} (see [rated voltage, page 172](#)). If the shorted circuit contains two branches of a converter circuit and thus two fuse links in series, and if the short-circuit current is sufficiently high (see [series connection, page 179](#)) it can be assumed that there is a uniform voltage sharing, i.e. $U_w = 0.5 \times U_{V0}$ or in the case of shoot-throughs $U_w = 0.9 \times U_{V0}$.

Influence of the power factor p.f.

The specifications in the characteristic curves for the breaking I^2t values (I^2t_a) refer to a power factor of p.f. = 0.35 (exception: for 3NC58..., 3NE64..., 3NE94... SITOR fuse links, the following applies: p.f. = 0.2).

The dependence of the breaking I^2t values on the power factor p.f. at $1.0 \times U_n$ and at $0.5 \times U_n$ is shown in the following diagram.

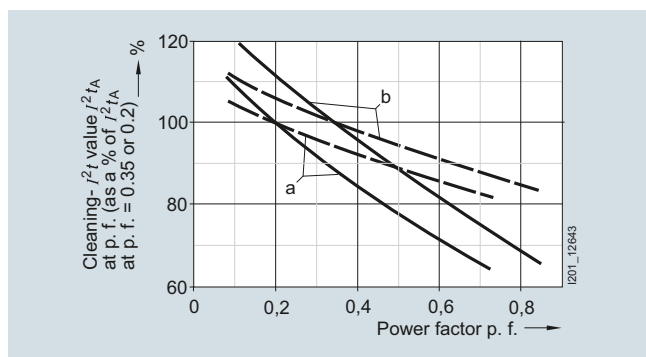

Breaking I^2t value I^2t_a of SITOR fuse links dependent on the power factor p.f.

- at $1.0 U_n$
- - - at $0.5 U_n$

a = for 3NC58..., 3NE64..., 3NE94... SITOR fuse links (reference to p.f. = 0.2)

b = for all other SITOR fuse links (reference to p.f. = 0.35)

Time/current characteristics

The solid time/current characteristic curves in the following diagram specify the time to melting for the non-loaded fuse link in a cold state (max. +45 °C).

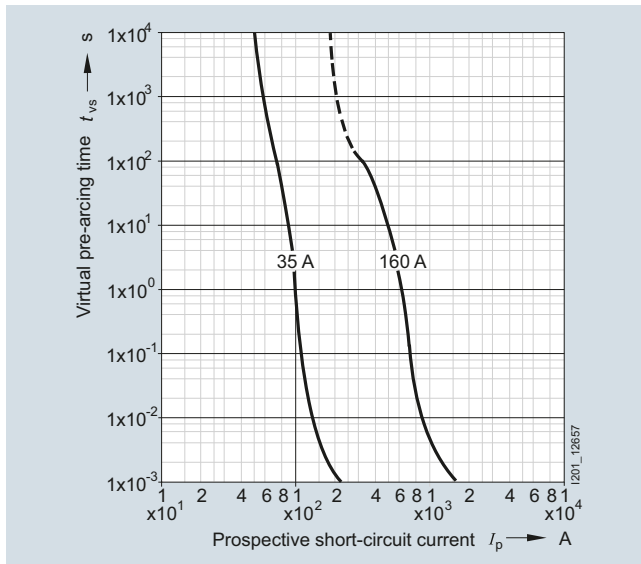

35 A: Operational class gR
160 A: Operational class aR

If the time/current characteristic curve in the long-time range ($t_{vs} > 30$ s) is dashed (fuse links of operational class aR), this specifies the limit of the permissible overload in a cold state. If the dotted part of the characteristic curve is exceeded, there is a risk of damage to the ceramic body of the fuse link. The fuse link can only be used for short-circuit protection. In this case, an additional protective device (overload relay, circuit breaker) is required to protect against overload. In the case of controlled converter equipment, the current limiter is sufficient.

If the time/current characteristic curve is shown as a solid line over the entire time range (fuse links of operational class gR or gS), the fuse link can operate in the entire time range. This means it can be used both for overload and short-circuit protection.

Real melting time

The virtual melting time t_{vs} is specified in the time/current characteristic curve, depending on the prospective current. It is a value that applies to the current squared ($dI/dt = \infty$).

In the case of melting times $t_{vs} < 20$ ms the virtual melting time t_{vs} deviates from the real melting time t_s . The real melting time may be several milliseconds longer (depending on the rate of current rise).

Within a range of several milliseconds, during which the rise of the short-circuit current can be assumed to be linear, the real melting time for a sinusoidal current rise and 50 Hz is as follows:

$$t_s = \frac{3xI^2 t_s}{I_c^2}$$

Taking into account preloading, residual value factor RV

Preloading the fuse link shortens the permissible overload duration and the melting time.

The residual value factor RV can be used to determine the time that a fuse link can be operated during a periodic or non-periodic load cycle, above and beyond the previously determined permissible load current I_n' , with any overload current I_{La} without aging.

The residual value factor RV is dependent on the preloading V (I_{rms} rms value of the fuse current during the load cycle at permissible load current I_n')

$$V = \frac{I_{rms}}{I_n'}$$

and the frequency of the overloads (see the following diagram, curves a and b).

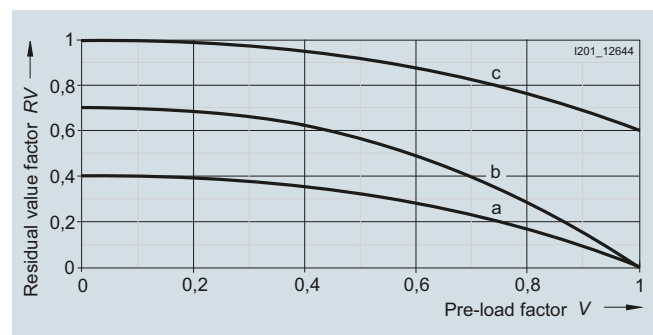

Permissible overload and melting time for previous load

- a = Frequent surge/load cycle currents (>1/week)
- b = Infrequent surge/load cycle currents (<1/week)
- c = Melting time for preloading

Permissible overload duration =
Residual value factor $RV \times$ melting time t_{vs}
(time/current characteristic curve)

A reduction of the melting time of a fuse link in the case of preloading can be derived from curve c.

Melting time =
Residual value factor $RV \times$ melting time t_{vs}
(time/current characteristic curve)

Fuse Systems

SITOR Semiconductor Fuses

Configuration

Let-through current I_c

The let-through current I_c can be determined from the current limiting characteristics (current limitation at 50 Hz) specified for the respective fuse link. This depends on the prospective current and the DC component when the short circuit occurs (instant of closing).

The following diagram shows the let-through current I_c of a fuse link, depending on the prospective short-circuit current I_p using the 3NE4333-0B SITOR fuse link as an example.

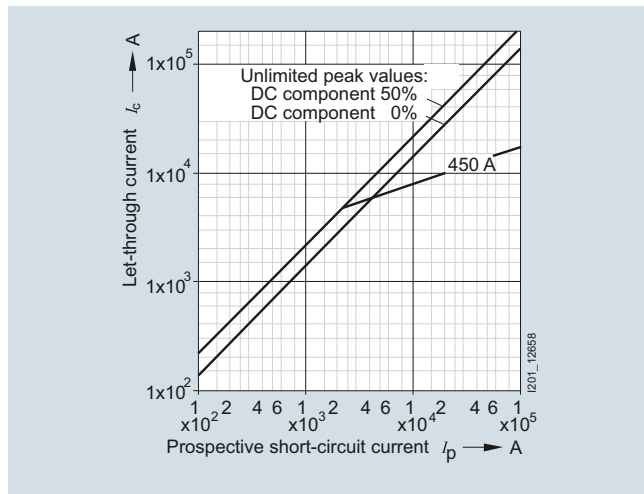

Example:
3NE4333-0B SITOR fuse link

Rated breaking capacity

The rated breaking capacity of all SITOR fuse links is at least 50 kA, unless higher values are specified in the characteristic curves.

The data applies to a test voltage of $1.1 \times U_n$, 45 Hz to 62 Hz and $0.1 \leq p.f. \leq 0.2$. In the case of inception voltages that are below the rated voltage, as well as rated currents of the fuse links that are below the maximum rated current of a fuse series, the breaking capacity is considerably higher than the rated breaking capacity.

Peak arc voltage \hat{U}_s

During the quenching process, a peak arc voltage \hat{U}_s occurs at the connections of the fuse link that can significantly exceed the supply voltage. The level of the peak arc voltage depends on the design of the fuse link and the level of the recovery voltage. It is presented in characteristic curves as a function of the recovery voltage U_w (see the following diagram).

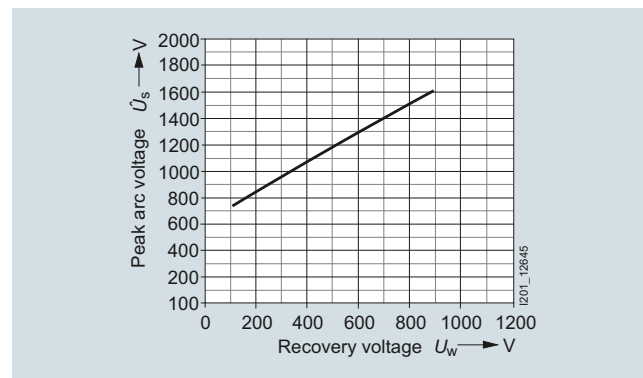

Example:
3NE4333-0B SITOR fuse link

The peak arc voltage occurs as a cutoff voltage at the semiconductor devices not in the shorted circuit. In order to prevent voltage-related hazards, the peak arc voltage must not exceed the peak cutoff voltage of the semiconductor devices.

Power dissipation, temperature rise

On reaching the rated current, the fuse elements of the SITOR fuse links have a considerably higher temperature than the fuse elements of line protection fuse links.

The power dissipation specified in the characteristic curves is the upper variance coefficient if the fuse link is loaded with the rated current.

In the case of partial loads, this power dissipation decreases as shown in the following diagram.

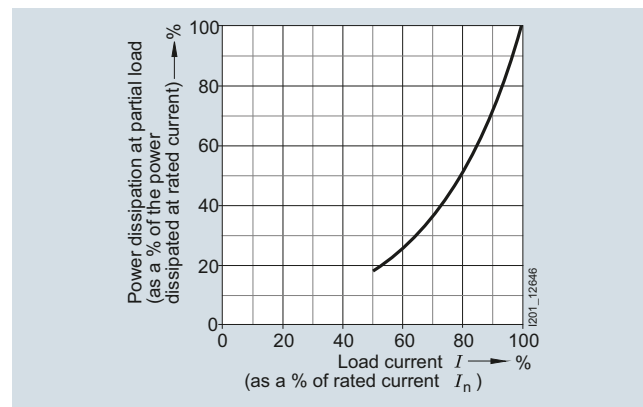

The temperature rise specified in the characteristic curves applies to the respective reference point and is determined when testing the fuse link (test setup according to DIN VDE 0636, Part 23 and IEC 269-4).

Parallel and series connection of fuse links

Parallel connection

If a branch of a converter circuit has several semiconductor devices so that the fuse links are connected in parallel, only the fuse link connected in series to the faulty semiconductor device is tripped in the event of an internal short circuit. It must quench the full supply voltage.

To boost the voltage, two or more parallel fuse links can be assigned to a single semiconductor device without reducing the current. The resulting breaking I^2t value increases with the square of the number of parallel connections. In this case, in order to prevent incorrect distribution of the current, you must only use fuse links of the same type or, better still, the parallel switched SITOR 3NB fuses.

Series connection

There are two kinds of series connection available:

- Series connection in the converter branch
- Two fused converter branches through which a short-circuit current flows in series

In both cases, uniform voltage sharing can only be assumed if the melting time of the SITOR fuse link does not exceed the value specified in the following table.

SITOR fuse links	Maximum melting time for uniform voltage sharing
Type	ms
3NC10..	10
3NC14..	
3NC15..	
3NC22..	
3NC24..	40
3NC58..	10
3NC73..	
3NC84..	
3NE10..	10
3NE12..	
3NE13..	
3NE14..	20
3NE18..	10
3NE32..	10
3NE33..	
3NE34..	20
3NE35..	
3NE36..	
3NE41..	10
3NE43..	
3NE54..	20
3NE56..	
3NE64..	10
3NE74..	20
3NE76..	
3NE80..	10
3NE87..	
3NE94..	10
3NE96..	20

Cooling conditions for series-connected fuse links should be approximately the same. If faults are expected, during which the specified melting times are exceeded (as a result of a slower current rise), it can no longer be assumed that voltage sharing is uniform. The voltage of the fuse links must then be rated so that a single fuse link can quench the full supply voltage.

It is best to avoid the series connection of fuse links in a converter connection branch and instead use a single fuse link with a suitably high rated voltage.

Use with direct current

In general, all SITOR fuses can be used for AC and DC applications. For AC fuse links that are to be used in DC circuits, some data may vary from the data specified in the characteristic curves for alternating current.

The new 1250 V DC fuses 3NB1 and 3NB2 have been explicitly tested with DC voltage. They can also be used with AC voltage; details on request.

Permissible direct voltage

The permissible direct voltage U_{perm} of the fuse links depends on the rated voltage U_n , on the time constant $\tau = L/R$ in the DC circuit and on the prospective current I_p . The permissible direct voltage refers to the rated voltage U_n and is specified depending on the time constant τ ; the prospective current is a parameter (see the following diagrams).

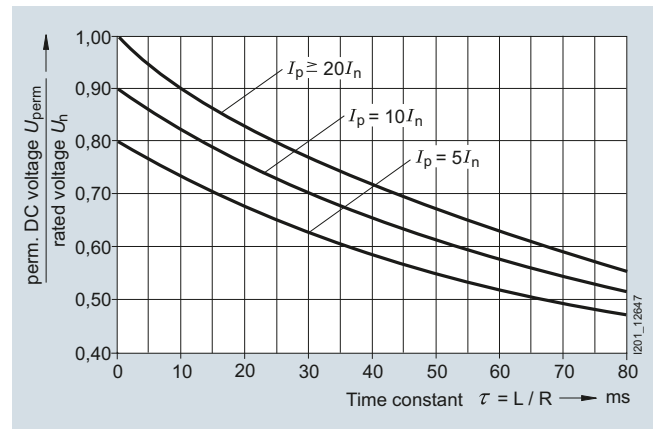

Applies to all series except 3NE10.., 3NE18..

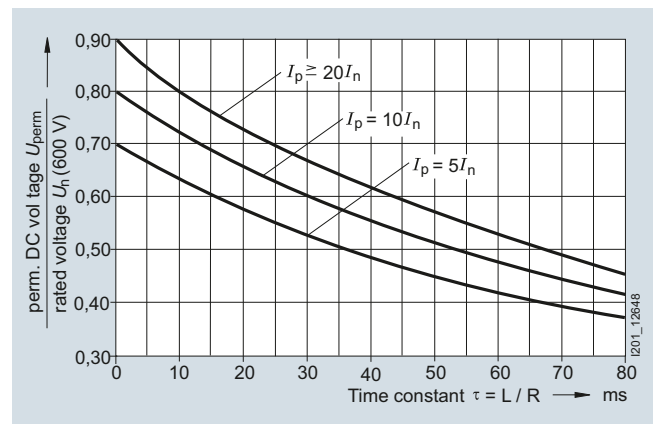

For series 3NE10.., 3NE18..

Fuse Systems

SITOR Semiconductor Fuses

Configuration

Breaking I^2t value $I_a^2t_a$

The breaking I^2t value $I_a^2t_a$ depends on the voltage, on the time constant $\tau = L/R$ and on the prospective current I_p . It is calculated from the I^2t_a value specified in the characteristic curve for the respective fuse link at rated voltage U_n and correction factor k_A whereby, instead of the recovery voltage U_w , the direct voltage is used against which the fuse link is to switch.

The breaking I^2t value determined in this way applies under the following conditions:

- Time constant $L/R \leq 25$ ms for $I_p \geq 20 \times I_n$
- Time constant $L/R \leq 10$ ms for $I_p = 10 \times I_n$
- The breaking I^2t values increase by 20 %
- For $I_p \geq 20 \times I_n$ and time constant $L/R = 60$ ms
- For $I_p = 10 \times I_n$ and time constant $L/R = 35$ ms.

Peak arc voltage \hat{U}_s

The peak arc voltage \hat{U}_s is determined from the curve specified in the characteristics for the respective fuse link, whereby instead of the recovery voltage U_w , the direct voltage is used against which the fuse link is to switch.

The peak arc voltage determined in this way applies under the following conditions:

- Time constant $L/R \leq 20$ ms for $I_p \geq 20 I_n$
- Time constant $L/R \leq 35$ ms for $I_p = 10 I_n$.

The switching voltages increase by 20 %

- For $I_p \geq 20 I_n$ and time constant $L/R = 45$ ms
- For $I_p = 10 I_n$ and time constant $L/R = 60$ ms.

Indicator

An indicator displays the switching of the fuse link. The SITOR fuse links have an indicator whose operational voltage lies between 20 V ($U_n \leq 1000$ V) and 40 V ($U_n > 1000$ V)

Accessories

Fuse bases, fuse pullers

Some of the SITOR fuse links can be inserted in matching fuse bases. The matching fuse bases (single-pole and three-pole) and the respective fuse pullers are listed in the Technical specifications, [from page 87](#).

Note:

Even if the values of the rated voltage and/or current of the fuse bases are lower than those of the allocated fuse link, the values of the fuse link apply.

Fuse switch disconnectors, switch disconnectors with fuses

Some series of SITOR fuse links are suitable for operation in 3NP4 and 3NP5 fuse switch disconnectors or in 3KL and 3KM switch disconnectors with fuses (see [Catalog LV 10, chapter on "Switch Disconnectors"](#)).

When using switch disconnectors, the following points must be observed:

- Because, compared with LV HRC fuses for line protection, the power dissipation of the SITOR fuse links is higher, the permissible load current of the fuse links sometimes needs to be reduced; see [below \(Configuration Manual\)](#)
- Fuse links with rated currents $I_n > 63$ A must not be used for overload protection even when they have operational class gR.

Note:

By contrast, all fuse links of the 3NE1... series with rated currents I_n from 16 A to 850 A and operational classes gR and gS can be used for overload protection.

- The rated voltage and rated isolation voltage of the switch disconnectors must at least correspond to the existing voltage
- When using fuse links of the 3NE32..., 3NE33..., 3NE43..., 3NC24... and 3NC84... series the breaking capacity of fuse switch disconnectors must not be fully utilized due to the slotted blade. Occasional switching of currents up to the rated current of the fuse links is permissible
- When used in fuse switch disconnectors, fuse links of the 3NE41... series may only be occasionally switched, and only without load, as this places the fuse blade under great mechanical stress

In the Technical specifications, [starting on page 87](#), the switch disconnectors are allocated to their respective individual fuse links.

Specifying the rated current I_n for non-aging operation with varying load

Power converters are often operated not with a continuous load, but with varying loads; these can also temporarily exceed the rated current of the power converter.

The selection process for non-aging operation of SITOR fuse links for four typical types of load is as follows:¹⁾

- Continuous load
- Unknown varying load, but with known maximum current
- Varying load with known load cycle
- Occasional surge load from preloading with unknown surge outcome

The diagrams for the correction factors k_u , k_q , k_λ , k_i , [page 173](#), and the residual value factor RV , [page 177](#) must be observed. The varying load factor VL for the fuse links is specified on [page 174](#).

The required rated current I_n of the fuse link is specified in two steps:

1. Specifying the rated current I_n on the basis of the rms value I_{rms} of the load current:

$$I_n > I_{rms} \times \frac{1}{k_u \times k_q \times k_\lambda \times k_i \times VL}$$

Permissible load current I_n' of the selected fuse link:

$$I_n' = k_u \times k_q \times k_i \times k_\lambda \times VL \times I_n$$

2. Checking the permissible overload duration of current blocks exceeding the permissible fuse load current I_n' .

Melting time t_{vs} (time/current characteristic curve) \times Residual value factor $RV \geq$ Overload duration t_k

To do this, you require the previous load ratio

$$V = \frac{I_{rms}}{I_n'}$$

as well as the characteristic curve "Permissible overload and melting time for previous load" ([page 177, curve a](#)) and the "Time/current characteristic curve" for the selected fuse link.

If a determined overload duration is less than the respective required overload duration, then you need to select a fuse link with a greater rated current I_n (taking into account the rated voltage U_n and the permissible breaking I^2t value) and repeat the check.

Continuous load

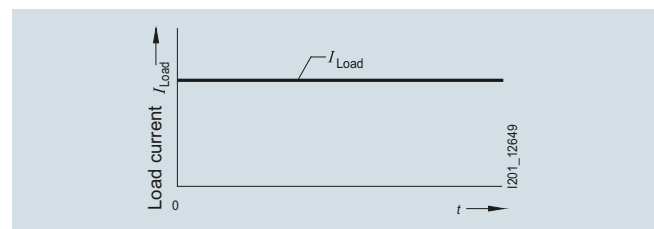

Rated current I_n of the fuse link

$$I_n \geq I_{La} \times \frac{1}{k_u \times k_q \times k_\lambda \times k_i \times VL}$$

I_{La} = Load current of the fuse link (rms value)

Less than 1 shutdown per week: $VL = 1$

More than 1 shutdown per week: $VL =$ see [Technical specifications, from page 87](#).

¹⁾ In the case of varying loads that cannot be assigned to one of the four types of load shown here, please contact us.

Fuse Systems

SITOR Semiconductor Fuses

Configuration

Unknown varying load, but with known maximum current I_{\max}

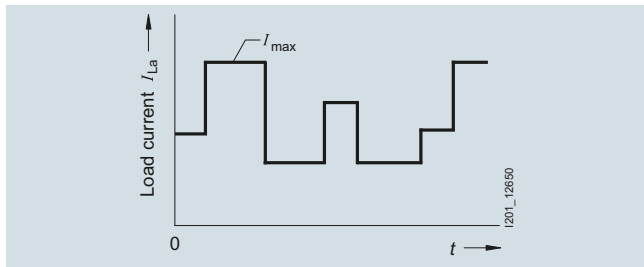

Rated current I_n of the fuse link

$$I_n \geq I_{\max} \times \frac{1}{k_u \times k_q \times k_\lambda \times k_1 \times VL}$$

I_{\max} = Maximum load current of the fuse link (rms value)

Varying load with known load cycle

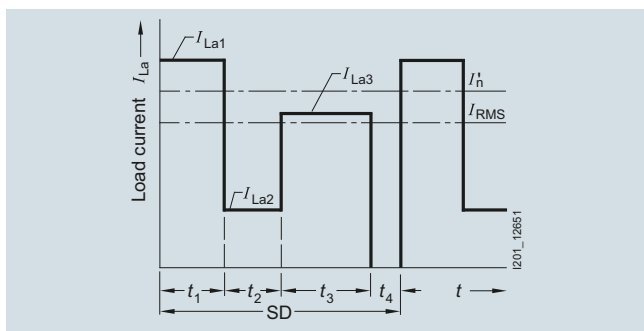

$$I_{\text{rms}} = \sqrt{\frac{\sum_{k=1}^{k=n} I_{La k}^2 \times t_k}{SD}}$$

$$I_{\text{rms}} = \sqrt{\frac{I_{La1}^2 t_1 + I_{La2}^2 t_2 + I_{La3}^2 t_3}{SD}}$$

I_{LK} = Maximum load current of the fuse link (rms value)

Occasional surge load from preloading with unknown surge outcome

The required rated current I_n of the fuse link is specified in two steps:

1. Specifying the rated current I_n on the basis of the previous load current I_{prev} :

$$I_n > I_{\text{prev}} \times \frac{1}{k_u \times k_q \times k_\lambda \times k_1 \times VL}$$

Permissible load current I_n' of the selected fuse link:

$$I_n' = k_u \times k_q \times k_\lambda \times k_1 \times VL \times I_n$$

2. Checking the permissible overload duration of the surge current I_{surge}

Melting time t_{ms} (time/current characteristic curve) \times Residual value factor R_V

\geq surge time t_{surge}

To do this, you require the previous load ratio

$$V = \frac{I_{\text{rms}}}{I_n'}$$

as well as the characteristic curve "Permissible overload and melting time for previous load" (page 177, curve a or b) and the "Time/current characteristic curve" for the selected fuse link.

If a determined overload duration is less than the respective required overload duration t_{surge} , then you need to select a fuse link with a greater rated current I_n (taking into account the rated voltage U_n and the permissible breaking $I^2 t$ value) and repeat the check.

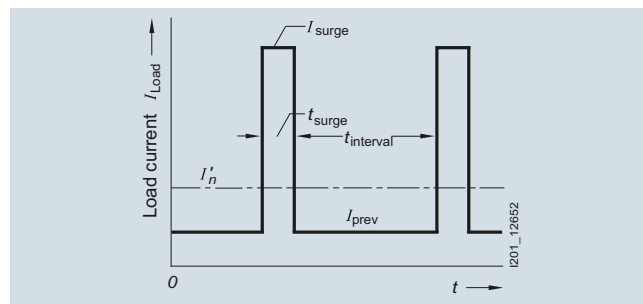

Condition:

$$t_{\text{pause}} \geq 3 \times t_{\text{surge}}$$

$$t_{\text{pause}} \geq 5 \text{ min}$$

Selection examples

For a converter assembly in circuit (B6) A (B6) C, whose rated direct current is $I_{dn} = 850 \text{ A}$, fuse links that can be installed as branch fuses should be selected. The choice of fuse is shown for different operating modes of the converter assembly.

Data for converter assembly

- Supply voltage
 $U_N = 3 \text{ AC } 50 \text{ Hz } 400 \text{ V}$
- Recovery voltage
 $U_W = 360 \text{ V} = U_N \times 0.9$ (for shoot-throughs)
- Thyristor T 508N (eupec),
 $I_2 t$ value
 $\int I^2 dt = 320 \times 10^{-3} \text{ A}^2 \text{ s}$ (10 ms, cold)
- Fuse links, natural air cooling,
ambient temperature $\vartheta_u = +35 \text{ }^\circ\text{C}$
- Conductor cross-section for copper fuse links: 160 mm^2
- Conversion factor
direct current I_d /fuse load current I_{La} : $I_{La} = I_d \times 0.58$.

For the following examples, it is assumed, in the case of loads that exceed the rated direct current of the converter assembly, that the converter assembly is rated for these loads.

Continuous, no-break load

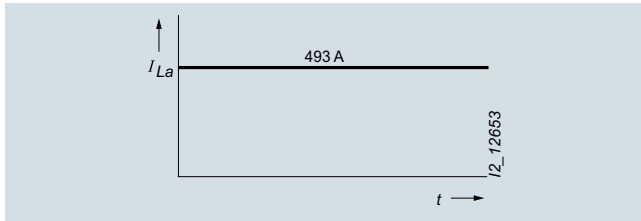

Direct current $I_d = I_{dn} = 850 \text{ A}$

$$I_{La} = I_d \times 0.58 = 493 \text{ A}$$

Selected:

SITOR 3NE3335 fuse link
(560 A/1000 V), $VL = 1$

Breaking I^2t value

$$I^2t_A = 360 \times 10^3 \times 0.53 = 191 \times 10^3 \text{ A}^2\text{s}$$

Test cross-section to 172: 400 mm²

The following correction factors are to be applied:

$$k_U = 1.02 \quad (\vartheta_U = +35 \text{ }^\circ\text{C})$$

$$k_Q = 0.91 \text{ (conductor cross-section, double-ended, 40 \% of test cross-section)}$$

$$k_\lambda = 1.0 \text{ (conduction angle } \lambda = 120^\circ)$$

$$k_1 = 1.0 \text{ (no forced-air cooling)}$$

Required rated current I_n of the SITOR fuse link:

$$I_n \geq I_{La} \times \frac{1}{k_U \times k_Q \times k_\lambda \times k_1 \times VL} =$$

$$493 \text{ A} \times \frac{1}{1.02 \times 0.91 \times 1.0 \times 1.0 \times 1.0} = 531 \text{ A}$$

Unknown varying load, but with known maximum current

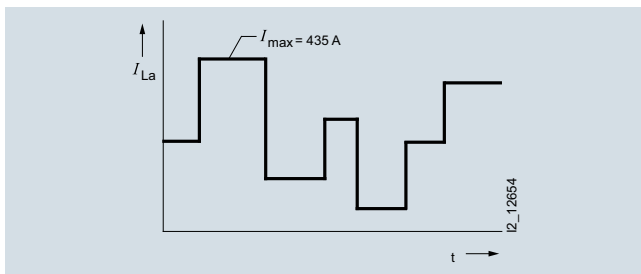

Max. direct current $I_{dmax} = 750 \text{ A}$

Max. fuse current $I_{max} = I_{dmax} \times 0.58 = 435 \text{ A}$

Selected:

SITOR 3NE3334-0B fuse link
(560 A/1000 V), $VL = 1$

Breaking I^2t value

$$I^2t_A = 260 \times 10^3 \times 0.53 = 138 \times 10^3 \text{ A}^2\text{s}$$

Test cross-section to 172: 400 mm²

The following correction factors are to be applied:

$$k_U = 1.02 \quad (\vartheta_U = +35 \text{ }^\circ\text{C})$$

$$k_Q = 0.91 \text{ (conductor cross-section, double-ended, 40 \% of test cross-section)}$$

$$k_\lambda = 1.0 \text{ (conduction angle } \lambda = 120^\circ)$$

$$k_1 = 1.0 \text{ (no forced-air cooling)}$$

Required rated current I_n of the SITOR fuse link:

$$I_n \geq I_{max} \times \frac{1}{k_U \times k_Q \times k_\lambda \times k_1 \times VL} =$$

$$435 \text{ A} \times \frac{1}{1.02 \times 0.91 \times 1.0 \times 1.0 \times 1.0} = 469 \text{ A}$$

Varying load with known load cycle

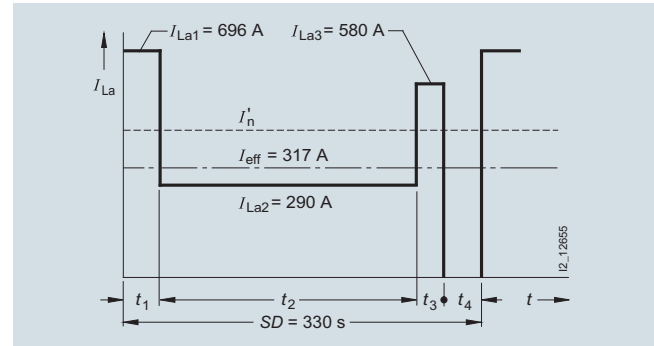

Direct current:

$$I_{d1} = 1200 \text{ A} \quad t_1 = 20 \text{ s}$$

$$I_{d2} = 500 \text{ A} \quad t_2 = 240 \text{ s}$$

$$I_{d3} = 1000 \text{ A} \quad t_3 = 10 \text{ s}$$

$$I_{d4} = 0 \text{ A} \quad t_4 = 60 \text{ s}$$

Fuse current:

$$I_{La1} = 1200 \times 0.58 = 696 \text{ A}$$

$$I_{La2} = 500 \times 0.58 = 290 \text{ A}$$

$$I_{La3} = 1000 \times 0.58 = 580 \text{ A}$$

rms value of load current

$$I_{rms} = \sqrt{\frac{696^2 \times 20 + 290^2 \times 240 + 580^2 \times 10}{330}} = 317 \text{ A}$$

Selected:

SITOR 3NE3333 fuse link
(450 A/1000 V), $VL = 1$

Breaking I^2t value $I^2t_A = 175 \times 10^3 \times 0.53 = 93 \times 10^3 \text{ A}^2\text{s}$

Test cross-section to 172: 320 mm²

The following correction factors are to be applied:

$$k_U = 1.02 \quad (\vartheta_U = +35 \text{ }^\circ\text{C})$$

$$k_Q = 0.94 \text{ (conductor cross-section, double-ended, 50 \% of test cross-section)}$$

$$k_\lambda = 1.0 \text{ (conduction angle } \lambda = 120^\circ)$$

$$k_1 = 1.0 \text{ (no forced-air cooling)}$$

1. Required rated current I_n of the SITOR fuse link:

$$I_n \geq I_{rms} \times \frac{1}{k_U \times k_Q \times k_\lambda \times k_1 \times VL} =$$

$$317 \text{ A} \times \frac{1}{1.02 \times 0.94 \times 1.0 \times 1.0 \times 1.0} = 331 \text{ A}$$

Permissible load current I_n' of the selected fuse link:

$$I_n' = k_U \times k_Q \times k_\lambda \times k_1 \times VL \times I_n = 1.02 \times 0.94 \times 1.0 \times 1.0 \times 1.0 \times 450 = 431 \text{ A}$$

2. Checking the permissible overload duration of current blocks exceeding the permissible fuse load current I_n' .

Previous load ratio:

$$V = \frac{I_{rms}}{I_n'} = \frac{317}{431} = 0.74$$

Residual value factor RV : for $V = 0.74$ from curve a (characteristic curve [page 177](#), frequent surge/load cycle currents) $RV = 0.2$

Current block I_{La1} : Melting time t_{vs} : 230 s (from time/current characteristic curve for 3NE3 333)

$$t_{vs} \times RV = 230 \text{ s} \times 0.2 = 46 \text{ s} > t_1$$

Current block I_{La3} : Melting time t_{vs} : 1200 s (from time/current characteristic curve for 3NE3 333)

$$t_{vs} \times RV = 1200 \text{ s} \times 0.2 = 240 \text{ s} > t_3$$

Fuse Systems

SITOR Semiconductor Fuses

Configuration

Occasional surge load from preloading with unknown surge outcome

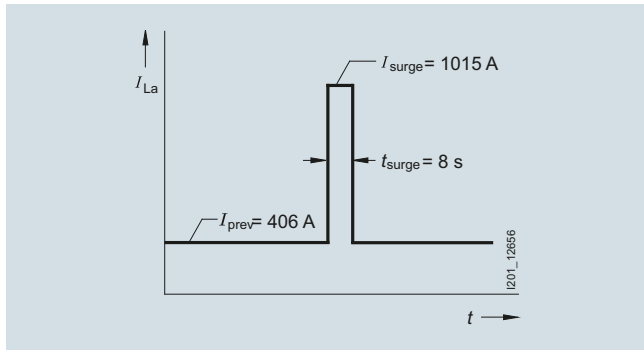

Direct current:

$$I_{dprev} = 700 \text{ A}$$

$$I_{dsurge} = 500 \text{ A} \quad t_{surge} = 8 \text{ s}$$

Fuse current:

$$I_{prev} = I_{dprev} \times 0.58 = 406 \text{ A}$$

$$I_{surge} = I_{dsurge} \times 0.58 = 1015 \text{ A}$$

Let us assume the conditions

$$t_{pause} \geq 3 t_{surge} \text{ and } t_{pause} \geq 5 \text{ min are met.}$$

Selected:

SITOR 3NE3333 fuse link

(560 A/1000 V), $VL = 1$

$$\text{Breaking } I^2t \text{ value } I^2t_a = 360 \times 10^3 \times 0.53 = 191 \times 10^3 \text{ A}^2\text{s}$$

Test cross-section to 172: 400 mm²

The following correction factors are to be applied:

$$k_u = 1.02 \text{ (}\vartheta_u = +35 \text{ °C)}$$

$$k_q = 0.91 \text{ (conductor cross-section, double-ended, 40 \% of test cross-section)}$$

$$k_\lambda = 1.0 \text{ (conduction angle } \lambda = 120^\circ)$$

$$k_1 = 1.0 \text{ (no forced-air cooling)}$$

1. Required rated current I_n of the SITOR fuse link:

$$I_n \geq I_{prev} \times \frac{1}{k_u \times k_q \times k_\lambda \times k_1 \times VL} =$$

$$406 \text{ A} \times \frac{1}{1.02 \times 0.91 \times 1.0 \times 1.0 \times 1.0} = 437 \text{ A}$$

Permissible load current I_n' of the selected fuse link:

$$I_n' = k_u \times k_q \times k_\lambda \times k_1 \times VL \times I_n =$$

$$1.02 \times 0.91 \times 1.0 \times 1.0 \times 1.0 \times 560 = 520 \text{ A}$$

2. Checking the permissible overload duration of the surge current I_{surge}

Previous load ratio:

$$V = \frac{I_{prev}}{I_n'} = \frac{406}{520} = 0.78$$

Residual value factor RV for $V = 0.78$ from curve a (characteristic curve [page 177](#), frequent surge/load cycle currents)

$RV = 0.18$ surge current I_{surge} : Melting time t_{vs} : 110 s

(from time/current characteristic curve for 3NE3333)

$$t_{vs} \times RV = 110 \text{ s} \times 0.18 = 19.8 \text{ s} > t_{surge}$$

correction factors [can be found on page 172 and page 173](#).

Overview

Special demands are made on fuses for application in photovoltaic systems. These fuses have a high DC rated voltage and a tripping characteristic specially designed to protect PV modules and their connecting cables (the newly defined operational class gPV). It is also crucial that the PV fuses do not age in spite of strongly alternating load currents, in order to ensure high plant availability throughout the service life of the PV system. The fuses must also be able to withstand high temperature fluctuations without damage. These requirements were only incorporated into an international standard in recent years and have now been published as IEC 60269-6.

All Siemens photovoltaic fuse systems comply with this new standard. Furthermore, they also already comply with the recently agreed corrections to the characteristic curves, which will be incorporated in the next standard update.

The IEC cylindrical fuses used as phase fuses also correspond to the characteristic curves specified in UL standard UL 2579. The non-fusing current I_{nf} and fusing current I_f test currents are crucial to the shape of the characteristic curves.

Standard	I_{nf}	I_f
Current IEC standard	$1.13 \times I_n$	$1.45 \times I_n$
UL standard	$1.0 \times I_n$	$1.35 \times I_n$
Future IEC standard	$1.05 \times I_n$	$1.35 \times I_n$
Siemens fuses	$1.13 \times I_n$	$1.35 \times I_n$

These test currents of gPV phase fuses to 32 A apply to a conventional test duration of one hour; at I_{nf} , the fuse must not trip within an hour, at I_f , it must trip within an hour.

The PV cylindrical fuses of size 10 mm x 38 mm offer an especially space-saving solution for the protection of the strings.

The fuse holders of size 10 x 38 mm can be supplied in single-pole and two-pole versions with and without signal detectors. In the case of devices with signal detector, a small electronic device with LED is located behind an inspection window in the plug-in module. If the inserted fuse link is tripped, this is indicated by the LED flashing. The devices have a sliding catch that enables removal of individual devices from the assembly. The in-feed can be from the top or the bottom. Because the cylindrical fuse holders are fitted with the same anti-slip terminals at the top and the bottom, the devices can also be bus-mounted at the top or the bottom.

The PV fuses in LV HRC design are usually used as cumulative fuses upstream of the inverter. In addition, they can also be used for protecting groups (PV subarrays). For the PV cumulative fuses of size 1, the standard LV HRC fuse bases are available. For PV cumulative fuses of size 1L, 1XL, 2L, 2XL and 3L, we have developed a special 3NH7...-4 fuse base with a swiveling mechanism which combines maximum touch protection with maximum user-friendliness. This makes it possible to change fuses safely and without the need for any tools, such as a fuse handle. This provides safe and fast access even in an emergency.

Our cylindrical fuse holders and fuse bases with swiveling mechanism comply with the IEC 60269-2 standard and are considered fuse disconnectors as defined in the IEC 60947 switchgear and controlgear standard. Under no circumstances are they suitable for switching loads.

To ensure that PV fuses are correctly selected and dimensioned, the specific operating conditions and the PV module data must be taken into account when calculating voltage and current ratings.

Benefits

- Protection of the modules and their connecting cables in the event of reverse currents
- Safe tripping in case of fault currents reduces the risk of fire due to DC electric arcs
- Safe isolation when the fuse holder/fuse base is open



PV cylindrical fuse system, 3NH70...-4, 3NH60...-4







PV LV HRC fuse systems, 3NH73...-4, 3NE13...-4

Fuse Systems

Photovoltaic Fuses

PV cylindrical fuses

Technical specifications

		Cylindrical fuse links		Cylindrical fuse holders	
		3NW60..-4	3NW66..-4	3NW70..-4	3NW76..-4
Size	mm x mm	10 x 38	10 x 85		
Standards		IEC 60269-6		IEC 60269, IEC 60269-2, IEC 60947, UL 4248-1, -18	IEC 60269, IEC 60269-2, IEC 60947, UL 4248-1, -18
Approvals		UL 248-13, waiver certification for China (2 to 16 A)	 (File No. E469670)	 (File No. E355487),  (versions without signal detector)	 (E355487)
Operational class		gPV			
Rated voltage U_n	V DC	1000	1500 (20 A: 1200 V)	1000	1500
Rated current I_n	A DC	2 to 20	4 to 20	30	32
Rated short-circuit strength	kA	--		30	
Rated breaking capacity	kA DC	30	10	--	
Breaking capacity • Utilization category		--		AC-20B, DC-20B	
Max. power dissipation of the fuse link	W	--		4	6
Rated impulse withstand voltage	kV	--		6	--
Overvoltage category		--		II	--
Pollution degree		--		2	--
No-voltage changing of fuse links		--		Yes	
Sealable when installed		--		Yes	
Mounting position		Any, preferably vertical			
Current direction		--		Any (signal detector with antiparallel LED)	
Degree of protection acc. to IEC 60529		--		IP20, with connected conductors ¹⁾	
Terminals with touch protection acc. to BGV A3 incoming and outgoing feeder		--		Yes	
Ambient temperature	°C	-25 to +55°C, humidity 90 % at +20°C			
Conductor cross-sections • Finely stranded, with end sleeve • AWG (American Wire Gauge)	mm ² AWG	--		0.75 ... 25 18 ... 4	
Tightening torque	Nm	--		2.5	

¹⁾ Degree of protection IP20 is tested according to regulations using a straight test finger (from the front), with the device mounted and equipped with a cover, housing or some other enclosure.

Characteristic curves

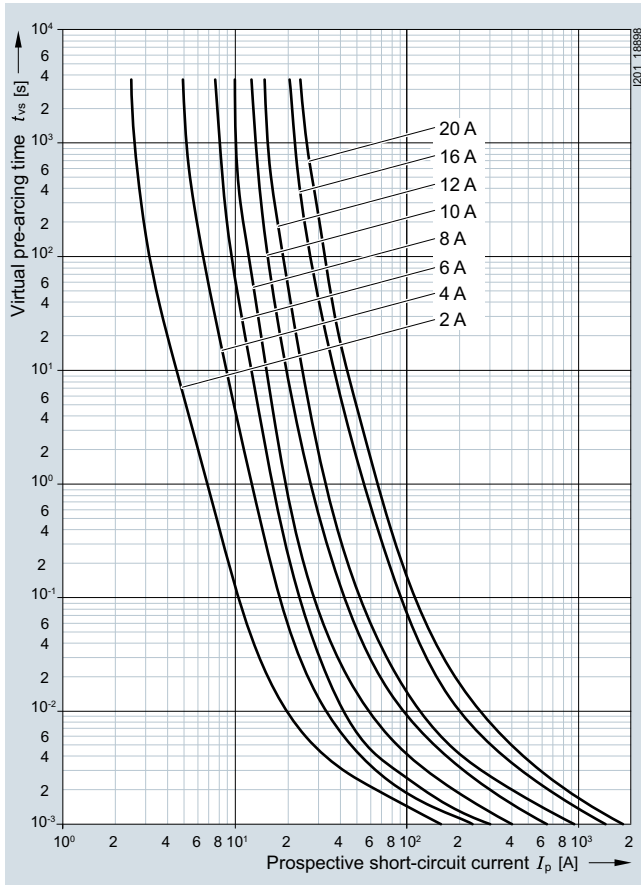

Time/current characteristics diagram 3NW600.-4

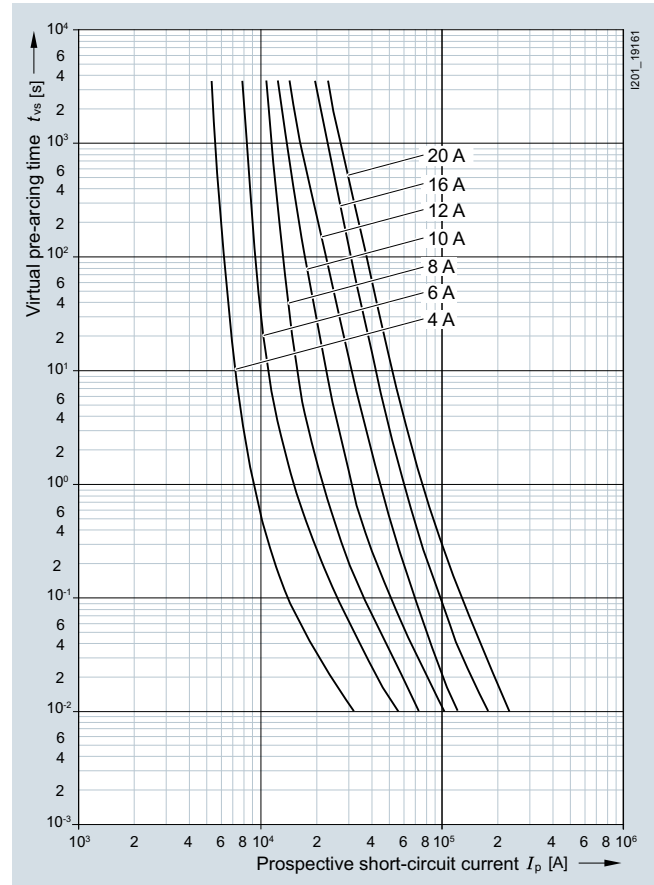

Time/current characteristics diagram 3NW660.-4

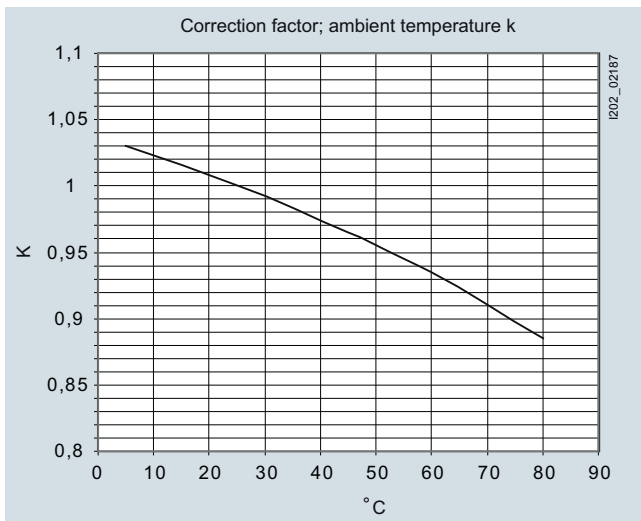

Characteristic curves diagram Correction factor Ambient temperature

Fuse Systems

Photovoltaic Fuses

PV cylindrical fuses

Dimensional drawings

3NW600.-4

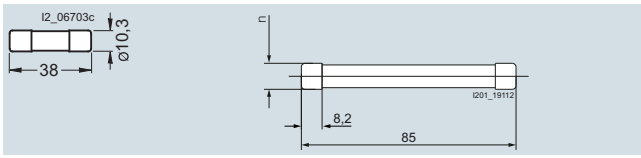

10 x 38 mm

3NW660.-4

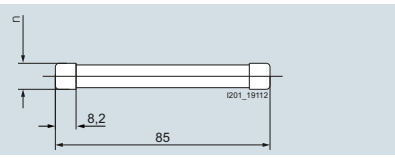

10 x 85 mm

3NW7613-4

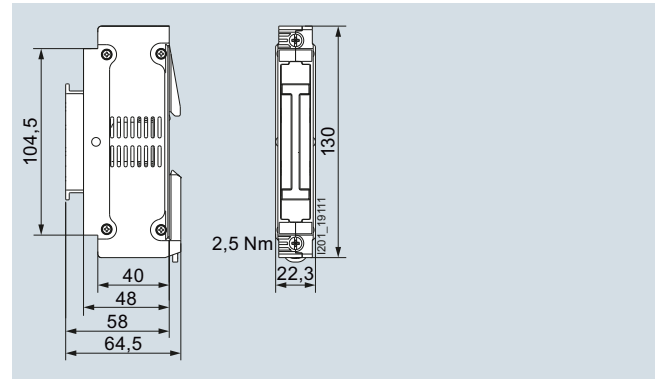

3NW70..-4

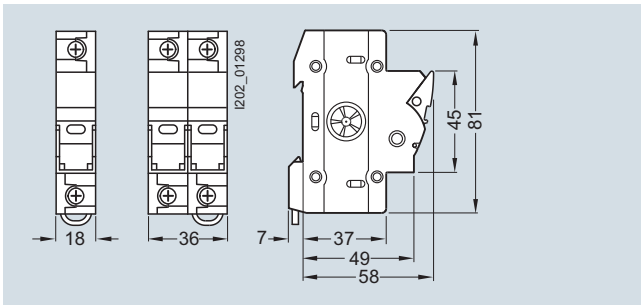

1-pole

2-pole

Circuit diagrams

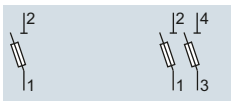

1-pole

2-pole

More information

Selecting and dimensioning photovoltaic fuses from Siemens

Standards:

The contents of the new standard IEC 60269-6 are currently being drawn up.

We follow this new standard when rating and labeling our PV fuses. Until now, some of our rivals have been relying on products based on the standard IEC 60269-4 "Fuses for semiconductor protection". Differences between the two standards are particularly evident for the rated voltage and the test voltage and in the definition of the operational class.

Terms:

$U_{OC\ STC}$ (also called $V_{OC\ STC}$)¹⁾

Voltage under standard test conditions on an unloaded string taking into account minimum ambient temperature (no-load voltage). The voltage $U_{OC\ STC}$ of a string is obtained by multiplying the single voltages $U_{OC\ STC}$ of a PV module ($U_{OC\ STC} \times M$ ²⁾).

$I_{SC\ STC}$

Short-circuit current of a PV module, a PV string, a PV sub-generator or a PV generator under standard test conditions

I_{MPP}

Is the largest possible working current of a string (MPP = Maximum Power Point).

$I_{P\ max}$

Is the maximum occurring load current; this is usually equivalent to I_{MPP} .

$I_{SC\ MOD}$

Short-circuit current of a PV module under regional conditions.

Standard test conditions (STC)

Test conditions that are laid down in EN 60904-3 for PV cells and PV modules:

- Solar radiation 1000 W/m²
- Ambient temperature 25 °C
- Air distribution (AM) 1.5

Standard test conditions are normally specified by the manufacturer of the PV module in data sheets.

Operational class

We use draft standard IEC 60269-6 as a guide when naming the operational class gPV. Accordingly, the symbols are also on the fuse:

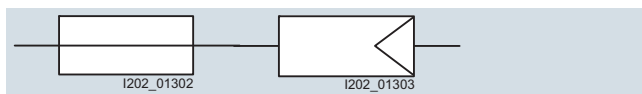

It is important that the fuse has a full-range characteristic that can cut off with certainty all possible fault currents, and especially also small fault currents³⁾.

The test currents for PV fuses are defined in draft standard IEC 60269-6.

$I_{nf} = 1.13 \times I_n$ (test current at which the fuse must not trip for one hour).

$I_f = 1.45 \times I_n$ (test current at which the fuse must trip within one hour).

For the time/current characteristic curve diagram, see page 187.

Rated making and breaking capacity

Under draft standard IEC 60269-6 a rated breaking capacity of at least 10 kA is required. While this is comparatively low compared with other fuses, it is more than adequate for handling the fault currents occurring in PV systems.

We have tested our PV fuses at 30 kA.

Dimensioning rules

PV fuses are to be dimensioned according to special rules with regard to rated voltage, rated current and operational class (characteristic).

Dimensioning rule

The rated voltage⁴⁾ of the fuse should be calibrated 20 % higher than the open-circuit voltage $U_{OC\ STC}$ of a string. Extreme operating conditions, e.g. temperatures down to -25 °C, are thus taken into account.

Rated voltage

Our PV fuses have been tested according to draft standard IEC 60269-6 with the rated voltage, i.e. the test voltage is the same as the rated voltage.

Based on IEC 60269-4, some manufacturers have issued two voltage values for their fuses, e.g. 900 V (tested 1000 V).

Rated current

1. To prevent unwanted tripping of the PV fuse during normal operation and in case of a fault in a different string that is connected in parallel, the rated current of the PV fuse must be greater than the short-circuit current I_{SC} of the respective module or string: $I_n \geq 1.4 I_{SC}$.

The value 1.4 was determined in draft standard IEC 60269-6 and should apply to the simple dimensioning of the fuse.

This value contains the following correction factors for the standard test conditions:

A higher ambient temperature of 45 °C, a higher solar radiation of 1200 W/m² and the reduction due to the variable loading.

An additional reduction must be used when several fuse holders are bundled.

According to EN 60469-1, Table 1, the following reduction factors must be applied:

Number of main circuits	Rated diversity factor
2 and 3	0.9
5 and 6	0.8
6 ... 9	0.7
10 and more	0.6

Since the fuses are only operated with around 70 to 80 % of the load current, a further reduction is only necessary from around six main circuits (e.g. three two-pole devices), including also where the fuses only have maximum power dissipation of 3.4 W.

¹⁾ Voltage of the unloaded circuit under standard test conditions.

²⁾ M is the number of PV modules connected in series in a string.

³⁾ **Note:** A difference in the overload current and the short-circuit current is not meaningful when protecting PV systems, because even for a short circuit, only small currents occur, which are not designated as short-circuit currents in terms of the standards of overcurrent protective devices. Therefore in the following we shall refer to fault currents.

⁴⁾ **Note:** Unlike with mechanical switching devices, when two fuses (positive pole and negative pole) are used, you cannot count on a division of the voltage in the event of fault current tripping. Accordingly every fuse must be dimensioned with the full rated voltage.

Fuse Systems

Photovoltaic Fuses

PV cylindrical fuses

Fuses with a lower rated current have a lower power dissipation, so that the reduction is considerably less. The 10 A fuse for example has a rated power dissipation of 1.5 W, with the result that no reduction is necessary here.

In the event of extreme solar radiation a further reduction of the rated current of the fuse may be necessary.

The short circuit current $I_{SC\ MOD}$ is dependent on regional climatic conditions. Under particular climatic conditions and cloud constellations, in particular high in the mountains, higher values for the solar radiation than the 1200 W/m² used above may by all means occur (above: simplified calculation).

In order to incorporate the peak values into the calculation, we recommend using the following correction factors.

Climate zone	Max. solar radiation	Correction factor
Standard test conditions	1000 W/m ²	1
Moderate climate zone	1200 W/m ²	1.2
Moderate climate zone/high mountains	1400 ... 1600 W/m ²	1.4 ... 1.6
Africa	1400 ... 1600 W/m ²	1.4 ... 1.5

The rated current of the fuse refers to an ambient temperature of 25 °C.

Cut-off performance will change at higher temperatures.

A further reduction may be required for an ambient temperature higher than the ambient temperature used above (+45 °C).

2. To protect the modules and their connecting cables, the PV fuse should cut off fault currents reliably and in time.

Fault currents can result from faulty modules, double ground faults or incorrect wiring. The PV modules are rated in such a way that they can continuously withstand the fault current in the forward direction without any problems.

However, fault currents which flow through the string or the PV module in a reverse direction are particularly critical.

This fault current $I_{SC\ REVERSE}$ is calculated from the number of parallel connected strings $n-1$ multiplied by the short circuit current $I_{SC\ MOD}$ of a string or module.

$$I_{SC\ REVERSE} = n-1 \times I_{SC\ MOD}$$

This $I_{SC\ MOD}$ is likewise dependent on the regional circumstances described above:

$$I_{SC\ MOD} = 1.2^{1)} \times I_{SC\ STC}$$

Only above $n = 3$ parallel strings are PV phase fuses meaningful at all.

To protect the PV modules against reverse currents $I_{SC\ REVERSE}$ that have a value higher than the reverse current resistance of the PV modules $I_{MOD\ REVERSE}$, the "cut-off current" of the PV fuse must be of a smaller size than the permitted and tested reverse current resistance of the module.

You can dispense with PV fuses if the reverse current resistance of the PV modules is greater than the fault current:

$$I_{MOD\ REVERSE} > I_{SC\ REVERSE}$$

The manufacturers of the modules normally test their modules with a 1.35x reverse current for two hours.

For protection, you therefore need a fuse that trips earlier under these conditions.

The PV fuses have a "disconnect current" (generally referred to as high test current I_t), which causes the fuse to disconnect at 1.45 x the rated current in less than one hour (at the latest).

To connect the tested reverse current resistance of the PV modules $I_{MOD\ REVERSE}$ with the cut-off performance of the fuse, we recommend use of a conversion factor of 0.9.

For the rated current of the PV fuse, I_n produces the following dimensioning rules:

$$I_n \leq 0.9 \times I_{MOD\ REVERSE}$$

This does not consider possible fault currents, if any, which are fed by the back-up batteries and/or the solar converters.

Protection of the factory-fitted connecting cables of the PV modules should be mainly ensured by the manufacturer.

Connecting cables/wires of a string must generally be able to withstand n times the short-circuit current $I_{SC\ MOD}$. As with other cables and wires, the following simple relationship applies:

$$I_n \leq I_{z2}$$

If several strings connected in parallel are grouped together, the aforementioned dimensioning rules also apply. The rated current of the PV fuse group should be at least 1.2¹⁾ times greater than the total of the short-circuit currents of the group.

¹⁾ Climate zone-dependent correction factor 1.2 ... 1.6 (see the table on page 190).

²⁾ I_z is the permitted capacity of the line/cable.

Technical specifications

	Fuse links 3NE1...-4 / -4D / -4E / -5E						Fuse bases 3NH7...-4							
	1	1L	2L	3L	1XL	2XL	1	1L	2L	3L	1XL	2XL		
Size														
Standards	IEC 60269-6						IEC 60269, IEC 60269-2, IEC 60947							
Operational class	gPV													
Rated voltage U_n	V DC	1000 at time constant (L/R) 3 ms 1500 at time constant (L/R) 3 ms					1000					1500		
Rated current I_n	A DC	63 ... 160	200/250	315/400	500/630	63 ... 200	250/315	250	400			630	250	400
Rated short-circuit strength	kA	--										30		
Rated breaking capacity	kA DC	30										--		
Breaking capacity • Utilization category		--										AC-20B, DC-20B (switching without load)		
Max. power dissipation of the fuse link	W	--					40	90	110	130	90	110		
No-voltage changing of fuse links		--										Yes		
Sealable when installed		--										Yes		
Mounting position		Any, preferably vertical												
Current direction		--										Any		
Ambient temperature	°C	-25 to +55°C, humidity 90 % at +20°C												
Tightening torque	Nm	--										20		
Microswitch for "tripped" signaling 5 A/250 V AC, 0.2 A/250 V DC		In the status "fuse not blown", contacts 1 and 3 are closed.												

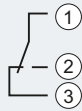

Characteristic curves

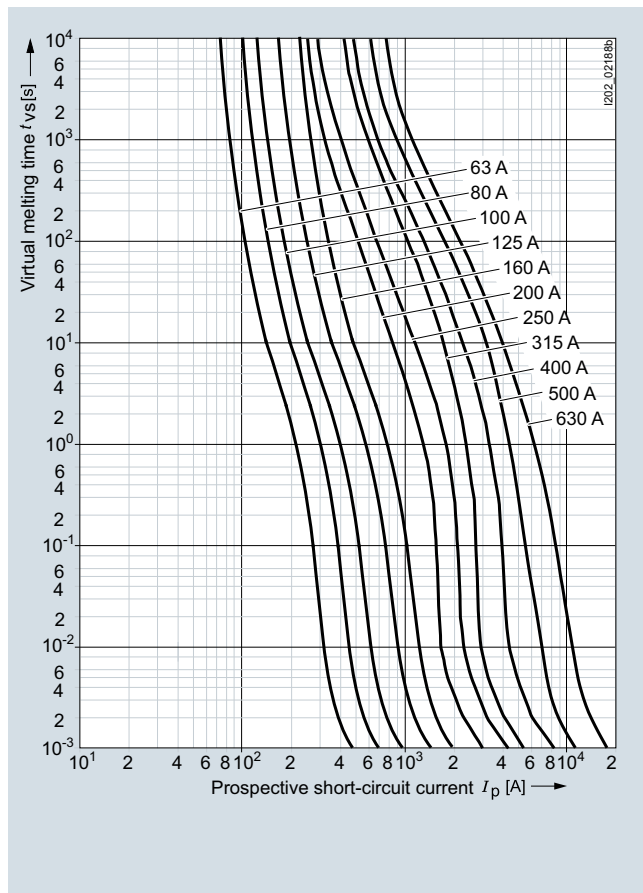

Time/current characteristics diagram 1000 V

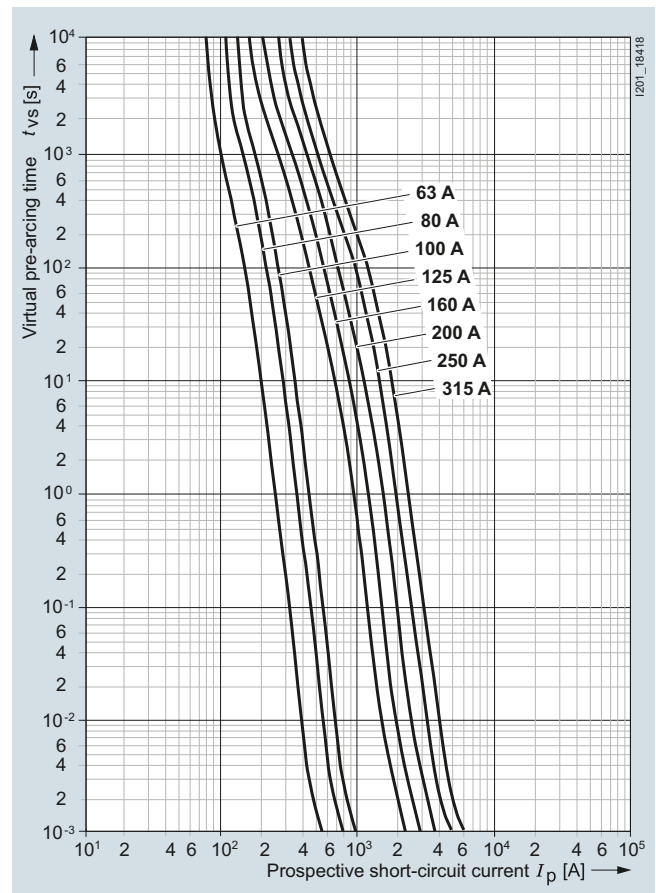

Time/current characteristics diagram 1500 V

Fuse Systems

Photovoltaic Fuses

PV cumulative fuses

Dimensional drawings

3NE1

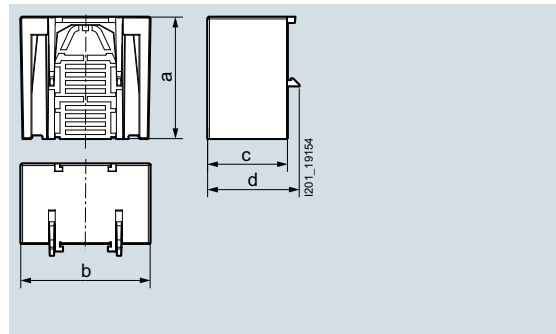
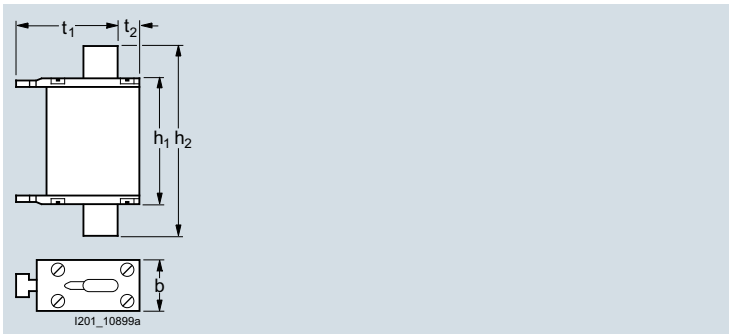

Size	I_n A	b mm	h1	h2	t1	t2
1	63 ... 160	52	66.5	135	50	13.5
1L	200, 250	52	106.5	175	50	13.5
2L	315, 400	60	106.5	189	57	15
3L	500, 630	75	125.5	201	68.5	17.5
1XL	63 ... 200	52	126.5	189	50	13.5
2XL	250, 315	60	126.5	205	57	15

Type	a mm	b	c	d
3NX3121	67	71.3	44	50.5
3NX3122	81	78.8	71	77
3NX3123	95	93.3	80	86

3NH73..-4

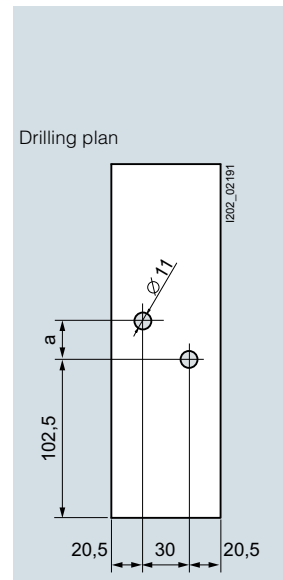
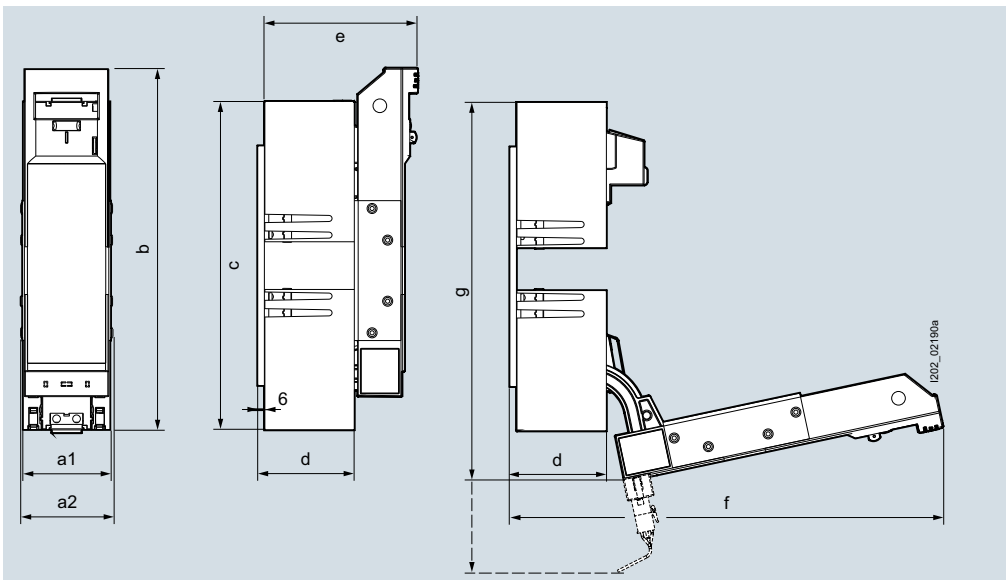

Size	Dimensions							
	a1 mm	a2	b	c	d	e	f	g
1	71.3	71.3	266	230	67	124	316.4	317.7
1L	71	75	306	270	73	130	362	313
2L	79	83	326	296	87	144	390	335
3L	93	97	341	311	101	158	418	359
1XL	71	76	325	289	73	124	380	332
2XL	79	83	341	311	87	144	410	354

Size	Dimension a mm
1	25
1L	65
2L	65
3L	80
1XL	84
2XL	80

Fuse bases with swiveling mechanism, 3NH7 3..-4

Circuit diagrams



1-pole

Siemens AG
Energy Management
Low Voltage & Products
Postfach 10 09 53
93009 REGENSBURG
GERMANY

Subject to change without prior notice
PDF (3ZW1012-3NW10-0AB1)
PH 0216 196 En
Produced in Germany
© Siemens AG 2016

The information provided in this brochure contains merely general descriptions or characteristics of performance which in case of actual use do not always apply as described or which may change as a result of further development of the products. An obligation to provide the respective characteristics shall only exist if expressly agreed in the terms of contract. Availability and technical specifications are subject to change without notice.

All product designations may be trademarks or product names of Siemens AG or supplier companies whose use by third parties for their own purposes could violate the rights of the owners.