



**RDECOM**



**OAK RIDGE NATIONAL LABORATORY**

MANAGED BY UT-BATTELLE FOR THE DEPARTMENT OF ENERGY

**Control of Hydrogen  
Embrittlement in High  
Strength Steel Using Special  
Designed Welding Wire.**



**TECHNOLOGY DRIVEN. WARFIGHTER FOCUSED.**

*Zhili Feng, Xinghua Yu, Jeff Bunn, Andrew Payzant- ORNL  
Demetrios Tzelepis, TARDEC*

- Background
  - Hydrogen Inducted Cracking (HIC)
  - HIC control principle
- New filler wire development
- Y-Groove test results
- Mechanical testing results
- Residual stress results
- Conclusions

- What is Hydrogen Induced Cracking?
  - Atomic Hydrogen can diffuse into steel at high temperatures (liquid state), in amount that exceeds the solid – solubility at low temperature.
  - At low temperatures atomic hydrogen precipitates out to form molecular hydrogen, “small voids”, along grain boundaries.
  - These voids create an internal stress where the metal has reduced tensile ductility and strength.
  - Cracking occurs when applied or residual tensile stress exceeds the reduced tensile strength of the steel.
- Fundamental factors leading to HIC.
  1. Hydrogen present to sufficient degree.
  2. Residual tensile stress
  3. A susceptible microstructure
  4. A low near ambient temperature is reached.
- **All four factors must be simultaneously present**



- Welding of Armor Steels favors all these conditions for HIC
- Hydrogen Present in Sufficient Degree
  - Derived from moisture in the atmosphere, fluxes, oils, and other contaminants.
  - Absorbed into the weld pool and transferred to the heat-affected zone (HAZ).
- Residual Tensile Stress
  - Typically present in the weld region.
    - Non-uniform heating and cooling.
    - Improper fixturing and assembly tolerances. i.e., using force to bring the assembly together for welding.
- A susceptible microstructure
  - Fast cooling in welding produces HAZ microstructures that are martensitic.
  - Often the HAZ is coarse grained.
- A low near ambient temperature
  - Welded assemblies are used at ambient room temperatures.

- Base steel plates
  - MIL-DTL-12560 and MIL-DTL-46100
  - ½” thick plates. 96”x288” each
- Steel plates supplied by ArcelorMittal through collaborative effort

Steel	C	Mn	P	S	Cu	Ni	Cr	Mo	Si	V	Ti	Al	Nb	B	N	CE
<b>12560</b>	0.23	1.2	0.005	0.002	0.17	0.12	0.12	0.45	0.25	0.003	0.025	0.025	0.001	0.002	0.008	0.56
<b>46100</b>	0.3	0.95	0.006	0.002	0.17	1	0.5	0.55	0.4	0.003	0.025	0.04	0.001	3E-04	0.007	0.74

Steel	Austenitize Temp, F	Cool from Austenitize	Temper Temp, F	Cool from Temper
12560	1660	Water	900 to 1100	Air
46100	1660	Water	400 to 450	Air

Steel	Brinell Hardness Range (3000-Kg load)	Minimum Impact Values
12560	331-375	16-25 ft. lbs.
46100	477-534	12-14 ft. lbs.

- HIC testing: Y-Groove (aka Tekken) test (ISO 17642-2)
- Chosen over other types of HIC weldability tests for its representative weld residual stress field
- Welding parameters
  - Travel speed: 8 in/min
  - Voltage: 25.9V
  - Wire feed rate: 255-280 in/min
  - Shielding gas: 98% Argon/2% O<sub>2</sub> or 75%Argon/25%CO<sub>2</sub>
- Steel plate surface grounded and cleaned to remove oxide
- All welds were made in air, without addition of moisture/hydrogen (TN weather, in lab, 50-60% humidity)

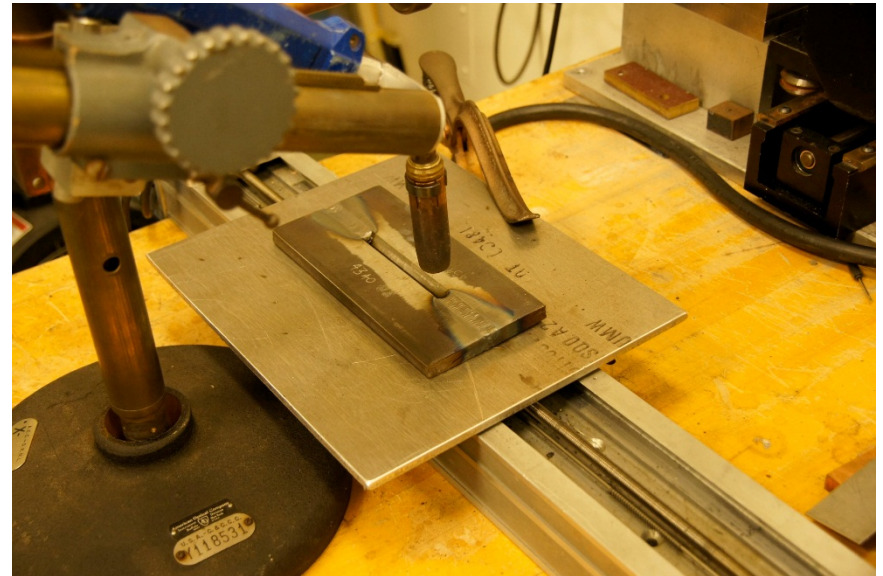
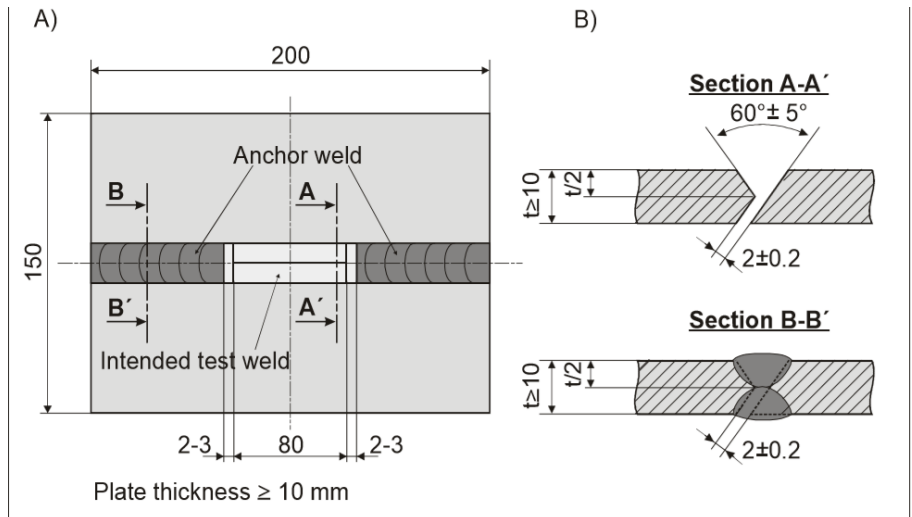

## HIC testing results

HIC crack appeared after 30-40 min.

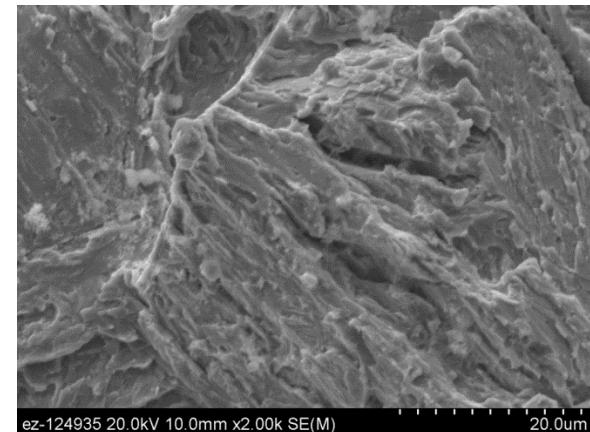
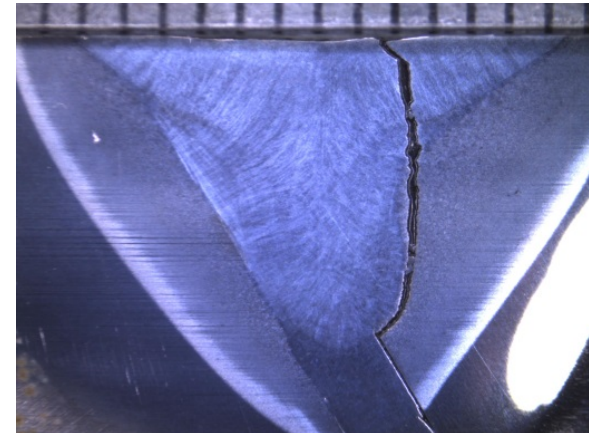
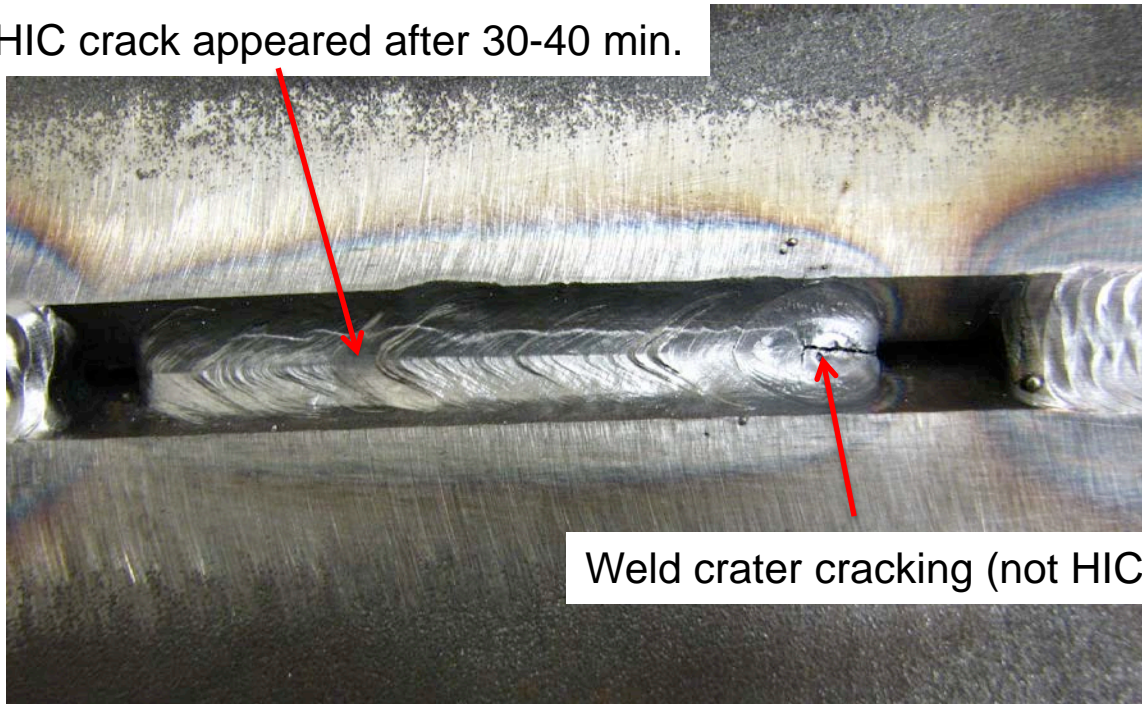

*HIC testing results on ER100S/110S*

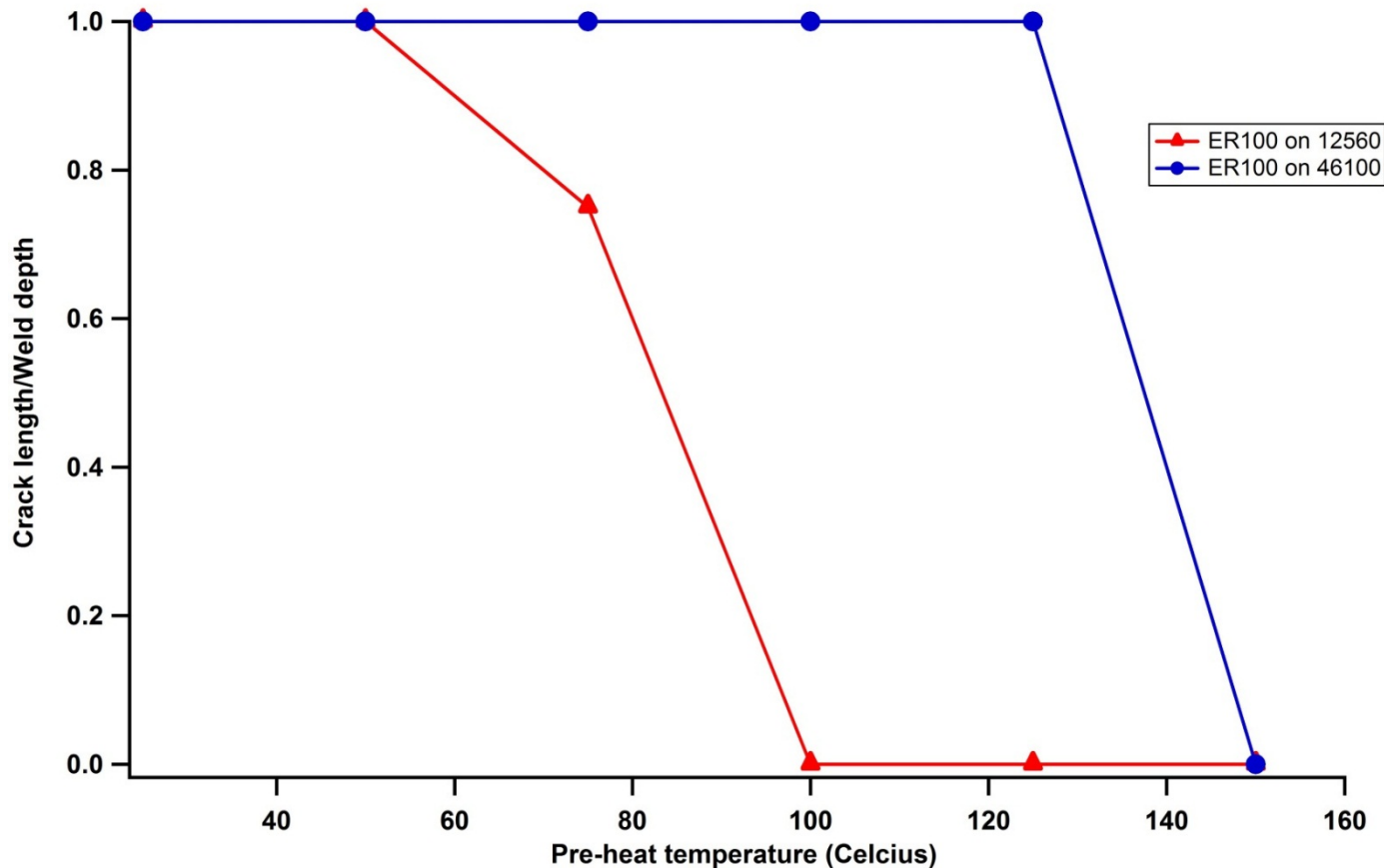

- 46100 has a high HIC tendency due to higher strength level



- Current Pathways to Prevent/Mitigate Weld HIC
  - If we eliminate one of the factors HIC does not occur.
- Option 1 - Use a different steel grades
  - HSLA, Micro-alloyed steel, i.e., non martensitic grades steels
- Option 2 - Low-Hydrogen Welding Practices.
  - Use of “low-hydrogen” electrodes
  - “Dry-baking” electrode before welding
  - Pre-heating requirement.
  - Minimum heat input requirement
- Option 1 is not a true option for the Army vehicles.
  - Would have to get away from the monocoque structures.
- Option 2 is effective when applied properly and consistently.

- Residual Stress control to Prevent/Mitigate Weld HIC
  - Over the years, post-weld heat treatment (>500 C typically) has been the only practical (and costly) approach to reduce weld residual stress.
  - In armor materials such as MIL-DTL-46100 temperatures exceeding 300 F are not allowed)
- Post-weld surface residual stress modification (long-history)
  - Principle: by means of surface plastic deformation
  - Laser shot peening, Sand blasting/peening, Low plasticity burnishing
- In-process residual stress control (**relatively new development**)
  - Principle: control and alter the “normal” thermal expansion/contraction sequence of welding
  - Special weld filler metal by means of low-temperature phase transformation (LTPT)
  - In-process proactive thermomechanical management
  - Potential benefit: no added steps in assembling

## In-process Residual Stress Control

- Special filler wire is formulated with its martensitic phase transformation temperatures designed much lower than the austenite decomposition temperature range of the base metal.
- Formation of compressive residual stress in the weld region as result of volumetric expansion of martensite through very low-temperature martensite phase transformation.
- Initial developments in Japan in 1990s for thick sectioned structures
- ORNL has been working on this technology since 1995 for several different applications (residual stress and distortion control and fatigue life improvement of steel pipelines and auto-body structures)

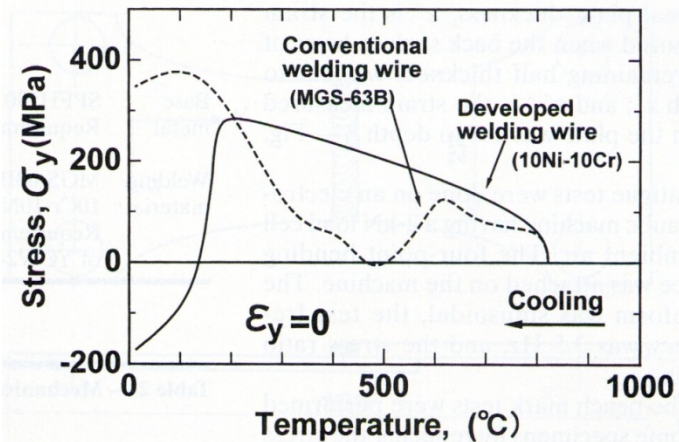
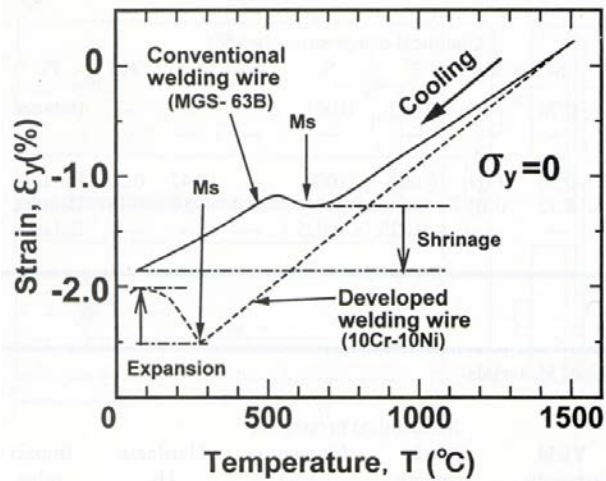

Ohta et. al. Fatigue Strength Improvement of Lap Joints of Thin Steel Plate Using Low-Transformation-Temperature Welding Wire Welding Journal, 2003, 78-S

- Filler wire design concept
  - Utilizing martensite transformation (LTPT) to reduce tensile residual stress in the weld
  - Add austenite stabilizing alloy element (e.g. Ni, Cu) to promote retained austenite formation (to trap hydrogen and slowdown diffusion into hardened HAZ.
  - Unique challenge for armored steel: match the strength and other properties of base metal
- Start with modifying the composition of commercially available martensitic weld filler wire

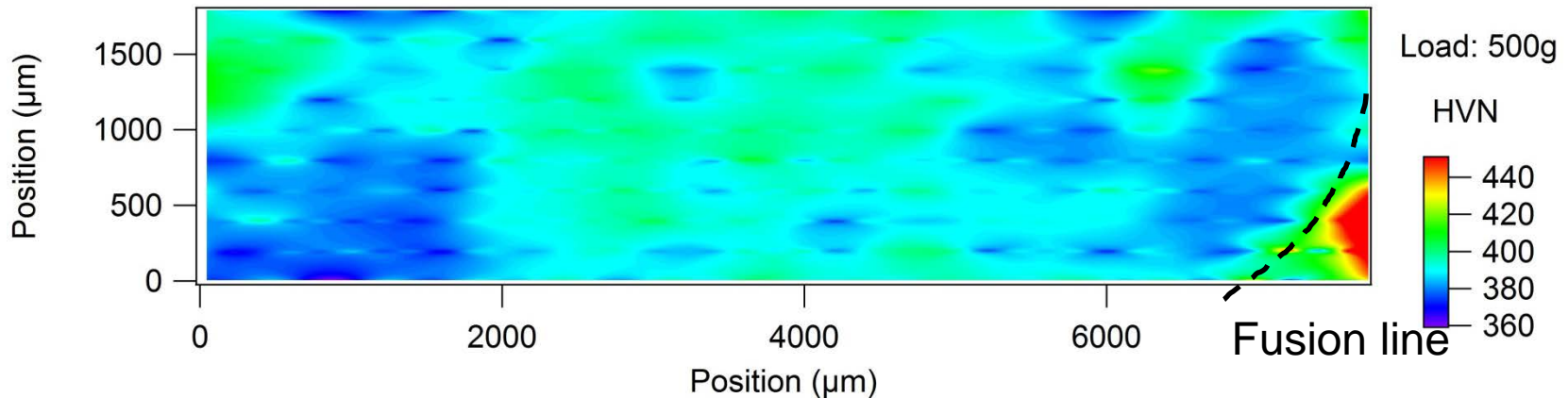

Weld metal hardness is more or less uniform. Hardness is ranging from 360 to 400 HVN, which is much higher than ER100 (300 HVN), and generally match the hardness (370HVN) of base metal MIL-12560

Weld composition was analyzed and used as the baseline for filler wire development

- Based on findings from initial previous study in this project, 5 filler wire compositions were proposed and alloys were casted
- Measured martensitic phase transformation temperature
- Characterized retained austenite and hardness



New Filler Wire ID	Ms (°C)	Mf (°C)	Austenite Fraction (vol.%)
A1	283	157	0.0
A2 (HV1764)	222	below RT	4.3
B1	294	151	3.0
B2	375	198	8.0
F	Below RT		100.0
G (HV1766)	280	80	

Using industry scale weld filler metal practices 2 heats were manufactured.

- ONRL - G = Heat HV1766
- ONRL - A2 = Heat HV1763



No pre-heat, no surface crack observed

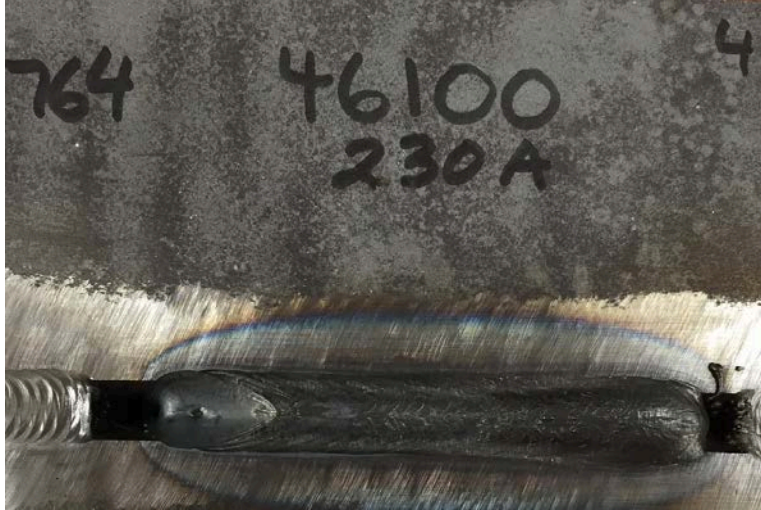

ORNL-A2  
HV1764

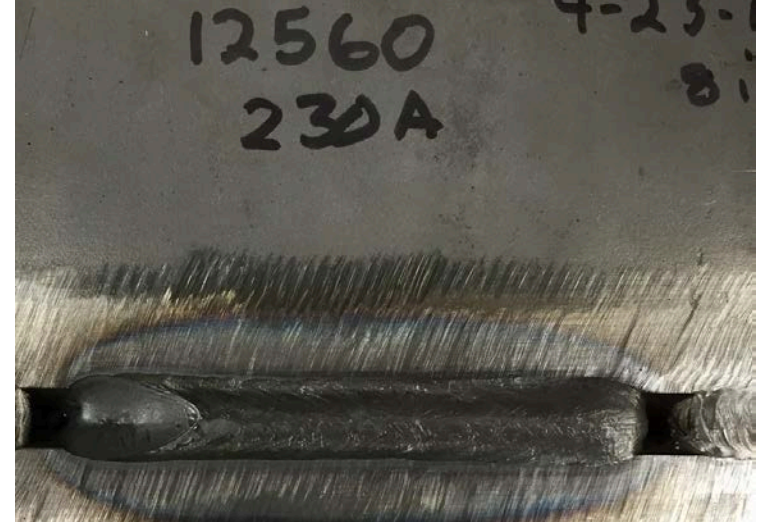

ORNL-G  
HV1766





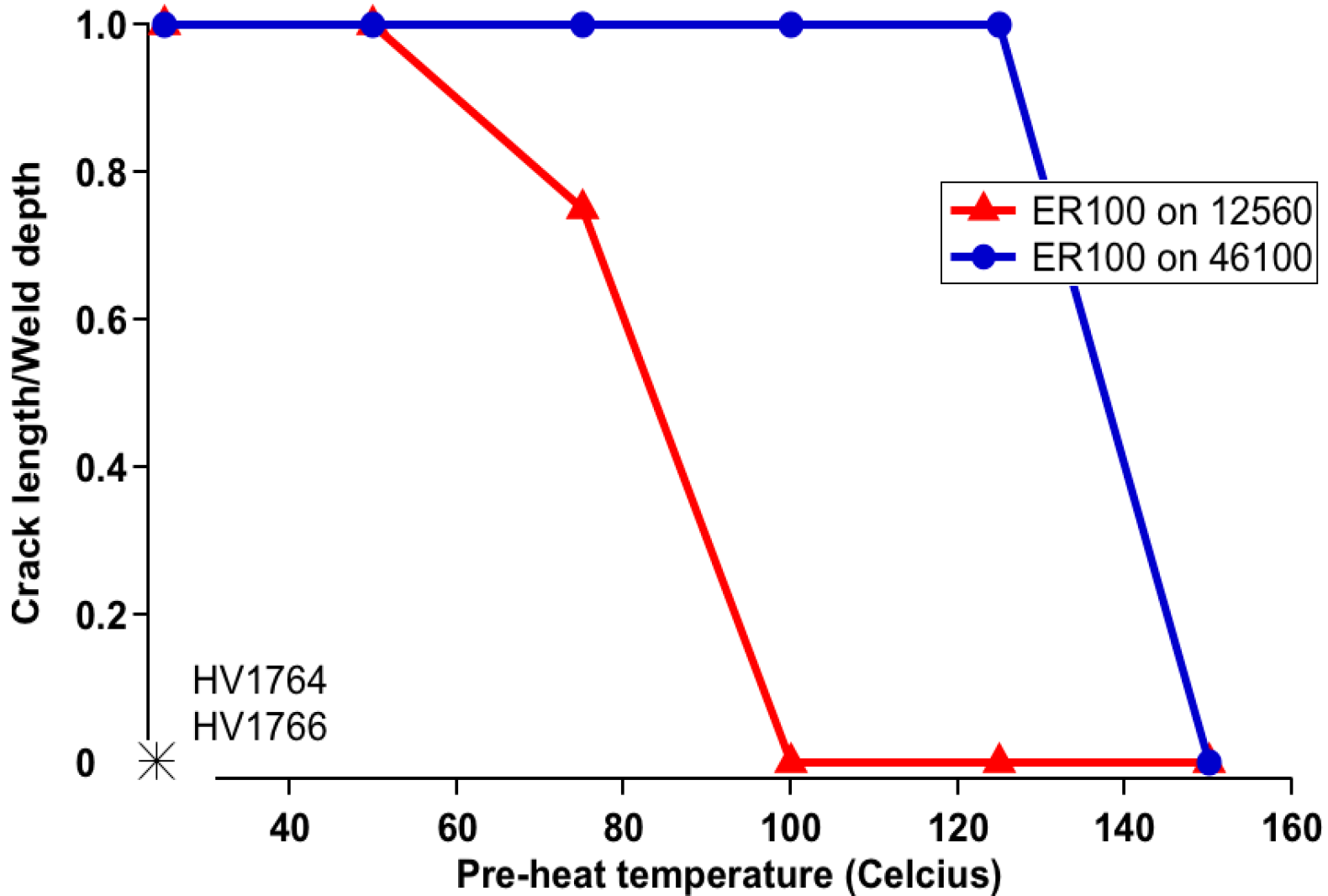

HV1764 on 12560  
Hardness is 418 HVN

HV1766 on 12560  
Hardness is 410 HVN

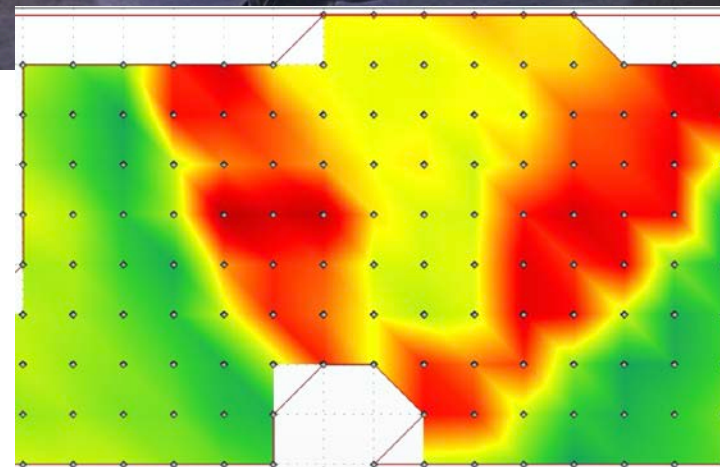
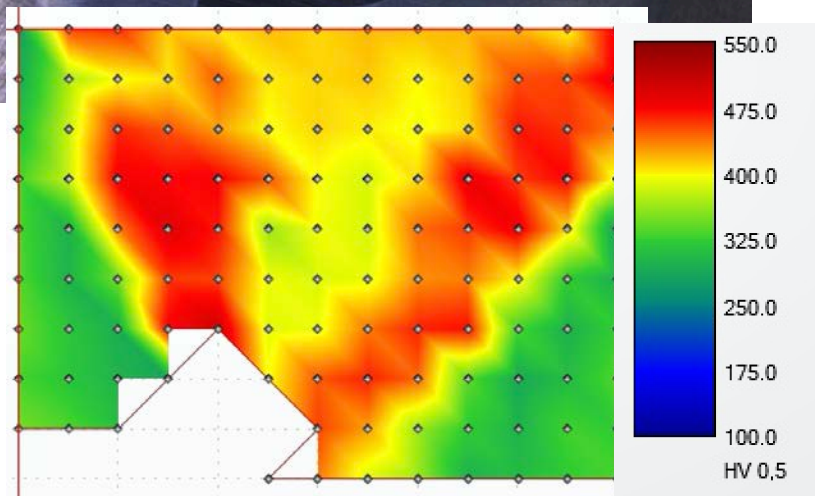
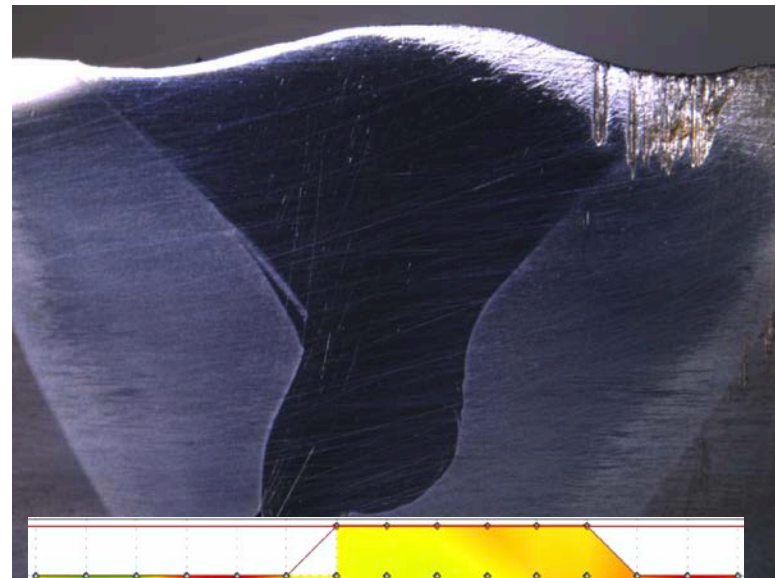
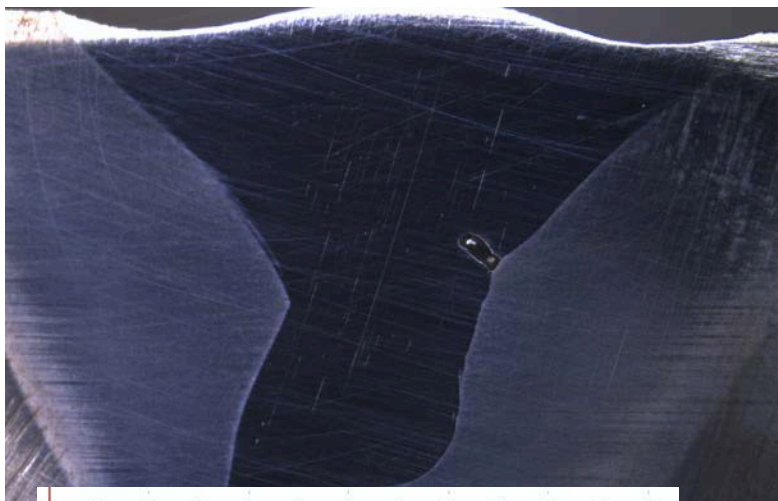

Current developed LTPT wires are resistant to HIC and with the same strength level of **12560!!!**

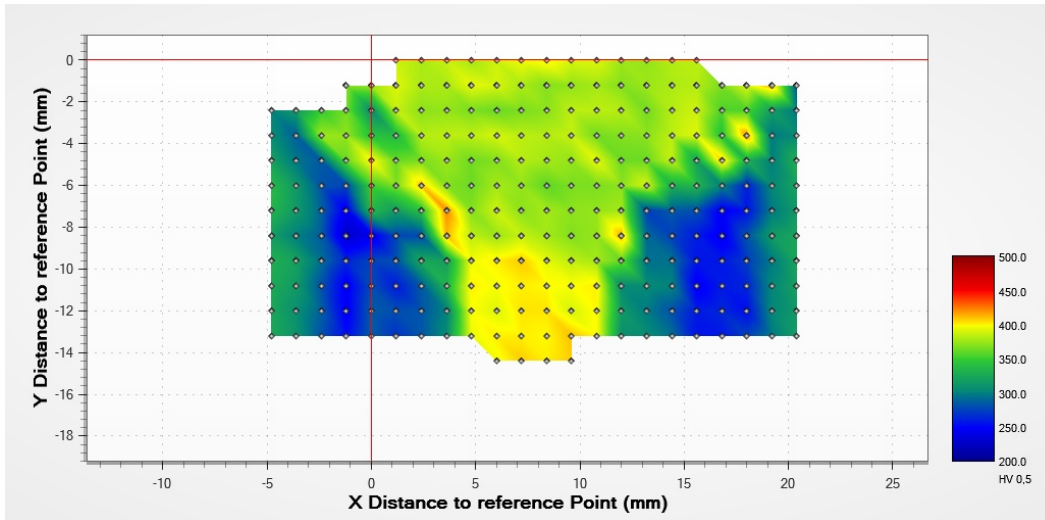

3 passes weld of HV1766 shows similar hardness distribution as Y-groove sample

EDS analysis showed dilution is about 50%.

Retained austenite measured by EBSD is less than 1 vol.%.

Low fraction of retained austenite may be due to high dilution.

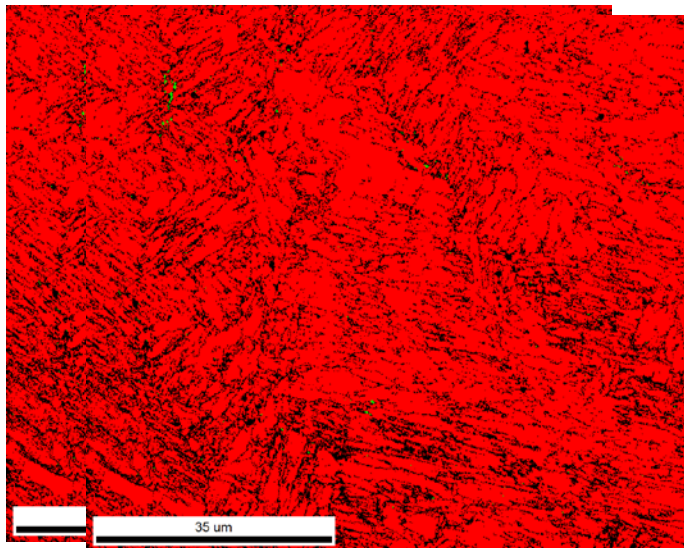

Comparison of Tensile Properties for Two weld wires HV1766 and ER100.  
MIL-DTL-12560 base metal

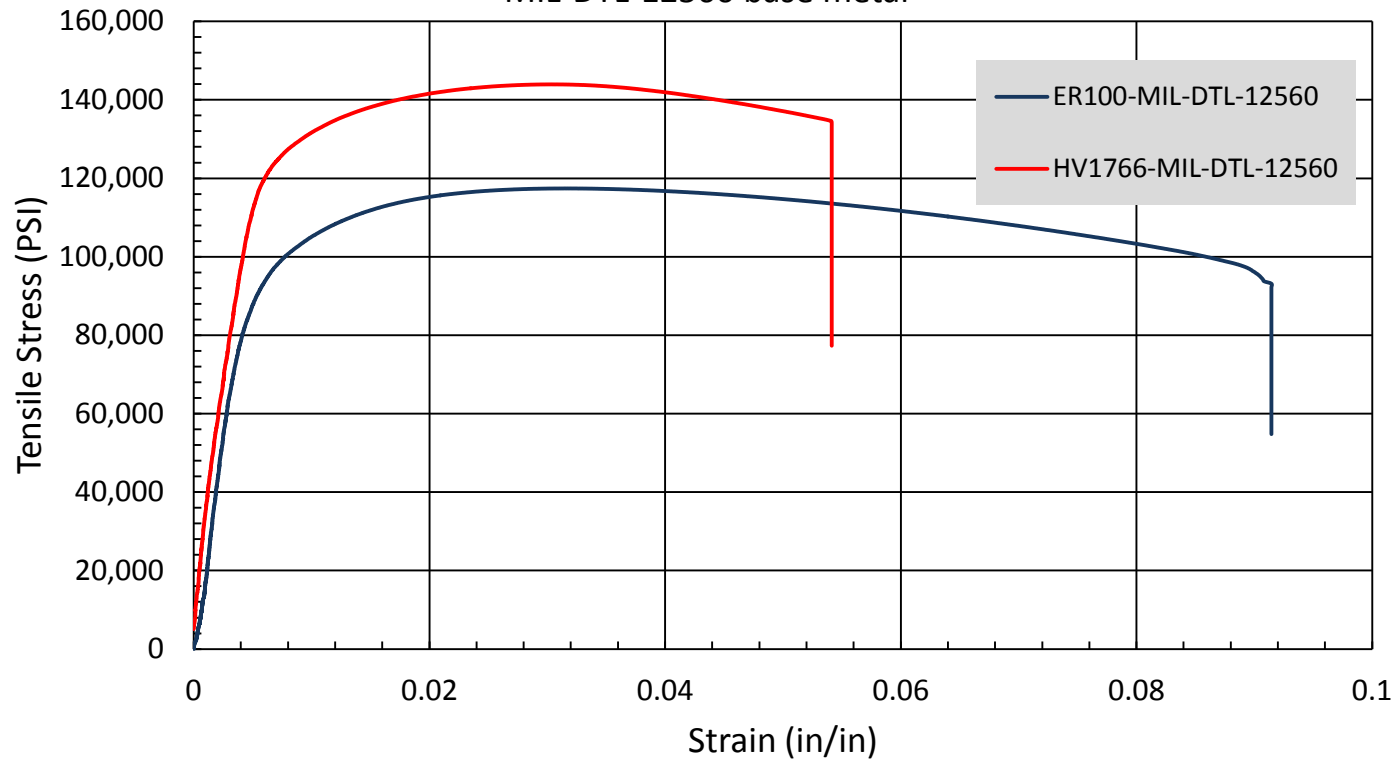

- 3 Pass weld on 1/2 inch 12560
- ER100-12560 fracture in the weld metal
- HV1766 weld wire fractured in base metal

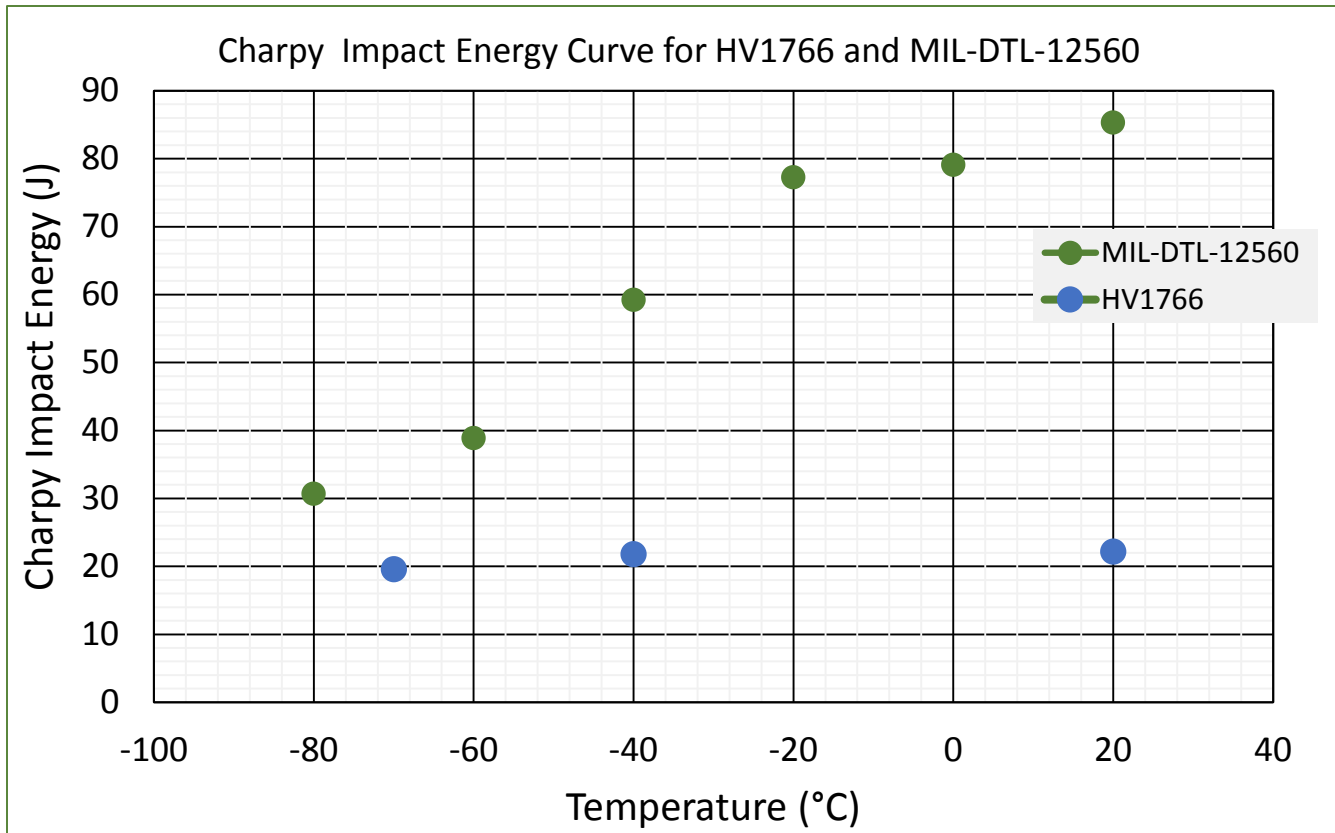

- HV1766 produced lower than expected Charpy Values.
- Causes of low toughness are being analyzed, solutions to increase the weld toughness are planned.

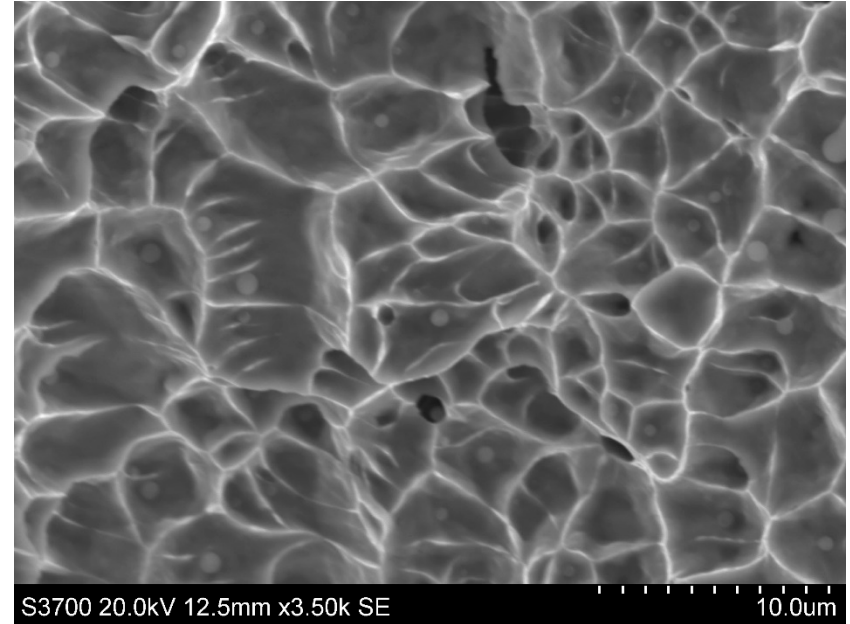
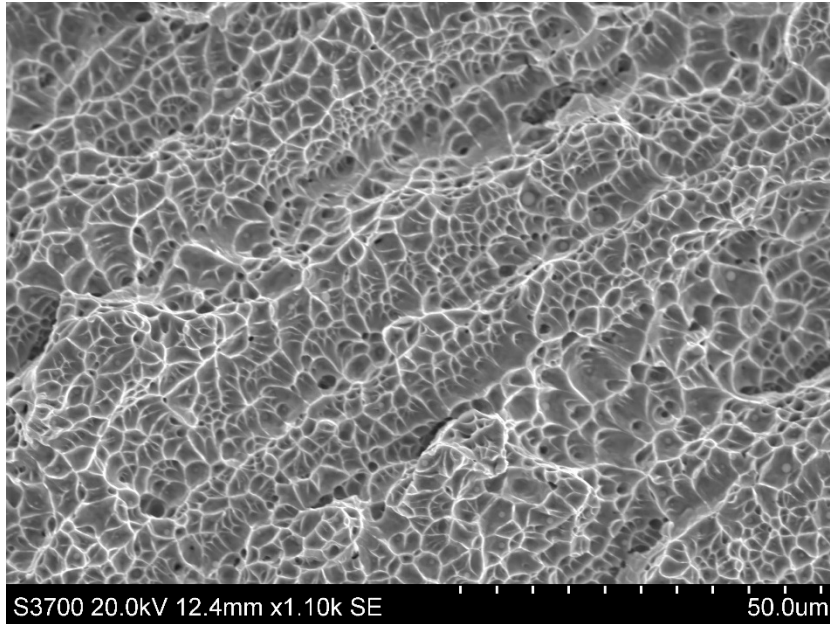

- Photograph showing the fracture surface of the charpy impact sample at room temperature. Weld wire HV1766
- A fine dispersion of Mn, Si, O inclusions were found in the fracture surface.

nrsf

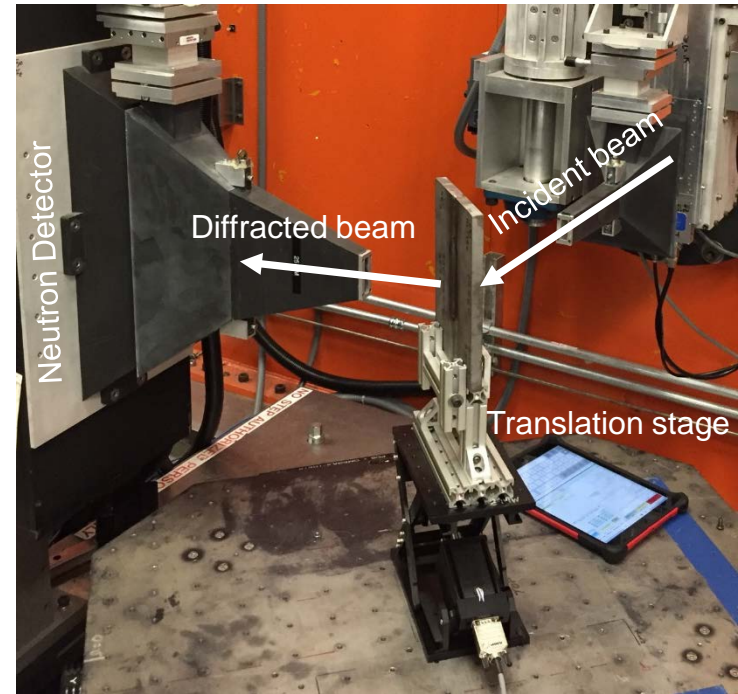
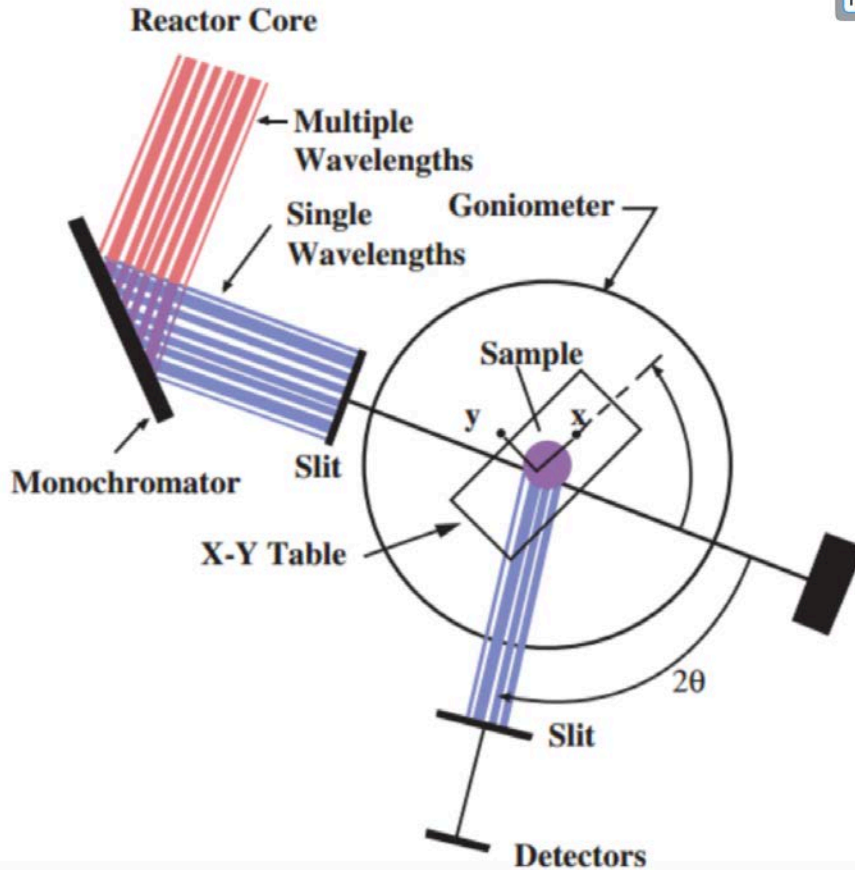

Neutron Residual Stress Setup

R. A. Lemaster et al., 2009

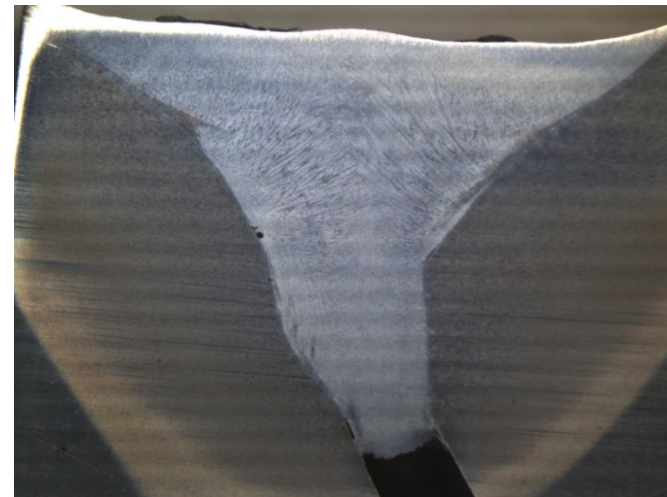
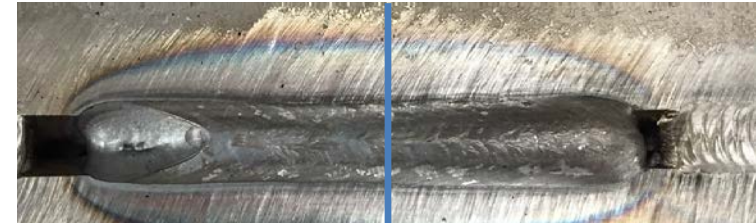
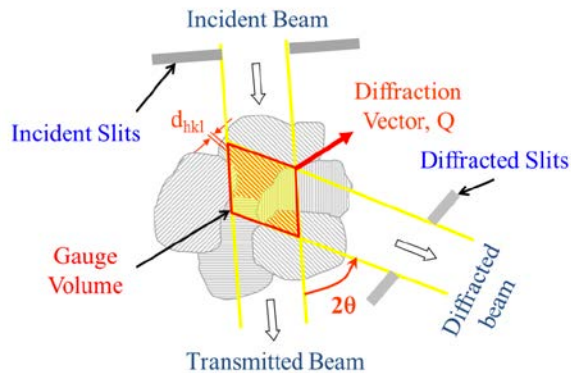

Gauge volume:

- $2 \times 2 \times 2 \text{ mm}^3$  for normal and transverse direction
- $2 \times 15 \times 2 \text{ mm}^3$  for longitudinal direction

Residual stress in the center of the weld was measured

Area of  $30 \times 5 \text{ mm}^2$  was mapped



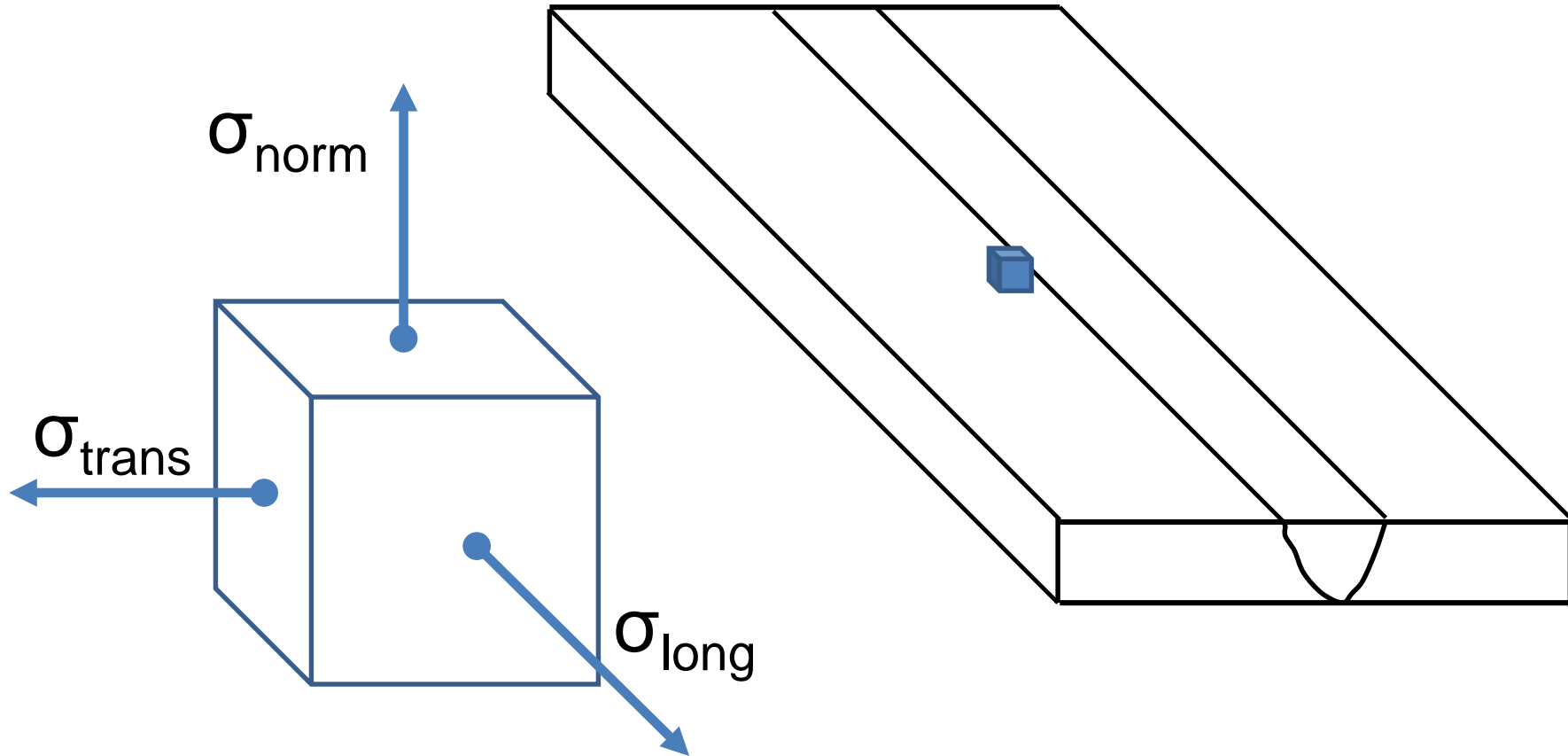

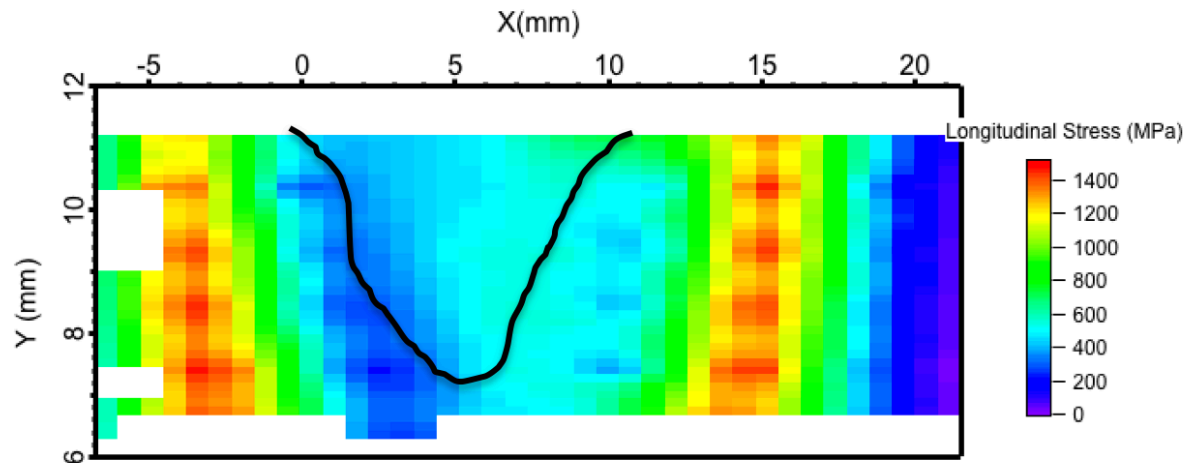
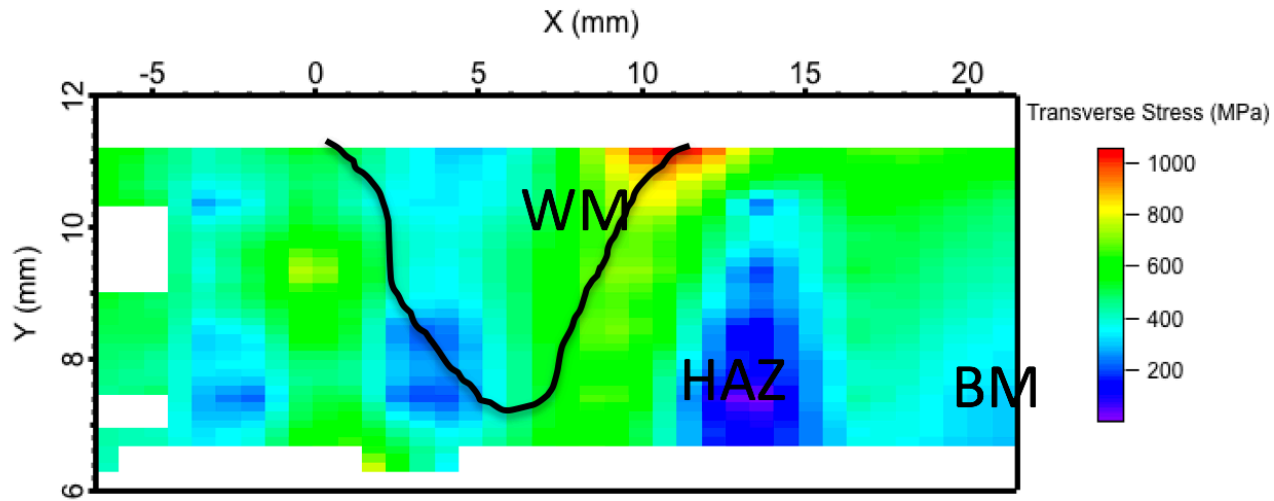

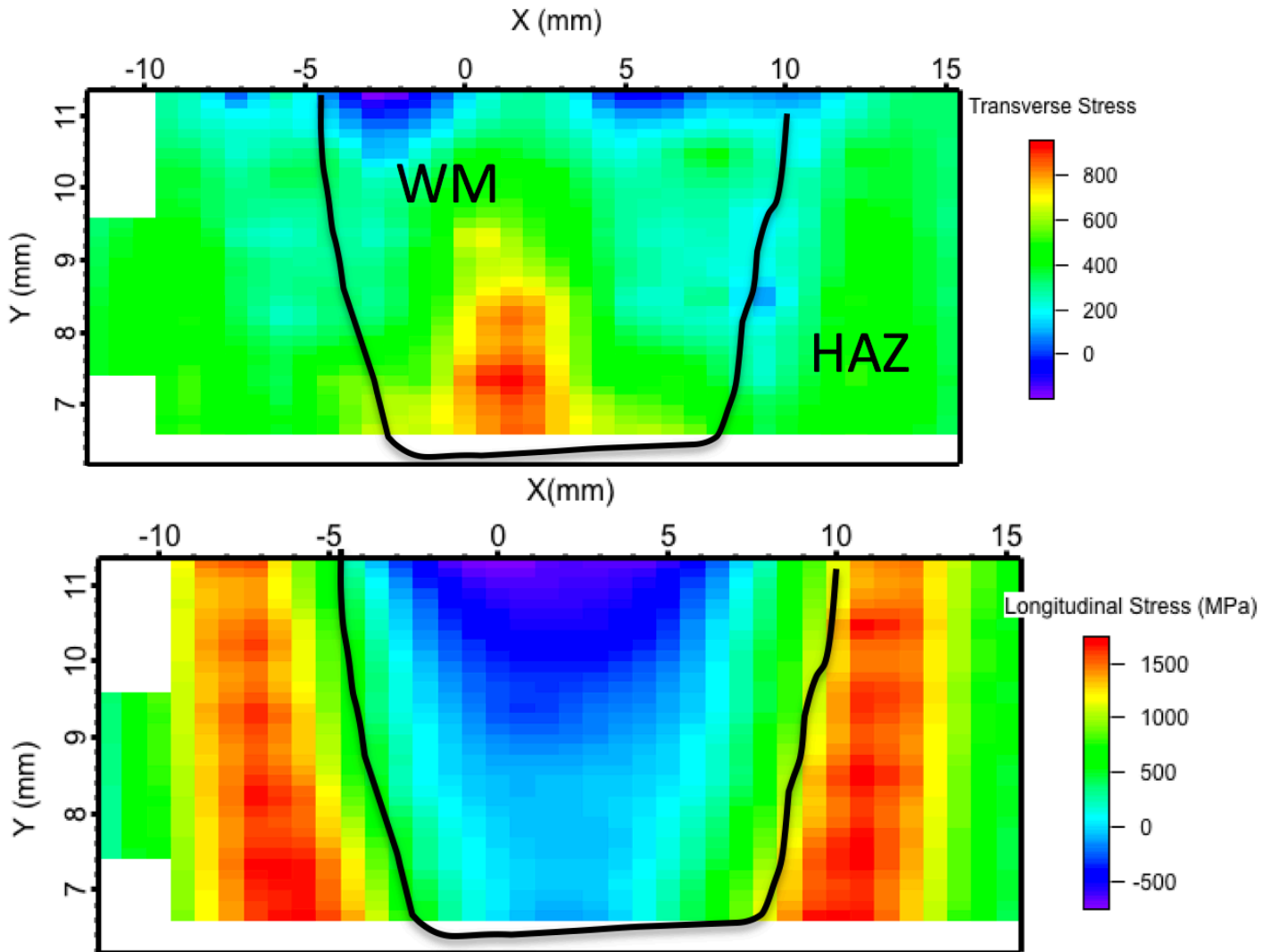

- Developed several new weld filler wire chemistries for “in-welding-process” Hydrogen Induced Cracking control.
- Two filler wire manufactured showed strong resistant to HIC.
- Experimental filler wires matches the strength level of MIL-DTL-12560
- Residual Stress were measured by neutron diffraction. Experimental wire showed reduced tensile residual stress in transverse direction and compressive residual stress in the weld in longitudinal direction.