

AD-A124 868

BOILER CONTROL SYSTEMS THEORY OF OPERATION MANUAL(U)
ULTRASYSTEMS INC IRVINE CA FEB 83 NCEL-CR-83.013
N62474-81-C-9388

1/2

UNCLASSIFIED

F/G 13/1 NL

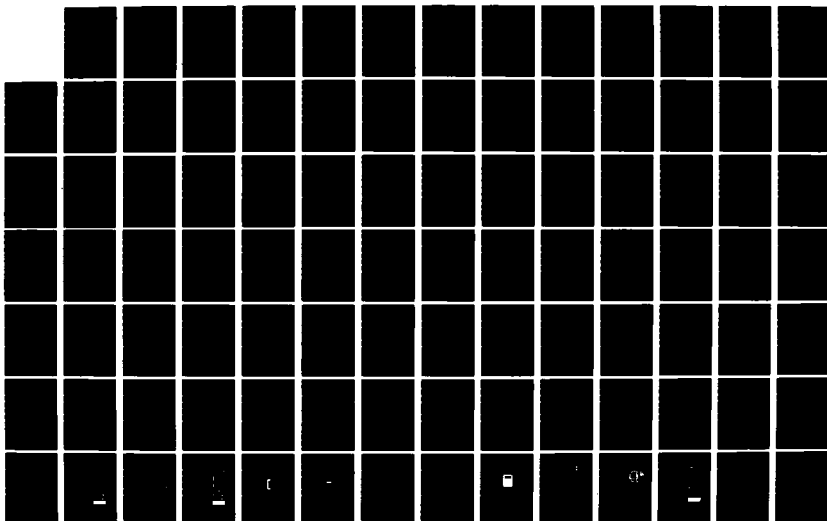

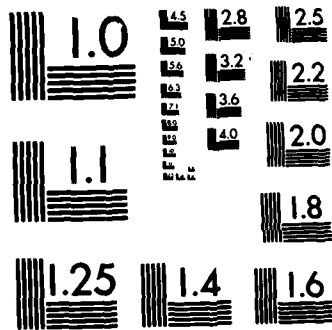

MICROCOPY RESOLUTION TEST CHART
NATIONAL BUREAU OF STANDARDS-1963-A

AD 249 8

12

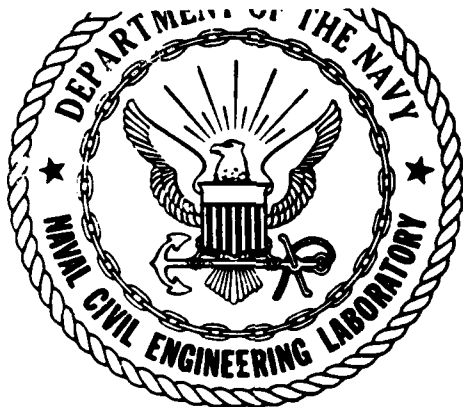

CR 83.013

NAVAL CIVIL ENGINEERING LABORATORY
Port Hueneme, California

Sponsored by
Navy Energy and Natural Resources R&D
Office, Washington, DC
Naval Facilities Engineering Command
Alexandria, Virginia

BOILER CONTROL SYSTEMS THEORY OF OPERATION MANUAL

February 1983

An Investigation Conducted by
ULTRASYSTEMS, INC.
2400 Michelson Drive
Irvine, California

N62474-81-C-9388

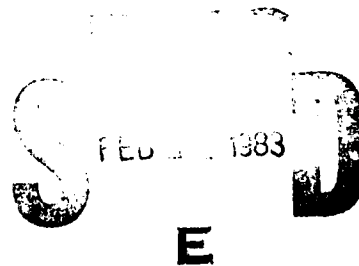

Approved for public release; distribution unlimited

DTIC FILE COPY

88 02 023 088

METRIC CONVERSION FACTORS

Approximate Conversions to Metric Measures			Approximate Conversions from Metric Measures																			
Symbol	When You Know	Multiply by	To Find	Symbol	When You Know	Multiply by	To Find	Symbol														
in ft yd mi	inches feet yards miles	2.5 30 0.9 1.6	centimeters centimeters meters kilometers	cm cm m km	mm cm m m km	0.04 0.4 3.3 1.1 0.6	inches inches feet yards miles	in in ft yd mi														
									in ² ft ² yd ² mi ²	square inches square feet square yards square miles	square centimeters square meters square kilometers hectares	cm ² m ² km ² ha	0.16 1.2 0.4 2.5	square inches square yards square miles acres	in ² yd ² mi ²							
																oz lb	ounces pounds short tons (2,000 lb)	grams kilograms tonnes	g kg t	0.035 2.2 1.1	ounces pounds short tons	oz lb
°F	Fahrenheit temperature	TEMPERATURE (exact) 5/9 (after subtracting 32)	°C	Celsius temperature	TEMPERATURE (exact) 9/5 (then add 32)	Fahrenheit temperature	°F															

*1 in = 2.54 (exactly) For other exact conversions and more detailed tables, see NBS Mon. Publ. 200, Units of Weights and Measures, Price \$5.25, 80 Catalog No. C13.10.200.

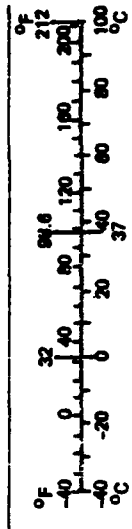

Unclassified

SECURITY CLASSIFICATION OF THIS PAGE (When Data Entered)

REPORT DOCUMENTATION PAGE		READ INSTRUCTIONS BEFORE COMPLETING FORM
1. REPORT NUMBER CR 83.013	2. GOVT ACCESSION NO. ADA124868	3. RECIPIENT'S CATALOG NUMBER
4. TITLE (and Subtitle) Boiler Control Systems Theory of Operation Manual		5. TYPE OF REPORT & PERIOD COVERED Final FY 82
		6. PERFORMING ORG. REPORT NUMBER
7. AUTHOR(s) Ultrasystems, Inc.		8. CONTRACT OR GRANT NUMBER(s) N62474-81-C-9388
9. PERFORMING ORGANIZATION NAME AND ADDRESS ULTRASYSTEMS, INC. 2400 Michelson Drive . Irvine, CA 92715		10. PROGRAM ELEMENT, PROJECT, TASK AREA & WORK UNIT NUMBERS Z0829-01-144B
11. CONTROLLING OFFICE NAME AND ADDRESS Naval Civil Engineering Laboratory Port Hueneme, CA 93043		12. REPORT DATE February 1983
		13. NUMBER OF PAGES 136
14. MONITORING AGENCY NAME & ADDRESS (if different from Controlling Office) Navy Energy and Natural Resources R&D Office, CNM, Washington, DC 20360 Naval Facilities Engineering Command Alexandria, VA 22332		15. SECURITY CLASS. (of this report) Unclassified
		15a. DECLASSIFICATION/DOWNGRADING SCHEDULE
16. DISTRIBUTION STATEMENT (of this Report) Approved for public release; distribution unlimited		
17. DISTRIBUTION STATEMENT (of the abstract entered in Block 20, if different from Report)		
18. SUPPLEMENTARY NOTES		
19. KEY WORDS (Continue on reverse side if necessary and identify by block number) Automatic control, boiler control, combustion control > For manual use		
20. ABSTRACT (Continue on reverse side if necessary and identify by block number) Report reviews the fundamentals of combustion, safety, and feedwater control systems commonly used on small industrial boilers. Report is educational material for boiler operation and maintenance personnel.		

DD FORM 1473 1 JAN 73 EDITION OF 1 NOV 55 IS OBSOLETE

Unclassified

SECURITY CLASSIFICATION OF THIS PAGE (When Data Entered)

TABLE OF CONTENTS

	<u>Page</u>
1.0 INTRODUCTION.....	1-1
2.0 BACKGROUND.....	2-1
2.1 <u>General</u>	2-1
2.2 <u>Burner Control</u>	2-1
2.3 <u>Feedwater Control</u>	2-3
2.4 <u>Flame Safety</u>	2-6
3.0 BASIC CONTROL THEORY.....	3-1
3.1 <u>General</u>	3-1
3.2 <u>Open-Loop Control</u>	3-2
3.3 <u>Closed-Loop Control</u>	3-2
3.4 <u>Control Signal Functions</u>	3-3
3.5 <u>Proportional Control</u>	3-4
3.6 <u>Integral Control</u>	3-6
3.7 <u>Derivative Control</u>	3-6
4.0 BURNER CONTROL SYSTEMS.....	4-1
4.1 <u>General</u>	4-1
4.2 <u>Parallel Positioning Control Systems</u>	4-1
4.2.1 Jackshaft System.....	4-2
4.2.2 Pneumatic Parallel Positioning System.....	4-4
4.2.3 Electric Parallel Positioning System.....	4-5
4.3 <u>Series Positioning Control Systems</u>	4-6
4.3.1 Pneumatic Series Positioning System.....	4-7
4.3.2 Electric Series Positioning System.....	4-8

	<u>Page</u>
4.4	<u>Metering Control Systems</u> 4-8
4.5	<u>Oxygen Trim</u> 4-9
4.6	<u>Cross-Limiting Control</u> 4-11
5.0	FEEDWATER CONTROL SYSTEMS..... 5-1
5.1	<u>General</u> 5-1
5.2	<u>Single-Element Feedwater Control</u> 5-1
5.3	<u>Two-Element Feedwater Control</u> 5-3
5.4	<u>Three-Element Feedwater Control</u> 5-4
5.5	<u>Mechanical Feedwater Regulator</u> 5-6
6.0	FLAME SAFETY SYSTEMS..... 6-1
6.1	<u>General</u> 6-1
6.2	<u>Start-Up</u> 6-2
6.3	<u>Normal Operation</u> 6-4
6.4	<u>Shut Down</u> 6-5
7.0	CONTROL SYSTEM COMPONENTS - THEORY OF OPERATION..... 7-1
7.1	<u>Burner Controls</u> 7-1
7.1.1	Manual Auto Station..... 7-1
7.1.2	Air/Fuel Ratio Relay..... 7-3
7.1.3	Master Pressure Controller..... 7-5
7.2	<u>Feedwater Controls</u> 7-7
7.2.1	Feedwater Controller..... 7-7
7.2.2	Mechanical Feedwater Regulator..... 7-10
7.2.3	Drum Level Transmitter..... 7-12
7.2.4	Flow Transmitter..... 7-14
7.3	<u>Flame Safety Systems</u> 7-16
7.3.1	Flame Scanners..... 7-16
7.4	<u>Drive Mechanisms</u> 7-17

	<u>Page</u>
7.4.1 Pneumatic Control Drive.....	7-17
7.4.2 Electric Control Drive.....	7-18
7.4.3 Pneumatic Valve Actuator.....	7-19
7.4.4 Electric Valve Actuator.....	7-21
7.4.5 Hydraulic Valve Actuator.....	7-23
 7.5 <u>Recording Devices</u>	 7-24
7.5.1 Circular and Strip Chart Recorders.....	7-24

APPENDIX A

SIGNAL PROCESSING FUNCTIONS

Accession For		
NTIS GRA&I	<input checked="" type="checkbox"/>	
DTIC TAB	<input type="checkbox"/>	
Unannounced	<input type="checkbox"/>	
Justification		
By _____		
Distribution/ _____		
Availability Codes		
Avail and/or		
Dist	Special	
A		

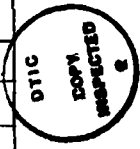

LIST OF FIGURES

<u>Figure Number</u>	<u>Figure Description</u>
3-1	Block Diagram - Open-Loop Control Mode
3-2	Block Diagram - Closed-Loop Control Mode
3-3	Fuel Valve Opening for Various Pressure Deviations in a Proportional Control System
3-4	Response of Steam Pressure to Step Increase of Load in a Proportional Control System
3-5	Response of Steam Pressure to Step Increase of Load in a Proportional-Plus-Integral-Control System
3-6	Proportional-Plus-Integral-Plus-Derivative Action
4-1	Block Diagram - Simple Parallel Positioning System
4-2	Jackshaft Burner Control System
4-3	Adjustable Jackshaft Cam Mechanism
4-4	Functional Schematic Diagram Jackshaft System
4-5	Parallel Positioning Control System (Pneumatic)
4-6	Functional Schematic Diagram Parallel Positioning System (Pneumatic)
4-7	Parallel Positioning Control System
4-8	Functional Schematic Diagram Parallel Positioning System (Electric)
4-9	Block Diagram-Simple Series Positioning Control System
4-10	Series Positioning Control System (Fuel Leading Air)
4-11	Series Positioning Control System (Air Leading Fuel)
4-12	Functional Schematic Diagram Series Positioning System (Pneumatic) Fuel Leading Air

<u>Figure Number</u>	<u>Figure Description</u>
4-13	Functional Schematic Diagram Series Positioning System (Pneumatic) Air Leading Fuel
4-14	Functional Schematic Diagram Series Positioning System (Electric) Fuel Leading Air
4-15	Functional Schematic Diagram Series Positioning System (Electric) Air Leading Fuel
4-16	Parallel Metering Control System
4-17	Parallel Positioning System with Oxygen Trim
4-18	Series Positioning System with Oxygen Trim
4-19	Oxygen Trim System with Damper Mounted Trim Device
4-20	Oxygen Trim System with Torsion Link Trim Positioner
4-12	Response of Air and Fuel Flow to a Step Change in Boiler Load with Time Delay Feature
5-1	Single-Element Feedwater Control
5-2	Offset Experienced with Proportional-Only Feedwater Control
5-3	Response of Single-Element Feedwater Control System to Rapid Load Change
5-4	Response of Three-Element Feedwater Control System to Rapid Load Change
5-5	Two-Element Feedwater Control
5-6	Three-Element Feedwater Control
5-7	Thermo-Hydraulic Feedwater Control System
5-8	Thermostatic Expansion Tube Feedwater Regulator

Figure Number

Figure Description

7-1	Bailey Electronic Manual/Auto Station
7-2	Bailey Pneumatic Manual/Auto Station
7-3	Bailey Electronic Manual/Auto Station with Bias Control
7-4	Hays-Republic Electronic Manual/Auto Station
7-5	Hays-Republic Pneumatic Manual/Auto Station
7-6	Hays-Republic Pneumatic Air/Fuel Ratio Relay
7-7	Hays-Republic Electronic Ratio Relay
7-8	Bailey Pneumatic Ratio Relay
7-9	Bailey Electronic Ratio Relay
7-10	Hays-Republic Pneumatic Master Pressure Controller
7-11	Hays-Republic Electronic Feedwater Controller
7-12	Bailey Thermo-Hydraulic Feedwater Regulator
7-13	Copes-Vulcan Thermostatic Expansion Tube Feedwater Regulator
7-14	Bailey Level Transmitters
7-15	Bailey Flow Transmitters
7-16	Bailey Flow Transmitters with Square Root Extraction
7-17	Bailey Pneumatic Square Root Extractor
7-18	Honeywell UV Flame Detector
7-19	Bailey Combination UV and Flicker Flame Detector
7-20	Bailey UV Flame Detector
7-21	Fireye Infrared Detector System
7-22	Fireye UV Detector System
7-23	Hays-Republic Pneumatic Control Drive

Figure Number

Figure Description

7-24	Bailey Pneumatic Control Drive
7-25	Hays-Republic Compact Pneumatic Control Drive
7-26	Hays-Republic Electric Control Drive
7-27	Bailey Electric Control Drive
7-28	Bailey Pneumatic Valve Actuator-Diaphragm Type
7-29	Bailey Pneumatic Valve Actuator-Piston Type
7-30	Bailey Pneumatic Valve Positioner
7-31	Honeywell Solenoid Valve
7-32	Honeywell Hydraulic Valve Actuator
7-33	Hays-Republic Hydraulic Valve Actuator
7-34	Hays-Republic Circular Chart Recorder
7-35	Hays-Republic Strip Chart Recorder
7-36	Bailey Strip Chart Recorder

1.0

INTRODUCTION

The purpose of this manual is to familiarize boiler operating personnel with the concepts which govern industrial boiler control systems. It is intended for use by those who do not necessarily have an extensive background in instrumentation and control technology, but who do have a basic knowledge of boilers and their ancilliary systems. The manual focuses on boilers in the 60 million BTU per hour (MM BTU/hr) range, but many of the concepts are applicable to boilers of any size.

The three major areas of industrial boiler control are covered. These are: burner (or combustion) control, feedwater control, and flame safety systems. Section 2.0 provides pertinent background information regarding the need for, and the objectives of, these three major subsystems. Section 3.0 is a discussion of control theory that acquaints the reader in general terms with various control techniques and concepts. Sections 4.0, 5.0, and 6.0 describe the control schemes that are normally employed to provide the desired control of each of the respective boiler subsystems. Section 7 provides detailed information regarding the function and operational theory behind the various control components. Also included in Section 7.0 is vendor's catalog data for selected control components.

2.0 BACKGROUND

2.1 General

The purpose of any boiler control system is to provide safe, efficient operation of the boiler at the desired output without the need for constant operator supervision. This means that the combustion process inside the furnace must be controlled as well as the steam conditions at the boiler outlet. The boiler must be able to respond to changes in load without jeopardizing safety or performance.

Although all boiler control systems perform essentially the same functions, the systems themselves may be either quite simple or quite intricate. Generally, the more complex the system the more precise the control capability. However, the more complex the system, the more difficult it is to maintain, and the more susceptible it is to malfunction. A variety of control techniques are available, and the choice of which technique is the "best" is often merely a matter of personal preference.

Boiler control systems are generally broken down into three main functions: burner controls, feedwater controls, and flame safety controls. The three are interrelated as far as actual operation of the boiler is concerned, but they are basically independent systems. They will, therefore, be discussed separately here.

2.2 Burner Control Systems

It is the responsibility of the burner control system to supply air and fuel to the furnace in the correct proportions to meet the steam demand. It is important that the correct air to fuel ratio be

maintained, regardless of steam flow. Too much air will result in inefficient operation, and too little air may be dangerous as well as being inefficient.

As the combustion process takes place in the furnace, oxygen in the combustion air combines chemically with the carbon, hydrogen, and sulfur (if present) in the fuel to produce heat. The amount of air that contains enough oxygen to combine exactly with all the combustible matter in the fuel is called the "theoretical" combustion air.

In actual practice, it is impossible for every molecule of oxygen that enters the furnace to combine with the fuel. For this reason, it is always necessary to provide more air than the theoretical requirement. For oil and gas fired boilers it is customary to provide 10 to 20 percent more air than the theoretical requirement to ensure complete combustion. This additional air is called "excess air," and a boiler firing at 1.2 times the theoretical air requirement would be said to be firing at 20 percent excess air. Since air is approximately 21 percent oxygen, a boiler firing at 20 percent excess air is also said to be firing at 4.2 percent "excess oxygen."

If insufficient oxygen is introduced into the furnace, incomplete combustion of the fuel will occur. This not only wastes fuel, but it can cause hazardous conditions in the boiler. The unburned fuel may later ignite in the boiler or breeching and result in a dangerous explosion.

Providing too much combustion air eliminates the explosion danger, but this, too, results in inefficiency. By far, the largest energy loss in any boiler is the heat which escapes as hot flue gas.

Increasing the excess air flow merely causes more hot flue gas to go up the stack as wasted energy.

It is, therefore, desirable to maintain the correct ratio of combustion air to fuel flow, or "air/fuel ratio," at all boiler outputs. Thus, the burner control system must simultaneously regulate the fuel and air supply to the furnace any time a change in load is required.

As mentioned earlier, burner control systems may become as simple or complex as desired. For boilers in the 60 MM BTU/hr range, the control systems are usually relatively simple, since the performance improvements possible generally cannot justify the cost of more complex systems. The firing rate of the boiler is normally determined by steam header pressure only.

This is called "single element" control since only one control element, pressure, is used. In larger boilers, two or three-element control may be used. That is, the firing rate of the boiler is not only controlled by header pressure, but may also be controlled by steam flow, steam temperature, or by a process signal such as the opening of a flow control valve.

Burner control systems are discussed in detail in Section 4.0.

2.3 Feedwater Control

The function of the feedwater control system is to provide make-up water to the boiler to replace the feedwater leaving as steam and/or blowdown. This is normally accomplished by maintaining a specified water level in the steam drum. It is essential that this water level

remain in the appropriate range. Too high a water level may cause water to be carried over into the superheater (if there is one) or even to the load devices, either of which can cause significant damage. Too low a water level may result in burn out of the boiler tubes. The range of safe water level in the drum is usually determined by the boiler manufacturer. It is dependent upon a number of factors, such as the size and shape of the boiler drum, the design of the boiler, and the characteristics of the steam load.

Maintaining a constant water level in the drum is not as straightforward as one might think. First of all, a clearly defined "level" usually does not exist. Instead there is a zone where steam and water are almost indistinguishable. The steam in the zone is entrained with many fine droplets of water. The water in the zone contains a multitude of steam bubbles in an almost continuous mass. What is more, the volume of these bubbles can increase or decrease rapidly, giving a false indication of changing water level in the drum. When the steam bubbles expand, this is known as drum "swell," and when they contract, it is called "shrink."

Drum swell is influenced by several factors. Among these are the drum pressure, boiler design, firing rate, steam load, feedwater temperature, and feedwater flow.

The boiler design influences drum swell in a number of ways. The ratio of heating surface to the volume of water in the boiler, the speed of circulation of the water, and the surface area of the drum water in relationship to the volume all have an effect on drum swell.

At low drum pressures, the volume of pound of steam is much greater than the volume of a pound of water at the same temperature. Because of this, greater swelling occurs in boilers with lower operating pressures.

Rapid fluctuations in steam load or in boiler firing rate have a marked effect on drum swell or shrink. For example, if the steam load is suddenly increased, the drum pressure will decrease, and the volume of the steam bubbles will increase. More bubbles will also be created since the lower pressure will allow an additional portion of the drum water to vaporize. The result is an apparent increase in drum level when the actual quantity of water in the drum is less.

An increase in firing rate will raise the drum pressure, which in turn tends to decrease the volume of the steam bubbles and lower the drum level. However, increased firing also creates more steam bubbles, and the net effect is usually an apparent increase in drum level.

Increasing the feedwater flow will at first tend to decrease the boiler drum level. The feedwater has a cooling effect which collapses the steam bubbles in the drum. The colder the feedwater, the more pronounced the effect.

The problems associated with feedwater control become obvious when one considers the effects of drum swell and the difficulties that can be encountered in determining the actual quantity of water in the drum at any given time. Feedwater control systems, like burner controls, may be quite simple or may become rather sophisticated. Again, the more complex the system, the more precise the control.

Smaller boilers in the 60 MM BTU/hr range normally use simple systems where only the drum level is monitored. (This is single-element control since only one parameter is monitored.) Larger boilers use two or three-element control, where steam flow or pressure and feedwater flow are monitored in addition to drum level. The various types of feedwater control systems are discussed in detail in Section 5.0.

2.4 Flame Safety System

The purpose of the flame safety system is to prevent those conditions which can lead to a boiler explosion. Such conditions can occur any time unburned fuel vapors are present in the furnace or ductwork, ~~and~~ ignition, either intentional or accidental, takes place.

Start-up is an especially critical period, since explosions can result from a variety of causes at that time. If the furnace is not properly purged, fuel that has seeped past faulty shut-off valves during the boiler outage may explode when the ignitors are lit. If the fuel that is intentionally introduced into the furnace during start-up does not ignite quickly, it too can accumulate with hazardous results.

During normal operation, an explosion can occur anytime the burner flame is extinguished and the fuel supply is not shut off immediately. The flame can be lost for a number of reasons, including improper fuel pressure, interruption in fuel supply, contaminated fuel, and burner malfunctions.

As mentioned earlier, hazardous conditions can also result during normal boiler operation if insufficient air is introduced into the furnace to complete the combustion process. The unburned fuel may later ignite in the ductwork with disastrous results. In this instance, the flame safety system does not provide any protective function. It is the responsibility of the burner control system to ensure that the proper air/fuel ratio exists. (This is perhaps just a matter of definition, since one could include those burner controls which prevent insufficient combustion air in the flame safety system.)

Thus the flame safety system must ensure that the boiler is purged prior to ignition, and that the fuel supply to the boiler is ignited quickly and burns continuously. Flame safety systems are generally required on all industrial boilers, both by law and by the regulations of insurance underwriters. There are some exceptions for boilers smaller than 10,000 lb/hr steam output, but for the purposes of this text it will be assumed that all boilers are equipped with at least some form of flame safety system.

Flame safety systems are discussed in detail in Section 6.0.

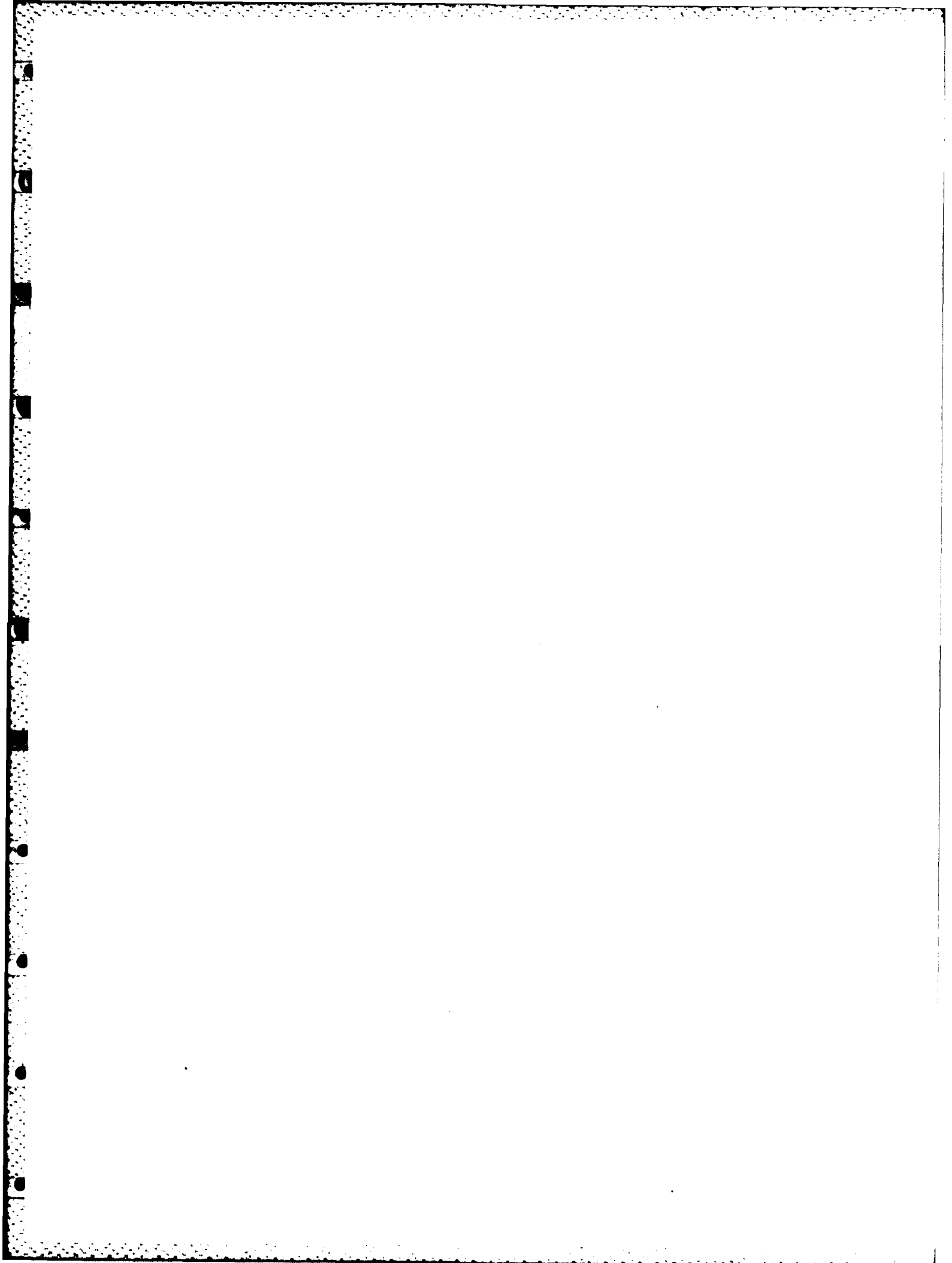

3.0 BASIC CONTROL THEORY

3.1 General

In order to fully understand the functioning of the various boiler control systems, it is necessary to first understand some of the basic principles of control. A brief overview of control theory, which highlights the principles applicable to small boiler control systems, is presented in this section.

Generally speaking, there are two basic modes of control: "open-loop" (or "non-feedback") and closed-loop (or "feedback"). These are broad classifications which may apply to the functioning of an individual control component or to an entire system. Open-loop means that there is no return signal, or feedback, to the controlling device to indicate whether or not the desired output conditions are being obtained. Closed-loop means there is a feedback signal. Often a control system will contain more than one control loop, and both closed and open loops may be utilized in the same system. Most small boiler control systems consist of a single basic closed-loop with several open-loops included.

One should also have a general understanding of the types of control signals that are utilized within a control system. The signals that are received from various sensing devices as input or feedback are often adjusted so that the desired output signal is achieved. A discussion of the various signal functions is given below, along with with a description of open- and closed-loop control techniques.

3.2 Open-Loop Control

The simplest control method is the open-loop system where the manipulated variables (such as fuel, air or water flow) are adjusted from the input demand signals without monitoring the outlet conditions or output variables (see Figure 3-1). In other words, there is no return signal, or "feedback" from the output variables by which the control system can determine if the desired outlet conditions are actually being met. The control system is initially calibrated, and it is assumed that the same outlet conditions will be produced for each controller output signal. This will only be the case as long as the boiler conditions remain the same as they were when the calibration was established. In actuality, the boiler conditions often do change, and the inaccuracy that can result with open-loop control often outweighs the advantages of simplicity and rapid response time. For this reason, pure open-loop systems are seldom used for boiler control, and at least one feedback loop is provided.

3.3 Closed-Loop Control

A closed-loop control system is used to overcome the inconsistency that can result from open-loop control. With closed loop control, the actual output is measured and compared to the desired output value (see Figure 3-2). If there is any deviation between the two, the closed-loop system acts to correct it. As stated earlier, the term "closed-loop" may apply to the functioning of an individual control component or of the entire system. In either case,



FIGURE 3-1 BLOCK DIAGRAM - OPEN-LOOP CONTROL MODE

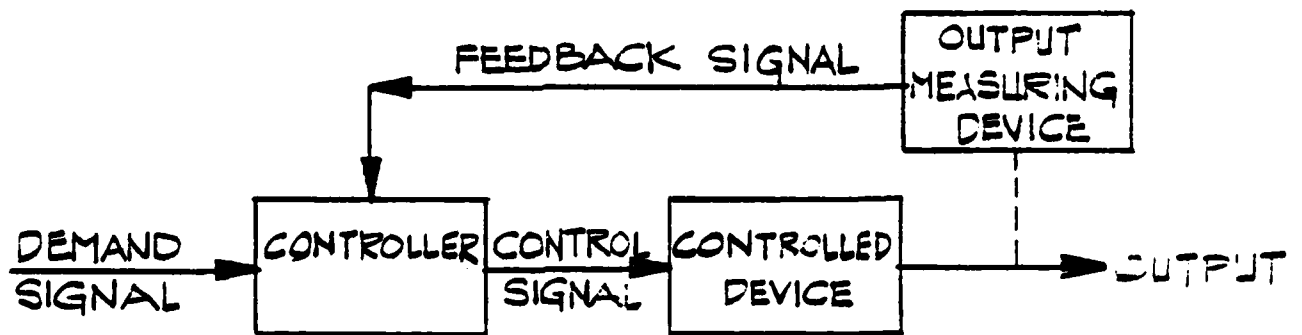

FIGURE 3-2 BLOCK DIAGRAM - CLOSED-LOOP CONTROL MOD

a return signal is provided from a measured output variable to the controlling device. This feedback signal is sometimes called the "error signal," since it is based on the deviation of the actual output from the desired output, or "set point."

A simple burner control system is a good example of closed-loop control. In this case the steam header pressure is the measured output variable. When the header pressure deviates from the set-point, the master pressure controller generates an error signal which is a function of the difference. This error signal is transmitted to the fuel and air regulating devices to adjust the fuel and air flows. As the header pressure returns to the set point value, the magnitude of the error signal is reduced to zero. (A more detailed discussion of burner control systems is provided in Section 4.0.)

3.4 Control Signal Functions

In order to fully understand the theory behind closed-loop control systems, it is necessary to examine just how feedback control signals are utilized by the system. Whenever a deviation between the actual output and the desired set point occurs, it is obviously desirable to return the system to normal as quickly as possible, without causing any wide fluctuations in performance. To accomplish this, it is often necessary to produce an error signal that varies in accordance with some mathematical equation.

It should be recognized that it is possible, by proper selection of hardware, to produce an output signal that will vary in magnitude

in accordance with virtually any mathematical function. Input signals can be added, subtracted, multiplied, divided, averaged, and increased or decreased exponentially to produce the desired output signal. A time parameter can also be included so that output signals vary with the integral or derivative of the input. (A table showing the various signal functions in both equational and graphical form is given in Appendix A.)

The closed loop-control systems which are used for boiler controls utilize many of the mathematical functions referenced above. For small boiler control systems, the basic control loop generally uses proportional control. However, integral and derivative functions are often included to improve performance.

3.5 Proportional Control

Proportional control is one of the simplest and most common types of control techniques. With proportional control, the manipulated variable (or the controller output) is proportional to the deviation between the controlled variable and the desired set point. For example, if the desired steam pressure is 100 psig, and the actual pressure is 90 psig, a master pressure controller with proportional control will transmit a signal proportional to that 10 psig difference. The ratio between the feedback (or error) signal and the variation in controller output which results from the feedback signal is known as "proportional gain" or "gain." Figure 3-3 is a diagram showing the relationship between the controlled variable, the set point, the output signal, and the proportional gain.

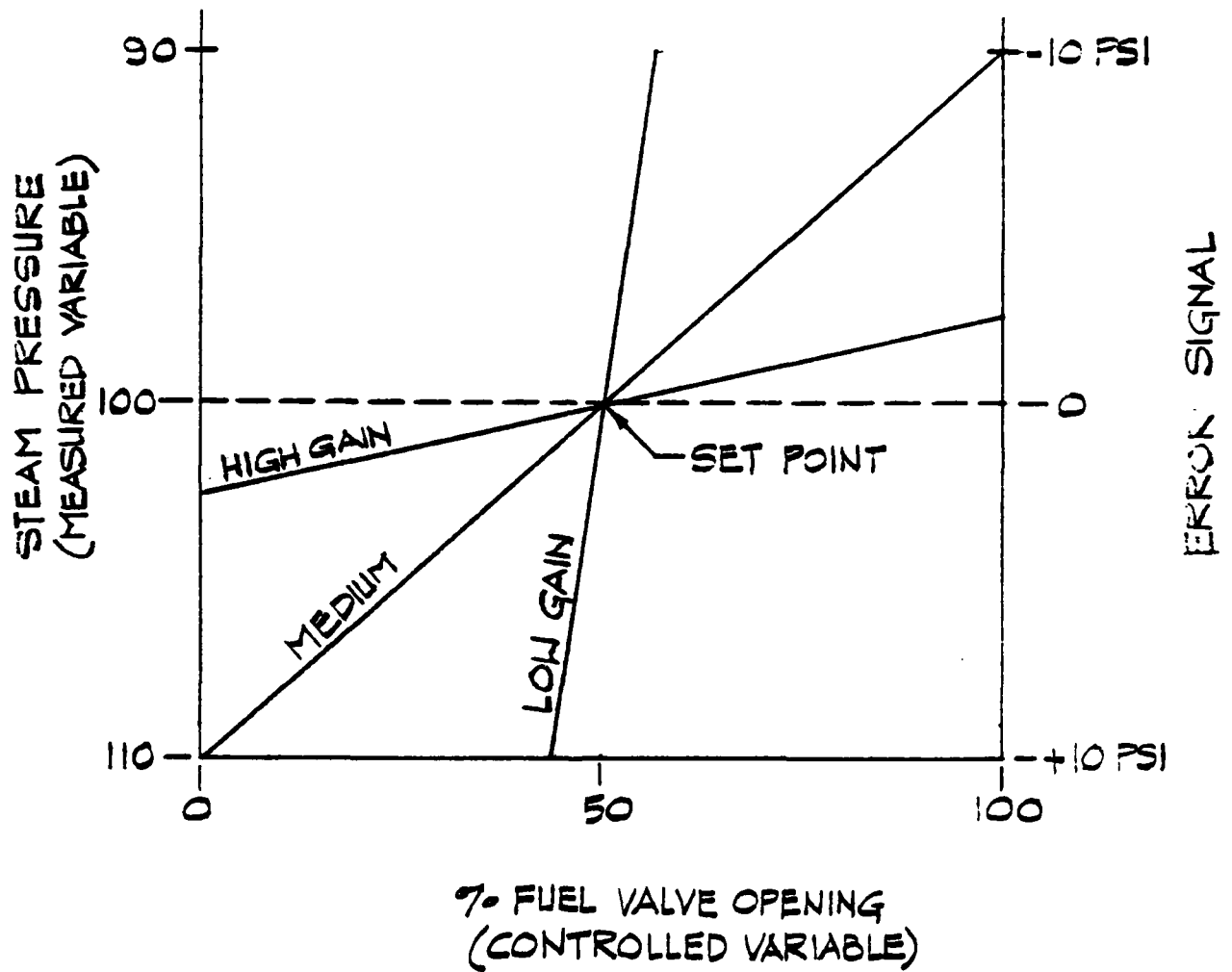

FIGURE 3-3 FUEL VALVE OPENING FOR VARIOUS PRESSURE DEVIATIONS IN A PROPORTIONAL CONTROL SYSTEM.

As can be seen from this diagram, increasing the gain causes a larger change in the output signal to the controlled variable for a given deviation of the measured variable from the set point. In other words the output signal is more sensitive to deviations from the set point. Likewise, when the gain is reduced, the output signal is less sensitive.

A disadvantage of proportional control is that when an upset does occur, the controlled variable does not return exactly to the set point, but instead is offset by a slight amount. This is a necessary feature of proportional control, and can be explained by another examination of Figure 3-3. At any proportional gain, there can be only one fuel valve opening that will produce the desired steam pressure. By increasing the gain, the offset can be reduced, but there is a limit to the amount of gain that can be increased. If the gain is too high, minor deviations from the pressure set point will cause drastic variations in the fuel valve opening, and a highly unstable control system will result.

A typical response curve to a step change in load for a proportional control system is shown in Figure 3-4. At a low gain there is little "cycling" or "hunting," and the system stabilizes rather quickly. However, a large offset results. At high gain some cycling occurs and the system takes longer to stabilize, but the final offset is reduced.

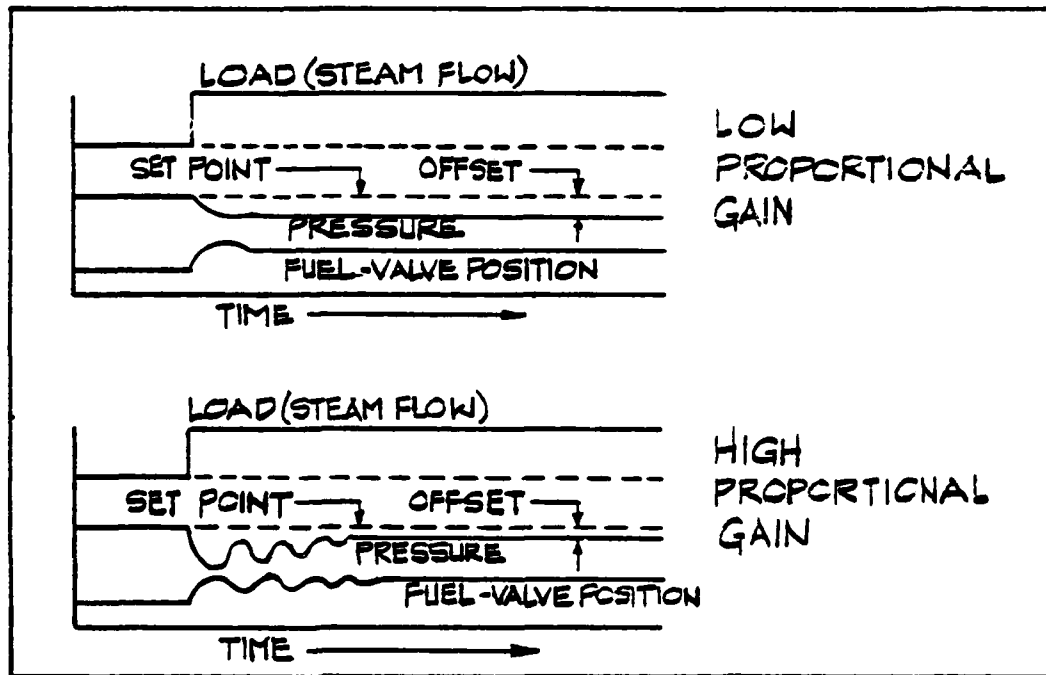

FIGURE 3-4 RESPONSE OF STEAM PRESSURE TO STEP INCREASE OF LOAD IN A PROPORTIONAL CONTROL SYSTEM.

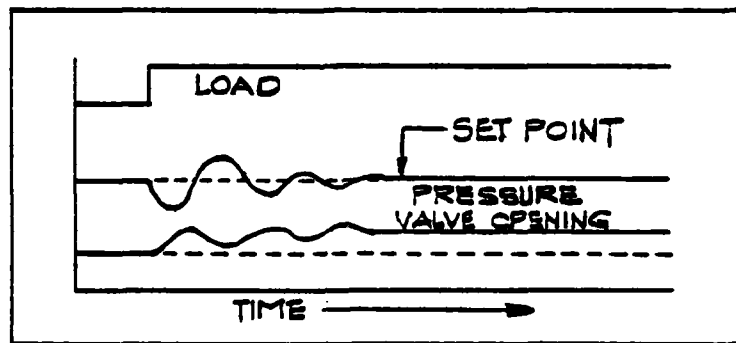

FIGURE 3-5 RESPONSE OF STEAM PRESSURE TO STEP INCREASE OF LOAD IN A PROPORTIONAL-PLUS-INTEGRAL-CONTROL SYSTEM.

3.6 Integral Control

The offset which results from proportional control can be eliminated by adding an integral or "reset" control mode to the system. With integral control, as the name implies, the error signal is a function of both the deviation of the controlled variable from the set point and time period over which it occurs. The term "reset" comes from the fact that with integral control, the band of proportional variation is shifted, or reset, so that the controlled variable operates around a new base point.

When integral control is added to proportional control, as shown in Figure 3-5, the result is a system which takes slightly longer to stabilize (than proportional-only control), but which returns the controlled variable to the original set point.

3.7 Derivative Control

Derivative control is a function of the rate of change of the controlled variable from its set point. Adding this control function to a proportional plus integral control system can improve both the stability and the response of the system. The response curve for proportional-plus-integral-plus-derivative control is shown in Figure 3-6.

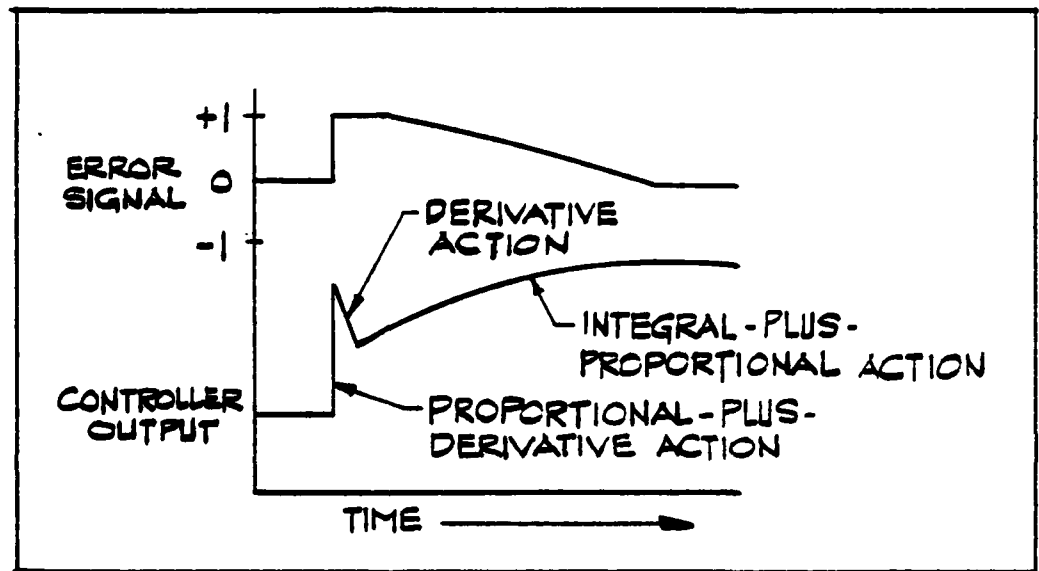

FIGURE 3-6 PROPORTIONAL-PLUS-INTEGRAL-PLUS-DERIVATIVE ACTION

4.0 BURNER CONTROL SYSTEMS

4.1 General

It is the function of the burner control system to regulate the flow of air and fuel to the boiler furnace in order to achieve the desired steam outlet conditions. For the purposes of this manual, it will be assumed that each boiler is equipped with a single combustion air fan and a single burner. This is not necessarily the case in actual practice. Boilers with both induced draft and forced draft fans, or with multiple burners, are not uncommon. However, essentially the same control concepts are employed in such cases, so the single burner/single fan design will be discussed for simplicity.

4.2 Parallel Positioning System

The parallel positioning system is perhaps the most common control scheme for small industrial boilers. With this type of system, control signals from the master pressure controller are sent simultaneously to the fuel flow and air flow regulating devices (see Figure 4-1). The positioning of these regulating devices is thus determined by the magnitude of the signal from the master pressure controller. Parallel positioning control systems may be either pneumatic, electrical, mechanical jackshaft, or a combination of the above.

The parallel positioning system has the advantages of quick response time and operating simplicity, but it does have some shortcomings. Although the system as a whole operates in a closed-loop mode, the control of the individual air and fuel positioners is essentially open-loop. As mentioned earlier, open-loop

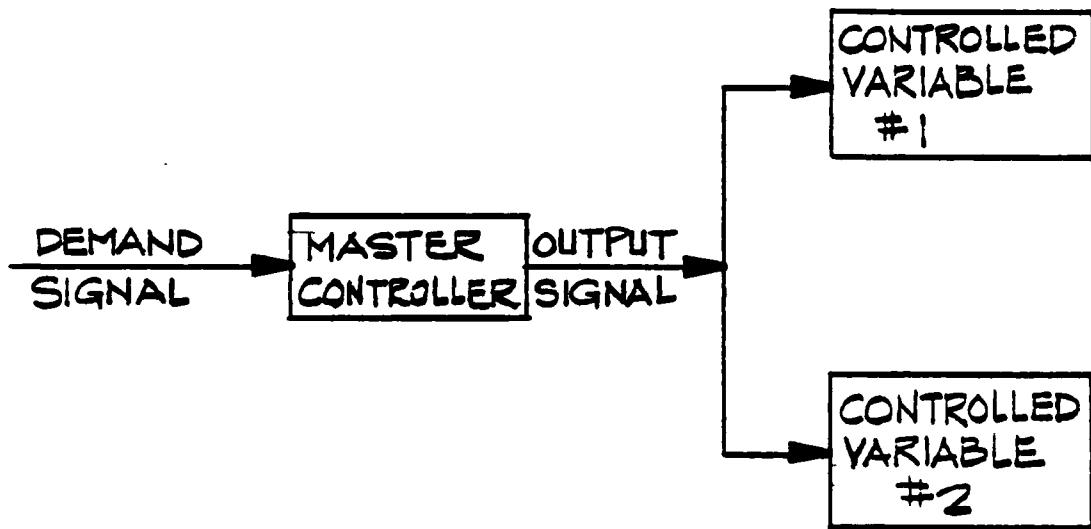

FIGURE 4-1 BLOCK DIAGRAM - SIMPLE
PARALLEL POSITIONING SYSTEM

control can lead to inconsistent performance. An example will illustrate this: In a burner control system, if the steam header pressure drops, the master pressure controller will send a signal simultaneously to the combustion air damper and fuel valve positioners. Fuel and air flow will be increased, and the header pressure will be returned to normal. The feedback to the control system is provided by the header pressure signal. No feedback is provided by the air and fuel regulating devices. Thus, there is no assurance that the fuel/air ratio is within the desired range, other than the initial calibration of the system.

In spite of this drawback, parallel positioning systems have a good operating history and are generally quite reliable. Individual control components are fully adjustable, and minor corrections can be made whenever necessary. If more precise control of fuel/air ratio is desirable, this can be readily accomplished by adding oxygen trim (see Section 4.5).

The operation of a parallel positioning system is virtually the same, regardless of whether pneumatic, electric, or jackshaft components are utilized. However, each will be discussed separately for the sake of clarity.

4.2.1 Jackshaft System

A jackshaft control system is shown in Figure 4-2. With this type of system, the individual control components are connected to a long shaft which rotates through an angle of approximately 90° or so. This shaft can be rotated either manually or automatically. In the automatic mode, the shaft is rotated by means of a drive mechanism

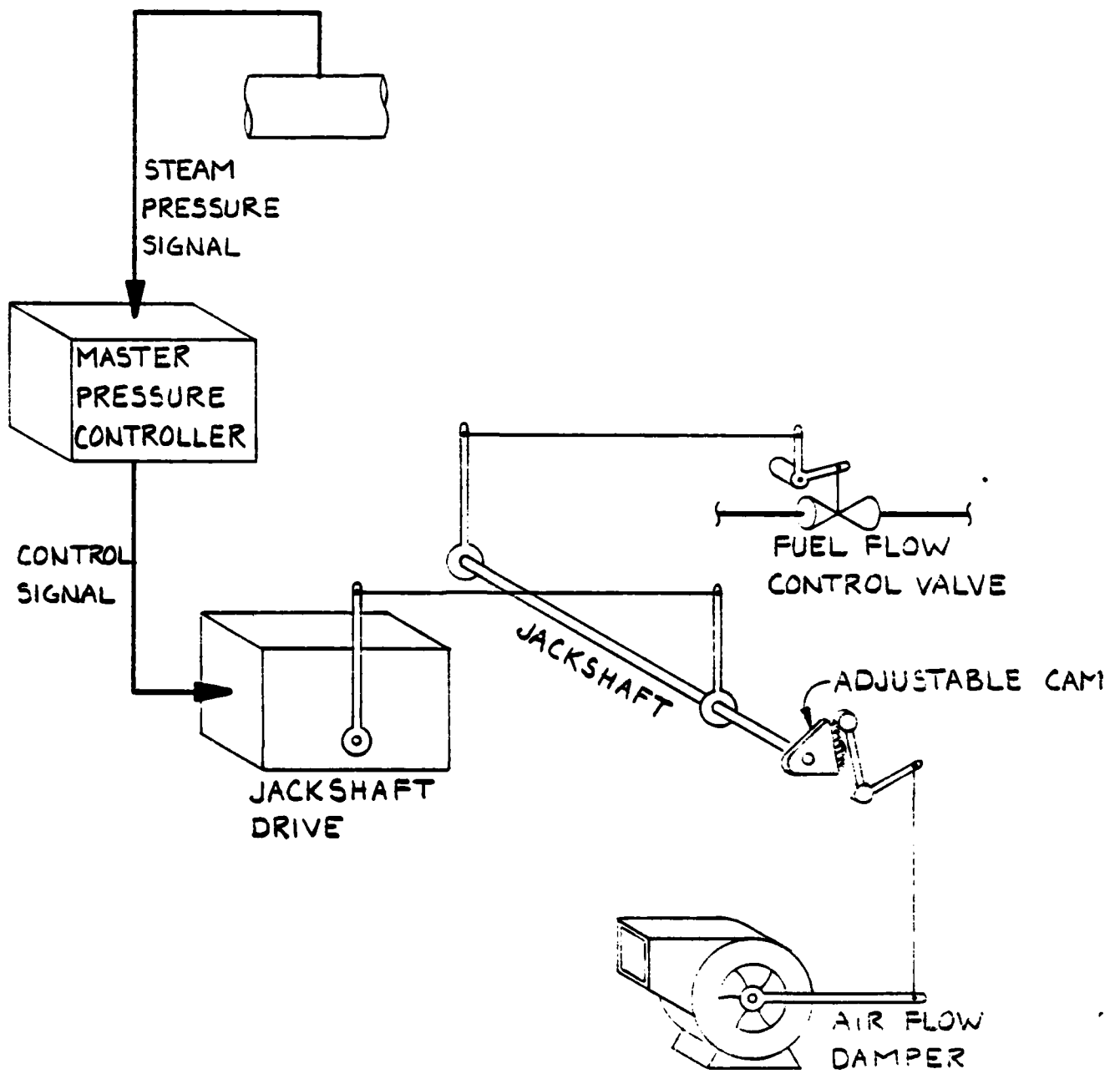

FIGURE 4-2 JACKSHAFT BURNER CONTROL SYSTEM

which is controlled by a master pressure controller. The jackshaft is linked either directly or through a cam mechanism to the combustion air damper and fuel valve positioner. As the shaft rotates, the fuel and air flows are either increased or decreased in unison. The purpose of the cam mechanism (see Figure 4-3) is to provide a means of varying the air/fuel ratio at different boiler outputs.

The functioning of the adjustable cam shown in Figure 4-3 is as follows: When the jackshaft is rotated, the roller follower on the cam causes the damper drive shaft to also rotate. The amount of damper drive shaft rotation that occurs is thus determined both by the jackshaft rotation and by the cam profile. The fuel valve positioner is linked directly to the jackshaft, so the air/fuel ratio is directly affected by the profile. Since the cam profile can be changed by means of a series of adjustable set screws, the air/fuel ratio can be calibrated for each boiler output.

The master pressure controller utilized with a jackshaft system may be either electrically or pneumatically operated. It receives an input signal from the steam pressure transmitter and produces an output signal which is in turn transmitted to the jackshaft control drive.

The output signal from the master pressure controller is usually proportional to the input from the steam pressure transmitter, and, depending upon the type of controller, integral and derivative control functions may be included.

The jackshaft control drive may be either pneumatic, hydraulic, or electric. Pneumatic drives are generally used on larger boilers where greater driving force is required.

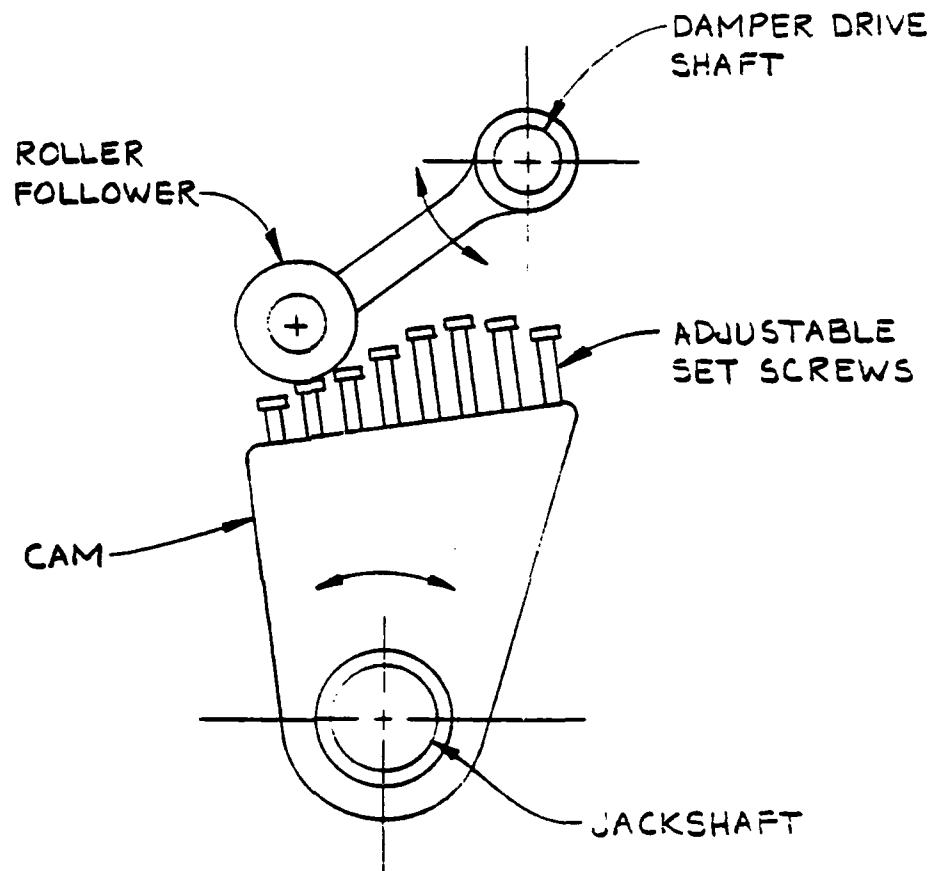

FIGURE 4-3 ADJUSTABLE JACKSHAFT
CAM MECHANISM

A functional schematic diagram for a jackshaft parallel positioning control system is shown in Figure 4-4.

4.2.2 Pneumatic Parallel Positioning System

The pneumatic parallel positioning system operates in a similar fashion to the jackshaft system except that pneumatic control signals are utilized in lieu of mechanical linkages. The steam pressure controller transmits a pneumatic signal to the combustion air damper and the fuel valve positioner instead of to a jackshaft control drive (see Figure 4-5). Manual operation of the system is accomplished by with a manual/auto control station, and the fuel to air ratio is adjusted by means of air/fuel ratio controller.

The manual/auto station is located in the control loop "down stream" of the master pressure controller. Thus, the output signal from the master controller must pass through the manual/auto station before it reaches the rest of the control system. The output signal from the master controller can, therefore, be blocked and another signal substituted in its place by putting the manual/auto station on manual. This provides manual control of the boiler.

The air/fuel ratio controller is located downstream of the manual/auto station, either just before the air damper positioner or the fuel valve positioner. Since the output signal from the air/fuel ratio controller is proportional to the input, a different control signal reaches the fuel valve positioner than reaches the damper drive. Furthermore, the output to input signal ratio for the air/fuel ratio controller is fully adjustable, so the boiler air/fuel ratio can be varied as necessary to ensure proper combustion.

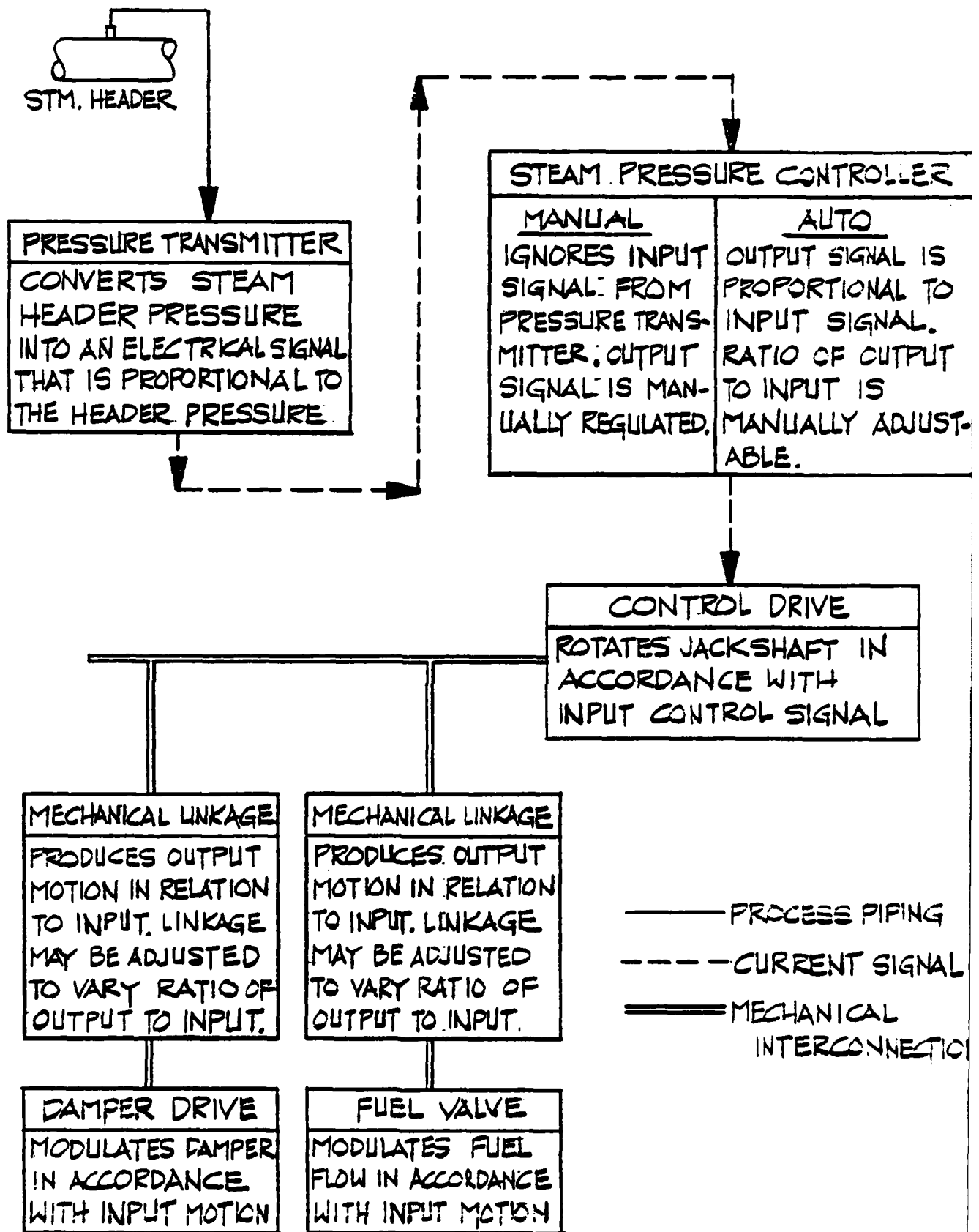

FIGURE 4.4 FUNCTIONAL SCHEMATIC DIAGRAM
JACKSHAFT SYSTEM

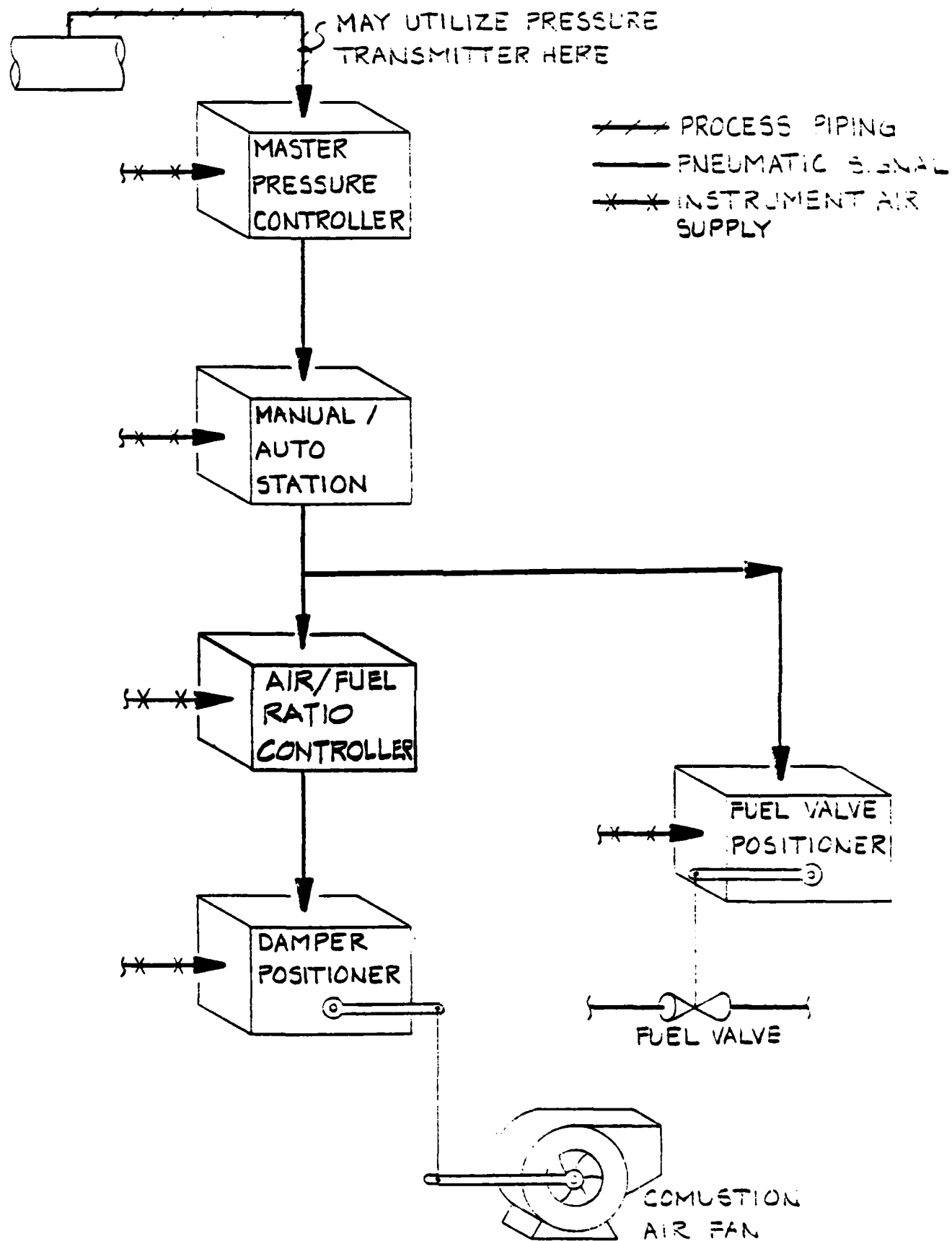

FIGURE 4-5 PARALLEL POSITIONING CONTROL SYSTEM (PNEUMATIC)

A functional schematic of a pneumatic parallel positioning control system is shown in Figure 4-6.

4.2.3 Electric Parallel Positioning System

The operation of an electric parallel positioning system is essentially the same as that of a pneumatic system (see Figure 4-7). The main difference lies in the fact that electric current is used to transmit control signals instead of compressed air. Most systems use direct current (dc), but the operating voltage may vary depending upon the manufacturer. Voltages in the 24 vdc or 115 vdc range are the most common. The magnitude of the control signal is determined by the current level. Control signal currents are generally in the 1 to 5 or 4 to 20 milliamp (ma) range.

A functional schematic diagram of an electric parallel positioning system is shown in Figure 4-8. As can be seen from this diagram, the electric system is virtually identical to the pneumatic system. There may be some slight differences in the performance of the individual components, but the overall functioning is the same. The steam header pressure is converted to a control signal which is transmitted in parallel to both the fuel and the air control devices. Manual/auto stations are used to provide local manual control for a particular device or subsystem, and a fuel/air ratio controller is used to provide a different control signal to the damper drive than the one transmitted to the fuel valve positioner.

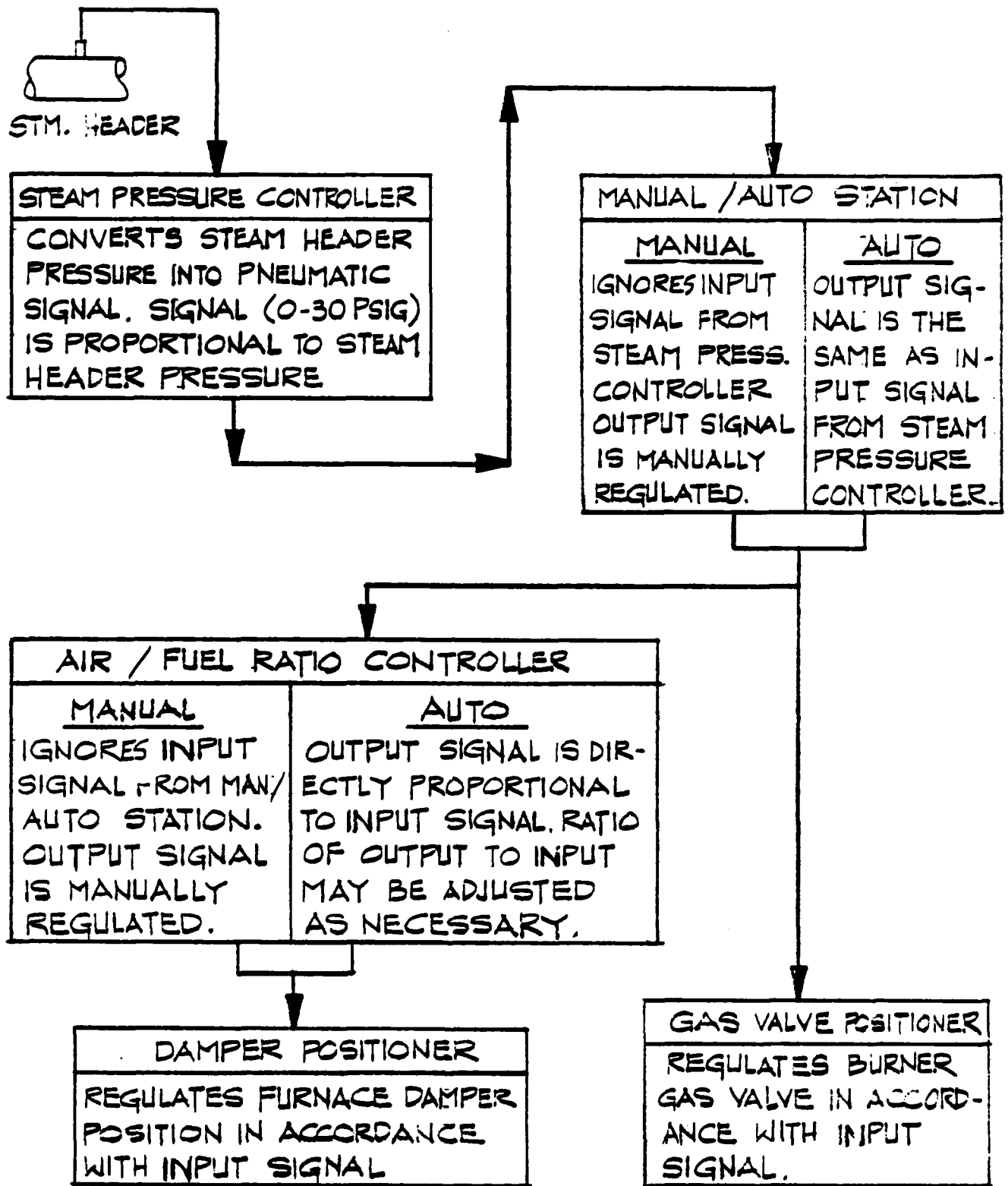

FIGURE 4-6 FUNCTIONAL SCHEMATIC DIAGRAM
 PARALLEL POSITIONING SYSTEM
 (PNEUMATIC)

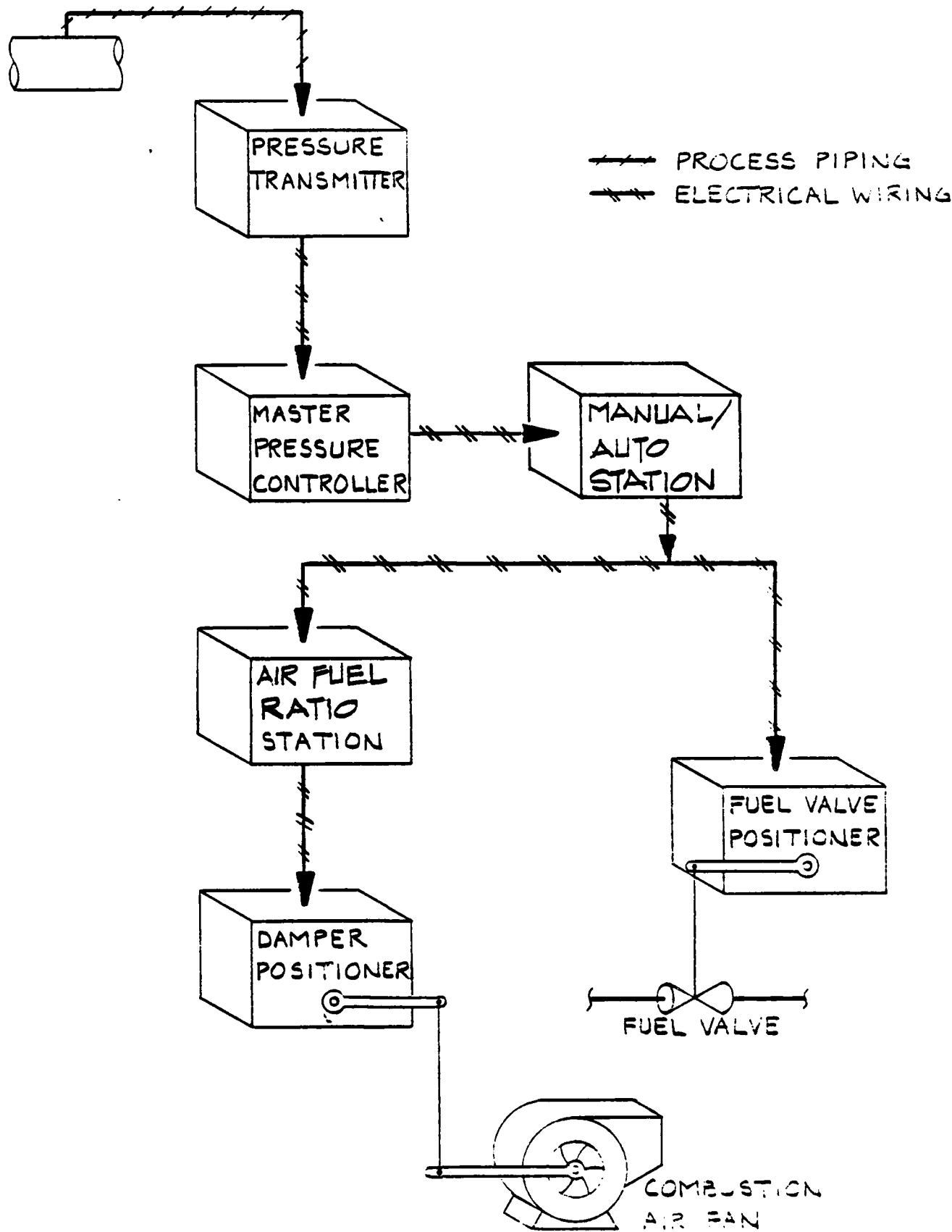
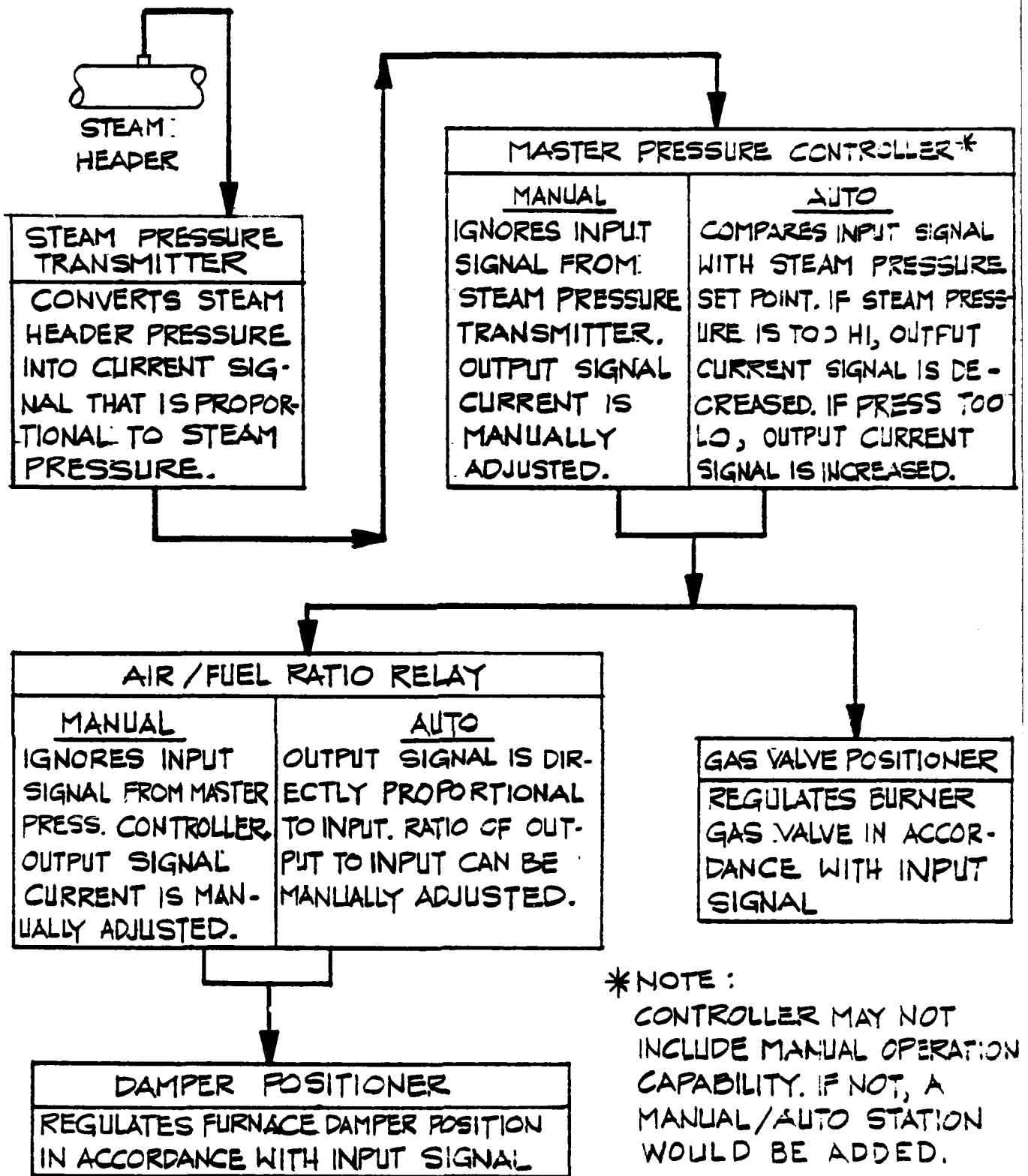

FIGURE 4-7 PARALLEL POSITIONING CONTROL SYSTEM (ELECTRIC)



**FIGURE 4.8 FUNCTIONAL SCHEMATIC DIAGRAM
 PARALLEL POSITIONING SYSTEM
 (ELECTRIC)**

Series Positioning Control Systems

In a series positioning system, the control signal from the master pressure controller is not sent to the fuel and air regulating devices simultaneously as it is in a parallel system. Instead, the signal is sent only to the fuel valve positioner or only to the damper positioner. The displacement of this first regulating device is then measured and used to transmit a control signal to the other positioner. A typical series positioning system is shown in Figure 4-9.

By using the actual displacement of one regulating device to control the other, the series positioning system provides an additional margin of safety that is not available in a parallel system. For example, if the damper positioner is the first control device in the series, then the fuel flow cannot increase unless the air damper actually opens. This prevents a hazardous condition from occurring should the damper drive fail to operate properly.

Despite this advantage, series positioning systems are not entirely foolproof. Just as is true of a parallel system, the control of air and fuel flows is open-loop in a series system. There is no feedback into the control loop which tells the system what the actual flows of air and fuel are. Feedback is provided by the steam header pressure only. If the header pressure is at the set point and the air/fuel ratio is nowhere near the desired value, the control system takes no action to correct it. For this reason, it is often desirable to have oxygen trim added to a series positioning system (see Section 4.5).

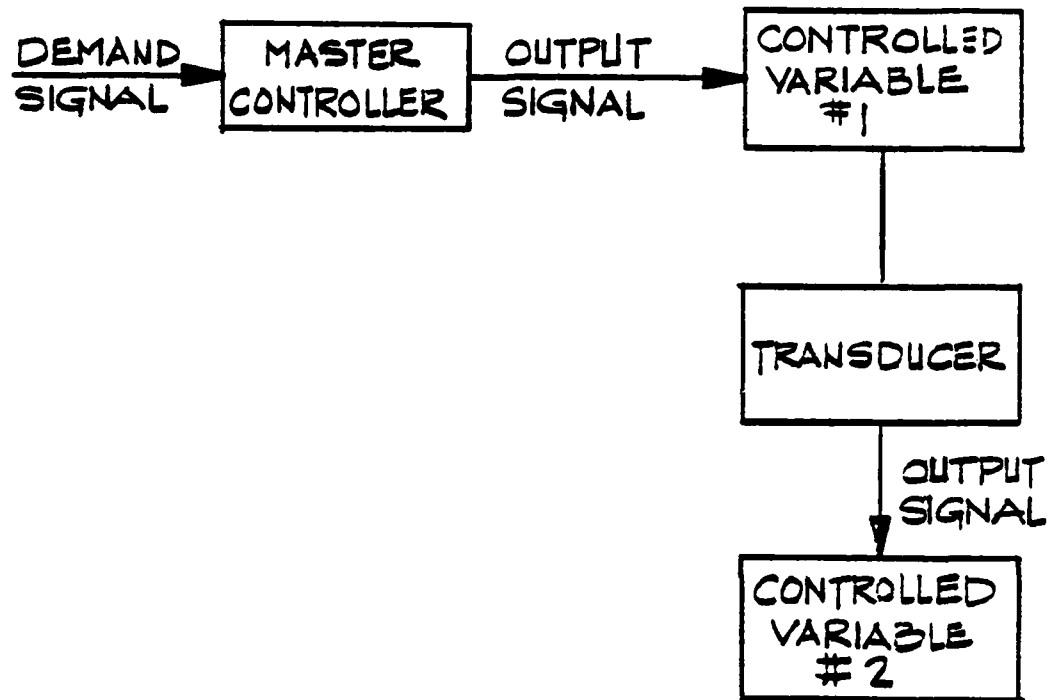

FIGURE 4-9 BLOCK DIAGRAM - SIMPLE
SERIES POSITIONING CONTROL
SYSTEM

Furthermore, with a series positioning system, there can be a temporary upset in the air/fuel ratio during changing load. This can be corrected by adding a cross-limiting function to the control loop. This approach is discussed in detail in Section 4.6.

4.3.1 Pneumatic Series Positioning System

Functional schematic diagrams for two pneumatic series positioning systems are shown in Figures 4-10 and 4-11. Figure 4-10 is a "fuel-leading-air" system and Figure 4-11 is an "air-leading-fuel" system. With the fuel-leading-air system, the output signal from the master pressure controller goes only to the fuel valve positioner. A transducer located at the valve positioner then transmits a signal to the air damper positioner. The magnitude of this signal is proportional to the amount that the fuel valve is opened.

With the air-leading-fuel system, the operational sequence is reversed from that stated above. The signal from the master pressure controller goes only to the damper positioner, and a transducer at the damper transmits a pressure signal to the valve positioner which is proportional to damper displacement.

Manual/auto stations and fuel/air ratio controllers are used in series positioning systems in the same manner as described earlier for parallel systems. A manual/auto station is located in the control loop just downstream from the master pressure controller so that the entire system may be placed on manual operation. A fuel/air ratio controller is located in the control loop at the outlet of the damper position transducer (air-leading-fuel system) or the outlet of the

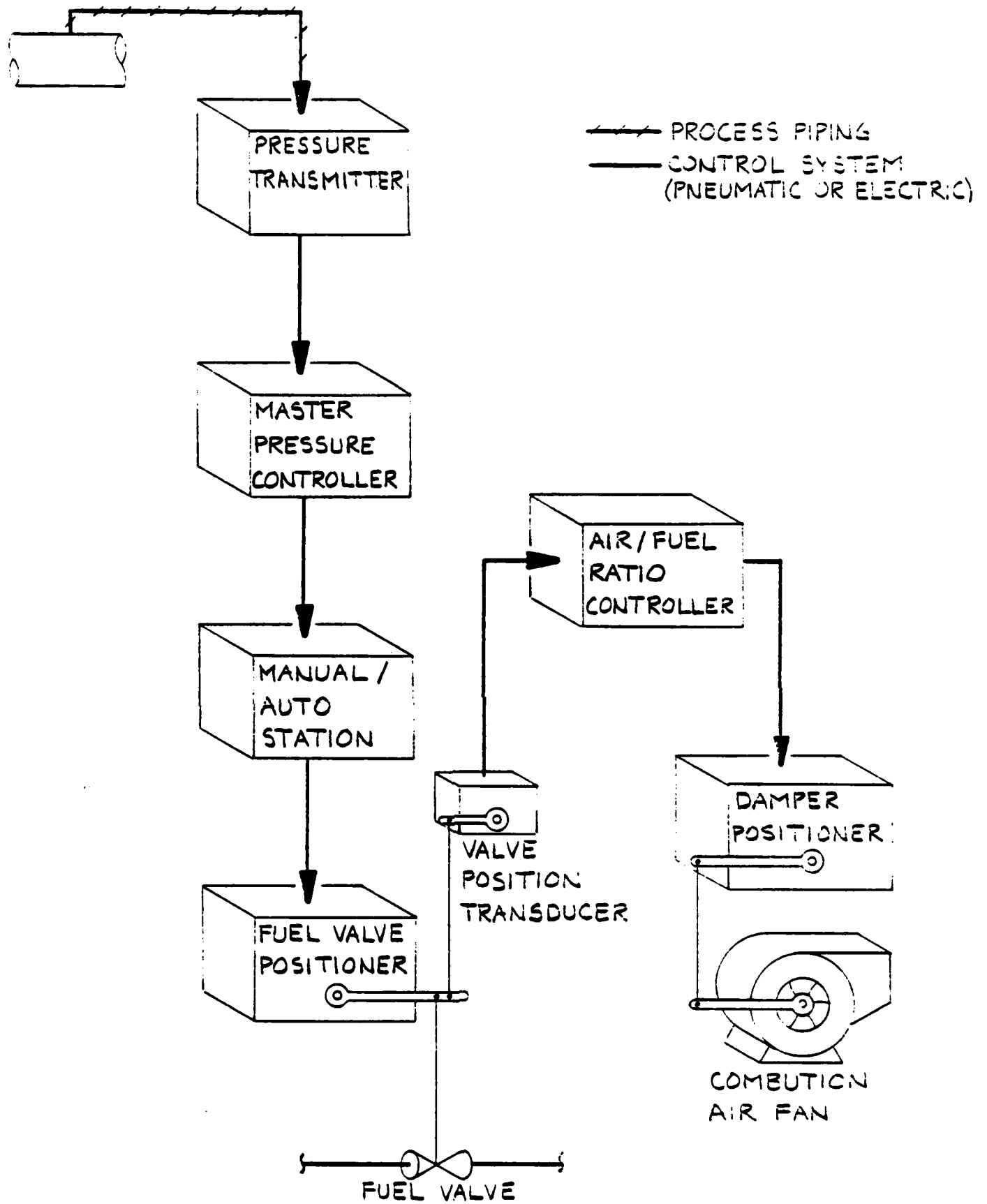

FIGURE 4-10 SERIES POSITIONING CONTROL SYSTEM (FUEL LEADING AIR)

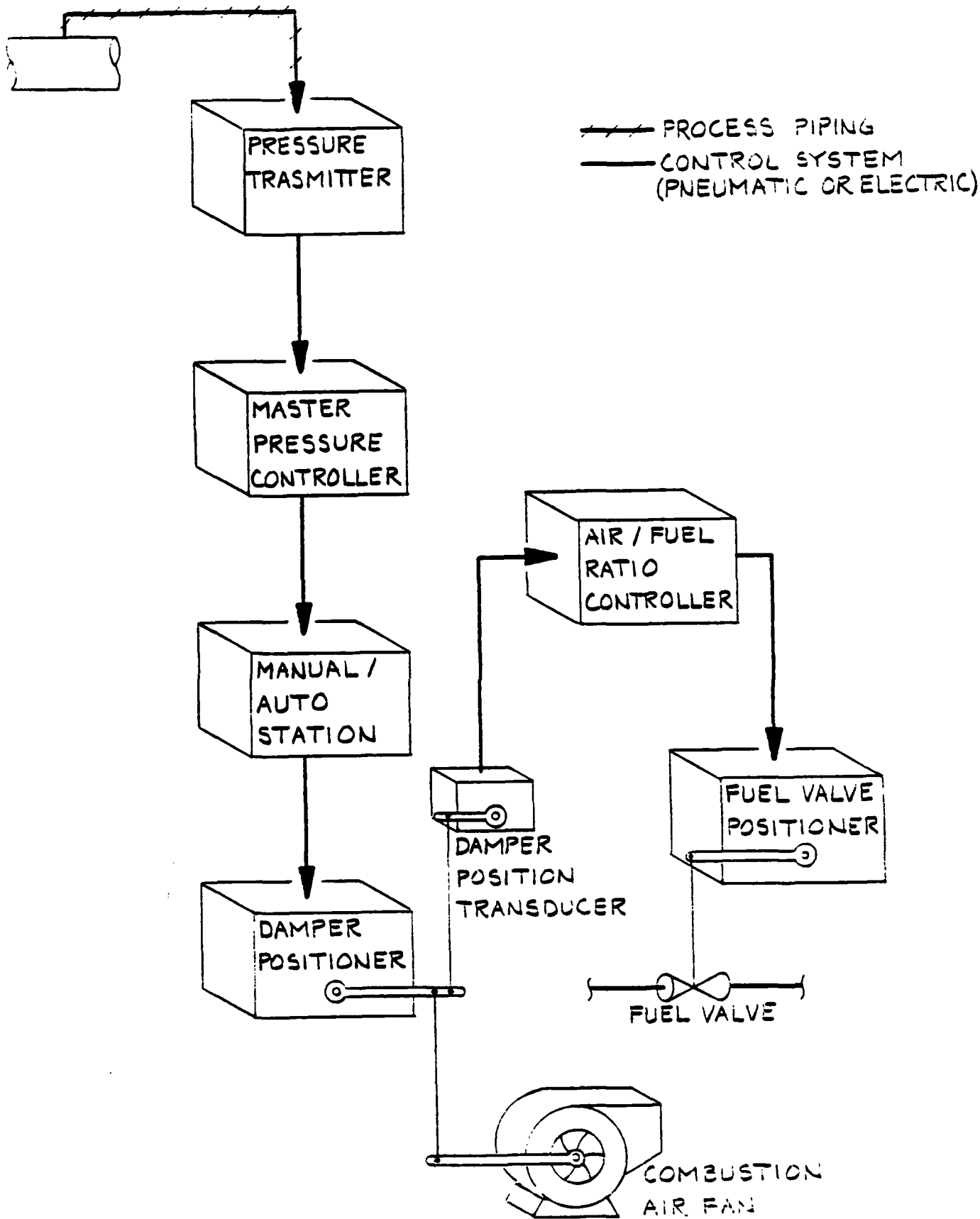

FIGURE 4-11 SERIES POSITIONING CONTROL SYSTEM (AIR LEADING FUEL)

fuel valve position transducer (fuel-leading-air system). The fuel/air ratio controller, by producing an output signal that is proportional to the input, provides a means of varying the ratio of damper opening to fuel valve opening.

Functional schematic diagrams for pneumatic series positioning control systems are shown in Figures 4-12 and 4-13. Figure 4-12 is a fuel-leading-air fuel system and 4-13 is air-leading-fuel.

4.3.2 Electric Series Positioning System

The electric series positioning system is functionally identical to the pneumatic system. As with the pneumatic system, the electric series positioning system may be either fuel-leading-air or air-leading-fuel. Functional schematic diagrams of these two types of series system are shown in Figures 4-14 and 4-15. For a description of the operation of electric series positioning systems, one may refer to the proceeding section on pneumatic systems.

4.4 Metering Control Systems

Metering control systems provide a level of precision that is not available with positioning systems. However, this level of precision does not come without additional cost and complexity, and metering systems are generally not justified on small industrial boilers. A brief overview of metering systems is given below for informational purposes.

With a metering control system, the open-loop control of fuel and air flows found with positioning systems is eliminated. Fuel and air flows are measured, and feedback is provided to their respective

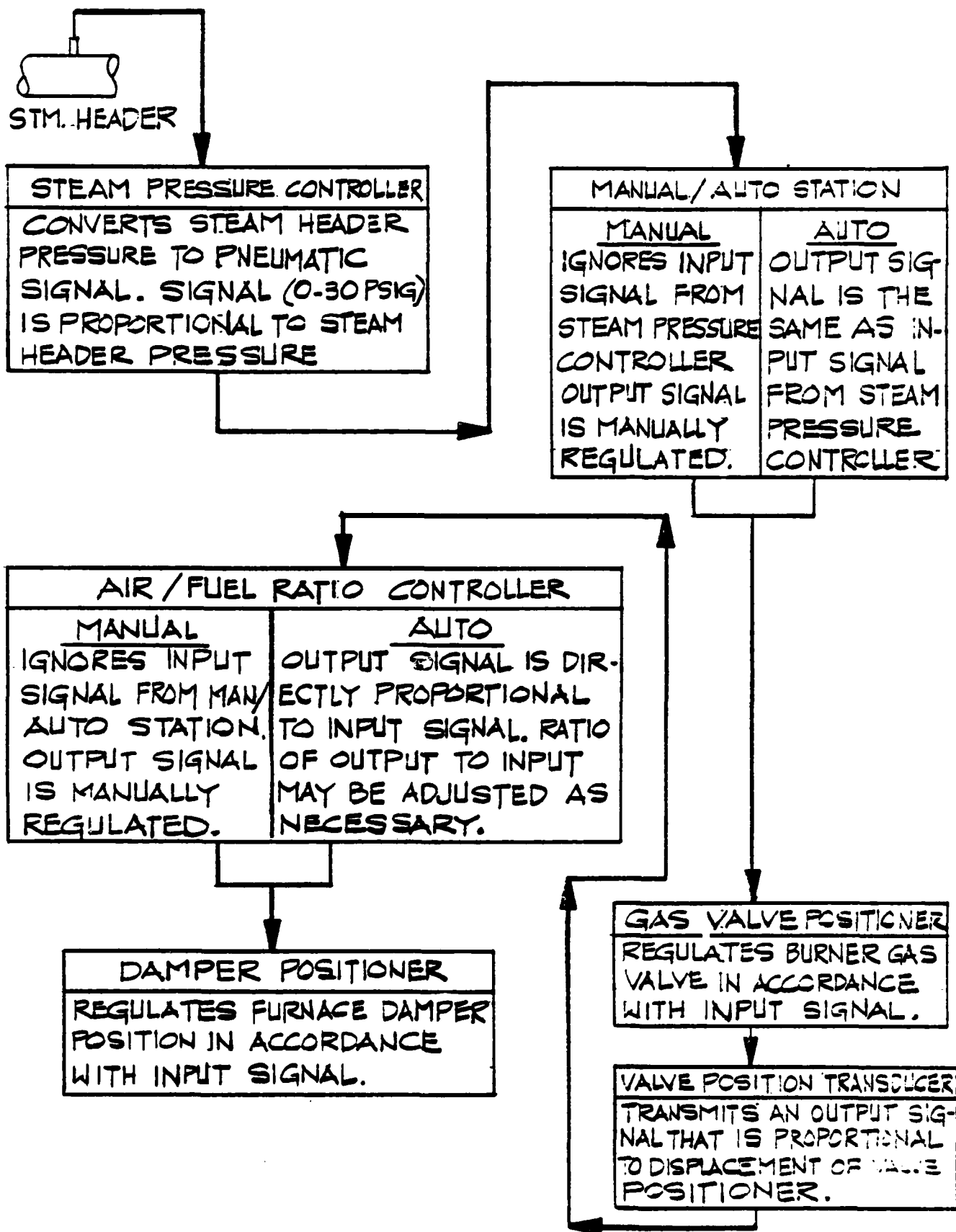

**FIGURE 4-12 FUNCTIONAL SCHEMATIC DIAGRAM
 SERIES POSITIONING SYSTEM (PNEUMATIC)
 FUEL LEADING AIR**

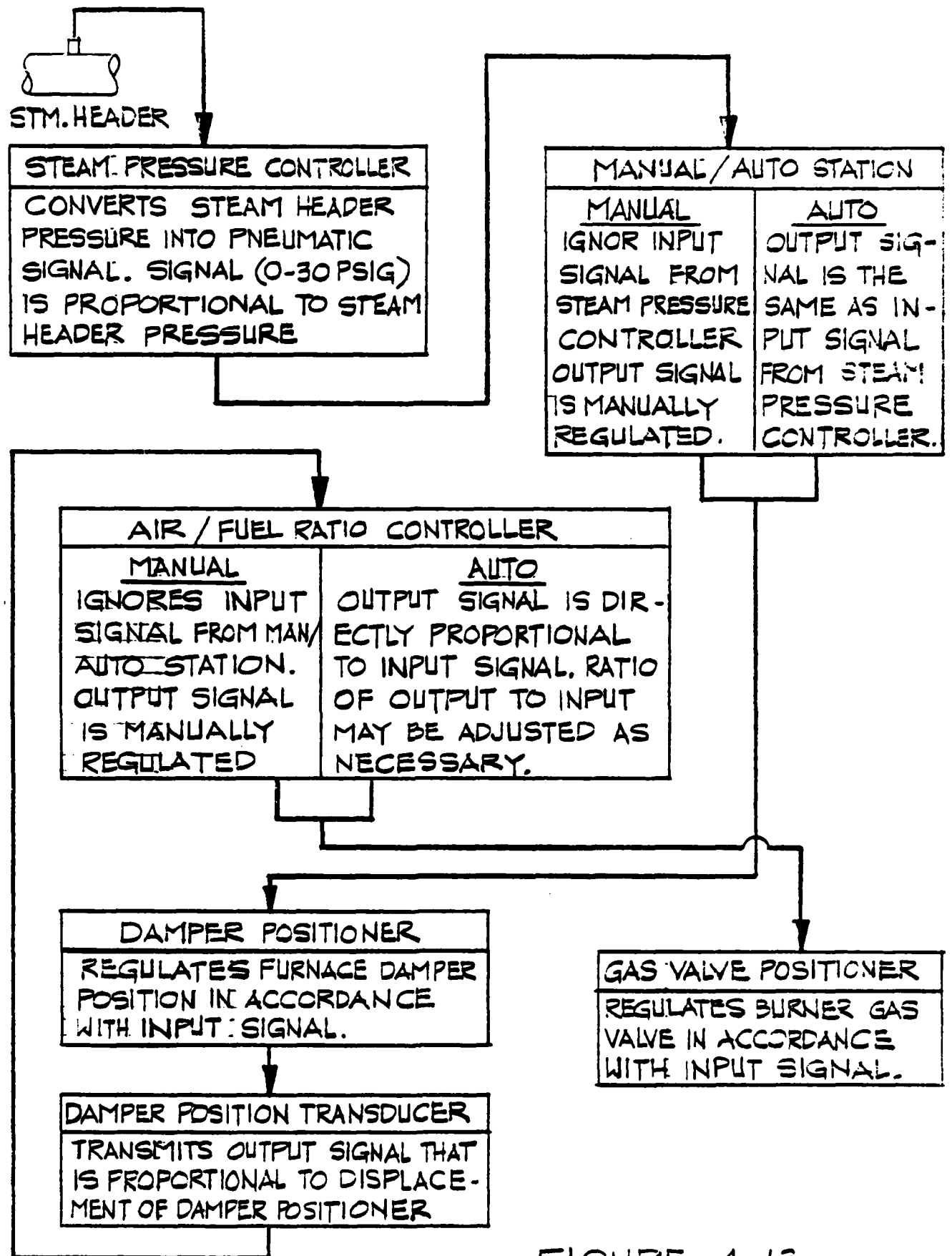
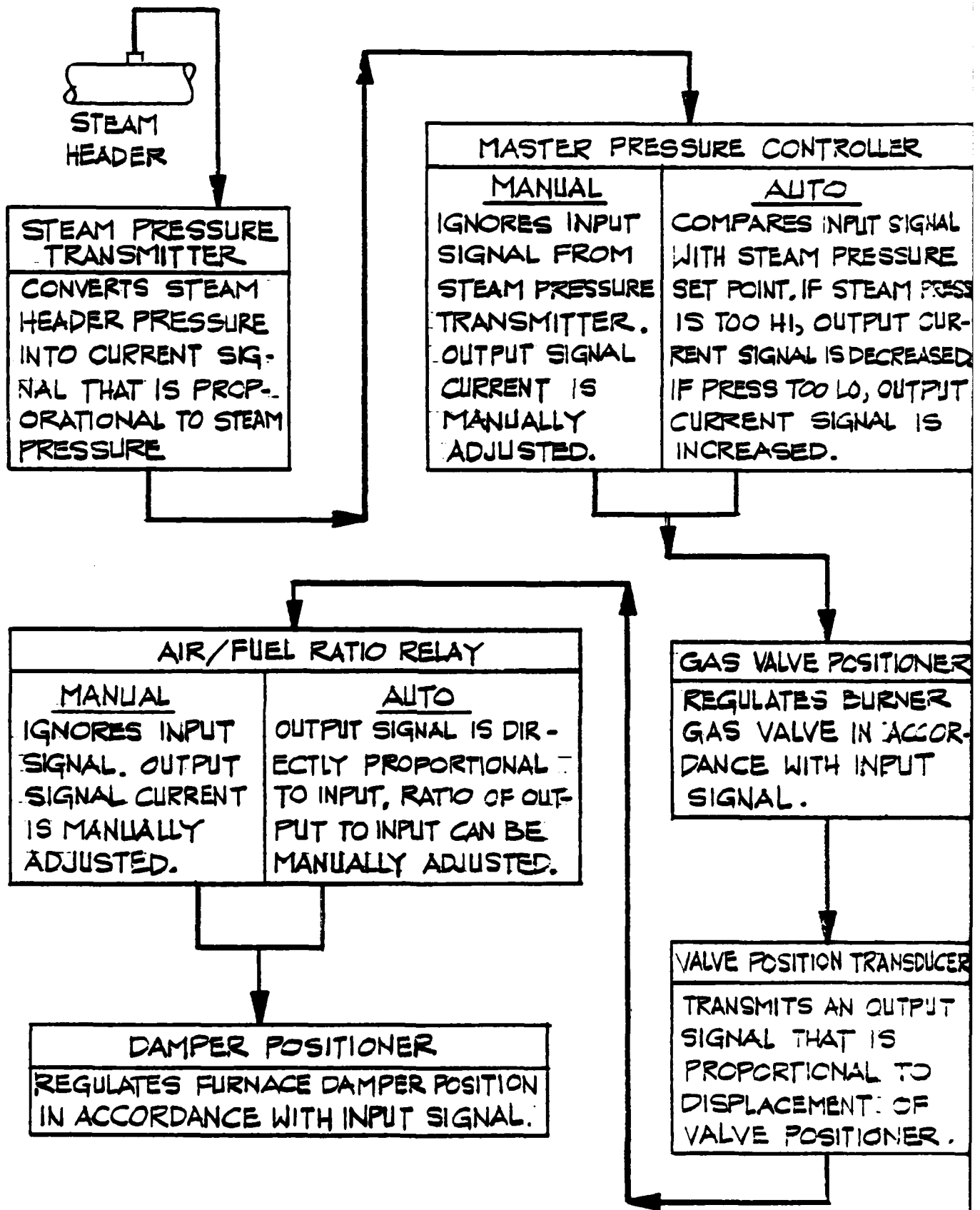

FIGURE 4-13

FUNCTIONAL SCHEMATIC DIAGRAM SERIES
 POSITIONING SYSTEM (PNEUMATIC) AIR LEADING FUEL



**FIGURE 4-14 FUNCTIONAL SCHEMATIC DIAGRAM
 SERIES POSITIONING SYSTEM
 (ELECTRIC) FUEL LEADING AIR**

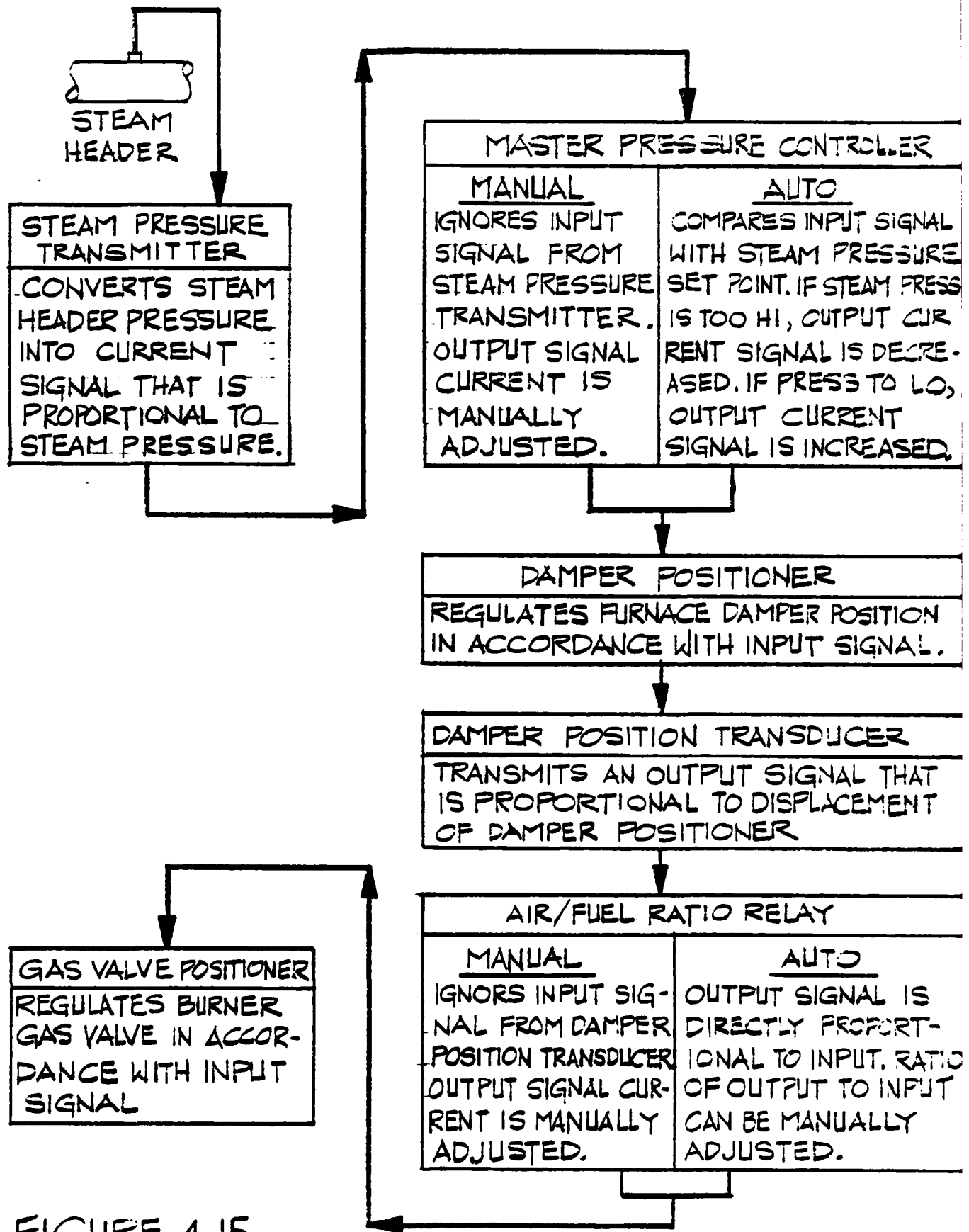

FIGURE 4-15
FUNCTIONAL SCHEMATIC DIAGRAM SERIES
POSITIONING SYSTEM (ELECTRIC) AIR LEADING FUEL

control devices. This is the same concept as was shown earlier in Figure 3-2, the block diagram for closed-loop control. A metering control system actually consists of several closed loops. The steam header pressure is measured and feedback is provided to the master pressure controller to adjust the fuel and air flows. The fuel and air flows are measured and feedback is provided to their control devices to ensure they are in accordance with the signal from the master pressure controller.

Metering systems may use either the parallel or series control scheme. A typical parallel metering system is shown in Figure 4-16. The general mode of operation of these systems is similar to the corresponding positioning systems, except that a feedback loop is provided for air flow and fuel flow.

4.5

Oxygen Trim

As discussed earlier under the sections describing series and parallel positioning systems, there may be boiler operating conditions during which the air/fuel ratio is unsuitable, and yet the control system does not have the capability to take corrective action. This may be caused by improper calibration, physical changes in the system, and variations in fuel heating value. Many of these deficiencies can be overcome by adding oxygen trim to the control system. Oxygen trim provides feedback to the control system regarding the current air/fuel ratio.

An oxygen trim system measures the excess oxygen in the combustion products and adjusts the air flow accordingly to reduce the excess oxygen to the minimum safe level. Oxygen trim systems are

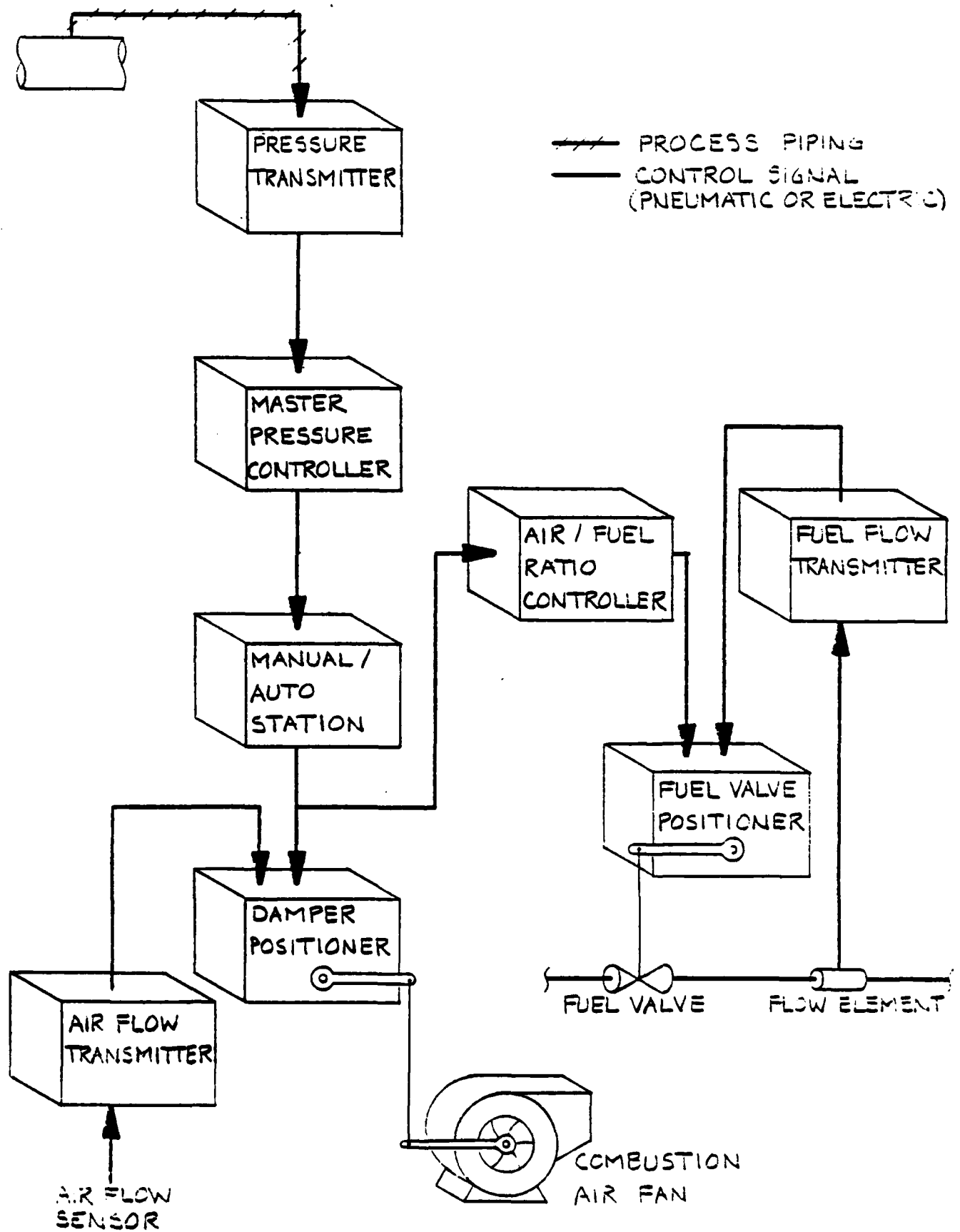

FIGURE 4-16 PARALLEL METERING CONTROL SYSTEM

shown diagrammatically in Figures 4-17 and 4-18. Figure 4-17 is a parallel positioning system with oxygen trim, and Figure 4-18 is a series system with oxygen trim.

The functioning of the oxygen trim system in either case is the same. The desired fuel and air flows are initially determined by the control signal from the master pressure controller. Since the master pressure controller only receives feedback from the steam header pressure, any signal from the master pressure controller is intended only to increase or decrease the header pressure. At the same time, the oxygen trim system measures the level of oxygen in the flue gas, and makes minor adjustments to the damper positioner. If the adjustment made by the oxygen trim system causes an increase or decrease in the steam header pressure, then the master pressure controller will again adjust the fuel and air flow together. Thus the feedback provided by the oxygen trim system may affect the fuel flow to the boiler (via the master pressure controller) even though it only adjusts the air damper positioning directly.

There are numerous oxygen trim systems available, but the operating principles of each are basically the same. An oxygen sensing probe measures the percentage of oxygen in the flue gas and transmits a control signal to an adjustable link mechanism. The link mechanism then alters the combustion air damper position. A typical mechanism is shown in Figure 4-19. The trim linkage may be located anywhere between the damper drive and the damper. The damper drive moves in accordance with the signal from the master pressure controller. The trim mechanism then by changing the effective length

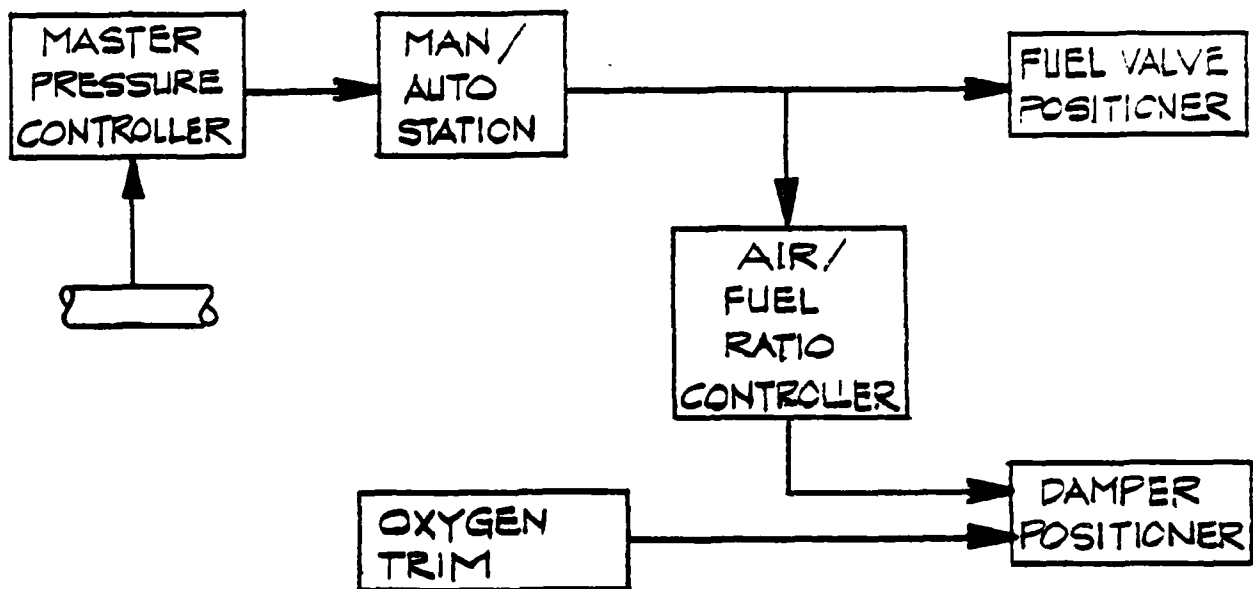

FIGURE 4-17 PARALLEL POSITIONING SYSTEM WITH OXYGEN TRIM

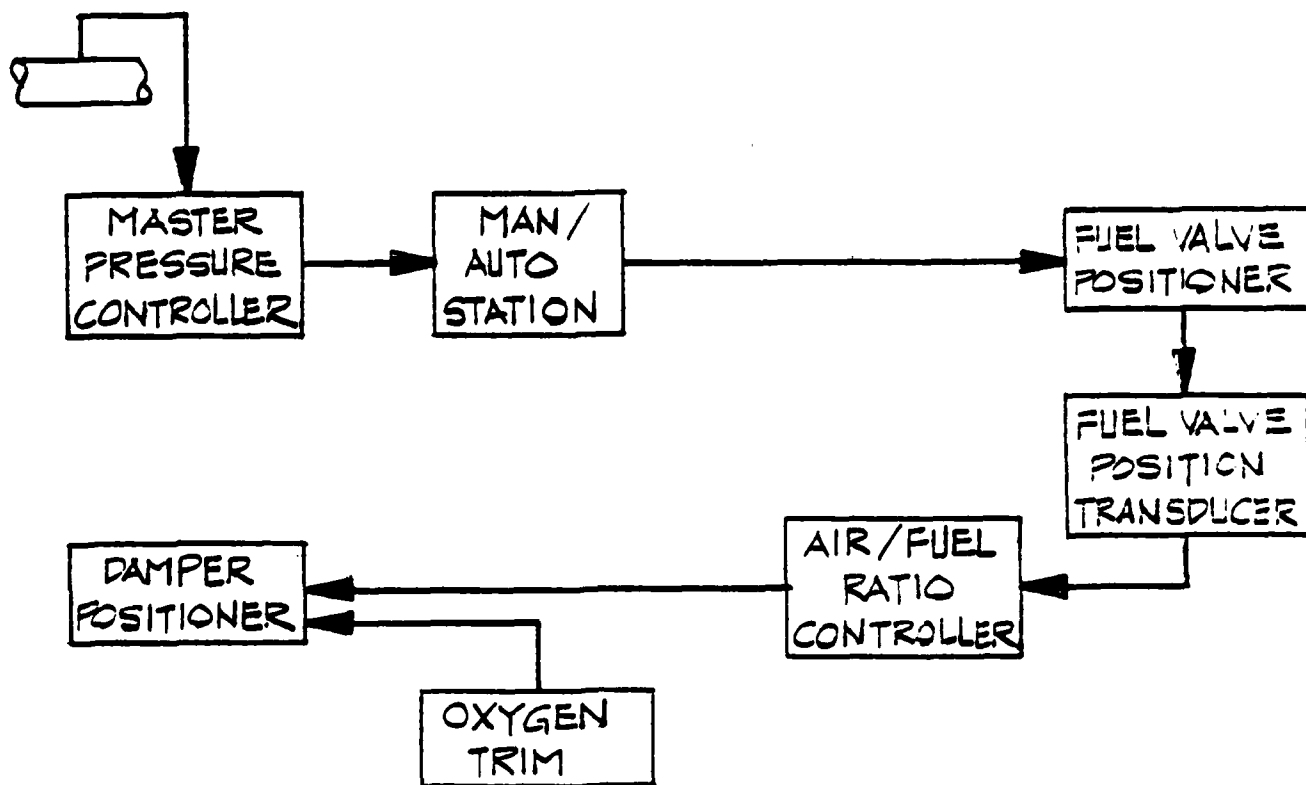

FIGURE 4-18 SERIES POSITIONING SYSTEM WITH OXYGEN TRIM

CONTROL SIGNAL FROM
MASTER PRESSURE CONTROLLER

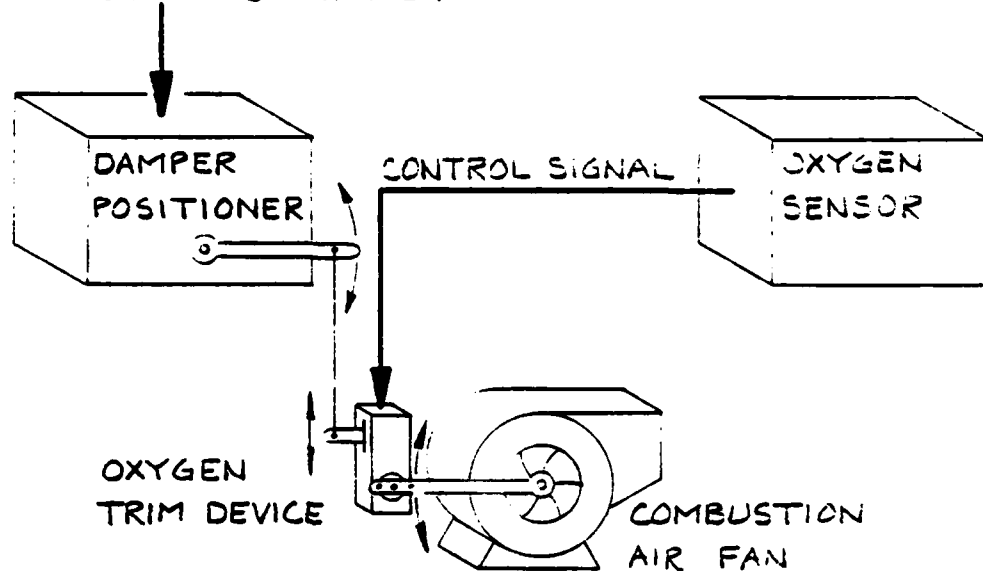

FIGURE 4-19 OXYGEN TRIM SYSTEM WITH DAMPER
MOUNTED TRIM DEVICE

CONTROL SIGNAL FROM
MASTER PRESSURE CONTROLLER

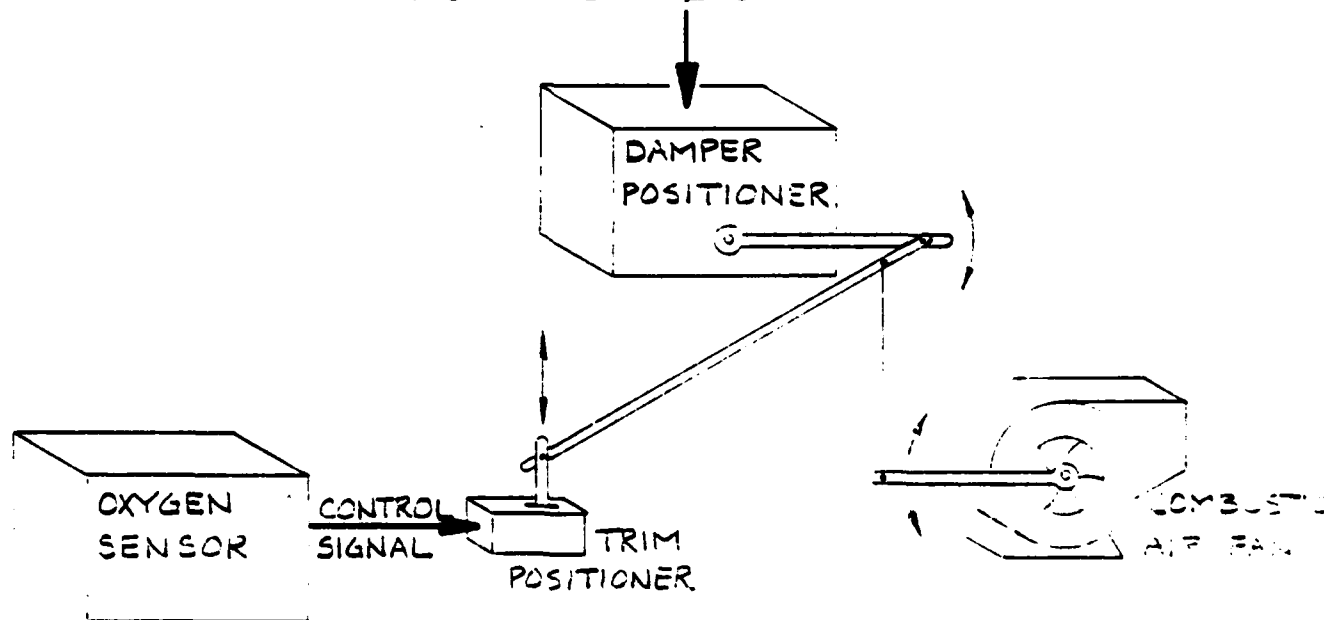

FIGURE 4-20 OXYGEN TRIM SYSTEM WITH TORY
LINK TRIM POSITIONER

of the connecting linkage, either adds to or subtracts from the damper drive displacement. An oxygen trim system using a so called "tory" link on the damper positioner is shown in Figure 4-20. This system changes the effective positioner displacement by adjusting the tory link.

Oxygen trim systems are also available which use electronic signals to perform the same function as the adjustable link mechanism. With these electronic systems, a feedback signal is provided to the damper positioner which alters its output.

Modern oxygen trim systems use a zirconium oxide probe which directly measures oxygen level. Older systems use an aspirating device which draws samples from the flue gas for analysis. These aspirating-type systems are inherently slower in response and are thus becoming obsolete.

4.6 Cross-Limiting Control

"Cross-limiting" or "lead-lag" control is another common feature which can be added to burner control systems to improve performance. Cross-limiting requires that the air flow increase first on increasing boiler load, and that the fuel flow decrease first on decreasing boiler load. This is especially important during sudden changes in boiler load. When a rapid change in load occurs, the boiler air/fuel ratio may be considerably out of adjustment until the control system stabilizes. As long as sufficient combustion air is admitted to the furnace, this does not create more than a temporary period of

inefficient operation. However, if insufficient air is present, the incomplete combustion that results can cause excessive smoking and possible hazardous conditions within the furnace.

It is, therefore, desirable to provide either a mechanical or electronic interlock in the control system that will not allow the fuel valve to open unless the air damper opens first, and will not allow the air damper to close unless the fuel valve closes first. With more advanced control systems, this is accomplished by using an auctioneering control device which receives feedback from the fuel and air flow transmitters and provides remote set points for the fuel and air flow controllers. This type of control system is generally not found on small industrial boilers due to its cost and complexity.

A more simple means of providing the cross-limiting effect is to install time delay units in the control loop upstream of the air damper and fuel valve positioners. These units cause an increasing signal to the fuel valve positioner to be delayed by a few seconds, and a decreasing signal to the air damper positioner to be delayed by a few seconds. Increasing signals to the air damper and decreasing signals to the fuel valve are not affected. This is represented graphically in Figure 4-21. This type of control does not actually "limit" the fuel flow with respect to air flow as occurs in a true cross-limiting system, but it does achieve essentially the same results.

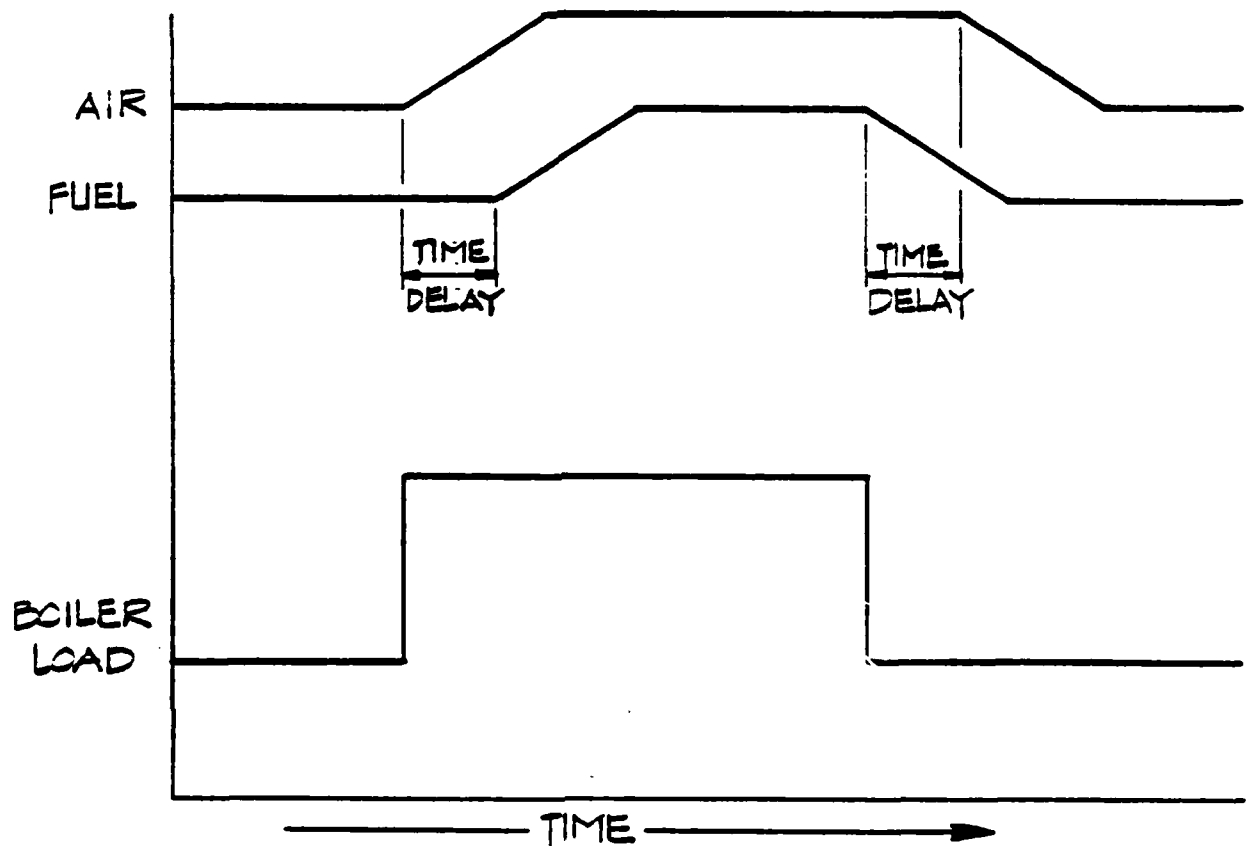

FIGURE 4-21

RESPONSE OF AIR AND FUEL FLOW TO A STEP CHANGE IN BOILER LOAD WITH TIME DELAY FEATURE.

5.0 FEEDWATER CONTROL SYSTEMS

5.1 General

As stated in Section 2.3, the purpose of the feedwater control system is to maintain the proper amount of water in the drum during all load conditions. This task is complicated by the effects of drum swell or shrink which occurs during load changes. Feedwater controls must take into consideration the design of the boiler as well as the operating conditions which are likely to be experienced.

Feedwater control systems are generally classified by the number of process variables which are used in the control loop. The variables normally used are drum level, feedwater flow, steam flow, and steam pressure. Single-element control uses one variable, two-element uses two variables, and so on. A discussion of one-, two-, and three-element control is given below.

5.2 Single-Element Feedwater Control

Single-element control is the simplest and most basic type of feedwater control. Only one process variable, namely drum level, is used as input to the control loop. A schematic diagram for single-element feedwater control is given in Figure 5-1.

Although there are numerous single-element control systems available, they all follow basically the same operating principle. Drum level is measured and transferred or transmitted to a level controller or regulator, which in turn manipulates the feedwater valve. As the water level lowers, the valve is opened, and as the water rises the valve closes.

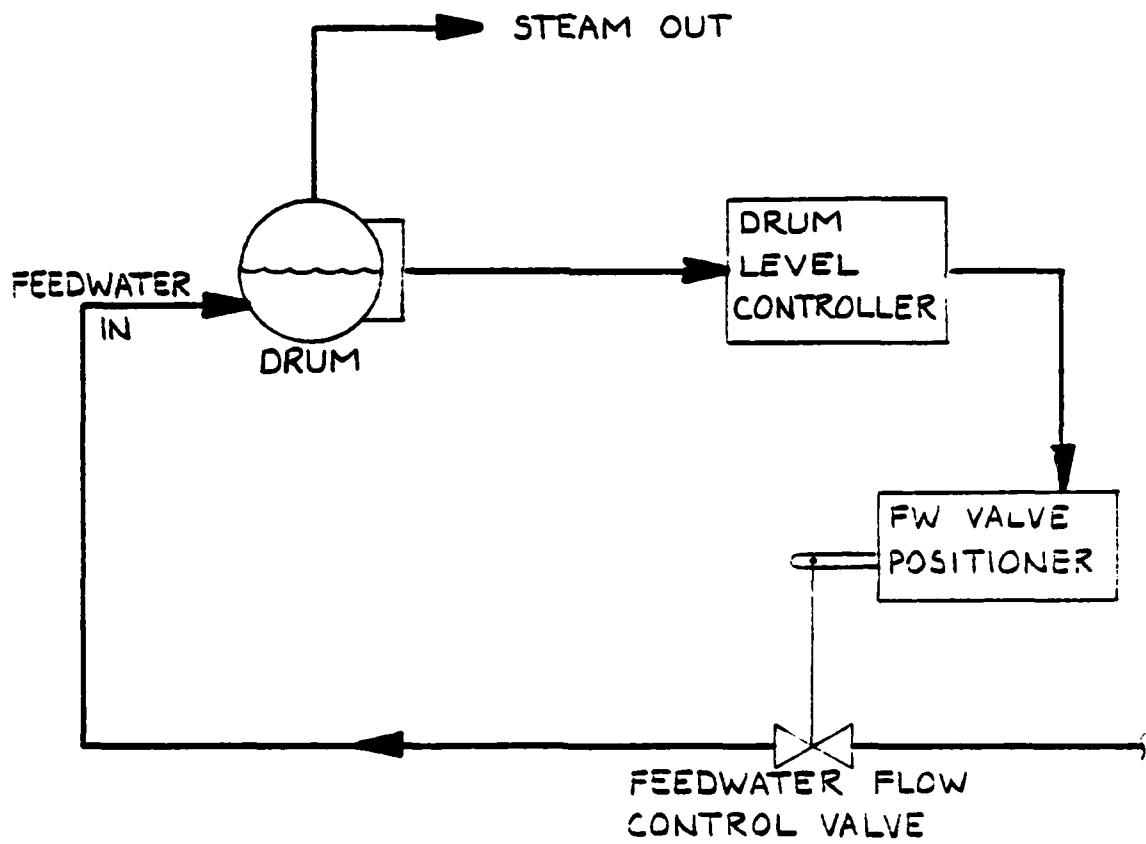
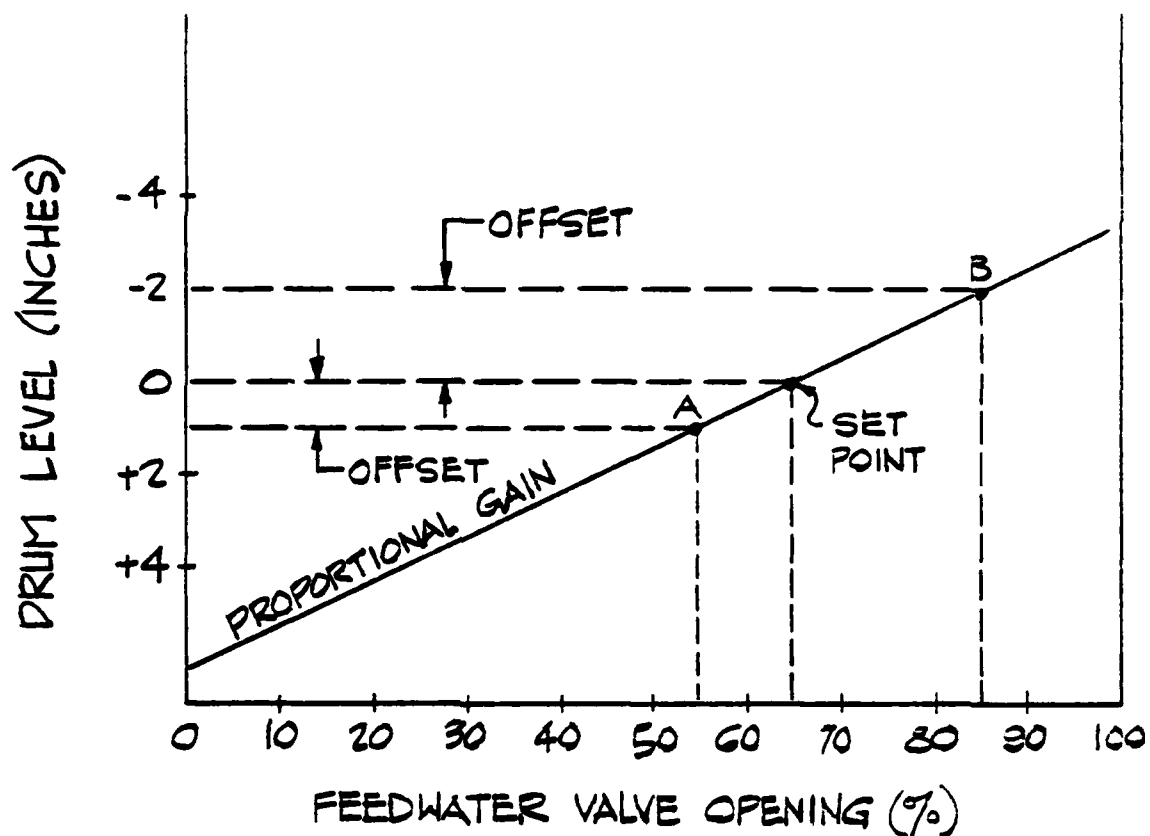

FIGURE 5-1 SINGLE ELEMENT FEEDWATER CONTROL

Many single-element feedwater controllers have proportional action only. This results in the characteristic offset experienced with proportional control (see Section 3.5). In other words, the drum level varies slightly as the boiler output varies. This is shown graphically in Figure 5-2. This is acceptable in some cases, but it is usually desirable to add an integral (or reset) function to the control signal to reduce the offset.

Even with proportional plus reset control, single element control systems can be somewhat unstable during sudden load changes. This is due in large part to the effects of drum swell. Figure 5-3 shows the response of a single-element feedwater control system with proportional plus reset control. As load increases, swelling raises the water level which causes the regulator to close the feedwater valve. The reduction in feedwater flow tends to increase the steaming rate. This produces additional swell and closes the feedwater valve even further. Eventually the lowered feedwater flow gradually causes the drum level to drop, and the feedwater valve then opens. The increased feedwater flow causes a shrink, which opens the feedwater valve even further. Finally, the rate of feedwater input exceeds the steam flow output, which causes the water level to approach the set point and the valve again starts to close. Continuous cycling of this type during a load change is common with single-element feedwater control, especially on fast steaming rate boilers.



- AT POINT 'A', BOILER OUTPUT AND HENCE FEEDWATER FLOW ARE REDUCED. AT THE PROPORTIONAL GAIN SHOWN, THIS RESULTS IN A DRUM LEVEL 1" ABOVE NORMAL.
- AT POINT 'B' FEEDWATER FLOW REQUIREMENT HAS BEEN INCREASED, RESULTING IN A DRUM LEVEL 2" BELOW NORMAL.

FIGURE 5-2 OFFSET EXPERIENCED WITH PROPORTIONAL-
ONLY FEEDWATER CONTROL

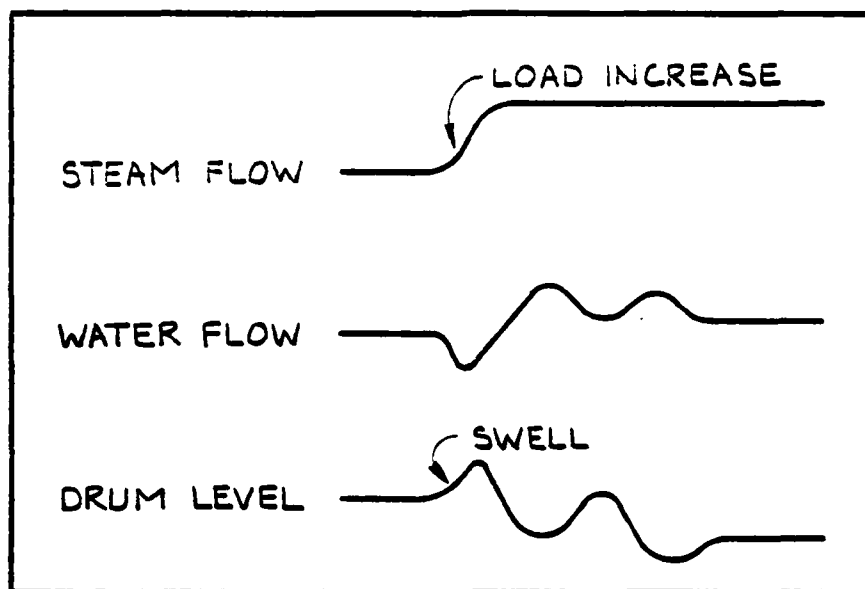

FIGURE 5-3 RESPONSE OF SINGLE-ELEMENT FEEDWATER CONTROL SYSTEM TO RAPID LOAD CHANGE.

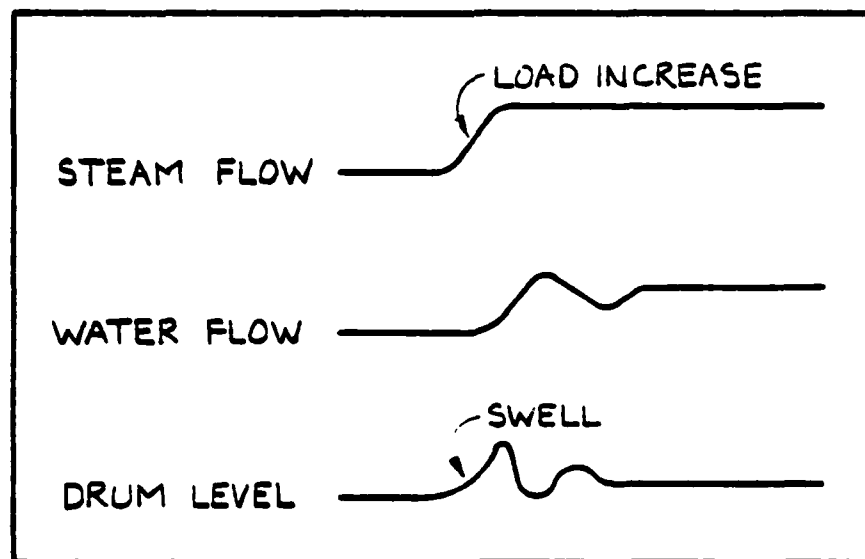

FIGURE 5-4 RESPONSE OF THREE-ELEMENT FEEDWATER CONTROL SYSTEM TO RAPID LOAD CHANGE.

Two-Element Feedwater Control

When the boiler drum level cannot be properly maintained using single-element control, a second process variable input may be added to the control loop to improve the response of the system. This is known as two-element control. (See Figure 5-5.) With a two-element system, both drum level and steam flow are used to regulate the feedwater flow into the drum. This is often necessary with boilers that have fast steaming rates or small steam drums, or which experience rapid load swings.

If the feedwater control valve could be relied upon to admit to the drum only the precise amount of water required to replace the steam flow, it would be necessary to only measure the steam flow, and no drum level measurement would be required. This is not the case, however, since the steam and water flows cannot be measured or controlled that accurately. Furthermore, the feedwater flow to the drum must also account for water lost during blowdown. Thus, the drum level must also be included in the control loop.

With two-element control, steam flow rate is measured and transmitted to a proportional positioning controller which compares the flow rate to the desired set point. If any deviation exists, a control signal is transmitted to the feedwater controller to increase or decrease the feedwater flow. A secondary signal is also sent to the feedwater controller from the drum level controller. In effect, the drum level controller modifies the set point or control point of the steam-feedwater system as necessary to correct for level changes

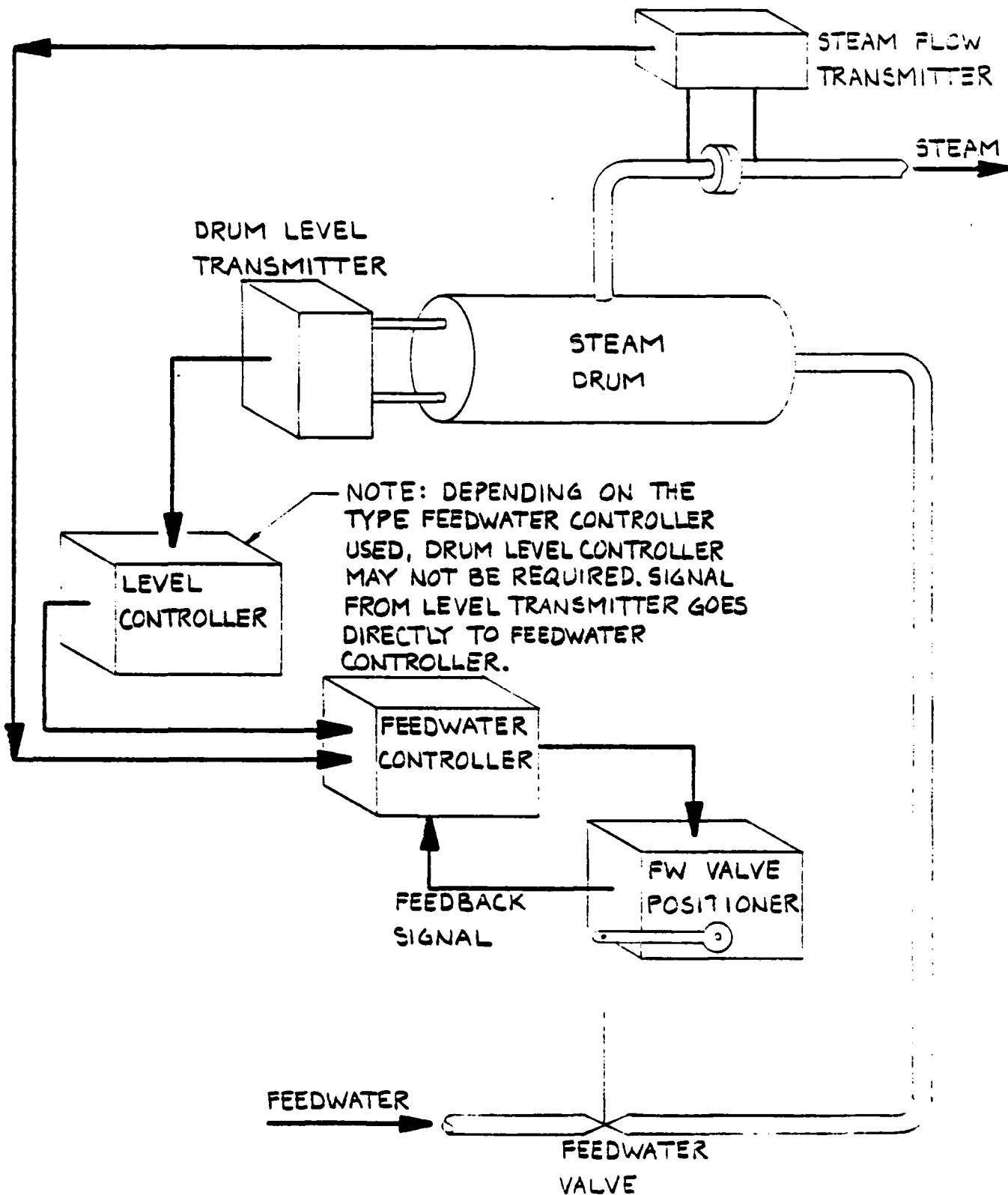

FIGURE 5-5 TWO-ELEMENT FEEDWATER CONTROL

resulting from unequal steam and feedwater flows. For example, when the load increases, the steam flow transmitter and control system respond to increase feedwater flow. This, in effect, anticipates the change in water level. It also counteracts the tendency of the drum level element to close the feedwater valve as swell occurs. Thus, both the feedwater flow and the drum water level are quickly stabilized, even if the change in load is rapid or large. A two-element system provides sufficient reduction in the sensitivity of the feedwater level controller so as to disregard the normal effects of shrink or swell.

5.4 Three-Element Feedwater Control

When operating conditions are severe, the three-element control system is by far the most reliable for maintaining drum level within the desired limits. With three-element control, the feedwater flow is measured in addition to steam flow (or pressure) and drum level (see Figure 5-6). This provides a closed-control loop in the system which is not available with either one or two-element control. With both one and two-element control, the feedwater valve positioning is open-loop. Actual flow is not measured, and the feedback to the control loop which corrects the valve positioning comes from drum level only.

In a three-element control system, the feedwater flow is measured, and a feedback signal is produced which adjusts the output signal from the feedwater controller. This direct feedback insures

that the desired feedwater flow is quickly achieved despite variations in water pressure or water temperature, changes in valve characteristics, loose linkages, or other system deviations.

Three-element control reduces the sensitivity of the drum level controller below that achievable with two-element systems, which makes them virtually unaffected by drum level instability. Three-element systems can also make effective use of proportional-plus-reset functions in the feedwater controller, thus eliminating droop (or offset). Figure 5-4 is a graphic representation of the response of a three-element control system to a sudden change in boiler load. As can be seen from this diagram, the feedwater flow is increased quickly after load increase, even though the apparent drum level has increased due to swell. The feedwater flow also quickly stabilizes despite several fluctuations in drum level. The drum level returns to its original position (with no offset) even though the boiler output has increased.

Three element control systems are also available which measure steam pressure (instead of flow), drum level, and feedwater flow. Although this approach is somewhat less common, it, too, provides precise control. The functioning of this type system is essentially the same as that outlined above, the only difference being the fact that steam header pressure instead of flow is monitored.

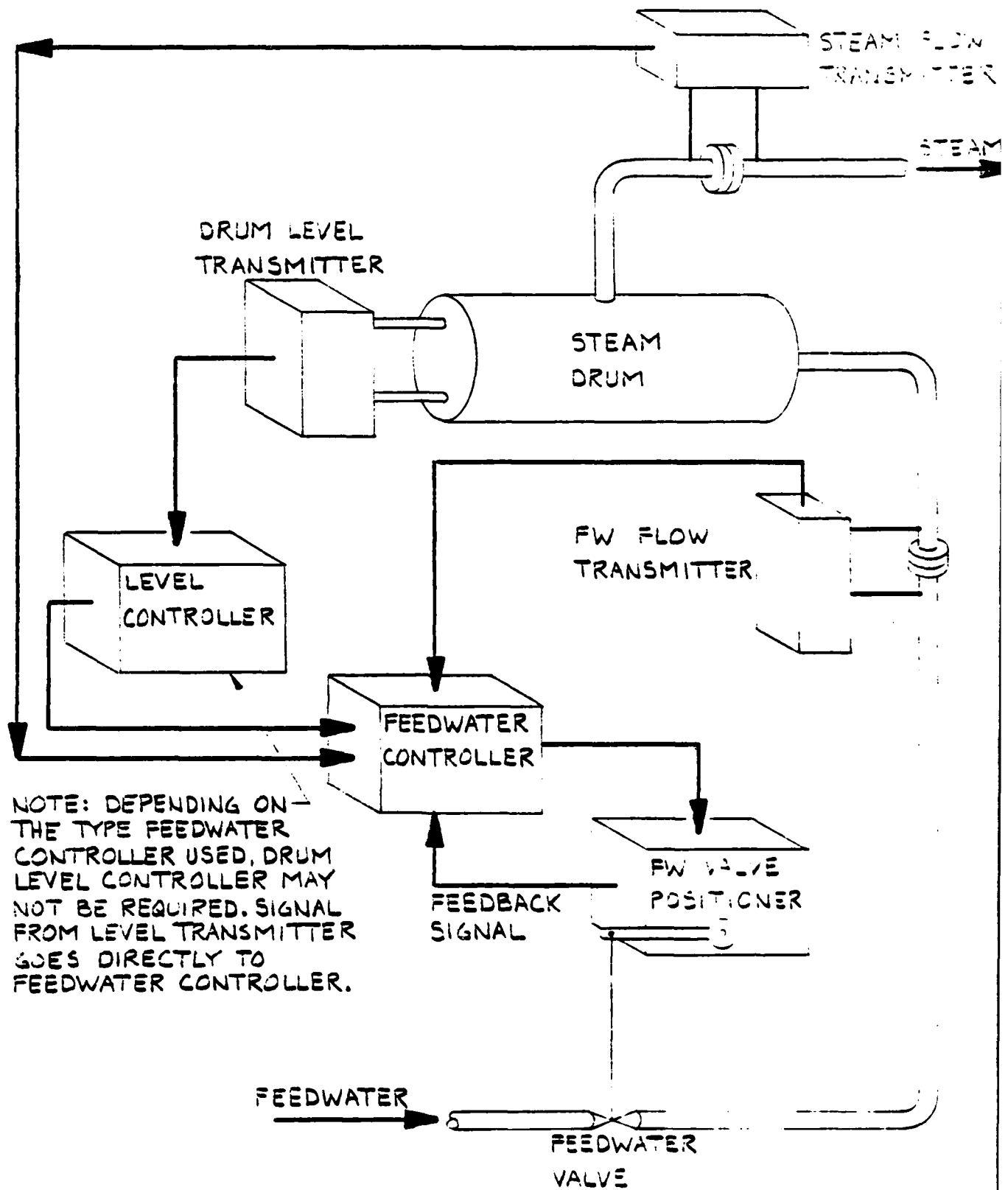

FIGURE 5-6 THREE-ELEMENT FEEDWATER CONTROL

5.5 Mechanical Feedwater Regulators

Mechanical feedwater regulators provide a complete control system, from drum level sensing to feedwater valve positioning. They generally provided single-element control, but two-element control regulators are also available. In either case, the entire control process is accomplished mechanically, and electronic or pneumatic control elements are not required.

Mechanical regulators have generally been replaced through the years with electronic or pneumatic systems like those described earlier. However, many of these regulators are still in existence and some types are still being installed on small boilers today. Two of the more common types of mechanical feedwater regulators are discussed below.

A thermo-hydraulic, or generator-diaphragm type of feedwater regulator is shown in Figure 5-7. This regulator uses the increase in pressure caused by evaporating water within a confined space to position the feedwater control valve.

The water is evaporated in a "generator" which consists of two concentric tubes. As can be seen from Figure 5-7, the outer tube of the generator is connected to the valve diaphragm chamber, which in turn positions the feedwater valve. The diaphragm, connecting tubing, and the outer tube of the generator filled with water. The water does not circulate, and heat is radiated from it by fins located on the generator. The inner tube is connected directly to the water column and contains boiler water and steam. The water in the inner tube remains at the same level as that in the drum.

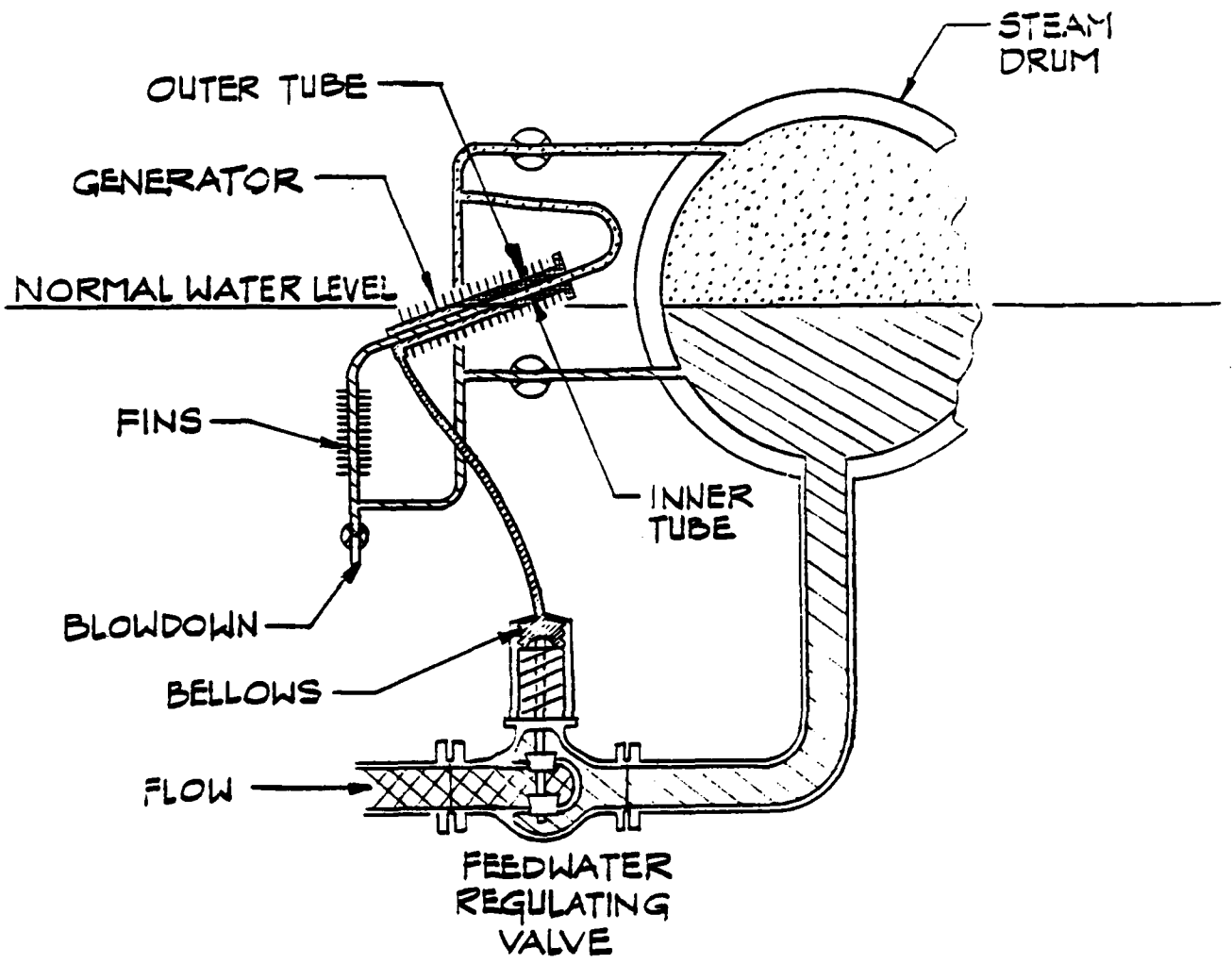

- | | | | |
|---|------------------|---|-----------------|
|  | BOILER WATER |  | GENERATOR WATER |
|  | BOILER STEAM |  | GENERATOR STEAM |
|  | BOILER FEEDWATER | | |

FIGURE 5.7 THERMO-HYDRAULIC FEEDWATER CONTROL SYSTEM

When the water in the drum is lowered, more of the inner generator tube is filled with steam. Since heat is transferred faster from steam to water than from water to water, extra heat is added to the confined water in the outer generator tube. The radiating fin surface is not sufficient to remove the heat as rapidly as it is generated. The heat from the steam in that portion of the tube vacated by the drop in water level thus causes the water in the outer tube to flash into steam. This increases the pressure in the outer tube which, in turn, causes the bellows in the valve positioner to expand. This forces the valve to open and admit more water to the drum. When the drum level is raised, the above process is reversed.

A thermostatic expansion tube regulator is shown in Figure 5-8. This type of regulator uses the expansion and contraction of a thermostatic tube to position the feedwater control valve. As can be seen in the diagram, lowering the drum level causes more of the thermostatic tube to be filled with steam. Since heat from the steam is transferred to the tube faster than the heat can be radiated from it, the tube expands. This causes displacement of the feedwater valve linkage and the valve is opened. When the water level rises, the process is reversed.



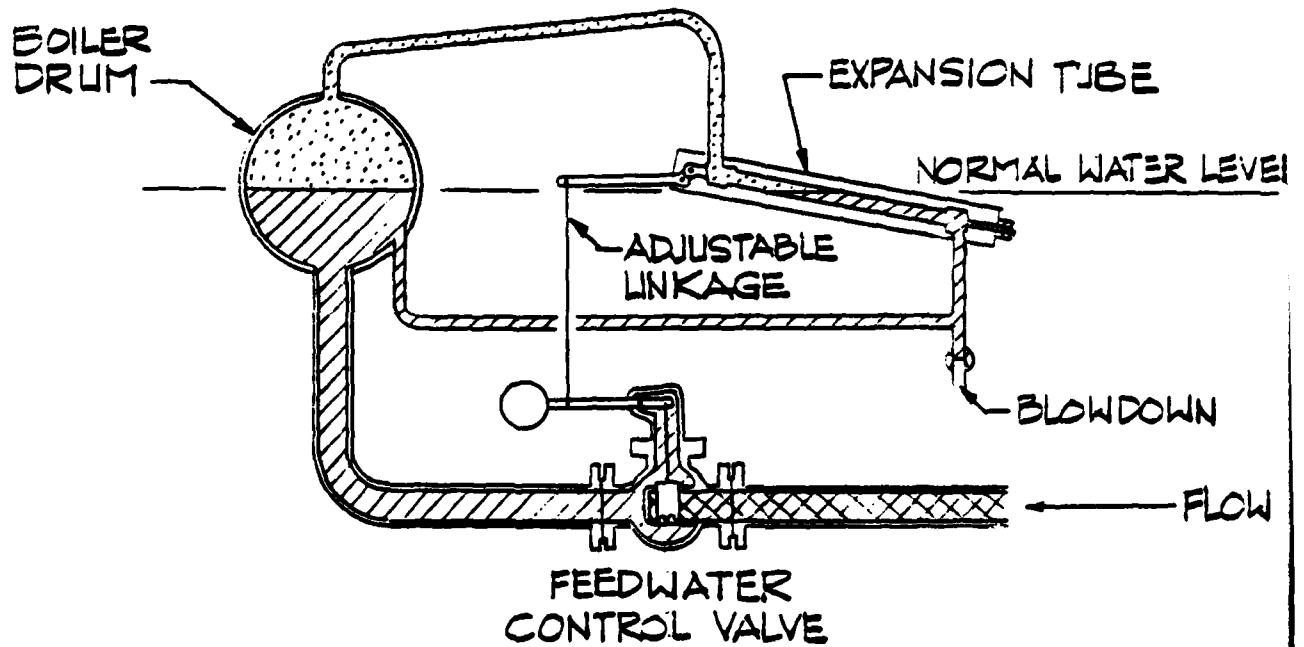

-  STEAM
-  BOILER WATER
-  FEEDWATER

FIGURE 5.8 THERMOSTATIC EXPANSION TUBE
FEEDWATER REGULATOR

6.0 FLAME SAFETY SYSTEMS

6.1 General

The purpose of the flame safety system is to prevent explosions that can occur when: (1) a flame or other ignition source is introduced into a furnace that contains air and fuel vapors in an explosive mixture, (2) fuel is discharged into the furnace during start-up without proper ignition taking place, (3) the burner flame is extinguished during normal operation without the fuel supply being shut off; or, (4) a major malfunction in the burner or feedwater control system occurs. There are a number of control techniques available, and the various manufacturer all have their own preferences, but each flame safety system provides protection in the areas outlined above.

In contrast to the sections covering burner and feedwater controls, no attempt will be made here to identify all the control components in the flame safety system. Instead, the basic functions of the system will be examined during each of three operating modes: start-up, normal operation, and shut-down will be discussed. The reason for this approach is the fact that flame safety systems are generally not discrete systems. Rather, they are a series of timers, relays, limit switches, sensing devices, etc., which are integrated into the burner control system to provide the necessary interlocks.

Although totally automatic systems are available, only semi-automatic or "supervised manual" systems will be discussed here. The more advanced systems are generally not found on small industrial boilers and are, therefore, considered beyond the scope of this text.

Start-Up

Start-up from a cold condition presents perhaps the greatest danger from explosion. It is essential that the furnace be purged of all combustible gases before any source of ignition is introduced, and that once fuel flow is initiated, ignition takes place quickly.

The entire startup process may be controlled automatically, but most small industrial boilers are started either manually or semi-automatically. If a manual-only system is provided, few interlocks may exist other than those which prevent lighting the ignitor after the fuel valve to the main burner has been opened. Semi-automatic systems provide a much greater level of protection against improper operation and are obviously more complex. The interlocks provided by a semi-automatic (supervised manual) flame safety system during the start-up process are shown in Tables 6-1 and 6-2.

Purging of the furnace is generally accomplished using the combustion air fan(s). A purging air timer is provided that will not allow ignition until the fan(s) have been in operation for a specific period of time. For watertube boilers the purge air flow must be at least 70 percent of the air flow required at the maximum capacity of the boiler, and the duration of the purge must be sufficient for at least eight air changes to occur. (This is usually around 5 minutes). For firetube boilers, the purge is conducted with wide open dampers, and four air changes are normally required. In either case, air flow is verified by providing limit switches on the dampers and a pressure switch at the fan discharge, or by providing air flow measurement devices such as differential pressure switches.

Once fuel flow has been initiated to the ignitor or main burner, flame verification is usually achieved by means of flame scanning devices. These flame scanners may be either the infrared flicker type or the ultraviolet type. (See Section 7.3.1).

TABLE 6-1
 FLAME SAFETY SYSTEM
 TYPICAL PREFIRING CYCLE

<u>Operator Function</u>	<u>Flame Safety System Function</u>
1. Check to see that fuel shut-off valve is closed.	Verify fuel shut-off valve is closed.
2. Start fan.	Verify fan is on.
3. Where used, open atomizing medium valve.	Verify atomizing medium supply is available.
4. Open damper(s) to purge position.	Verify air pressure is available and damper(s) is open or verify air flow.
5. Start purge timer.	Verify purge time has elapsed.
6. Place damper and fuel control valve in light-off position.	Verify damper and fuel control valve in light-off position. If light-off air flow is less than purge air flow, start light-off time limit timer.
7. None	Verify spark and igniter and main safety valve is operable.

TABLE 6-2
FLAME SAFETY SYSTEM
TYPICAL LIGHT-OFF CYCLE

<u>Operator Function</u>	<u>Flame Safety System Function</u>
1. Start igniter ignition system.	Verify igniter operation. If air flow is less than purge air flow rate, igniter operation shall be demonstrated within 10 seconds.
2. Open fuel safety shutoff valve to main burner.	None
3. Open manual fuel shutoff valve.	Verify flame within 10 seconds for gas, No. 2, and No. 4 oil, 15 seconds for No. 5 and No. 6 oil. Close igniter safety shutoff valve(s). For gas igniter vent gas piping between shutoff valves.
4. Bring unit to preset operating pressure at acceptable rate and switch to automatic combustion control.	None

6.3

Normal Operation

The main safety hazard during normal operation is loss of the burner flame. This can result from a variety of causes, including improper fuel pressure, interruption in fuel supply, contaminated fuel (with water, sludge, etc.) boiler tube rupture or some malfunction of the burner itself. If the burner controls are improperly calibrated, the flame can be unstable due to improper air fuel ratio.

The flame safety system must, therefore, ensure that the fuel supply to the burner is shut off immediately whenever the burner flame is lost. This is accomplished using the same flame scanners that are used for start-up. If more than one burner is provided, a flame scanner is usually furnished for each burner. If the burner flame goes out inadvertently, the flame scanner immediately trips the fuel safety shutoff valve.

The flame safety system must also have the ability to take the boiler out of service if a major malfunction in the burner control system or feedwater control system occurs. Therefore, interconnections are usually provided between the flame safety system and both the burner control and feedwater control systems. These interconnections allow the flame safety system to trip the boiler any time one of the following conditions occur:

1. Loss of burner control system power (electric, pneumatic, or hydraulic)
2. Loss of combustion air supply
3. Excessive steam pressure
4. Loss of atomizing medium (if required)
5. Very high or very low drum level
6. Improper fuel supply pressure

If the boiler is furnished with sootblowers, interlocks are normally provided so that sootblowing can only be performed when the boiler is in service with a firing rate sufficient to avoid extinguishing the burner flame. Sootblowing during shutdown or startup is thus precluded.

6.4 Shutdown

The flame safety system is involved in both the normal boiler shutdown and the emergency or safety shutdown. (The normal shutdown is one which is initiated by the boiler operator, whereas the emergency shutdown is initiated by the flame safety system or by any boiler trip signal.)

During a normal shutdown, the flame safety system verifies that the fuel safety shutoff valve to the main burner is closed so that the combustion air fan and atomizing system (if used) may be shut down. In an emergency shutdown, the flame safety system will normally stop the fuel supply to the main burner and the igniter (by tripping the safety shutoff valves) and interrupt the spark to the igniter. If a gas burner and/or igniter is used, the flame safety system will also vent the piping between the fuel safety shutoff valves during an emergency shutdown.

- 7.0 CONTROL SYSTEM COMPONENTS
- 7.1 Burner Controls
- 7.1.1 Manual/Auto Control Station

Function

The manual/auto control station allows the operator to isolate a device or sub-system from automatic control and to operate that device or sub-system manually from the control station.

Theory of Operation

o Pneumatic Systems

In the automatic mode of operation, the output signal from the manual/auto control station is identical to the input signal. An unrestricted passage is provided through the device so that the air pressure at the outlet signal port is the same as the air pressure at the inlet. In other words, the manual/auto control station has no effect on the system when it is in the automatic mode.

In the manual mode of operation, the output signal is totally independent of the input signal. The input pressure signal is blocked by means of a multiport valve, and the output pressure signal is controlled by manually adjusting a pressure regulator. This regulator is fed from an auxiliary air supply (from the instrument air compressor).

An important feature of the manual/auto control station is what is called "bumpless transfer." That is, the ability to switch back and forth from manual to auto without drastic or rapid changes in the output pressure signal. Indicating gauges are provided on the control station, and the valving arrangement is such that the output signal may be manually adjusted to match the input signal before the transfer is made.

o Electronic Systems

The electronic manual/auto control stations operate in the same manner as the pneumatic units, except that electronic circuitry is utilized instead of mechanical components. The input signal can be duplicated as output (auto mode), or the input signal can be blocked and an independent output signal generated by the unit (manual mode).

BAILEY 7000 M/A STATION Type 711

Function

Provides a means of connecting a final control element either to an automatic signal, or to a manually adjustable source of 4-20ma DC within the station. Transfer to and from manual control is bumpless.

The station may be equipped with an optional input meter.

Application

The Type 711 Manual/Automatic Station is used primarily where one controller actuates several final control elements and it may be desirable to switch any element from automatic to manual control.

Description

The Type 711 Manual/Automatic Station is provided with an output meter with a scale calibrated 0-100 per cent. The meter is equipped with a manually adjustable pointer on the outside of the case. This memory pointer allows the operator to mark the station output for normal operation.

Operation

When the station manual/automatic switch is in the automatic position the 1-5 volt input produces two output signals, 1-5 volts and 4-20ma DC.

When the M/A switch is in the manual position, the station output is derived from a pushbutton actuated manual power supply. Interchangeable caps on the pushbuttons, marked "Close" and "Open", indicate the state of the final control element corresponding to 0 and 100% output. When normal pressure is applied to a pushbutton, the station output changes at a rate that takes 50 seconds for 100 per cent change. If the button is pressed hard against the stop, the output change is 100 per cent in 5 seconds.

Normally, the left pushbutton causes the manual output to decrease, however, the direction of change can be reversed by repositioning jumpers on the circuit board.

There is no change in output when the station is switched from automatic to manual.

When the station is switched from manual to automatic there is no immediate output change. If, however, the manual output is not the same as the automatic signal at the time of transfer, the station output will ramp to the proper value at an adjustable rate of 0-30 seconds for a 10% change.

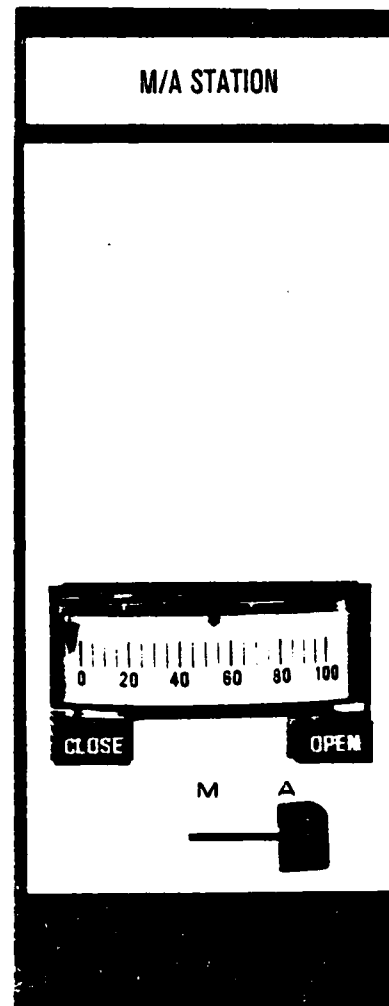

FULL SIZE

FIGURE 1 - Type 711 M/A Station

© Bailey Meter Company 1974

MINI-LINE* 500 HAND/AUTOMATIC STATION

Provides all necessary indications and controls for smooth, "bumpless" hand automatic transfer and complete remote manual or automatic operation of a pneumatic control system.

Application

For use as a single-loop or multi-loop pneumatic control system component or as an independent operating station remote from central control location.

Features

- Small size and compact grouping of all indicators and control knobs provide maximum efficiency and flexibility in layout of control stations.
- Plug-in module design permits removal of H/A station without disturbing piping since all connections are made at manifold on rear of protective case which mounts directly to panel.
- Reduces routine maintenance through use of built-in air supply filters.
- Shock and vibration resistant.
- Simplifies stocking of spare parts since many of the component parts are common to other Bailey equipment.

**FIGURE 1 — MINI-LINE 500
H/A Station, TYPE AJ.**

* Reg. U.S. Pat. Off.

SERVICE

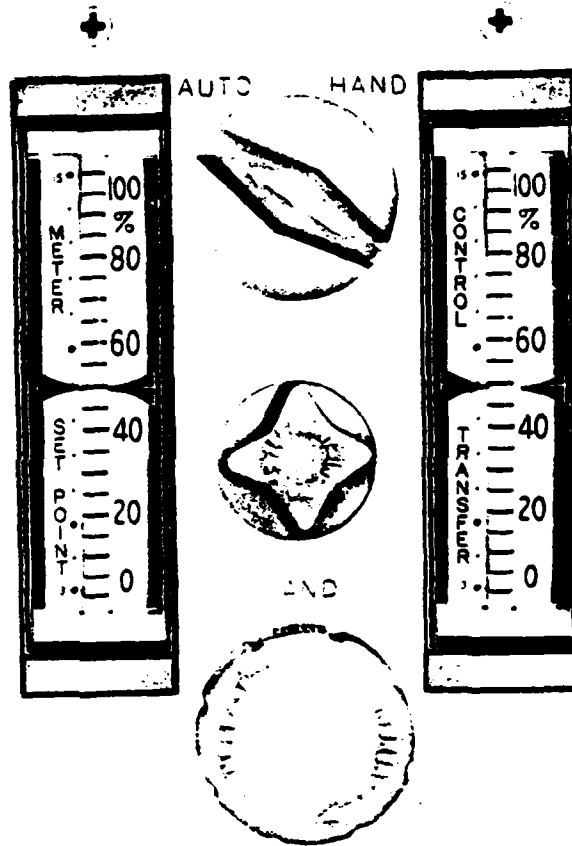

FULL SIZE

FIGURE 7-2 BAILEY PNEUMATIC MANUAL/AUTO STATION

BAILEY 7000 BIAS M/A STATION Type 712

Function

The Type 712 Bias Manual/Automatic Station accepts an input signal and either adds to it, or subtracts from it a fixed amount up to 25% of the input span. After this addition or subtraction, the signal is passed on to the load if the station manual/automatic switch is in the automatic position.

If the switch is on manual, the load is supplied with either 1-5 volts or 4-20ma from an independent supply within the station.

Application

Figure 2 illustrates a typical application of the Type 712 Bias M/A Station. Header pressure is controlled by a pressure controller, the output of which regulates flow of coal from three pulverizers to a boiler.

For the same control signal the pulverizers do not deliver the same quantity of fuel to the combustion chamber, and if the pulverizers do not divide the load equally, they may cause the operation to be inefficient.

The bias stations make it possible to balance the pulverizer outputs so that they respond equally to the pressure controller output.

Description

The Type 712 Bias Manual/Automatic Station consists of a front panel on which are mounted the bias setting mechanism, meters, manual operation pushbuttons and two-position transfer switch. The vertical meter is a 1-5v voltmeter scaled 0-100 representing percent of the input variable. The horizontal meter is scaled 0-100 representing percent of the station output which may be either 1-5 volt or 4-20ma.

The electronic elements, which are a combination of integrated circuits, amplifiers, and discrete components, are mounted on a single glass epoxy laminated circuit board.

The top and bottom of the controller are extruded aluminum, and an easily removed cover plate on each side completes the enclosure.

A spring catch on the top secures the station in its normal position on the shelf but allows easy withdrawal, either completely or half-way, for in-place calibration.

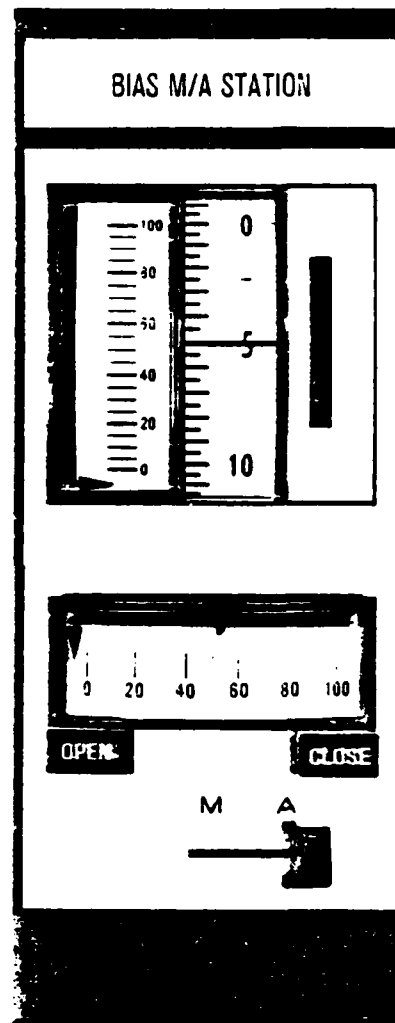

FULL SIZE

FIGURE 1 - Type 712 Bias Manual/Automatic Station.

Hays-Republic

model C-04330

pneumatic control stations

- MANUAL or MANUAL-AUTOMATIC ● CONSOLE ORIENTED ●
- BUMPLESS M/A TRANSFER ● MINIMUM PANEL SPACE ●

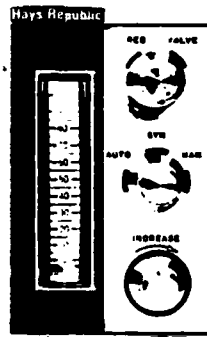

operation

The Hays-Republic series of pneumatic control stations are available in seven variations for such applications as: remote set point; manual-auto transfer of panel or remotely located controllers; manual-auto stations for spring set point or cascaded controllers; monitoring and remote positioning of final drive devices; and stations for monitoring only.

The control stations feature a 3-inch duplex scale indicating the controller variable with either the final control or set point pressure. All controls and switches are readily accessible on the front of the compact panel. There is no need for back-of-the-panel adjustments, or special setting procedures.

Basic elements for each station include a hand loader for quick set point adjustments when the system is on automatic; or loading a final control element during manual operation. Manual-auto models contain transfer valves providing positive, bumpless m/a transfer. Models C-43301 and C-43304 include a position switch for set point loading pressure and controlled variable synchronization.

specifications

Model	C-04330
Input/Output	3 to 15 psig
Indicator:	
Accuracy	±1% of Range
Sensitivity	±1/2% of Range
Red Pointer	Manual Loading
Black Pointer	3 to 15 psig Input
Air Supply	18 to 20 psig
Static Air Consumption	0.1 scfm
Service Markings	25 Spaces
Panel Cutout	2-3/4" w x 5" h
Weight	6 Pounds Net

FIGURE 7-4 HAYS-REPUBLIC ELECTRONIC MANUAL/AUTO STATION

Hays-Republic

model C-85001

hand auto station

- SIMPLE RUGGED DESIGN • PRECISE MANUAL POWER UNIT POSITIONING •
- CONVENIENT FRONT ADJUSTED ZERO AND SPAN •

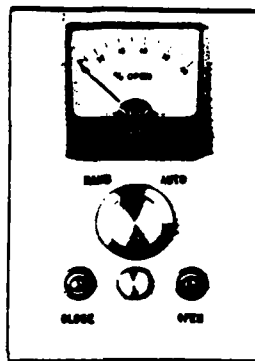

application

The C-85001 Hand-Auto Station permits remote or rear of panel mounting of 840 series controllers while providing the necessary manual functions and position indication (optional) to the operator. Mounting of 840 controllers at locations other than the front of the panel makes greater panel area available for items which are necessary there. If desired, the C-85001 Hand-Auto Station may be located on sloping panels or bench boards, a location not permissible for the 840 controller.

Controllers of the 840 series which may be used with the C-85001 Hand-Auto Station in this manner are C-84105 Sequence Draft Controller, C-84106 and C-84107 Draft Controllers and the C-84601 Electric Positioning Controller.

construction

The C-85001 Hand-Auto Station incorporates the conventional two-position hand-auto switch with separate "open" and "close" push button switches. Optional is an electrical indicator showing the position of the power unit manipulated by the 840 controller and the Hand-Auto Station. A 500 ohm slidewire is required on the power unit to operate the position indicator. Energy for the position indicator circuit is supplied by a small stepdown transformer supplied as an integral part of the Hand-Auto Station. Indicator span adjustment is accessible from the front of the panel.

FIGURE 7-5 HAYS-REPUBLIC PNEUMATIC MANUAL/AUTO STATION

7.1.2 Air/Fuel Ratio Relay

Function

The air/fuel ratio relay is a manual/auto control station that provides an output signal which is proportional to the input signal in the automatic mode.

Theory of Operation

o Pneumatic Systems

A typical ratio relay station uses a "seesaw" type beam arrangement to balance the output signal against the input signal. The input pressure acts through a diaphragm to rotate the beam in one direction, while the output pressure acts through a diaphragm to rotate the beam in the opposite direction. The beam is connected to the output pressure regulator valve such that movement of the beam causes either an increase or decrease in the output signal. Air for the output signal is furnished by a constant pressure air supply to the regulator from the instrument air system.

The ratio relay station may be operated in either the automatic or manual mode. In the automatic mode of operation, the output signal is always directly proportional to the input signal. However, the ratio of output to input pressure may be varied by a manual adjustment which changes the location of the fulcrum under the balance beam.

In the manual mode of operation, the output signal is totally independent of the input signal. The input pressure signal is blocked by means of a multiport valve, and the output signal is controlled by the same manual adjustment which is used to vary the output pressure ratio during automatic operation. In effect, a constant pressure signal is substituted for the input pressure signals, and the operative of the device is otherwise the same as for automatic operation.

As with standard manual/auto control station, the ratio relay station must be capable of "bumpless" transfer. This is accomplished in essentially the same manner as was described for the manual/auto station. (See Section 7.1.1)

o Electric Systems

The electronic air/fuel ratio relay functions in the same manner as the pneumatic unit, except that electronic circuitry is used in lieu of mechanical components. In the automatic mode, the output current signal varies from the input signal by fixed ratio which is determined by the plant operator. In the manual mode of operation (if available) the input signal is blocked and an output signal is generated by the relay unit. With some systems, a pure manual function is not provided. However, the output signal can be varied at any time by the plant operator by regulating the bias adjustment.

Hays-Republic model 845:01B fuel-air ratio controller

- FAST, EFFICIENT ELECTRICAL CONTROL ●
- MANUAL/AUTOMATIC CONTROL STATION ● LOW LOAD RATIO ADJUSTMENT ●

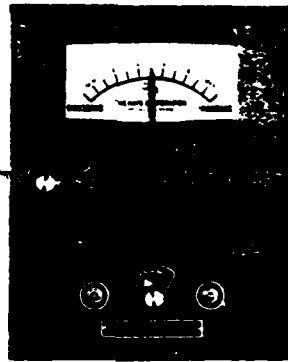

APPLICATION This type of controller has several uses such as: Maintaining (1) a ratio of combustion air flow to flow of fuel, (2) a proportioned flow of two gases, and (3) an established differential of two pressures, two drafts, a pressure and a draft, or one flow and either a pressure or a draft.

OPERATION Figure 1 illustrates use of the controller in proportioning one flow to another, such as air flow to gas flow. The upper differential diaphragm unit is connected across a differential device (orifice, venturi, etc.) in a gas pipe or duct. The flow through this pipe is automatically or manually controlled by separate means and the differential produced is the loading force on the controller. The force is transmitted through linkage to the lower differential diaphragm which is connected across a differential installation in an air line. The air flow differential is thus balanced against the gas flow differential. When the air flow is not in correct proportion to gas flow, the diaphragm moves and connecting linkage causes the armature of

the pilot device to close the contact in one of the mercury switches. This energizes the power unit to increase or decrease the controlled air flow until the correct proportion of gas to air is established.

Model 845:04B is used to control forced draft fan speed.

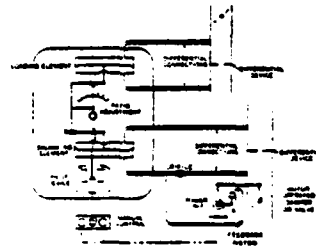

Figure 1

APPLICATION 895:02

The Model 895:02 Ratio Set Station is used to ratio one process variable to another process variable. The versatility of the ratio station allows it to be applied to many operations. In most applications the signal (1-5 ma d-c) from a transmitter is fed into the ratio station. This instrument reflects the desired ratio and bias into its output. The 895:02 is designed primarily, although not exclusively, for use with Hays Models 854 and 855 Universal Controllers.

A typical flow transmitter has a 1-5 ma d-c output representing 0-100% of the transmitter range. Assuming range of the transmitter to be 0 to 120 gpm, a 30 gpm flow will be represented by a 25% output signal from the transmitter. If the ratio is set at unity, the output of the 895:02 Ratio Set Station will be 25% or 2 ma d-c. However, if the ratio is set at two, the output will be 50% or 3 ma d-c.

Illustrated below are two typical applications of the Hays 895:02. In the first, for example, the ratio station is controlling the set point of a Model 855 controller. As the rate of flow of the process variable (PV₁) increases, the set point of the controller is readjusted so that the rate of flow of PV₂ increases in a proportion determined by the ratio dial setting.

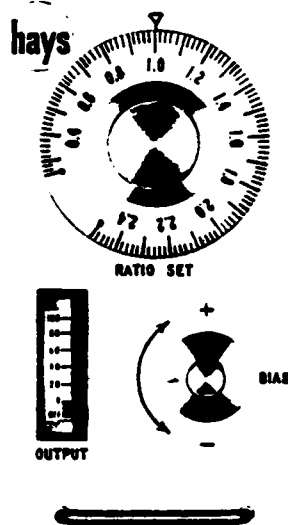

Model 895:02 Ratio Set Station, current output. Vertical scale indicator shows output of the Station in percent of total signal.

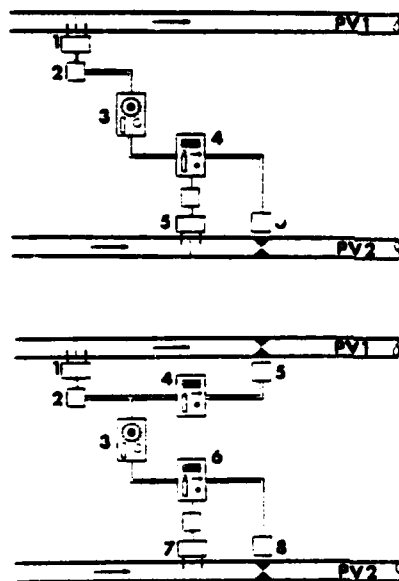

- 1 The model 252A TRANSMITTER senses a signal, (proportional to the rate of PV₁), through its
- 2 POWER SUPPLY * to the
- 3 895:02 RATIO STATION whose output is used as a set point to the
- 4 855 CONTROLLER.
- 5 The 252A TRANSMITTER measures the rate of flow and the controller in turn adjusts the
- 6 CONTROL VALVE to maintain the desired flow rate.

- 1 The model 252A TRANSMITTER senses a signal through its
- 2 POWER SUPPLY * to the
- 3 895:02 RATIO STATION and to a model
- 4 855 CONTROLLER which maintains a constant rate of flow of PV₁ by adjusting the
- 5 CONTROL VALVE.
- 6 A second model 855 CONTROLLER uses a model
- 7 252A TRANSMITTER and a
- 8 CONTROL VALVE to maintain the rate of PV₂ proportional to the signal fed from the ratio station into the cascade control of the controller.

* Power supply is usually panel mounted.

FIGURE 7-7 HAYS-REPUBLIC ELECTRONIC RATIO RELAY

RATIO CONTROLLER

Automatically maintains a preset ratio between two variables, such as fuel and air, measured in terms of pressures, drafts or differential pressures.

Features

- Maximum power at low pressures and drafts provided by large-area diaphragm. Bellows used for pressures above 75 inches H₂O.
- Convenient external knob and vertical scale establish operating ratio.
- Externally-visible gages show supply and control signal pressures.
- Sensitivity is adjustable with direct or reverse action setting.

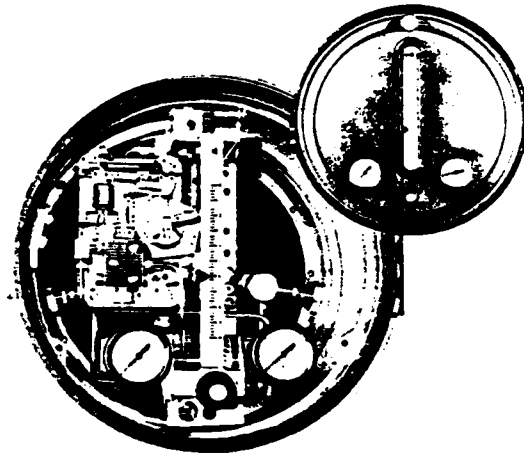

FIGURE 1 - Ratio Controller, TYPE AB41.

SPECIFICATIONS TABLE I

Input Pressure Range	See Table II
Output Signal Range	MODEL A: 3-27 psig. MODEL B: 3-15 psig.
Air Supply Requirements	MODEL A: 30 psig recommended; 35 psig maximum. MODEL B: 18 psig recommended; 20 psig maximum.
Air Consumption	0.4 cu. ft. per minute (average).
Sensitivity Adjustment	Range: 130 to 1, direct or reverse action.
Vertical Scale	Black figures and divisions on aluminum background; percentage scale with 10 at bottom and zero at top.
Recommended Piping	Pressure, draft, or differential pressure (diaphragm unit): 1/2 in. OD copper tubing or 1/2 in. steel pipe for up to 15 ft.; 3/4 in. OD copper tubing or 1/2 in. steel pipe for up to 100 ft. Pressure bellows unit: 1/2 in. OD copper tubing or 1/4 in. steel pipe. Control signal: 1/2 in. OD copper, aluminum, or plastic tubing.
External Connections	See Figure 3.
Mounting	Surface or panel (see Figure 3).
Weight	Net: 34 lbs., shipping: 50 lbs.
Construction	Enclosure: pressed steel Diaphragm: synthetic rubber or nylon. Bellows: for ranges up to 30 psig: brass. Bellows: for ranges above 30 psig: 302 stainless steel.
Enclosure Classification	General purpose.

STANDARD TYPES TABLE II

For ranges up to 75"H₂O, diaphragm mechanism can measure draft, pressure, or differential pressure; maximum static pressure: 10 psi. For ranges beyond 75"H₂O, bellows measures pressure only.

Rear Measuring Unit Range Limits		Front Measuring Unit Range Limits		TYPE
Lower	Upper	Lower	Upper	
0	10"H ₂ O	0	75"H ₂ O	AB4114A
		0	10 psig	AB4116A
		0	30 psig	AB4117A
		0	400 psig	AB4118A
0	30"H ₂ O	0	75"H ₂ O	AB4124A
		0	10 psig	AB4126A
		0	30 psig	AB4127A
		0	400 psig	AB4128A
0	50"H ₂ O	0	400 psig	AB4138A
0	30 psig	0	75"H ₂ O	AB4174A
		0	10 psig	AB4176A
		0	30 psig	AB4177A
		0	400 psig	AB4178A
0	400 psig	0	400 psig	AB4188A

© Bailey Meter Company, 1968

FIGURE 7-8 BAILEY PNEUMATIC RATIO RELAY

BAILEY 7000 RATIO STATION Type 715

Function

The Type 715 Ratio Station is used to multiply an input signal by a manually adjusted factor to produce an output signal that is at the set ratio to the input.

The output of the station can be used to adjust the cascade set point of a controller, maintaining a desired ratio between two process variables.

Application

In ratio control, Figure 2, of a controlled variable (flow A) to an uncontrolled variable (flow B) the measurement signal from flow B is applied to the input of the ratio station.

The ratio station multiplies this signal by an adjustable factor, preset on the set point scale, and transmits the output as a set point (cascade input) signal to the flow controller.

The flow controller continuously regulates flow A in proportion to flow B at the ratio setting. The signals of both flows in the example have a squared relationship to flow rate.

If one was squared, i.e., (differential pressure) and the other linear (magnetic flow meter), it would be necessary to linearize the squared signal with a Type 750 Square Root Extractor.

For applications where it is desirable to have the station output biased so that the output will be above the minimum (1 volt or 4ma) even though the input is reduced to the minimum value of its range, the ratio station has a circuit board adjustment that makes it easy to bias the output so it never falls below some desired value (0-50%) of output span even though the station input falls to zero percent.

Operation

The input meter indicates the input in percent before ratiomg. The signal then goes to the set point slidewire and gain amplifier which subtracts the 1-volt live zero and multiplies the remaining signal by the factor set on the set point scale. An output bias is added to the ratioed signal, available at the station output as a 1.5 volt and/or 4-20ma signal.

Features

- Input and output meters for visual comparison of ratio.
- High accuracy ratio set point on a 2-inch scale.
- Adjustable output bias.
- Both 4-20ma and 1.5v output.
- Wide or narrow ratio spans, linear or square root
- Input-output test jacks.
- DC to DC power supply isolation.

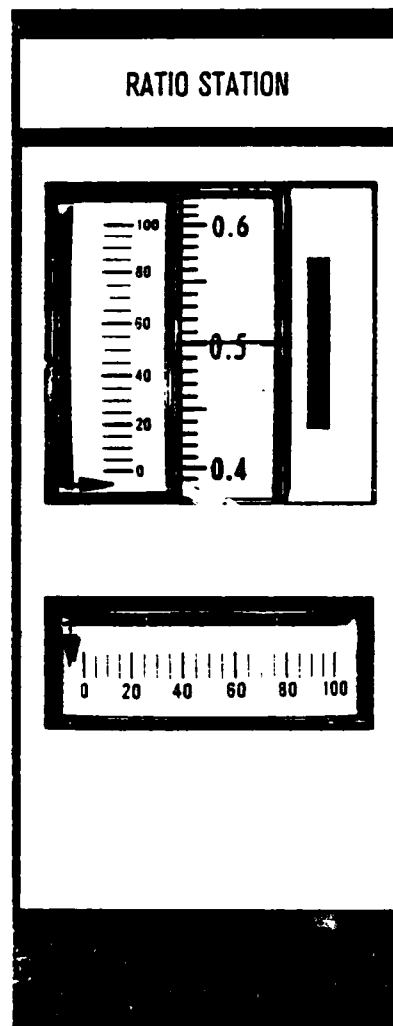

FULL SIZE

FIGURE 1 - Type 715 Ratio Station.

Optional Features

- Indicating lights - operated from external contacts.
- 1-Hertz filter - for exceptionally noisy processes.

© Bailey Meter Company 1974

FIGURE 7-9 BAILEY ELECTRONIC RATIO RELAY

7.1.3 Master Pressure Controller

Function

The master pressure controller compares the steam header pressure with the desired set point and produces an output signal which is a function of the deviation (error) between the header pressure and the set point.

Theory of Operation

o Pneumatic Systems

The master pressure controller uses a lever and fulcrum arrangement to balance output signal pressure against steam header pressure. (If a pressure transmitter is included in the control system, the input to the master pressure controller will be a pneumatic signal. Some units can utilize steam header pressure directly as the input signal.) The steam header pressure acts, through a sealed bellows, to rotate the lever in one direction, while the output pressure acts through a bellows to rotate the lever in the opposite direction. The lever is connected to the output pressure regulator which in turn controls the output pressure signal. Therefore, displacement of the lever causes either an increase or decrease in the output pressure signal which tends to restore the lever back to its original position. Air for the output pressure signal is furnished by a constant pressure air supply to the controller from the instrument air system.

o Electronic Systems

A typical electronic master pressure controller utilizes a magnetic amplifier which sums the various input signals and determines the magnitude of the error signal. This error signal is then amplified and transmitted as an output signal.

A feedback loop is provided from the controller output back to the input. The purpose of this feedback loop is to adjust the output signal so that the most desirable response to a given error signal will result. The feedback loop typically contains proportional, reset (integral), and rate (derivative) functions. The proportional function provides an output that is directly proportional to the magnitude of the error signal; the reset function provides an output that is proportional to the integral of the error signal; and the rate function provides an output that is proportional to the rate of change of the error signal. By summing the input signal and the various feedback function signals and comparing them to the set point, the master pressure controller produces an output signal that tends to return the steam pressure to the desired set point with a minimum of pressure swings.

AD-A124 868

BOILER CONTROL SYSTEMS THEORY OF OPERATION MANUAL (U)
ULTRASYSTEMS INC IRVINE CA FEB 83 NCEL-CR-83. 813
N62474-81-C-9388

2/2

UNCLASSIFIED

. F/G 13/1 NL

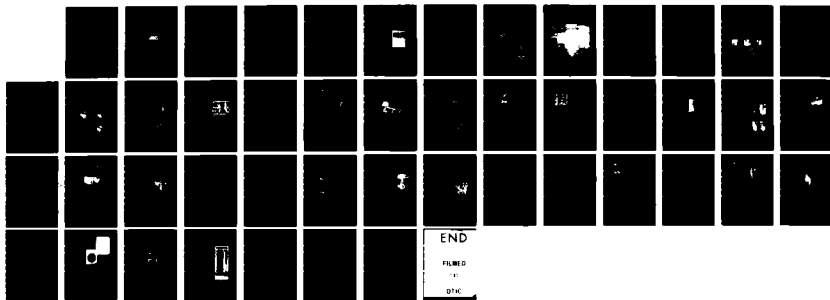

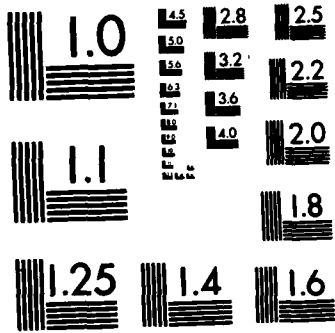

MICROCOPY RESOLUTION TEST CHART
NATIONAL BUREAU OF STANDARDS-1963-A

Hays-Republic model 841:02B master pressure controller

- MANUAL/AUTOMATIC CONTROL STATION • FAST, EFFICIENT ELECTRICAL CONTROL •
- ADJUSTABLE SET POINT • METALLIC BELLOWS MEASURING ELEMENT •
- FOR PRESSURES TO 300 PSIG •

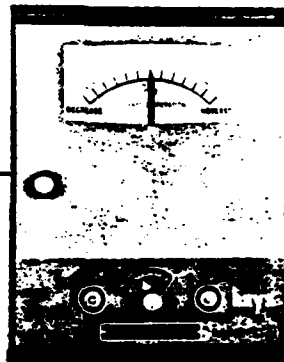

APPLICATION Model 841:02B Master Controller is a primary controlling unit of the Hays Electric Combustion Control System. It responds to change in steam pressure and adjusts the rate of fuel or air supply accordingly in order to maintain uniform steam pressure. It maintains a uniform pressure over the entire range of boiler operation. This controller is used with pressures to and including 300 psi.

OPERATION Model 841:02B controller directly regulates the rate of fuel and air supply through an integrally mounted master motor. This power unit is connected through linkage to the fuel and air controllers. This power unit can also adjust sending potentiometers for remotely mounted controllers. See Figure 1.

A change in the steam header pressure (due to an increase or decrease in steam flow) acts on the metallic bellows causing contact to be made in one of the mercury switches. This energizes the master motor which loads other controllers through linkage or sending potentiometers. Fuel and Air Controllers then change the fuel flow and air flow to bring the steam pressure back to the set point.

The follow-up linkage shown is connected to the master motor on the rear of the controller by means of a shaft. This shaft extends to the inside of the case and is connected to the magnet bar. Movement of the lever breaks the contact in the mercury switch, stopping the power unit. No further change takes place until the steam header pressure again varies.

One Master Controller of this type and one power unit can control the rate of fuel and air to several steam generators providing they all deliver steam to the same header.

FIGURE 7-10 HAYS-REPUBLIC PNEUMATIC MASTER PRESSURE CONTROLLER

7.2 Feedwater Controls

7.2.1 Feedwater Controller (Electric and Pneumatic)

Function

The feedwater controller regulates water flow to the steam drum in accordance with (1) drum level, or, (2) drum level and steam flow or pressure requirements.

Theory of Operation

o Single-Element Controller

The single element feedwater controller has only one process variable input signal, which is drum level. This signal may be provided by a level transmitter, or if the controller is so equipped, from a level sensing device integral to the controller. The controller then transmits an output signal which is proportional to the deviation of the input signal from the set point valve.

The controller may either electronic or pneumatic. The pneumatic controllers operate in similar fashion to a pneumatic master pressure controllers. The input signal is mechanically balanced against a beam and/or spring mechanism. The force opposing the input signal is provided by the existing output signal and the set point spring selected by the operator. When the input signal force overcomes the set point force, the resulting displacement of the beam or diaphragm causes an output signal pressure control valve to open and increase the output pressure signal. If the input signal is less than the set point, then the resulting displacement opens a vent valve which bleeds air from the output signal piping.

Electronic feedwater controllers operate in a similar fashion to pneumatic controllers except that electronic signals and circuitry are used to compare the input signal to the set point signal, and an output signal is generated which is proportional to the deviation.

o Two-Element Controller

The two element controller uses two process variable input signals to produce the desired output signal. One input signal is provided from a steam flow transmitter and the other from a drum level transmitter. The controller compares the steam flow rate signal with the existing output signal (to the feedwater control valve) and continuously drives the feedwater valve to a position that is directly proportional to steam flow. At the same time, the controller compares the drum level input signal with the set point value and produces an output signal proportional to the deviation. This output signal is used to adjust the output signal to the feedwater control valve.

Two-element controllers may be either pneumatic or electronic. The principles which govern their operation are very similar to the principles governing single-element controllers.

o Three-Element Controller

Three-element feedwater controllers use three process variable input signals to produce the desired output signal. Functionally they are the same as two-element controllers, except that a feedback signal from feedwater flow transmitter is included with drum level and steam flow input signals. The drum level and steam flow inputs are used in

the same fashion as with a two-element controller to produce an output signal to the feedwater control valve. The feedwater flow signal provides metered control of the feedwater valve so that the flow will match the value determined by the drum level and steam flow inputs.

Although three-element controllers provide precise control of feedwater flow, they are seldom used on small industrial boilers unless severe operating conditions exist. For most applications, the additional cost and complexity cannot be justified.

Hays-Republic

model C-00856

feedwater controller systems

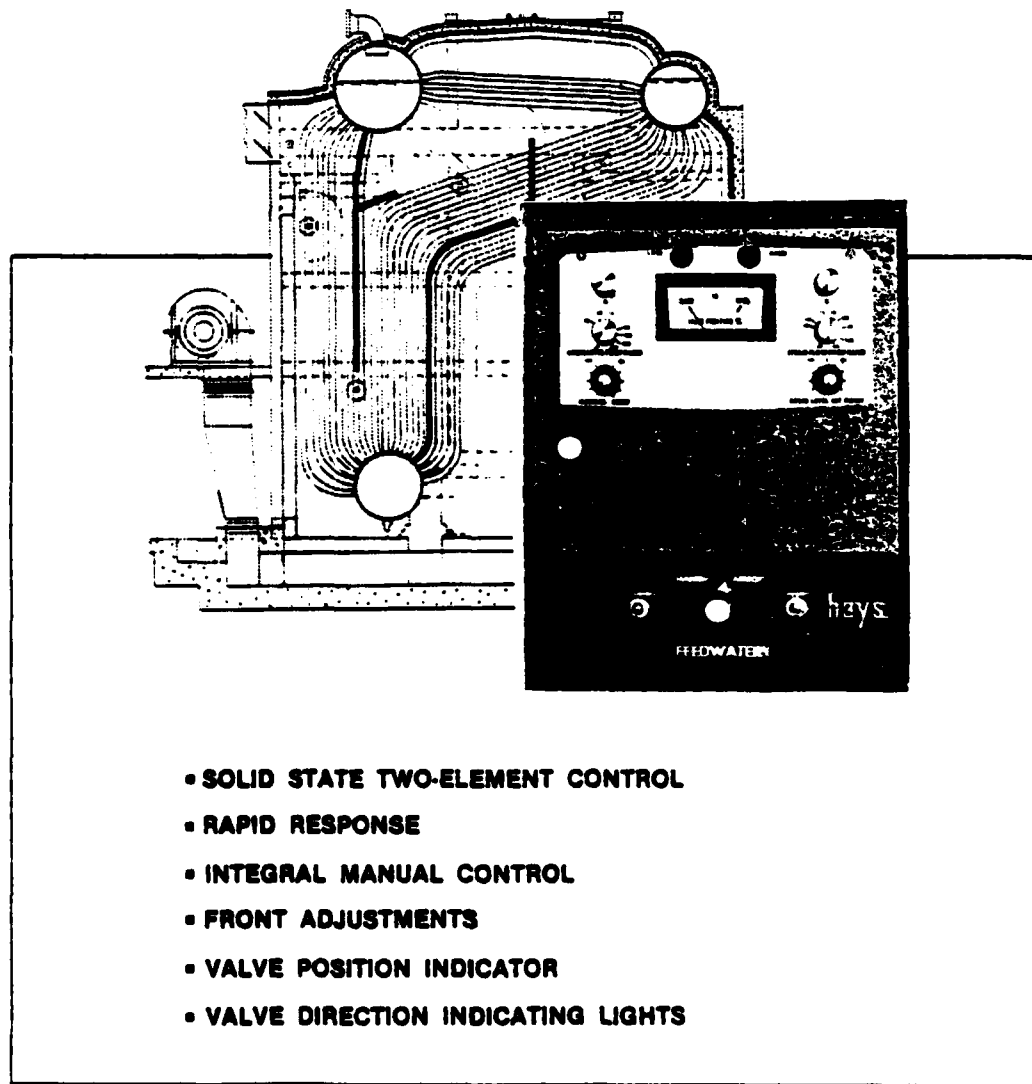

FIGURE 7-11 HAYS-REPUBLIC ELECTRONIC FEEDWATER CONTROLLER

7.2.2 Mechanical Feedwater Regulator

Function

The function of a mechanical feedwater regulator is to automatically control the flow of feedwater into the boiler drum in order to maintain the appropriate drum water level.

Theory of Operation

Numerous types of mechanical feedwater regulators are available. Two of the most common are the thermostatic expansion tube type and the thermo-hydraulic type. The thermo-hydraulic type uses the expansion of a liquid in an enclosed space to position the feedwater valve. The amount of expansion which takes place is dependent upon the drum level. The expansion tube type uses the expansion and contraction of a metal tube filled drum water to position the feedwater valve via a mechanical linkage. The operational theory of each of these devices is discussed in detail in Section 5.5.

THERMO-HYDRAULIC FEEDWATER REGULATOR

Provides a simple and effective means of controlling boiler feedwater. For boilers operating at rates of steam liberation under 1500 cu. ft. per hr. per sq. ft. of liberating area at the water level in the drum. For higher rates of evaporation, consult Sales Department, Bailey Meter Company, for specific feedwater control recommendations.

Features

- Only two boiler connections required. Generator mounts with standard screwed or flanged connections.
- No connecting linkage needed. Flexible copper tubing is only connection between generator and regulating valve, so regulating valve can be remotely mounted. No structural or piping changes necessary.

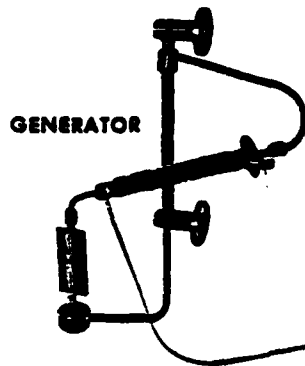

FIGURE 1 — Thermo-Hydraulic Feedwater Regulator, TYPE VBH11.
Pressure tight, all-metal system contains water for operation, needs no external power.

- Easily operated, positive bypass standard. Regulating valve includes bypass lever as standard equipment.
- Balanced valve trim minimizes friction and vibration. Forces of the incoming feedwater tend to balance themselves against the two discs.
- Uniform flow control assured. Straight-line flow characteristic of valve assures uniform flow control over entire operating range.
- No piping changes required. Regulating valve can be installed above or below boiler water level in horizontal or vertical feedline. Standard flanged and screwed connections available.
- Servicing simplified. Valve trim can be removed without removing valve body from line or topwork from valve.

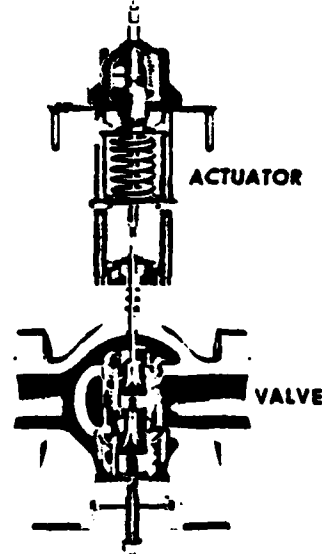

FIGURE 7-12 BAILEY THERMO-HYDRAULIC FEEDWATER REGULATOR

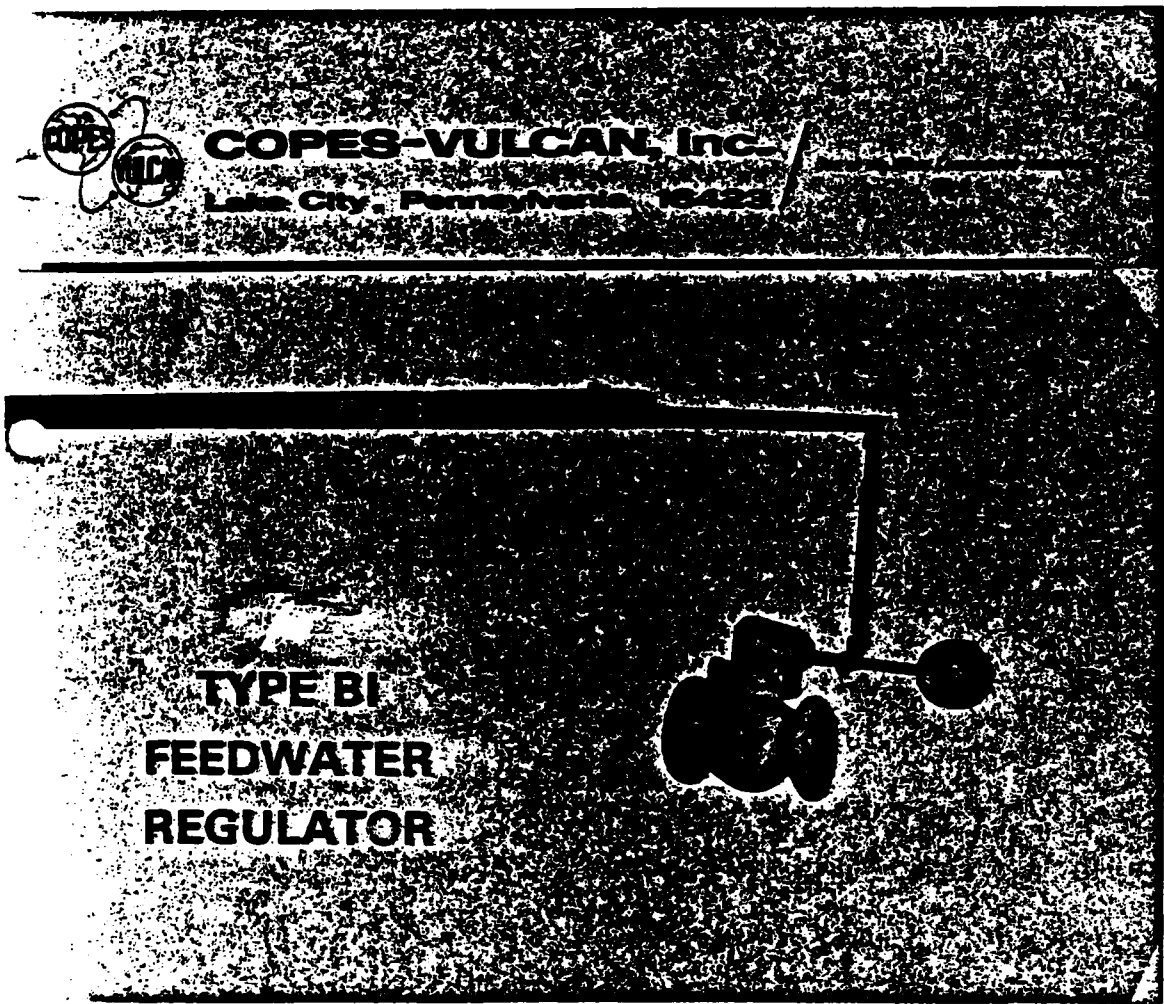

FIGURE 7-13 COPES-VULCAN THERMOSTATIC EXPANSION TUBE FEEDWATER REGULATOR

7.2.3 Drum Level Transmitter

Function

The function of the drum level transmitter is to measure the drum water level and transmit an output control signal which varies in accordance with the level.

Theory of Operation

Drum level transmitters are generally either the float type or the differential pressure type. Either type may be used to transmit a pneumatic signal or an electronic signal.

Float type level transmitters measure liquid level with a float mechanism that rests on the surface of the liquid in an enclosed chamber. This chamber is located along side the drum and has piping connections to the drum above and below the water level. The water level in the chamber therefore is the same as the water level in the drum.

The float is connected either to a pneumatic control valve mechanism or electronic signal amplifier which in turn generates the output signal. In either case, the displacement of the float determines the magnitude of the output signal.

Differential pressure type transmitters determine drum water level by the measuring difference in pressure between the steam in the space above the water surface and a reference point below the surface. Thus the higher the water level, the greater the differential

pressure. This differential pressure is used to create a linear displacement of a bellows (or other expanding chamber device) by increasing or decreasing the pressure inside the bellows with respect to the outside. This linear displacement is in turn converted into a pneumatic or electronic control signal in the same manner as the float type transmitter.

MINI-LINE* LEVEL TRANSMITTERS

Transmit measurements of liquid level in pressure vessels to indicating, recording, and/or controlling equipment at remote stations. Transmitter directly indicates level. Available for use in electric or pneumatic transmission or control systems.

APPLICATION

For the measurement of boiler drum level or liquid level in pressure vessels over standard range spans from 12 in. H₂O to 400 in. H₂O at maximum service pressures to 800, 1500, and 3500 psig. See Figures 1, 2, and 3. See Product Specification P31-6 for *MINI-LINE* Level Transmitters utilizing torque tube measuring mechanism, TYPE LD13.

FEATURES

Indicates Level at Point of Measurement. Provides a quick check of system performance and permits checking transmitting system without affecting measuring mechanism.

Decreases Installation Costs. Cuts installation costs by minimizing length of high pressure piping required.

Promotes Safety. Output signal is carried to control room in place of high pressure piping.

Simplifies Stocking of Spare Parts. Fewer spares required since components and parts are common to other Bailey equipment.

Calibration Unaffected by Case Mounting. Transmitter mechanism is securely attached to measuring mechanism. Case serves as enclosure only.

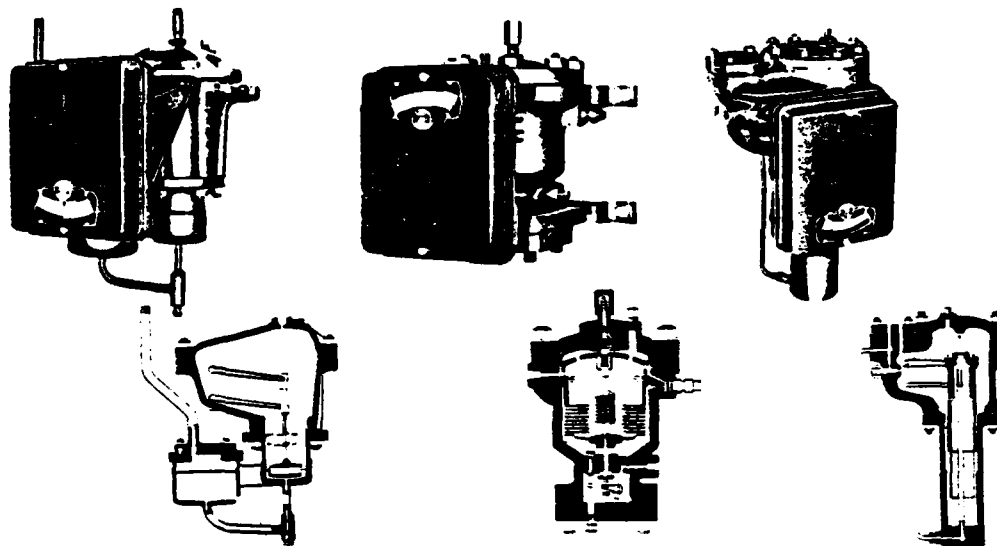

FIGURE 1—Mercury U-tube measuring mechanism for standard level range spans from 15 in. H₂O to 400 in. H₂O. *MINI-LINE* Level Transmitter: TYPE LU12 for electric transmission; TYPE LU13 for pneumatic transmission.

FIGURE 2—Bellows measuring mechanism for standard level range spans from 12 in. H₂O to 211 in. H₂O. *MINI-LINE* Level Transmitter: TYPE LR12 for electric transmission; TYPE LR13 for pneumatic transmission.

FIGURE 3—Mercury-sealed bell measuring mechanism for standard level range spans from 12 in. H₂O to 70 in. H₂O. *MINI-LINE* Level Transmitter: TYPE LH12 for electric transmission; TYPE LH13 for pneumatic transmission.

*Reg. U.S. Pat. Off.

7.2.4 Flow Transmitter

Function

A Flow transmitter measures steam or feedwater flow and transmit a control signal which varies with flow.

Theory of Operation

A variety of different flow measuring devices are available, but most of those furnished with small industrial boiler systems are the differential pressure type. These transmitters measure the pressure drop of the flowing fluid across an orifice, flow nozzle, or other such restriction-type flow element in the fluid pipe line. The difference in pressure upstream and downstream of the flow element is then used to create a linear displacement of a bellows, bourdon tube, or other similar device. The bellows or bourdon tube is connected to a pneumatic control valve mechanism or to an electronic signal amplifier which produces an output signal based on displacement.

One of the drawbacks of differential pressure type flow transmitters is that the output signal varies linearly with the differential pressure and not with flow. This is inherent in the design of the device, since pressure drop through an orifice varies as the square of the flow. (Conversely, the flow varies as the square root of the pressure drop.) Therefore, it is often necessary to add an additional control component known as a "square root extractor" to

the system. This device produces an output signal which has a magnitude equal to the square root of the input. The output signal from the square root extractor thus varies linearly with the measured fluid flow.

MINI-LINE* FLOW TRANSMITTERS

Transmit rate of flow measurements to indicating, recording, integrating, and/or controlling equipment at remote locations. Transmitter directly indicates rate of flow on a uniformly-graduated scale. Available for use in electric or pneumatic transmission or control systems.

APPLICATION

For rate of flow measurements of steam, water and other liquids, air, and gases which produce standard differentials across primary elements from 0-2 in. H₂O to 0-212 in. H₂O at maximum service pressures to 50, 300, 800, 3500, and 6000 psig. See Figures 1, 2, 3, and 4.

FEATURES

Indicates Flow at Point of Measurement. Provides a quick check of system performance and permits checking transmitting system without affecting measuring mechanism.

Transmits a Signal Directly Proportional to Rate of Flow. Uses receiver with uniformly-graduated chart or scale. Eliminates the need for square root extractors or characterizers.

Decreases Installation Costs. Cuts installation costs by minimizing length of high pressure piping required.

Promotes Safety. Output signal is carried to control room in place of high pressure piping.

Simplifies Stocking of Spare Parts. Fewer spares required since component parts are common to other Bailey equipment.

Calibration Unaffected by Case Mounting. Transmitter mechanism is securely attached to measuring mechanism. Case serves as enclosure only.

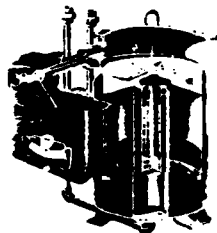

FIGURE 1—Large oil-sealed bell with parabolic displacer measuring mechanism for standard ranges of 0-2 in. H₂O or 0-4 in. H₂O. Used for measurement of air or gas flow. Bailey *MINI-LINE* Flow Transmitters: TYPE CG12 for electric transmission; TYPE CG13 for pneumatic transmission.

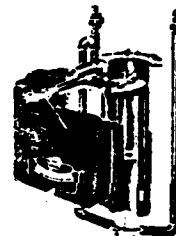

FIGURE 2—Oil-sealed bell with parabolic displacer measuring mechanism for standard range of 0-8 in. H₂O. Used for measurement of air or gas flow. Bailey *MINI-LINE* Flow Transmitters: TYPE CA12 for electric transmission; TYPE CA13 for pneumatic transmission.



FIGURE 3—Mercury-sealed bell with parabolic displacer measuring mechanism for standard ranges of 0-13.25 in. H₂O for steam and liquids and 0-14.3 in. H₂O for gases. Bailey *MINI-LINE* Flow Transmitters: TYPE CH12 for electric transmission; TYPE CH13 for pneumatic transmission.

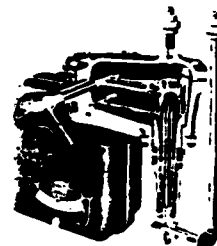

FIGURE 4—Ledoux bell measuring mechanism for standard ranges from 0-53 in. H₂O to 0-212 in. H₂O. Used for measurement of gas, steam, or liquid flow. Bailey *MINI-LINE* Flow Transmitters: TYPE CC12 for electric transmission; TYPE CC13 for pneumatic transmission.

* Reg. U.S. Pat. Off.

FLOW TRANSMITTER Pneumatic Square Root Extractor

Extracts the square root of differential pressure measurements to produce a pneumatic signal proportional to rate of flow; transmits to indicating, recording, integrating, and or controlling equipment at remote stations.

Application

For the measurement and transmission of rate of flow of liquids and gases producing standard differential pressure ranges from 0-50 to 0-1200 in. H₂O under service pressures to 6000 psig.

Features

- **FLEXIBLE IN APPLICATION.** Wide choice of differential pressure ranges from 0-50 to 0-1200 in. H₂O.
- **HIGH SENSITIVITY AND LARGE CAPACITY.** Sensitive vane, nozzle, and booster assembly provide response and capacity necessary for fast, accurate transmission.
- **FULL CONTROL RANGEABILITY.** By extracting the square root function, the Bailey Flow Transmitter gives full control rangeability to differential pressure measuring instruments.
- **FLOW INDICATION AT TRANSMITTER.** Quick check of transmitter performance provided by indication at point of transmission of pneumatic signal corresponding to rate of flow.
- **SIMPLIFIES STOCKING OF SPARE PARTS.** Fewer spare parts required since component parts are common to other Bailey Transmitters.

Quotation/Ordering Information

For a quotation and shipping date or to place an order, please supply the following data:

TYPE: _____ (see Table II)
 or Application: _____
 Range: _____ "H₂O
 Service Pressure: _____ psig
 MODEL: B (3-15 psig Transmitter Range);
 A (3-27 psig Transmitter Range).

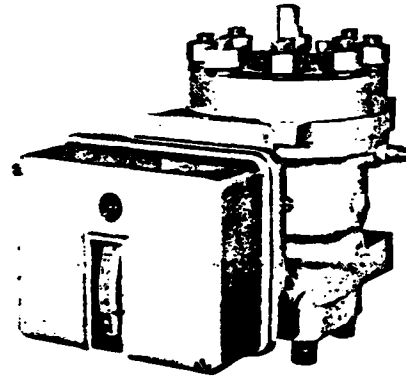

FIGURE 1—Bellows flow transmitter for 1500 and 3500 psig service pressures, TYPE CR16□□A. Used where quick response is required and where no mercury is permitted.

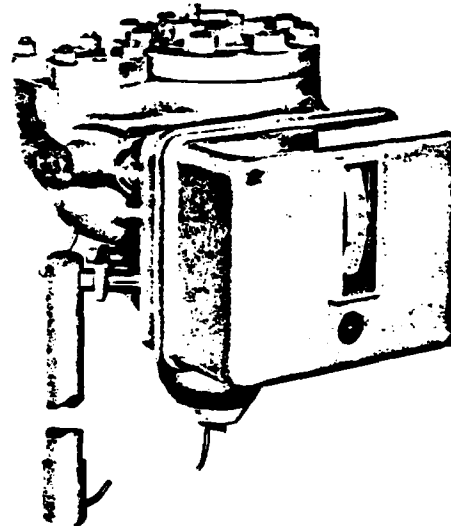

FIGURE 2—Mercury U-Tube flow transmitter for 800, 3500, and 6000 psig service pressures, TYPE CU16□□A. Used on applications where there are pulsations in pressure (inertia of the mercury dampens surges in pressure).

SQUARE ROOT CONVERTER

Extracts the square root of nonlinear pneumatic signals from flow differential pressure transmitters; produces a pneumatic signal directly proportional to rate of flow.

Application

For converting nonlinear pneumatic flow signals to linear pneumatic output signals for indicating, recording, and/or control purposes.

Features

- **ADDS CONTROL RANGEABILITY.** By extracting square root function, the Bailey Square Root Converter gives full control rangeability to differential pressure transmitters.
- **PROVIDES FLOW INDICATION.** Quick check of transmitter performance provided by indication of pneumatic output signal corresponding to rate of flow.
- **FLEXIBLE APPLICATION.** Receives pneumatic signals over 3-15 or 3-27 psig ranges; transmits pneumatic signals over 3-15 or 3-27 psig. Any combination permissible.
- **HIGH SENSITIVITY AND LARGE CAPACITY.** Sensitive vane, nozzle, and booster assembly provides response and capacity necessary for fast, accurate transmission.

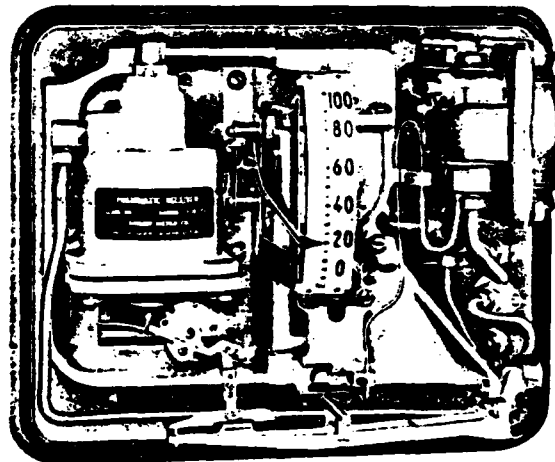

FIGURE 1—The Bailey Square Root Converter, TYPE KC1610A.

SPECIFICATIONS

TABLE I

Accuracy*	Transmitted signal is factory calibrated to be accurate within 1/2% of signal span between 20% and 100% of flow.
Transmitting Distance	Approximately 1000 feet to indicators and recorders; 400 feet to controllers; limitations depend on required system response.
Air Supply	18 psig for 3-15 psig transmitter range. 30 psig for 3-27 psig transmitter range.
Air Consumption	At balance on dead end service 0.10 scfm (18 psig supply) or 0.15 scfm (30 psig supply).
Pneumatic Capacity	With 18 psig or 30 psig supply and at balanced conditions, output capacity is 2.0 scfm when transmitted signal is decreased 1 psig.
External Connections	1/4 inch-27 NPT female.

Recommended Tubing	1/4 inch OD copper or aluminum of wall thickness 0.028 to 0.032 inches.
Indicating Scale	Uniformly graduated, 3 inch vertical scale; black figures, and divisions on aluminum background, calibrated from 0-100%; 10 major divisions, 20 minor divisions; range figures are 0, 20, 40, 60, 80, and 100; no scale legend. Pointer indicates per cent flow range.
Enclosure	Die-cast aluminum base with pressed steel cover; Pearlesk gray baked-enamel finish.
Mounting	Surface or panel with same mounting bracket.
Weight	Net — 15 lb; Shipping — 25 lb.

*As defined by SAMA Standard PMC20.

© Bailey Meter Company 1956

FIGURE 7-17 BAILEY PNEUMATIC SQUARE ROOT EXTRACTOR

7.3 Flame Safety Systems

7.3.1 Flame Scanner

Function

The function of a flame scanner is to determine if a burner or igniter flame is present.

Theory of Operation

Flame scanners are available which detect either infrared or ultraviolet radiation, but the ultraviolet (UV) detectors are by far the most common. UV scanners generally use a silicon detector which is sensitive to the ultraviolet light which is given off during the combustion process. Infrared or "flicker" scanners measure the fluctuations that occur in infrared radiation during the normal combustion process to determine if a flame is present.

Most flame scanners are equipped with a self-checking feature which verifies they are operating properly. A shutter is usually provided which temporarily blocks the scanner's view of the furnace. If a "flame-off" signal is not received during this period, the scanner is determined to be defective.



INSTRUCTIONS

Minneapolis - Honeywell Regulator Company

MINNEAPOLIS 6, MINNESOTA • TORONTO 17, ONTARIO

C7012A
ULTRA-VISION*
FLAME DETECTOR

GENERAL DESCRIPTION

The C7012A is an ultraviolet-sensitive flame detector designed for use with rectification-type flame safeguards.

FEATURES

ALL-FLAME, ALL-BURNER APPLICATION

The C7012A detects the ultraviolet radiation that is present in all flames. It even detects electric sparks. Consequently, it can be used to supervise gas-fired, oil-fired, or combination (gas-oil) industrial burners.

ULTRAVIOLET SENSITIVE ONLY

The C7012A detects only ultraviolet radiation. It is not actuated by the radiation of a hot refractory.

RAPID FLAME RESPONSE

The flame response time of the C7012A is less than 0.1 of a second. The system response time depends on the flame safeguard relay with which the C7012A is used.

INTEGRAL HEAT BLOCK

Heat block is built into the mounting adaptor for high temperature applications. No extra installation or ordering of parts is needed.

INTEGRAL SEAL OFF

Seal off is also built into the adaptor to keep high temperature gases from the detector.

EASY MOUNTING AND REMOVAL

Combination adaptor permits simple, easy removal of the detector. In addition, the case can be rotated 360° on the adaptor.

SPECIFICATIONS

MODEL: C7012A Ultra-Vision Flame Detector.

ELECTRICAL RATINGS: 120, 208, or 240 volts; 50/60 cycles.

APPROVAL BODIES: The C7012A is approved by FM (Factory Mutual) and listed by UL (Underwriters Laboratories).

MOUNTING MEANS: Combination Seal-off and heat-block adaptor threaded to fit 3/4" pipe.

*Trademark
February 25, 1969
Supersedes earlier issue
J. B.

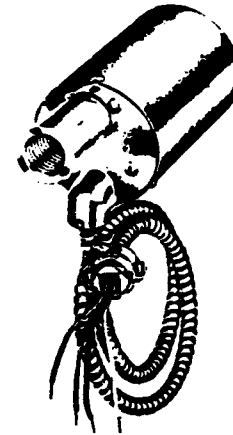

DUST-TIGHT, ANODIZED ALUMINUM COVER

Cover keeps parts clean and is resistant to most industrial atmospheres.

COVER INTERLOCK SWITCH

Switch turns off power to the detector when the cover is removed, making the detector inoperative.

LEADWIRE CONNECTIONS

A four-foot length of armored cable is factory installed. If necessary, additional length can be added.

HIGHLY ADAPTABLE

This detector requires no unusual installation procedures. The C7012A can be readily substituted for the flame detector in existing rectification-type systems. It can also be used in conjunction with a rectification-type flame safeguard to convert a flame flicker system.

MAXIMUM POWER CONSUMPTION: 10 watts.

CONNECTION MEANS: Four-foot length of four-wire armored cable complete with connector.

TEMPERATURE RATINGS:

Air surrounding case (ambient), 50F to 135F.

USE WITH: RA190, R478A, R485A, RA890C, R7023, or W124; 2 to 4 second flame response models only.

Order This Sheet
By Part Number 95-2776

FIGURE 7-18 HONEYWELL UV FLAME DETECTOR

FLAMON® Flame Detector, Type UF (Flicker or Flicker and Ultraviolet Sensor)

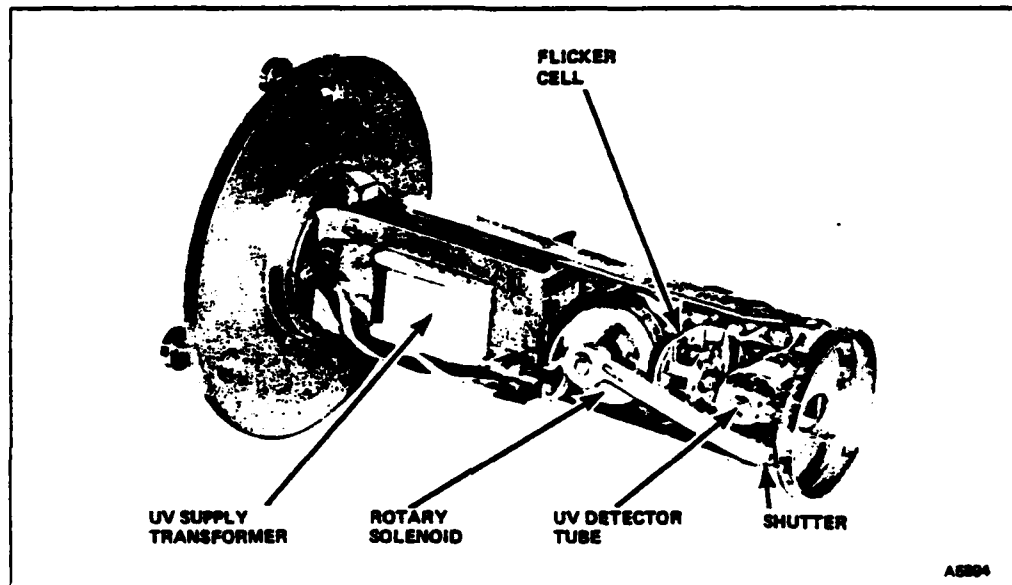

FIGURE 1 - FLAMON sensor. Flicker or combination Ultraviolet (UV) and Flicker designs are available.

Monitors fuel-burning equipment and provides alarm, indication, and/or control of the fuel when used with auxiliary equipment.

FEATURES

- Responds only to the flame under surveillance when properly installed.
- LED indicates flame status.
- To maximize life, electronic circuitry is contained in the Receiver module(s) mounted remote from the burner area (Figure 2).
- Test jacks accessible on module face.
- A shutter for self-checking of the Flame Detector is available as an option on UF4, standard on UF5.
- Only low voltage is transmitted to the burner front (25 V ac and 40 V dc maximum).
- Reflector tube and vane permit flame sighting angles up to 40° from the mounting axis.

FLAMON* Detector
Type UF11□□ Series 15

Detects the presence of a flame and signals its presence by changing the internal relay contact status.

APPLICATION

Monitors fuel burning equipment using gas, oil, or cyclone coal firing. Provides services for alarm, indication, and/or control of the fuel when used in conjunction with the necessary auxiliaries. Used only as an alarm device unless combined with Bailey Burner Management System.

FEATURES

- **Reliable detection:** designed to respond only to flame under surveillance, not to adjacent flames or infrared radiation from glowing refractories when properly installed.
- **Ease of maintenance** accomplished by quick disconnect flange mounting.
- **Simplified field installation and wiring** provided by terminal block within detector.
- **High reliability and minimum maintenance** assured by simple passive circuitry.

AVAILABLE TYPES

TABLE I

STANDARD TYPES			
Flame Detector	Extension Head Length	Approximate Weight - lb (kg)	
		Net	Shipping
UF1100	Basic 4-13/16" (122 mm)	9.5 (4.3)	13 (5.9)
UF1101	12" (305 mm)	13.5 (6.1)	17 (7.7)
OPTIONAL TYPES†			
UF1110	Basic 4-13/16" (122 mm)	9.5 (4.3)	13 (5.9)
UF1111	12" (305 mm)	13.5 (6.1)	17 (7.7)
UF11*2	18" (457 mm)	18.5 (7.0)	19 (8.6)
UF11*3	24" (610 mm)	17.5 (7.9)	21 (9.5)
UF11*9	60" (1524 mm)	29.5 (13.4)	33 (15.0)

†Requires 2-6 weeks extra for delivery for necessary modification and assembly.
*Add "0" (60 Hz) or "1" (50 Hz) to designate electrical supply.

*Reg. U.S. Pat. Office
Form CE66-2E Litho in U.S.A. 780

© Bailey Controls Company 1980

Bailey Controls Company
Babcock & Wilcox, a McDermott Company

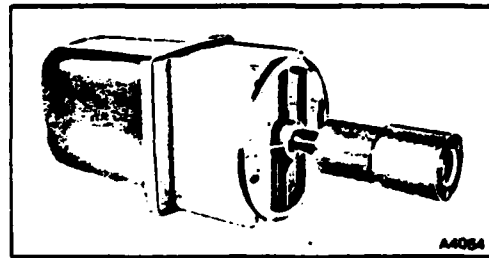

FIGURE 1 - Basic FLAMON Detector for monitoring fuel burning equipment.

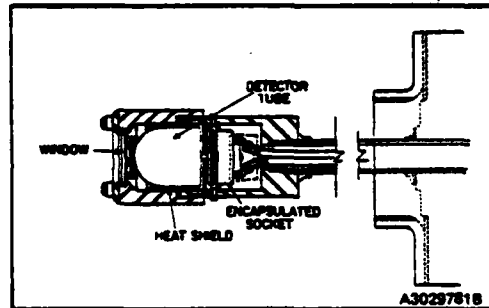

FIGURE 2 - Diagram of rigid extension head adapter.

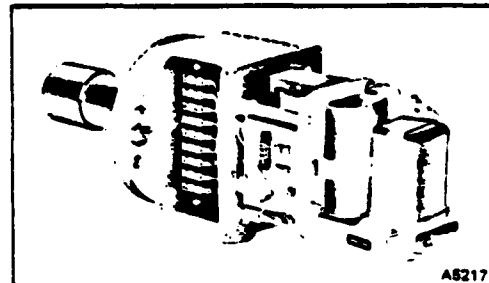
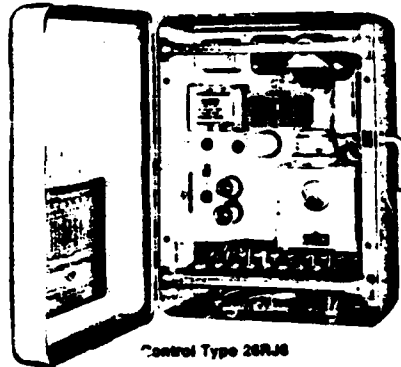
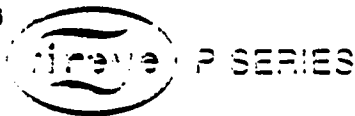

FIGURE 3 - FLAMON Detector, Type UF11□□. Covers removed to show integral terminal block, and circuit components.



Control Type 26RJ8

FP-2 SYSTEM

Flame Safeguard and programming controls for AUTOMATIC Industrial sizes of oil, gas or combination fuel burners, using INFRARED flame detection.

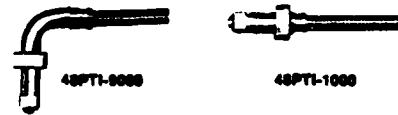

Infrared Scanners

DESCRIPTION:

Fireye Systems FP-2 consist of a Type 26RJ8 Programming Control and a Type 48PTI Scanner which uses the "Firetron" cell to visually supervise both oil and gas flames. In conjunction with operating, limit and interlock devices, they automatically program each starting, operating, and shutdown period, providing ignition and flame failure protection for industrial and commercial oil, gas or combination oil/gas burners.

FP-2 systems incorporate a safety checking circuit that is effective on every start. Any condition which will cause the flame relay to hold in during the checking period will stop the program before any ignition circuits are energized and if sustained, will result in safety lockout; except MODEL 6080 which will go to safety shutdown if flame relay is momentarily energized.

The Type 26RJ8 Control programs the operation of blower and/or burner motor, ignition system, fuel valve, and modulator system in a proper sequence which includes suitable purge periods

before ignition and after burner shutdown, returning them to the starting position prior to lightoff and to automatic control after the main flame is established and proven. Also featured is a selectable trial for ignition of the main flame which is restricted to a safe short interval. An interlock circuit is provided for air flow switches, fuel pressure switches, etc.

Additionally, the control is designed to de-energize all fuel valves within a short safe interval following flame failure. The control recycles each time the operating or limit control closes, or after a power failure, but locks out and must be reset manually following flame failure. An alarm circuit actuates audible or visual alarms following a safety lockout.

Additional features available on specific models include proof of fuel valve closure, proof of open damper during purge, non-recycling limit and air flow interlocks and spark cut-off prior to energizing the main fuel valve.

FP-2 SYSTEM MODEL LISTING

TYPE 26RJ8 MODEL	SUPPLY VOLTAGE	PRE-PURGE (SEC)	APPROVABLE SY	OPEN DAMPER INT'L K	NON-RECYCLE INT'L K	F.P.R.T (SEC)	T.P.I. PILOT (SEC)	T.P.I. MAIN (SEC)	SPK. CUTOFF	MODULATOR ACTION	REF. BULL.
6008	120, 208, 240	35	FM			1-4	10	15.66		LO-AUTO	CP58
6018	120, 208, 240	45	FM			1-4	10	16.30		LO-HI-LO - AUTO	CP51
6068	120	35	UL FM CSA			1-4	10	15.66		LO-AUTO	CP58
*6100	120	60	UL FM CSA			1-4	7	10-15	X	LO-HI-LO - AUTO	CP60
6070	120	60	UL FM CSA	X	X	1-4	7	15.30		LO-HI-LO - AUTO	CP59
*6080	120	46	FM CSA IIR	X	X	1-4	10	18, 15, 30		LO-HI-LO - AUTO	C30

*Has fuel valve interlock.

For further details see bulletin C-30.

FIGURE 7-21 FIREYE INFRARED DETECTOR SYSTEM

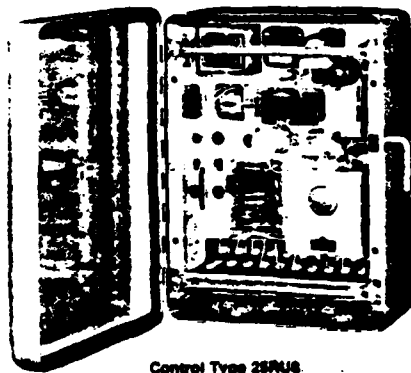

Control Type 25RU8
Model 5580

UVP-2 SYSTEM

Flame Safeguard and programming control for AUTOMATIC industrial sizes of oil, gas or combination fuel burners, using ULTRAVIOLET flame detection.

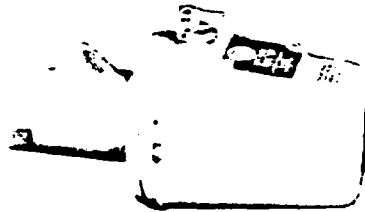

45UV2-1025
Ultraviolet Scanner



DESCRIPTION:

Fireeye System UVP-2 consists of a Type 25RU8 Programming Control and a Type 45UV2 Scanner which uses an ultra-violet detection tube to visually supervise both oil and gas flames. In conjunction with operating, limit and interlock devices, they automatically program each starting, operating, and shutdown period, providing ignition and flame failure protection for industrial and commercial oil, gas or combination oil/gas burners.

UVP-2 system incorporates a safety checking circuit that is effective on every start. Any condition which will cause the flame relay to hold in during the checking period will stop the program before any ignition circuits are energized and will result in safety shutdown.

The Type 25RU8 Control programs the operation of blower and/or burner motor, ignition system, fuel valve, and modulator system in a proper sequence which includes suitable purge periods before ignition and after burner shutdown, returning them to the starting position prior to lightoff and to

automatic control after the main flame is established. The UVP-2 System monitors both main and pilot flames and do not permit the main fuel valve to be energized unless pilot flame has been established and proven. Also featured is a selectable trial for ignition of the main flame which is restricted to a safe short interval. An interlock circuit is provided for air flow switches, fuel pressure switches, and spark cut-off prior to energizing the main fuel valve.

Additional features include proof of fuel valve closure, proof of open damper during purge, non-recycling limit and air flow interlocks.

Additionally, the control is designed to de-energize all fuel valves within a short safe interval following flame failure. The control recycles each time the operating or limit control closes, or after a power failure, but locks out and must be reset manually following flame failure. An alarm circuit actuates audible or visual alarms following a safety lockout.

UVP-2 SYSTEM MODEL LISTING

TYPE 25RU8 MODEL #	SUPPLY VOLTAGE	PRE-PURGE SEC.	APPROV. ABLE BY	OPEN DAMPER INT'LK	NON- RECYCLE INT'LK	PRE- PURGE SEC.	TRIAL PILOT SEC.	TRIAL MAIN SEC.	SPK CUTOFF	MODULATOR ACTION	REF BULL.
* 5580	120	45	UL FM CSA IRI	X	X	2-4	10	0-15.30	X	3-M-FLO-AUTO	C30

* HAS FUEL VALVE INTERLOCK

For further details see bulletin C-30.

FIGURE 7-22 FIREYE UV DETECTOR SYSTEM

7.4 Drive Mechanisms

7.4.1 Pneumatic Control Device

Function

The function of a pneumatic control drive is to position a damper or lever operated valve in response to an input control signal.

Theory of Operation

Pneumatic control drives normally use an air operated piston to provide the force necessary to drive the output lever. Compressed air from an external air supply is required since the pneumatic input signal is generally not used to drive the piston. A positioning system is provided which regulates the air supply to the piston in accordance with the input control signal. The positioner may be either pneumatically or electronically operated, depending upon the control system employed.

The drive piston may be either the spring-opposed type or air-opposed type. With spring-opposed pistons, the air pressure drives the piston in one direction, and a spring drives it back in the opposite direction when the air pressure is reduced. With the air-opposed type, compressed air is contained in both sides of the piston, and the proper placement is achieved by increasing or decreasing the air pressure on either side.

Hays-Republic

model F-10000 pneumatic final drive

- EASILY CALIBRATED • PRECISION POSITIONING • CAN BE FULLY CHARACTERIZED •
- HIGH STARTING TORQUE • EASILY MAINTAINED •



description

The Hays-Republic Model F-10000 Final Drive is designed to operate and position dampers, lever operated valves, fan inlet vanes, turbine governors, and other control devices requiring rotary torque precision positioning.

This Pneumatic Actuator provides high starting torques and rapidly positions the final control element. Input signals are cam characterized to accurately control the relationship of the drive lever motion to a given input signal variation.

The Positioner is complete with all internal pneumatic piping required for the air supply and input signals.

The entire unit is weathertight, and suitable for temperature ranges of 0° to 140°F. All operating parts are readily accessible for calibration, servicing, and maintenance as required.

specifications

CONSTRUCTION:	Weathertight
OPERATING TEMPERATURES:	0° - 140°F.
MOUNTING:	Floor, 4 7/8" x 13" bolt centers
CYLINDER:	4" x 5"
OUTPUT:	0° - 90° rotation cam characterized
RESPONSE TIME:	Less than 6 seconds
REPEATABILITY:	± .25%
INPUT:	3 - 15 psig or 15 - 3 psig
AIR SUPPLY:	35 - 100 psig
AIR CONSUMPTION:	1 SCFM
INDICATION:	0° - 90° lever position
CONNECTIONS:	1/8" NPT (Signal Input)
SUPPLY:	1/4" NPT
ELECTRICAL:	2 - 3/4" conduit knockouts
NET WEIGHT:	100 lbs.

FIGURE 7-23 HAYS-REPUBLIC PNEUMATIC CONTROL DRIVE

Pneumatic Control Drives Type AC

Bailey pneumatic control drives Type AC provide remote-controlled power for positioning of regulating devices thru mechanical linkage.

APPLICATION

Bailey pneumatic control drives operate and position regulating devices such as dampers, fan inlet vanes, lever-operated valves, turbine governors and other devices requiring an external means of power. Drives are actuated by electric or pneumatic incoming signals from automatic control or remote manual stations.

FEATURES

- Wide range of torque. Four sizes are available in torque ratings from 125 to 4000 ft-lbs (169 to 5420 Nm).
- Suitable for high temperature environments. Units with pneumatic positioners can be used in ambient temperatures up to 200°F (93°C). Units with I/P positioners operate at up to 180°F (82°C).
- Characterizable positioning relays. Feedback cams can be shaped to provide the relationship required between input signal and final control element position. Controls both direct and reverse action of drive.
- Accepts electric or pneumatic control signal. See positioner Product Specification P88-7 (for Characterizable Pneumatic Positioner Type AP2) or P88-8 (for Characterizable I/P Positioner Type AP5).
- Easy to install. Can be placed in any convenient location indoors or out and connected to the regulating device by standard linkage components (see Product Specification G81-5 on control drive linkage).
- Quick change-over to local hand operation from remote manual or automatic operation can be made without loss of control.

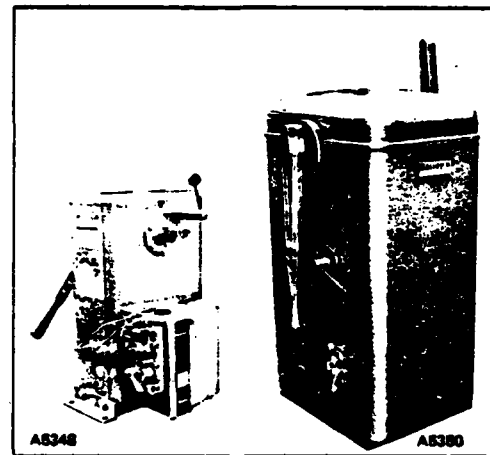

FIGURE 1 - Type AC0404 Pneumatic Control Drive (left) with external Type AP characterizable positioner. Type AC0608 Pneumatic Control Drive (right) has internal Type AP characterizable positioner.

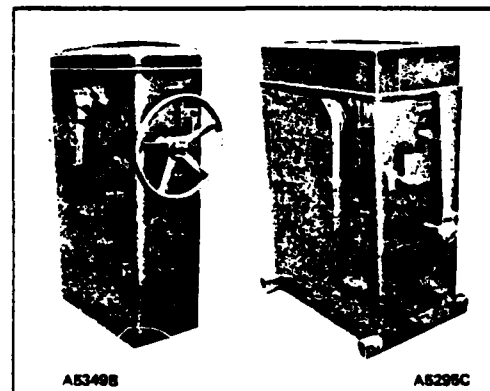
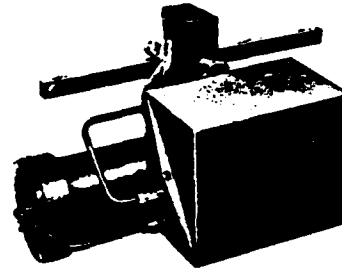

FIGURE 2 - Both Type AC0816 (left) and Type AC1016 (right) have internal Type AP characterizable positioners.

MODEL 7330
PRODUCT DATA SHEET

COMPACT FINAL DRIVE

- **HIGH OUTPUT TORQUE**
- **CHARACTERIZED MOTION**
- **ACCURATE ROTARY OUTPUT**
- **STANDARD MANUAL LOCK**
- **WEATHERPROOF ENCLOSURES**



This versatile pneumatic drive unit is a low-cost final drive for positioning valves, dampers, and other final control elements. Compact size, a characterizing cam, and weatherproof case contribute to produce a drive unit suitable for a great variety of applications. And as an added benefit, you can easily mount the unit in any position — indoors or out. Besides producing an excellent torque, the rotary motion output shaft simplifies installation. Linkage problems do not exist. Simply mount lever in any position on the output shaft. Lever length adjusts to a full 13 inches.

A characterizing cam produces various feed-back functions for given signal pressure changes. One portion of the cam produces an output linear to the input, while another portion produces an exponential motion approximately equal to the square of the input. The

remaining cam segment is uncut. You can easily tailor your response by merely shaping the blank portion to your requirements. Or just select the segment that will produce your desired results. Cam changing is completely eliminated.

The drive will operate directly from a 40 to 150 psi air supply, and does not require either regulation or filtering if attached to a clean, dry air source. Inputs may be 3 to 15 or 3 to 27 psig, depending on which you select. A manual operator and limit switches are optional accessories to provide even greater versatility.

Model	7330
Input Signal	3 to 15 or 3 to 27 psig
Maximum Supply Pressure	150 psi
Minimum Supply Pressure	40 psi
Operating Temperature Limits	0°F to +200°F
Sensitivity	1/4% or Better
Output Shaft Rotation	75 Degrees
Time Required for Full Stroke:	
No Load	8 Seconds
30 Pound Feet	8 Seconds
50 Pound Feet	9 Seconds
Weight	22 Pounds

FIGURE 7-25 HAYS-REPUBLIC COMPACT PNEUMATIC CONTROL DRIVE

7.4.2 Electric Control Drive

Function

The function of an electric control drive is to position a damper or lever operated valve in response to an input control signal.

Theory of Operation

Most electric control drives use a reversible electric motor to position the output drive lever. The motor acts through a series of reduction gears to increase the output torque and provide precise control. The motor does not operate continuously. It is started when an input control signal is received and stopped when the output drive lever reaches the desired position.

Often a cam mechanism is included with the control drive which can be used to "characterize" the output. Thus, the displacement of the output drive lever can be made to vary with respect to the input signal in accordance with almost any mathematical function.

Hays-Republic

models 873 and 874

electric power units

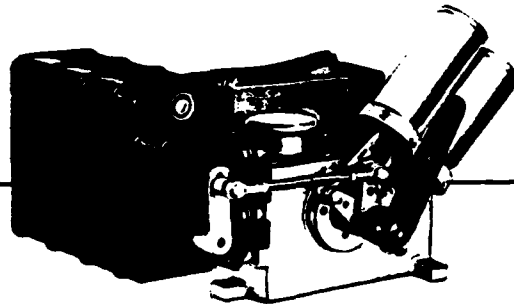

application

Electric Power Units are normally used in combustion and process control to operate the final control element. These units have a reversible motor and may be applied to operate dampers, valves, rheostats, variable speed transmissions, fan couplings, stoker levers, and similar devices. Adjustable limit switches are supplied to restrict angular travel of the unit. Additional switches can be installed to operate signal lights or alarms, for transfer of control or for purpose of interlocking. Potentiometers for control application or for the operation of remote position indicators are also available.

operation

The Electric Power Unit is electrically connected to its controller. It is energized by reversing relays whose coils are operated by a circuit closing device such as magnetically operated mercury switches, relay contacts or an electronic relay. A lever secured to the output shaft moves as the shaft turns. Linkage connects this lever to the final control element to be operated. By suitable adjustment of the linkage, either linear or non-linear motion of the final control element may be obtained.

features

- **RAPID RESPONSE.** Electrical operation insures immediate response.
- **REVERSIBLE MOTOR:** Rotation of output shaft is instantly reversible.
- **RATINGS** include high safety factor for normal line voltage variations.
- **NO OVER-TRAVEL:** Friction braking at rotor stops motor when current is cut off.
- **PLUG-IN RELAYS** with integral dual life feature.
- **HIGH STARTING TORQUE** always available to overcome static friction.
- **HAND WHEEL** provided for manual operation.

FIGURE 7-26 HAYS-REPUBLIC ELECTRIC CONTROL DRIVE

Electric Control Drives (Modulating) Type RW

Provide remote-controlled power for precise positioning of regulating devices through mechanical linkage.

APPLICATION

Operating and positioning dampers, lever-operated valves, and other regulating devices requiring an external means of power. Drives are actuated by electrical signals from an automatic control system or from a remote manual station.

FEATURES

- **Modulating Control.** Speed of travel is proportional to the value of the position error signal. As the signal approaches the desired control point, speed decreases and virtually no overshooting occurs.
- **Flexible Control Characteristics.** Cam mechanism improves control characteristics of regulating devices by providing a simple adjustment for relation between Drive position and electric input signal.
- **Easy to Install.** Control drive can be placed in any convenient location indoors or outdoors. Connected to the device being regulated by standard linkage (see Product Specification G81-5).
- **Servo Amplifier** is designed for indoor cabinet or rack mounting.
- **Wide Range of Torques.** Five sizes available in torque ratings from 230 to 6000 lb-ft (312 to 8136 Nm).
- **Equipment Protection.** Motor current limiting prevents damage during automatic operation in the event that the driven device jams. Torque limit switches are provided to limit maximum output torque to a preset value. Torque limit switches are normally set to $\pm 20\%$ of maximum rated torque. Special factory settings are available on request.
- **Remote Manual Control.** Precise jogging control bypasses Servo Amplifier and can be accomplished with Amplifier Card unplugged to facilitate maintenance.
- **Direct Manual Operation.** Quick changeover to direct manual operation from automatic or remote manual operation thru local interlock and hand crank.
- **Service Accessibility.** Easy access to drive components. Plug-in circuit cards allow testing and maintenance while drive continues operating under manual control.
- **Quick Disconnect Plug** permits functional testing without disturbing system wiring.
- **Wide Ambient Temperature Applications.** -10 to $+160^{\circ}\text{F}$ (-23 to 71°C); low temperature lubricant available for operation at -30 to $+160^{\circ}\text{F}$ (-34 to 71°C).

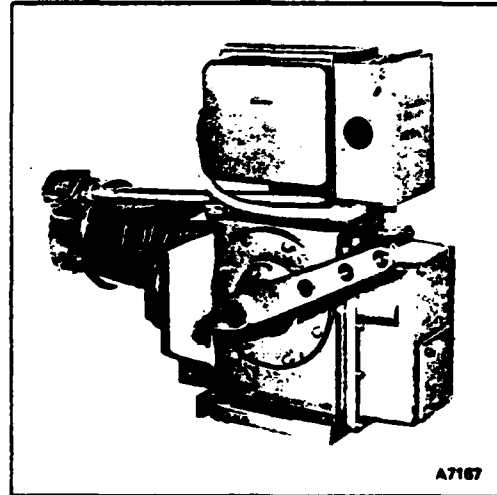

FIGURE 1 - Type RWB Control Drive with 650 lb-ft (881 Nm) continuous torque rating.

7.4.3 Pneumatic Valve Actuator

Function

The function of a pneumatic valve actuator is to vary the amount a valve is opened in accordance with an input control signal from some other control component.

Theory of Operation

Pneumatic actuators are normally the piston operated or diaphragm operated type. The piston operated type perform in essentially the same manner as any piston operated pneumatic control drive (see Section 7.4.1). The main difference is that piston operated valve actuators are specifically designed for valves and are mounted directly on the valve yoke.

Diaphragm actuators are perhaps the most common valve positioning device. They are relatively inexpensive and yet afford very precise modulating control. They operate in somewhat the same manner as a piston actuator, except a spring loaded (or air opposed) diaphragm is used instead of a piston. The valve stem is directly coupled to the diaphragm. When the air pressure is increased in the chamber above the diaphragm it pushes the valve stem down, and when the pressure is decreased the stem comes up.

Numerous control options are available with pneumatic actuators. The valve may be made to either open or close on loss of air supply or even fail in place if desired. The valves may be operated directly using control signal air, or the control signal may go to a positioner which in turn regulates the actuator. If a positioner is provided, the valve may be controlled using either a pneumatic or electric control signal.

Pneumatic actuators may be used to provide either modulating or on-off control. If modulating a control is required, valve positioners are normally added since they greatly increase the control precision. The positioner normally receives a feedback signal from the valve (via a mechanical linkage) so that it is able to precisely vary the valve opening in accordance with the input control signal.

V-PUP* CONTROL VALVE

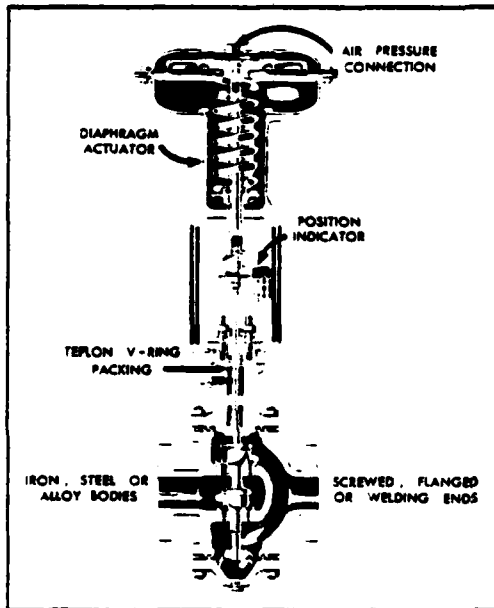

FIGURE 1 - Bailey Diaphragm-Actuated, V-Pup Control Valve. TYPE VFA. CLASS C20E-O.

The TYPE VFA. CLASS C20E or D20E valve is of the double-seat, top and bottom guided, V-Port design with proportional uniform percentage characteristics. If pressure drop is held constant, equal percentage change in rate of flow will result from equal changes in valve lift for all openings of the valve.

Application

Typical applications include condensate flow control, steam pressure reducing, etc. Restricted area inner valves are available where specific applications necessitate their use.

SPECIFICATIONS

TABLE I

Material	<p>Plug, Stem, and Seats: Type 316 stainless steel. Sealtined seating and/or guiding surfaces optional.</p> <p>Body: Semi-steel (ASTM A126 Class B or C); carbon steel (ASTM A216 Gr. WCB); or chrome-moly (ASTM A217 Gr. CS).</p> <p>Yoke: Semi-steel.</p> <p>Packing: Self-lubricating Teflon V-ring for steam to 480 psi saturated, superheated steam to 480 psi, and water to 450F; Durethane for steam over 450 psi or water over 450F.</p> <p>Actuator Spring: Silicon manganese steel.</p> <p>Diaphragm: Buna N with nylon fabric insert.</p> <p>Diaphragm Case: Pressed steel.</p>
Operation	<p>Normally Open (air-to-close action): CLASS C20E-O. See Figure 2, Page 2.</p> <p>Normally Closed (air-to-open action): CLASS D20E-C. See Figure 3, Page 2.</p>
Actuator	<p>See Table II, Page 2, for dimensions and effective diaphragm areas for various type actuators.</p>
Pressure Standards And Ends	<p>125, 150, 250, 300, 600, 900, or 1500 psig bodies having screwed, flanged, or welding ends designed to ASA standards. See Table III, Page 2, for corresponding sizes and materials.</p>
Control Pressure Ranges	<p>Standard signal ranges of 3-27 or 3-15 psig. 40 psig supply pressure required when positioning relay is included.</p>
Weights	<p>Shipping: See Table III, Page 2.</p> <p>Net: Approximately 85% of shipping weight.</p>
Accessories	<p>Standard: Unless otherwise specified, base price includes position indicator and instruction book.</p> <p>Available: Handjack; positioning relay (see Product Specification P88-4); travel stops; extension bonnet (for temperatures above 450F); pneumatic trapping valves; solenoid valves; limit switches; and position transmitters (see Product Specification P88-51).</p>

© Bailey Meter Company 1964

FIGURE 7-28 BAILEY PNEUMATIC VALVE ACTUATOR-DIAGRAM TYPE

BAILEY PISTON-ACTUATED CONTROL VALVE

The TYPE VJ, CLASS D10E, D10F, or D10G valve is of the balanced, double-seat, cage-guided, V-port design where port area is determined by the size and shape of cage ports. Integral piston actuator provides ample power.

APPLICATION

For accurate, dependable throttling control with minimum noise and maximum availability under conditions of high initial pressure, high temperature, and high pressure drop. Typical applications include feed water control, steam pressure reducing, etc.

PHYSICAL CHARACTERISTICS

Material

Cage, Stem, and Discs: Type 304 stainless steel (CLASS D10E); Type 304 stainless steel with stellite seating surfaces (CLASS D10F); or Type 304 stainless steel with stellite seating and guiding surfaces (CLASS D10G).

Body: Carbon steel (ASTM A216 Gr. WCB); or chrome-moly (ASTM A217 Gr. WC6 or Gr. C5).

Yoke: Semi-steel.

Stem and Branch Block Packing: Suitable for specific valve operating pressure and temperature.

Operation

Stem moves up to close.

Actuator

TYPE VJ1: Single-cylinder (6" diameter and 8" stroke) with positioning relay.

TYPE VJ2: Single-cylinder (8" diameter and 8" stroke) with positioning relay.

TYPE VJ3: Single-cylinder (10" diameter and 8" stroke) with positioning relay.

TYPE VJ4: Two-cylinders (8" diameter and 8" stroke) with positioning relay.

See Table I, Page 2, for actuators used with various size valves.

Pressure Standards and Ends

600, 900, 1500, or 2500 psig bodies having raised face flanged or welding ends designed to ASA standards. See Table I, Page 2, for corresponding sizes and materials. Ring joint flanges or carbon steel welding ends on chrome-moly bodies optional.

Control Pressure Ranges

Standard signal ranges of 3-15 or 3-27 psig, 40 psig supply pressure required for positioning relay.

Weights

Shipping: See Table I, Page 2.

Net: Approximately 85% of shipping weight.

MAXIMUM RECOMMENDED VELOCITIES

Steam, Air, or Gas: 50,000 fpm outlet.

Water (550 psia and 350F): Carbon steel body—10 fps; Semi-steel body—20 fps; Gr. WC6 chrome-moly body—25 fps; Gr. C5 chrome-moly body—35 fps.

ACCESSORIES

Standard: Unless otherwise specified, price includes characterized positioning relay (see Product Specification P99-5); air failure lock with manual reset; integral cooling head (standard except for 600 psig valve with 3 1/2" x 1 1/4" cage size with optional, separate casting cooling head); position indicator; and instruction book.

Available: Position transmitter (see Product Specification P99-10); fixed minimum stop; air failure alarm; travel limit switches; stem lubricator and isolating valve; expanded outlets in some sizes; radiography.

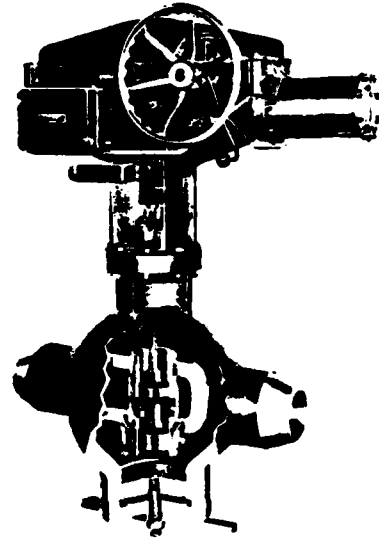

FIGURE 1 — Bailey Piston-Actuated, V-Port Control Valve, TYPE VJ, CLASS D10E, D10F, or D10G.

QUOTATION/ORDERING INFORMATION

To receive a complete quotation and shipping date or to place an order, please supply information on the V-PORT CONTROL VALVE as follows:

Flowing Conditions:

Fluid: _____

Maximum Capacity: _____

Minimum Capacity: _____

Maximum Inlet Pressure: _____ psig

Fluid Temperature: _____ F

Specific Gravity: _____ at _____ P/60F

Pressure Drop at Maximum Capacity: _____ psi

Pressure Drop at Minimum Capacity: _____ psi

Inlet Pressure at Maximum Capacity: _____ psig

Valve Inlet Size: _____ inches

Valve Outlet Size: _____ inches

Control Pressure: 3-27 psig; 3-15 psig

Pressure Standard: 600 psig; 900 psig;
 1500 psig; 2500 psig

Valve Ends: Flanged; Welding

Accessories: _____

©Bailey Meter Company 1964

PNEUMATIC EQUIPMENT

FIGURE 7-29 BAILEY PNEUMATIC VALVE ACTUATOR-PISTON TYPE

PNEUMATIC PROPORTIONAL POSITIONER Type AP1

The Type AP1 Proportional Positioner provides fast, sensitive and accurate positioning of double-acting piston/cylinder assemblies and single-acting spring or cushion-loaded diaphragm actuators in response to an input signal (3-15 or 3-27 psig) from a pneumatic controller device.

The Positioner is usually located in the control loop between the controller and the final control element power device (cylinder or diaphragm actuator). A mechanical connection to the final control element is used to feed back the actual position. When the controller calls for repositioning, the Positioner acts as a pneumatic relay, thru an independent air supply, and changes the piston or valve to the new required position.

Features

- Stable positioning characteristics are provided for both small and large cylinders or actuators.
- Large gas/air capacity (greater than 25 scfm at 75 psi) for fast final control element response while maintaining low gas usage.
- Wide range of operation. Standard stroke ranges from 0.25" to 24.0".
- 24 psig maximum input span. Includes standard input signals of 3-15 psig or 3-27 psig and offers a variety of split range capabilities (ie. 3-9 psig, 9-15 psig, etc.).
- Usable for double-acting or single-acting service. A valve adjustment procedure permits changeover from double-acting to single-acting operation.
- Action (direct or reverse) is changeable in the field without the need for any additional parts.
- Capable of operating at ambient temperatures up to 250F and supply pressures up to 150 psig.
- Externally adjustable span and zero for each stroke level.
- Good vibration resistant characteristics to final control element movement for accelerations up to 2 G's and frequencies below 60Hz.
- Positive mechanical feedback provides accurate final control element movement for each value of input signal applied.
- Most Positioners available as off-the-shelf units.
- Small compact size allows for easy handling and installation.

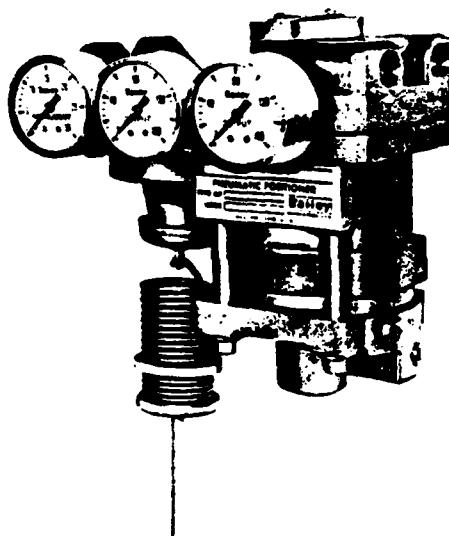

FIGURE 1 - Type AP1 Pneumatic Proportional Positioner

7.4.4 Electric Valve Actuator

Function

The function of an electric valve actuator is to vary the amount the valve is opened in accordance with an input control signal from some other control component.

Theory of Operation

Electric actuators may be either the motor operated type or the solenoid type. Motor operated actuators are in general rather expensive and are normally not used on small industrial boilers. They utilize a reversing electric motor acting through a series of reduction gears to position the valve. The motor drives the valve to the desired position and then stops. Torque switches and/or limit switches are generally included for motor protection.

Solenoid actuators are much less expensive than motor operators, but they are much more limited in their application. Solenoid actuators can only provide on-off, or wide open-shut valve control. Furthermore, they are only practical on small valves, generally less than two inches in diameter, and are normally only used on valves smaller than one inch.

Solenoid actuators use an electromagnetic coil to position the valve plug. The valve stem is usually an integral part of a magnetic plunger which passes through the middle of the coil. When the coil is energized, electromagnetic force causes the plunger to move either up

or down, thus positioning the valve plug. The plunger is spring loaded, so that when the coil is de-energized, the valve plug returns to its original position. Solenoid valves may be designed to either open when energized or close when energized, and either alternating current (ac) or direct current (dc) may be used to energize the coil.



fuel valves and actuators

V4036A,B; V8036A SOLENOID GAS VALVES

NORMALLY CLOSED SOLENOID GAS VALVES FOR MEDIUM PRESSURE GAS BURNERS.



May be used as safety shutoff valve on pilot or main fuel supply lines. Suitable for LP, natural, or manufactured gases. Valve Pattern: Straight-through. Maximum Ambient Tem-

perature: V4036A, V8036A—125 F [52 C]; V4036B—140 F [60 C]. Listed by Underwriters Laboratories Inc; Industrial Risk Insurers (formerly FIA) approvable; Factory Mutual approved; Canadian Gas Association certified; American Gas Association certified.

REPLACEMENT PARTS: Coil Assemblies—

ASSEMBLY NUMBER	CLASS ^a	VOLTS (60 Hz)	USED ON
7840NB ^b	A	120	V4036A
7840NC ^b	A	208	V4036A
7840ND ^b	A	240	V4036A
7840NH ^b	B	120	V4036B
118834 ^b	A	24	V8036A

^aCoil assembly consists of (1) coil, (1) V4021 nameplate, (1) V4036 nameplate, (1 set) Honeywell form 96-2230 instructions, 96-6489 instructions, and 80-0004 instructions.

^b24V, 60 Hz coil only.

^cCapable of operation at following maximum coil temperature levels:

	FAHRENHEIT	CELSIUS
Class A	221	105
Class B	205	130

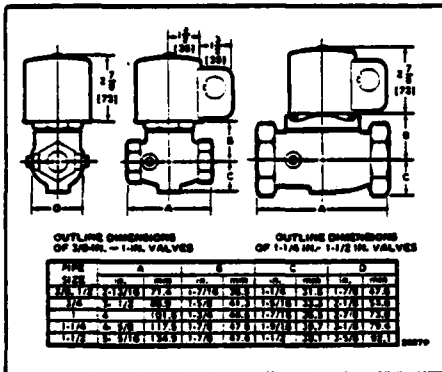

V4036, V8036 dimensions in inches [millimetres in brackets].

No other parts replaceable.

ORDER NUMBER	VOLTAGE (60/60 Hz)	PIPE SIZE NPT	PRESSURE RATING		FLOW CAPACITY ^a		PILOT TAP
			psi	kPa	cfh	m ³ /hr	
V4036A1001	120	3/8	10.0	68.9	108	3.1	1/8
V4036A1019	120	1/2	5.0	34.5	238	6.7	1/8
V4036A1027	120	3/4	3.0	20.7	485	13.7	1/8
V4036A1035	120	1	1.5	10.3	772	21.9	1/8
V4036A1043	120	1-1/4	1.25	8.6	1058	30.0	1/4
V4036A1050	120	1-1/2	1.0	6.9	1409	39.9	1/4
V4036A1058	240	3/8	10.0	68.9	108	3.1	1/8
V4036A1076	240	1/2	5.0	34.5	238	6.7	1/8
V4036A1084	240	3/4	3.0	20.7	485	13.7	1/8
V4036A1092	240	1	1.5	10.3	772	21.9	1/8
V4036A1100	240	1-1/4	1.25	8.6	1058	30.0	1/4
V4036A1118	240	1-1/2	1.0	6.9	1409	39.9	1/4
V4036B1009	120 ^b	3/8	10.0	68.9	108	3.1	1/8
V4036B1017	120 ^b	1/2	5.0	34.5	238	6.7	1/8
V4036B1025	120 ^b	3/4	3.0	20.7	485	13.7	1/8
V4036B1033	120 ^b	1	1.5	10.3	772	21.9	1/8
V4036B1041	120 ^b	1-1/4	1.25	8.6	1058	30.0	1/4
V4036B1058	120 ^b	1-1/2	1.0	6.9	1409	39.9	1/4
V8036A1002	24	1-1/4	1.25	8.6	1058	30.0	1/4

^aCFH Net. gas 1000 Btu/cu ft, 0.64 sp gr, p.d., 1 inch w.c. (m³/hr. 37.3 MJ/m³, 0.64 sp gr gas at 0.25 kPa).

^bClass B coil.

TRADELINE

FIGURE 7-31 HONEYWELL SOLENOID VALVE

7.4.5 Hydraulic Valve Actuator

Function

The function of a hydraulic valve actuator is to vary the amount a valve is opened in accordance with an input control signal from some other control component.

Theory of Operation

Hydraulic valve actuators operate in basically the same manner as pneumatic actuators, except that a liquid instead of a gas is used as the motive, or control, fluid. Either a piston or diaphragm is provided, and the hydraulic pressure acting against it is varied as necessary to position the valve.

Hydraulic actuators may use liquid from the process piping upstream of the valve as the motive fluid, or they may be provided with self-contained hydraulic oil systems. Pilot valves, either electric, hydraulic, or pneumatic, are used to regulate the flow to and from the actuator diaphragm or piston.



fuel valves and actuators

—V4055A,B,D,E ON-OFF FLUID POWER GAS VALVE ACTUATORS—



USED WITH V5055 VALVE TO CONTROL GAS SUPPLY TO COMMERCIAL AND INDUSTRIAL BURNERS.

Refer to ordering table for application. Rated for final safety shutoff service when used with V5034 or V5055 valve. Indicators on valve and actuator provide

constant visual indication of valve position. Valve and actuator can be mounted in any position. Actuator mounts directly to valve bonnet with 2 setscrews. Ambient Temperature Rating: Minus 40 to plus 150 F [minus 40 to plus 66 C] for 60 Hz models. Closing Time: 1 second maximum. Pressure ratings and approvals for these actuators depend on the valve used. Refer to VALVE-ACTUATOR APPROVALS and PRESSURE RATINGS, page 238.

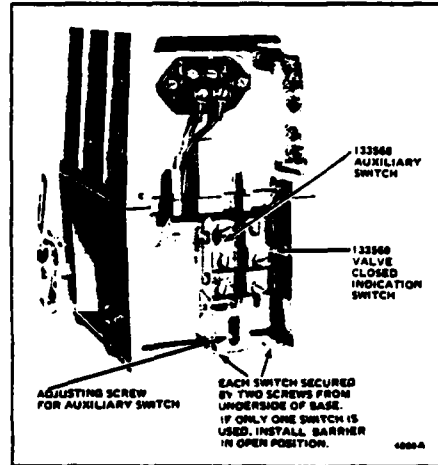

V4055 Actuator with cover removed.

ELECTRICAL RATINGS:
V4055A,D—

VOLTAGE/ FREQUENCY	OPENING (STANDARD)				OPENING (FAST)				HOLDING		
	INRUSH	WATTS	AMP	VA	INRUSH	WATTS	AMP	VA	WATTS	AMP	VA
120V/60 Hz	3.9	50.0	0.94	115	5.4	71.0	1.33	160	9.5	0.12	14
208V/60 Hz	2.7	54.0	0.99	115	4.0	73.0	0.80	160	9.1	0.07	14
240V/60 Hz	2.6	51.0	0.45	115	4.0	71.5	0.68	160	9.2	0.06	14

V4055B,E—120V, 60 Hz.

Opening—60 watts, 0.94 amp (5.4 amp inrush), 115 VA.

Holding—9.5 watts, 0.16 amp, 19 VA.

DAMPER CRANK ARM RATING (electrically drives damper in 1 direction only):

Standard Models—20 lb maximum at 2-11/16 in. radius at plus 20 to plus 150 F, and 5 lb at minus 40 to plus 20 F [9 kg maximum at 68 mm radius at minus 7 to plus 66 C, and 2.3 kg at minus 40 to minus 7 C].

Models with Damper Shaft Return Spring—10 lb maximum at 2-11/16 in. radius at plus 20 to plus 150 F and 5 lb at minus 40 to plus 20 F [4.5 kg maximum at 68 mm radius at minus 7 to plus 66 C, and 2.3 kg at minus 40 to minus 7 C].

MAXIMUM DAMPER SHAFT ROTATION: 52 angular degrees.

AUXILIARY SWITCH AND VALVE-CLOSED (FACTORY MUTUAL) SWITCH RATINGS: 1/2 hp.

LOAD	120V	240V
Full Load	9.8 amp	4.9 amp
Locked Rotor	58.8 amp	29.4 amp

*Maximum total connected power to both switches (if used) is 1800 VA.

REPLACEMENT PARTS:

133568 Auxiliary Switch Bag Assembly.
133569 FM Proof of Closure/UL Valve Seal Overtravel Interlock Switch Bag Assembly. Must be used with V5055C or E; do not use with V5034 valve body.
76168R Damper Crank Arm (damper arm and clip).
No other parts replaceable.

ACCESSORIES:

133568 Auxiliary Switch Bag Assembly.
133569 FM Proof of Closure/UL Valve Seal Overtravel Interlock Switch Bag Assembly. Must be used with V5055C or E; do not use with V5034 valve body.
76168R Damper Crank Arm (damper arm and clip).
133533A Short Stem Adapter for mounting actuator on V5034 valve with short stem.
133534A Long Stem Adapter for mounting actuator on V5034 valve with long stem.

continued next page

TRADELINE

FIGURE 7-32 HONEYWELL HYDRAULIC VALVE ACTUATOR

Hays-Republic

model F-04632

hydraulic position regulator

- RUGGED CONSTRUCTION • WEATHERPROOF CASE • CHARACTERIZED OUTPUT •
- POSITION INDICATING RELAY OPTION AVAILABLE •



application

The Hays-Republic Hydraulic Position Regulator is used to regulate the position of a hydraulic piston operated slide valve. An air loading pressure received either from a controller or a manual air loading station is used to control the action of the regulator and hence determine the position of the slide valve.

The attached curve, Figure 1 on reverse side, illustrates the relationship between the air pressure applied to the loading diaphragm and the power piston position or valve stroke.

the regulator

The Hydraulic Positioner consists of a cast iron case upon which are mounted a loading diaphragm assembly, an oil pilot valve assembly and a return motion assembly.

Such a regulator is illustrated by Figure 2 on reverse side. There may be certain variations in the arrangement of the return motion to accommodate a vertical or horizontal position of the power relay cylinder.

Regardless of the arrangement or size of parts, the principle of operation is the same for this type of positioner.

operation

The Positioner is an oil operated regulating device of the positioning type. It transforms loading air pressure impulses as received from a controller of the flow control, level control, hand control or other type of master control device, and converts this air pressure into a definite position of a power piston. In this particular case, its purpose is to position a slide valve. Its action is controlled manually or automatically from a remote control panel.

operation cycle

With zero pressure on the loading diaphragm the power piston is at the end of its stroke. Application of pressure on the loading diaphragm causes it to move downward against the pressure

of the diaphragm spring. The pilot valve balancing lever is pinned at its left end to the cam follower lever. Since this pivot point is held stationary at the beginning of the cycle, the righthand end of the balancing lever is moved downward. This moves the pilot valve connecting link and results in a movement of the multiplying valve which produces a movement of the pilot valve. The pilot valve is connected to a supply of oil under pressure. When the valve is moved from its neutral or mid-position, the pressure is increased on one end of the power piston and decreased on the opposite end. This produces a movement of the power piston. As shown in Figure 2, the power piston will move from right to left and produce a counterclockwise rotation of the circular cable pulley which holds the cam plate. The cam roller is held against the edge of the cam by a spring, and therefore, follows the shape of the cam so that the cam lever turns on its supporting shaft to reset the pilot valve to neutral. A decrease in pressure on the loading diaphragm causes a reversal of all the movements described above.

FIGURE 7-33 HAYS-REPUBLIC HYDRAULIC VALVE ACTUATOR

7.5 Recording Devices

7.5.1 Circular and Strip Chart Recorder

Function

The function of a circular or strip chart recorder is to keep a continuous record of one or more boiler operating parameters.

Theory of Operation

A circular chart recorder consists of a motor driven disk on which a paper chart is located, and one or more pen mechanisms which plot the desired output on the chart. The disk rotates very slowly, usually once every twenty-four hours. The individual pen mechanisms receive continuous input signals from various boiler parameter measuring devices, such as pressure, temperature, and flow transmitters. The mechanisms cause the individual marking pens to move laterally on the chart (towards or away from the center of the disk) in accordance with the magnitude of the control signal.

Circular chart recorders may be designed to receive either electric or pneumatic control signals.

Strip chart recorders operate on essentially the same principle as circular chart recorders. The only difference is that the pens mark on a rectangular "strip" chart which is rolled continuously from one reel onto another instead of a rotating disk. Since the strip chart can be made very long if desired, the same chart paper can be used for several days or even weeks.

Hays-Republic model 2100 12" circular chart recorder

- Accurate
- Wide Range Selection
- 1 to 4 Pens
- Plug-in Design

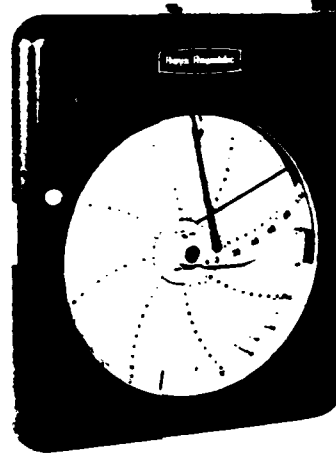

DESCRIPTION

The Hays-Republic Model 2100 is a versatile 12" circular chart recorder. The Model 2100 Recorder can be custom built from standard plug-in measuring elements to meet specific process recording requirements. The Model 2100 Recorder is capable of recording and indicating from one to four process measurements.

A quadrant or zone arrangement permits an extremely wide variety of recording, indicating, and integrating combinations. The quadrant design allows simple installation of up to four completely untized plug-in measuring elements for process recording. A maximum of two flow measurements with continuous integration utilizing all four quadrants is an available construction.

The Model 2100 Recorder has a rugged case which is easy to install and maintain. The case is weather resistant and designed to prevent entry of dust, moisture, and other harmful ambient elements.

The ink system design insures each pen a continuous ink flow with a three to four month ink supply in sealed cartridges.

Chart replacement is simple and may be accomplished with one hand. Instead of keys, nuts, chains, or loose parts, the Model 2100 Recorder has a spring latch that seats the chart firmly on its drive to prevent slippage.

Disengaging the chart latch automatically lifts the recording pens from the chart.

The chart holder and automatic pen lifters are secured to the chart plate. This plate simultaneously provides a smooth recording surface while protecting the chart drive mechanism. The chart bearing bracket, case, and chart plate are internally constructed to insure permanent alignment.

Optional indicating scales and fluorescent chart lighting are available for operator convenience.

STANDARD SPECIFICATIONS

- Standard Chart Drive....
..24 hour; 115 volt
60 cycle A.C.
- Hysteresis 0.5% or less
- Resolution 0.2% or less
- Ambient Temp. Effect
.. 0.4% per 50° F.
change
- Barometric Pressure Effect.....
..none
- Recorder Weight
(No Receivers).... Approx. 40 lbs.
- Specifications subject to change
without notice.

FIGURE 7-34 HAYS-REPUBLIC CIRCULAR CHART RECORDER

Hays-Republic

model 2550

strip chart recorder

- ACCURACY OF - 0.5% • SOLID STATE, PLUG-IN COMPONENTS •
- ONE, TWO OR THREE PENS • OPTIONAL ALARMS •

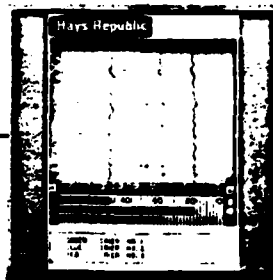

DESCRIPTION

The Hays-Republic Model 2550 Strip Chart Recorder provides recording of up to three variables on a 4" strip chart while providing a highly visible indication of the variable. Ribbon-type indicators are color coded to the pen color and provide indication at up to twice the distance of conventional pointer indicators.

The servo-operated, null-balance recorder uses a fully transistorized plug-in amplifier. Input circuits are electrically isolated from the power line and conduit, and are isolated from each other in multiple pen units to eliminate interaction between signals.

The servos operate on a 0-1 volt DC signal, and may be used on any of the common input ranges by proper selection of the input resistor (e.g. 1-3 mA DC, 4-20 mA DC, 10-50 mA DC, etc.).

The design of the servo is such that maximum power is available to overcome inherent friction or other sources of inaccuracy. A system accuracy of $\pm 0.50\%$ is obtained with a sensitivity of 0.25%. As a result of the power afforded by the servo operation, it is possible to add accessories directly to the servo drive.

ACCESSORIES

Alarm switches, to a maximum of two per pen, may be added as an option. The switches are cam-operated, SPDT-type and may be adjusted to trip at any point within the span. Each switch is rated $2\frac{1}{2}$ amps. at 125 to 250 VAC.

A retransmitting slidewire may be added to any pen. The potentiometer values are 1 to 1,000 ohms for general purpose applications and 1 to 32 ohms for use with the Hays-Republic Model 2240 Integrator.

The 2550 Recorder may also be provided with external ON-OFF control of chart drive and servo-motors which makes it ideally suited for use with process chromatograph to provide trend recording.

ACCESSIBILITY

The recorder has been designed for ease of maintenance and calibration. Zero and span adjustments are accessible from the front, with no need to withdraw the chassis from the case. The chart drive mechanism flips out at the touch of a lever to allow chart changing with no need of removing the drive mechanism or chassis from the case.

FIGURE 7-35 HAYS-REPUBLIC STRIP CHART RECORDER

BAILEY 7000 RECORDERS

Type 771, 772 and 773

Records up to three process measurements on a 4-inch rectilinear chart. Color matched indicators track with the recording pens, providing accurate, highly visible indications. Pen motion is servo driven by a plug-in high gain null balance DC amplifier, providing fast, accurate response. The recorder chassis mounts in a standard 762 panel or rack mounted shelf and connections are made through a plug and cable assembly.

Type 771, 772 and 773 Recorders are fully compatible with other Bailey 7000 instruments, including the Type 770 Point Selector for trend recording up to 12 variables, as well as for general use in recording DC signals from many other process instruments.

Input Signal Choice

- 1 to 5, 0 to 1, 0 to 5, 0 to 10, -10 to +10v DC or 4 to 20ma DC powered from recorder or self-powered.

Improved Operator Convenience and Understanding

- Three chart displays:
 - Type 771 Narrow Roll Chart: High recording density, up to 3 pens in a 2.8 inch-wide recorder. Up to eight hour instant review. Two hours visible on the face of recorder, six more hours with recorder partially removed from enclosure.
 - Type 772 Wide Roll Chart: Up to 13 hour instant review. Six hours visible on the face of the 5.6 inch-wide recorder, seven more hours with recorder partially removed from enclosure.
 - Type 773 Z-fold Chart: Up to three hours visible on the face of the recorder. The entire past record may be viewed by opening front window and pulling folded chart paper from take-up chamber. This is also a 5.6 inch-wide recorder.
- Chart transport assembly completely removable for historic review and chart change without operator inconvenience.
- Operator supervision maintained during chart removal by independent bar graph indicators that communicate process measurement to operator.
- Unique two-way door for operator notation and maintenance convenience.
- Highly visible color coded bar graph indicators to match pens.

Minimum Maintenance with Simplified Servicing

- Quick change, disposable one piece pen and ink cartridge. Easy one step replacement. Ink cartridge life, up to ninety days of normal usage - 3000 ft (914.4m) of trace.

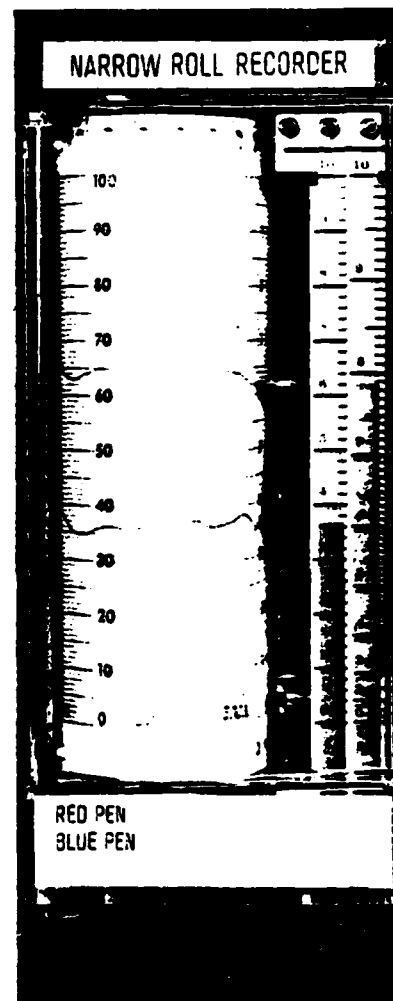

FULL SIZE

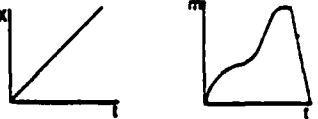

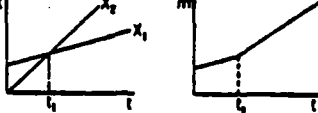

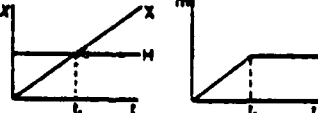
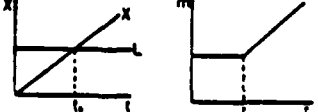

FIGURE 1 - Type 771 Narrow Roll Strip-Chart Recorder

APPENDIX A



SIGNAL PROCESSING FUNCTIONS

Function & Symbol *	Math Equation	Graphic Representation	Definition
SUMMING Σ	$m = x_1 + x_2 + \dots + x_n$		The output equals the algebraic sum of the inputs.
AVERAGING Σ/n	$m = \frac{x_1 + x_2 + \dots + x_n}{n}$		The output equals the algebraic sum of the inputs divided by the number of inputs.
DIFFERENCE Δ	$m = x_1 - x_2$		The output equals the algebraic difference between the two inputs.
PROPORTIONAL K	$m = Kx$		The output is directly proportional to the input.
INTEGRAL \int	$m = \int x dt$		The output varies in accordance with both magnitude and duration of the input. The output is proportional to the time integral of the input.
DERIVATIVE d/dt	$m = T_D \frac{dx}{dt}$		The output is proportional to the rate of change (derivative) of the input.
MULTIPLYING X	$m = x_1 x_2$		The output equals the product of the two inputs.
DIVIDING \div	$m = \frac{x_1}{x_2}$		The output equals the quotient of the two inputs.
ROOT EXTRACTION $\sqrt{\quad}$	$m = \sqrt{x}$		The output equals the root (i.e., square root, fourth root, 3/2 root, etc.) of the input.
EXPONENTIAL x^n	$m = x^n$		The output equals the input raised to a power (i.e., second, third, fourth, etc.)

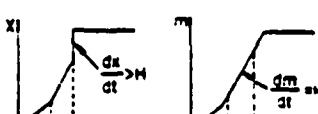
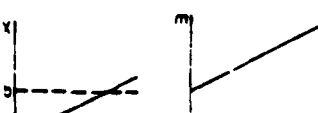
SIGNAL PROCESSING FUNCTIONS (CONT.)

Function & Symbol	Math Equation	Graphic Representation	Definition
NONLINEAR OR UNSPECIFIED FUNCTION $f(x)$	$m = f(x)$		The output equals some nonlinear function of the input.
TIME FUNCTION $f(t)$	$m = x f(t)$ $m = f(t)$		The output equals the input times some function of time or equals some function of time alone.
HIGH SELECTING >	$m = \begin{cases} x_1 & \text{FOR } x_1 \geq x_2 \\ x_2 & \text{FOR } x_1 < x_2 \end{cases}$		The output is equal to that input which is the greatest of the inputs.
LOW SELECTING <	$m = \begin{cases} x_2 & \text{FOR } x_1 \geq x_2 \\ x_1 & \text{FOR } x_1 < x_2 \end{cases}$		The output is equal to that input which is the least of the inputs.
HIGH LIMITING ↘	$m = \begin{cases} x & \text{FOR } x \leq H \\ H & \text{FOR } x > H \end{cases}$		The output equals the input or the high limit value whichever is lower.
LOW LIMITING ↗	$m = \begin{cases} x & \text{FOR } x \geq L \\ L & \text{FOR } x < L \end{cases}$		The output equals the input or the low limit value whichever is higher.
REVERSE PROPORTIONAL -K	$m = -Kx$		The output is reversely proportional to the input.
VELOCITY LIMITING V↘	$\frac{dm}{dt} = \frac{dx}{dt} \begin{cases} \frac{dx}{dt} \leq H \text{ and } m = x \\ \frac{dx}{dt} > H \text{ OR } m = H \end{cases}$		The output equals the input as long as the rate of change of the input does not exceed a limit value. The output will change at the rate established by this limit until the output again equals the input.
BIAS +, -, or ±	$m = x + b$		The output equals the input plus (or minus) some arbitrary value (bias).

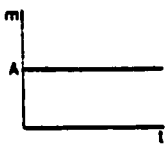
SIGNAL PROCESSING FUNCTIONS (CONT.)

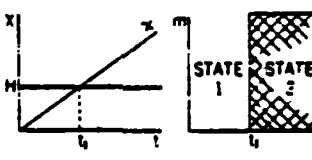
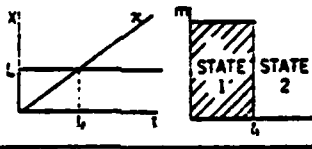
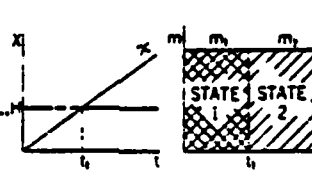
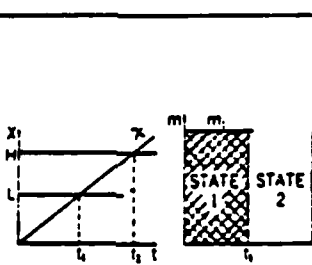
Function & Symbol	Math Equation	Graphic Representation	Definition
ANALOG SIGNAL GENERATOR A	$m = A$	DOES NOT APPLY 	The output is an analog signal developed within the generator.
TRANSFER T	$m = \begin{cases} x_1, & \text{FOR STATE 1} \\ x_2, & \text{FOR STATE 2} \end{cases}$		The output equals the input which has been selected by transfer. The state of the transfer is established by external means.
SIGNAL MONITOR H/	STATE 1 $x \leq H$ STATE 2 (ENERGIZED OR ALARM STATE) $x > H$		
/L	STATE 1 (ENERGIZED OR ALARM STATE) $x < L$ STATE 2 $x \geq L$		
H/L	STATE 1 (FIRST OUTPUT m_1 ENERGIZED OR ALARM STATE) $x < H, L$ STATE 2 (SECOND OUTPUT m_2 ENERGIZED OR ALARM STATE) $x > H, L$		The output has discrete states which are dependent on the value of the input. When the input exceeds (or becomes less than) an arbitrary limit value the output changes state.
H//L	STATE 1 (FIRST OUTPUT m_1 ENERGIZED OR ALARM STATE) $x < L$ STATE 2 (BOTH OUTPUTS INACTIVE OR DE-ENERGIZED) $L \leq x \leq H$ STATE 3 (SECOND OUTPUT m_2 ENERGIZED OR ALARM STATE) $x > H$		

The variables used in the table are:

A — An arbitrary analog signal

b — Analog bias value

$\frac{d}{dt}$ — Derivative with respect to time

H — An arbitrary analog high limit value

$\frac{1}{T_i}$ — Integrating rate

L — An arbitrary analog low limit value

m — Analog output variable

n — Number of analog inputs or value of exponent

t — Time

T_n — Derivative time

x — Analog input variable

$x_1, x_2, x_3, \dots, x_n$ — Analog input variable (1 to n in number)

END

FILMED

3-83

DTIC