

# Basic Weaving Skills

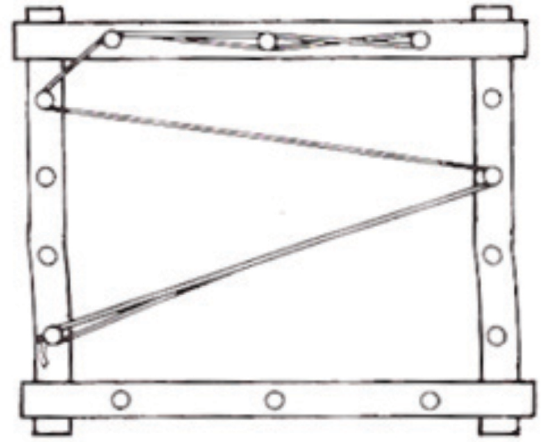

1. Making a warp, then chaining warp (giant crochet).
2. Beaming warp (rolling it on the back beam of loom).
3. Threading the warp through the heddles.
4. Sleying the warp through the reed.
5. Tying the warp to the front apron.
6. Tying up the treadles (on a floor loom).
7. Preparing bobbins.
8. Shuttle Control and Beating.

# Making the Warp

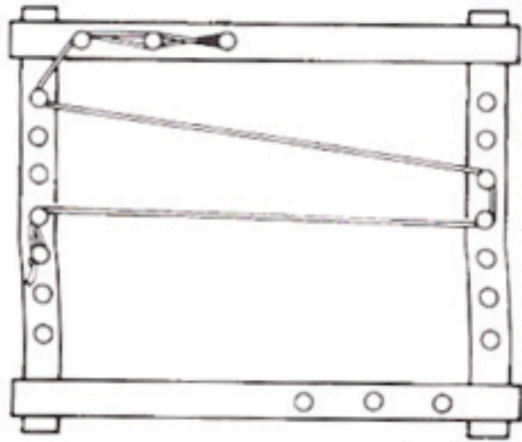

Two examples of three-yard-long warps on a warping board.

Start with a guide string to map the path your warp will take.

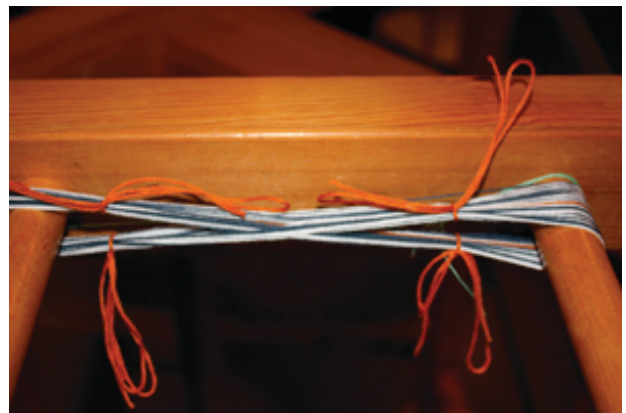

## Warping Mill

Wind in whichever direction feels most comfortable

Tie the Cross in 4 places



# Notes on Making the Warp and Chaining

---

---

---

---

---

---

---

---

---

---

---

---

---

---

---

---

---

---

---

---

---

---

---

---

---

---

# Prepping Your Loom



There's a couple of things you can do ahead of time to get your loom ready for warping back to front.

Cut two cords approximately 2 yards long, fold them in half and half hitch them to the sides of your castle.

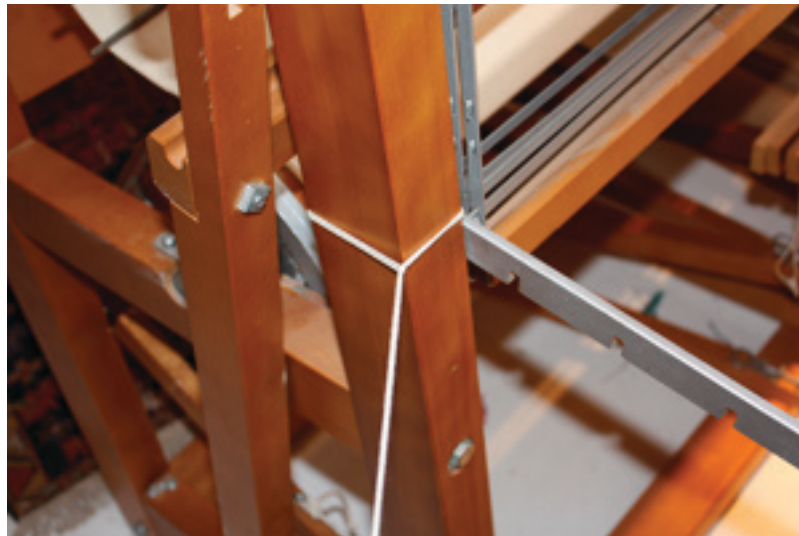

Undo the lashing cord on your apron rod. Cut two pieces of strong cord about 12" long, fold them in half and half hitch them to the apron rod at both ends. You will use these cords to attach the apron rod. We have one end of the apron rod attached in the photo.

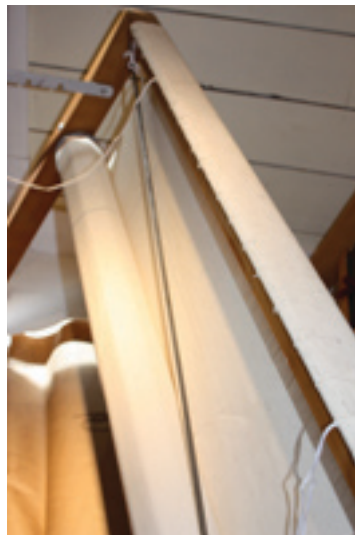

# Prepping Your Loom



Clamping the raddle.

Here are two possible locations where you can clamp your raddle onto your loom:



Jack Loom



Counterbalance Loom

# Dressing the Loom with a Raddle: Threading Back to Front



1. The cross end of the warp forms a loop. Slide a rod through this loop. Attach the warp rod to the apron rod at their ends leaving a one inch space between them. (Half-hitches)



2. Insert the lease sticks into the warp.

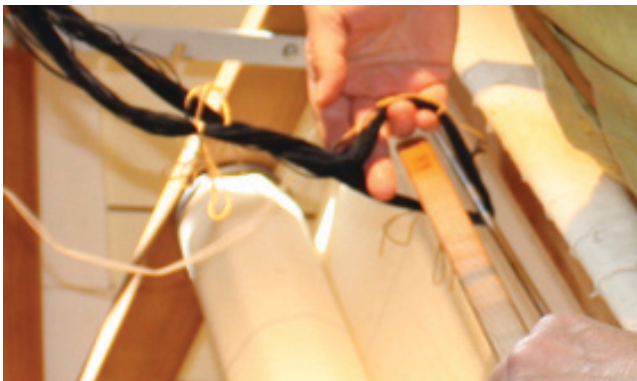

# Dressing the Loom with a Raddle:

## Threading Back to Front

2. Cont'd. Secure the lease sticks between the castle posts and back beam using cords attached to the castle uprights (down & down, up & up). Undo the ties that are securing the cross in the warp.

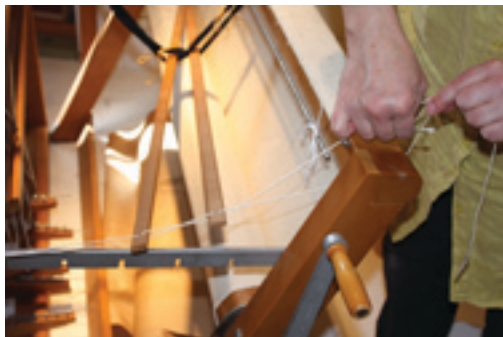

3. We mount our raddles to the top of the loom regardless of where the manufacturer suggests you put it.



# Dressing the Loom with a Raddle: Threading Back to Front



4. Spread your warp to the desired weaving width, distributing your warp threads evenly across the raddle. IMPORTANT: If you have warped with more than one thread, never split the thread groups going through the raddle!



5. Place an elastic band or tie string over the ends of the pegs or nails to prevent the threads from escaping. The warp should now run from the raddle to the rear of the loom in a straight line.





# Dressing the Loom with a Raddle: Threading Back to Front



6. Before rolling your warp on, it will be necessary to lash the warp rod to the apron rod to prevent the rods from bowing.



\*\*\*\*\*

**7. Move to the front of the loom where the warp chain is lying. Find a spot in the chain where no threads have been disturbed. Give the warp chain a good tug from this point as it will realign the warp displacement that may have occurred when spreading the warp across the raddle.**

\*\*\*\*\*



# Dressing the Loom with a Raddle: Threading Back to Front



8. Undo the warp chain and let it lie across the floor.



9. Roll the warp onto the warp beam feeding paper between the layers of warp. (For fine threads, paper provides a more even bed between the layers than warp sticks.) Remember to occasionally pull down on the paper to remove slack.



# Dressing the Loom with a Raddle: Threading Back to Front

10. Every 2 or 3 turns, return to the front of the loom and give the warp a good tug, straightening any threads that are out of line. REPEAT UNTIL WARP IS WOUND ON LEAVING ENOUGH TO THREAD AND SLEY.

