

# BALLAST WATER MANAGEMENT SYSTEMS



Proceedings of the Global R&D Forum on Compliance  
Monitoring and Enforcement  
The Next R&D Challenge and Opportunity

26-28 October 2011  
İstanbul, Turkey

Edited by  
Arzu Olgun  
Fatma Telli Karakoç  
Fredrik Haag

# BALLAST WATER MANAGEMENT SYSTEMS

Proceedings of the Global R&D Forum on Compliance Monitoring  
and Enforcement – The Next R&D Challenge and Opportunity

**26-28 October 2011**  
**İstanbul, Turkey**

Edited by  
Arzu Olgun  
Fatma Telli Karakoç  
Fredrik Haag

**A REPUBLIC OF TURKEY AND IMO-GLOBALLAST INITIATIVE**



**A TÜBİTAK MRC ENVIRONMENT INSTITUTE  
PUBLICATION IN COLLABORATION WITH THE GEF-  
UNDP-IMO GLOBALLAST PARTNERSHIPS PROGRAMME**

TÜBİTAK MRC  
PO. BOX. 41470  
KOCAELI-TURKEY

First published in Turkey in 2012

All papers Copyright © TÜBİTAK-MRC Publications 2012. The views expressed are those of the authors and do not necessarily reflect the view or policy of TÜBİTAK - MRC or the GEF-UNDP-IMO GloBallast Partnerships Programme. TÜBİTAK-MRC Publications and the Editors, while exercising the greatest care in compiling this volume, do not hold themselves responsible for the consequences arising from any inaccuracies therein.

All rights reserved. Except for quotation of short passages for the purposes of criticism and review, no part of this publication may be reproduced, stored in a retrieval system, or translated, in any form or by any means, electronic, mechanical, photocopying, recording or otherwise, without the prior permission of the publisher.

ISBN 978-975-403-730-2

Cover image provided by Onur Tan

English Edition by Stephanie Messina Dikeç

## CONTENTS

<b>Acknowledgements</b>	v
<b>Foreword</b>	vii
<b>Introduction</b>	xi
TÜBİTAK Marmara Research Center	
<b>Opening Addresses</b>	1
IMO- Marine Environment Division	
<b>Forum program</b>	7
<b>SELECTED CONFERENCE PAPER</b>	
Limitations with respect to vital staining techniques for use in treated ballast water	13
<i>August D. Tobiesen, Anne-Marie Bomo, Stephanie Delacroix, Aina C. Wennberg and Helge Liltved</i>	
Ecological risk of treated ballast water: a mesocosm experiment	21
<i>A.C. (Andrea) Sneekes, N.H.B.M. (Klaas) Kaag and E.M. (Edwin) Foekema</i>	
Technology of ship's ballast water treatment using ·OH radicals based on IMO Guidelines	31
<i>Mindong Bai, Nahui Zhang, Zhitao Zhang, Yiping Tian, Xiyao Bai</i>	
The forgotten fraction: The importance of organisms smaller than 10 µm when evaluating ballast water treatment systems	41
<i>Isabel van der Star, Viola Liebich, Peter Paul Stehouwer</i>	
ERMA first BWTS an integrated and modular ballast water treatment system. Performance and compliance with IMO guidelines	51
<i>Efi Tsolaki, Konstantinos Stampedakis, Yannis Moulinos, Nikos Kyritsis</i>	
Lab-Scale Chlorine Generation	67
<i>Ceren Bilgin Güney, Fatma Yönsel</i>	
A ballast discharge monitoring system for great lakes relevant ships: a method for researchers, ship owners, and agency officials	83
<i>Allegra Cangelosi, Tyler Schwerdt, Travis Mangan, Nicole Mays, Kelsey Prihoda</i>	

Sampling of ballast water for compliance control <i>Stephan Gollasch, Matej David</i>	109
Validation of a shipboard filter skid for sampling zoo plankton from ballast water <i>Matthew First</i>	115
Efforts to develop a ballast water detecting device <i>Goran Bakalar</i>	117
A portable, sensitive plankton viability assay for IMO shipboard ballast water compliance testing <i>Nick Welschmeyer, Brian Maurer</i>	127
Finalized methodology for risk assessment of active substances under procedure (G9) <i>Jan Linders</i>	141
Risk assessment for exemptions from BWM the Intra-baltic HELCOM study <i>Matej David, Stephan Gollasch, Erkki Leppäkoski</i>	151
Ballast Water Management in Turkey – an overview <i>Murat Korçak</i>	157
Biological efficacy of electrolytic BWMs (electro-cleen <sup>tm</sup> system) during on board installation <i>Yong Seok Park, Dong Hyun Shon, Gwang Ho Lee, Hyun Ju Moon, Hyung Geun Jeon</i>	171
Assessing of the Ballast Water Risk in Ceyhan Marine Terminal <i>Arzu Olgun, Aslı Suha Dönertaş, Cihangir Aydöner, Yasemin Gümüslüoğlu</i>	177
Closing remarks Mr. Espinoza Ferrey, Director, MED, IMO	185
Information about organizers	189

## **ACKNOWLEDGEMENTS**

This publication contains a selection of presentations and papers the IMO - GloBallast Global R&D Forum on Ballast Water Management “Compliance Monitoring and Enforcement: the Next R&D Challenge”, which was held in İstanbul, Turkey, on 26-28 October 2011.

Special thanks are owed to the partners and sponsors who made this event possible, in particular IMarEST, and ICS.

Our very special thanks go to the Mr. Jo Espinoza-Ferrey, Director, Marine Environment Division, IMO for their kind attention, contribution, welcoming addresses and his closing remarks to the Forum.

We would like to express our sincere gratitude to Dr. Özkan Poyraz, Mr. Ömer Tıktık and Mr. Murat Korçak from the Undersecretariat for Maritime Affairs (UMA) for all their valuable support and taking part in the organization process of the Forum.

Many thanks are also due to our colleagues for their hard work who supported the 2011 R&D Forum from IMO in particular Mr. Fredrik Haag, Ms. Aicha Cherif and Dr. José Matheickal, as well as Dandu Pughiuc. A special acknowledgement must go to the GloBallast Partnerships Programme of the IMO for their initiative in recognizing the possibilities for this Forum towards enhancing the momentum of the discussion on ballast water treatment and management systems.

In particular, we would like to thank the International Scientific Advisory Committee who aided into selecting the topics and the papers for the Forum; and of course, we would also like to thank every one of those thirty-five expert presenters for their addresses, presentations, and interventions in the discussions, as well as for their knowledgeable contributions of papers for publication in these proceedings.

We would like to express our heart-felt thanks to especially Dr. Özen Arlı Küçükosmanoğlu, Emrah Ali Pekdemir, İbrahim Tan and our friends in TUBITAK MRC Environment Institute for the great job they achieved in all the relevant activities. A special note of appreciation is also for Stephanie Messina Dikeç for her outstanding efforts in the linguistic edit work.

Arzu OLGUN, Ahmet BABAN  
TÜBİTAK MARMARA RESEARCH CENTER



## **FOREWORD**

Global R&D Forum on Ballast Water Management “Compliance Monitoring and Enforcement: the Next R&D Challenge” was held with the initiative of the GEF-UNDP-IMO Globallast Partnerships Programme, the TÜBİTAK Marmara Research Center (TUBITAK- MRC) and, the Turkish Undersecretariat for Maritime Affairs (UMA). The R&D Forum was held in İstanbul, Turkey on October 26 - 28. In conjunction with the Forum, two different workshops and conferences were held. The Forum was attended by more than 130 participants, representing technology developers, the maritime industry, academia, and the international and regional agencies from around the world and was considered a major success by forum participants.

The third meeting of the Global Expert Forum on Ballast Water Test Facility Harmonization was held on 24-25 October, continuing their discussions and efforts to further harmonize the approaches to testing and verifying ballast water treatment technologies. The Forum was also preceded by the 2nd IMO-IMarEST Shipbuilders’ Forum on Ballast Water Management on 25 October.

The R&D Forum itself focused on “Compliance Monitoring and Enforcement (CME) – the next R&D issue?”, and was opened by UMA, IMO and TUBITAK. The welcome speech on behalf of IMO was delivered by Mr Jo Espinoza-Ferrey, Director MED.

The welcome remarks were followed by keynote speeches. Ms. Theresa Crossley, Head of Implementation, European Maritime Safety Agency (EMSA) gave a keynote speech where she highlighted the EU agenda for invasive alien species and EMSA’s ballast water programme and research in terms of compliance. Mr. Alfonso Castellero, Director General, Merchant Marine, Panama Maritime Authority delivered a powerful speech ensuring the participants that Panama is committed to doing all it can, as quickly as it can, to address marine biosecurity issues in ways which will safeguard the shipping industry interests and deliver substantial net environmental benefit.



Over the three days of the Forum, a breadth of topics were presented, including the experiences from testing of technologies for compliance, Port State Control issues, an overview of current ballast water technologies and how these meet the compliance criteria, sampling and monitoring (including latest developments in rapid diagnostic tools), risk assessments and related tools in the CME framework, regional and developing country perspectives on CME, as well as the ship-owners' and shipbuilders' perspectives.

The busy agenda allowed almost every community to share their views and ideas on how to meet the challenge, but also their concerns and different perspectives. The Forum also illustrated the dedication of all those present from the shipping industry, academia and Administrations.

There were very informative presentations, followed by wide-ranging and active discussions, during both the plenary and panel sessions, that also addressed issues such as the challenge to meet the IMO Ballast Water Convention standards, compliance, and monitoring.

A total of 35 technical papers and 8 posters were presented over the three days, covering the testing of the technologies for compliance, port state control issues and experiences, risk assessments and related tools in the CME framework, sampling and monitoring, including latest developments in rapid diagnostic tools, performance of current technologies in meeting the compliance criteria, developing country perspective on CME, and compliance for alternative technologies.

The Forum concluded with a Panel discussion, highlighting the importance of the R&D efforts now that the entry into force of the BWM Convention is imminent, but also on the need for the technologies to be validated for ship use and for the receiving environment to be closely monitored. The Forum was also informed that the next R&D Forum will take place in Republic of Korea in October 2013, and that the next ICBWM (International Conference of Ballast Water Management) will take place in Singapore in November 2012.

Over the course of the three days, the significant progress made since the last R&D Forum, which was held in Malmö, Sweden, in January 2010, was apparent. For example, in early 2010 there were 7 ballast water treatment systems having received their Type Approval certificates. At the time of the meeting in Turkey, this had more than doubled (17 systems), with a further 30-40 systems in different stages of development. The theme of the Forum, taking a more in-depth look at the CME, was thus very timely. Even though challenges are undoubtedly still there as the field of ballast water management is still developing, the ever-growing pool of knowledge and experiences around the world is an encouraging sign that the global community is continuing to rise to the challenge, determined to work together to address the issue.

Solutions that cater to the various needs of the shipping industry are being developed, but what is now more needed than ever is to share the growing amount of operational experiences to overcome the remaining hurdles. We therefore believe that conferences and forums such as the IMO-GloBallast R&D Forum will therefore continue to provide a crucial platform for exchanging views and inspire constructive dialogue.

#### The Organizing Committee

Dr. Mustafa Tırıs  
Dr. Arzu Olgun  
Dr. Ahmet Baban  
Ms. Özen Arlı Küçükosmanoğlu  
Dr. Jose Matheickal

Dr. Özkan Poyraz  
Mr. Ömer Tıktık  
Mr. Murat Korcak  
Mr. Fredrik Haag  
Ms. Aicha Cherif



## INTRODUCTION

The increasing globalization of the world economy in recent decades has unavoidably spurred international trade. While this development has brought some favorable opportunities around the globe, it has caused some undesirable consequences. In this sense, one of the areas, in which international trade has raised concerns, has been environmental sciences. While the debates on this issue include a multidimensionality based on different interest groups within the field, certain adverse effects emerged are obviously undeniable. One of these effects which needs immediate policy attention on a global base appears to be the ballast water discharge of sea vessels.

As well known, maritime transportation constitutes a major part of international trade, particularly in terms of tonnage, and hence is an inevitable means for transferring goods. However, the sea vessels operating for this purpose throughout global waters do not only transfer goods, but also a variety of biological organisms including animals, plants and bacteria, some of which deteriorate the aquatic ecosystem. This unfavorable fact, unfortunately, is led by the ballast water taken in by ships for stabilization purposes, which is discharged upon the loading of cargo. Considering the huge amount of ballast water used by the sea vessels due to the significant volume of maritime trade, the danger posed for the planet is certainly nontrivial.

The main problem is that because the ballast water unintentionally transmits the species of a certain region to another one, the biological materials ending up alive at their new location can act in an invasive manner to reproduce and establish a population. Such behavior of those alien organisms poses a threat for the native ones, in terms of crowding-out or destruction, resulting in damage to the habitat they belong to.

Various studies have shown that thousands of different species are carried in ballast tanks, which significantly threaten the biodiversity in the seas around the globe. It is also underlined in these studies that the rate as well as the extension of the bio-invasions continue to increase, affecting not only the marine environment but also the human health, in an adverse manner. Hence, the problems caused by invasive species de-ballasted into new national

waters, have been experienced by many countries to date, including Turkey. In this regard, the research has revealed that Turkish coasts host 400 non-native species, a significant part of which was brought by ships. Among these, one of the biggest damages known so far was caused by the filter-feeding North American comb jelly, *Mnemiopsis leidyi* that depleted a considerable amount of native plankton stocks in the Black Sea, generating a major economic loss for the commercial fishery in the region.

Therefore, Turkey is quite familiar with and very conscious about the ballast water problem and considers it one of the key environmental priorities to be handled both at national and international levels, as the solution lies at the heart of global cooperation. That is why Turkey has completed a national initiative to address the related threat by commissioning a one million US Dollar project, which has been conducted with collaboration between the Undersecretariat for Maritime Affairs of Turkey (UMA) and the Scientific and Technological Research Council of Turkey (TUBITAK), with the purpose of producing a synergy to develop an operational ballast water management strategy and system in the country.

Within the framework of the project, an inventory of the maritime transport activities of the Turkish coasts has been developed in the form of a database system in order to determine the quantity and sources of the ballast water discharges at the Turkish ports. In this framework, all these ports have been subjected to a risk assessment process using the GloBallast Risk Assessment Methodology. Furthermore, a Geographical Information System (GIS) as well as an Invasive Species Database have been developed during the project period.

So, Turkey takes the issue seriously and keeps investing in the R&D activities in the field in order to offer effective solutions to the problem. In this regard, we gladly hosted the Global R&D Forum on Ballast Water Management in Istanbul in order to create a platform for international participants to discuss the related subjects ranging from treatment technologies to shipbuilding. As expected, it resulted in the following outcomes:

- ✓ Achieving close and fruitful collaboration among the scientists and administrators,
- ✓ Enhancing the awareness towards risks imposed by BW handling and transport,
- ✓ Providing the opportunity for the Turkish shipping sector to improve knowledge and make assessment and projection for the existing conditions and future needs,
- ✓ Disseminating innovative methodologies and technologies for ballast water monitoring and management,
- ✓ Adapting for the compliance of legislative issues and their relevant implementation practices.

Lastly, it is important to note that, Turkey has started the ratification procedure for the Ballast Water Convention and hence it is believed that the successful results of the Global R&D Forum on Ballast Water Management held in Istanbul would certainly have a positive impact on relevant developments. I am sure that this proceedings of the Forum will help disseminate the research results on recent developments in the area of ballast water management and benefit the scientists and researchers who try to bring solutions to the current issues.

**Prof. Dr. İbrahim Dinçer**  
**(Acting) President of TÜBİTAK MRC**



**Global R&D Forum on Ballast Water Management**  
**“Compliance Monitoring and Enforcement: the Next R&D Challenge”**  
**Istanbul, Turkey**  
**26-28 October 2011**

Opening address by Mr. Jo Espinoza-Ferrey  
Director, Marine Environment Division, IMO

Welcome to Turkey

Dr. Poyraz, Director General of the Undersecretariat for Maritime Affairs,  
Dr. Baban, Acting Director of Environment Institute, Marmara Research Center, TUBITAK,  
Distinguished Panel members, participants,  
Ladies and Gentlemen,

It is a great pleasure to be with you, here in Istanbul, for this fourth Global Research and Development Forum on Ballast Water Management.

Dear friends,

The news of the devastating earthquake in Eastern Turkey has filled all of us with great sadness, even as we rejoice for the safe discovery of survivors and for the courage and untiring determination of all those involved in the rescue operations.

On behalf of the Member States of the International Maritime Organisation, our Secretary-General, Mr. Efthimios Mitropoulos and all of us in the Secretariat, I wish to convey to the Government and people of Turkey, and especially to all those directly affected by the earthquake, our most sincere condolences and deep sympathy.

As you may know, IMO has arranged R&D conferences on Ballast Water Management for almost a decade – in fact, since 2002. The first two conferences focused on treatment technologies. Back then, what has now grown into an industry and global market of its own



was just in its infancy, and the R&D Fora held at IMO Headquarters were part of our strategy to assist in the research and development efforts that were starting to grow around the world.

The most recent and third R&D Forum was held in January 2010, hosted by the World Maritime University in Malmö, Sweden. That event focused on the *emerging alternative solutions* to ballast water management. During that wintery week in Malmö, participants were introduced to solutions such as variable buoyancy concepts, thermal systems applying retrieved heat, as well as single source systems to treat a variety of waste streams onboard, to mention but a few. During the pre-conference workshop, an open and constructive discussion took place on how to prove equivalency between systems approved under the G8 and G9 Guidelines of the Convention and these new, emerging ideas. Also, as a side-meeting to the R&D Forum, the world's test facilities for ballast water treatment systems met for the first time, to plant the first seeds for a global network on harmonization of testing procedures.

The third Forum emphatically demonstrated that the R&D community is ready to take on the challenge of meeting the needs of the shipping industry when it comes to adapting to the regulatory regime under the Ballast Water Management Convention. Since then, and although it is only 18 months ago, we have come even further; and it is most pleasing to be able to inform you that, during the sixty-second session of IMO's Marine Environment Protection Committee, which was held in July, earlier this year, the Committee endorsed a procedure for approving 'other methods' of ballast water management in accordance with regulation B-3.7 of the Convention. This will certainly open the door for new methods and concepts to prevent risks arising from the transfer of invasive species.

In addition, as of today, 17 treatment systems have received type approval under the G8 or G9 Guidelines, which means that there are indeed a variety of technologies out there to meet the demand from the shipping industry.

And not least, we now have 30 Parties to the Convention, which actually means that the only remaining hurdle for the Convention to enter into force is the tonnage criteria. The current contracting Parties represent 26.44% of the gross tonnage of the world's merchant shipping, whereas 35% is required for the Convention to enter into force. I, therefore, urge all of you in a position to do so, to promote the earliest possible ratification of the Convention by your Governments so that the benefits to the environment that it was designed to deliver can be attained expeditiously.

So, with this recent progress in mind, what are the next challenges facing us? Well, as we get closer to entry into force and countries prepare for implementation of the Convention, it is clear that there is a need to address the specific challenges of monitoring compliance with, and the enforcement of, the Convention. And, in this context, there is no doubt that the R&D community will be playing a pivotal role. This is exactly why we decided that the theme for this year's R&D Forum should be "Compliance Monitoring and Enforcement: the next R&D challenge and opportunity".

The R&D Forum relay baton has now been taken over by the Republic of Turkey, welcoming us to and hosting this year's Forum in the beautiful, historic and certainly maritime city of Istanbul. We are extremely grateful to our colleagues and friends in the Turkish Prime Ministry's Undersecretariat for Maritime Affairs and to TUBITAK, the Scientific and Technological Research Council of Turkey, who have worked very hard over the last six months or so to make this event possible. And our thanks go also to the ICS and IMarEST for their sponsorship of this week's activities.

But, even though the Forum starts today, there have already been plenty of activities earlier this week. On Monday and yesterday, the world's ballast water treatment test facilities convened for their third meeting. This is a unique and truly commendable effort, with those involved in the testing of treatment systems having recognized the need for a constructive and continuing dialogue on this issue, with a view to harmonize test procedures and reporting. Their aim is to set minimum testing standards and to strengthen cooperation and

exchange of information between the test facilities, in order to improve the comparison of testing and reporting of systems. This will both increase the buyers' confidence in the products and have positive impacts on comparison of the systems' performance, which will be highly relevant for compliance monitoring and enforcement. In their meeting over the last two days, representatives from Administrations and class societies were invited to discuss their experiences and needs on issues such as reporting of test results. The next step is to formalise this network through the signing of a MoU.

In addition to that activity, the second IMO-IMarEST Shipbuilders' Forum on Ballast Water Management has also been held here at this hotel. The intention of the Shipbuilders' Forum was to provide the latest information to shipbuilders and ship repair yards, in particular, on those issues in which they will play a crucial role, such as installation and retrofitting of ballast water treatment systems. This one-day Forum, therefore, saw presentations from ship owners, class societies, vendors of systems, IMO and IMarEST. Furthermore, it was an opportunity for useful, open dialogue among those that will be involved in the task of making sure that the world fleet is ready for the Convention requirements when it enters into force.

So the week has already gotten off to a flying start, and we have a very busy programme for the next three days. We will have the opportunity to discuss issues such as testing for compliance, experiences with port State control, the current state when it comes to ballast water treatment technologies, latest developments on sampling and monitoring and, not least, the developing country perspective.

Ladies and gentlemen,

Before the detailed technical sessions start, you will have the opportunity to listen to the views of three keynote speakers - three extremely relevant perspectives on the Ballast Water Management Convention delivered by Mr. Dandu Pughiuc from IMO, Ms. Theresa Crossley from the European Maritime Safety Agency (EMSA) and Mr. Alfonso Castellero from the Directorate of Merchant Marine, in the Panama Maritime Administration. Providing you with

views from the global, regional and national levels, I am sure that these three speakers will give us an excellent backdrop for the presentations and discussions that follow.

Fellow participants, I certainly look forward to the debates and exchange of ideas and views that lie ahead of us in the next three days, and I am sure you do, too.

So, on behalf of IMO, and with renewed thanks to the Government of Turkey and TUBITAK for hosting what promises to be a most stimulating event, I hereby welcome you to the fourth IMO-GloBallast R&D Forum on Ballast Water Management, and I wish you a great conference!

Or, as they say over here, "İstanbul'a hoşgeldiniz ve bu konferansa hoşgeldiniz".

Thank you.



## FORUM PROGRAM

### Tuesday 25 October

- 08.30 - 09.00 Registration
- 09.00 – 09.15 Welcoming remarks  
UMA, TUBITAK-MAM, IMO-GloBallast and IMarEST
- 09.15 – 09.45 Introduction: The regulatory framework - the Ballast Water Convention and its implication for shipbuilders and repair yards  
Jose Matheickal, IMO-GloBallast
- 09.45 – 10.30 Keynote address: Ship-owners Perspectives on Ballast Water Management Options: Experiences and concerns  
William Nugent, OSG
- 10.30 – 11.00 Coffee break
- 11.00 – 11.45 Ballast Water Treatment Technologies - Technical considerations, experiences and concerns in retrofitting and new-builds  
Jad Mouawad, DNV
- 12:30 – 14.00 Lunch break
- 14.00 – 14.45 BWM Technologies – Remaining scientific and technological challenges  
David Wright, IMarEST and Jim Mackey, Hyde Marine
- 14.45– 15.30 Challenges of installing Ballast Water Treatment Systems on large vessels, such as tankers and in Explosion Zones  
Leif Erik Caspersen, OceanSaver AS
- 15.30– 16.00 Coffee break
- 16.00– 16.30 Class society perspectives on survey and certification  
Jad Mouawad, DNV
- 16.30 – 17.00 Discussion: Do the current solutions address the industry needs and concerns? Opportunities and challenges ahead for shipyards and shipbuilders

### Day 1 – Wednesday 26 October

#### Opening Session

- 09:00-10:00 Registration and refreshments
- 10:00-10:15 Welcome from the organizers  
Undersecretariat for Maritime Affairs of Turkey, TUBITAK-MAM and IMO-GloBallast

## FORUM PROGRAM

- 10:15-10:30      Opening address  
Jo Espinoza-Ferrey, Director, Marine Environment Division, International Maritime Organization (IMO)
- Plenary keynote session  
Moderator Jose Matheickal, Chief Technical Adviser, GloBallast Partnerships, IMO
- 10:30-11:00      Keynote address  
Dandu Pughiuc, Head, Biosafety Section, IMO
- 11:00-11:30      Keynote address  
Theresa Crossley, Head, Implementation Department, European Maritime Safety Agency
- 11:30-12:00      Keynote address  
Alfonso Castillero, Director, General Directorate of Merchant Marine, Panama
- 12:00-12:30      Q&A with keynote speakers  
12:30-14:00      Lunch break
- 14:00-15:30      **Session 1: Testing of technologies for compliance**  
Moderator: Mario N. Tamburri, MERC, United States

Session keynote: Testing of technologies and the emerging global network of test facilities, including a report from the 3rd Global Test Facility Forum

Sjur Tveite, NIVA, Chairman of the Global Network of Test Facilities, Norway

Harmonisation of testing regimes – comparability of testing in tropical and temperate climates

Martin Andersen, DHI Ballast Water Technology Innovation Centre, Singapore

Improved procedures for sampling and analysis of disinfection by-products and toxicological parameters of treated ballast water

Stephanie Delacroix, NIVA, Norway

Limitations with Respect to Vital Staining Techniques for Use in Treated Ballast Water

Anne Maria Bono, NIVA, Norway

Ecological risk of treated ballast water: a mesocosm experiment

Andrea Snakes, IMARES, Netherlands

Technology of ship's ballast water treatment using •OH radicals based on IMO Guidelines

Mindong Bai, Dalian Maritime University, China

The importance of organisms smaller than 10 um

Isabel van der Star, Viola Liebig and Peter Paul Stehouwer, NIOZ, Netherlands

### **Session 2: Port State Control issues and experiences**

Moderator: Murat Korçak, UMA, Turkey

Session keynote: Key aspects of Port State Control under the BWM Convention

Raphael Baumler, World Maritime University

## FORUM PROGRAM

A Proposed Framework for Compliance Monitoring of Ballast Water Discharge Regulations

Mario N. Tamburri, MERC, United States

The Occurrence of Pathogenic Bacteria in Some Ships' Ballast Water Coming from Various Marine Regions to the Sea of Marmara, Turkey

Gülşen Altuğ, Istanbul University, Turkey

An Examination of the Practicalities of Compliance Monitoring and Enforcement

Jon Stewart, International Maritime Technology Consultants, United States

### Day 2 – Thursday 27 October

#### 09:45-10:30 Session 3: Overview of current ballast water technologies: meeting the compliance criteria

Moderator: Allegra Cangelosi, GSI, United States

Session keynote: Overview of current technologies

Graham Greensmith, Lloyd's Register, United Kingdom

Type approval of BW treatment systems – experiences

Jad Mouawad, DNV, Norway

ERMA FIRST ballast water treatment system: an integrated and modular ballast water treatment system. Performance and compliance with IMO Guidelines

Efi Tsolaki, ERMAFIRST ESK Engineering Solutions S.A.

Ballast Water Treatment Solution From Turkey "Akballast TM "

Bülent İşmen, AK Gemi Company, Turkey

The second generation of Ballast water treatment systems

Leif Erik Caspersen, OceanSaver AS, Norway

Lab-Scale Chlorine Generation

Ceren Bilgin Güney, Fatma Yonsel Department of Shipbuilding and Ocean Engineering, Istanbul Technical University, Istanbul, Turkey

#### Session 4: Sampling and monitoring, including latest developments in rapid diagnostic tools

Moderator: Jan Linders, GESAMP BWWG Chair, and Brian Elliot, EMSA (TBC)

Session keynote: Sampling aspects for CME under the BWM Convention

Brian Elliot, EMSA

Great Ships Initiative Sampling Systems for Land- and Ship-based Ballast Water Treatment System Performance Testing

Allegra Cangelosi, GSI, United States

Sampling of ballast water for compliance control and Possible tools for organism detection in ballast water samples

Stephan Gollasch, GoConsult, Germany



## FORUM PROGRAM

Validation of a shipboard filter skid for sampling zoo plankton from ballast water  
Matthew First, SAIC Inc, Naval Research Laboratory, United States

Efforts to develop a ballast water detecting device  
Goran Bakalar, Maritime Consultancy, Croatia

Evaluations of Total Residual Oxidant Technologies for use in Monitoring Ballast Water Treatment System

Amy Zimmer Faust, Maritime Environmental Resource Center, University of Maryland, United States

Updated Experiments using a portable imaging instrument as a rapid diagnostic tool for IMO Indicative monitoring compliance for BWTS  
Kent Peterson, FlowCam, United States

A portable, sensitive plankton viability assay for IMO shipboard ballast water compliance testing.  
Nick Welschmeyer and Brian Maurer, United States

### **Day 3 – Friday 28 October**

**09:45-10:30      Session 5: Risk assessments and related tools in the CME framework**

Moderator: Adnan Awad, IOI

Session keynote: The Turkish approach to Risk Assessments  
Arzu Olgun, Emrah Ali Pekdemir TUBITAK, Turkey

Finalized methodology for risk assessment of active substances under procedure (G9)  
Jan Linders, National Institute for Public and Environment-Expert Centre for Substances, Netherlands

Ballast water management related risk assessment – The intra-Baltic HELCOM study  
Erkki Leppäkoski, Akademi University, Turku, Finland

### **Session 6: Regional and developing country perspectives on CME**

Fredrik Haag, GloBallast Partnerships, Marine Environment Division, IMO

Session keynote: The role of/experiences with Port Biological Baseline Surveys in developing countries  
Adnan Awad, International Ocean Institute Southern Africa

Ballast Water Management in the Wider Caribbean Region: Progress and Challenge  
Andrew Wood, RAC-REMPEITC-Carib

Ballast Water Management in Turkey – an overview  
Murat Korcak, Undersecretariat for Maritime Affairs of Turkey

### **Session 7: The ship-owners' and shipbuilders' perspectives**

Moderator: Dandu Pughiuc, IMO

Session keynote: Technical issues for selection of a ballast water system for an Aframax tanker  
Vayia Hatziyianni and Maria Sotiriou, OSG

## FORUM PROGRAM

### Q&A session

15:00-16:00 Plenary session - Panel Discussion

Compliance and monitoring: Are the current R&D efforts matching requirements of the Convention?

Moderator: Jose Matheickal, IMO/GloBallast

### Closing remarks

Mr. J. Espinoza-Ferrey, Director, Marine Environment Division, IMO, and Undersecretariat for Maritime Affairs of Turkey, TUBITAK-MAM

Forum closes

### POSTER PRESENTATIONS

Analysis Of Active Substance And Relevant Substance in Ship's Ballast Water Management (BWM) System

Ji Hyun Lee, Young Keun Im, Dong Yoon Kim, Jin Hoon Do, Jun Ho Park, Sung Uk Lee, Won Tae Cho

Effects of Fresh Water Electrolysis On Algal Growth Eunjoo Choi, Sojung Jung, Yongseok Park, Myung Hwan Do, Kyung Soon Shin, Kitate Rhie

Biological Efficacy of Electrolytic BWMs (Electro-Cleen Tm System) During on Board Installation  
Yong Seok Park, Dong Hyun Shon, Gwang Ho Lee, Hyun Ju Moon, Hyung Geun Jeon

Harmful Algal Species in Anthropogenically Impacted Water of The Syrian Coastal Waters  
Feirouz Darwich

Ballast Water Risk Assessment System–Alien Species Module

Arzu Olgun, Özen Arlı Küçükosmanoğlu, Tolga Atalay, Fatma Telli Karakoç, Vildan Tüfekçi

Ballast Water Risk Assessment System–Ballast Water Reporting Module

Emrah Pekdemir, Arzu Olgun, Tolga Atalay, Cihangir Aydoğan

Assessing of the Ballast Water Risk and the Alien Species in Iskenderun Bay, Turkey

Arzu Olgun, Aslı Suha Dönertaş, Cihangir Aydoğan, Yasemin Gümüşlüoğlu

Ballast Water Risk Assessment System – Risk Assessment and Route Analysis Module

Cihangir Aydoğan, Arzu Olgun, Tolga Atalay, Onur Akyol, Emrah Pekdemir, Özen Arlı



## Limitations with Respect to Vital Staining Techniques for Use in Treated Ballast Water

August D. Tobiesen<sup>1</sup>, Anne-Marie Bomo, Stephanie Delacroix,  
Aina C. Wennberg and Helge Liltved

---

### Abstract

*Staining cells in the  $\geq 10\text{-}50\ \mu\text{m}$  size group in treated ballast water with the vital stain 5-carboxyfluorescein diacetate acetoxymethyl ester (CFDA) has been used to detect viable cells. In intact viable cells, the non-fluorescent CFDA will be taken up in the cytosol, where it becomes hydrolysed into fluorescence end products. Viable cells can be identified and distinguished from dead cells by studying the stained sample with an epifluorescence microscope. Some limitations with this method have been observed during full-scale land-based testing of UV treatment systems. Determination of viable cells in the 10-50  $\mu\text{m}$  size group using the CFDA method seems to overestimate the number of viable cells compared to results based on plate counts and dilution cultures, the two latter techniques being a direct measurement of the cells ability to reproduce. In an attempt to investigate the consistency between the three methods (CFDA staining technique, plate counts and dilution culture) on UV-treated samples, some preliminary laboratory-scale experiments were carried out, where the algae, *Tetraselmis suecica*, in seawater was treated with different UV doses and viability in samples quantified using CFDA staining, plate counts and dilution culture. The results were compared with a parallel study where *Tetraselmis suecica* was treated with ozone doses in the range of 0 – 180 mg TRO\*s/l using the same three methods. The results from the study with ozone gave more consistent results between CFDA and the culture-based methods. For UV-treated water, large deviations were observed at UV doses up to 600 mWs/cm<sup>2</sup>. At higher UV doses (i.e. up to 2400 mWs/cm<sup>2</sup>), consistency among the methods was evident. However, such high dosages are not used for ballast water treatment.*

*Based on these results, one may conclude that staining techniques may overestimate viability in UV-treated samples compared to cultivation methods. Additionally, staining procedures should be amended to incorporate the time needed for UV treatment to manifest itself. It may be suggested that methods based on cell cultivation are more reliable with respect to the organisms ability to reproduce and should be used for evaluation of long-term viability of algae in UV-treated water, either alone or complementary to staining methods for organisms that are not easily cultivated in the laboratory.*

**Key words:** viable stain, enumeration, algae, ballast water

---

<sup>1</sup> Norwegian Institute for Water Research, Gaustadalleen 21, 0349 Oslo, Norway

## Introduction

The introduction of invasive marine species into new environments by ships' ballast water has been identified as having serious impacts on the marine ecology of the world's oceans. The International Convention for the Control and Management of Ships' Ballast Water & Sediments was adopted by the International Maritime Organization (IMO) in 2004. The IMO convention sets discharge limits on densities of live organisms by size class of organisms. For instance, for organisms in the size group  $\geq 10\mu\text{m}$  and  $< 50\mu\text{m}$ , discharge water should contain less than 10 viable organisms per milliliter ( $< 10$  cells/ml). To comply with the discharge limits by IMO, this implies that the world's fleet must invest in approved technology for treatment of their ballast water before discharge.

Since the success of a treatment system and the ability of a ship to meet the ballast water discharge standards are determined by the number of viable organisms in treated water, general methods are required that can be used to detect these living organisms at low densities in treated water.

Common methods for analyzing and quantifying organisms in the 10-50  $\mu\text{m}$  range are measuring chlorophyll, culture dependent methods (dilution culture, plate counts), ATP assays, flow cytometry and direct counts and/or in combination with fluorescent vital stains (Garvey *et al.*, 2007; Reavie *et al.*, 2010; Steinberg *et al.*, 2011a; Steinberg *et al.*, 2011b). Vital staining methods with different fluorescent stains (i.e. FDA, CFDA, CFDMA), either alone or in combinations, have been emphasized as suitable methods for detecting living organisms in the 10-50  $\mu\text{m}$  range in treated ballast water (Reavie *et al.*, 2010, Steinberg *et al.*, 2011b). One fluorescent staining method for detecting viable cells in the  $\geq 10$ -50  $\mu\text{m}$  size group in ballast water is to incubate samples with 5-carboxyfluorescein diacetate acetoxymethyl ester (CFDA) and study the stained cells with an epifluorescence microscope (Ganassin *et al.*, 2000). In intact viable cells, the non-fluorescent CFDA will be taken up in the cytosol, where it becomes hydrolysed into fluorescence end products. Viable cells can be identified and distinguished from dead cells as viable cells are a bright yellow/green colour, while non-viable cells are pale green (heterotrophic cells) or pale green with red autofluorescence of the chloroplast (photoautotrophs).

Since 2006, numerous ballast water management systems have been tested through land-based testing at NIVA's (Norwegian Institute for Water Research) test facility for ballast water management systems in Solbergstrand, Norway. Documentation of viable organisms in the 10-50  $\mu\text{m}$  size group are performed using the CFDA staining technique. In addition, standard culture techniques such as dilution cultures and plate counts are always conducted as a supplement to the CFDA staining technique. However, when performing land-based tests on technologies that utilize UV irradiation, the CFDA staining technique has been shown to

## LIMITATIONS WITH RESPECT TO VITAL STAINING TECHNIQUES

overestimate the number of viable cells relative to complimentary methods used that are based on regrowth (i.e organism concentration in treated water being higher than the discharge requirement (>10 cells/ml), and the results using the CFDA method deviating from results based on plate counts and dilution cultures (cell concentration <10 cells/ml)). The consequences of not fulfilling the discharge requirements can be disqualification of test cycles, possibly leading to non-approval of the treatment system by national administrations and IMO.

In an attempt to better understand the extent of these observations from land based testing (i.e. to investigate the consistency of the three methods (CFDA staining technique, plate counts and dilution culture) on UV treated samples and to assess to what extent the UV dose applied could impact the deviating results), some preliminary laboratory-scale experiments were carried out where the algae *Tetraselmis suecica* in seawater was treated with different UV doses and living cells were quantified using CFDA staining, plate counts and dilution culture. As a comparison to UV treatment, quantification of *Tetraselmis suecica* with the same three methods was also conducted in ozone treated seawater.

The algae *Tetraselmis suecica* from NIVAs algae culture collection was used as the test organism in all laboratory experiments. *Tetraselmis suecica* was grown autotrophically in seawater growth media with added nutrients and harvested in the exponential phase. Cell density was determined using a Beckman Coulter "Multisizer 3" coulter counter. In case of too dense cell cultures, the algae solution was mixed with 0.45µm seawater (salinity > 32 PSU). Initial concentrations of algae in all experiments were 10<sup>4</sup> - 10<sup>5</sup> cells/ml.

## Materials and Methods

### Test organisms

The algae *Tetraselmis suecica* from NIVA's algae culture collection was used as the test organism in all laboratory experiments. *Tetraselmis suecica* was grown autotrophically in seawater growth media with added nutrients and harvested in the exponential phase. Cell density was determined using a Beckman Coulter "Multisizer 3" coulter counter. Where cell cultures were too dense, the algae solution was mixed with 0.45 µm seawater (salinity > 32 PSU). Initial concentrations of algae in all experiments were 10<sup>4</sup> - 10<sup>5</sup> cells/ml.

### UV-irradiation

Algae solutions (15 ml) were added to Petri dishes and slowly stirred during UV irradiation. The UV lamp used was a 15 W (3.5 W of 254 nm UV output), low pressure, germicidal lamp (Philips Ltd, Eindhoven, Netherlands) mounted in an apparatus which provided a collimated

beam (Qualls and Johnson, 1983). The UV dose, defined as the product of average intensity across the Petri dish and the exposure time, was varied by varying the exposure time. UV doses ranging from 0 (control) to 2400 mWs/cm<sup>2</sup> were applied in the experiment.

#### Ozonation

Ozone was produced in an ozone generator (Wedeco Modular 8 HC). An ozone stock solution (8 mg/l TRO) was made by bubbling ozone produced by the ozone generator into a bottle of 0.45µm filtered seawater (32 PSU). Aliquots of this stock solution were diluted with seawater and algae to achieve ozone doses of 0 (control), 24, 60, 120 and 180 mg TRO\*s/l. Ozone concentration was measured using the colorimetric DPD method (Hach method 8167), and ozone doses were defined as the product of measured TRO concentration (TRO as mg/l Cl<sub>2</sub>) in the ozonated seawater and algae mixture, and contact time (two minutes). After two minutes of contact time, all samples were neutralized with natriumthiosulphate prior to being analyzed.

#### **Determination of viable *Tetraselmis suecica* after treatment**

##### **Cultivation on agar plates**

Samples were spread on a seawater agar growth medium and incubated in constant light for 3-7 days at 20 °C. Colonies of *Tetraselmis suecica* were observed by viewing agar plates in a stereo microscope at 160x magnification.

##### **Dilution culture method (after Throndsen, 1978)**

Sample volume of 1 ml was added to 9 ml of media (20 % Z8 seawater media). After mixing, 1 ml of this sample was further diluted with 9 ml. The number of dilutions was set to cover the expected cell density range in the original sample. Three to five parallels were employed in order to provide statistical significance of the estimated number. Test tubes were incubated in constant light for two weeks at 20°C. After two weeks, positive test tubes (i.e. tubes where growth occurred) were counted. Based on this, the number of cells in the original sample was calculated.

##### **CFDA staining (after Ganassin et al., 2000)**

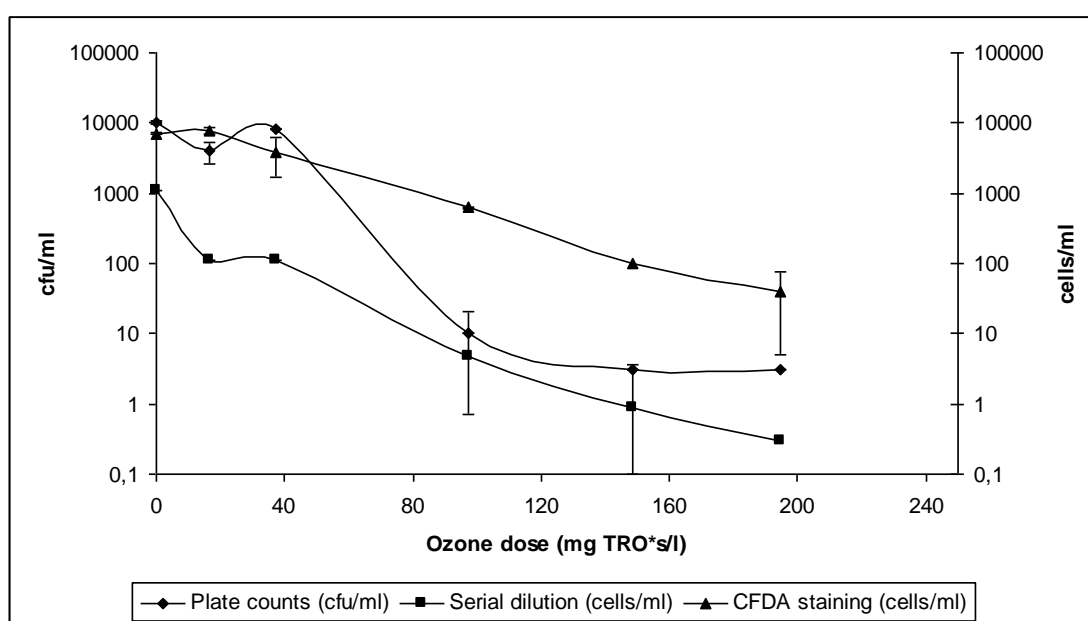
The viability of the *Tetraselmis suecica* was determined by observing cells incubated with CFDA. Samples were inspected with an epifluorescence microscope using an excitation filter of 485 nm and an emission filter of 530 nm. In the epifluorescence microscope, viable cells were observable as bright yellow/green cells, while non-viable cells were pale green (heterotrophic cells) or pale green with red autofluorescence of the chloroplast (photoautotrophs). Cells were counted at 300x – 480x magnification.

## LIMITATIONS WITH RESPECT TO VITAL STAINING TECHNIQUES

UV treated samples were stored for 24 hours at 4°C in the dark before staining with CFDA. Ozonated samples were stained with CFDA on the same day as ozone treatment was performed.

### Results and Discussion

Results from the study with ozone doses in the range of 0 – 180 mg TRO\*s/l showed that enumeration of algae cells with the CFDA staining method was consistent with the culture based methods (Figure 1).

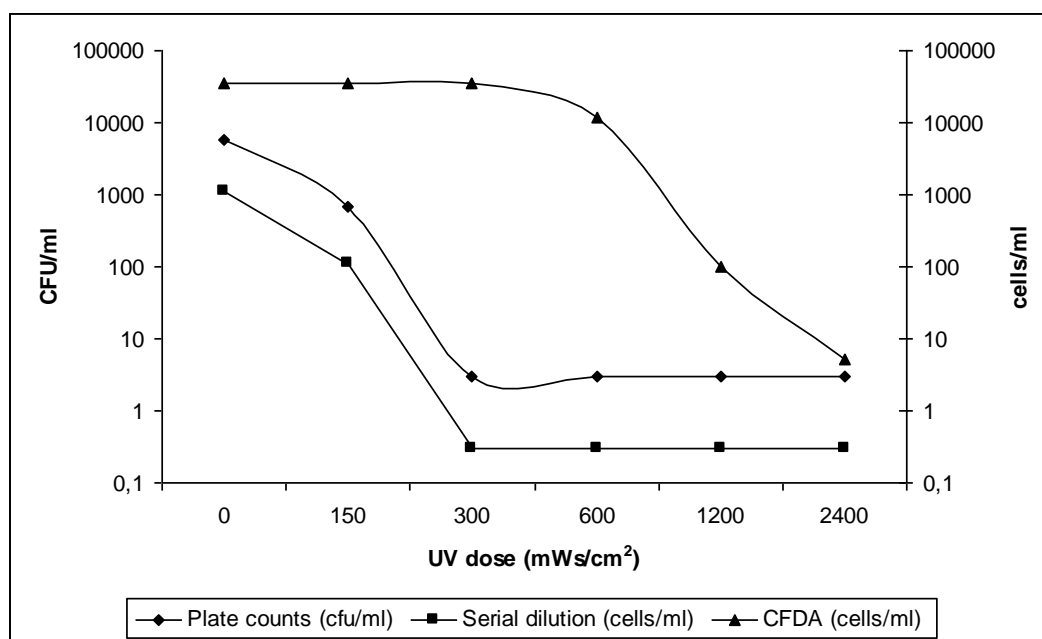


**Figure 1. Quantification of ozonated algae cells (*Tetraselmis suecica*) using plate counts, dilution culture and CFDA staining.**

Ozone is a strong oxidizing agent and will cause rapid damage to the cell membrane with leakage of cellular constituents when the dose is high enough. It was, therefore, expected that it should be easier to distinguish between dead and live cells when enumeration with the CFDA staining method, and that the results based on CFDA staining should be consistent with methods based on cell cultivation. When using the same three methods for enumeration of live algae in UV treated water, significant deviations were observed for UV doses up to 600 mWs/cm<sup>2</sup> (Figure 2). The vital staining method is based on cell activity, which depends on a non-damaged cell membrane and the presence of necessary enzymes. As the principal effect of UV irradiation is damage of the cells' DNA or RNA, which, in turn, blocks replication of nucleic acids and prevents cell multiplication, the cell membrane and enzyme activity can be intact for several hours, or even days after treatment. Such cells can still take up and



hydrolyse CFDA, and may give false positive counts. This is apparently the reason for the deviating results, as seen in Figure 2. At higher UV dosages (i.e. up to 2400 mWs/cm<sup>2</sup>) consistency among the methods was more evident. At the highest UV dose, no living cells could be detected, neither with the culture dependent methods (all results below the detection limit of the methods) nor with the CFDA staining method. It should be noted, however, that UV doses as high as 2400 mWs/cm<sup>2</sup> are not used in ballast water treatment. UV doses necessary to inactivate marine organisms in the 10-50 µm size group does not normally exceed 300 mWs/cm<sup>2</sup>.



**Figure 2. Quantification of UV irradiated algae cells (*Tetraselmis suecica*) using plate counts, dilution culture and CFDA staining.**

The results from these preliminary experiments using the CFDA staining technique shows an initial weak efficacy of UV treatment, when cells are exposed to UV irradiation dosages that do not immediately kill the cells. We, therefore, conclude that the CFDA method will overestimate the number of viable cells, especially if the period following UV treatment before staining with CFDA is short.

Hence, the methods based on cell cultivation should be regarded as more reliable with respect to *Tetraselmis suecica* and should be used as complementary methods for the evaluation of long-term viability of UV irradiated cells. Experience from land-based testing at NIVA have shown that the CFDA method and also the complementary methods based on regrowth become more consistent if CFDA staining is delayed for some time after UV treatment. With awareness of the limitations with culture dependent methods, in particular,

## LIMITATIONS WITH RESPECT TO VITAL STAINING TECHNIQUES

the fact that culture media will only support the growth of some organisms and not the entire plankton community, underestimation of cell number is a consequence. When estimating viability in UV treated water, it has, therefore, been decided to use all three methods (CFDA staining, plate counts and dilution culture) for quantification of organisms in the 10-50 µm size group during land-based testing of UV ballast water treatment systems at NIVAs test facility.

The problem addressed in this paper is limited to our experience with *Tetraselmis suecica* as a test organism and should be further explored using natural organisms in the 10-50 µm size group.

## REFERENCES

*Ganassin, R.C., Schrimmer, K. and Bols, N. (2000) Cell and Tissue culture. In: Ostrander, G.K (ed): The laboratory fish. Academic Press, San Diego, pp. 631-651.*

*Garvey, M., Moriceau, B. and Passow, U. (2007) Applicability of the FDA assay to determine the viability of marine phytoplankton under different environmental conditions. Marine Ecology Progress Series, 352, 17-26.*

*Reavie, E.D., Cangelosi, A.A. and Allinger, L.E. (2010) Assessing ballast water treatments: Evaluation of viability methods for ambient freshwater microplankton assemblages. Journal of Great Lakes Research, 36, 540 – 547.*

*Steinberg, M.K., First, M.R., Lemieux, E.J., Drake, L.A., Nelson, B.N., Kulis, D.M., Anderson, D.M., Welschmeyer, N.A and P.R., Herring (2011a) Comparison of techniques used to count single-celled viable phytoplankton. Journal of Applied Phycology.*

*Steinberg, M.K., Lemieux, E.J. and Drake, L. (2011b) Determining the viability of marine protists using a combination of vital, fluorescent stains, Marine Biology, 158, 1431 – 1437.*

*Thronsdon, J. (1978), The dilution-culture method. In: Sournia, A. (Ed): Phytoplankton manual. Unesco, Paris, pp. 218 – 224.*



## Ecological risk of treated ballast water: a mesocosm experiment

A.C. (Andrea) Sneekes<sup>1</sup>, N.H.B.M. (Klaas) Kaag, E.M. (Edwin) Foekema

---

### **Abstract**

*As a consequence of the IMO Ballast Water Convention, in the near future, large amounts of water treated with an active substance will be discharged into harbours and coastal areas. With regard to the ecological risk assessment of active substances used in ballast water treatment systems, mesocosms may be applied. Routinely, mesocosms are applied as 'higher tier tests' in the ecological risk assessment of pesticides. For ballast water testing, adaptation of the test set-up is necessary, as not a small amount of a toxic substance is added, but rather, a significant volume of water is replaced.*

*During spring 2011, such an experiment was conducted in 4-m<sup>3</sup> outdoor marine mesocosms with PERACLEAN Ocean® as the active substance. Three different treatment levels were created by replacing 10% of the volume of test systems with treated ballast water aged for 1 hour (BW-d0), 24 hours (BW-d1) or 5 days (BW-d5). Two control systems did not receive any treatment. At the same time, the toxicity of the ballast water was tested with standard laboratory bioassays confirming earlier test results. During the 69-day exposure period, the water compartment was sampled weekly. At the end, the test systems were drained and the bottom compartment was sampled.*

*The results show that replacement of water without remaining active substances is not free from effects. However, the level of toxic substances present in the treated water corresponded with the degree of impact. Effects seen in bioassays are not directly copied in mesocosms. Results might be affected by physical characteristics like pH, oxygen, DOC and nitrogen or phosphorus levels. However, high risk indicated by the toxicity tests corresponded with high levels of disturbances in the ecosystem. Mesocosms can be used in higher tier assessment of whole effluents, such as ballast water. Even when as much as 10% of the water volume is replaced by treated water, treatment effects are obvious. Moreover, clear recovery of some systems was observed within the test period enabling to assess the No Observed Ecological Adverse Effects Concentration (NOEAEC) conform to De Jong et al. (2008). The mesocosms are a useful tool for assessment of treatments, including the side effects, in discharged ballast water, by integrating effects as well as recovery of multiple interacting species.*

---

### **Introduction**

For ballast water treatment systems that use active substances, there is a need to test their system under IMO guideline G9. This guideline asks for estimating the ecological risk of the

---

<sup>1</sup> IMARES Wageningen UR, Dept. Environment. P.O. Box 57, 1780AB Den Helder, the Netherlands.

active substance used in the BWMS [Ballast Water Management System] for the receiving environment. Toxicity tests the so-called bioassays, need to be conducted to estimate the ecotoxicological impact of the treatment on the environment. A bioassay is a test in which an organism is exposed to a series of concentrations of a substance or to whole effluents (WET-testing), like discharged ballast water. A batch of these tests, including different trophic levels of organisms like algae, crustacean and fish, are used to assess the risk of treated ballast water in a harbor.

However, there is a large difference between the limited organisms used in bioassays when compared to the vastness and complexity of a harbor, not to mention the extensive variations in the different harbors around the world. Therefore, results from these single species tests must to be used with caution. In the risk assessment, this is done by using safety or assessment factors (Table 1).

**Table 1. Assessment factors for risk assessment of ballast water under IMO G9, as presented by GESAMP in the 38<sup>th</sup> meeting.**

Assessment factor	GESAMP 38 <sup>th</sup> meeting (PNEC general)
10,000	Lowest short-term L(E)C50 from 1-2 fresh/marine species from one or two trophic levels
1,000	Lowest short-term L(E)C50 from 3 fresh/marine species representing three trophic levels
100	Lowest short-term L(E)C50 from 3 fresh/marine species representing three trophic levels + 2 additional marine species
100	1 chronic NOEC from fresh/marine species but not algae
50	2 chronic NOEC from fresh/marine species including algae representing two trophic levels
10	3 chronic NOEC from fresh/marine species including algae representing three trophic levels

If limited information is available, the uncertainty is higher, and for translation to ecosystem levels, a higher safety factor is used. As more information is gathered, the safety factor can be lowered. Nonetheless, as long as only single species tests are used and considered, it is difficult to translate the effects to an ecosystem where various populations interact.

For (non-) agricultural biocides, this problem was recognized, and experimental ecosystems (mesocosms) with multiple species have been developed. These mesocosms allow the fate and impact of a treatment on the ecosystem to be examined under longer-term controlled, but realistic (semi-natural) conditions. In the legislation procedure of biocides, mesocosms are well accepted tools, and data can overrule toxicity data derived from single species laboratory

tests. These mesocosm tests are all performed in stagnant fresh water systems and dosed with an active substance. More recently, IMARES developed marine stagnant systems and tested these systems with additions of substances. Applicability for use with effluents like ballast water discharge was not investigated yet. The replacement of a portion of water may, in itself, already cause multiple effects. Therefore, as part of the InterregIVb project called “North Sea Ballast Water Opportunity” (NSBWO), the applicability of mesocosms for use in whole effluent testing was investigated. This pilot study was designed to try to answer two research questions:

- How can the effects caused by replacement of water and the effects of toxic substances be discriminated?
- How predictive are toxicity test results (i.e. bioassays) for the effects of treated ballast water on ecosystems?

### **Materials and Methods**

The mesocosms that were used for this study were intended to mimic a shallow, soft sediment ecosystem as much as possible. This type of ecosystem is common along the whole European coast. The mesocosms, however, are static, whereas the “real” ecosystem is characterised by a high rate of water refreshment. It was decided, however, not to use flow-through mesocosms for this test in order to allow a good determination of the fate of the treatment. In total, eight tanks were selected for this pilot study. Each circular tank had a volume of 4 m<sup>3</sup>. The tanks were filled with a sediment layer and a water compartment. Phyto- and zooplankton were introduced with the test water at the start of the establishment phase. Lists of species representative for various taxonomic classes that are commonly present in shallow, soft sediment coastal ecosystems were introduced deliberately. Sponges and bivalves both use phytoplankton as their primary food resource. For the bivalve species, the sediment dwelling cockle was selected. Two gastropod species were introduced; the small mudsnail and the larger periwinkle. Both species feed mainly on benthic algae; but the mudsnails live on the sediment surface, while periwinkles prefer the solid substrate of the mesocosm sides. As a representative of the group of crustaceans larger than zooplankton, the mudshrimp was introduced. This shrimp lives in the top layer of the sediment where it feeds on organic material. Deeply burrowed in the sediment, the lugworm can be found in its habitat in U-shaped burrows. Lugworms are very important sediment bioturbators in many shallow coastal ecosystems. For stabilization of the ecosystems, the water fraction was re-circulated for one month. This creates a stable community of pelagic invertebrates and microflora, as well as similar water quality conditions in all mesocosms at the start of the application of the test substance (chlorophyll-a, pH, dissolved oxygen concentration, salinity and nutrient concentrations). Just before the start of the exposure phase, each mesocosm unit became static. Within each system, water circulation was created by continuous aeration.

The salinity in the mesocosms was kept at the initial value  $30\pm 2\text{‰}$ . Evaporation losses were replenished with demineralised water. Each mesocosm was covered with a transparent lid to minimise the influence of rainfall.

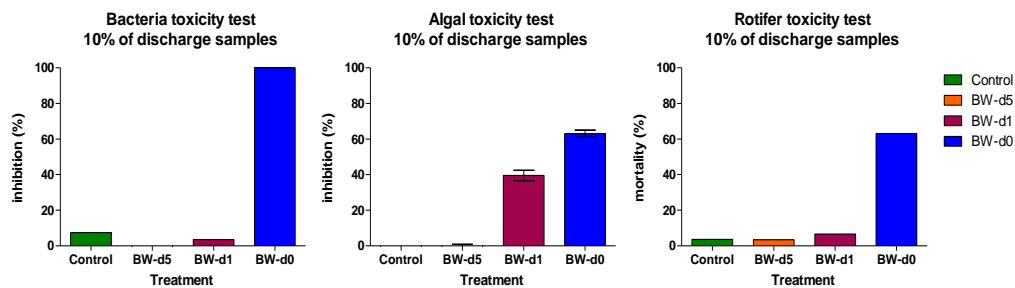
Seawater was treated on several days to mimic different discharge and concentration circumstances. The following water treatment discharge scenarios were created: 5 days old (BW-d5), 24 hours old (BW-d1) and freshly treated (BW-d0). Each treatment was dosed into two mesocosms. Two control tanks (Control) did not receive any ballast water. Dosing into the mesocosms was performed on the same day by replacing approximately 10% of the total water volume. The ballast water was treated with PERACLEAN Ocean® provided by Evonik Degussa GmbH. This treatment consists of two main active substances – Peracetic acid (PAA) and hydrogen peroxide ( $\text{H}_2\text{O}_2$ ). To check the dosing concentrations, the discharge water was measured before and after dosage in the mesocosm tanks. No  $\text{H}_2\text{O}_2$  and PAA could be measured for the control and BW-d5.  $\text{H}_2\text{O}_2$  was still present in the BW-d1 and BW-d0 treated water, and about 10% could still be measured after dosing into the mesocosms. Hardly any PAA could be measured in BW-d1, and none was detected after dosing in the mesocosms. Only BW-d0 showed the presence of PAA. The dosed mesocosms were monitored for another 69 days to monitor the effects. Extensive analyses were performed during the exposure period. These included water quality parameters like oxygen and pH but also sampling of zoo- and phytoplankton communities. After the deployment period, the systems were emptied, and the sediment compartment was also sampled intensively.

*As results from the study were still being processed at the time of the presentation, only observations were presented. Statistical analysis of the data had not been done.*

## Results

Toxicity of the ballast water was tested at the start of the exposure in the mesocosm experiment. In total, three bioassays were selected: a bacteria test (ISO, 2007), an algae test (ISO, 2006) and rotifer test (MicroBioTests Inc.). Each bioassay tested all of the different treated ballast waters and a sample of untreated ballast water. The samples were diluted in a concentration series according to the test procedures of each bioassay. At 10% dilution, the expected effects of the treated ballast water samples in the mesocosms could be derived (Figure 1). For the Control tanks and for the BW-d5 tanks, no toxicity was found. The algal toxicity test showed inhibitory effects of approximately 40% for the BW-d1. No effects were found for the bacteria and the rotifer test. All three bioassays showed effects for the freshly prepared ballast water (BW-d0), ranging from 100% inhibition for the bacteria to approximately 60% effect for the algae and rotifers.

## ECOLOGICAL RISK OF TREATED BALLAST WATER



**Figure 1. Results of the bioassays at 10% of the discharge ballast water samples. Presented are results from a bacterium, an algae and a rotifer test.**

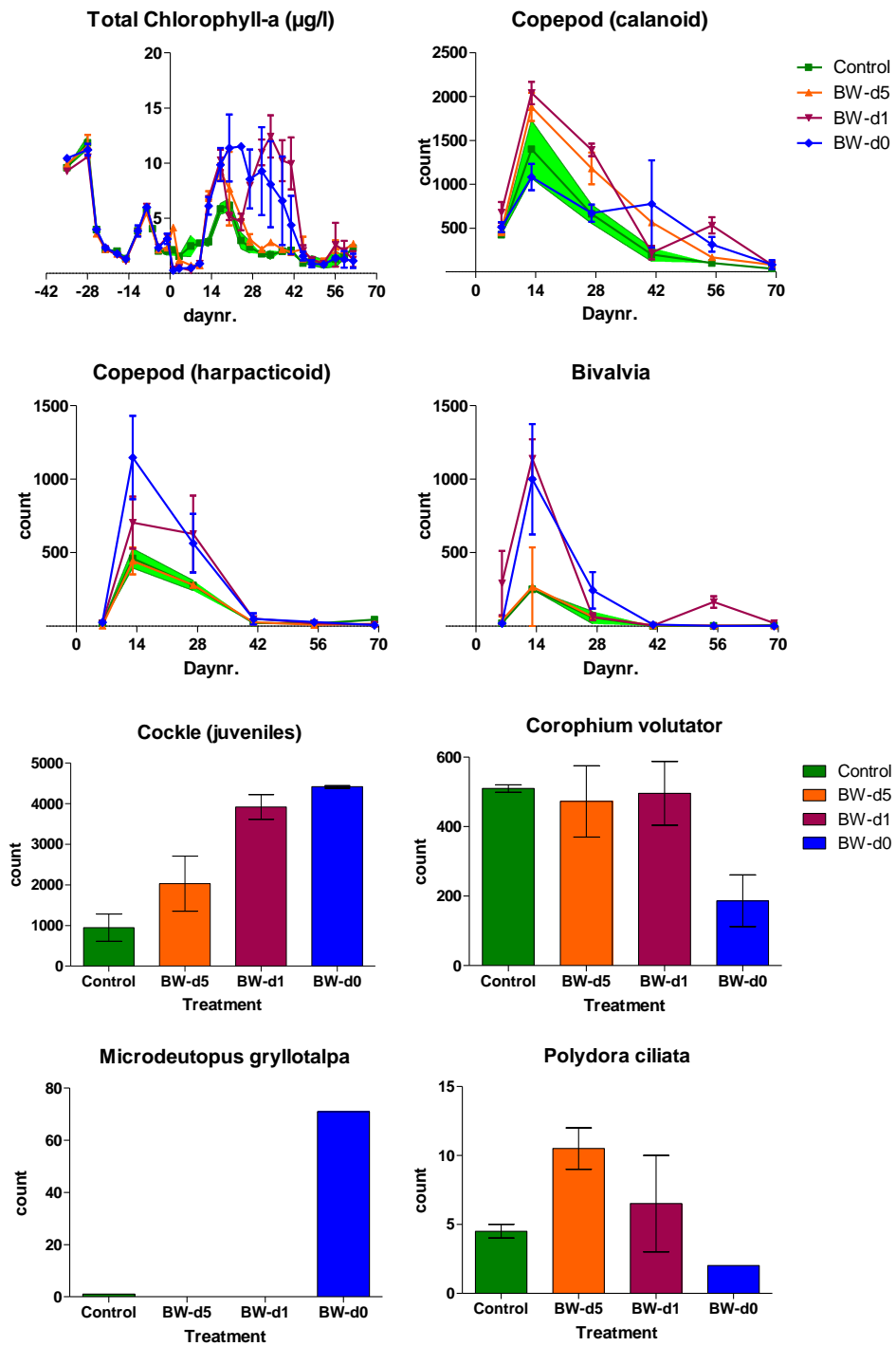
Figure 2 shows a selection of the results for the mesocosm study. The line graphs present the number of days on the x-axis before and after dosing. For the bar graphs the treatment is presented on the x-axis. In all graphs, the error bars are the ranges of the different treatments. For the line graphs, the ranges of the control are accentuated with a green color.

The biomass of the phytoplankton community is presented as total chlorophyll-a concentration. The before period is the stabilization time for the systems. The graph shows that the systems were following similar patterns. After dosage, a short stimulation is seen for the five-day old ballast water (BW-d5). After about three weeks, the pattern is similar to the control again. BW-d1 showed negative effects during the first ten days and stimulation effects for about three to four weeks. BW-d0 reduced during the first ten days and then remained stimulated for about five weeks. After six weeks, all systems show very low concentrations of chlorophyll, which is normal for summer conditions. Due to the very low concentrations, it is uncertain whether full recovery took place.

The zooplankton community was sampled weekly, and biweekly samples were selected for analyses. Calanoid copepods seem to show stimulation for BW-d5 and BW-d1, but not for BW-d0. This effect is seen more often in mesocosm research and is often referred to as a classic mesocosm result. As a response to effects on other species, a population is stimulated until the dose becomes toxic. Stimulation of the harpacticoid copepods is seen for BW-d1 and BW-d0. BW-d5 follows the control system. After 42 days, the zooplankton populations collapse in all systems.

Bivalvia larvae produced by the introduced cockles were more numerous in BW-d1 and BW-d0 when compared to the control system and BW-d5. After a short period, the larvae settled and disappeared from the water column. However, sampling the benthic community at the end of the study confirmed the higher amounts of juvenile cockles in BW-d1 and BW-d0.





**Figure 2.** Graphs of a selection of the ballast water mesocosm results. Presented are phytoplankton (chlorophyll-a), zooplankton (copepods and bivalvia), amphipods (*Corophium volutator* and *Microdeutopus gryllotalpa*) and polychaeta (*Polydora ciliate*).

## ECOLOGICAL RISK OF TREATED BALLAST WATER

The population of *Corophium volutator* amphipods in the mesocosms seemed to be able to cope with the stress of the dosing with BW-d5 and BW-d1. The population was reduced for the mesocosms which were dosed with BW-d0. However, another amphipod (*Microdeutopus gryllotalpa*) showed up in the BW-d0 discharge and not in the other systems. Still total amphipod counts remained lower when compared to the other treatments.

The polychaeta *Polydora ciliata* shows the classic mesocosm graph, wherein the species population compared to the control system is stimulated for BW-d5, inconclusive for BW-d1 and reduced for BW-d0.

### Conclusions

In Table 2, results are summarized by comparing the control situation with the three different treated ballast waters. If there was stimulation seen in the analysis for the treated water compared to the control, this is shown in green, whereas red indicates negative effects and yellow indicates that no clear effects were visible. If the effects were clearly observable, but only for a short period, this is shown as dashed. The three toxicity tests are presented first.

Even though no toxicity was found for BW-d5, the mesocosm study does reveal some effects. These effects can be a result of replacing the water and also a result of physical changes caused by the treatment (e.g., pH, oxygen). In toxicity tests, the aim is to look at chemical effects and not physical effects even though it is part of a treatment. In a mesocosm study and at discharge in a harbor, the physical changes will be an important characteristic of the effluent and, thus, have a potential effect. One toxicity test revealed negative effects for BW-d1 - the algae test. The phytoplankton biomass, however, was stimulated in the mesocosm study and not hampered. This is opposite to what is expected to happen. More parameters seem to be stimulated by the treatment, and only one has shown negative results. It should be recalled, however, that phytoplankton was seriously reduced the first ten days after treatment. All toxicity tests revealed negative effects for the treatment. In the mesocosms negative effects for many of the species were seen, but stimulating effects were also seen, such as for the algae after the first drop, the harpacticoid copepods and the large amounts of cocklespat.

It is concluded that replacement of water without remaining active substances is not free from effects. However, the level of toxic substances present in the treated water corresponded with the amount of effects. Effects seen in bioassays are not directly copied in mesocosms. Results might be affected by physical characteristics like pH, oxygen, DOC, N/P. However, high risk indicated by the toxicity tests corresponded with high level of disturbances of the ecosystem. Mesocosms can be used in higher tier assessment of whole effluents, such as ballast water. Even when as much as 10% of the water volume is replaced by treated water,

treatment effects are obvious. Moreover, clear recovery of some systems was observed within the test period enabling to assess the No Observed Ecological Adverse Effects Concentration (NOEAEC) conform to De Jong et al. (2008). The mesocosms are a useful tool for assessment of treatments including the side effects of ballast water discharge, by integrating effects as well as recovery of multiple interacting species.

**Table 2. Summary of a selection of results for the pilot ballast water mesocosm study. Presented is the effects for the control system versus each treatment for a list of tests (toxicity test, organism and water characteristics) including the type of output (C=concentration, N=numbers/counts and G=growth). The effects are presented in colour where Yellow=no clear effects, Red=negative effects, Green=stimulation effects, dashed=temporary effects.**

Type of test		Control versus		
		BW-d5	BW-d1	BW-d0
<i>Bacteria test</i>	-	Yellow	Yellow	Red
<i>Algae test</i>	-	Yellow	Red	Red
<i>Rotifer test</i>	-	Yellow	Yellow	Red
Total Chlorophyll-a	C	Green	Green	Green
Copepod (calanoid)	N	Green	Green	Red
Copepod (harpacticoid)	N	Yellow	Green	Green
Bivalvia larvae	N	Green	Green	Green
Cockles (juveniles)	N	Green	Green	Green
Corophiumvolutator	N	Yellow	Yellow	Red
Microdeutopusgryllotalpa	N	Yellow	Yellow	Green
Polydora ciliate	N	Green	Yellow	Red
Halichondriapanicea	G	Red	Red	Red
Mytilusedulis	G	Yellow	Green	Green
Ctenodrilusserratus	N	Red	Yellow	Red
Cockles (adults)	N	Red	Yellow	Red
Littorinalittorea	N	Yellow	Yellow	Red
TOC	C	Yellow	Green	Green
DOC	C	Yellow	Yellow	Green
Acidity	C	Red	Red	Red
Oxygen	C	Red	Red	Red
Ortho-phosphate	C	Yellow	Red	Yellow
Oligochaeta sp.	N	Yellow	Yellow	Yellow
Arenicola marina	N	Yellow	Yellow	Yellow
Ammonium	C	Yellow	Yellow	Yellow

## REFERENCES

De Jong, F.M.W., T.C.M. Brock, E.M. Foekema and P. Leeuwangh (2008), Guidance for summarizing and evaluating aquatic micro- and mesocosm studies. A guidance document of the Dutch Platform for the Assessment of Higher Tier Studies. RIVM report 601506009/2008.

ISO (2006), International Standard, Water quality - Marine algal growth inhibition test with *Skeletonema costatum* and *Phaeodactylum tricornutum*. Second Edition 2006-04-15. NEN-EN-ISO 10253:2006(E).

ISO (2007), International Standard. Water quality - Determination of the inhibitory effect of water samples on the light emission of *Vibrio fischeri* (Luminescent bacteria test) - Part 3: Method using freeze-dried bacteria. Second edition 2007-12-01. ISO 11348-3:2007(E).

MicroBioTests (s.a.), ROTOXKIT M™. *Brachionus* toxicity screening test for estuarine and marine waters. MicroBioTests Inc. Belgium. V071090.



## Technology of ship's ballast water treatment using ·OH radicals based on IMO Guidelines

Mindong Bai<sup>1</sup>, Nahui Zhang, Zhitao Zhang, Yiping Tian, Xiyao Bai

---

### Abstract

*A new method of ·OH radicals is available for fast killing (within several seconds) of harmful aquatic organisms and pathogens in the course of discharging a ship's ballast water. With the strong electric-field discharge, the O<sub>2</sub> in air and H<sub>2</sub>O in a gaseous state are ionized and dissociated into a number of activated particles such as O<sub>2</sub><sup>+</sup>, O<sub>3</sub>, H<sub>2</sub>O<sup>+</sup> and H<sub>2</sub>O<sub>2</sub>, which are injected into a portion of the ballast water to form the dissolved ·OH and other active substances including O<sub>2</sub><sup>-</sup>, HO<sub>2</sub><sup>·</sup>, HO<sub>3</sub><sup>·</sup>; O<sub>2</sub><sup>+</sup>, H<sub>2</sub>O, etc. In an ·OH treatment system of 10 t/h, a series of experiments were completed. As a result, the D-2 ballast water discharge standard of IMO was satisfied and realized. The contents of 45 kinds of chemical substances such as bromated, haloalkane, haloacetic acid, haloacetonitriles and halophenols were under the test limit according as the Drinking Water Standard of World Health Organization (WHO). The evaluated results showed that treated ballast water posed a low potential risk to the aquatic environment, and there was no unacceptable risk to human health.*

**Key Words:** Ship's ballast water, strong electric-field discharge, ·OH radicals, IMO Guidelines, D-2 discharge standard, WHO drinking water standard, no potential risk.

---

### 1 Introduction

The introduction of invasive marine species into new environments by a ship's ballast water has been identified as one of the four greatest threats to the world's oceans. Until today, about 500 different species are known to have been transported via ballast water. Sixteen kinds of invasive red tide algae introduced into China Sea by ballast water resulted in great destruction to aquaculture. As a result, whole ecosystems are being changed, and economic losses of up to 10 billion USD is being caused each year. Consequently, IMO Regulation D-2 *ballast water discharge standard* is forced to require that the aquatic organism concentrations in the discharge of ballast water should be below specified limits. At the same time, a ballast water treatment system for producing and using chemical active substances such as ·OH radicals, ozonation, chlorination is necessary to obtain Basic and Final Approvals G9 of IMO.

As a result, many technologies for the treatment of ships' ballast waters have been developed, such as filtration and ultraviolet radiation (UV), chlorination, ozonation, thermal

---

<sup>1</sup> Environmental Engineering Institute, Dalian Maritime University, Dalian (116026), China.

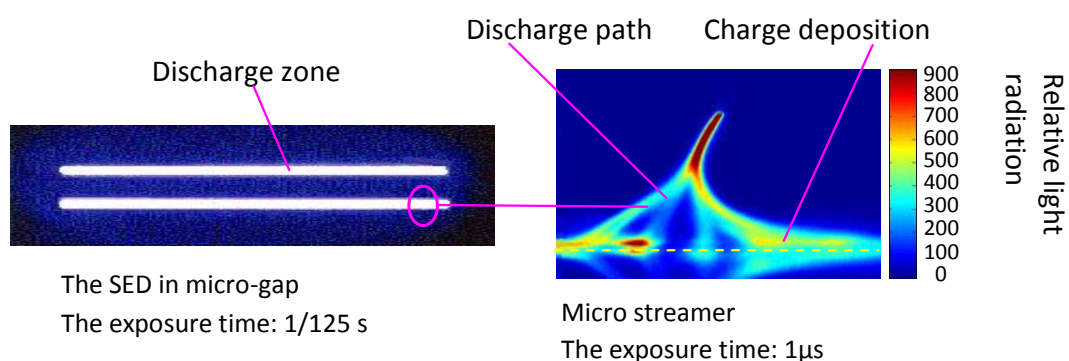
techniques, electrolysis, deoxygenation and so on. None of these potential solutions is in wide use, however. For example, treatment systems combining UV with filtration have been installed only on a small number of ships and it is not known whether any systems now available will consistently and efficiently meet the discharge requirements of developing regulations. In addition, the lamps of UV technology need periodic cleaning and are easily broken. So far, no effective method is available for fast killing (within several seconds) of harmful aquatic organisms and pathogens in the course of discharging a ship's ballast water.

Based on the G9 Guidance and D-2 ballast water discharge standard of IMO, a new treatment method for ballast water using  $\cdot\text{OH}$  radicals were presented. In a 10 t-h<sup>-1</sup> (tonne per hour)  $\cdot\text{OH}$  treatment system, a series of experiments such as biological efficacy, water qualities, chemical analysis and aquatic toxicity were completed.

## 2 Strong electric-field discharge and formation of $\cdot\text{OH}$ radicals

### 2.1 Strong Electric-Field Discharge

A physical method based on the strong electric-field discharge (SED) was applied to treat ballast water. The configuration of SED is shown in Figure 1. The strong discharge plasma was filled in two micro-gaps (width=0.47mm). Two  $\alpha\text{-Al}_2\text{O}_3$  dielectric layers, with a thickness of 0.2mm, dielectric constant of 10, and an insulation intensity of 350 kV/cm, were covered on an Ag thin plate discharge electrode (180×90 mm<sup>2</sup>). The self-made power supply was applied on the discharge electrodes with the following parameters: peak voltage, 7 kV; frequency, 10.4 kHz; current pulse width, and 5~10 ns. With the dielectric layers (15), problems such as restricted electric current, uniform and unstable distribution of micro plasma bundle and the power deposition were solved. The micro discharge gap allows the electrons to be accelerated, resulting in increased numbers of high-energy electrons compared to the conventional discharges at atmospheric pressure. The electron density in the discharge gap was high due to the applied high-frequency power supply.



**Figure 1. Photo of SED**





with other kinds of oxygen active substances, such as  $\text{HO}_2^-$ ,  $\text{O}_2^{\cdot-}$ ,  $\text{HO}_3^{\cdot}$ ,  $\text{O}_2+\text{H}_2\text{O}$ , etc., had the most significant contributions with respect to killing harmful organisms due to their strong oxidizing effects.

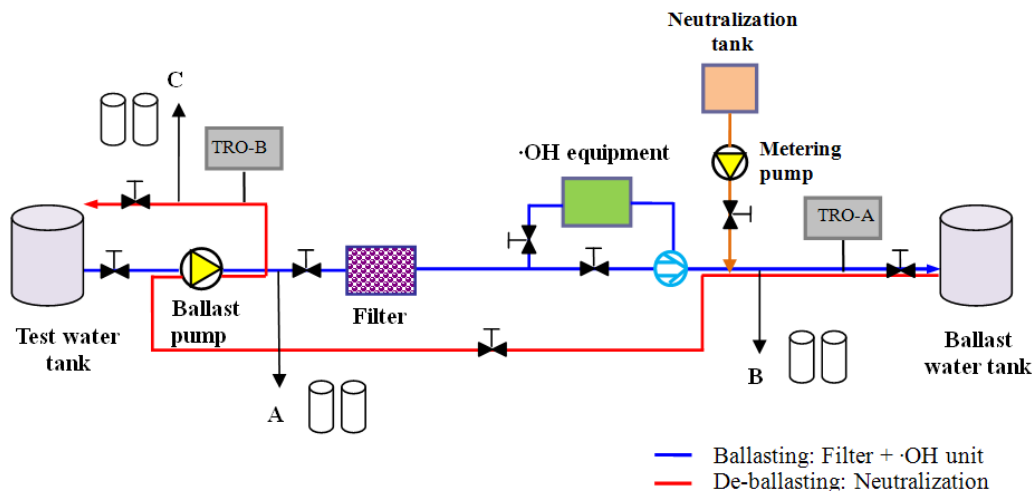
In addition,  $\cdot\text{OH}$  radicals react with bromide ions ( $\text{Br}^-$ ) in seawater to form hypobromous acid/hypobromite ( $\text{HOBr}/\text{OBr}^-$ ) and bromamines. Theoretically speaking, however, both  $\text{HOBr}/\text{OBr}^-$  and bromamines have a certain germicidal effect on controlling bacteria, algae and macroscopic bio-fouling organisms during the storage period of treated ballast water.

The concentration of total oxygen active substances is measured by TRO (total residual oxidant) analyzer during the treatment. The TRO refers to all of the oxidants which have the ability to kill harmful aquatic organisms and pathogens.

### 3 Experiment

#### 3.1 Experimental System

The experimental system for ship ballast water treatment is shown in Figure 3. When ballasting, as a first step, ballast water is filtered by an automatic self-cleaning filter for removing the large particles and organisms of  $>50\ \mu\text{m}$ . In the main pipe, a part of ballast water is pumped into  $\cdot\text{OH}$  equipment to produce large numbers of  $\cdot\text{OH}$  radicals and other active substances, including  $\text{HO}_2^-$ ,  $\text{O}_2^{\cdot-}$ ,  $\text{HO}_3^{\cdot}$ ,  $\text{O}_2+\text{H}_2\text{O}$ , etc., so that harmful organisms and pathogens are rapidly killed in the course of conveying the ship's ballast water. This effluent is then directed into the ballast tank for 5 days of testing. When de-ballasting, the filter and the  $\cdot\text{OH}$  equipment are passed-by, and the treated ballast water is to be neutralized at discharge to ensure that the TRO is less than  $0.2\ \text{mg/L}$  in any case. There are three sampling points of A, B and C, corresponding to the samples for control water, treated water and treated water with neutralization.



**Figure 3. Schematic diagram of  $\cdot\text{OH}$  ballast water treatment system**

Two different salinity ballast waters – with high salinity (33.7 PSU) and low salinity (23.1 PSU) – were used for ·OH killing experiments. Water samples were collected from the ballast tank 0, 2 and 5 days after ·OH treatment. The flow velocity of ballast water in the main pipe was 1.5 m/s, and the flow rate measured by Model 8035 Burkert Flow meter (Burkert Co. in France) was 10 m<sup>3</sup>/h. The energy cost for the treatment of the ship's ballast water was 30Wh/m<sup>3</sup>, without considering the energy cost of pumping.

### 3.2 Test Methods

#### 3.2.1 Biological test

Algae and bacteria: The living bodies of algae were identified and counted using the automatic Fluorescence Microscope (Olympus BX61). The bacteria were fast-counted using Epics Altra II Flow Cytometry (Co. Beckman Coulter), meanwhile, the colony-forming unites were calculated by plating the membrane filtered sample on ocean 2216E agar medium.

#### 3.2.2 Chemical analysis

The chemical analysis methods and corresponding analyzers are shown in Table 1. The items of ballast water quality including pH, Temperature, DO, Salinity, Turbidity, ORP were measured using Multiparameter water quality sondes (YSI-6600 V2). The DOC and POC were tested by Ligui TOC.

**Table 1. List of analytical methods used for each chemical tested**

Item	Test method	Analyzer
TRO/TRC*	DPD Method	UNICO7200 type, Spectrophotometer
Bromate	Ion Chromatographic Method	ICS-1500 Ion chromatograph, DIONEX
Trihalomethane	Gas Chromatographic Method	
Haloacetic acids	Gas Chromatographic Method	7890A Gas chromatograph, Agilent
Haloacetonitriles	Gas Chromatographic Method	
Sodium thiosulfate	Iodometric Method	-

\* The detection value of TRO is the amount of ·OH, O<sub>2</sub><sup>·-</sup>, O<sub>3</sub>, HOBr/OBr<sup>-</sup> and bromamines. And the detection value of TRC is the amount of ·OH, O<sub>2</sub><sup>·-</sup>, O<sub>3</sub> and HOBr/OBr<sup>-</sup>.

## 4 Experimental Results and Discussion

Both high and medium salinity sea water was used for analysis, however, the test results of the high salinity sea water is only shown in the following section (Table 2 and Table 3).

### 4.1. OH killing experiment

For the ·OH killing experiment, five kinds of algae and three kinds of bacteria were in the system of the ship's ballast water. The dimensions of algae were in the range of 10~50 µm. Two group experiments were done for different algae contents of 1.23×10<sup>4</sup> cells/mL and

0.508×10<sup>4</sup> cells/mL. The concentrations of *E. coli*, *I. Enterococci* and Heterotrophic bacteria were about 13×10<sup>4</sup>, 12×10<sup>4</sup>, and 38×10<sup>4</sup> cell/ML, respectively. After ·OH treatment, the algae content of 1.23×10<sup>4</sup> cells/mL was decreased to 8 cell/mL when the TRO was 1.86 mg/L, and algae content of 0.508×10<sup>4</sup> cells/mL was reduced to 9 cells/mL when the TRO was 1.41 mg/L. After both 2 days and 5 days of storage, no living algae were detected in the ballast tank. At the same time, no living bacteria were found in the ballast tank after either 0 days, 2 days or 5 days of storage. The results were tested by the Detecting Center of Xiamen University with Accreditation of ISO/IEC 17025. The results indicate that the D-2 ballast water discharge standard of IMO was satisfied.

**Table 2. Experiment results of high salinity water**

Item	0h (Day 0)		48h (Day 2)		120h (Day 5)	
	Control	Treated	Control	Treated	Control	Treated
TRO (mg/L)	0	1.41	0	0.21	0	0
Organism ≥10 ~ 50 μm (cell/mL)	0.508×10 <sup>4</sup>	9	2400	0	1000	0
<i>Escherichia coli</i> (cfu/100mL)	14×10 <sup>4</sup>	0	13×10 <sup>4</sup>	0	11×10 <sup>4</sup>	0
<i>Intestinal Enterococci</i> (cfu/100mL)	12×10 <sup>4</sup>	0	11×10 <sup>4</sup>	0	9.5×10 <sup>4</sup>	0
Heterotrophic bacteria (cell/mL)	39×10 <sup>4</sup>	0	33×10 <sup>4</sup>	0	29×10 <sup>4</sup>	0
TRO (mg/L)	0	1.86	0	0.44	0	0
Organism ≥10 ~ 50 μm (cell/mL)	1.235×10 <sup>4</sup>	8	0.5×10 <sup>4</sup>	0	0.21×10 <sup>4</sup>	0
<i>Escherichia coli</i> (cfu/100mL)	13×10 <sup>4</sup>	0	11×10 <sup>4</sup>	0	10×10 <sup>4</sup>	0
<i>Intestinal Enterococci</i> (cfu/100mL)	12×10 <sup>4</sup>	0	10×10 <sup>4</sup>	0	7.8×10 <sup>4</sup>	0
Heterotrophic bacteria (cell/mL)	38×10 <sup>4</sup>	0	32×10 <sup>4</sup>	0	29×10 <sup>4</sup>	0

#### 4.2. Water qualities

Water properties are shown in Table 3. Three basic water qualities including temperature, salinity and pH showed almost no change after ·OH treatment on Day 0, Day 2 and Day 5, respectively.

The oxidation-reduction potential (ORP) increased three times with the injection of oxygen active substances when TRO is 1.86 mg/L, but returned to the original value with the neutralization of Na<sub>2</sub>S<sub>2</sub>O<sub>3</sub>. The ORP of 683.6 mV after ·OH treatment decreased with the decrease of TRO, which decreased to 262.6 mV on Day 2 and 259.1 mV on Day 5. Dissolved oxygen (DO) increased with the injection of TRO and decreased with the attenuation of TRO.

However, DO after 5 days of storage was still higher than that of the original value of 7.08 mg/L. Both total suspended solids (TSS) and turbidity decreased significantly at the intake of the tanks due to the filtration.

The addition of ·OH resulted in an immediate increase in the DOC in ballast water at the intake of the tanks about from 2.52 to 5.31 mg/L. A possible explanation for these results is that due to the sterilizing characteristics of the hydroxyl radical, which can kill invasive species in ballast water rapidly, making the biological cells rupture and a large number of cellular content overflow, thus, the DOC content increases initially. By contrast, the addition of ·OH resulted in an immediate decrease of the POC in ballast water at the intake of the tanks from about 2.05 to 0.01 mg/L, and then increased slowly, to a final stable trend.

**Table 3. Water qualities (high salinity seawater)**

Item	0 day		Treated with neutralization	2 day	5 day
	Control	Treated		Treated	Treated
TRO (mg/L)	----	1.86	----	0.44	0.01
Salinity (PSU)	33.7	33.6	33.9	33.8	33.6
Temperature (°C)	12.73	13.79	13.59	14.50	14.42
pH	8.21	8.20	8.26	8.30	8.24
ORP (mV)	229.1	683.6	229.4	262.6	259.1
DO (mg/L)	7.08	7.98	9.57	9.00	8.30
TSS (mg/L)	11.3	6.8	6.9	6.4	5.5
Turbidity (NTU)	2.90	1.99	2.22	2.10	2.0
DOC (mg/L)	2.52	5.31	5.51	3.72	3.51
POC* (mg/L)	2.05	0.01	0.05	0.91	1.1

\* POC (particulate organic carbon) is estimated from total organic carbon (TOC).

Based on these results, we can reach a conclusion that ·OH can purify water and decline the contaminant levels.

#### 4.1 Chemical analysis

The potential by-products in the seawater treated by ·OH have been tested and analyzed. Chemical analysis results are given in Table 4.

The results indicate that bromate was always below the MDL in all samples. From the other tested compounds, four THMs (tribromomethane, trichloromethane, dibromochloromethane and bromodichloromethane), all nine HAAs (monochloroacetic acid, dichloroacetic acid, trichloroacetic acid, monobromoacetic acid, dibromoacetic acid, tribromoacetic acid,

bromochloroacetic acid, bromodichloroacetic acid and dibromochloroacetic acid) were detected. The maximum concentration of bromoform and tribromoacetic acid, which have been detected in treated ballast water during the development of  $\cdot\text{OH}$  treatment, were 68.2  $\mu\text{g/L}$  in high salinity water. It is obvious that the formation of THMs and HAAs increased over time initially, and then decreased slightly (especially halogenated carbon) which can be related to the degradation of TRO. TRO degraded very rapidly under conditions tested. In all tests, TRO completely degraded below 0.2 mg/L (detection limit ppm) within less than hours. Then, the degradation rate was slightly slower after 70 hours, probably trended to be stable. Thus, the formation of halogenated carbon increased in the presence of TRO, whereas it decreased with the decline of TRO over time. It is assumed that the maximum concentration of halogenated carbon would occur around 70 hours after  $\cdot\text{OH}$  treatment, and then begin to decrease slowly.

**Table 4. Data summary for chemical analysis (33.7 PSU)**

Chemical name	Unit	MQL <sup>*</sup>	Day 0			Day 2	Day 5
			Control	Treated	Treated after neutralization	Treated	Treated
TRO	mg/L	0.01	ND <sup>**</sup>	2.41	ND	0.44	0.01
TRC	mg/L	0.01	ND	2.3	ND	0.42	ND
Bromate	$\mu\text{g/L}$	0.01	ND	ND	ND	ND	ND
Tribromomethane	$\mu\text{g/L}$	0.01	ND	42.5	41.2	62.6	48.7
Trichloromethane	$\mu\text{g/L}$	0.01	2.06	0.78	0.74	0.79	2.06
Dibromochloromethane	$\mu\text{g/L}$	0.01	ND	0.83	0.46	2.28	2.99
Bromodichloromethane	$\mu\text{g/L}$	0.02	0.38	0.88	0.14	0.16	0.017
Monobromoacetic acid	$\mu\text{g/L}$	0.01	ND	2.61	2.48	1.45	1.88
Dibromoacetic acid	$\mu\text{g/L}$	0.02	2.91	6.03	4.13	17.6	12.2
Tribromoacetic acid	$\mu\text{g/L}$	0.02	10.7	57.8	50.2	56	10.8
Monochloroacetic acid	$\mu\text{g/L}$	0.01	ND	6.50	ND	16.2	22.5
Dichloroacetic acid	$\mu\text{g/L}$	0.01	2.27	2.23	2.17	0.67	ND
Trichloroacetic acid	$\mu\text{g/L}$	0.01	2.50	ND	ND	0.78	0.91
Bromochloroacetic acid	$\mu\text{g/L}$	0.01	ND	6.03	ND	ND	ND
Bromodichloroacetic acid	$\mu\text{g/L}$	0.01	3.81	3.80	3.79	ND	ND
Chlorodibromoacetic acid	$\mu\text{g/L}$	0.01	ND	ND	ND	ND	ND
Dibromoacetonitrile	$\mu\text{g/L}$	0.01	ND	ND	ND	ND	ND
Sodium thiosulfate	mg/L	0.02	ND	ND	0.8	ND	ND

\* MDL: method detection limit

\*\*ND: not detected

#### 4.4 TRO decay

All TRO concentrations in the ballast tanks declined over time. TRO levels reduced rapidly during the first 24 hours of sampling (Figure 4), and then the rate of decay slowed after 48 hours. The TRO declines below 0.2 mg/L nearly 72 hours after storage.

Our results suggested that a higher initial TRO concentration in ballast water would decay more slowly than a lower initial TRO concentration. Therefore, increasing the initial TRO would provide the disinfectant effect over a longer period of time. This increased disinfection period would not only be able to increase the effectiveness of treatment on those organisms, but would also inhibit the re-growth of organisms with rapid reproductive rates, such as bacteria.

The test results indicated that the rate of TRO decay was dependent on the chemistry of the ballast water. Reasons for these differences could be due to the uncontrolled variables among tests, such as chemical compositions of the source water and non-selective oxidation of organic matter. Inorganic compounds including iron, ammonia, and others may also affect residual oxidant decay.

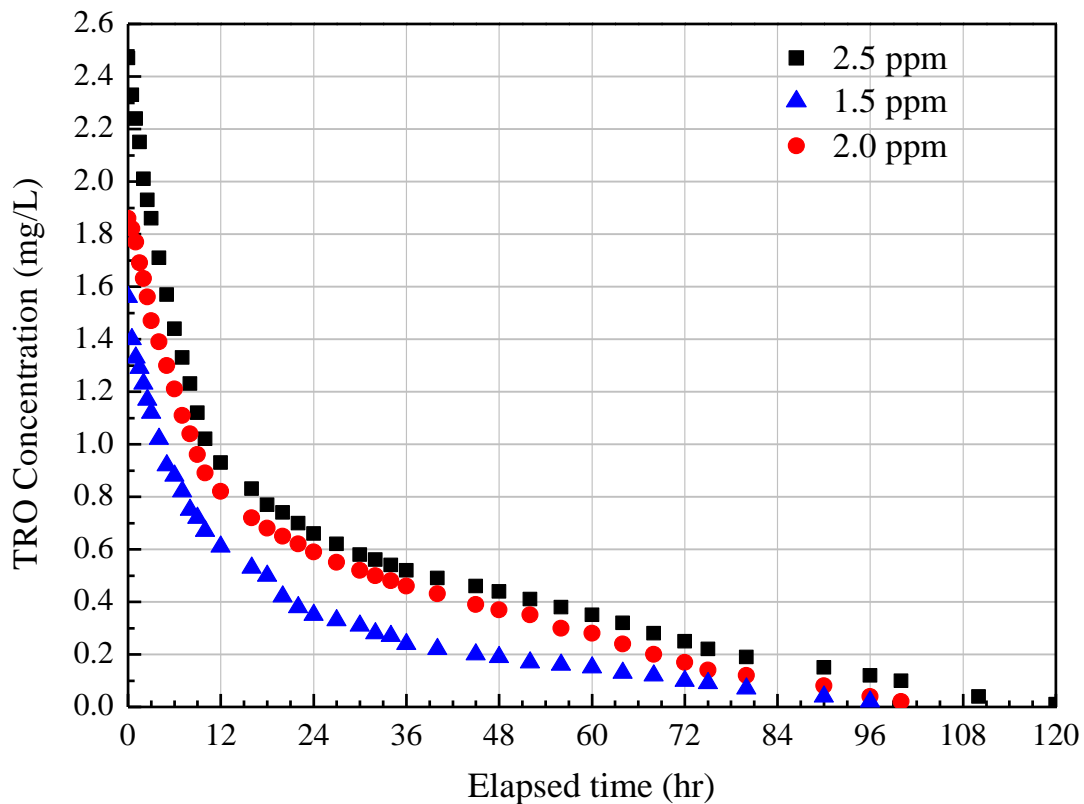


Figure 4. TRO decay over a period of 120h for high salinity (measured as Cl<sub>2</sub>).

#### 4.5 Toxicity Tests

According to the guidelines of the US EPA, the algae growth inhibition test for high salinity ballast water after  $\cdot\text{OH}$  treatment was performed.

The definitive test was conducted with the 100% treated ballast water under laboratory conditions. During the 96-hour test period, growth inhibition and other toxic signs were not observed in the treated and control cultures. The test results indicated that  $\text{IrC}_{50}$  (96hr),  $\text{IyC}_{50}$  (96hr) and NOAEC (No Observed Adverse Effect Concentrations) to *Platymonas helgolandica* were all greater than 100% treated ballast water.

# The forgotten fraction: The importance of organisms smaller than 10 $\mu\text{m}$ when evaluating ballast water treatment systems

Isabel van der Star<sup>1</sup>, Viola Liebich, Peter Paul Stehouwer

---

## Abstract

*Aquatic organisms in the size class of 10 to 50  $\mu\text{m}$  and larger than 50  $\mu\text{m}$  are the main parameters when qualifying ballast water treatment systems (BWTS). Organisms smaller than 10  $\mu\text{m}$  in minimum dimension are not taken into account when testing BWTS following the D-2 standard of the IMO. This size class includes bacteria, phytoplankton and protozoa as micro-zooplankton species which can be analysed conveniently by flow cytometry. Results of numerous land-based tests showed that 90% of all phytoplankton organisms were smaller than 10  $\mu\text{m}$  in minimum dimension. Besides a high numerical abundance, it is well known that many toxic phytoplankton species belong to this size fraction. Therefore, the importance of this size class should be reconsidered when evaluating BWTS and deserves to be taken into account in the requirements for certification of BWTS.*

Keywords: ballast water convention, D-2 standard, minimum dimension, harmful algal blooms, flow-cytometry, plankton

---

## 1. Introduction

Biological invasions are facilitated by human actions. One main activity contributing to biological invasions is shipping ballast water (Carlton, 1987; Wohnham et al., 2001). Due to ecological and economic damages caused by invasive species in the past (Ruiz et al., 1997; Waite et al., 2003; Gregg et al., 2009) the International Maritime Organization (IMO) implemented the Ballast Water Management Convention. The Convention specifies in the D-2 standard the amount of viable organisms allowed in ballast water upon discharge (Anonymous, 2004). According to the BWM Convention, the D-2 standard requires that ballast water upon discharge should contain:

- Less than 10 viable org/ $\text{m}^3 \geq 50 \mu\text{m}$  in minimum dimension
- Less than 10 viable org/ $\text{ml} < 50 \mu\text{m}$  and  $\geq 10 \mu\text{m}$  in minimum dimension

---

<sup>1</sup> Department of Biological Oceanography, Royal Netherlands Institute for Sea Research, P.O.Box 59, NL-1790 AB, Den Burg, Texel, The Netherlands  
Corresponding author: [i.vanderstar@mea-nl.com](mailto:i.vanderstar@mea-nl.com) Questions referring to the ballast water project at NIOZ: [Louis.Peperzak@nioz.nl](mailto:Louis.Peperzak@nioz.nl)



Indicator microbes at the following concentrations (cfu= colony forming units):

- *Vibrio cholerae* < 1 cfu/100ml
- *Escherichia coli* < 250 cfu/100ml
- Intestinal *Enterococci* <100 cfu/100ml

Besides some indicator microbes the D-2 standard does not include requirements of organisms smaller than 10 µm in minimum dimension.

## 2. Organisms <10 µm; Biology, toxicity and high health risks

The size class smaller than 10 µm in minimum dimension comprises a great variety: phytoplankton, micro-zooplankton, protozoa, bacteria and viruses. The size classes as defined in the D-2 standard refer to minimum dimension, i.e. the widest dimension of the smallest visible axis of the body excluding appendages (Miller et al., 2011; Gollasch et al., 2007).

Numerous marine species are on average below 10 µm in minimum dimension: e.g. *Pseudo-nitzschia* sp., *Nitzschia* sp., *Skeletonema* sp. and *Bodo* sp. Especially in elongated or needle shaped diatom taxa like *Pseudo-nitzschia* and *Nitzschia* the minimum dimension can be below 5 µm (transapical axis) while cell length can be more than 30 µm (apical axis). Besides these, there are also organisms around 10 µm in minimum dimension (e.g. *Thalassiosira* sp., *Balanion* sp. and *Tetraselmis* sp.). A third group is formed by organisms having a complex life cycle including stages belonging to more than one size class. An example for this is *Pfiesteria piscicida*. It shows a complex life cycle including transformation forms of flagellate, amoeba and cyst (Burkholder and Glasgow, 1997). Size in this species depends on life stage and diet. It ranges between 5-450 µm.

Resting stages and cysts are smaller than their vegetative cells and a lot are <10 µm in minimum dimension. They easily survive transport in ballast water or in the sediment at the bottom of ballast tanks.

Hallegraeff and Bolch (1992) investigated the viability of phytoplankton cysts in sediment of a ballast water tank. Twenty cysts of 53 identified species showed viable regrowth in cultures. Among the surviving species numerous belonged to the group of toxic dinoflagellates including *Alexandrium catenella*, *Alexandrium tamarense* and *Gymnodinium catenatum*. The occurrence of toxin producing plankton species can result in negative effects since they can be harmful already in low cell concentrations. Also blooming phytoplankton species can be harmful by causing anoxic conditions following their decay (e.g. *Skeletonema* sp., *Thalassiosira* sp. and *Phaeocystis* sp.).

Toxicity of these harmful bloom forming species, with an average cell size of less than 10 µm, affects other organisms in the ecosystem but it may also affect humans. Humans can be exposed through different ways like seafood consumption, dermal contact (Knap et al., 2002) or by inhalation (Kirkpatrick et al., 2004). Exposure can pose health risks including irritation of skin, eye and respiratory tract, gastroenteritis and short term neurocognitive disorders (for references see Sellner et al., 2003 and Grattan et al., 2001). Toxic species may become invasive because this size class is not included in compliance testing of BWTS.

The main part of invasive phytoplankton species found is larger than 10 µm in size, e.g. diatoms like *Rhizosolenia indica* and *Coscinodiscus wailesii* (Gómez and Souissi, 2010; Nehring, 1998). This might be due to their cell size which makes them easier to monitor by microscopy, which is the established, standard method. Data are scarce on invasive species below 10 µm in minimum dimension. Nehring (1998) reviewed studies discussing invasive species and mentioned *Prorocentrum triestinum* ranging from 6-11µm in minimum dimension. Fifteen other invasive phytoplankton species in the North Sea reviewed in the same study are bigger than 10 µm in minimum dimension. However, some of the larger cells form cysts which are much smaller than their vegetative cells and can survive long periods in the dark. Therefore, for numerous reasons the whole range of phytoplankton cell sizes should be considered and not exclusively those larger than 10µm.

### **3. Enumerating and size determination of phytoplankton with a cell size of <10 µm**

Flow cytometry (FCM) is used as analytical method for microorganisms (unicellular algae, protozoa, bacteria and viruses) in aquatic ecosystems since the early 1980's (e.g. Dubelaar and Jonker, 2000; Veldhuis and Kraay, 2000; Vives-Rego et al., 2000; Yentsch et al., 1983; Troussellier et al., 1993). It is a faster tool for quantifying microorganisms compared to microscopic analysis, especially for the smaller phytoplankton species, where high numbers can be found above 10<sup>8</sup> per litre (Veldhuis and Kraay, 2000).

Quantitative analysis of phytoplankton smaller than 10 µm in minimum dimension can be done by flow cytometry. Guideline G8 does not require these measurements (Anonymous, 2008). However, the Royal Netherlands Institute for Sea Research (NIOZ) performs this analysis from the beginning of land based testing of BWTS at their harbor (Texel, The Netherlands). For further information on this test facility for BWTS see Veldhuis et al. (2006).

Data presented here come from control samples taken during testing of BWTS before any treatment. Analysis is done in triplicate. Quantitative results of the last three years show that phytoplankton smaller than 10 µm comprises 92% (SD= 6%) of the total phytoplankton cells found in control samples (Table 1). This research is based on a total of 85 samples and 255 measurements.

**Table 1. Percentage of phytoplankton <10 µm of total phytoplankton counts in control samples during April till June from 2009 till 2011 analyzed by FCM.**

Year	# samples taken	# analyzed samples	minimum %	maximum %	average %	SD %
2009	21	63	71	98	92	6
2010	40	120	76	99	92	5
2011	24	72	60	99	92	6
<b>total</b>	<b>85</b>	<b>255</b>	<b>60</b>	<b>99</b>	<b>92</b>	<b>6</b>

#### 4. Cell viability and regrowth potential

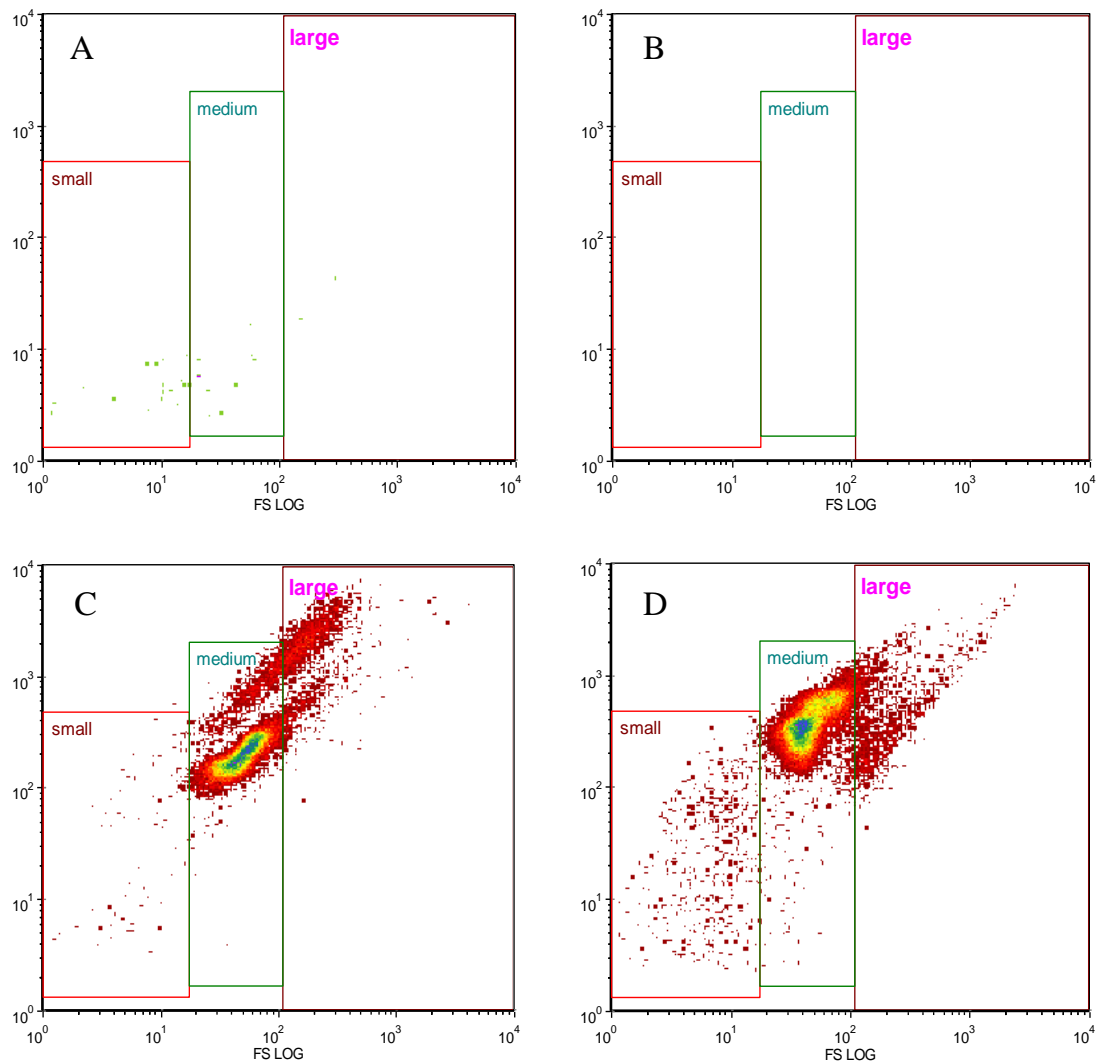
To investigate the regrowth ability of phytoplankton after treatment of BWTS, long-term incubation experiments were performed. Experiments were conducted based on normal scheduled test runs according to the G8 guideline (Anonymous, 2008). Results are compared of two treatment systems: The first treatment system includes a filter (20 µm mesh size) and low-pressure UV-radiation (fixed wavelength of 254 nm) and the second treatment system includes a filter (200 µm mesh size), hydrocyclone and electrolytic chlorination. Systems were tested from March till June 2010 and treated water was stored during five continuous days. Before discharge, 10 litre samples were taken for incubation experiments. Quantitative analysis of phytoplankton was done every five days by flow cytometry (Coulter Epics XL-MCL with a 488 nm argon laser, Miami, USA). Further details of incubation experiments can be found in Stehouwer et al. (2010).

After treatment with the UV system (Figure 1A-D) no regrowth of phytoplankton was found the first five days. After 10 to 15 days there is substantial regrowth, especially of phytoplankton <10 µm. Comparable tests with the electrolytic chlorination showed also regrowth (Figure 2A-D) after 10 days of mainly phytoplankton <10 µm although numbers were lower than the UV system. This was also found after 15 and 20 days while phytoplankton numbers further increased, especially phytoplankton <10 µm. For both treatment systems and during the whole period, larger numbers of phytoplankton <10 µm were found compared with the size class above 10 µm.

#### 5. Discussion and conclusion

The abundance of phytoplankton in different size classes is highly dependent on the growth (primary production) and mortality due to grazing e.g. by zooplankton (Gieskes and Kraay, 1975) and therefore seasonal dependent. During spring and early summer phytoplankton species with a minimum dimension of 10 µm are the main species found in the NIOZ harbor (92% of all phytoplankton). These organisms also showed a large ability to regrow after treatment by different BWTS, although there was a lag period of up to 10 days. When

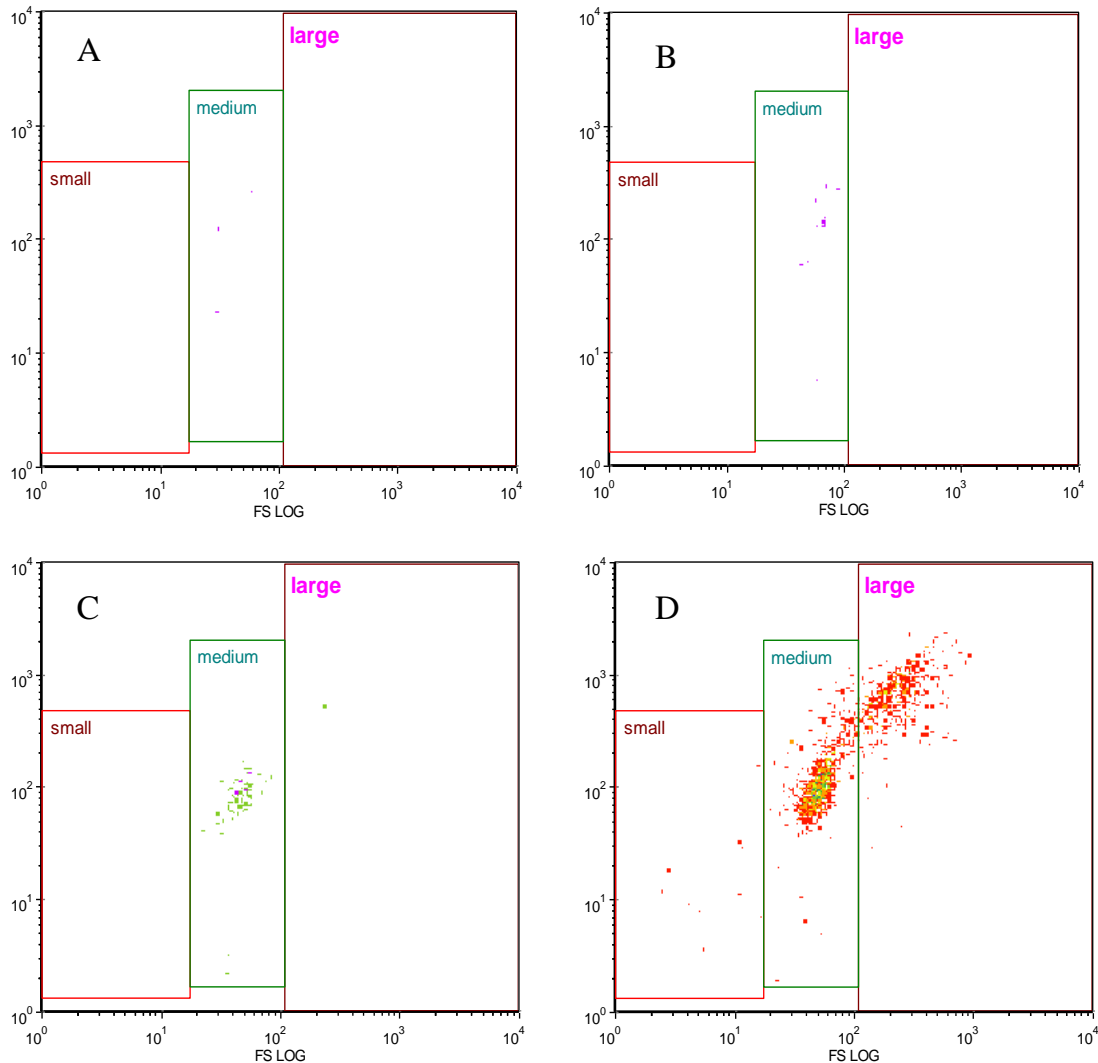
## THE IMPORTANCE OF ORGANISMS SMALLER THAN 10 $\mu\text{m}$



**Figure 1. Phytoplankton counts by FCM; chlorophyll (FL4log) against the size of the phytoplankton (FSlog) at discharge after treatment including filter and UV at day: A=0, B=5, C=10, and D=15. The size class large is  $>10\mu\text{m}$ .**

comparing systems, filter together with UV treatment showed faster regrowth and higher numbers compared to the system using filter, hydrocyclone and electrolytic chlorination. Faster regrowth after UV treatment is unexpected due to the fact that water is treated twice by an UV system, namely before intake and before discharge. However, phytoplankton regrowth after UV treatment is also found in other studies (Waite et al., 2003; Stehouwer et al., 2010; Sutherland et al., 2001).

Determination of regrowing phytoplankton species was also done after UV treatment. Different phytoplankton species were found including *Chaetoceros* sp., *Skeletonema* sp., and *Thalassiosira* sp. in the  $<10\mu\text{m}$  and  $10\text{-}50\mu\text{m}$  size class (Liebich et al., 2011). Results of this



**Figure 2. Phytoplankton counts by FCM (chlorophyll/FL4log against the size of the phytoplankton/ FSlog) at discharge after treatment including filter, hydro cyclone and electrolytic chlorination at day: A= 0, B=5, C=10 and D=15. The size class large is >10  $\mu\text{m}$ .**

study suggest that only certain phytoplankton species are able to survive after treatment in a ballast water tank. Regrowth abilities of these survivors might be due to a broader temperature tolerance, high growth rates and the ability to form resting stages in their life cycle. These traits imply the potential of the species to become invasive once discharged (Liebich et al., 2011). Besides the well discussed phytoplankton <10  $\mu\text{m}$ , it is known that this size class includes various other groups of organisms like: micro-zooplankton, protozoa, bacteria and viruses. In particular the smaller sized organisms possess a high growth rate (Kagami and Urabe, 2011) favoring their regrowth ability when discharged in recipient water. Due to toxic and harmful species in this size class, successful invasion may result in negative effects on ecosystems and may cause health risks.

## THE IMPORTANCE OF ORGANISMS SMALLER THAN 10 µm

The problem of invasive species in the oceans is still a huge issue to solve. The IMO made important progress by the Ballast Water Management Convention although it is not implemented yet. However, when this convention becomes into force, living organisms smaller than 10 µm in minimum dimension will still be able to be discharged. This is due to the fact that these organisms are not mentioned in the D-2 standard, except for certain indicator microbes. Invasiveness of this size class by ballast water transportation is possible because they are not analyzed when testing BWTS following the G8 guideline (Anonymous, 2008).

Besides the D-2 standard, other standards are developed including the proposed "Californian standard" and USCG Phase-2 standard which do mention bacteria and viruses. No other organisms smaller than 10 µm as phytoplankton, micro-zooplankton and protozoa are mentioned. It is possible to quantify viruses and bacteria in marine and fresh water by flow cytometry. However, it is questionable if it is needed to include viruses in any standard because viruses are not regarded as living organisms. Bacteria occur in high numbers in surface water, but also in drinking water bacteria numbers between  $5.56 \times 10^2$  and  $3.94 \times 10^4$  per ml have been found (Hoefel et al., 2003). Therefore it might be impractical to have a high standard for bacteria when testing BWTS. It is more realistic to have high standards for phytoplankton and zooplankton species below 10 µm in minimum dimension. However when it becomes possible to amend the D-2 standard after ratification, it will be difficult to decide how. While this is still under debate, it is clear that organisms below 10 µm in minimum dimension are important and should be taken into account in the requirements for certification of ballast water treatment systems.

## REFERENCES

- Anonymous. (2004), International Convention for the Control and Management of Ships' Ballast Water and Sediments. International Maritime Organization. <http://www.imo.org>.
- Anonymous. (2008), Guidelines for approval of ballast water management systems (G8).Annex3Resolution MEPC.174(58) Annex: Parts 1,2,3 and 4.
- Burkholder, J.M., Glasgow, H.B. (1997), *Pfiesteria piscicida* and other *Pfiesteria*-like dinoflagellates; Behavior, impacts, and environmental controls. *Limnol. Oceanogr.* 42: 1052-1075.
- Carlton, J.T. (1987), Patterns of Transoceanic Marine Biological Invasions in the Pacific-Ocean. *Bulletin of Marine Science* 41:452-465.
- Dubelaar, G.B.J., Jonker, R.R. (2000), Flowcytometry as a tool for the study of phytoplankton. *Sci. Mar.* 64:135-156.
- Gieskes, W.W.C. and Kraay, G. (1975), The phytoplankton spring bloom in Dutch coastal waters of the North Sea. *Neth. J. Sea Res.* 9:166-196.

- Gollasch, S., David, M., Voigt, M., Dragsund, E., Hewitt, C. and Fukuyo, Y. (2007), Critical review of the IMO international convention on the management of ships'ballast water and sediments. *Harmful Algae* 6:585-600.
- Gómez, F. and Souissi, S. (2010), The diatoms *Odontella sinensis*, *Coscinodiscus wailessii* and *Thalassiosira punctigera* in the European Atlantic: recent introductions or overlooked in the past? *Fresenius Env. Bull.*19:1424-1433.
- Grattan, L.M., Oldbach, D. and Morris, J.G. (2001), Human Health risks of exposure to *Pfiesteria piscicida*. *Bioscience*. 51:853-858.
- Gregg, M.D., Rigby, G. and Hallegraeff, M. (2009), Review of two decades of progress in the development of management options for reducing or eradicating the phytoplankton, zooplankton and bacteria in ship's ballast water. *Aquatic invasions* 4:521-565.
- Hallegraeff, G.M. and Bolch, C.J. (1992), Transport of diatom and dinoflagellate resting spores in ships' ballast water: implications for plankton biogeography and aquaculture. *J. Plankton Res.* 14:1067-1084.
- Hoefel, D., Grooby, W.L., Monis, P.T., Andrews, S. and Saint, C.P. (2003), Enumeration of water-borne bacteria using viability assays and flow cytometry: a comparison to culture-based techniques. *J. of Microbiol. Meth.* 55:585-597.
- Kagami, M. and Urabe, J. (2001), Phytoplankton growth rate as a function of cell size: an experimental test in Lake Biwa. *Limnology*. 2:111–117.
- Kirkpatrick, P., Fleming, L.E., Squicciarini, D., Backer, L.C., Clark, R., Abraham, W., Benson, J., Cheng, Y.S., Johnson, D., Pierce, R., Zaias, J., Bossart, G.D. and Baden, D.G. (2004), Literature review of Florida red tide: implications for human health effects. *Harmful Algae*. 3:99-115.
- Knap, A., Dewailly, E., Furgal, C., Galvin, J., Baden, D., Bowen, R.E., Depledge, M., Dugua, L., Fleming, L.E., Ford, T., Moser, F., Owen, R., Suk, W.A. and Uluata, U. (2002), Indicators of ocean health and human health: developing a research and monitoring framework. *Environ Health Perspect.*110:839-845.
- Liebich, V., Stehouwer, P.P. and Veldhuis, M. (2011), Re-growth of potential invasive phytoplankton following UV-based ballast water treatment. *Aquatic Invasions*. 7 published online doi: 10.3391/ai.2012.7.
- Miller, A.W., Frazier, M., Smith, G.E., Perry, E.S., Ruiz, G.M. and Tamburri, M.N. (2011), Enumerating sparse organisms in ships' ballast water: why counting to 10 is not so easy. *Environmental Science and Technology*. 45:3539-3546.
- Nehring, S. (1998), Establishment of thermophilic phytoplankton species in the North Sea: biological indicators of climatic changes? *ICES J. of Marine Sci.* 55:818-823.
- Ruiz, G.M., Carlton, J.T., Grosholz, E.D. and Hines, A.H. (1997), Global invasions of marine and estuarine habitats by non-indigenous species: mechanisms, extent and consequences. *American Zoologist* 37:621–632.

## THE IMPORTANCE OF ORGANISMS SMALLER THAN 10 µm

Sellner, K.G., Doucette, G.J. and Kirkpatrick, G.J. (2003), Harmful algal blooms: causes, impacts and detection. *J. Ind. Microbiol. Biotechnol.* 30:383-406.

Stehouwer, P.P., Fuhr, F., Veldhuis, M. (2010), A novel approach to determine ballast water vitality and viability after treatment. In: Bellefontaine, N., Haag, F., Linden, O., Matheickal, J., (eds) (2010) Proceedings of the IMO-WMU Research and Development Forum 2010 Malmö, Sweden, 233-240.

Sutherland, T.F., Levings, C.D., Elliott, C.C., Hesse, W.W. (2001), Effect of a ballast water treatment system on survivorship of natural populations of marine plankton. *Mar. Ecol. Prog. Ser.* 210:139-148.

Troussellier, M., Courties, C. and Vaquer, A. (1993), Recent applications of flow cytometry in aquatic microbial ecology. *Biol Cell.* 78:111-121.

Veldhuis, M.J.W., Fuhr, F., Boon, J.P. and Ten Hallers-Tjabbers, C. (2006), Treatment of ballast water; How to test a system with a modular concept? *Environmental Technology* 27:909-921.

Veldhuis, M.J.W. and Kraay, G.W. (2000), Application of flow cytometry in marine phytoplankton research: current applications and future perspectives. *Scientia Marina* 64:121-134.

Vives-Rego, J., Lebaron, P. and Nebe-von Caron, G. (2000), Current and future applications of flow cytometry in aquatic microbiology. *FEMS Microbiology reviews* 24:429-448.

Waite, T.D., Kazumi, J., Lane, P.V.Z., Farmer, L.L., Smith, S.G., Smith, S.L., Hitchcock, G. and Cap, T.R. (2003), Removal of natural populations of marine plankton by a large-scale ballast water treatment system. *Marine Ecology-Progress Series* 258:51-63.

Wonham, M.J., Walton, W.C., Ruiz, G.M., Frese, A.M. and Galil, B.S. (2001), Going to the source: role of the invasion pathway in determining potential invaders. *Marine Ecology-Progress Series* 215:1-12.

Yentsch, C.M., Horan, P.K., Murhead, K., Dortch, Q., Haugen, E., Legendre, L., Murphy, L.S. Perry, M.J. Phinney, D.A., Pomponi, S.A., Spinrad, R.W., Wood, M., Yentsch, C.S. and Zahuranec, B.J. (1983), Flow cytometry and cell sorting: A technique for analysis and sorting of aquatic particles. *Limnol. Oceanogr.* 28:1275-1280.





## ERMA FIRST BWTS: An Integrated and Modular Ballast Water Treatment System – Performance and Compliance with IMO Guidelines

Efi Tsolaki<sup>1</sup>, Konstantinos Stampedakis, Yannis Moulinos, Nikos Kyritsis

---

### **Abstract**

*The ERMA FIRST Ballast Water Treatment System (BWTS), produced by ERMA FIRST ESK SA (Greece), is an integrated ballast water treatment system. It consists of a combination of a mechanical separation system and an electrolysis system. The combination of an automatic back-flushing filter with an advanced cyclonic separator ensures trouble-free operation, as well as efficient removal of biota and particles with a minimum diameter of 50 microns. The separation stage is necessary for conditioning the quality of ballast water before the electrolysis unit. The electrolysis apparatus follows the ballast water conditioning. The unit utilizes special coated electrodes for the production of chlorine as a disinfectant that ensures sufficient chlorine concentration even in low salinity waters. The blockage-free operation of the system, its efficiency and the compliance with the Regulations D2 and Guidelines regulated by the International Maritime Organization through land-based and shipboard testing are demonstrated in this study. It is established beyond doubt that the ERMA FIRST Ballast Water Treatment System could be regarded as a fast and effective way for reducing the number of viable organisms in ballast water of ships.*

**Keywords:** ballast water, electrolysis, mechanical separation, D2 standards, risk assessment.

---

### **1 Introduction**

The introduction of invasive marine species into new environments by the discharge of a ship's ballast water, the attachment of these species to a ship's hull and via other vectors has been identified as one of the four greatest threats to the world's oceans. Shipping moves over 80% of the world's commodities and transfers approximately 3 to 10 billion tonnes of ballast water internationally each year.

Ballast water is essential to the safe and efficient operation of modern shipping providing balance and stability to ships. The translocation and release of ballast water causes environmental, economic and health threats that are concerns of governments, maritime environmental entities and public health organizations. As shipping is probably the most international industry, the only effective way to address shipping-related issues is through a standardized international system. This has been one of the targets of IMO during the last 50 years of its existence. IMO member States adopted a new ballast water Convention in

---

<sup>1</sup> ERMA FIRST ESK ENGINEERING SOLUTIONS S.A.

February 2004. The International Convention for the Control and Management of Ships' Ballast Water and Sediments was adopted by a Diplomatic Conference at IMO in London on Friday, 13 February 2004. As of September 2011, the Convention had been ratified by 28 contracted states, representing 26.37% of world tonnage. In order to attain the necessary ratification of the Convention in the near future, the urgent of approval of systems is more important than ever. The ERMA FIRST BWTS has been designed and developed by ERMA FIRST ESK Engineering Solutions SA, a Greek company established to produce a sound and reliable ballast water treatment system.

ERMA FIRST'S R&D department started operational research in 2006 for the development of the ballast water treatment system, exploring various aspects of the electrochemical generation of sodium hypochlorite in relation to the biological efficacy required by the D2 performance standard of the Convention. Laboratory testing was conducted that was aimed at evaluating the efficacy of the whole process, testing different concentrations of free active chlorine on representative species of taxonomic groups that prevail in the fraction of less than 20  $\mu\text{m}$  of filtered sea water. In the bench-scale testing that followed, issues such as dose effectiveness were assessed to determine the optimum operational characteristics of the system and the need for neutralization of residual products before discharge of treated ballast water into the sea.

In this study, the operation of the system is demonstrated, as well as its efficiency and the compliance with the Regulations D2 and Guidelines regulated by the IMO through land-based and shipboard testing.

## **2 ERMA FIRST Ballast Water Treatment System Overview**

The ERMA FIRST BWTS is an integrated, autonomous and modular treatment system for ballast water, jointly developed by a group of scientists and engineers with extensive experience in the design and production of equipment for ship-generated liquid waste treatment.

The treatment process includes two distinctive stages – a primary stage that enables the separation of coarser suspended materials and relatively larger living organisms in ballast water and a secondary stage, in which electrolytic disinfection takes place to meet the required biological efficacy standard for treated ballast water as stipulated in the Convention.

At the primary stage of the process, removal of material with diameters larger than 20  $\mu\text{m}$  is accomplished by means of an advanced cyclonic separator made from frictionless material. To prevent blocking of the separator from large particles that might pass through the sea

chests and strainers of the vessel, a 200 µm self-cleaning basket filter has been installed prior to the separator.

Electrolysis of ballast water to produce *in situ* free active chlorine up to 10 mg/L constitutes the second stage of treatment that takes place during ballasting. The products of this process flow into the ballast tanks of the vessel, so that the residual oxidants disinfect any harmful organisms taken onboard. Integral components of the system are the control and monitoring equipment that ensure its proper operation as well as the neutralization process of treated ballast water prior to its eventual discharge into the sea.

The operational status of the system is continuously monitored at a central data logger, located on the central control panel of the system. Data logging includes the operation status of the system, operation, flow and temperature at the electrolytic cell, pressure differences across the self-cleaned filter and the cyclonic separator, the operational status of the neutralizing agent dosing pump, as well as the chlorine level of the system. The control panel can be positioned into the cargo control room of the vessel.

### **3 ERMA FIRST BWTS OPERATION**

The ERMA FIRST BWTS is an autonomous fully automatic operational unit. The system has two different operational modes, one during ballasting and one during the discharge of treated ballast water (de-ballasting). The two operational modes are described in the following paragraphs.

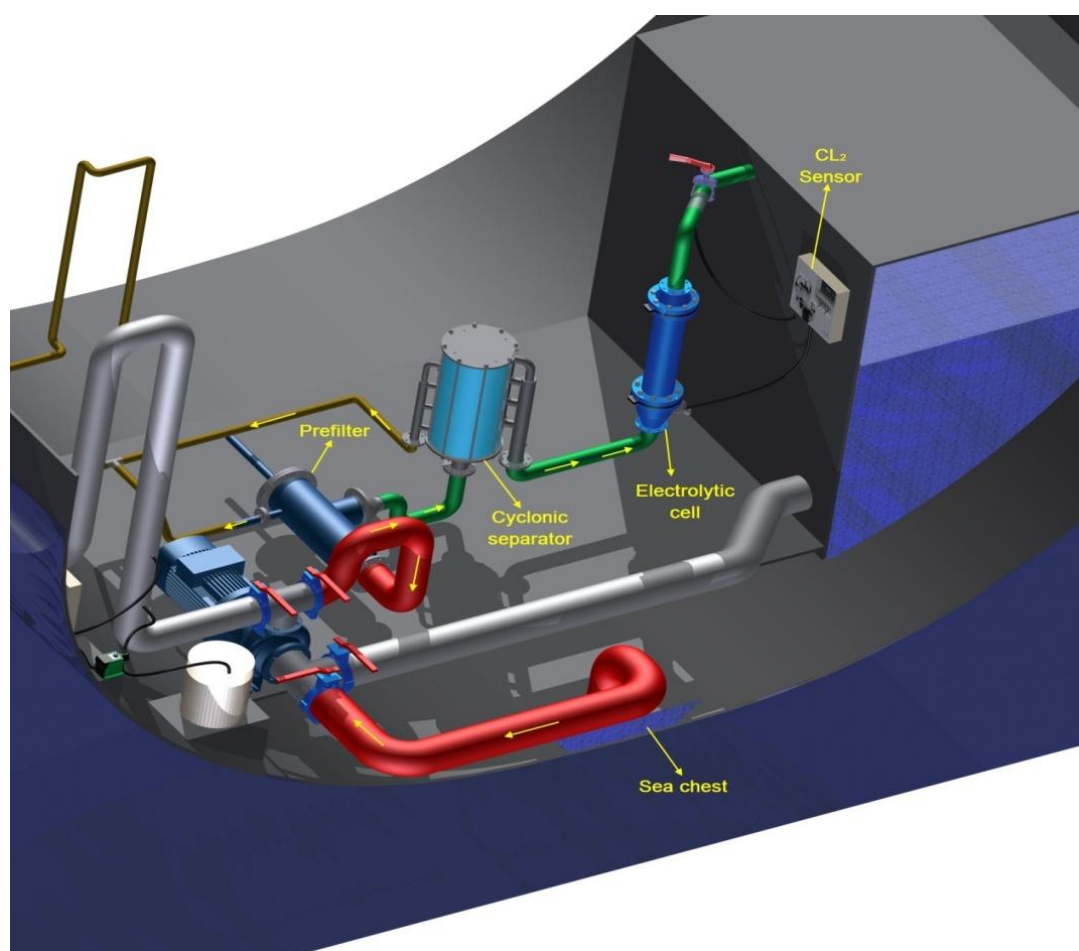
#### **Mode one: Ballasting**

During ballasting, ballast water passes through the 200 µm pre-filter and then into the cyclonic separator. The underflow stream rich in sediments and coarse material from the latter returns back into the sea via a drain line. The overflow enters the electrolytic cell. A flow sensor, installed upstream of the cell provides a signal to the cell through the PLC of the system to apply a DC current to the electrodes in order to initiate the electrochemical process and the production of the Active Substances. A free chlorine sensor (TRO sensor), located downstream of the cell, monitors the free chlorine concentration.

The production rate of the Active Substances is continuously adjusted in accordance with the ballast flow rate and the measurement of the free chlorine at the sensor. Depending on the flow rate and the free chlorine measurement, the voltage at the cell changes in order to maintain the pre-set free chlorine concentration.

The electrolytic cell of the system has been specifically designed to produce the identified Active Substances at temperatures as low as 5°C and a water salinity > 6.0 PSU. The ability

of the cell to produce free chlorine under such conditions is based on the special coating material of its electrodes, and also on its design that enables sufficient contact time of chlorides in the water stream with the electrodes, thus providing enough contact time to convert into Active Substances.



**Figure 1. Operation mode during the ballasting**

Similarly, the electrolytic cell of the system can operate effectively in salinities above 32 PSU, due to the fact that water of such salinity results in high electrical resistance, and thus, the PLC of the system will adjust the voltage at the electrodes in such manner to maintain the production of free chlorine at the pre-set values. The whole unit is current-driven, controlled by the chlorine sensor arranging for the set concentration and current applied to the electrodes resulting in a specific amount of active substance production. By monitoring the operating Amperes on the electrodes of the cell and adjusting the applied voltage, the PLC of the system ensures a constant production rate of Active Substances in an extended salinity and

temperature range. Note that the ballast water management system can be bypassed using the appropriate valve arrangement (e.g., in cases of emergency).

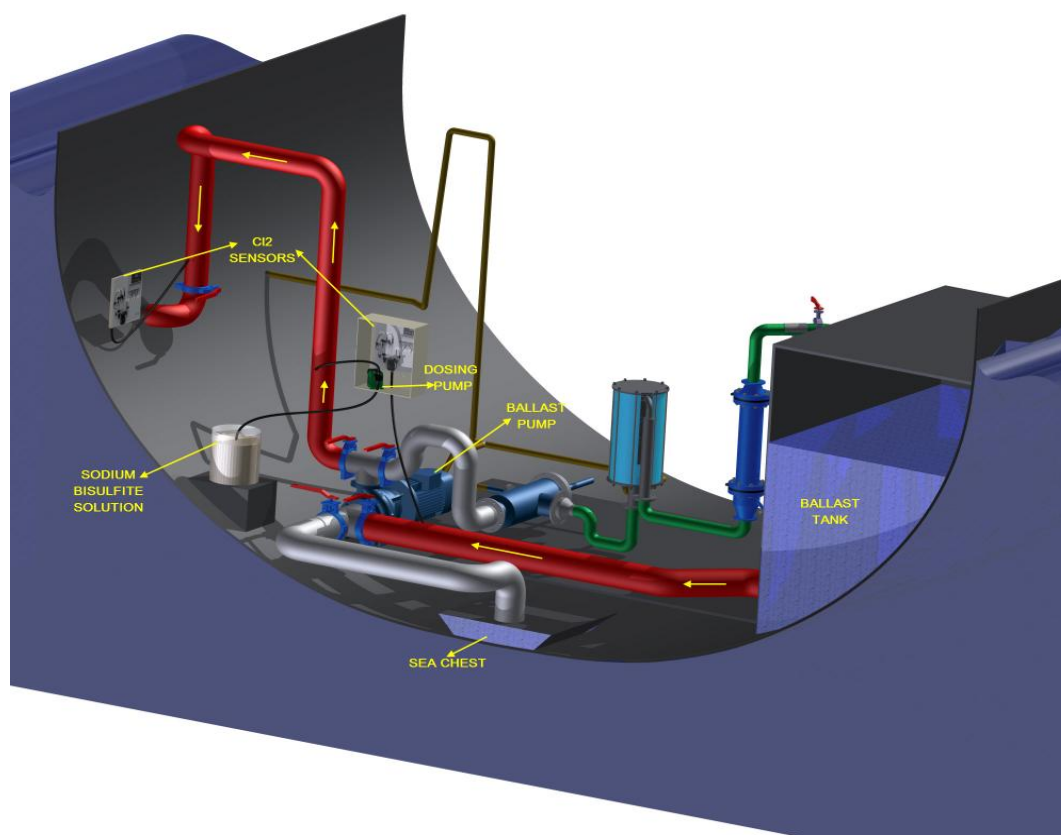
### **Operation mode two: Deballasting**

During de-ballasting, neutralization of the total residual oxidants takes place by adding an aqueous sodium bisulfite solution (38% w/w). At this mode, the pre-filtering equipment, the cyclonic separator and the electrolytic cell of the system are bypassed with the exception of the free chlorine sensor.

For the efficient control of the neutralizing process during de-ballasting, and the avoidance of the surplus consumption of the neutralizing media, the ERMA FIRST system is equipped with an additional chlorine sensor. The new chlorine sensor is of the same type as the two others already equipped on the system, and it is installed at the de-ballasting line prior the neutralizing agent injection point. The reading of this sensor drives the dosing rate of the neutralizing pump. The dosing rate of the neutralizing pump is based on the stoichiometry of the neutralization reaction between the chlorine and sodium bisulfite.

From the stoichiometry of the reaction for the neutralization of 1 mg/L of chlorine, 1.5-1.7 mg/Li (Metcalf & Eddy, 2003) of sodium bisulfite (i.e. for the 10 mg/L concentration of total residual oxidants) and 17 mg/L of NaHSO<sub>3</sub> are required for effective neutralization. According to this stoichiometry and the readings of the free chlorine sensor installed upstream of the dosing point, a neutralizing pump is activated. By using a safety margin of 10%, the dosing pump of the neutralizing agent should be set at a point to deliver 18.7 mg/L sodium bisulfite.

As recommended, a discharge control point for TRO has been added to the system with the fitting of a second sensor in the deballasting procedure that will ensure that the maximum allowable discharge concentration (MADC) of 0.2 mg/L (as Cl<sub>2</sub>) will not be exceeded. The third sensor of the system is installed on the far end point of the de-ballasting line, after the neutralization injection point but close to the discharge point. This sensor confirms that the chlorine concentration is well below the MADDC. In case that the total chlorine level at the discharge will reach the maximum MADDC of 0.2 mg/L, then the dosing rate of the pump of the neutralization unit will increase in order to reduce the TRO to the recommended lowest MADDC. A schematic diagram of the operation of the system during de-ballasting is illustrated in figure 2.



*Figure 2. Operation mode during deballasting*

#### **4 Efficacy of the ERMA FIRST BWMS**

The land-based testing of the ERMA FIRST ballast water treatment system according to IMO respective G8 and G9 Guidelines was successfully completed in July 2010 in the testing facility of the Royal Netherlands Institute for Sea Research in the Netherlands, demonstrating the effectiveness of the system to comply with the D2 performance standard, as well as its reliability and environmental acceptability. The Whole Effluent Toxicity Testing that was conducted during the land-based testing proved that the discharge of neutralized treated ballast water is not toxic, as no toxic effects were observed to the organisms exposed.

##### **Compliance with the Regulations D2 and Guidelines**

The ERMA FIRST followed the appropriate procedure as indicated by the Guidelines, in order to obtain Basic, Final and Type Approval for its ballast water treatment system. ERMA FIRST collaborated with the expert scientists, from among the most knowledgeable in the field, in order to be competent in the market of ballast water systems.

At first, Basic Approval was granted in the MEPC 62 (July 2011), as the Application for Basic approval was recommended by 15th GESAMP meeting (December 2010). Application for Final Approval was submitted to the Secretary of IMO to be evaluated in the 63<sup>rd</sup> MEPC (March 2012).

Land-based tests were carried out at the Royal Netherlands Institute for Sea Research (NIOZ), in the Texel, Netherlands, from March through July 2010. The system was a full-scale commercially available system. The hydraulic capacity of the system tested was 100 m<sup>3</sup>/h.

Shipboard tests on board M/V COSCO GUANGZOOU (IMO No. 9305570), a 9600 TEU container vessel, were carried out from January until June 2011. The system was modular of hydraulic capacity 500 m<sup>3</sup>/h.

### Land-based testing

Land-based tests were carried out at the Royal Netherlands Institute for Sea Research (NIOZ, [www.nioz.nl](http://www.nioz.nl)) in the Texel, Netherlands, from March through July 2010 [3]. The system was a full-scale commercially available system. The hydraulic capacity of the system tested was 100 m<sup>3</sup>/h (NIOZ, 2011).

A summary of water parameters in the NIOZ test facility is presented in the Table 1. The procedure was in conformance with Guidelines for approval of ballast water management systems (G8).

**Table 1 Summary of water parameters in the NIOZ test facility.**

Parameter	Value
Temperature (°C)	Variable
Salinity (PSU)	20-34
TSS (mg/l)	5-400
POC (mg/l)	5-20
DOC (mg/l)	1-5
Organisms $\geq 50\mu\text{m}/\text{m}^3$	10,000-1,000,000
Organisms $<50 \geq 10\mu\text{m}/\text{m}^3$	100-100,000
Heterotrophic bacteria /ml	10,000-10,000,000

(Source: Report of Global expert workshop on harmonization of methodologies for test facilities of ballast water management systems (24-25 January 2010) World Maritime University, Malmö, Sweden)

### Physical and chemical analysis of treated ballast water

Sample handling and volumes were in accordance with G8 Guidelines. Temperature, pH, Dissolved Oxygen, DOC, TSS/POC were monitored prior, during and after ERMA FIRST



ballast water discharge. Also, chlorine decay was studied in-situ using samples from the ballast tanks. Chemical analyses for disinfection by-products of treated ballast water were performed also during land-based testing by OMEGAM Laboratories. Relevant chemicals were measured for both low and high salinity test cycles at Day 1 and Day 5 of treatment.

### **Total Residual Oxidants**

During each test cycle, the concentration of the active compound (Total Chlorine) was measured as soon as possible after filling of the treated ballast water tank, also at regular intervals during the 5-day holding period, and during discharge.

Total Residual Oxidant (TRO) was measured as total chlorine using the Hach portable spectrophotometer DR 2800. The device employs the DPD Method accepted for reporting water analyses by the USEPA and is equivalent to USEPA method 330.5 for wastewater and Standard Method 4500-Cl G for drinking water. The method had a detection limit of 0.02 mg/L as Cl<sub>2</sub>. Samples were collected from the ballast tanks immediately after the completion of ballasting and afterwards every 24h from the ballast tank.

Retention time was 120 h. Neutralization occurred five days after ballasting during discharge of the ERMA FIRST treated water. TRO as chlorine was not detected post neutralization procedure.

### **Disinfection By-products**

All samples were taken at discharge to ensure that the data represent full-scale employment. Samples indicated that trichloromethane was the only non-detectable THM (Trihalomethanes) compound. The following HAA (haloacetic acids) had measurable concentrations in treated ballast water: Monobromoacetic acid, bromochloroacetic acid, dibromoacetic acid, tribromoacetic acid and dibromochloroacetic acid. Bromate was also detected once. In low salinity water, the most predominant haloform was tribromomethane, comprising more than 95% of the total trihalomethanes. Dibromochloromethane and bromodichloromethane constituted 2% and 3%, respectively. Trichloromethane was not detected. The most predominant haloacetic acid was dibromoacetic acid, accounting for more than 83% of the total haloacetic acids. Tribromoacetic acid, bromochloroacetic acid and monobromoacetic acid constituted up to 12%, 3% and 2%, respectively. Monochloroacetic acid, dichloroacetic acid, trichloroacetic acid, dibromochloroacetic acid and bromodichloroacetic acid were not detected.

In high salinity water, the most predominant haloform was tribromomethane, accounting for more than 98% of the total trihalomethanes. Dibromochloromethane constituted 2% of the total trihalomethanes. Trichloromethane and bromodichloromethane were not detected. The

most predominant haloacetic acid was tribromoacetic acid, accounting for more than 93% of the total haloacetic acids. Dibromochloroacetic acid and dibromoacetic acid constituted up to 1% and 6%, respectively. Monochloroacetic acid, monobromoacetic acid dichloroacetic acid, trichloroacetic acid, dibromochloroacetic acid and bromodichloroacetic acid were not detected. Bromate was only detected in high salinity test cycle on Day 5. Higher concentrations of bromo haloacetic acids in seawater could be attributed to a high bromide content of the seawater.

### Biological effectiveness

Sample handling and volumes were in accordance with G8 Guidelines. Organisms larger than 50 µm were collected using modified Hydrobios net. The effluent of the Hydrobios net was collected and corresponded to the fraction of organisms 10 to 50 µm. A 10 µm sieve was used to filter a subsample from the effluent net in order to enumerate organisms less than 10 µm.

The analyses of bacteria (total heterotrophic bacteria) and human pathogens (Intestinal Enterococci and *E. coli*) were carried out according to international standards NEN-EN-ISO 6222:1999; 7899-2; 9308-1, respectively.

**Table 2. Summary of Biological Efficiency of ERMA FIRST BWTS of Land-Based Testing in NIOZ.**

ERMA FIRST Treated ballast water							
Run test	Organisms						Comply with D2 standards
	>50 µm (numbers/m <sup>3</sup> )	<10 µm (numbers/m <sup>3</sup> )	10-50 µm numbers/m <sup>3</sup> )	E. coli (cfu/mL)	Enterococci (cfu/100mL)	Total bacteria (counts/mL)	
I	19.7	26.2	10.3	<0.1	<1	1.87E+06	X
II	2.3	62.7	0.8	<0.1	<1	1.20E+05	√
III	2	19.8	0	<0.1	<1	8.20E+04	√
IV	1.7	5.6	0	<0.1	<1	1.53E+05	√
V	2.7	41.3	0	<0.1	<1	1.66E+05	√
VI	2.7	3.2	0.8	<0.1	<1	2.20E+05	√
VII	0	1.6	0	<0.1	<1	2.09E+05	√
VIII	0.3	0.8	0	<0.1	<1	1.88E+05	√
IX	0.3	3.2	0	<0.1	<1	2.37E+05	√
X	0	0	0	<0.1	<1	2.13E+05	√
XI	0	6.3	0.8	<0.1	<1	2.22E+05	√

All 10 test runs were effectively conducted according to the IMO's G8 Guidelines. During test runs, the numbers of viable organisms at discharge were at least one order of magnitude

lower than the D2 Standard. The residual number of organisms at discharge was well in compliance with the D2 Standard.

All detailed data are presented in the official NIOZ report (NIOZ Report, 2011), and a summary of the 11 run cycles of two conditions of ballast water are presented in Table 2. With the exception of the first run, all 10 subsequent runs were successful in complying with D2 standards.

### **Ecotoxicity testing of treated ballast water, land based testing**

The toxicity of treated ballast water was evaluated at the laboratories of the Institute for Marine Resources & Ecosystem Studies – IMARES in Den Helder, Netherlands [5].

Four bioassays were performed representing four different phyla of marine organisms, the marine diatom *Phaeodactylum tricornutum*, the crustacean *Artemia franciscana*, the rotifer *Brachionus plicatilis* and the fish larvae *Solea solea* (IMARES, 2010).

Treated ballast water and neutralized treated ballast water were evaluated in two salinity regimes in a concentration series that was made by diluting test water with untreated ballast water. Algal growth inhibition tests were carried out with water sampled directly after treatment (T0) and storage for 1 day (T1), 2 days (T2) and 5 days (T5), respectively, while the tests for the other organisms were carried out following the storage of treated ballast water for 1 day (T1) and 5 days (T5).

#### *Algae growth inhibition Phaeodactylum tricornutum*

Algal growth inhibition by exposure to a sample is determined by the so-called algal growth inhibition test according to ISO 10253 (2006) and OECD 201 (1984) procedures. Exposure to neutralized treated ballast water did not result in reduced growth of *Phaeodactylum tricornutum* in most growth inhibition tests.

#### *Rotifer mortality test with Brachionus plicatilis*

The test applied is commercially available as Testkit at MicroBiotest Inc., Belgium, under the name ROTOXKIT M and performed according to the Standard Operational Procedure provided by the manufacturer. No mortality was observed in any of the rotifer tests with exposure to neutralized, treated ballast water.

#### *Crustacean mortality with Artemia franciscana*

The Crustacean mortality test was performed in a multi-well testplate using instar II-III larvae of the brine shrimp *Artemia franciscana*, obtained as dried cysts from Microlan B.V., Netherlands. The test conformed with the Standard Operational Procedure for ARTOXKIT

M™ (MicroBioTests Inc. V100603). No mortality was observed in any of the crustacean tests with exposure to neutralized, treated ballast water.

Fish mortality test with *Solea solea*

The fish mortality test protocol is based upon OECD-203 (1992). No mortality was observed in any of the fish tests with exposure to neutralized, treated ballast water.

### Shipboard testing

Shipboard testing of the system is being currently conducted onboard a 9600 TEU, Greek-flagged, container vessel, Cosco Guangzhou. Until now, three successful test cycles have been conducted from January to August 2011, which are presented in Table 3 below. ERMA FIRST collaborated with GoConsult for the performance procedure of the shipboard testing.

**Table 3. Summary of Biological efficiency of ERMA FIRST BWTS of Shipboard Testing**

ERMA FIRST Treated ballast water							
Run test	Organisms						
	>50 µm (numbers/m <sup>3</sup> )	<10 µm (numbers/m <sup>3</sup> )	10-50 µm (numbers/m <sup>3</sup> )	E. coli (cfu/mL)	Enterococci (cfu/100mL)	Vibrio cholerae (counts/mL)	Comply with D2 standards
I	1.9	nd	Nd	Nd	2	nd	√
II	1.2	nd	Nd	Nd	5.3	nd	√
III	4.4	nd	Nd	Nd	3.7	nd	√

nd: not detected

IMO Guideline G8 was followed and met during trial tests. The D2 standard was met during uptake and discharge procedures.

### Corrosion testing

ERMA FIRST contracted TNO to evaluate the corrosivity of the ERMA FIRST system following the recently published GESAMP recommendations for corrosivity testing (MEPC 59.2.16, Report of the 8<sup>th</sup> GESAMP meeting group). The aim of this study was to compare the corrosivity of seawater treated with the ERMA FIRST BWTS relative to untreated seawater. The different corrosivity tests were performed on coated and uncoated samples according to the above mentioned GESAMP recommendations [6]. The project ended in the middle of August of 2011 and the complete report will be submitted for the Type Approval procedure (TNO, 2010).

A 6-month corrosion testing project was carried out by TNO, involving certain immersion tests of coated and uncoated materials, as well as electrochemical measurements, summarized below:

- Crevice corrosion testing of stainless steel alloys AISI 316L and AISI 304 in treated seawater and untreated seawater,
- Cyclic potentiodynamic polarization measurements to determine relative susceptibility to localized corrosion (pitting and crevice corrosion) in treated seawater and untreated seawater for the varying materials (i.e. Stainless steel alloy AISI 316L; Stainless steel alloy AISI 304; Low carbon steel ST 37 and CuNi 90-10),
- Immersion corrosion testing for varying materials (i.e. Stainless steel alloy AISI 316L; Stainless steel alloy AISI 304; Low carbon steel ST 37; CuNi 90-10 and Rubber),
- Determination of the resistance of intact and damaged coatings (which were applied according to the standard specifications) to the effects of treated water and untreated water, and evaluation of the adhesion of coatings and the degree of blistering,
- Measurements of the electrochemical impedance spectroscopy of coatings.

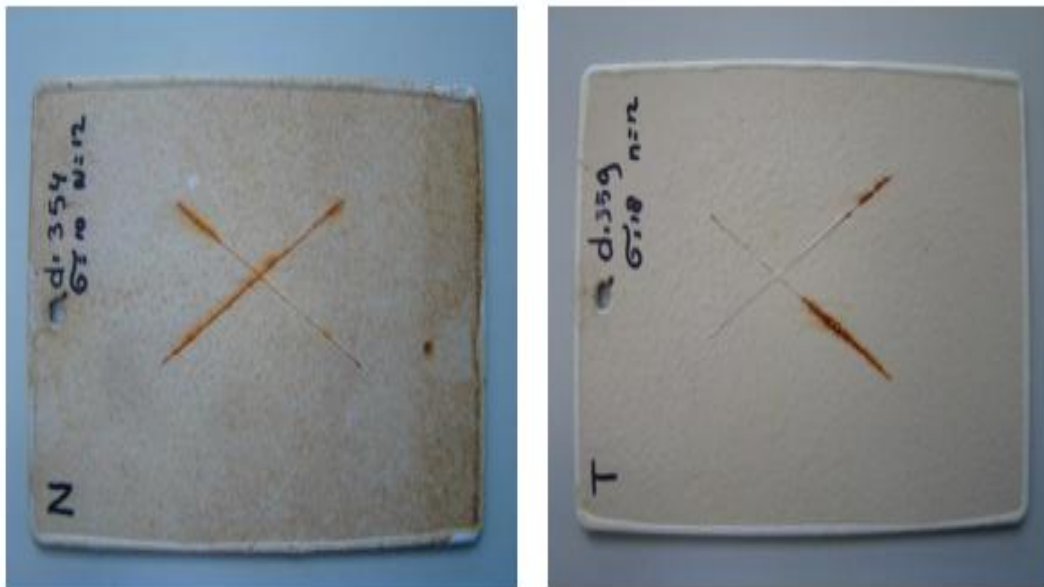
The medium in which the tests were performed was filtrated (50 $\mu$ m) natural seawater of North Sea origin. All tests were conducted in two separate media to enable the comparison of corrosivity between treated and untreated seawater. Both testing media (treated and untreated sea water) were refreshed each working day. The duration of the test was six months.



**Figure 3. Corrosion on AISI 316 (top) and AISI 304L (bottom) materials in untreated seawater (left) and treated seawater from the ERMA FIRST BWTS (right) after 90 days.**

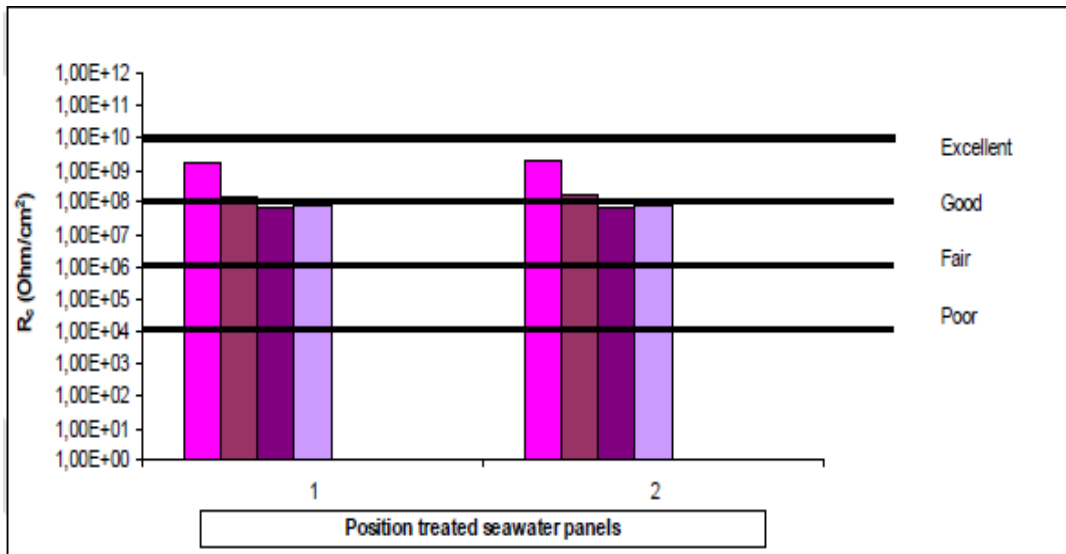


*Figure 4. Intact coated panels in untreated water for 90 days (left) and intact coated steel panels in treated water for 90 days (right).*

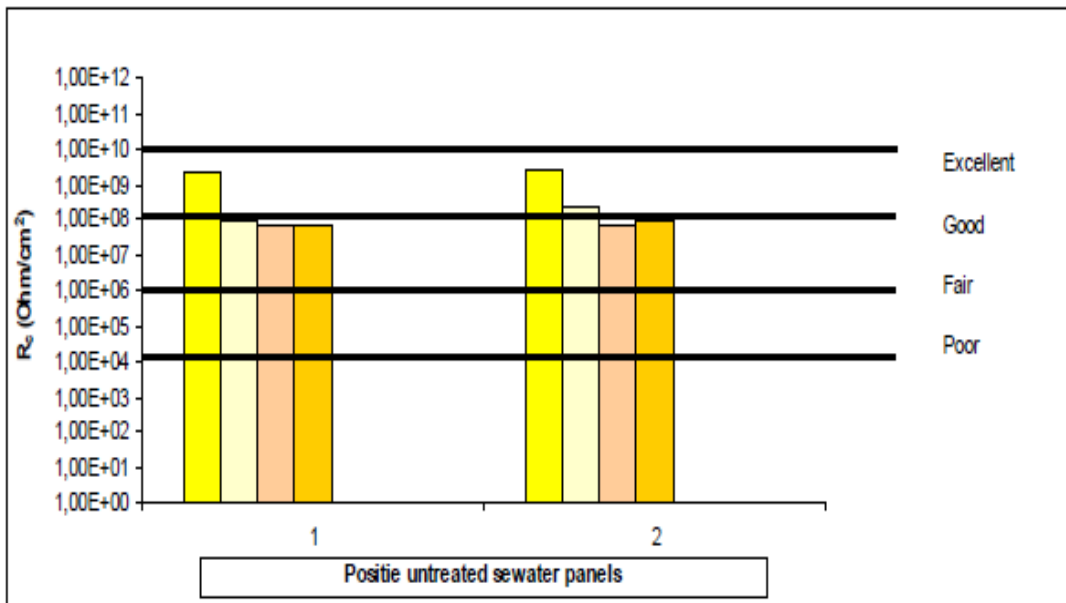


*Figure 5. Scratched coated panels in untreated water for 90 days (left) and scratched coated steel panels in treated water for 90 days (right).*

For treated and untreated seawater, electrochemical impedance spectroscopy measurements were performed in two-fold after 0, 1, 7 and 21 days, and 1, 2, 3, 4, 5 and 6 months of immersion.



**Figure 6. Development of coating resistance in treated seawater after 1 day, 30 days, 60 days and 90 days.**



**Figure 7. Development of coating resistance in untreated seawater after 1 day, 30 days, 60 days and 90 days.**

The measurements taken after 90 days of immersion show that the value of coating resistance is approximately 108 ohm·cm<sup>2</sup>. Both treated and untreated seawater panels have similar coating resistance. This indicates that the protective properties of the

coating in treated and untreated seawater meets the resistance commonly found in practice for good protective coatings with this layer thickness.

## 5 Discussion

The ERMA FIRST BWTS is an integrated, autonomous and modular treatment system for ballast water treatment. The benefits offered from the pre-filtering and the cyclonic separation towards the removal of coarse inorganic and organic material present in ballast water relate to a lower disinfectant concentration demand, which, in turn, results in less energy consumption and less consumption of electrode coatings.

The Land-Based Tests performed in the challenging Wadden Sea in NIOZ, Texel, The Netherlands, and the Shipboard Tests on board *M/V COSCO GUANGZHOU* (IMO No 9305570), a 9600 TEU container vessel, presented excellent results, reaching discharge limits far below the IMO D-2, revealing a prospective and promising performance even for the stricter United States Certification requirements.

Ecotoxicity testing demonstrated that the discharge of neutralized treated ballast water was not toxic, as no toxic effects were observed to the organisms exposed during the testing. The testing further confirmed the necessity of the neutralization of treated ballast water.

Corrosion testing was performed according to GESAMP recommendations for corrosivity testing (MEPC 59.2.16, Report of the 8<sup>th</sup> GESAMP meeting group). With regard to the evaluation of coatings, the visual examination of all panels after 3 months of exposure showed comparable results in treated and untreated water. Specifically, no deposits were present on the coatings, no degradation of coatings were observed and no blistering was present; while the damaged panels showed corrosion in a similar manner as in the untreated scenario. Corrosion rates of specimens will be available after the finalization of the report by the TNO and will be available for the Type Approval procedure.

Enforced by the above unique features, ERMA FIRST is promptly coming one significant step closer to the Final Approval and Type Approval process. Lloyds Register Classification Society, who are further supervising shipboard Tests, are currently performing the technical appraisal of ERMA FIRST, and will be in a position to officially issue the Type Approval on behalf of Hellenic Flag in March 2012.

## REFERENCES

*Metcalf and Eddy* (2003), ISBN McGraw-Hill Science/Engineering/Math; 4th Edition.



MEPC 61.2.11 Application for Basic Approval of the ERMA FIRST Ballast Water Management System.

NIOZ (2011), Final Report of the Land based testing of ERMA FIRST Ballast Water treatment system, for type approval according to Regulation-D2 and the relevant IMO Guidelines.

Report of Global expert workshop on harmonization of methodologies for test facilities of ballast water management systems (24-25 January 2010) World Maritime University, Malmö, Sweden.

IMARES Report C093/10 Toxicity test with ballast water from ERMA FIRST SA BWMS land based tests, August 2010.

TNO (2011), Report Evaluation of the corrosivity of the ERMA FIRST BWTS according to GESAMP Recommendations.

## Lab-Scale Chlorine Generation

Ceren Bilgin Güney<sup>1</sup>, Fatma Yönsel

---

### **Abstract**

*Chlorine disinfection is one of the most commonly considered techniques for ballast water treatment. The main areas of concern with respect to using chlorine disinfection for ballast water organisms are the safety risk during handling and onboard storage of chlorine gas or HOCl solutions. Electrochemical generation of active chlorine onboard is a good alternative to eliminate these unfavorable features of chlorine disinfection.*

*A new hybrid ballast water treatment system has been developed within the project, “BaWaPla – Sustainable Ballast Water Management Plant”, funded by the European Union under contract number 031529. This self-controlled system consists of filter systems, UV and electrochemical technologies. The electrochemical component of BaWaPla produces active substances onboard through electrolysis of seawater and eliminates the need to carry or store hazardous and corrosive chemicals.*

*This study covers some of the laboratory-scale experiments conducted by Istanbul Technical University for the best and optimal electrochemical cell design. Five different electrochemical cells were assessed for the BaWaPla system. The cells were supplied from FumaTech GmbH, Germany. A laboratory system was provided to Istanbul Technical University by the project partner, LVPG GmbH, Germany. This system was used for testing assumptions and proposals for the best and optimal cell design. The final cell design for the BaWaPla Pilot System was tested at Blyth, England, during the period from July to September 2009.*

**Keywords:** Ballast water treatment, chlorine generation, electrochemical cells

---

### **Nomenclature**

**A:** Amperage

**ASW:** Substrate prepared with tap water

**DI:** Substrate prepared with deionized water

**mg/L:** milligrams per liter

**Sal:** Salinity

**SW:** Substrate prepared with seawater

## **1 Introduction**

Ballast water treatment has been widely studied throughout the last decade. The studies have focused on different technologies (Tsolaki and Diamadopoulos 2009, Abu-Khader et al.,

---

<sup>1</sup> Istanbul Technical University, Faculty of Naval Architecture and Ocean Engineering Department of Naval Architecture and Marine Engineering.

2011). Both chlorine disinfection and electrochemical systems are among those considered techniques for ballast water treatment.

Chlorine is a well known and widely used disinfectant around the world [Sawyer et al., 1994; Hammer and Hammer Jr., 2004], and it has also been proven to be effective for disinfection of many ballast water organisms at different concentrations [Stocks, 2004; Zhang et al., 2004; Derek et al., 2006]. The main areas of concern with respect to the use of chlorine disinfection for ballast water organisms is the safety risk during handling and onboard storage of chlorine gas or HOCl solutions.

On the other hand, there are number of studies for using electrochemical systems for ballast water treatment. Some of these studies are focused on the direct electrolytic disinfection of ballast water [Dang et al., 2004; Kim et al., 2006, Tsolaki et al., 2010)], while others aim to produce disinfectant to be used for treatment [Aliotta et al., 2003; Lefler et al., 2004; Matousek et al., 2006].

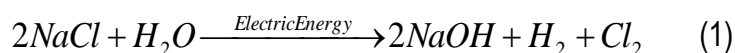
In-situ electrochemical generation of chlorine onboard would have many advantages, such as eliminating storage and handling of chlorine gas or HOCl solutions [Kraft et al., 1999; Jonnalagadda and Nadupalli, 2004; Kerwick et al., 2005]. This technique depends on the electrolysis of sodium chloride, which is readily found in seawater.

In electrochemical systems, resultant disinfectant fluid can be affected by the design of the electrochemical cell and the selection of material used to produce the permeable membrane that separates the fluid paths, as well as the electrical current applied to the electrodes. The choice of the materials used for coating the relevant electrodes must also be considered.

This work has been conducted within the project, "BaWaPla – Sustainable Ballast Water Management Plant", funded by the European Union under the contract number 031529, which began 15 November 2006, and was finalized 15 May 2010. A new hybrid ballast water treatment system was developed during the project. This self-controlled system consists of filter systems, UV and electrochemical technologies. The electrochemical component of BaWaPla produces active substances onboard through electrolysis of seawater and eliminates the requirement to carry or store hazardous and corrosive chemicals. The portion of the work presented herein covers some of the laboratory-scale experiments conducted by Istanbul Technical University for the best and optimal electrochemical cell design. In this study, five different electrochemical cells are assessed for the BaWaPla system. The cells are supplied from FumaTech GmbH, Germany. The variable parameters of the cell design are the geometry and dimensions of the electrodes, and the materials used for the electrodes and their coatings.

## 1.1 BACKGROUND

The electrolysis of sodium chloride is also referred as the chlor-alkali process. As a result of this process, chlorine, sodium hydroxide and hydrogen are formed simultaneously [Rajeshwar and Ibanez, 1996; Srinivasan, 2006].



Within the chlor-alkali process, brine passes through the first chamber of the electrochemical cell and the chloride ion ( $Cl^-$ ) is oxidized at the anode as:



In the membrane cell, the anode and cathode are separated by an ion-permeable membrane in the center of the cell, and this membrane allows only the liberated sodium ions ( $Na^+$ ) to pass through to the second chamber. The unreacted sodium chloride ( $NaCl$ ) and other ions cannot pass through the membrane.

At the cathode, hydrogen in water is reduced to hydrogen gas, releasing hydroxide ions into the solution (eq.3). Simultaneously, the chlorine gas that is formed by oxidation of  $Cl^-$  reacts with water in the first chamber. Hypochlorous acid ( $HOCl$ ) and hydrochloric acid are formed (eq.4) [Abdul-Wahab and Al-Wesbahi, 2009].



On the other hand, protolysis of  $HOCl$  yields to hypochlorite ion ( $OCl^-$ ), depending upon pH and temperature:



$$K_a = \frac{[H_3O^+][OCl^-]}{[HOCl]} = 2,5 \times 10^{-8} \text{ at } 20^\circ\text{C} \quad (6)$$

$$\%[HOCl] = \frac{100}{\frac{K_a}{[H_3O^+]} + 1} \quad (7)$$

$$[H_3O^+] = 10^{-pH} \quad (8)$$

The product in the first compartment, such as elemental chlorine ( $Cl_2$ ), hypochlorous acid (HOCl) and hypochlorite ion, constitute “free available chlorine”, which is the first concept of chlorine disinfection. If there is ammonia in water, chlorine reacts with ammonia and forms chloramines (Hammer, M. J., and Hammer M.J.Jr., 2004; Vijayaraghavan, K. et al, 2004; Walter, J. and Weber, J. R., 1972). The chloramines are referred as “combined available chlorine”, which is the second concept of chlorine disinfection. And finally, the sum of free available and combined available chlorine constitutes the “total available chlorine” in the chlorine disinfection process.

The disinfection effect of the combined available chlorine is dramatically less than the free available chlorine. For the disinfection of cysts of *E. histolytica*, dichloramines ( $NHCl_2$ ) were found to be 60% as efficient as HOCl, and monochloramines ( $NH_2Cl$ ) were found to be 22% as efficient as HOCl under comparable conditions (Walter, J. and Weber, J. R., 1972). Considering the contact time for a bactericidal effect, 100 times more contact time is needed for combined available chlorine compared to the same amount of free available chlorine (Oğur et al., 2004).

## 2 MATERIALS AND METHODS

### 2.1 EXPERIMENTAL DESIGN AND TEST SYSTEM



**Figure 1. Test System**

## LAB-SCALE CHLORINE GENERATION

A laboratory system was provided to Istanbul Technical University by one of the Project partners, LVPG GmbH, Germany. This system was used for various test assumptions and proposals for the best and optimal cell design. Employing electrolysis techniques to produce disinfectants, saline water/seawater is introduced into an electrochemical cell in the heart of the test system. Electrochemical reaction within the cell results in the production of highly effective “Hypochlorous acid-rich” disinfectant. The disinfectant produced with the regular current direction is called AnoFluid, whereas the disinfectant produced with the reverse current direction is called CathoFluid.

### 2.2 Electrochemical Cells

In this study, five different electrochemical cells are assessed for the BaWaPla system. The cells are been supplied from FumaTech GmbH, Germany. The cells are referred as “standard cell, FTEC 100, FTEC 500, EC 100 Nr. 201, EC 100 Nr. 240”. The variable parameters of the cell design are the geometry and dimensions of the electrodes, and the materials used for the electrodes and their coatings<sup>1</sup> (Table 1).

**Table 1. Electrochemical cell specifications**

		<b>Standard</b>	<b>FTEC 100</b>	<b>FTEC 500</b>	<b>EC 100Nr. 201</b>	<b>EC 100Nr. 240</b>
<b>Dimension</b>	Anode:	88x42 mm	88x42 mm	175x175mm	88x42 mm	88x42 mm
	Cathode	88x42 mm	88x42 mm	175x175mm	88x42 mm	88x42 mm
<b>Geometry</b>	Anode:	Expanded grid	Compact planar	Compact planar	Special	Special
	Cathode	Expanded grid	Expanded grid	Expanded grid	Special	Special
<b>Material</b>	Anode:	Mixed metal oxide	Mixed metal oxide	Mixed metal oxide	Special coating with a polarity reversal finish	Special coating with a polarity reversal finish
	Cathode	Stainless Steel	Stainless Steel	Stainless Steel	Special coating	Special coating
<b>Membrane</b>		Fabric reinforced, perfluorinated cation exchange membrane, as separator between catholyte and anolyte compartment				

<sup>1</sup> The cells are supplied from FumaTech GmbH. The Constructional and The technical details about the cells depend on the personal communications, correspondences and unpublished documents during the BaWaPla Project.

### 2.3 Water for the Experiments

For the experiments, different types of substrates were used, as outlined below:

DI: To produce disinfectant for the preliminary experiments with the Standard Cell, deionised water and saturated saline solution were used.

ASW: To avoid any uncontrolled effects of natural seawater, artificial seawater prepared with tap water and salt was used as test media for the preliminary investigations of cell types FTEC 100, FTEC 500, EC 100 Nr.201 and EC 100 Nr.240.

SW: Further experiments were carried out with seawater collected from the Bosphorus at Yeniköy (S‰:~18).

### 2.4 Measured Parameters and Instruments

Total chlorine and free available chlorine were the main parameters investigated with respect to the effectiveness of disinfectants. They were measured by a Hach DR 2000 Spectrophotometer using the DPD method. Redox potential, pH, temperature, salinity and conductivity were also measured as control parameters. The equipment used for the laboratory measurements are given within Table 2.

**Table 2. Parameters and instruments**

Parameter	Instrument
Redox Potential	Hach Sension1 pH / mV Meter
pH	WTW 720 InoLabseries - pH Meter
Temperature	WTW 720 InoLabseries - pH Meter
Salinity	WTW LF 196 –Microprocessor Conductivity Meter
Conductivity	WTW LF 196 –Microprocessor Conductivity Meter
Chlorine (Total and Free Available)	Hach DR 2000- DPD method

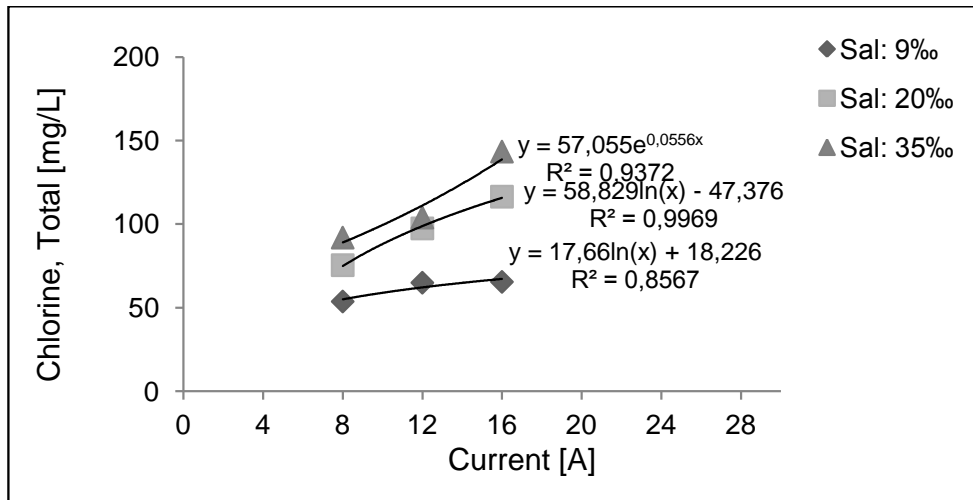
## 3 Results and Discussions

The experimental procedures varied for each electrochemical cell based on the different design parameters of the cells and the phase reached with the previous cell.

Standard cell experiments were carried out with three different substrate salinities (9‰, 20‰, 35‰) under three different current stresses (8A, 12A, 16A). AnoFluid was produced with a flow rate of 100 L/h and the samples were taken at the 10<sup>th</sup> minute of production.

The results show that the effectiveness of AnoFluid increases with salinity and current, as expected, due to principles of the electrochemical cells (Khelifa et. al., 2004). However, it should be noted that the change is not linear with the control parameters (Figure 2). The results obtained with similar salinities reveal the irregularity of chlorine content change with the current.

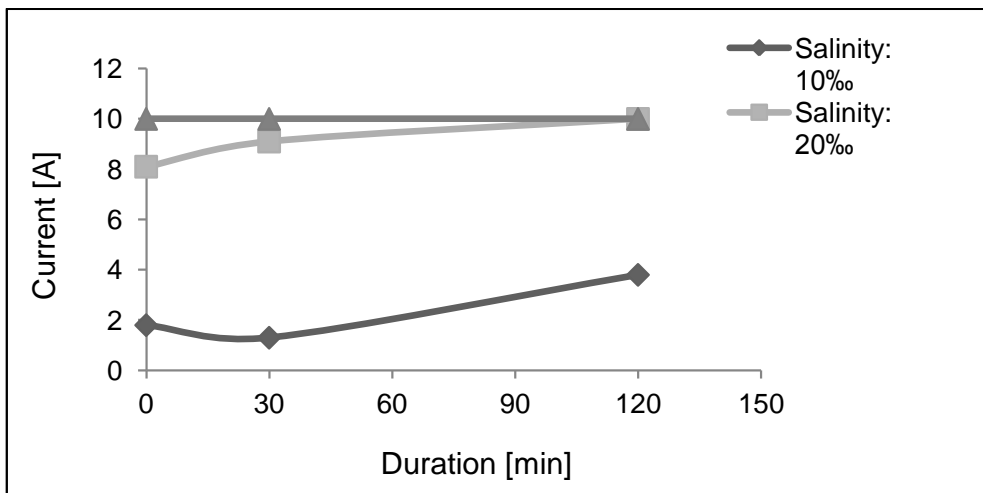
### LAB-SCALE CHLORINE GENERATION



**Figure 2. Effect of salinity and current**

On the other hand, the temperature of the produced AnoFluid changed between 22.5-23°C while pH values were distributed between 3.0 and 3.5. The calculations reveal that more than 99.99% of free available chlorine is in the form of hypochlorous acid (HOCl).

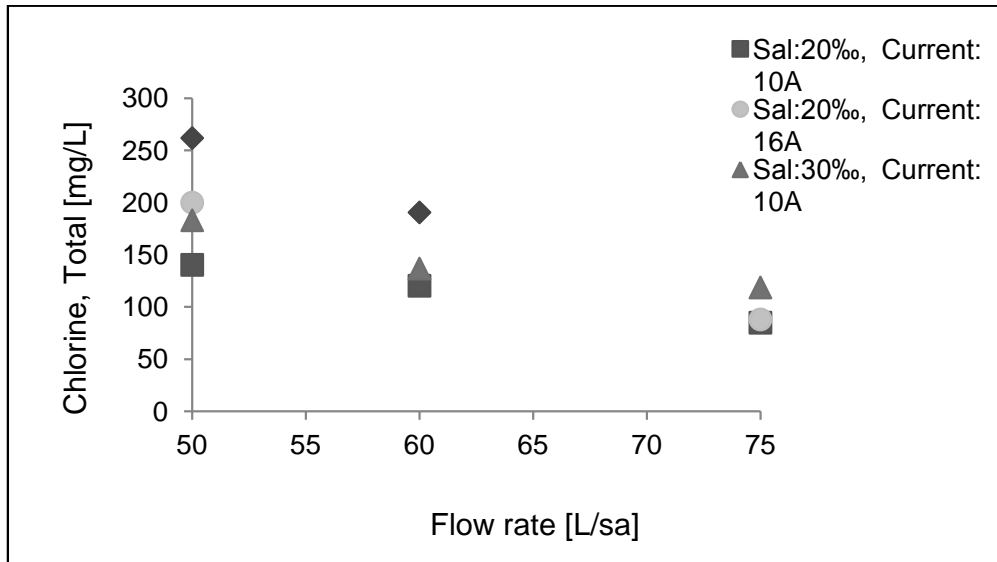
Several sets of tests are carried out to develop specifications for regular operation with FTEC 100. The system was found to be stable at currents above 10 A and salinity above 10‰ (Figure 3). Therefore, basically two different salinities (20‰, 30‰) were tested with two different currents (10 A and 16 A) under three different AnoFluid production rates (50 L/h, 60L/h, 75L/h). Artificial seawater was used as substrate. AnoFluid production lasted 120 minutes, and the values given in Figure 4 were derived from the samples taken at the end of the production.



**Figure 3. Operation tests with FTEC 100, (Yönsel and Bilgin Güney, 2010)**

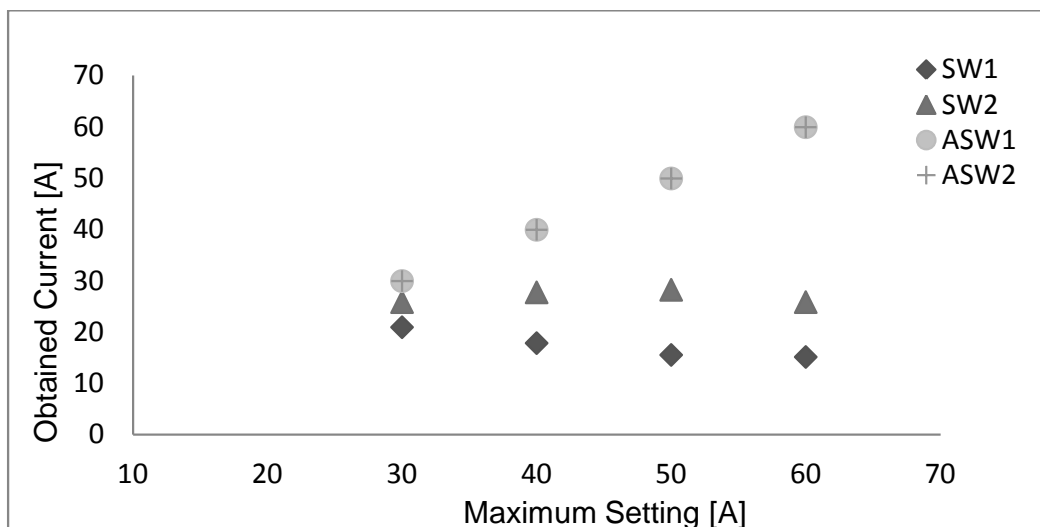


The results of FTEC 100 confirm the results of standard cell as the chlorine content rises with current and salinity. However, these experiments also show the importance of the production rate, the higher chlorine contents were obtained with lower AnoFluid flow rates (Figure 4).



**Figure 4. Effect of flow rate.**

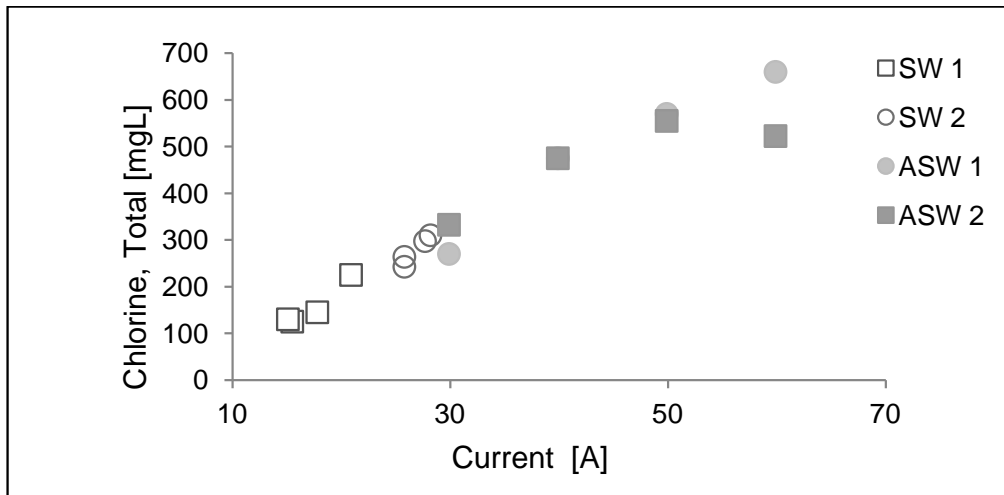
Experiments with FTEC 500 were carried out under a 100 L/h flowrate with four different maximum current settings (30A, 40A, 50A, 60A). AnoFluid production lasted 10 minutes to avoid heat excess on the cell. Both artificial seawater (Sal: 20‰) and natural seawater (Sal: ~18‰) were used as substrates. The numbers in the legends of related figures refer to the number of experiment with the relevant substrate.



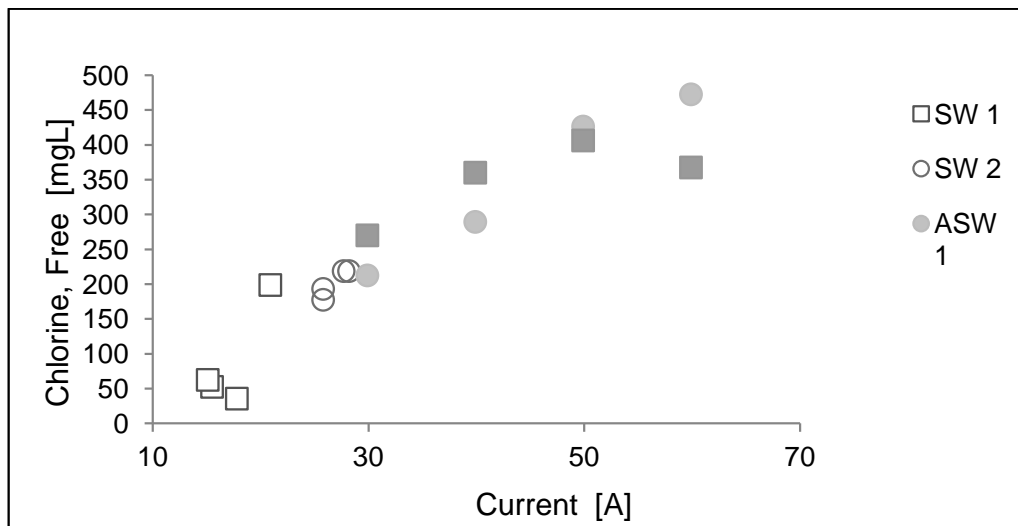
**Figure 5. Effect of substrate on current**

## LAB-SCALE CHLORINE GENERATION

The results underline that the properties of the substrate that go under the electrochemical process have direct effect on the Anofluid content. Figure 5 shows the obtained current values versus maximum current settings with each substrate. The currents with natural seawater generally lie below 30A even when the maximum setting reaches to 60 A whereas with artificial seawater, obtained and set values coincide. This fact is also reflected in the chlorine contents (Figure 6 and 7).



**Figure 6. Effect of substrate on total chlorine**



**Figure 7. Effect of substrate on free available chlorine**

Total and free available chlorine contents rise with rising currents with artificial seawater. However, chlorine contents form groups around certain values as the currents cannot go beyond 30A with natural seawater. The maximum chlorine content of the Anofluid produced

with natural seawater stays below the minimum chlorine content of the AnoFluid produced with artificial seawater (Total chlorine:332 mg/L, Free available chlorine: 212 mg/L).

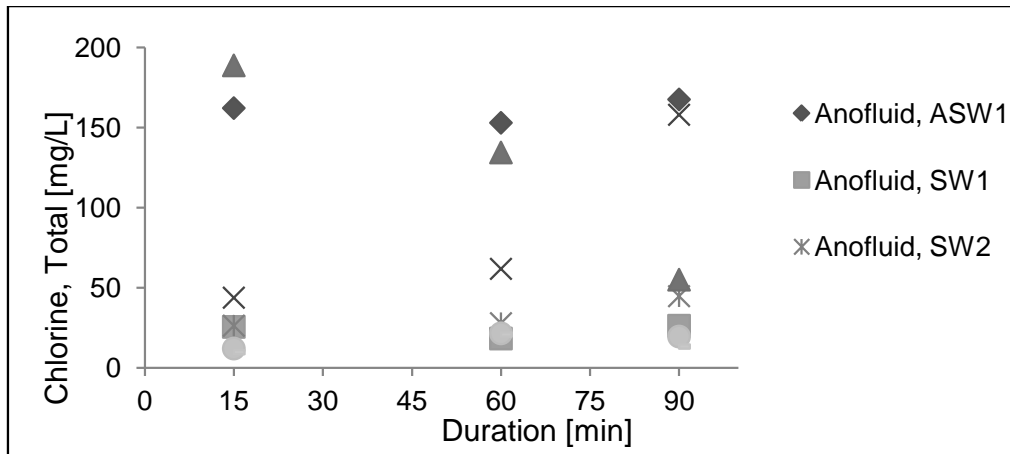
Seawater contains a wide range of salts at various concentrations and combinations (Riley & Skirrow, 1976). Our formerly published studies have shown that the chlorine figures decrease as the  $\text{Ca}^{2+}$  and  $\text{Mg}^{2+}$  concentrations of the substrate increase to the typical seawater levels and the accumulation of these ions on electrodes and membranes leads to a dramatic loss in the AnoFluid quality over time (Bilgin Güney and Yonsel, 2009). Additionally, coastal seawater may also contain high levels of ammonia (Yonsel et. al., 2000), and the ammonia content of the intake ballast water has a direct effect on the seawater generated disinfectant. As the active chlorine produced at the electrode reacts rapidly with ammonia in the reaction zone, chloramines are formed. The formation of chloramines causes a decrease in both total and free available chlorine concentrations of the electrochemically produced disinfectant (Bilgin Güney and Yonsel, 2011). The difference between total and free available chlorine contents of the produced AnoFluid indicates the presence of ammonia in the used seawater.

The results of the tests show the need for the cells to have the ability to work with reverse polarity onboard. This necessity leads to new cell designs, and consequently, EC 100 Nr. 201 and EC 100 Nr. 240 were supplied from FumaTech, GmbH. The new electrode types were designed to be "seawater resistant" which means resistant against typical seawater salt contents. The cells have electrodes equipped with polarity reversal finish, which has an additional protective layer between the coating, metal and glossier electrode surface. This protective layer allows for reverse current direction such that self-cleaning of the cell can be maintained simultaneously with the production of disinfectant. The disinfectant produced in this manner is referred to as CathoFluid to distinguish it from the disinfectant produced with the regular current direction.

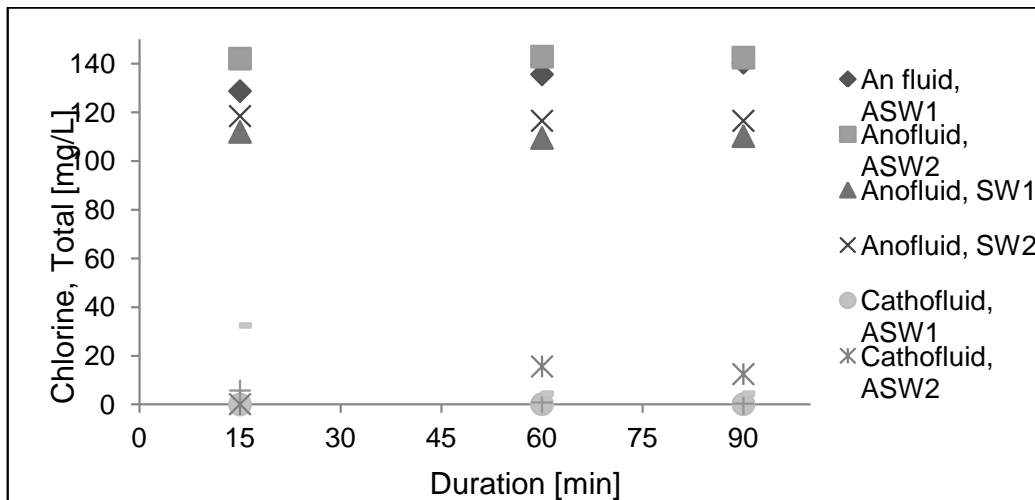
The disinfectant production with EC 100 Nr. 201 and EC 100 Nr. 240 lasted 90 minutes for each direction. The samples of artificial seawater (Sal: 20‰) and natural seawater (Sal: ~18‰) were used as substrates. The values given in Figure 8 and Figure 9 were derived from the samples taken at the end of the production. The numbers in the legends of related figures refer to the number of the experiment with the relevant substrate.

When using artificial seawater, EC 100 Nr. 240 shows better performance for both AnoFluid and CathoFluid (Figure 8). The chlorine content of AnoFluid with artificial seawater was generally greater than 150 mg/L; and for CathoFluid, chlorine content was greater than 50 mg/L, even exceeding 150 mg/L in some cases. On the other hand, the chlorine figures was far less (<50 mg/L) when natural seawater was used as the substrate.

## LAB-SCALE CHLORINE GENERATION



**Figure 8. Disinfectant produced with EC 100 Nr.240**



**Figure 9. Disinfectant produced with EC 100 Nr.201.**

EC 100 Nr. 201 had much better performance when producing Anofluid with natural seawater (Figure 9). The chlorine content of Anofluid was greater than 100 mg/L throughout the production. But this cell did not have the same performance for CathoFluid. The chlorine content of CathoFluid was below 16 mg/L in all cases.

## 4 Conclusions

The overall results show that the best chlorine figures were achieved with FTEC 500 under comparable conditions. Considering the only exception between FTEC 100 and FTEC 500 was the electrode dimensions, enlargement of other cells would also lead to this consequence. The best chlorine figures for Anofluid with natural seawater were achieved with EC 100 Nr. 201, even though chlorine figures were far less for CathoFluid independent of

dimensions. Since the main objective is producing the best disinfectant using natural seawater, EC 100 Nr. 201 is considered the best cell among the five in terms of cell design.

Taking into consideration these laboratory results, FumaTech GmbH optimised new cells for BaWaPla. These cells have the electrode dimensions like those of FTEC 500, and the material used for electrodes and their coatings are similar to EC 100 Nr. 201. The cells have a capacity of 500 L/h disinfectant production, and they have the ability to be operated with reverse polarity such that a self-cleaning process can take place simultaneously with disinfectant production. Such cells will present substantial advantages considering the operations onboard. Six of these cells were employed within the land-based pilot BaWaPla system at Blyth-England during the period from July to September 2009 (Figure 10). Under optimal operation conditions, the electrochemical module of the BaWaPla system had the capability to provide 3-3.5mg/L of active chlorine to the test tank, which was capable of disinfecting the organisms to IMO levels under operational conditions (i.e. seawater properties organism load) (Carney et. al., 2009).



**Figure 10. BaWaPla Pilot System, Blyth-England (2009).**

## Acknowledgments

Authors thank all of the partners of “BaWaPla – Sustainable Ballast Water Management Plant” Project funded by the European Union under contract number 031529, for their support, particularly Mr. Michael Laverty and Mr. Frank Voiglaender from LVPG International for providing the electrolyzing generator.

## REFERENCES

Abdul-Wahab, S.A. and M.A., Al-Wesbahi (2009) Brine Management Substituting Chlorine with On-Site produced sodium hypochlorite for Environmentally Improved Desalination Processes, *Water Resouce Management*, 23, 2437-2454.

*Abu-Khader, M.M., Badran, O. and M., Attarakihet (2011) Ballast water treatment technologies: hydrocyclonic a viable option, Clean Techn Environ Policy (2011) 13:403–413.*

*Aliotta, J. Rogerson, A., Campbell, C.B. and M., Yonge (2003), Ballast water treatment by electro-ization. In: Raaymakers, S. (Ed.), 2003. 1st International Ballast Water Treatment R&D Symposium, IMO, London, 26–27 March 2001: Symposium Proceedings, GloBallast Monograph Series No.5. IMO: London, p: 61-69.*

*Bilgin Güney, C. and F., Yonsel (2009), Onboard electrochemically generation of disinfectant for ballast water treatment, 13th Congress of Intl. Maritime Assoc. of Mediterranean IMAM 2009, İstanbul, 12-15 Ekim. 2009.*

*Bilgin Güney, C. and F., Yonsel (2011), Effects of ammonia on electrochemical chlorine generation for ballast water treatment, Proceedings, International Conference on Ocean, Offshore and Arctic Engineering OMAE 2011, June 19-24, Rotterdam.*

*Carney, K.J., Delany J., Mesbahi, E., Pazouki, K., Rajarajan, N. and K., Emami (2009), Biological, technical and operational assessment and recommendations for system’s operational optimisation, BaWaPla Deliverable 5.3, Draft.*

*Dang, K., Yin, P., Sun, P., Xiao, J. and Y., Song (2004), Application study of ballast water treatment bt electrolyzing seawater, In: Matheickal, J.T., Raaymakers, S. (Eds.), 2004. 2nd International Ballast Water Treatment R&D Symposium, IMO, London, 21–23 July 2003: Symposium Proceedings, GloBallast Monograph Series No.15. IMO: London, p: 103-110.*

*Derek, K.G., Duggan, I.C. and H.J., MacIsaac., (2006) Can sodium hypochlorite reduce the risk of species introductions from diapausing invertebrate eggs in non-ballast ships?: *Marine Pollution Bulletin*, 52, 689-695.*

*Hammer M.J., M.J., Hammer Jr. (2004), Water and Wastewater Technology, Fifth Edition, Prentice-Hall, Inc., 2004, New Jersey, ABD.*

*Jonnalagadda, S.B. and S., Nadupalli (2004)* Effluent tretment using electrochemically bleached seawater-oxidative degradation of pollutants, *Talanta*, 64, 18-22.

*Yonsel, F. et. al., (2000)*, İstinye deresinin İstanbul Boğazı'na taşıdığı kirlilik, IV. Ulusal Kimya Mühendiliği Kongresi, 4-7 Eylül, İstanbul.

*Kerwick, M.I. Reddy, S.M., Chamberlain, A.H.L. and D.M., Holt (2005)*, Electrochemical disinfection, an environmentally acceptable method of drinking water disinfection? *Electrochimica Acta*, 50, 5270-5277.

*Khelifa, A., Moulay, S., Hannane, F., Benslimene, S. and M., Hecini (2004)*, Application of experimental design method to study the performance of electrochlorination cells, *Desalination*, 160, 91-98.

*Kim, E., Shin, K., Kang, J.H., Pak, D., Lee, K.P., Lee, I.S. and K., Rhie (2006)*, Consideration on the environmental acceptability and biological effectiveness of the electrochemical disinfection system for balast water management, *Oceans 2006- Asia Pacific Conference*, Singapore, 16-19 May.

*Kraft, A., Stadelmann, M., Blaschke, M., Kreysig, D., Sandt, B., Schröder and F., Rennau, J., (1999a)*, Electrochemical water disinfection Part 1: Hypochlorite production from very dilute chloride solutions, *Journal of Applied Electrochemistry*, 29, 861-868.

*Leffler, C. E., Rogerson, A., Paul, W., Germaine, G., Elliot, M., Antonelli, V., Grubs, S., Campbell, C., Beall, G. and A., Salamone, (2004)*, Electro-sanitization of ballast water. In: Matheickal, J.T., Raaymakers, S. (Eds.), 2004. 2nd International Ballast Water Treatment R&D Symposium, IMO, London, 21–23 July 2003: Symposium Proceedings, *GloBallast Monograph Series No.15*. IMO: London, p: 111-120.

*Matousek, R. C., Hill, D.W., Herwig, R.P., Cordell, J.R., Nielsen, B.C., Ferm, N.C., Lawrence, D.C. and J.C., Perrins (2006)*, Electrolytic sodium hypochlorite system for treatment of ballast water, *Journal of Ship Production*, 22, No:3, 160-171.

*Oğur, R., Tekbaş, Ö.F. and M., Hasde (2004)*, Klorlama Rehberi (İçme ve Kullanma Sularının Klorlanması), Gülhane Askeri Tıp Akademisi Halk Sağlığı Anabilim Dalı, Ankara.

*Rajeshwar K. and J.G., Ibanez (1997)*, *Environmental Electrochemistry Fundamentals and Applications in Pollution Abatement*, Academic Press, California.

*Sawyer, C. N., McCarty, P.L., Parkin and G.F., (1994)*, *Chemistry for Environmental Engineering*, Fourth edition, McGraw-Hill series in water resources and environmental engineering, New York.

*Srinivasan, S., (2006)*, *Fuel Cells From Fundamental to applications*, Springer Science+Business Media, New York, ABD.

*Stocks, D. T. O'Reilly, M. and W., McCracken (2004a)*, Treatment of ballast water in the NOBOB ship using heat. In: Matheickal, J.T., Raaymakers, S. (Eds.), 2004. 2nd International Ballast Water

## LAB-SCALE CHLORINE GENERATION

Treatment R&D Symposium, IMO, London, 21–23 July 2003: Symposium Proceedings, GloBallast Monograph Series No.15. IMO: London, p: 80-87.

*Tsolaki, E. and E., Diamadopoulou (2009), Technologies for ballast water treatment: A review, J Chem Technol Biotechnol 2010; 85: 19–32.*

*Tsolaki, E., Pitta, P. and E., Diamadopoulou (2010), Electrochemical disinfection of simulated ballast water using Artemi salina as indicator, Journal of Chemical Engineering, 156, 305-312.*

*Vijayaraghavan, K., Ramanujam, T.K. and N., Balasubramanian (1999), In situ hypochlorous acid generation for the treatment of syntan wastewater, Waste Management, 19,319-323.*

*Weber Jr., J.W., 1972. Physicochemical Process for Water Quality Control, Wiley-Interscience Series of Texts and Monographs.*

*Yönsel, F., Bilgin, C. and C., Gülşen (2000), İstinye Deresinin İstanbul Boğazına Taşıdığı Kirlilik. UKMK-IV Bildiri Kitabı 2. Cilt S, 769-774, 4-7 Eylül 2000, İstanbul Üniversitesi Avcılar-İstanbul ISBN: 975-404-615-8.*

*Yönsel, F. and C., Bilgin Güney (2010), Electrochemical chlorine generation applications for ballast water treatment, International Conference on ship design and operation for environmental Sustainability 10 - 11 March 2010, RINA Hq, London, UK Bildiriler kitabı, sayfa: 95-103, ISBN: 978-1-905040-69-8.*

*Zhang, S. Yang, C.D., Gong, W., Wang, Q., Xiao, J., Zhang, H. and Q., Wang, (2004) Effects of the chlorination treatment for ballast water. In: Matheickal, J.T., Raaymakers, S. (Eds.), 2004. 2nd International Ballast Water*

Treatment R&D Symposium, IMO, London, 21–23 July 2003: Symposium Proceedings, GloBallast Monograph Series No.15. IMO: London, p: 148-157.





## A Ballast Discharge Monitoring System for Great Lakes Relevant Ships: A Method for Researchers, Ship Owners, and Agency Officials

Allegra Cangelosi<sup>1</sup>, Tyler Schwerdt, Travis Mangan,  
Nicole Mays, Kelsey Prihoda

---

### Abstract

*The Great Ships Initiative (GSI) is a collaborative project led by the Northeast-Midwest Institute devoted to ending the problem of ship-mediated invasive species in the Great Lakes-St. Lawrence Seaway System and globally. In support of that goal, GSI has established superlative freshwater ballast treatment evaluation capabilities at three scales—bench, land-based, and onboard ship. GSI testing takes place at the scale appropriate to the treatment's state of development. The goal is to help meritorious BWTs progress as rapidly as possible toward an approval-ready and market-ready condition through supplying rigorous status testing or certification testing of biological efficacy.*

*GSI developed and tested onboard five ships a ship discharge monitoring method to share with regulatory authorities, ship owners and researchers. The method details an approach for collecting and analyzing representative samples of living organisms in ballast discharge from Great Lakes-relevant ships. Specifically, the method describes a feasible, practicable and cost-efficient approach for retrieving quantitative samples from ships to determine live organism densities in three size classes of organisms (equal to or greater than 50 micrometers in minimum dimension, less than 50 micrometers and equal to or greater than 10 micrometers in minimum dimension, and less than 10 micrometers in minimum dimension), water quality parameters, and whole effluent toxicity tests.*

*GSI designed the ship discharge monitoring method for planned ship discharge monitoring exercises (the method would not be suitable to surprise spot checks). As such, the method is highly applicable to a wide range of quantitative ballast treatment performance research and validation, including type approval testing and planned treatment performance monitoring events post approval. Any application of the method to regulatory purposes, however, would require close review and revisions of method specifics per specific regulatory guidelines.*

**Key Words:** Great Ships Initiative, Great Lakes, Ballast Water, Ballast Discharge, Ship Discharge Monitoring, Shipboard Tests, Ballast Water Treatment Systems, Ballast Water Samples.

---

### Introduction

The objective of this paper is to document a Great Ships Initiative (GSI) ship discharge monitoring method which GSI developed to prepare regulatory authorities, ship owners and

---

<sup>1</sup> Northeast-Midwest Institute

researchers for collecting and analyzing representative samples of living organisms in ballast discharge from Great Lakes-relevant ships. Specifically, the GSI method allows monitoring entities to retrieve quantitative samples from ships to determine live organism densities in three size classes of organisms (equal to or greater than 50 micrometers in minimum dimension, less than 50 micrometers and equal to or greater than 10 micrometers in minimum dimension, and less than 10 micrometers in minimum dimension), water quality parameters, and whole effluent toxicity tests. Methods associated with sample analysis were not part of the scope of the project; GSI has already developed Standard Operating Procedures for these analyses, which can be downloaded from GSI's website ([www.greatshipsinitiative.org](http://www.greatshipsinitiative.org)). It is important to note that the method described here is preliminary and subject to revision over time. GSI will periodically update the method and repost new versions on its website.

GSI designed the ship discharge monitoring method reported here for planned ship discharge monitoring exercises (the method would not be suitable to surprise spot checks). As such, the method detailed in this paper is highly applicable to a wide range of quantitative ballast treatment performance research and validation, including type approval testing and planned treatment performance monitoring events post approval. Any application of the method to regulatory purposes, however, would require close review and revisions of method specifics per particular regulatory guidelines.

This paper:

- Presents an overview of the GSI ship discharge sampling approach;
- Describes details of the sample and return port installations necessary for this sampling approach to be used on Great Lakes-relevant ships;
- Details the set-up and break-down processes for implementing this approach for a sampling event; and
- Provides a discussion of the feasibility of the methods, including their strengths and weaknesses based on GSI trials in the field.

### **Background on the Great Ships Initiative (GSI)**

GSI is a collaborative project led by the Northeast-Midwest Institute (NEMWI) devoted to ending the problem of ship-mediated invasive species in the Great Lakes-St. Lawrence Seaway System and globally. NEMWI is a Washington, D.C.-based non-profit and non-partisan research organization dedicated to the economic vitality, environmental quality, and regional equity of Northeast and Midwest states. In support of that goal, NEMWI has established through GSI a superlative freshwater ballast treatment evaluation capabilities at three scales—bench, land-based, and onboard ship. GSI research is carried out

## A BALLAST DISCHARGE MONITORING SYSTEM

collaboratively with contracting entities including the University of Wisconsin-Superior (UW-S), AMI Consulting Engineers, Broadreach Services, and the University of Minnesota-Duluth (UM-D).

GSI testing takes place at the scale appropriate to the treatment's state of development. The goal is to help meritorious BWTs progress as rapidly as possible toward an approval-ready and market-ready condition through supplying rigorous status testing or certification testing of biological efficacy. To assure relevancy of test output, GSI test protocols, generally, are as consistent with the International Maritime Organization (IMO) Convention for the Control and Management of Ships' Ballast Water and Sediments Convention (IMO, 2004) and federal and state requirements as practicable. For example, United States Environmental Protection Agency (USEPA) Environmental Technology Verification (ETV) Program testing is performed consistent with ETV protocols (e.g., NSF International, 2010).

A GSI Advisory Committee is comprised of top-level officials of key stakeholder groups and provides direct input on GSI award decisions, program direction, finances and fund-raising. The GSI Advisory Committee, which meets three times a year, includes elected leadership, environmental organizations, port directors and federal officials from the United States and Canada, and industry representatives.

GSI's Quality Management Plan (GSI, 2011) outlines the activities that GSI uses to ensure that personnel have the necessary education, qualifications, and experience needed to effectively carry out their specific roles and responsibilities within the project.

### **Background on GSI Ship Discharge Monitoring Project**

GSI received funding from the Legislative Citizen's Commission on Minnesota Resources (LCCMR), the Maritime Administration and the Great Lakes Protection Fund to design, install and test a ship-based ballast discharge sampling approach on the range of commercial cargo ships which ply the Great Lakes. The primary goal of this GSI project was to inform ship owners, researchers and regulators about effective and efficient methods for carrying out ballast discharge monitoring on Great Lakes ships. A secondary goal was to initiate the installation of effective sampling ports on Great Lakes-relevant ships for BWTs testing and monitoring.

GSI developed a proposed sampling approach, which included permanent sample port flange installation guidelines consistent with those of the IMO (IMO, 2004) and the USEPA ETV Program (NSF International, 2010); portable sampling system equipment and methods for shipboard use; and portable sample analysis equipment and methods for port-side use.

GSI personnel visited a range of ships to identify optimal locations for sample port flanges given a set of the project criteria (see Methods). Sample locations that had the potential to meet most or all of these criteria were identified and photographed during the ship visit, and later modeled using computational fluid dynamics (CFD) to determine which location would deliver the most representative sample.

GSI in consultation with the ship owner then selected the best location based on the inspection information, and the ships were then outfitted with sample flanges. GSI visited the ships to trial and review the GSI sampling approach in real-world applications. This paper provides the method and lessons learned from this project activity. The sample ports will stay in place for possible future use in research and compliance monitoring. Data gathered on living organisms in ballast discharge sampled through this project will be provided to the State of Minnesota and published on GSI's website ([www.greatshipsinitiative.org](http://www.greatshipsinitiative.org)).

### **Sampling Approach Overview**

GSI designed the sampling approach described here to be applicable to a range of test applications. It employs simultaneous, in-line and continuous collection of large and small quantities of sample water from subject ballast water discharge to estimate live organism densities and types in and water quality characteristics of that discharge. The method is adaptable to a wide range of sampling intensities and ships with diverse ballast line diameters and ballast system types.

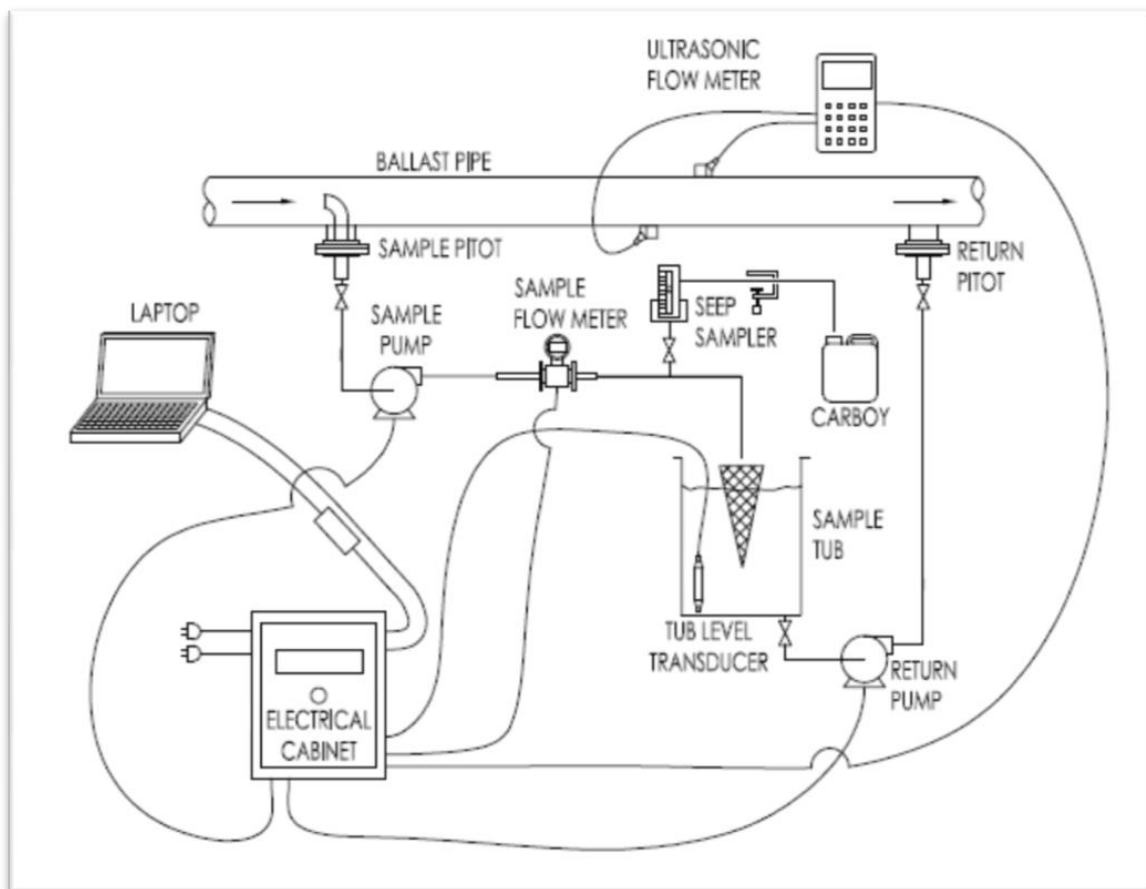
It is important to note that hardware and personnel alone will not deliver useful sampling exercises. The sampling team must also have a robust and valid test plan and standard operating procedures (SOPs) to accompany any ship sampling exercise. The test plan will describe the objectives of the test, the hypotheses, the experimental design, the analytical methods, and quality control and quality assurance (QAQC) procedures for the work. The SOPs will detail specific methods. The GSI website ([www.greatshipsinitiative.org](http://www.greatshipsinitiative.org)) includes test reports on ship-based ballast treatment research providing examples of these documents.

Details of the sampling approach are provided in subsequent sections. Fundamentally, the process involves:

- Prior installation of two permanent 4-inch diameter blind flanges in a strategically selected segment of the ship's ballast line (detailed below), and insertion of a temporary sampling pitot in one such flange;

## A BALLAST DISCHARGE MONITORING SYSTEM

- Space and services on the ship to support sample collection (detailed below);
- A port-based set-up, sampling and ballast team of four people, and nearby analytical space and equipment (detailed below); and
- A time window affording 45 minutes to one hour for sampling system set-up and 45 minutes to one hour for its break-down, in addition to the selected sampling period duration.



**Figure 1. Schematic of the GSI Ship Discharge Sampling System and Component Parts.**

Figure 1 illustrates the GSI sampling system lay out. In summary, the installation of the blind flanges—a relatively minor permanent change to the ship costing less than \$5,000—is completed according to strict location guidelines well before sampling is to occur. At the time of, or just prior to, the sampling event, an elbow-shaped sampling pitot is installed in the upstream flange to deliver flow to the sampling system. For zooplankton sampling (i.e., organisms equal to or greater than 50 micrometers in minimum dimension), sample flow from

the discharge line is pumped from the sampling pitot at a known flow rate through a plastic line equipped with a flow meter into a 35 micron plankton net that is suspended in a 50 gallon tub with a level transmitter and a bottom discharge flange. The fraction of the ballast line flow pumped through the sample port should remain constant throughout the sampling process. This ratio is monitored using an in-line magnetic flux flow meter on the sample line, and a portable ultrasonic flow meter mounted to the ships ballast piping. A second pump draws spent sample water from the 50 gallon tub through plastic line to the return flange in the ballast line for discharge overboard with other ballast water. The water level in the tub is maintained at near full as the net filters the plankton into a bottom cod-end. A small side stream of the sample water flow (pre-plankton net) is directed into a carboy for whole water samples which can be used to assess water quality, protists (i.e., organisms less than 50 micrometers and equal to or greater than 10 micrometers in minimum dimension), bacteria (i.e., organisms less than 10 micrometers in minimum dimension), and effluent toxicity. Grab samples can be extracted from the line (i.e., hose) feeding into the nets, or through a dedicated side port off the main sample line which can be opened and closed. Sample analysis can take place on-ship, but is easiest to arrange off-ship.

## **METHODOLOGY**

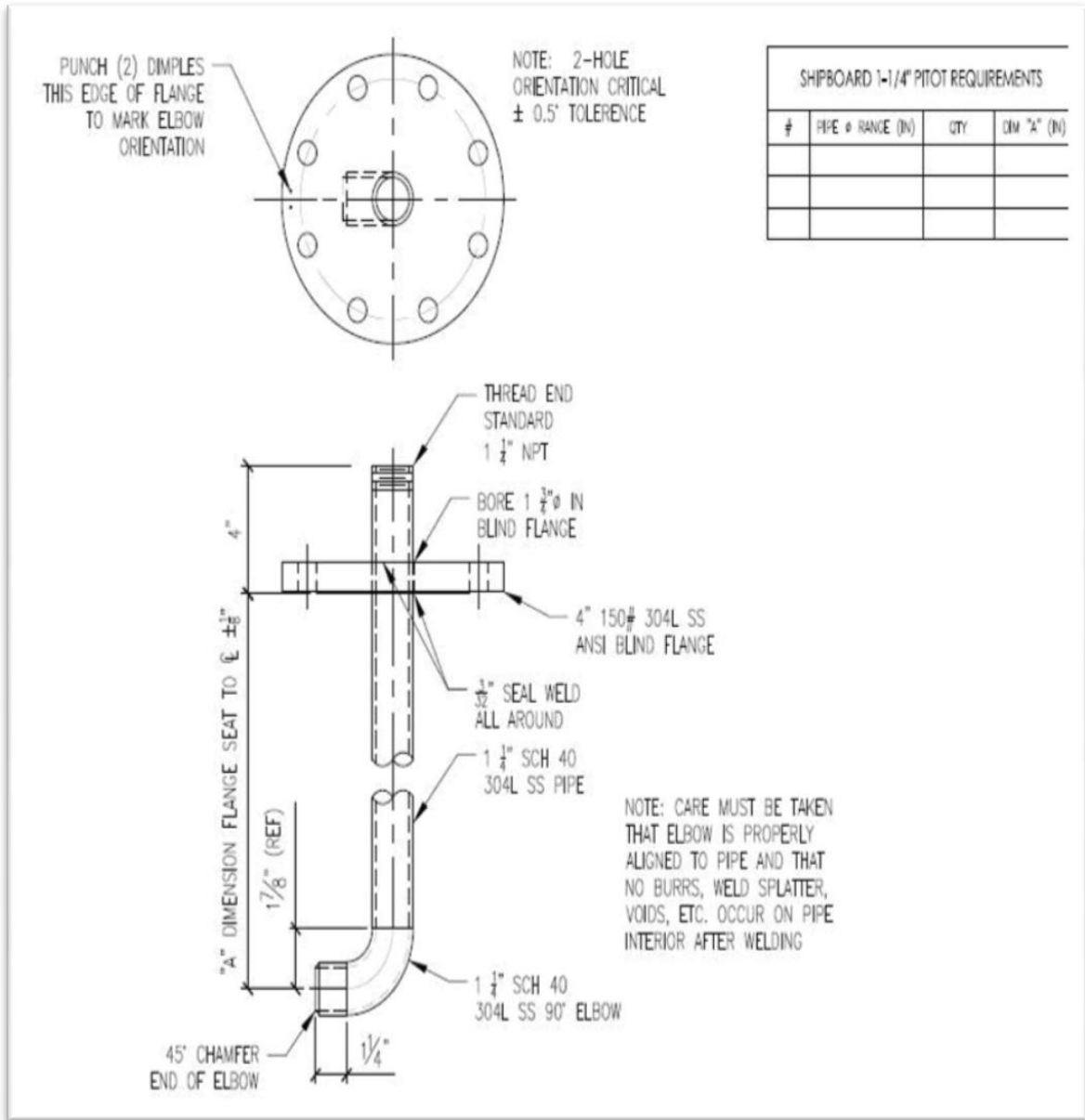
### **Sample Ports/Return Ports**

GSI installed sample ports and return ports as 4 "150 # ANSI flanges with blinds. GSI employed stainless steel bent elbow style pitots (Figure 2) installed so that the opening faces into the flow at the center of the pipe.

GSI first determined the target sample volume per unit ballast discharge based on experimental design criteria. Then it assured the internal diameter of the pitot opening was large enough to guarantee that sample water pumped through the pitot was able to provide the target volume, but at a subisokinetic flow velocity that ranges between 44%-25% of the discharge flow velocity of the ship. An isokinetic flow rate occurs within a pitot when the sample water flow velocity is the same as discharge line flow velocity.

A subisokinetic velocity means there is a slower flow velocity in the pitot than in the line being sampled. Consistent with recommendations by the United States Coast Guard (USCG) to maintain a pitot inlet of 1.5-2.0 times the isokinetic diameter (USCG, 2008), GSI assumes that subisokinetic flow helps prevent organism damage by edge interactions with pitot inlet and walls. Assuming most ballast systems are designed for a flow rate of around 10 feet/second, the pitot sizes required to collect a range of volume of sample water per hour are shown in Table 1.

**A BALLAST DISCHARGE MONITORING SYSTEM**



**Figure 2. Diagram of Elbow Pitot for Ballast Discharge Sampling.**

**Table 1. Relationship of Sample Pitot Diameter to Sample Water Flow Rate**

Sample Pitot, Flow Rate at 10 ft/sec Ranging From 1.5 - 2.0 Times The Isokinetic Diameter									
Diameter (in)	3/4	1	1 1/4	1 1/2	2	2 1/2	3	3 1/2	4
Flow (Gal/Hr)	359.4 - 202.2	97.8 - 36.3	1066.1 - 599.7	1468.7 - 826.1	2454.2 - 1380.5	3522.5 - 1981.4	5489.7 - 3087.9	7386.9 - 4155.1	9555.2 - 5374.8
Flow (M3/Hr)	1.4 - 0.8	2.3 - 1.3	4 - 2.3	5.6 - 3.1	9.3 - 5.2	13.3 - 7.5	20.8 - 11.7	28 - 15.7	36.2 - 20.3



**Step-by-Step Approach to Pitot Diameter Selection**

1. Determine Test Plan Sample Volume/Rate requirements (e.g., the test plan requires 6.0 m<sup>3</sup> in 2 hours or 3.0 m<sup>3</sup>/hr).
2. Assure the pump is capable of that flow rate.
3. Consult with the ship engineer to determine ship ballast discharge flow rate (usually around 10 ft./sec., but not always).
4. Select a pitot diameter that assures the flow velocity is in the subsokinetic range of 44% - 25% ballast discharge flow rate. If they ballast at 10 ft./sec, Table 1 can be used (e.g., For a desired flow rate of 3.0 m<sup>3</sup>/hr, per Table 1, a 1.25" pitot can be used since it has a valid range of 4.0-2.3 m<sup>3</sup>/hr).

**Criteria for Sample Port Location**

The location of the sample port is critical to its ability to deliver representative samples of live organisms in ballast discharge. Both fluid dynamic properties of a location, physical access and safety considerations come into play.

**Table 2. GSI Criteria for Sample Port Location in a Ship Ballast System.**

Criteria	Reason
Single location services all tanks equally.	A single sample point means fewer flanges are needed, and less sampling effort is required.
Long length of straight pipe preceding the sample port.	Long lengths of straight pipe create a "fully developed" flow characteristic, assuring water is well-mixed at the point of sampling, and samples are representative of the discharge.
Locations as close to overboard as possible.	Samples collected closer to discharge will more closely represent the quality of water entering the receiving system.
A suitable adjacent area for sample processing, suitable for technician occupancy, and with accessible light and power supply.	A sample port alone won't deliver a good sample. Technicians must be able to work in proximity to it to collect and process samples.
Necessary clearances to install the sample pitot.	The sample team or ship personnel must be able to install and remove the pitot without damaging other equipment.
Piping that can be isolated.	Piping around the sample location must be isolated so that the sample equipment can be safely installed or removed.
No explosion or other hazards.	Explosive environments require special equipment to assure safety of the ship, crew and sampling team.

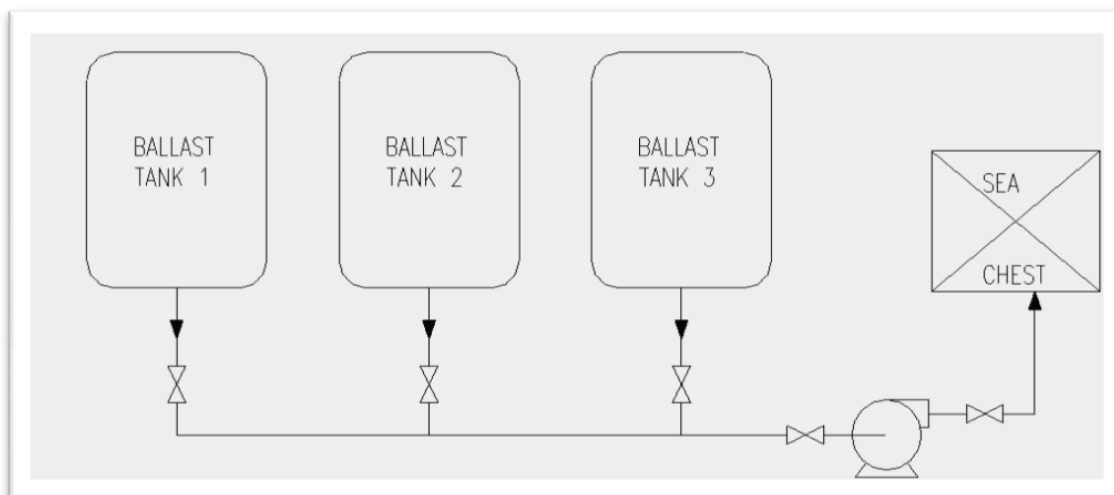
## A BALLAST DISCHARGE MONITORING SYSTEM

A suitable location for a return flow port is somewhat simpler as the flow mechanics of the return location are unimportant, but locating it a minimum of two pipe diameters downstream of the sample port assures that it in no way interferes with the sample port fluid dynamics. GSI uses the criteria detailed in Table 2 to guide selection of sample port location.

### **Sample Pitot Locations in Ballast Systems Found on Great Lakes-Relevant Ships Types**

A ballast system comprises the pump, sea chests and piping associated with moving ballast water on and off the ship. Most ships have two ballast systems mirrored along the centerline of the ship: one system services the port side tanks and the other the starboard tanks. Thus, most ships require a minimum of two sample points for monitoring ballast discharge. Ballast systems associated with ships in service on the Great Lakes can be quite different from each other, as will the best location for a sample point given the criteria noted in Table 2. During GSI ship inspections, three fundamentally different types of ballast systems were identified:

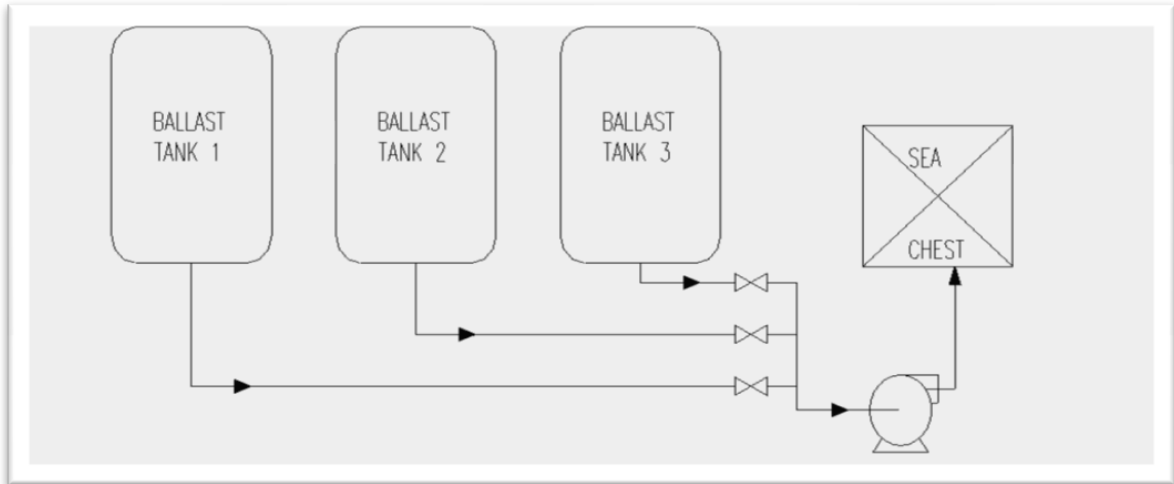
- Distributed Manifold Ballast System (Figure 3), in a distributed manifold system a single pump or pair of pumps is installed in the engine room with ballast main(s) traveling the length of the ship. Branches off the main service each tank. Flow in or out of the tank is controlled by manual or actuated valves at the ballast tank. This ballast system design typically had straight lengths of pipe suitable for sampling locations in the ship tunnel.



**Figure 3. Schematic of Distributed Manifold Ballast System Design.**

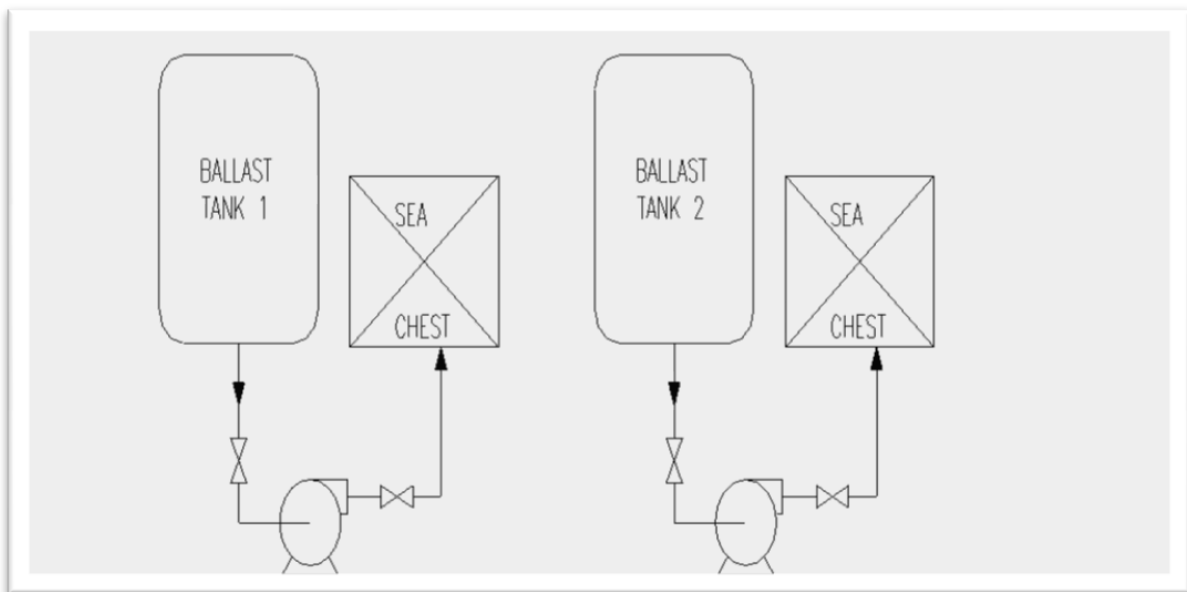
- Centralized Manifold Ballast System (Figure 4); this ballast system style is similar to a distributed manifold except each ballast tank has an individual line leading back to

the engine room; the lines combine prior to the pump. All the ballast system valves are located together in the engine room.



**Figure 4. Schematic of Centralized Manifold Ballast System Design.**

Multiple Independent Ballast Systems (Figure 5). Ships with multiple independent ballast systems have no common piping between ballast tanks. Every ballast tank on the ship has a separate sea chest, ballast pump and piping. This style of ballast system is rare within and outside the Great Lakes.



**Figure 5. Schematic of Multiple Independent Ballast System Design.**

### ***Power Requirements***

Power requirements for sample collection systems should be kept to a minimum. The GSI sampling system runs off of two 13 amp 120 volt circuits at 60 hertz. Although it has been easy to find this supply on U.S. and Canadian ships, it becomes more difficult with foreign vessels that operate with different electrical standards.

### ***Pitot Custody***

The GSI team prefers to provide the pitot to the ship master for installation into the flange sometime within a week or two prior to the ship's arrival at the port at which sampling is scheduled. After the sample visit, the ship crew returns the pitot to the GSI sample team. GSI does not install sample pitots permanently in the ships in order to assure that bio-fouling inside of the pitot does not bias sampling outcomes, and to assure that structural defects of the pitot will not endanger ship operations. If necessary, GSI can install the pitot on the day of sampling, but this approach expends limited time available for set-up, and sample collection, processing and analysis.

GSI recommends that pitots be owned by the testing agency and loaned to the ship being evaluated. Upon pitot return after a sampling event, the GSI team inspects the pitot for any damage. Having the pitot belong to the sample team also puts the responsibility of maintaining a specialized piece of equipment in the hands of those that will need to operate it. The research team can then size the pitot aperture to deliver the desired flow to discharge ratio (i.e. volume of sample water per unit volume of ballast discharge).

### ***Step-By-Step Process for Sample Port Commissioning***

In summary, steps employed by GSI to identify and install sample ports on ships are as follows:

1. **Pre-Installation Ship Inspection.** A ship inspection is conducted to identify and document features of sample locations with potential to meet most or all of the relevant criteria. Also, possible locations for a return flow port downstream of the sample port and sample processing are assessed and identified at this time.
2. **CFD Models.** A qualified engineering firm models potentially suitable locations using computational fluid dynamics (CFD) to determine which locations, in fact, provide well-mixed samples of ballast discharge (i.e. have fully developed flow or are closest to fully developed flow).
3. **Installation Design to Ship Owner.** Once a location is determined by the sample inspection team, the location is submitted to the ship owner for approval and class society review.

4. **Flange Installation.** Once the ship owner and class society agree to the design, the ports can be installed with blind flanges.
5. **Pitot Installation.** Prior to a sampling event, the blind flange is removed and replaced with a sample pitot of an appropriate size.

#### **Equipment, Set up and Tear Down**

GSI selected sampling equipment for its reliability and portability. All of the equipment and components of the process described here are no greater than 45 lbs in weight. GSI includes spare parts for critical components in case of component failure during sampling. Set up and tear-down of the sampling system consumes approximately one and one-half (1.5) hours each by two technicians.

#### **SAMPLING SYSTEM COMPONENTS**

The following components comprised GSI's sampling system;

##### **Sample Pitot and Sample and Return Port Flange**

**Function:** A section of pipe sized to allow water to be collected from the center of the ballast line.

##### ***GSI Specific Equipment***

***Manufacturer:*** Custom designed and manufactured.

***Model:*** Custom.

**Description:** A 90 degree elbow mounted on a 4" 304L stainless steel sample port blind flange. The sample pitot is made from 1-1/4" sch. 40 304L stainless steel pipe. There is a 1-1/4" full port ball valve with plug installed on the outlet of both to prevent leaking. The pitot aperture is sized to deliver 1.5-2 times isokinetic flow from the line being sampled. The return flange is a board flange with threaded nipple welded to match the size of the pitot.

See Figure 6 for an installation example.



**Figure 6. Sample Pitot and Sample and Return Port Flange**

## A BALLAST DISCHARGE MONITORING SYSTEM

### Electrical Cabinet

**Function:** Monitor and control the system logic.

**GSI Specific Equipment**

**Manufacturer:** Rockwell Automation.

**Model:** Custom.

**Description:** Contains the PLC, motor drives, and other necessary components, see Figure 7.



**Figure 7. Electrical Cabinet**

### Ultrasonic Flow Meter<sup>9</sup>

**Description:** Monitors the ballast discharge flow rate from the exterior of the ballast discharge pipe.

**GSI Specific Equipment**

**Manufacturer:** Fuji Electronics

**Model:** FSC w/FSD410B1 transmitters

**Description:** See Figures 8 and 9.



**Figure 8. Ultrasonic Flow Meter.**



**Figure 9. Flow Meter Transducer**

---

<sup>9</sup> GSI team determined that this approach to monitoring the ballast discharge flow rate was not sufficiently reliable and flexible across ships to warrant continued use. Instead, ideally, ballast treatment systems should be installed with magnetic flow meters. In the worst-case scenario, indirect methods of determining ballast discharge flow using tank level changes should be used.

### **Magnetic Flow Meter**

**Function:** Monitors the flow rate of water being sampled by the sampling system.

**GSI Specific Equipment:**

**Manufacturer:** Yamatake.

**Model:** MTG18A.

**Description:** Two Wire electromagnetic in-line flow meter, see Figure 10.



**Figure 10. Sample Flow Meter.**

### **Tub Level Transducer**

**Function:** Monitors the level of the water in the tub.

**GSI Specific Equipment:**

**Manufacturer:** Ametek DrexelBrook.

**Model:** 750 Series Well Watcher Submersible Level Transmitter.

**Description:** See Figure 11.



**Figure 11. Tub Level Transducer**

### **Sample Pump and Return Pump**

**Function:** Sample pumps water from ship's ballast lines to sample tub and return pumps back into the ballast line.

**GSI Specific Equipment:**

**Motor:** Dayton 1TRZ6.

**Pump:** Jabsco 777-9001

**Coupling:** Lovejoy AL095 & 68514471706.

**Description:** Flexible impeller pumps, custom aluminum frame. See Figure 12.



**Figure 12. Sample Pump**

### **Sample Tub**

**Function:** Provides a reservoir for the sampling net, with inlet and outlet.

***GSI Specific Equipment:***

***Manufacturer:*** RubberMaid.

***Model:*** 32 Gallon Heavy Duty trash can

***Description:*** Bulkhead fitting with a valve on the bottom as a water outlet, and an adjustable riser to hold the sample nets. See Figure 13.



***Figure 13. Sample Tub***

### **Laptop**

**Description:** Provides the interface for running the Ballast Sampling Program and data logging.

***GSI Specific Equipment:***

***Manufacturer:*** Panasonic Semi-Rugged Toughbook.

***Model:*** CF-52.

**Description:** The Toughbook provides some splash resistance and fall protection as well as dust protection that is above what a typical laptop would provide. It also provides access to equipment manuals, troubleshooting guides and other useful information while in the field. See Figure 14.





*Figure 14. Laptop.*

### **Whole Water Sampling Apparatus**

**Function:** For small volume collection that is representative of an individual sample period.

**GSI Specific Equipment:**

**Manufacturer:** Key Instruments (flow meter).

**Model:** 5079K53.

**Description:** Known as the “Seep Sampler”, the apparatus consists of a PVC T section on the 1” hose (with PVC union fittings) from the collection pitot to the sampling tub (Figure 1). A 1/2” brass fitting was used to connect the rotometer (flowmeter) to the PVC section. A brass fitting on the outlet of the rotometer connects to a small PVC hose (1/8”) leading into a carboy. A pinch clamp on the small tubing provides flow control. See Figure 15.



*Figure 15. Seep Sampler.*

### Human Machine Interface (HMI) Software

The GSI shipboard sample equipment is controlled using FactoryTalk Historian ME. FactoryTalk is a brand of HMI software that includes graphical representation (see Figure 16). Any HMI software used to control sampling equipment should include the following abilities:

1. Control of pump actives through PLC loops,
2. Ability to set sample pump as a percent of ballast line flow,
3. Data Logging and live data display, and
4. Fault and warning notifications.

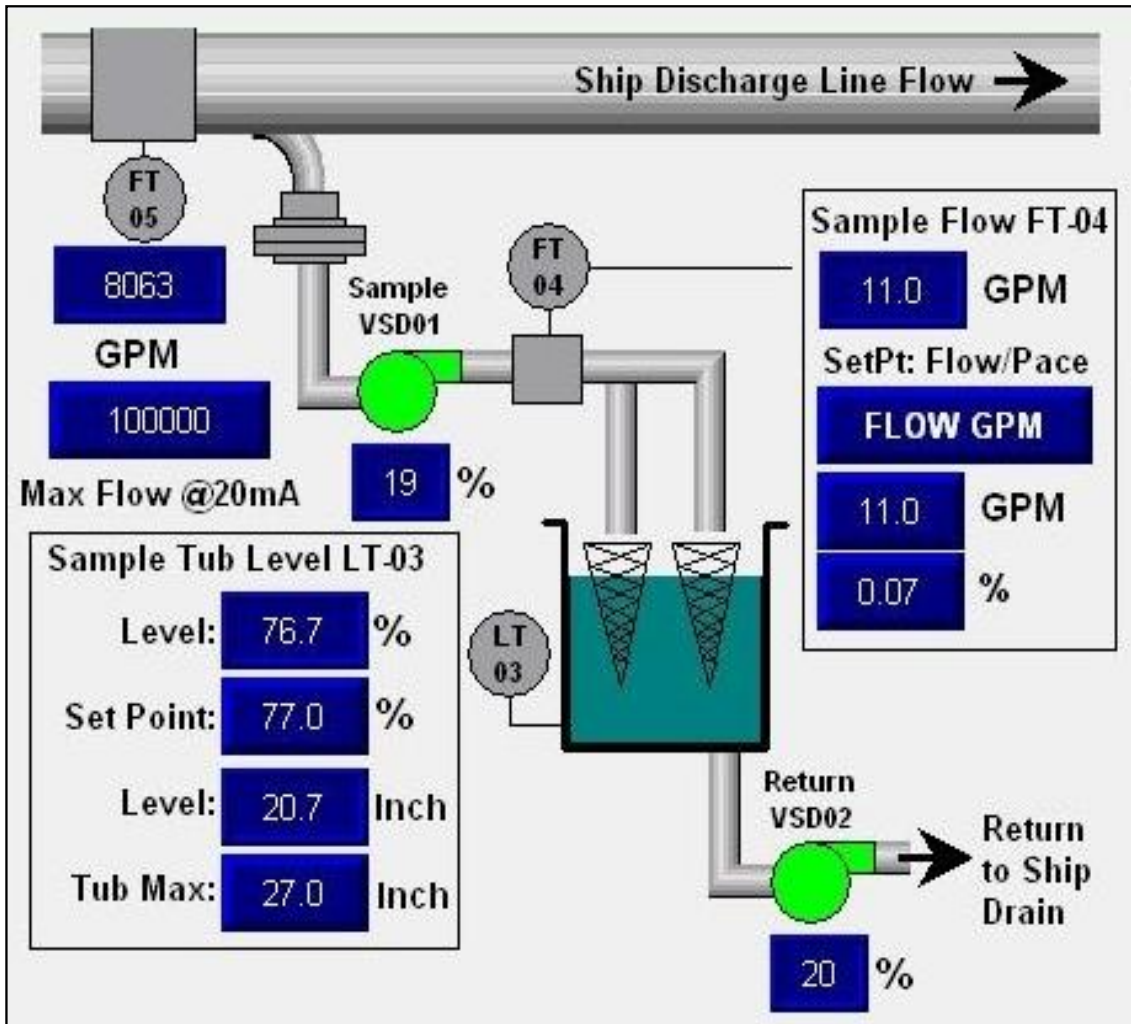


Figure 16. Sample Screen Image from GSI HMI Software.

## Sample Gear

Sample gear included the following items:

### Plankton Net and Cod-End

**Manufacturer:** Sea-Gear Corporation

**Model:** 9000 (30cm, 3:1, 35 micrometer mesh)

**Description:** Zooplankton samples are collected by concentrating the sample volume through a 35 micrometer mesh plankton net (i.e., 50 micrometers on the diagonal) into a 1 Liter cod-end for analysis. A minimum of one plankton net is required per sample. The plankton nets used by GSI during shipboard sampling were purchased from Sea-Gear Corporation of Melbourne, Florida (Figure 17).



*Figure 17. Plankton Net (35 micrometers) with Attached 1 Liter Cod-End.*

### Sample Collection Containers: Carboy, 20 Liter

**Manufacturer:** ULine

**Model:** S12768

**Description:** High-density polyethylene (HDPE) containers for time-integrated sample collection, the type and quantity of which are dependent on the test plan. For example, the time-integrated “seep” sample is collected using a 19 liter HDPE carboy (one per replicate;

## A BALLAST DISCHARGE MONITORING SYSTEM

Figure 18). For collection of whole effluent, two time-integrated “seep” samples are collected; one for whole water samples and one for whole effluent toxicity testing. From one time-integrate sample, total suspended solids and percent transmittance subsamples, as well as, whole water for analysis of protists are collected using HDPE sample bottles (Figure 18). Organic carbon samples (i.e., non-purgeable organic carbon and dissolved organic carbon) are collected using 125 mL glass sample bottles prepared by soaking in Micro-90® Concentrated Cleaning Solution (Figure 18). Microbial samples (a minimum of three subsamples per carboy) are collected using sterile 1 liter polypropylene bottles (not pictured). Extra sample containers should be carried aboard.



**Figure 18. Sample Collection Containers used for Shipboard Sampling Events.**

### Transport Coolers and Ice Packs

**Description:** To ensure sample integrity, proper sample holding and transport is of the utmost importance. Following sample collection, sample bottles are immediately placed into small sample transport coolers (Figure 19) and are kept cold until they are delivered to the sample analysis personnel by using a minimum of two ice packs per cooler (Figure 19).

### YSI Multiparameter Water Quality Sonde with Data Display and Logging System

**Manufacturer:** YSI Incorporated (Yellow Springs, Ohio)

**Model:** YSI 6-Series Model 6600 V2-4 Sonde and YSI 650MDS Data Logging System

**Description:** Water quality parameters are measured from the time-integrated sample using a YSI Multiparameter Water Quality Sonde (Figure 20). It is recommended that two Sondes be brought onboard in case one of the Sondes is not functioning correctly. The 6600 V2-4 Sonde (Figure 20) was used by GSI and included sensors to measure the following parameters: specific conductivity, salinity, pH, temperature, dissolved oxygen (concentration and percent saturation), turbidity, and total chlorophyll. The measured values are displayed using the YSI 650 MDS data logger (Figure 21).



*Figure 19. Small Sample Transport Cooler with Samples and Ice Packs.*



*Figure 20. (left), YSI 6-Series Multiparameter Water Quality Sonde (YSI 6600 V2-4)*

*Figure 21. (right), YSI 650 MDS Data Logging System*

## **Standard Operating Procedures, Test Plan, Datasheets and Laboratory Notebooks**

**Description:** A copy of the Test Plan, as well as, the sample collection SOPs, must be brought on board during the sampling event and must be readily accessible to the sample collection team. The appropriate datasheets will be identified in the Test Plan and extra datasheets should be brought onboard, along with extra pens (indelible ink only). Data may also be recorded in laboratory notebooks, although pre-printed datasheets are preferred due to the increased efficiency of data recording.

## **Personal Protective Gear and Dress**

The equipment listed below is the recommended, and in most cases, the required protective gear for personnel involved with the shipboard ballast sampling and operation of the equipment. The requirements of the vessels or the facilities through which the vessels are accessed may vary, and the sample team is expected to follow safety procedures required of the dock or ship, including Occupational Safety and Health Administration (OSHA) requirements.

- Hardhat,
- Steel toe boots,
- Safety Glasses,
- Hearing Protection (ear plugs or muffs, or in some cases both may be advisable),
- Flashlight or headlamp,
- Work Gloves,
- Work Clothing – work clothing should cover arms and legs, and fit in a manner as to not create a safety hazard. Jewelry (including rings) is not recommended and on many facilities not allowed,
- Transportation Worker Identification Card (TWIC) – Some facilities require for access.

## **Equipment Set Up and Tear-Down**

Equipment loading and unloading to and from the ship should be as swift as possible to minimize disruption to ship operations, and to avoid the possibility of needing to re-route entry during the loading. Two to four people can effectively accomplish set up and tear-down within 45 minutes to one hour for each operation. It is advisable to have one member of the set-up

team assigned to sonic flow meter set up, while the others bring the rest of the gear to the sampling location since flow meter set up can be time consuming. It is important to make sure that hose unions have the rubber grommet installed and that all connections are proper and snug. Equipment should be laid out with consideration to:

- Keeping walkways clear of wires and other equipment,
- Keeping wires and hoses neat, using wire ties to secure hoses and wiring out of the way, and
- Planning for good work flow.

Once all of the hoses are installed, the valves may be opened on the sample and return ports and at the pumps and sample tub. With the software program in manual mode, the pump rotation should be verified by powering the pump motor for a few seconds while someone checks for rotation. If the pump does not turn, the motor should be disconnected from the electrical cabinet and the guard removed to allow the pump to be manually turned over several times. This usually should require a "Lockout/Tagout" procedure. The guard should then be reinstalled and the pump rechecked.

During equipment tear-down, the sample port and return port valves must first be closed and the plugs secured. GSI's Ballast Sampling System is designed to automatically empty the sample tub at the conclusion of a test. Depending on the amount of water left in the sample tub, it may be best to place the control program into manual mode and completely drain the sample tub of water, tilting the sample tub to get the water into the drain. The sample lines must also be manually emptied into the sample tub.

Other tasks are:

- Packing the pump for removal,
- Removing the hoses from the sample pitots via unions,
- Shutting the valve on the return port to prevent any flow that may otherwise push back through the return pump,
- Backing up the data log file separately from the laptop,
- Packing and removing from the vessel the remainder of the hose, wiring, and equipment,
- Conducting a final visual check to assure that all equipment and personal items have been removed, and
- Ensuring that both the Sample and Return port valves are fully closed and the plugs firmly installed.

## Discussion

Overall, the sampling approaches and supporting equipment detailed in this paper performed well during GSI’s ship visits. GSI successfully loaded, set up and operated the sampling method described here within a feasible time window, and “left no trace” upon departing the ship, except for the pitot flange, which was removed later by the ship crew.

The costs of carrying out a sampling event using this method (excluding scientific supplies associated with sample analysis) are detailed in Table 3.

**Table 3. GSI Costs Per Sampling Event.**

	Cost Factor	Time/Cost
<b>One-Time Costs</b>	Ship Inspection	\$1,500
	Installation of flanges in a ship	\$2,000-\$5,000
	Reuseable Operational Equipment	\$45,000
	Biological Sampling Equipment	\$500-\$2000, depending on Test Plan
<b>Per Sampling Event Costs</b>	Set up and Tear Down of Sampling Equipment	1.5 – 2 hrs (total) assuming 2-3 staff
	Sample Collection Staff Time	TBD, depending on Test Plan
	Staff Travel	TBD, depending on Test Plan

## Equipment Performance

Sampling operational equipment performed as expected with the following exceptions:

***The Ultra-Sonic Flow Meter on the ships’ ballast discharge line performed inconsistently and unreliably***, jeopardizing the extent to which representativeness of the sample can be proven. It is important to sample a constant fraction of the ballast line flow through using an in-line magnetic flux flow meter on the sample line, and a portable ultrasonic flow meter mounted to the ships ballast piping. If one of these monitors is inconsistent, there is no direct means to assure that the sample volume and the flow volumes are proportional throughout the sampling process. Without this information, it becomes difficult to translate



organisms per unit volume in the sample to organisms per unit volume in the ballast discharge:

$$\frac{\text{Sample Flow Rate (inline magnetic flux flow meter)}}{\text{Ballast Line Flow Rate (portable ultrasonic flow meter)}} = \text{Constant}$$

The ultrasonic flow meter was also difficult to mount properly. It is highly recommended that ship owners and authorities encourage treatment system developers to include flow meters in their systems that have a proven in-situ performance to within 3 %. It is also recommended to have a standardized output connection so that the sample team can make use of that flow meter to facilitate the constant percent sampling necessary for a representative sample.

***It was necessary to tune up the PLC Control Loop.*** Because the sampling equipment is used on a number of different ships each having different arrangements, flow rates and pressures, sometimes it is necessary to fine-tune the automation of the sample system to prevent unstable rates or oscillating rates of the sample flow. It is recommended that the PLC control loop parameters be available (i.e. the Gain, Reset and Rate).

***The 32 Gallon heavy duty tub (sample collection barrel) though strong and light was awkward to bring aboard.*** Attaching backpack straps in the future may remedy this. Delivery of the 19 liter carboys for effluent toxicity testing was improved by placing each carboy inside a frame backpack for navigation from the sampling location to the dock.

## Recommendations

Key lessons learned in terms of sample event planning and staffing were:

***Scheduling of the sampling event is subject to changes*** in weather, ship equipment, and port schedules. Even when the ship has docked, the schedule is still subject to change. Depending on each ship and each cargo load, the ballasting and deballasting operation varies and may start and stop at various times (i.e. 6 hours of sampling may actually take 12 hours). Fresh sampling and analysis personnel are essential to quality data. It is recommended that sampling and analysis crew shifts of 24 hours be in place to address schedule contingencies.

***Equipment set-up and break-down is easier when shared among several team members.*** Initially, the engineers were more familiar with the equipment set up. As more sampling events took place, all personnel became familiar with the set up and break-down and could, therefore, provide more support and assistance in those areas.

***The ship pumping schedule is subject to variation making “beginning, middle and end” grab samples difficult to plan.*** The ballast pump (or pumps) move water at a rate that may be faster than the loading of cargo, resulting in starting and stopping of the pump (and therefore, sampling). As a result, determining three sets of discrete grab samples spaced approximately near the beginning, middle and end proves difficult. One hour samples seemed to work for all parties (i.e. each sample was one hour of collection). The test plan should require that a certain volume, duration, or number of tanks of ballast water discharge be sampled instead.

***Have a dedicated handling and sample transport person.*** This additional person allows maximum support aboard the ship and efficient delivery of the samples. This person could also return the previous samples' cooler and ice packs to ship personnel, eliminating the need to carry multiple transport equipment aboard the ship.

## **Conclusions**

The operational method for sampling ship discharge described in this paper is a feasible and cost-effective approach which can yield representative samples for a range of experimental objectives. It appears to be applicable to most ships which ply the Great Lakes. The costs of the exercise are dominated by a one-time investment in operational equipment. Installation of sample ports on ships is a relatively minor one-time expense. Costs of deployment of the sampling team and sample analysis are largely dictated by the test plan under consideration, as well as the number of schedule changes associated with the ship visit.

## **Acknowledgements**

The GSI team wishes to thank the Legislative Commission on Minnesota Resources, the United States Department of Transportation Maritime Administration and the Great Lakes Protection Fund for financial support for the work leading to the development of this Guidebook. We are indebted to the technical teams at the Navy Research Laboratory and Work Groups of the International Maritime Organization Maritime Environment Protection Committee for initial guidelines for effective sampling from ships. Most of all, the GSI project benefited from the participation and assistance of the ship owners and their capable Officers and Crew Members involved in the GSI effort to develop and test these methods. Specifically, we thank the owners, operators, officers and crew of the Niagara, Saguenay, M/V Tim S. Dool, M/V Indiana Harbor, Edwin H. Gott, Str. Herbert C. Jackson, M/V James R. Barker, M/V Hon. James L. Oberstar, Federal Hunter and Isolda.

## A BALLAST DISCHARGE MONITORING SYSTEM

### REFERENCES

GSI (2011), Great Ships Initiative (GSI) Quality Management Plan. Northeast-Midwest Institute, Washington, DC.

IMO (2004), International Convention for the Control and Management of Ships Ballast Water and Sediments. As adopted by consensus at a Diplomatic Conference at IMO, London, England, February 13 2004.

NSF International (September, 2010), Generic Protocol for the Verification of Ballast Water Treatment Technology. Version 5.1. EPA/600/R-10/146. Produced for the USEPA, Environmental Technology Verification Program in Conjunction with U.S. Coast Guard, Environmental Standards Division and U.S. Naval Research Laboratory, Center for Corrosion Science and Engineering. NSF International, Ann Arbor, Michigan.

United States Coast Guard (2008), Analysis of Ballast Water Sampling Port Designs Using Computational Fluid Dynamics. United States Coast Guard, Research and Development Center, Report No. CG-D-01-08. February 2008.

### GSI Team Members

#### PRINCIPAL INVESTIGATOR

Allegra Cangelosi, NEMWI

#### RESEARCH TEAM

Lisa Allinger, NRRI, UMD  
Mary Balcer, PhD, LSRI, UWS  
Lana Fanberg, LSRI, UWS  
Debra Fobbe, LSRI, UWS  
Steve Hagedorn, LSRI, UWS  
Travis Mangan, NEMWI  
Nicole Mays, NEMWI  
Christine Polkinghorne, LSRI, UWS  
Kelsey Prihoda, LSRI, UWS

Euan Reavie, PhD, NRRI, UMD  
Deanna Regan, LSRI, UWS  
Donald Reid, Consultant  
Elaine Ruzycski, NRRI, UMD  
Heidi Saillard, LSRI, UWS  
Heidi Schaefer, LSRI, UWS  
Tyler Schwerdt, AMI Engineering  
Tyler Snetting, AMI Engineering  
Matthew TenEyck, LSRI, UWS

## Sampling of Ballast Water for Compliance Control

Stephan Gollasch<sup>1</sup>, Matej David<sup>2</sup>

---

### **Abstract**

*Ballast water sampling is an important option to assess the compliance with ballast water management requirements. Organism diversity and behaviour are triggering complexity in ballast water sampling. As a result, different sampling strategies may be required to obtain a representative sample of ballast water discharge. The authors conducted two sampling studies onboard commercial vessels to study differences in the application of different sampling methods. This paper summarises the recommendations for how to obtain a representative sample of the whole ballast water discharge as required by the International Convention on the Management of Ships' Ballast Water and Sediments, 2004.*

**Key Words:** maritime transport, ballast water management, convention, sampling for compliance.

---

### **Introduction**

The International Maritime Organization (IMO), the United Nations body to address shipping, noted the problems caused by species movements with ballast water and tasked its Marine Environment Protection Committee (MEPC), *specifically*, the Ballast Water Working Group (BWWG), to draft an instrument to take care of this problem. As a result of many years of negotiations at IMO, the International Convention on the Management of Ships' Ballast Water and Sediments (BWM Convention) was adopted in 2004 (IMO, 2004). The BWM Convention introduces two different protective approaches which will sequentially be implemented after the BWM Convention enters into force:

- 1) The Ballast Water Exchange Standard (outlined in Regulation D-1 of the BWM Convention) requiring ships to exchange a minimum of 95% ballast water volume; and
- 2) The Ballast Water Performance Standard (outlined in Regulation D-2 of the BWM Convention).

The latter standard limits the number of viable organisms in the ballast water discharged, as shown below.

---

<sup>1</sup> GoConsult, Grosse Brunnenstr. 61, 22763 Hamburg, Germany, sgollasch@aol.com.

<sup>2</sup> University of Ljubljana, Faculty of Maritime Studies and Transport, Pot pomorščakov 4, SI 6320 Portorož, Slovenia.

### **Regulation D-2 Ballast Water Performance Standard**

- 1 *Ships conducting Ballast Water Management in accordance with this regulation shall discharge less than 10 viable organisms per cubic metre greater than or equal to 50 micrometres in minimum dimension and less than 10 viable organisms per millilitre less than 50 micrometres in minimum dimension and greater than or equal to 10 micrometres in minimum dimension; and discharge of the indicator microbes shall not exceed the specified concentrations described in paragraph 2.*
- 2 *Indicator microbes, as a human health standard, shall include:*
  - .1 *Toxicogenic Vibrio cholerae (O1 and O139) with less than 1 colony forming unit (cfu) per 100 millilitres or less than 1 cfu per 1 gram (wet weight) zooplankton samples;*
  - .2 *Escherichia coli less than 250 cfu per 100 millilitres;*
  - .3 *Intestinal Enterococci less than 100 cfu per 100 milliliters.*

Sampling ballast water of vessels to assess compliance with ballast water management requirements is very specific and includes sampling the biology of ballast water (e.g., David and Perkovič 2004, David et al. 2007), and the sample collection process should by no means influence such an assessment. It is possible to over or under-sample the real organism concentrations because of various potential errors (Gollasch et al. 2007). As the sampling process represents additional stress for organisms, they may be damaged during the process, and the underestimation may result in false compliance; as such, sampling representativeness becomes a key issue (Gollasch & David 2009, 2010).

To overcome this, the BWWG of IMO developed a sampling guideline (*i.e.* Guidelines for Ballast Water Sampling (G2) (IMO MEPC, 2008)) to provide sampling guidance. However, some key aspects were not addressed, such as the sampling frequency, the minimum water volume to be sampled and the number of samples to be taken.

An IMO correspondence group on ballast water sampling was established to deal with these issues. It is expected that at the next meeting of the Bulk Liquid and Gases Sub-committee in early 2012, the correspondence group will present their findings.

The authors were recently involved in two studies which aimed to recommend how to take representative samples of ballast water (Gollasch & David 2009, 2010). During both studies, several different options to sample the ballast water of vessels were practically tested onboard commercial vessels. The method comparison included short-time sequential samples versus samples taken over the entire ballast water pumping time. Results from these

## SAMPLING OF BALLAST WATER

studies suggest possible sampling strategies to obtain a representative sample of the whole ballast water discharge.

### **BWS Methods for Compliance Monitoring**

The results show that different approaches in the sampling process influence the results regarding organism concentrations. The organisms in the discharge are affected in different ways, therefore the selection of the “wrong” sampling approach may influence the compliance control result. The organism concentrations in the ballast water discharge may, therefore, be underestimated, and a “faulty” ballast water treatment system (BWTS) could be recognised as compliant. Conversely, organism concentrations may be overestimated, and a BWTS complying with the D-2 Standard may fail in compliance tests.

It should be noted that a certain level of pragmatism is required during on-board ballast water compliance control sampling especially when larger volumes of water need to be sampled. This is especially relevant when sampling for organisms above 50 micron in minimum dimension, and attempts should be made to avoid negatively impairing organism survival during the sampling process. Compliance control sampling teams are unlikely to have large water collection tanks (>1000 litres) available during the sampling event and will probably need to work with nets to concentrate the sample during the sampling procedure.

During the two studies the authors have undertaken, it was observed that the sampling duration (*i.e.* length of the sampling process), timing (*i.e.* which point in time during the discharge that the sampling is conducted), the number of samples and the sampled water quantity are the main factors which influence the results regarding organism concentrations.

### **Recommended sampling duration**

The results show that mainly zooplankton organisms above 50 microns in minimum dimension are negatively affected by longer sampling times. As these are the main component of the organisms in the group >50 micron, longer sampling times result in an underestimation of the viable organism concentration for this group in the discharge.

### **Recommended sampling timing and number of samples**

The results show that organism patchiness occurs in ballast tanks so that the organism concentrations vary considerably during the discharge. The highest variability was recognized in samples at the beginning or at the end of the discharge. Therefore, it is recommended that the sampling is conducted randomly anytime in the middle of the discharge with more than one sequential sample being taken.

### **Recommended sample quantity**

In this study, sequential sampling was conducted every 5 minutes for up to almost 2 hours. To obtain the most representative results, it is recommended that:

- for the organisms greater than 50 microns, less than 500 liters may be filtered and concentrated not to extend the sampling time;
- for the organisms greater than 10 microns and less than 50 microns, a "continuous drip" sample totaling approximately 5 liters should be taken.
- for bacteria, a sample of approximately 1 liter should be taken as a "continuous drip" sample.

### **Sampling logistics feasibility**

Different types, sizes and cargo profiles of vessels trigger very different ballast water discharge profiles and times. Ballast water discharge may be conducted "at once" or "in sequence", lasting from approximately one hour, up to several days depending on the length of the cargo operation. It is important to take this factor into account, as it is difficult to imagine that the PSC officer and/or sampling team would stay on-board the vessel for several days.

### **Conclusions**

If different sampling approaches are used by different PSC around the EU, it may occur that a vessel is sampled and determined to be in compliance in one port, but not in another. This would be an unacceptable situation.

Both studies have shown that different sampling approaches result in different organism concentrations. The sequential trials showed different numbers of organisms in the samples taken in the beginning, middle and end of the pumping event, but no consistent trend could be identified.

Considering the above recommendations on representative sampling, sampling of at least two random samples is feasible and relatively easy, while sampling over the entire time of the ballast water discharge would be quite difficult, especially if long sampling times are required over several days or during night.

Therefore, a harmonised sampling approach seems essential to provide consistent compliance tests.

## SAMPLING OF BALLAST WATER

### Acknowledgements

The first study was undertaken 2009 and was funded by the Federal Maritime and Hydrographic Agency, Hamburg, Germany. The second study was conducted in 2010, funded by the European Maritime Safety Agency (EMSA), Lisbon, Portugal. We would like to thank the vessel crews for their outstanding support to enable the sampling events. Further, our grateful thanks are expressed to the treatment system vendors Resource Ballast Technologies Ltd (Cape Town, South Africa), Mahle Industriefiltration GmbH (Hamburg, Germany) and Aquaworx ATC GmbH (Munich, Germany), as well as Wilhelmsen Ships Equipment (Norway, Poland); without their support, the sampling voyages would not have been possible.

### REFERENCES

*David, M, & M. Perkovič* (2004), Ballast water sampling as a critical component of biological invasions risk management. *Marine Pollution Bulletin* 49, 313–318.

*David, M, Gollasch, S, Cabrini, M, Perkovič, M, Bošnjak, D & D., Virgilio* (2007). Results from the First Ballast Water Sampling Study in the Mediterranean Sea - the Port of Koper Study. *Marine Pollution Bulletin* 54(1), 53-65.

*David, M. & S. Gollasch* (2008), EU Shipping in the Dawn of Managing the Ballast Water Issue. *Mar. Pollut. Bull.*, vol. 56, no. 12, 1966-1972.

*Gollasch, S. & M. David* (2009), Results of an on-board ballast water sampling study and initial considerations how to take representative samples for compliance control with the D-2 Standard of the Ballast Water Management Convention. Submitted by Germany to IMO Sub-committee Bulk, Liquid and Gases as BLG 14/INF.6, 11 pp. (Study funded by The German Federal Maritime and Hydrographic Agency, Hamburg (BSH)).

*Gollasch, S., David, M., Voigt, M., Dragsund, E., Hewitt, C. and Y., Fukuyo* (2007). Critical review of the IMO International Convention on the Management of Ships' Ballast Water and Sediments. *Harmful algae*, iss. 4, vol. 6, 585-600.

*Gollasch, S. & M., David* (2010), Testing Sample Representativeness of a Ballast Water Discharge and developing methods for Indicative Analysis. Report for Tender N° EMSA/NEG/09/2010. European Maritime Safety Agency (EMSA), Lisbon, Portugal, 124 pp.

IMO (2004). International Convention for the Control and Management of Ships' Ballast Water and Sediments. International Maritime Organization. 36 pp.

IMO MEPC (2008). Guidelines for Ballast Water Sampling (G2). International Maritime Organization, London. 14 pp.





## Validation of a Shipboard filter skid for Sampling Zooplankton from Ballast Water

Matthew First<sup>1</sup>, Edward J Lemieux<sup>2</sup>, Cameron S Moser<sup>3</sup>, Timothy P Wier<sup>3</sup>, Jonathan F Grant<sup>4</sup>, Stephanie H Robbins Wamsley<sup>1</sup>, Scott C Riley<sup>1</sup>, Mia K Steinberg<sup>5</sup>,  
Lisa A Drake<sup>6</sup>

---

### Abstract

*Proposed US and international performance standards for ships' ballast water allow for very low concentrations of live organisms. The limit for organisms  $\geq 50 \mu\text{m}$  in minimum dimension (nominally zooplankton) is  $<10$  living organisms  $\text{m}^{-3}$ . Large volumes of water (i.e. several  $\text{m}^3$  to 10s of  $\text{m}^3$ ) must be sampled to estimate zooplankton concentrations with suitable statistical confidence. Traditional sampling devices (e.g., plankton nets) are not well suited for use aboard ships, as nets are unwieldy and difficult to manage in the available small spaces, and the water filtered through plankton nets must be managed in the limited spaces of the commercial shipboard environment. To sample relatively large volumes from ballast discharges in a manner compatible with the shipboard environment, a novel shipboard filter skid (SFS) consisting of two stainless steel housings, each containing a filter bag, was constructed for use with closed fluidic systems such as shipboard piping.*

**Keywords:** zooplankton, sampling, shipboard

---

### Objectives

The objective of this study was to validate the efficacy of a prototype SFS for capturing living zooplankton at a land-based ballast water facility. Validation of the SFS included examining the retention efficiency of zooplankton proxies (microbeads), assessing the potential toxicity of filter skid materials, and comparing zooplankton samples collected with SFS to those collected with a plankton net at two sample volumes (5 and 10 $\text{m}^3$ ). Capture efficiency (CE), defined here as concentration of zooplankton in the SFS relative to the plankton net, was the metric used to evaluate the SFS. The overall goal of this work was to determine if the SFS could capture zooplankton efficiently without introducing high rates of zooplankton loss or mortality, and thus, be used as a substitute for plankton nets.

---

<sup>1</sup> SAIC, Inc., Naval Research Laboratory; Key West, FL.

<sup>2</sup> Naval Research Laboratory, Code 6130; Washington, DC.

<sup>3</sup> EXCET, Inc., Naval Research Laboratory; Key West, FL

<sup>4</sup> Battenkill Technologies; Manchester Center, VT

<sup>5</sup> Naval Surface Warfare Center, Carderock Division; West Bethesda, MD

<sup>6</sup> Naval Research Laboratory, Code 6136; Key West, FL

## Results

Microbead recovery in filter bags was >89% and 100% for microbeads of 50 $\mu$ m and 150 $\mu$ m diameters, respectively. Exposure to the sealant used to seal the filter bags' seams and the stainless steel materials of the housings did not lead to mortality in two zooplankton species. Overall, CE was higher in the SFS than in the plankton net:  $108 \pm 66\%$  (mean  $\pm$  SD, n=6). The SFS provided higher capture efficiency of zooplankton in trials using 5m<sup>3</sup> sample volumes (CE= $147 \pm 74\%$ , n=3), whereas CE was lower in trials using 10m<sup>3</sup> sample volumes ( $69 \pm 28\%$ , n=3). In trials with low CE, ciliates approximately 50  $\mu$ m in minimum dimension were poorly retained by the SFS relative to the plankton net. Mortality in both the filter skid and the plankton net was low (<4%).

## Conclusions

The data presented here show that, at lower sample volumes (i.e., 5m<sup>3</sup>), the SFS was a valid substitute for a plankton net for concentrating living zooplankton from ballast water systems. Future work should be done to validate the SFS aboard a vessel, where the flow rates and system pressure may fluctuate throughout the course of the sampling event. Additionally, the SFS should be validated in freshwater environments to verify that high CE of the filter skid is applicable to freshwater zooplankton communities, which may be dominated by soft-bodied organisms.

## Efforts to Develop a Ballast Water Detecting Device

Goran Bakalar, B. Sc.<sup>1</sup>

---

### Abstract

*Research of ballast water treatment devices does not address the research of repairs for these devices and the research of the permanent quality of such machinery. There is a need for a follow-up system. In this research, it analysed what technology is sufficient to support development of the ballast water bio-invasive organism detection. There are static and dynamic detecting efforts and challenges. Two methods were considered as good examples; for each of them, static and dynamic detection are possible. Methods of detection involving the DNA method are not reliable as dynamic detecting methods. Characteristics of the DNA method are described in this paper. Another method with some existing devices is already in use as another form of detection. Spectroscopy and cytometry have been explained, as well. Products that use this methodology were listed, and the functionality of the system has been explained. The use itself and reasons for it were researched in this paper, and the conclusions are discussed.*

**Key words:** Ballast water treatment devices on the ships, professional service and repairs, detection, methods, DNA, cytometry, bio-invasive organisms, scientific research using inducting method.

---

### Introduction

International law led to Convention of Ballast Water Management (BWM) 2004. The Convention requires that certified inspectors do their best to avoid *not needed stoppage caused by potential sampling* of all of the ships (p.12). In other words, attention is usually given to respect the contracts of transportation, rather than protect the seas. The inspector can give an order to a designated institution or certified laboratory to take samples and to analyse ballast water that any crew intends to discharge into the sea. This inspection in a laboratory includes analyses to find whether microorganisms exist in ballast water and to determine salinity and the kind of salt in such a way as to determine is the source of the ballast water. If the analyses find no microorganisms or any other reason that would prevent ballast water discharge, all the expenses would be paid by the Ministry that the inspector represents. Those expenses are very large and could even cause loss of the cargo in next port of call. There is a need for *cheaper* and faster inspections. New technologies could help lead to such solutions.

---

<sup>1</sup> Maritime consultancy Put Radosevca 52, 21000 Split, Croatia  
email: Goran.Bakalar@xnet.hr

## BAKALAR

Another reason why we need other solutions is weather conditions on the ships, and among the crew members. Experience has shown problems with the repairs that occur on the ships. There is a large difference between the correction of damage in the cargo tanks and in the ballast water tanks on ships. A good example is correction of the pittings in cargo tanks after the cargo of sulfur acid has been discharged and the tanks cleaned. The repair of the heating coils that exist in cargo tanks (one of the ways to hold liquid cargo at a consistent temperature) would be much more difficult if it were necessary in ballast water tanks. Another example is to derust and correct by welding a constructional problem in ballast or cargo tanks, when needed. The basic difference is in the height of the tanks — cargo tanks are three to ten metres high, and ballast tanks are a half meter up to 1.5 metres tall. To do any repair or welding job in that height is extremely difficult. The same problem could happen with any possible repair of a ballast water treatment device or welded holders of that device. Any equipment that exists in the salt water is in constant exposure to elements that cause damage. A ship's movement in storms combined with salt exposure results in a very big risk for damage or improper functionality of any device, heating coils or other methods of ballast water treatment in the ballast water tanks. Heating coils become loose over time, and the fluid in the heating system may leak and contaminate ballast water. Oil is usually used as the heating fluid in heating coils. It would be impossible to find from the location of the heating coil fluid leaks if the ballast inspector found the contamination. Even if the hole was found, there are measures, and the law that requires how and where it is allowed to repair such damage.

One of the solutions to control whether a ballast water device/system is actually functioning properly is to give opportunity to new technologies.

### **Detection Methods**

The detection of algae and other bio-invasive organisms in ballast water is important. It is necessary to avoid expenses that could be incurred by wrongful inspectors' decisions, and there is an obligation to protect the nature. The crew and the ship owners take the responsibility of ballast water treatment onboard the ships. The experience of using other monitoring devices (even not fixed in the salt water) (for example, oil discharge monitor) has resulted in various *overworks* by crew members. The most popular one is to bypass the oil discharge monitor in the monitoring system onboard the ships. It is expected that crew members all over the world will invent ways to bypass improperly functioning devices, and in the above mentioned case, ballast water treatment. To evaluate good or improper functioning of ballast water treatment systems onboard a ship requires a good method to detect bio-invasive algae and other microorganisms. Good methods are dynamic methods. A good method that could detect unwanted microorganisms needs to be dynamic and able to scan extremely quickly. It is also necessary to format data, analyse that data and process large data files. Advantages of silico-imaging or scanning are the high acquisition rate of up to 1000

## EFFORTS TO DEVELOP A BALLAST WATER DETECTING DEVICE

scans per second through a USB interface, the suitability of the data format for standard flow cytometer data analysis and fast processing of large data files.

### **DNA Detection Method**

DNA analysis led to a new way to answer old questions in science. The DNA analysis method is an initiation to cytometry analyses. DNA analyses are done in a laboratory and sometimes it requires days to inspect some objects of detection. DNA taxonomy is based on the analysis of small segments of genomes. Group of nucleotides of each alga is a different barcode that exists in different algae. Those barcodes filed in a database are used to identify all algae of the world. The following example shows that the time for DNA detection in that case was shortened to three hours.

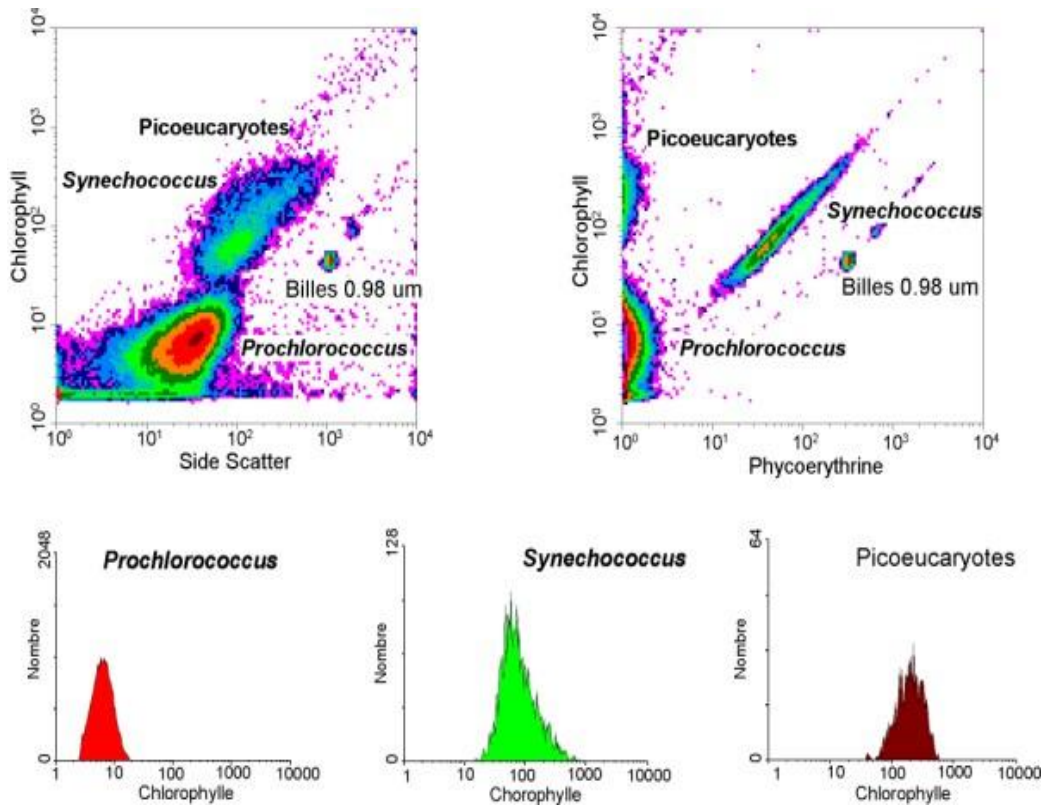
A technique used for detecting *Raphidophycean*, a bloom-forming genus of algae, was developed using a specific DNA probe. The design of the probe was based on a sequence polymorphism within the small subunit ribosomal DNA (rDNA) gene of a strain by using fluorescence polarization analysis and the BIAcore 2000 biosensor, which utilized surface plasmon resonance. The specific sequence for *Heterosigma carterae* was determined by sequence data analysis. One pair of polymerase chain reaction probes was designed for use in making the identification. *Heterosigma carterae* rDNA was amplified by using a fluorescein isothiocyanate-labeled or biotin-labeled oligonucleotide probe, the amplified rDNA was selectively detected as an intensive change via analysis or as a resonance-unit change. Although total time for final detection after sampling was within 3 hours, specific rDNA could be detected within 10 minutes through these detection methods [1].

### **Cytometry Detection Method**

The power of the flow cytometric analysis principle is that the cells are passing a laser beam one-by-one at high speed and their individual light scattering and fluorescence properties are recorded to form an optical *fingerprint* for each cell. This separates the flow cytometric method from bulk methods for fluorescence spectra and/or size spectra for bulk volumes of water, where it is much harder to discriminate between the contributions of the various groups in the water since the readings are collected for all particles at once. Flow cytometry allows easy recognition of the different groups in the sample and quantification of their abundance, as well as their optical properties (size, pigment) - even the detection of a few rare cells from within a high number of cells from a blooming species.

### **History**

The first impedance-based flow cytometry device, using the Coulter principle, was disclosed in U.S. Patent 2,656,508, issued in 1953, to Wallace H. Coulter. The first fluorescence-based flow cytometry device (ICP 11) was developed in 1968 by Wolfgang Göhde from the



**Figure 1. Some scans of flow cytometry technology [ 2 ].**

University of Münster and first commercialized in 1968/69 by German developer and manufacturer Partec through Phywe AG in Göttingen. At that time, absorption methods were still widely favored by other scientists over fluorescence methods. Soon after, flow cytometry instruments were developed, including the Cytofluorograph (1971) from Bio/Physics Systems Inc. (later: Ortho Diagnostics), the PAS 8000 (1973) from Partec, the first FACS instrument from Becton Dickinson (1974), the ICP 22 (1975) from Partec/Phywe and the Epics from Coulter (1977/78).

The original name of the flow cytometry technology was "pulse cytophotometry". Only 20 years later in 1988, at the Conference of the American Engineering Foundation in Pensacola, Florida, the name was changed to "flow cytometry", a term that quickly became popular.

### **Principle of flow cytometry**

A beam of light (usually laser light) of a single wavelength is directed onto a hydrodynamically-focused stream of fluid. A number of detectors are aimed at the point where the stream passes through the light beam: one in line with the light beam (Forward Scatter or FSC), several perpendicular to it (Side Scatter or SSC), and one or more fluorescent detectors. Each suspended particle from 0.2 to 150 micrometers passing through the beam

## EFFORTS TO DEVELOP A BALLAST WATER DETECTING DEVICE

scatters the ray, and fluorescent chemicals found in the particle or attached to the particle may be excited into emitting light at a longer wavelength than the light source. This combination of scattered and fluorescent light is picked up by the detectors, and, by analysing fluctuations in brightness at each detector (one for each fluorescent emission peak), it is then possible to derive various types of information about the physical and chemical structure of each individual particle. FSC correlates with the cell volume and SSC depends on the inner complexity of the particle (i.e., shape of the nucleus, the amount and type of cytoplasmic granules or the membrane roughness) [3].

### Flow cytometers

Modern flow cytometers are able to analyze several thousand particles every second, in *real time*, and can actively separate and isolate particles having specified properties. A flow cytometer is similar to a microscope, except that, instead of producing an image of the cell, flow cytometry offers "high-throughput" (for a large number of cells) automated quantification of set parameters. To analyze solid tissues, a single-cell suspension must first be prepared.

A flow cytometer has five main components:

- a flow cell - liquid stream (sheath fluid), which carries and aligns the cells so that they pass single file through the light beam for sensing,
- a measuring system - commonly used are measurement of impedance (or conductivity) and optical systems - lamps (mercury, xenon); high-power water-cooled lasers (argon, krypton, dye laser); low-power air-cooled lasers , diode lasers (blue, green, red, violet) resulting in light signals,
- a detector and Analogue-to-Digital Conversion (ADC) system - which generates FSC and SSC as well as fluorescence signals from light into electrical signals that can be processed by a computer,
- an amplification system - linear or logarithmic,
- a computer for analysis of the signals. [3].

The process of collecting data from samples using the flow cytometer is termed *acquisition*. Acquisition is mediated by a computer physically connected to the flow cytometer and the software which handles the digital interface with the cytometer. The software is capable of adjusting parameters (i.e. voltage, compensation, etc.) for the sample being tested, and also assists in displaying initial sample information while acquiring sample data to insure that parameters are set correctly. Early flow cytometers were, in general, experimental devices, but technological advances have enabled widespread applications for use in a variety of both clinical and research purposes. Due to these developments, a considerable market for



instrumentation, analysis software, as well as the reagents used in acquisition, such as fluorescently-labeled antibodies, has developed.

Modern instruments usually have multiple lasers and fluorescence detectors. The current record for a commercial instrument is four lasers and 18 fluorescence detectors. Increasing the number of lasers and detectors allows for multiple antibody labeling, and can more precisely identify a target population by their phenotypic markers. Certain instruments can even take digital images of individual cells, allowing for the analysis of fluorescent signal location within or on the surface of a cell.

### **Data analysis**

The data generated by flow-cytometers can be plotted in a single dimension (to produce a histogram), in two-dimensional dot plots, or even in three dimensions. The regions on these plots can be sequentially separated, based on fluorescence intensity, by creating a series of subset extractions, termed *gates*. Specific gating protocols exist for diagnostic and clinical purposes especially in relation to hematology. The plots are often made on logarithmic scales. Because different fluorescent dyes' emission spectra overlap, signals at the detectors have to be compensated electronically, as well as computationally. Data accumulated using the flow cytometer can be analyzed using software. Once the data are collected, there is no need to stay connected to the flow cytometer. For this reason, analysis is most often done on a separate computer. This is especially necessary in core facilities where usage of these machines is in high demand.

### **Fluorescence-activated cell sorting**

Fluorescence-activated cell sorting (FACS) is a specialized type of flow cytometry. It provides a method for sorting a heterogeneous mixture of biological cells into two or more containers, one cell at a time, based upon the specific light scattering and fluorescent characteristics of each cell. It is a useful scientific instrument, as it provides fast, objective and quantitative recording of fluorescent signals from individual cells, as well as physical separation of cells of particular interest.

The cell suspension is entrained in the center of a narrow, rapidly flowing stream of liquid. The flow is arranged so that there is a large separation between cells relative to their diameter. A vibrating mechanism causes the stream of cells to break into individual droplets. The system is adjusted so that there is a low probability of more than one cell per droplet. Just before the stream breaks into droplets, the flow passes through a fluorescence measuring station where the fluorescent character of interest of each cell is measured. An electrical charging ring is placed just at the point where the stream breaks into droplets. A

charge is placed on the ring based on the immediately prior fluorescence intensity measurement, and the opposite charge is trapped on the droplet as it breaks from the stream. The charged droplets then fall through an electrostatic deflection system that diverts droplets into containers based upon their charge. In some systems, the charge is applied directly to the stream, and the droplet breaking off retains charge of the same sign as the stream. The stream is then returned to neutral after the droplet breaks off [ 4 ].

### **Applications**

The technology has applications in a number of fields, including molecular biology, pathology, immunology, plant biology and marine biology. It has broad application in medicine (especially in transplantation, hematology, tumor immunology and chemotherapy, genetics and sperm sorting for sex preselection). In marine biology, the auto-fluorescent properties of photosynthetic plankton can be exploited by flow cytometry in order to characterise abundance and community structure. In protein engineering, flow cytometry is used in conjunction with yeast display and bacterial display to identify cell surface-displayed protein variants with desired properties. It is also used to determine ploidy of grass carp fry [5].

### **Particle scanning:**

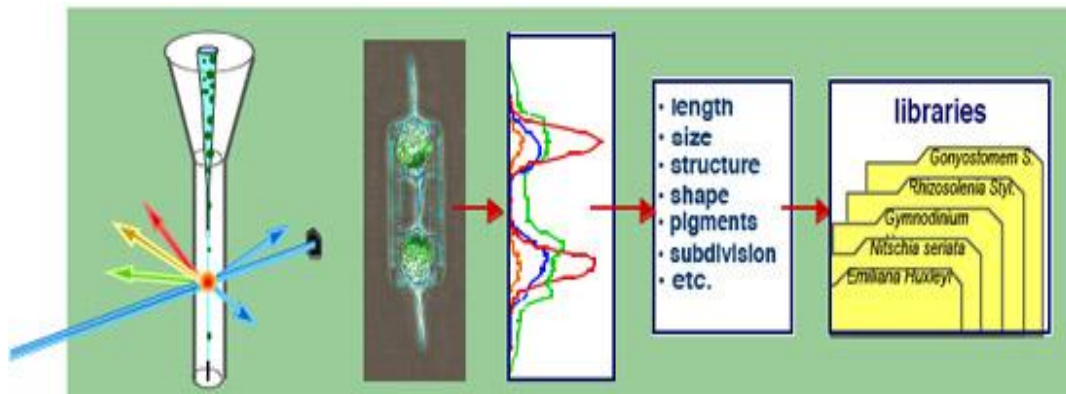
Traditional flow cytometers analyze thousands of cells per second acquiring basic total fluorescence and light scattering per cell. This is proportional to particle size and pigment content.

In the cytosome instruments the signals from all the detectors are not only digitized continuously, they are also stored for each particle. Since the particles flow through the laser focus in a stretched-out manner these digital profiles are actually length scans of the particle, representing the distribution of its *body parts* along its length axis with regard to their light scattering and fluorescing properties. This fluid driven laser scanning of individual particles is called silico-imaging and uses the normal flow cytometer setup combined with special data grabber boards. The optional *curvature* sensor adds a two-dimensional component to the silico-images using a laser beam polarization setup only available on flow cytometers.

Advantages of silico-imaging or scanning is the high acquisition rate of up to 1000 scans per second through a USB interface, and the suitability of the data format for standard flow cytometer data analysis and fast processing of large data files. Libraries of these fingerprints allow the automatic classification and enumeration of groups and species from many data sets, as well as online warning for target (algae) species.

## Cytobuoy

CytoBuoy instruments use silico-imaging as the basic data format: data-extensive but highly informative optical fingerprints obtained by fluid-driven laser scanning of individual particles. Libraries of these fingerprints allow the automatic classification and enumeration of groups and species from large data sets, as well as online warning for targeted harmful algae species.



**Figure 2. Principle of screening and filing data of harmful algae [ 5 ].**

To be able to take the instrument and put it in/under water, the flow cytometer was completely redesigned to be significantly smaller and modular. The basic instrument, which is a scanning flow cytometer, which can hold two lasers and up to ten optical detectors in a 30x45cm cylinder of only 15KGs. The instrument is fully computer programmable with the possibility to read the data files over the internet, if needed. The same instrument can be placed in a moored buoy or a high pressure submersible housing, which makes it possible to do field measurements on actual live samples (without filtering - fixatives - transportation - waiting), anywhere and at anytime.

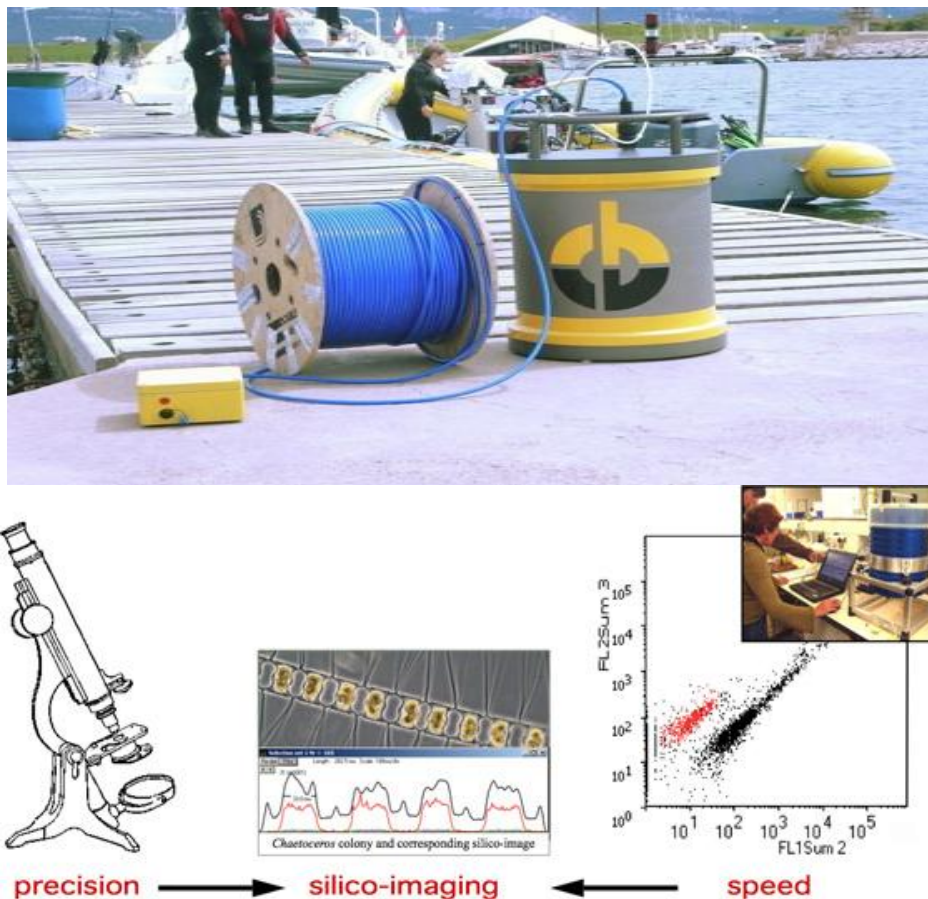
Applications of the cytobuoy are screening of phytoplankton cultures, natural samples, detection of rare species, population dynamics research, general phytoplankton monitoring, assessment of biodiversity, bio-indicators, harmful algal blooms, grazing, (micro)zooplankton, protection of aquaculture, bathing water, resource water, lake restoration, alarm for herbicides, invasive species control and bio-effect monitoring, marine optics and lake or sea truth for remote sensing.

## Conclusions

An instrument is required that combines a high level of information content and a high level of frequency in sampling times and/or space (coverage). Dynamic ecosystems require sampling at *critical scales*: the temporal and/or spatial scales at which data must be collected in order

## EFFORTS TO DEVELOP A BALLAST WATER DETECTING DEVICE

to resolve patterns and processes (including early warning). In practice, this means the flow cytometer could be fixed on ships, underwater and on moorings, and should allow a high level of autonomous operation combined with high speed and high throughput.



**Figure 3. Buoy equipped for flow cytometry detection [ 5 ].**

Ballast water inspectors can inspect ballast water, but it is not necessary. That is, in accordance with Ballast Water Convention, Inspectorate has to pay stoppage expenses if the analyses were negative. A fast analysis method combined with increased fines would diminish any possibility of non-compliant work.

The fast and quantitative diagnostic capabilities of the flow cytometers may be of great help for the fast screening of ballast water by generating countings and accurate size spectra for sediment particles, phytoplankton and other groups of particles. This can be used to monitor the efficiency of selected treatment schemes for organisms, or even serve as a feedback mechanism to actively control treatment performance [6].

## BAKALAR

### REFERENCES

1. <http://www.springerlink.com/content/5wr78nck7m01vheu/>
2. [http://en.wikipedia.org/wiki/File:Picoplancton\\_cytometrie.jpg](http://en.wikipedia.org/wiki/File:Picoplancton_cytometrie.jpg)
3. [http://en.wikipedia.org/wiki/Flow\\_cytometry](http://en.wikipedia.org/wiki/Flow_cytometry)
4. [www.cytobuoy.com](http://www.cytobuoy.com)
5. <http://www.cytobuoy.com/applications/aquaticscience.php>
6. [http://www.cytobuoy.com/products/cytobuoy\\_flow\\_cytometer.php](http://www.cytobuoy.com/products/cytobuoy_flow_cytometer.php)

## A Portable, Sensitive Plankton Viability Assay for IMO Shipboard Ballast Water Compliance Testing

Nick Welschmeyer<sup>1</sup>, Brian Maurer

---

### **Abstract**

*One of the most difficult aspects of implementing ballast water regulatory compliance is field verification testing of ballast treatment systems to validate proper biological inactivation efficacy. Whether tests are to be carried out by regulatory personnel as an enforcement tool, or by ship crew members as a process verification tool, a rapid, simple, accurate test that can be performed onboard ship with a minimum amount of effort is needed.*

*A rapid method for estimating living planktonic biomass, based on the quantitative, enzymatic transformation of fluorescein diacetate (FDA) into its fluorescent product, fluorescein, has been developed for use in ballast water compliance testing. FDA has been utilized as a cell-specific tag for cellular viability for almost five decades (Rotman and Papermaster, 1966) and is now a recommended procedure in US EPA/ETV ballast water testing protocol. However, the technique has been criticized often for the apparent cellular efflux of fluorescein which results in rapid optical fading of fluorescently labeled 'living' cells. We completed a flow cytometric analysis of the time-based, cell-specific fluorescent labeling properties of FDA in phytoplankton, clearly identifying the rapid influx/efflux kinetics of its fluorescent product. Simultaneous temporal measurements of the extracellular medium revealed a linear, quantitative increase in bulk fluid fluorescence that can be used as a sensitive, analytical estimate of 'living' biomass. That is, the production rate of extracellular fluorescein is quantitatively proportional to total living biomass; in contrast, killed cells produce no fluorescent product. Assay conditions, including quantitative temperature effects, specific incubation buffers (that prevent abiotic conversion of FDA to fluorescein), and reaction termination techniques were developed. Tests can be completed in less than one hour with portable equipment (hand-held, battery-operated fluorometer) and modest technical training; if desired, samples can be terminated and stored for analysis at a later time.*

*The assay reagents were developed specifically to minimize 'false positives' and to allow accurate assay of ballast water ranging in salinity from 0-35 PSU. The resulting bulk fluorescence assay provides estimates of living biomass with sensitivity comparable to ATP analyses, without many of the drawbacks associated with ATP testing. The sensitivity is such that the regulated ballast water organism size class, 10-50  $\mu\text{m}$  (100 mL sample), can be tested for 'gross exceedance' compliance*

---

<sup>1</sup> Moss Landing Marine Laboratories, Moss Landing, California 95039, USA and Golden Bear Facility (GBF), California Maritime Academy, Vallejo, California 94590 USA  
email: welschmeyer@mlml.calstate.edu

*criteria in less than 15 minutes. When executed with larger volumes (1 L), at elevated temperatures (30 C) and longer incubations (2h), the method can detect living biomass at levels lower than current IMO regulatory tolerance levels, for example, less than 10 live cells/mL (10  $\mu$ m equivalent spherical diameter). The FDA bulk viability assay was executed successfully onboard the training ship, Golden Bear (California Maritime Academy), in real-time ballast tests in Busan S. Korea; Kobe, Japan; Guam, USA; and San Francisco Bay, USA.*

*This method has the potential to solve the problems currently associated with compliance and process control testing carried out onboard ship. The speed, sensitivity, simplicity and economics of the new method will make it a useful tool for those interested in verifying the function of ballast water treatment systems.*

---

## 1 Introduction

The discharge of ships' ballast water is considered the primary vector in the spread of aquatic invasive species. The maritime industry and international, federal and state agencies have made significant efforts to foster the development of commercial ballast treatment systems that will remove or inactivate planktonic organisms from ballast water for the purpose of abating the aquatic invasive species problem. Unfortunately, existing regulations, such as IMO D-2, require exhaustive analytical procedures to verify biological inactivation efficiency of treatment systems relative to regulatory performance standards. The labor, time, and workforce required to fully substantiate successful adherence to ballast performance standards precludes such exhaustive tests for routine ship inspections.

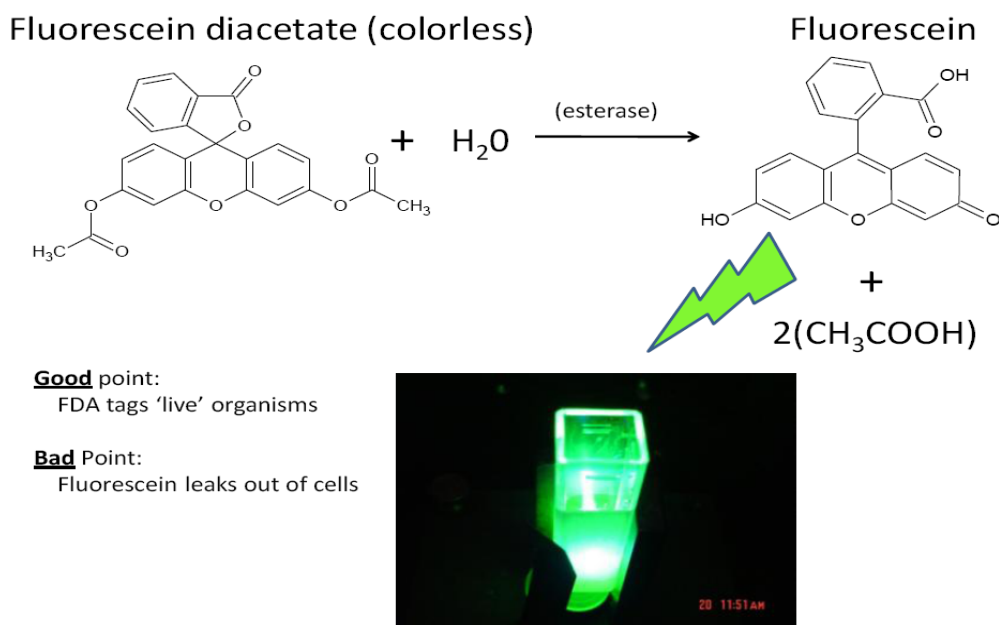
At this time, there is a need for a simple, rapid analysis of plankton viability for the purpose of ballast treatment verification through Port State Control, either at the dock or onboard ship. Moreover, such a method should be available to ships' crews so that non-technical personnel can easily verify ballast treatment performance during routine shipboard ballasting operations.

A rapid, portable viability assay is described here that provides single-step analytical determination of ballast compliance in less than one hour. The method breaks from the conventional tedious determination of numeric live counts (microscopy/cytometry) and utilizes a bulk quantitative fluorescence determination of total viable biomass, based on the universal enzymatic conversion of fluorescein diacetate (FDA) to its fluorescent product, fluorescein.

## 2 Fluorescein Diacetate as Bulk Indicator of Viable Biomass

FDA has a long history of use as a visual marker for cell-specific determination of viability (Rotman and Papermaster, 1966). FDA is a non-fluorescent compound which, when hydrolyzed by biological enzyme activity, yields fluorescein, a highly fluorescent compound that clearly marks 'live' cells with optically-induced green fluorescent emission (Figure 1).

## A PORTABLE, SENSITIVE PLANKTON VIABILITY ASSAY



**Figure 1. Simplified summary of the use of fluorescein diacetate (FDA) as a tag for viable organism metabolism; esterase activity is present in all living organisms and is rapidly lost upon cell death.**

FDA cell-specific viability analysis is commonly quantified by numeric counts made either by epifluorescence microscopy or flow cytometry (Dorsey et al., 1989; Brussaard et al., 2001; Garvey et al., 2007). It should be understood, however, that the FDA technique is not a staining procedure per se (e.g., the reaction product, fluorescein) is not chemically bound to specific targets within the cell. FDA and fluorescein readily pass diffusively through cell membranes making the loading of FDA into the interior of cell tissue a simple task in aqueous cellular suspensions. Unfortunately, the subsequent efflux of fluorescein out of the cell's interior results in rapid fading of the optical cellular signature. FDA cell-specific viability assays have been criticized often for this apparent inconvenience, which requires immediate numerical analysis and offers no opportunity for storage of samples for later analysis (Garvey et al. 2007). As a result, chemical variants of FDA, utilizing larger molecular moieties of fluorescein, such as chloro-methoxy fluorescein diacetate (CMFDA) and Calcein AM (Invitrogen Inc.), have been developed; these larger molecules extend the period of optical recognition.

In contrast to the classic *internal* cell-specific application of FDA in viability assays described above, a few reports have described the use of FDA as a *bulk* indicator of viable cell biomass, in this case, based on simple fluorometric analysis of the extracellular bulk fluid in which the cellular material is suspended. This procedure has been described for use with soil samples,



leaf litter and industrial cell slurries (Breeuwer et al., 1995). Generally, the bulk approaches have enjoyed limited application due to: a) well known non-biological conversion of FDA into fluorescein in the extracellular media (Clarke et al. 2001), and 2) uncertainties in the relation between fluorescein production and viable biomass concentrations, per se (Breeuwer et al., 1995).

In the present work, we re-examine the extra-cellular bulk analysis of FDA-derived fluorescein for the purpose of quantitatively and rapidly determining viable biomass of ballast water organisms. We have converted the FDA methodology into a *bulk* assay that yields simple, cuvet-based fluorometric readings; this is ideal for ballast water testing. Reagent mixtures were developed to accommodate the wide range of salinities that can characterize ballast water organisms (e.g., 0-35 PSU). Reagents were developed to prevent non-biological conversion of FDA to fluorescein, thus reducing the possibility of a 'false-positive' indication of viable cells. The protocol was optimized to yield the highest sensitivity in the shortest period of time. Our plan was to devise a relatively fool-proof method that can be executed reliably in the field with minimum technical training, yet still provide the sensitivity to detect undesirable living planktonic biomass in ballast water at low levels commensurate with ballast water performance standards.

### 3 Methodology

*Biological samples;* Both cultured phytoplankton and natural plankton assemblages were used to generate FDA viability response and to determine the cellular densities required to elicit adequate analytical sensitivity. Phytoplankton cultures were obtained from collections that have been maintained by Drs. G.J. Smith and N. Welschmeyer for years at Moss Landing Marine Laboratories. The cultures were grown in F/2 enriched seawater (marine organisms) or enriched freshwater media (Algo-Gro, Carolina Biological, Inc.) in temperature controlled incubators with 12h:12h dark:light cycles under fluorescent irradiance (18°C). Cultures were also maintained on a north-facing windowsill at room temperature subject to seasonal changes in day length. Natural plankton were sampled from Moss Landing Harbor, a shallow, turbid marine harbor environment, and also from open water in Monterey Bay, CA, accessed through cruises aboard the research vessel, POINT SUR.

*Instrumentation;* A high sensitivity Spex Fluoromax 2 spectrofluorometer was used determine excitation/emission spectral characteristics of FDA derived fluorescein. The same instrument was used in non-scanning mode at optimized excitation/emission wavelengths to provide the most sensitive fluorescence response when biological samples were diluted to their weakest concentrations (e.g., less than IMO D-2 performance concentrations for organisms 10-50  $\mu\text{m}$  in size). At our request, a Turner Designs hand-held, battery-operated fluorometer

## A PORTABLE, SENSITIVE PLANKTON VIABILITY ASSAY

(Aquafluor™) was modified by the manufacturer to yield optimized response sensitivity to aqueous solutions of fluorescein. This includes a change in LED excitation source, ex/em filters and circuit board power characteristics; this resulted in a portable fluorescein fluorometer that was roughly fifteen-fold more sensitive to fluorescein than the standard off-the-shelf configuration.

Cellular densities of cultured phytoplankton were measured by flow cytometry on either a Becton Dickinson FACScan cytometer or an Accuri C-6 cytometer, each calibrated for flow rates using BD Accumax calibration beads. Organism size characteristics were determined microscopically on a Zeiss Standard epifluorescence microscope.

*Reagents*; All reagents used in this study were obtained from readily available chemical sources; however, specific mixtures, treatments and concentrations remain proprietary. Briefly, an aqueous incubation buffer with organic modifiers was developed that: 1) promotes FDA enzymatic hydrolysis by all single-celled organisms regardless of the original salinity of their natural waters (0-35 PSU), and 2) prevents undesired, non-biological degradation of FDA to fluorescein in the absence of viable biota, a problem which yields high blanks and false detection of viable cells. FDA in DMSO was administered in 10  $\mu$ L quantities to yield final FDA concentrations in incubation buffers of 10  $\mu$ M. Generally, organisms were harvested onto appropriate filters, the filters were incubated in the appropriate buffer, and fluorescence was determined in the incubation fluid after removal of the filter and gentle mixing.

## 4 Results

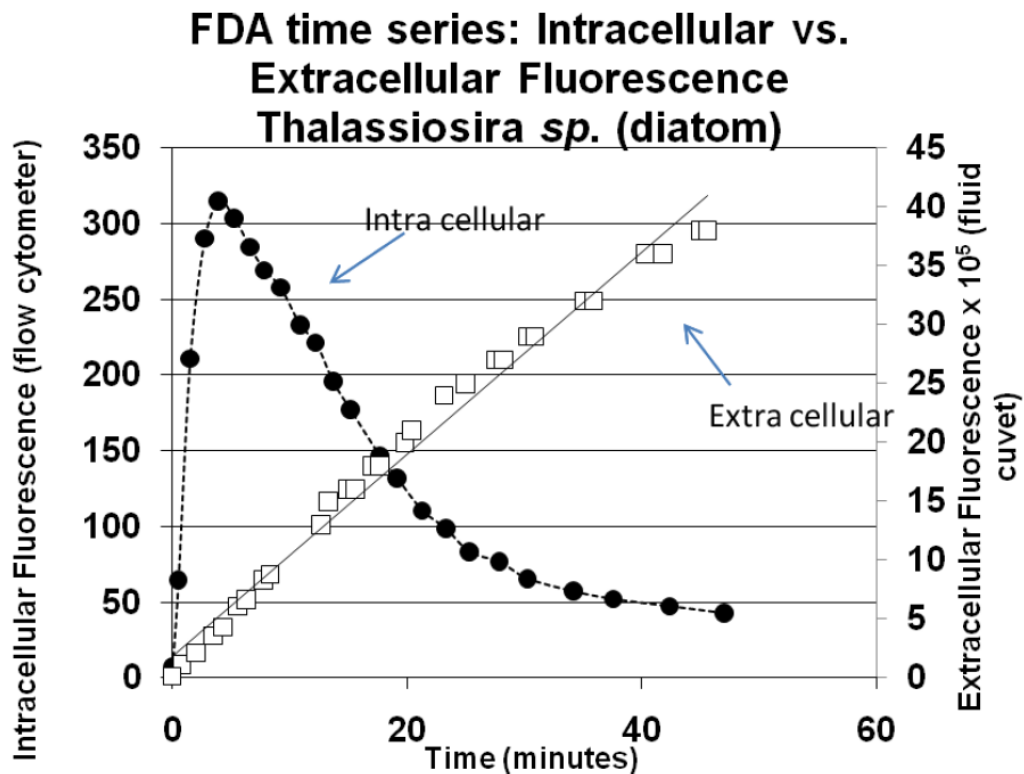
### **Intracellular and Extracellular Fluorescence Derived From FDA**

Time-based studies were initiated to define the time scales, and fate, of fluorescence derived from FDA-labeling of live phytoplankton cells. Flow cytometry was used to quantify the intensity of intracellular fluorescence that accumulates (and fades) after FDA inoculation. At least 2,000 cells were analyzed at each time-point to capture individual cellular levels of green fluorescence over the course of approximately one hour. The population mean fluorescence was computed for each time-point yielding the temporal changes in average fluorescence/cell (Figure 2). Parallel measurements of the same sample were made simultaneously over the same time period in a conventional cuvet-based fluorometer (Spex Fluoromax 2) so that total fluorescence of the suspension could be monitored. At the end of the observation period, the cells were removed by centrifugation and the extracellular fluid was measured for fluorescence.

The results in Figure 2 give an example of the FDA labeling characteristics generally found for all samples analyzed. The intracellular fluorescence rose quickly after FDA inoculation

and, for the diatom *Thalassiosira* sp., peaked at approximately 5 minutes (Figure 2). There was a slow, but continuous, drop in fluorescence/cell that eventually approached the initial time-zero level of fluorescence. All species tested showed the same trend, with maximum fluorescence found somewhere between 4-20 minutes. Interestingly, even though the cellular fluorescence was adequately bright for cytometric detection, the total fluorescence of the algal suspension was dominated entirely by *extracellular* fluorescence. That is, removal of the cells by centrifugation resulted in less than 1% reduction in the measured fluorescence of the fluid in the cuvet.

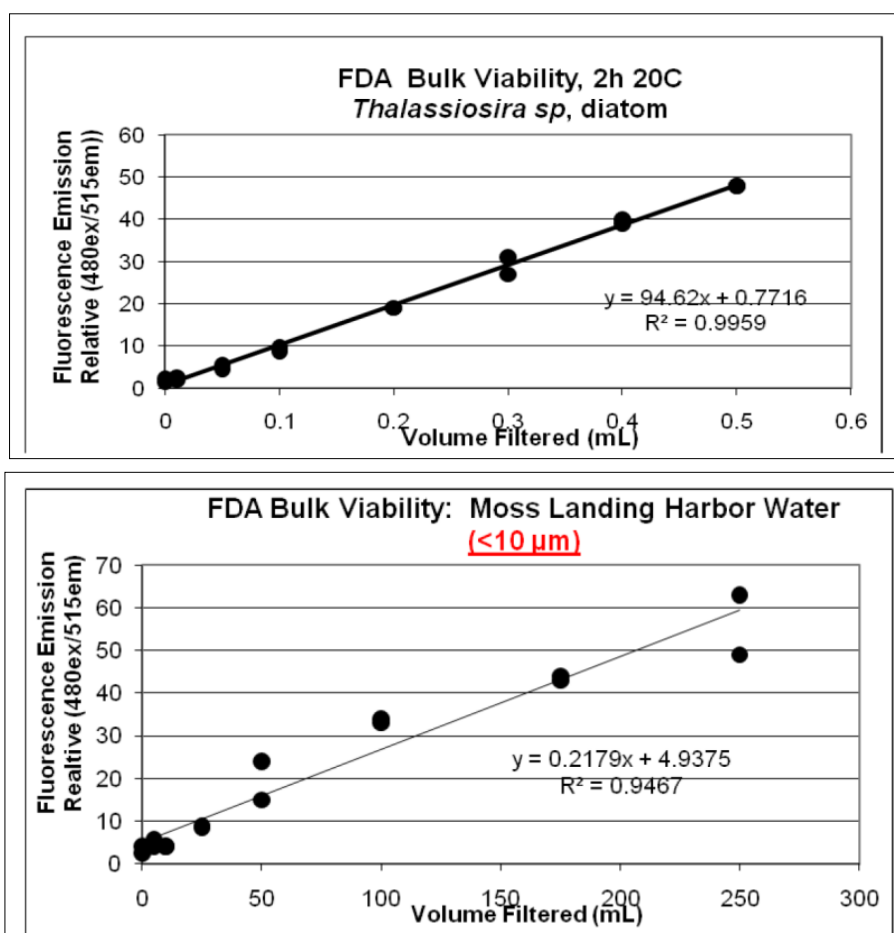
As seen in Figure 2, the resultant extracellular fluid fluorescence rose linearly over the time course of the experiment. The results suggested that a predictable analytical production rate of fluorescein was evident in each experiment (e.g., the live cells exhibit a constant rate of fluorescein production), and at the FDA final concentrations used here (10  $\mu$ M), the extracellular fluid fluorescence could be predicted over the course of at least one hour in this experiment and over two hours in corroborative experiments.



**Figure 2.** Time series of FDA derived fluorescence measured intracellularly (w/ flow cytometry) and extracellularly (w/ conventional cuvet fluorometry) with living suspensions of the diatom, *Thalassiosira* sp. Note that the fluorescence response of both instruments are not directly comparable (relative units).

### FDA-derived fluorescence as a function of 'live' biomass

Experiments were conducted to test the fluorescence response of cell suspensions to relative biomass loading, under conditions of constant incubation conditions (e.g., identical temperature, FDA concentration and incubation time). The biomass levels were controlled by quantitative volumetric filtration of sample suspensions (cultures or natural seawater) onto filters of appropriate pore size. As shown in Figure 3, under equivalent FDA substrate concentrations, the production of fluorescein was proportional to loaded biomass. Figure 3 shows experimental results for laboratory algal cultures and natural samples from Moss Landing Harbor, CA which were size-fractionated into the <10 µm and 10-50 µm size classes. A linear relationship between fluorescein production and viable biomass was clearly evident; the FDA response of natural plankton communities could be assessed with filtration of as little as 100 mL. The biomass-dependent yield of FDA-derived fluorescence has been observed for all experiments to date and constitutes the fundamental quantitative premise of the analytical method described here.



**Figure 3. FDA-derived fluorescence as a function biomass. Relative biomass loading was controlled by quantitative volumetric filtration on appropriate pore size filters; <10µm fractions captured on GF/F filters, nylon 10 and 50µm filters were cut from sheets of Nitex screen.**

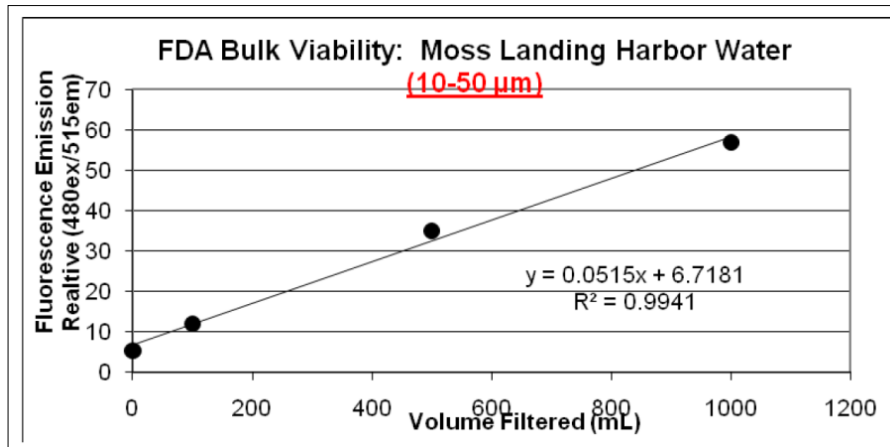


Figure 3 cont.

### FDA response in live and dead organisms

Side-by-side samples of live and dead organisms, killed by a variety of methods commonly utilized in ballast water treatment technology, but reduced to bench-scale operation, were analyzed using the bulk FDA incubation technique. In each case, the original sample of algal culture was split into two aliquots; the *untreated* sample was measured for 'live' FDA response, the remaining *treated* sample was subjected to the kill-process and analyzed within one hour of the treatment (i.e. a nominal 24 hour hold time, as in ballast treatment protocol, was not utilized). The results in Fig. 4 show that all kill factors produced significant depressions in FDA response relative to the corresponding live aliquot, at times by as much as 2 orders of magnitude (Fig. 4).

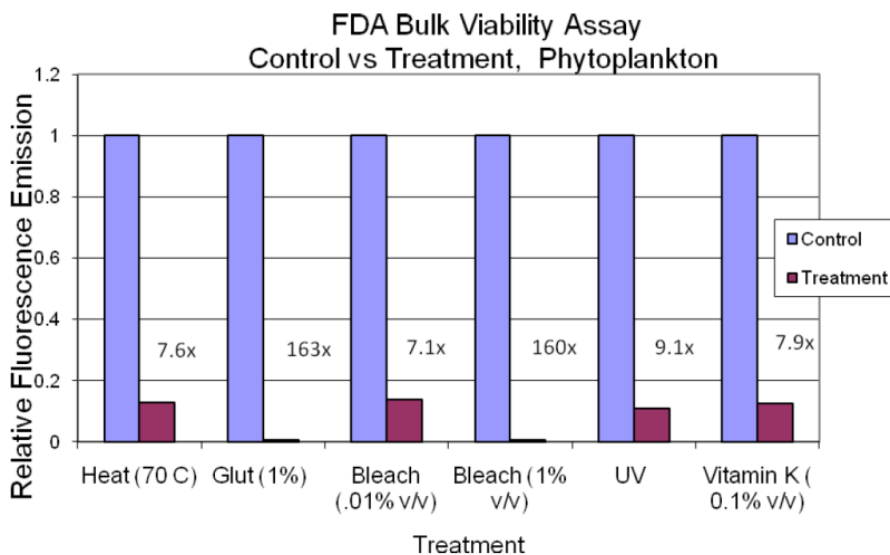
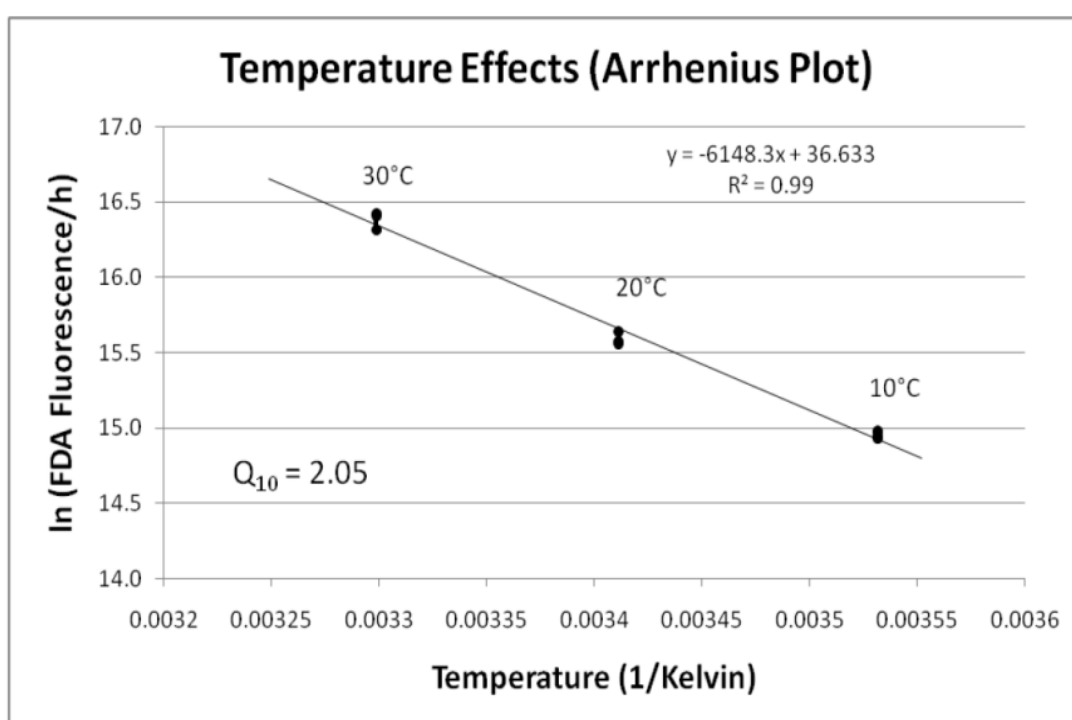


Figure 4. FDA bulk viability response in live phytoplankton relative to 'killed' treatment samples. Method of kill is listed for each sample pair; untreated ('live') sample responses were normalized to 1.0 for comparison. The Ratio of live fluorescence to dead fluorescence is noted for each logical pair of samples.

### Temperature effects on FDA response

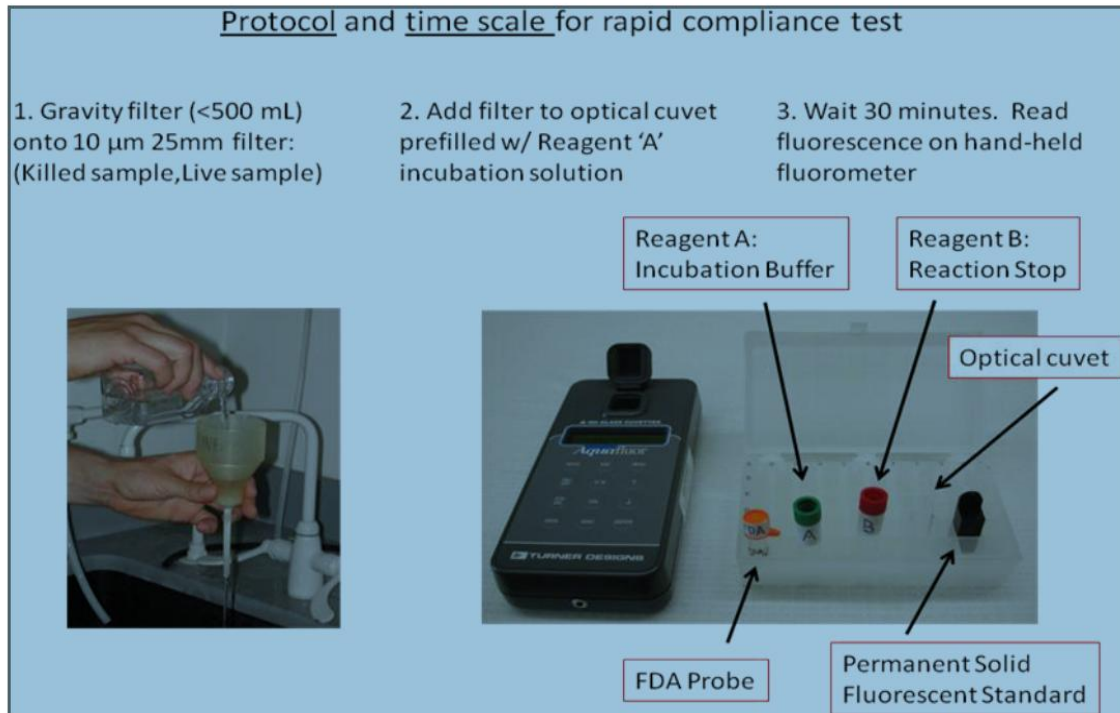
The enzymatic hydrolysis of FDA to fluorescein is expected to be temperature dependent due to the catalytic enzyme activity of the living biological systems that are being tested. The temperature effect was quantified using three temperature controlled water baths set at 10, 20 and 30°C. The incubators were used to incubate replicate aliquots of the prasinophyte, *Tetraselmis* sp.; aliquots were identical in volume and derived from the same culture, originally grown at 20°C. Figure 5 shows the resulting linear Arrhenius plot with a calculated Q<sub>10</sub> of 2.05 (e.g., a 10°C increase in temperature yields a two-fold increase in fluorescence signal, all other factors held constant).



**Figure 5. Standard Arrhenius plot (inverse temperature (Kelvin) vs. natural logarithm of reaction response) showing expected temperature-dependent linearity with a Q<sub>10</sub> of 2.05.**

### Simplified, rapid execution of the bulk FDA viability assay

Our overall objective was to develop a rapid, portable, and sensitive viability assay for quantitative ballast water testing. Given the results summarized above, we combined a series of steps, summarized in Figures 6 and 7, to yield an example protocol that stresses experimental simplicity for use onboard ship. For instance, Figure 6 shows the convenient preparation of samples when only the 10-50 µm size class is tested. In this case, small sample volumes (<500 mL) can be pre-screened through 50 µm mesh and gravity-filtered



**Figure 6. Example operation of FDA bulk viability assay for 10-50  $\mu$ m organisms (see text).**

onto a 10  $\mu$ m final filter (eliminating the need for vacuum filtration). The nylon 10  $\mu$ m filter yields minimum seawater retention (a cause of high blanks) and produces a final cuvet solution with no filter pulp (e.g., optical clarity); filtration/centrifugation is not required for clean fluorescence readings. Figure 7 shows the use of hypochlorite as a logical 'killed blank'. We found that a 15 minute exposure of sample water to 60ppm hypochlorite produces a killed sample that captures all the appropriate features of an analytical blank; that is, the killed *blank* cuvet contains the organisms, sample filter, incubation reagent, and FDA, thus, mimicking the *sample* cuvet exactly. Figure 7 shows that with a high-sensitivity fluorometer, a 100 mL sample, after 15 minutes of incubation produces a signal/blank reading of approximately 30. Thus, as an example of a possible rapid test strategy, a treated ballast water sample might be judged to be in 'gross exceedance' of regulations on the basis of its signal relative to a killed blank.

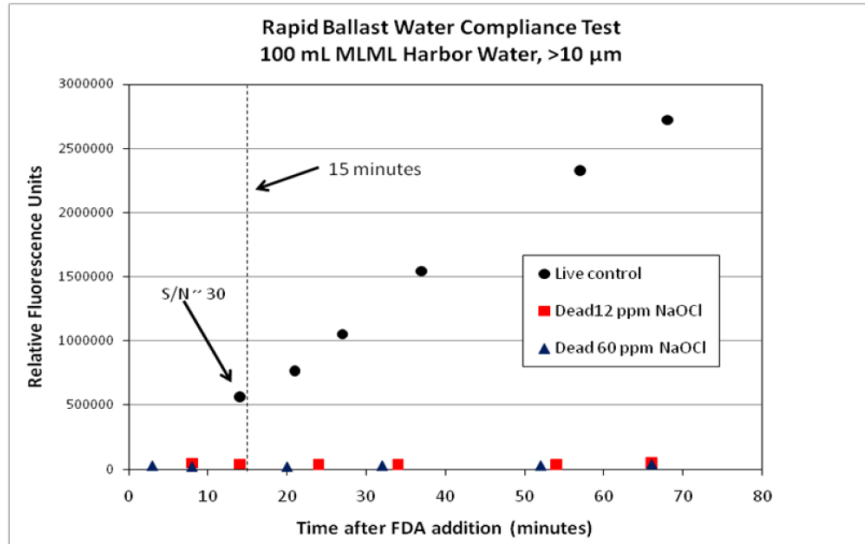
### **From rapid compliance assay to full-scale treatment testing**

The results presented above have focused on rapid, simple compliance testing. It should be clear, however, that with appropriate choices in filters, sample volumes and FDA incubation conditions, the rapid method can be expanded into a full scale test. Figure 8 shows results recently acquired on T/S Golden Bear (Golden Bear Facility, Calif. (GBF)) while completing

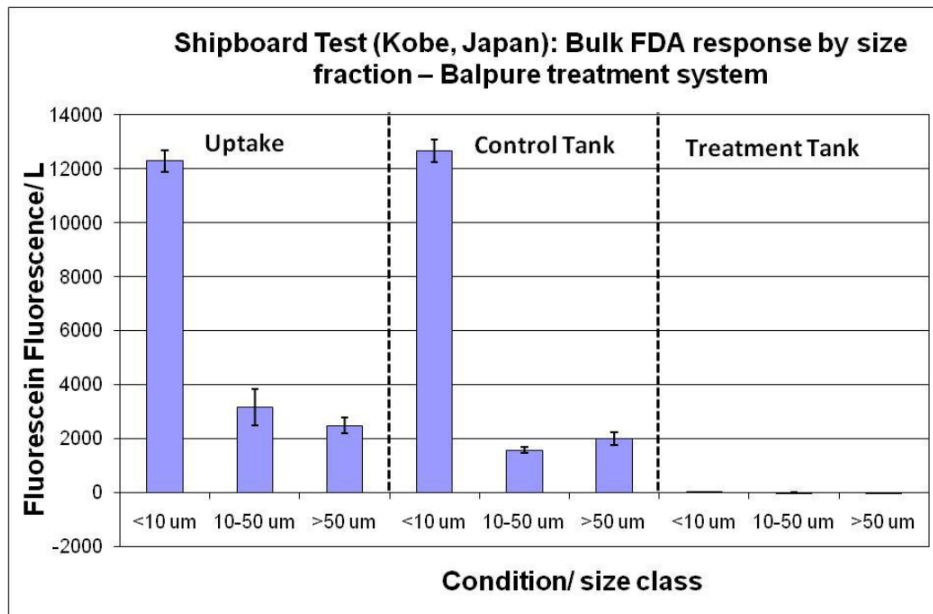
A PORTABLE, SENSITIVE PLANKTON VIABILITY ASSAY

full-scale, shipboard testing of the Balpure electrochlorination/filtration treatment system (now Type Approved) in Kobe, Japan.

Protocol and time scale for rapid compliance test



**Figure 7. Rapid FDA bulk viability assay comparing ‘live’ harbor water to complementary blank samples killed with reagent grade hypochlorite. Signal to noise is evaluated as signal/blank based on observed fluorescence (see text). A successfully-treated ballast water sample of equivalent volume would be expected to produce a signal at, or near, the killed blank level; the resultant S/N could be used as an indicator of gross exceedance relative to ballast performance standards.**



**Figure 8. The rapid FDA bulk viability assay applied to all regulated organism size classes during full-scale, shipboard ballast treatment testing in Kobe, Japan, aboard T/S Golden Bear (see text).**



Samples were collected in integrated, continuous fashion during all three ballasting cycles (uptake, control and treatment); each cycle yielded triplicate integrated samples collected over a two hour period. Samples were size fractionated appropriately, again in triplicate, processed with FDA and incubated for two hours at room temperature. The fluorescence responses were normalized to the volume filtered and plotted as a function of regulatory size fractions (<10, 10-50 and >50  $\mu\text{m}$ ) for each of the ballast cycles (Figure 8). Note, not surprisingly, that the largest viable biomass levels are contained in the microbial size fraction <10  $\mu\text{m}$ . Most importantly, the FDA bulk viability assay demonstrated that all regulated size classes showed remarkable inactivation/removal by the ballast water treatment system (treatment data are plotted in the figure, though the responses were so low that they are hidden within the x-axis). This finding was corroborated by all the labor-intensive, numeric counting procedures required for successful full-scale IMO testing, made at the same time. Thus, the entire suite of regulated organisms was tested using a single methodology, the bulk FDA assay; the full exercise (filtration, incubation and instrument measurement) could be completed in three hours.

## 5 Discussion

A rapid, bulk viability assay, based on FDA, is introduced here. The method utilizes concepts outlined in the original cell-specific application of FDA as a viability tag; but here, the 'leaky' nature of FDA is exploited to yield a simple, cuvet-based fluorescence assay that produces a signal that is directly proportional to living biomass. Thus, tedious numerical counting is eliminated. Side-by-side comparisons (data not shown) showed the FDA response to be comparable in sensitivity to ATP analyses (boiling Tris extraction; Karl, 1993); the FDA method, however, is significantly simpler. The magnitude of the FDA fluorescent signal can be controlled by: 1) volume filtered, 2) incubation temperature, and 3) incubation time. The nature of the sample can also be controlled by choice of filter pore size. For the purpose of speed and simplicity, we focused on the 10-50  $\mu\text{m}$  size class. Organisms in this size class can be measured with adequate sensitivity using conveniently small volumes (<500 mL); furthermore, because the pore size of the capture filter (10  $\mu\text{m}$ ) is relatively coarse, sample processing procedures are streamlined, analysis time is reduced, optical interference is minimized and instrumentation is minimal. The resulting portable method can easily be executed onboard ship with relatively little technical training and no formal laboratory provisions.

The purpose of this paper was to introduce the bulk FDA viability assay as a promising, indirect measurement for ballast water compliance testing. A discussion of the quantitative, analytical aspect of the bulk FDA measurement per se, and its exact relation to specific ballast regulations is beyond the scope of this paper. Briefly, however, it is clear that this new rapid method, based on viable *biomass* response, will need correlations to regulatory

## A PORTABLE, SENSITIVE PLANKTON VIABILITY ASSAY

*numerical* limits (e.g., IMO D-2; USCG P-1). That work is underway now with empirical confirmation of fluorescein mass production rates (traceable to NIST standards) and their expected relations to lab-reared organisms of known cell size (Coulter-measured equivalent spherical diameter). A relation of fluorescein produced per biovolume living organism, under standard incubation conditions, will allow us to estimate the equivalent numeric density of living cells of any size, given a simple measurement of FDA-derived fluorescein production. This will set the appropriate scales and error limits for rational ballast water compliance testing relative to extant ballast water performance standards. The convenience and sensitivity of the FDA bulk viability measurement may raise the question of whether current numeric standards are logistically the most appropriate regulatory metric for ballast water management.

## REFERENCES

*Rotman, B., and B. W. Papermaster* (1966), Membrane properties of living mammalian cells as studied by enzymatic hydrolysis of fluorogenic esters. *Proc. Nat. Acad. Sci.* 55: 134-141.

*Breeuwer, P., J. L. Drocourt, N. Bunschoten, M. H. Zwietering, F. M. Rombouts and T. Abee* (1995). Characterization of uptake and hydrolysis of fluorescein diacetate and carboxyfluorescein diacetate by intracellular esterases in *Saccharomyces cerevisiae*, which result in accumulation of fluorescent product. *Appl. Environ. Microbiol.* 61: 1614-1619.

*Brussaard, C.P.D., D. Marie, R. Thyrhaug and G. Bratbak* (2001), Flow cytometric analysis of phytoplankton viability following viral infection. *Aquatic Microbial Ecology* 26:157-166.

*Clarke, J.M., M.R. Gillings, N. Altavilla and A.J. Beattie* (2001), Potential problems with fluorescein diacetate assays of cell viability when testing natural products for antimicrobial activity. *J. Microbiological Methods* 46:261-267. 15.

*Dobroski, N., C. Scianni, D. Gehringer and M. Falkner* (2009), Assessment of the efficacy, availability and environmental impacts of ballast water treatment systems for use in California waters. Prepared for the California State Legislature, California State Lands Commission, 173p.

*Dorsey, J., C. M. Yentsch, S. Mayo and C. McKenna* (1989), Rapid analytical technique for the assessment of cell metabolic activity in marine microalgae. *Cytometry.* 10: 622-628.

*Garvey, M., B. Moriceau and U., Passow* (2007), Applicability of the FDA assay to determine the viability of marine phytoplankton under different environmental conditions. *Mar. Ecol. Prog. Ser.* 352: 17-26.

*Karl, D. M.* (1993), Total microbial biomass estimation derived from the measurement of particulate adenosine-5'-triphosphate. In P. F. Kemp, B. F. Sherr, E. B. Sherr and J. J. Cole (Eds.), *Current methods in aquatic microbial ecology*, pp. 359-368. Lewis Publishers, Boca Raton, Florida.

## (Finalized) Methodology for Risk Assessment of Active Substances under Procedure (G9)

Jan Linders<sup>1</sup>

---

### **Abstract**

*After some years of experience and the more recent knowledge on the submission of Ballast Water Management Systems (BWMS), the GESAMP-Ballast Water Working Group (GESAMP-BWWG) has further developed its methodology to evaluate the BWMS to avoid unreasonable risks for the environment, human health and for the ships' safety. The latest proposals on the methodology have been established in so-called stock-taking workshops. These proposals will be sent to the joint Group of Experts on the Scientific Aspects of Marine Protection (GESAMP) and to the Marine Environmental Protection Committee for adoption at their next meetings. After its adoption, the methodology will be used in the evaluation process of BWMS in the future. The methodology is considered to be a living document that will be updated if necessary and will be based on developments of the submission of BWMS within the framework of the Ballast Water Management Convention. Models have been developed for the estimation of the Predicted Environmental Concentrations (PEC) in the marine environment. The model is called MAMPEC-BW 3.0 and is especially developed for ballast water, although originally crafted for antifouling products. The new model will be used for the estimation of potential effects on humans and the environment. This paper deals with the final proposals in the development of the methodology and will focus on risk assessment. The purpose is the protection of the world's oceans and coastal areas from bio-invasion ensuring, at the same time, that ballast water management practices used to comply with the Convention do not cause greater harm than they prevent.*

---

### **1 Introduction**

In 2004, the Ballast Water Management Convention (BWMC) was adopted, which would oblige ships to treat their ballast water preventing the discharge of ballast water containing harmful organisms that could cause bio-invasion in the area of discharge. Treatment of ballast water can be carried out using certain chemicals. Therefore, a guideline (G9) became part of the BWMC regulating that the discharge of treated ballast water using chemicals should occur without any harmful effects to the ship, its crew, humans and the environment.

---

<sup>1</sup> Chairman of GESAMP-BWWG, P. Pieckweg 8, NL-3828 PR Hoogland, The Netherlands  
Tel. +31334554567, e-mail Jan@familielinders.nl

To provide advice on the effects of ballast water management systems (BWMS) using active substances, with respect to these subjects at risk, a technical group (the GESAMP-BWWG) was established. After about five years of experience, this working group has further developed its methodology on the conduct of work to prepare advice to the Marine Environmental Protection Committee (MEPC), taking into account the knowledge gained evaluating approximately 60 BWMS. The proposed methodology addressed in this document focuses on the exposure of aquatic organisms.

## **2 Evaluation of BWMS**

The GESAMP-BWWG evaluates the BWMS with respect to several topics: 1) the risk of discharge of ballast water to the receiving environment (aquatic organisms); 2) the risk to the people that work with ballast water management systems because of their profession (crew and port state control); 3) the risk to the public at large that may recreate in waters or eat contaminated seafood harvested where ships discharge ballast water; and 4) risks to the ship itself (e.g., corrosion).

The process of risk assessment for chemicals is well developed. As many countries have to make decisions about the registration of chemicals intended for the control of harmful pests and diseases (e.g., pesticides and biocides), and also as they must make decisions about putting industrial chemicals on the market, the risk assessment management tool is used. The basic principles of this process are also adopted by the GESAMP-BWWG to evaluate the risks of discharge ballast water. The applicant provides a dossier to the regulating authorities, in this case, to IMO and MEPC, containing information on the substance and its use, including data on the identity (physic-chemical properties), the fate and behavior (sorption and degradation) and potential toxic effects (human toxicology and ecotoxicology). First, the data are evaluated with respect to quality and whether the data are generated using generally accepted methods (e.g., OECD-guidelines). Only scientifically justified data are accepted for further use in the risk assessment. Some data are used for the estimation of potential concentrations in the environment — the environmental exposure assessment. The final result of this evaluation is the predicted environmental concentrations (PEC). Often, use is made of mathematical models to describe the behavior of the substance in the environment based on typical information such as the octanol / water partition coefficient, the sorption capacity to soil or sediment and the abiotic or biotic degradation potential of the substance (e.g., half-life in water or soil). In the hazard assessment, the effect data are used for the estimation of safe levels of the substance in the environment or for humans. The (eco)toxicity data include acute and chronic endpoints. Using safety factors, to account for required safety and uncertainty in the data, a safe level is estimated resulting in a predicted no-effect concentration (PNEC) for the environment or a derived no-effect level (DNEL) for human

exposure. Finally, the results of the exposure assessment and the hazard assessment are compared to each other using a risk characterization ratio (RCR). The value of the CRC defines whether or not a potential risk may be expected for the topic under consideration. In the case that risk cannot be excluded, a further in-depth assessment may be needed.

### **3 Risk Assessment Tools for BWMS**

In order to perform the approach outlined in Section 2, the GESAMP-BWWG has developed a methodology on the conduct of work. The proposed methodology has been forwarded to MEPC for comments, suggestions and adoption. The focus of the new methodology has been on: 1) the development of a database for the most commonly occurring disinfection byproducts (DBP) generated during the BWMS operation, 2) the model development and scenario description to calculate the PEC in a standardized harbor environment, and 3) the definition and analysis of the unit operations for crew and port state control in the handling of BWMS.

#### **3.1 Database**

Especially if electrolysis of seawater is the main disinfection process, which is the case in the majority of the BWMS currently evaluated, a huge number of DBP may be formed, of which trihalomethanes (THM) and haloacetic acids (HAA) are the most important. A list of 18 DBP have been prepared, that contain those occurring most frequently and in the highest concentrations. The physico-chemical properties and the fate and effect data have been incorporated in the database for further use in the risk assessment.

The database serves two primary goals: 1) to ensure that for all substances included in the database, the same physico-chemical data and effect data are used in the risk assessment for these substances independent of the BWMS in which they occur (providing consistency between the substances and systems evaluated); and 2) the main DBP currently identified in BWMS happen to be quite well-known rather simple organic compounds. For many of them, risk assessments have been carried out by other institutions, including those in the USA and EU, but also by non-governmental gremia like WHO. Therefore, the GESAMP-BWWG and IMO face the submission of data in manifold as each applicant will provide the data available in public literature on, for instance, the substance bromoform. Once a substance has been included in the database, no publicly available data will no longer need to be submitted with the dossier for Basic and Final Approval.

The currently proposed list of DBP contains the substances as indicated in Table 1.

The waiving of data is restricted to information on these substances that may be found in scientific literature and in risk assessment documents carried out by national or international

## LINDERS

bodies that generally also have carried out an evaluation of the quality of the data based on established criteria like standard test guidelines (OECD), GLP, etc. It should be recognized that data required for the functioning of the BWMS, like the whole effluent toxicity (WET) test and the chemical analysis of treated ballast water, can never be waived and are exempted from this waiving process.

**Table 1. DBP in database.**

#	Substance	#	Substance
1	sodium bromate	10	dibromoacetic acid
2	potassium bromate	11	tribromoacetic acid
3	Bromoform	12	monochloroacetic acid
4	Chloroform	13	dichloroacetic acid
5	dibromochloromethane	14	trichloroacetic acid
6	dichlorobromomethane	15	bromochloroacetic acid
7	sodium hypochlorite	16	monochloroamine
8	sodium thiosulphate	17	trichloropropane
9	monobromoacetic acid	18	dibromoacetone

### 3.2 MAMPEC

As the model to be used for the calculation of the PEC, the GESAMP-BWWG adopted the MAMPEC-model as the most suitable model currently available. In the model, a specific scenario has been defined describing the harbor environment and an emission scenario for the discharge of ballast water. In the harbor scenario, the most relevant parameters are defined as pH, temperature, particulate organic matter, dimensions of the port and exchange volume with the surroundings. The harbor scenario is given in Table 2, where the relevant parameters that define the harbor are presented, including the exchange volume with the shipping lane or the open sea.

The emission scenario defines the amount of ballast water discharged each day. A value of  $E+5 \text{ m}^3/\text{d}$  was chosen as a representative worst case discharge of ballast water in the recipient environment. The multiplication of the discharged ballast water and the measured concentration of a substance in the discharged ballast water, as given in the dossier of the applicant, yields the total load of the substance in the recipient harbor.

The result of the MAMPEC calculation is the yearly average and median concentration of the substance under consideration, its maximum, minimum and its 95<sup>th</sup>-percentile. As a worst-case situation, the maximum value is currently used for the evaluation. The MAMPEC-BW, version 3.0, has been specifically developed for the GESAMP-BWWG. For the human exposure scenario, the MAMPEC results may be used as well for the estimation of the exposure to the general public.

**Table 2. Standard harbor scenario**

Parameter	Value	Unit	Parameter	Value	Unit
Tidal period	12.41	m <sup>3</sup>	Width y1	1000	m
Tidal difference	1.5	m	Width y2	500	m
Tidal density difference	0.4	kg m <sup>-3</sup>	Depth	15	m
Water level change	0	m	Mouth width x3	1000	m
Flow velocity	1	m s <sup>-1</sup>	Latitude	50	NH
SPM concentration	35	mg L <sup>-1</sup>	Depth mixed sediment layer	0.2	m
POC concentration	1	mg L <sup>-1</sup>	Sediment density	1000	kg m <sup>-3</sup>
DOC concentration	2	mg L <sup>-1</sup>	Degradation rate o.m.	0	d <sup>-1</sup>
Chlorophyll	3	µg L <sup>-1</sup>	Net sedimentation velocity	1	m d <sup>-1</sup>
Salinity	34	psu	Fraction o.m. in sediment	2.852E2	-
Temperature	15	°C	Depth in harbor entrance	15	m
pH	8	-	Exchange area harbor mouth	15000	m <sup>2</sup>
Length x1	5000	m	Tidal exchange	2.432E7	m <sup>3</sup>
Length x2	5000	m	Tidal exchange	32.43	%

### 3.4 The Near Sea Scenario

The Group considered that also, for the area around the ship where the actual discharge takes place, a situation of higher risk may occur. Therefore, a near sea scenario has been defined, as well, taking an additional dilution factor of 5 into account for the short-term exposure of aquatic species. The following equation gives the calculation of the exposure concentration for aquatic organisms and general public in the near sea situation:

$$C_{max} = \frac{C_{bw} + (S - 1)C_{mean}}{S}$$



## LINDERS

where:

- C<sub>max</sub> = the maximum concentration due to near sea exposure (µg/L)
- C<sub>bw</sub> = the concentration in the ballast water (µg/L)
- S = dilution factor, the proposed default value is 5
- C<sub>mean</sub> = the calculated mean concentration with MAMPEC (µg/L)

The general public may be exposed by oral intake, dermal uptake and inhalation of discharged ballast water during swimming in contaminated areas, and additionally, oral exposure takes place during consumption of fish caught in these contaminated areas.

### 3.5 Assessment Factors

Whilst in the area of exposure, a Predicted Environmental Concentration (PEC) is needed to perform the risk assessment, and a Predicted No-Effect Concentration (PNEC) is needed in the area of effects of substances in the environment. The derived PNEC-value is defined as the concentration to which an ecosystem may be exposed without negative effects to the populations of organisms in the ecosystem. To establish a meaningful PNEC that is comparable with the PEC, it should be derived based on sound scientific principles. Several methods have been described in the scientific literature, and the method adopted by GESAMP-BWWG has been based on the principles used by USEPA and EU in their risk assessment reports. Based on the amount and quality of the data of a specific substance, an overall assessment factor is assigned.

The value of the assessment factor depends on the type of effect, acute or chronic. For environmental effects, no effects on the individual organism are considered, only the potential effects on the population are considered relevant. In the case of DBP and the evaluation of BWMS, the Group decided that the relevance of sediment toxicity was not significant, as all DBP considered have a low lipophilicity and, therefore, do not adsorb to the sediment.

Toxicity for sediment organisms was considered unlikely. If the Group came across substances with high lipophilicity also, a risk assessment would be needed, and standard assessment techniques should be used. Normally, for a hazard evaluation for aquatic organisms, a set of three toxicity tests would be required for algae, crustaceans and fish, both for acute and chronic toxicity. Even for the well-known DBP, a complete set of toxicity data is often not available. To arrive at a PNEC based on a complete or incomplete data set, the table of assessment factors is used as given in table 3.

**Table 3. Assessment factors.**

Data set	Assessment factor	
	PNEC general	PNEC near sea
Lowest short-term L(E)C50 from freshwater or marine species representing one or two trophic levels	10,000	1,000
Lowest short-term L(E)C50 from three freshwater or marine species representing three trophic levels	1,000	100
Lowest short-term L(E)C50 from three freshwater or marine species representing three trophic levels + at least two short-term L(E)C50 from additional marine taxonomic groups	100	10
Lowest chronic NOEC from one freshwater or marine species representing one trophic level, but not including micro-algae	100	-
Lowest chronic NOEC from two freshwater or marine species representing two trophic levels, which may include micro-algae	50	-
Lowest chronic NOEC from three freshwater or marine species representing three trophic levels, which may include micro-algae	10	-

### 3.6 Human Exposure Scenario

For the estimation of the risk to the crew and port state control, MAMPEC is not suitable, as exposure may take place during handling of the chemicals used in the BWMS or during operation of the BWMS. The possibilities of exposure are defined in the unit operations involved in the BWMS. These unit operations have to be defined for each individual BWMS, as the specific circumstances may change from one system to another. The number of exposure events and the amount occurring have been estimated for a worst-case and a realistic case. As an example for human exposure, sampling of ballast water tanks may result in dermal and inhalation exposure at a frequency of 2 hours per day and 5 days per week for acute exposure, and an additional assumption of 45 weeks per year would represent chronic exposure.

## 4 Conclusions

The methodology of GESAMP-BWWG has been further developed during a series of three stock-taking workshops, to which additional experts have been invited on specific topics like the model development and the human exposure scenario development. The Group considered the current methodology quite complete and more or less in place. Therefore, the time has arrived to request parties' suggestions and criticism on the proposals. The methodology should be considered a living document to which new information may be added or items changed if scientific developments indicate the need. In addition, the methodology has to be tested in practice. Changes have been performed taking into account current experience and knowledge, which is based on the major use of disinfection by electrolysis of seawater and the production of DBP. If other substances are proposed as active substances, changes or other concepts must be developed and used to perform an acceptable risk assessment for those cases. Nevertheless, the main principles of risk assessment, exposure assessment, hazard assessment and risk characterization will be kept as the basic keystones.

Potential areas for further development of the methodology may include the evaluation of key model parameters, like the tidal exchange volume of water in the harbor; the temperature in the harbor in relation to the temperature at which degradation of the substance has been determined; and a correction factor that may be needed to account for temperature differences. An important area of research could be the necessity for a second or higher tier assessment in the event that the worst-case scenario leads to unacceptable risk. Also the occurrence of many other possible DBP should be further assessed. Literature sources have shown that over 600 different substances have been analyzed in all kinds of disinfection processes. It remains to be seen whether applicants have to search more thoroughly for more DBP. Finally, the potential exposure to substances showing carcinogenicity, mutagenicity and reproductive toxicity (so-called CMR-substances) should be further analyzed as some of the DBP have such classifications.

To answer the questions posed in these potential areas of concern, stock-taking workshops will be held on a yearly basis, and successively, the group will discuss possible solutions with invited experts in the field. The final aim of controlling the world-wide spread of invasive aquatic species may require additional scientific input to gain more insight in the area of ballast water management and advance the protection of the world's oceans and coastal areas from bio-invasion, at the same time, ensuring that ballast water management practices used to comply with the Convention do not cause greater harm than they prevent.

## **Acknowledgment**

The author wishes to acknowledge the input of the GESAMP-BWWG and of all the invited experts who contributed to the current status of the methodology on the evaluation of the environmental and human risk assessment of ballast water discharges.



## Risk Assessment for Exemptions from Ballast Water Management – The Intra-Baltic HELCOM Study

Matej David<sup>1,2</sup>, Stephan Gollasch<sup>3</sup>, Erkki Leppäkoski<sup>4</sup>

---

### Abstract

*This study focuses on intra-Baltic shipping for exemptions from ballast water management requirements based on risk assessment (RA). As a basic framework, the HELCOM Guidance to distinguish between unacceptable high risk scenarios and acceptable low risk scenarios and the IMO G7 Guideline were used. RA methods were selected considering these documents. After studying shipping profiles in the Baltic Sea, possible RA applications were studied on four different routes. The current lack of information regarding alien and cryptogenic species, as well as human pathogens present in port areas of the ballast water donor and recipient points were found as most limiting factors to conduct a RA. This study may be of particular interest for regional seas, for example, the Black and Baltic Seas share some RA-relevant features, such as intensive shipping inside the area and different salinities throughout the sea.*

**Key Words:** maritime transport, ballast water management, exemptions, risk assessment

---

### Introduction

The *International Convention for the Management and Control of Ballast Water and Sediments* (BWM Convention) was adopted by the IMO in February 2004, to set global standards on ballast water management (BWM) requirements (Gollasch *et al.*, 2007). The BWM Convention introduces the selective BWM approach with Article 4.2, which allows to adapt BWM measures to local conditions based on risk assessment (RA). In light of exemptions from BWM requirements, these can be given on the basis of Regulation A-4 (IMO, 2004). Clearly, to enable a port state to introduce such a selective approach, an appropriate RA is essential and necessary. Globally agreed procedures for granting exemptions are described in the *IMO Guidelines for Risk Assessment under Regulation A-4 of the BWM Convention* (IMO G7 Guideline) (IMO MEPC, 2007).

---

<sup>1</sup> University of Ljubljana, Faculty of Maritime Studies and Transport, Pot pomorščakov 4, SI-6320 Portorož, Slovenia

<sup>2</sup> corresponding author, e-mail address: matej.david@fpp.uni-lj.si

<sup>3</sup> GoConsult, Grosse Brunnenstr. 61, DE-22763 Hamburg, Germany

<sup>4</sup> Åbo Akademi University, Environmental and Marine Biology, FI-20520 Turku, Finland

HELCOM went further and prepared and adopted a Baltic Sea specific guidance for RA-based exemptions, the *Guidance to distinguish between unacceptable high risk scenarios and acceptable low risk scenarios – a risk of spreading of alien species by ships on Intra-Baltic voyages* (HELCOM RA Guidance 2010). This study focussed on testing the possible application of the HELCOM RA Guidance for intra-Baltic shipping (the Kattegat included), considering also the IMO G7 Guideline. In general, environmental issues in shipping should be dealt with at a global scale, however the implementation may occur through regional agreements to consider local specifics (David and Gollasch, 2008).

### **Risk Assessment Methods for Exemptions from BWM**

The IMO G7 Guideline specifies three basic RA methods, “environmental matching”, “species-specific” and “species biogeographical”. The risk estimation on the assessment of environmental matching between the areas of ballast water origin and discharge considers salinity and temperature as surrogates for the assessment of the species’ capability of survival in the new environment. Species’ biogeographical risk assessment identifies overlapping species in the donor and recipient ports and biogeographical regions, and these are direct indications of the similarity of environmental conditions. The risk identification in the species-specific approach is focused on the assessment of the potential invasiveness of each species and anticipations of the harm that it could cause in the new environment.

The risk assessment based upon an **environmental match** was found applicable considering water salinity as key feature in this approach. Temperature was also considered as a risk assessment quantifying factor in the environmental match approach, but it was agreed that this is of lesser reliability to identify low risk scenarios. The salinity is believed to be a relatively solid indicator for species compatibility and survival in a new environment, and on the other hand, this information is easily available for ballast water source and discharge areas. Acceptable risk is assessed should the salinity between ballast water donor and recipient ports be freshwater (< 0.5 PSU) to marine (> 30 PSU). Such a salinity difference does not occur for intra-Baltic shipping, and therefore, this environmental match approach alone cannot be applied as a RA concept. A new approach (*i.e.* the combination of environmental match with species-specific considerations) was developed.

In terms of the application of the **species-specific** approach, the target species approach was selected. Target species need to be selected out of all alien, cryptogenic and harmful native species present in the Baltic Sea area. Selection criteria to be used are set in the IMO G7 Guideline.

Further, should both the ballast water donor and recipient regions have the same target species, but occurring in much different **abundance**, a low risk indication needs to be

## RISK ASSESSMENT FOR EXEMPTIONS FROM BWM

evaluated on a case-by-case basis. Basically, it would not be acceptable to transfer unmanaged ballast water if a target species would occur in much higher abundance in any of the donor ports than in the recipient port.

Plants and animals, native as well as non-native, have the theoretical potential to **spread naturally** from a donor to a recipient port without being assisted by any man-related vectors. It was recognized that this is species-specific, and that the risk could be acceptable only if all target species of concern could easily and naturally spread from the donor to the recipient port.

It was also considered, that a coastal state may introduce a **control or eradication program** for certain most unwanted species in their waters. The further introduction of any such species to the ballast water recipient area would not be acceptable.

For the **combined environmental and species-specific approach**, it was agreed that it may be still acceptable when ballast water is moved between freshwater ports and brackish ports with salinities higher than 18 PSU, in which case, a species-specific approach would be also required especially considering the species that have known salinity tolerance higher than <0.5 PSU and >18 PSU. Should such species occur in only one of the considered donor ports, a low risk cannot be assumed.

The **species biogeographical** risk assessment was found not applicable as the ballast water movements considered here are not undertaken between different biogeographical regions. IMO Guideline G7 further states a species-specific risk assessment may be best suited to situations where the assessment can be conducted on a limited number of harmful species within a biogeographic region.

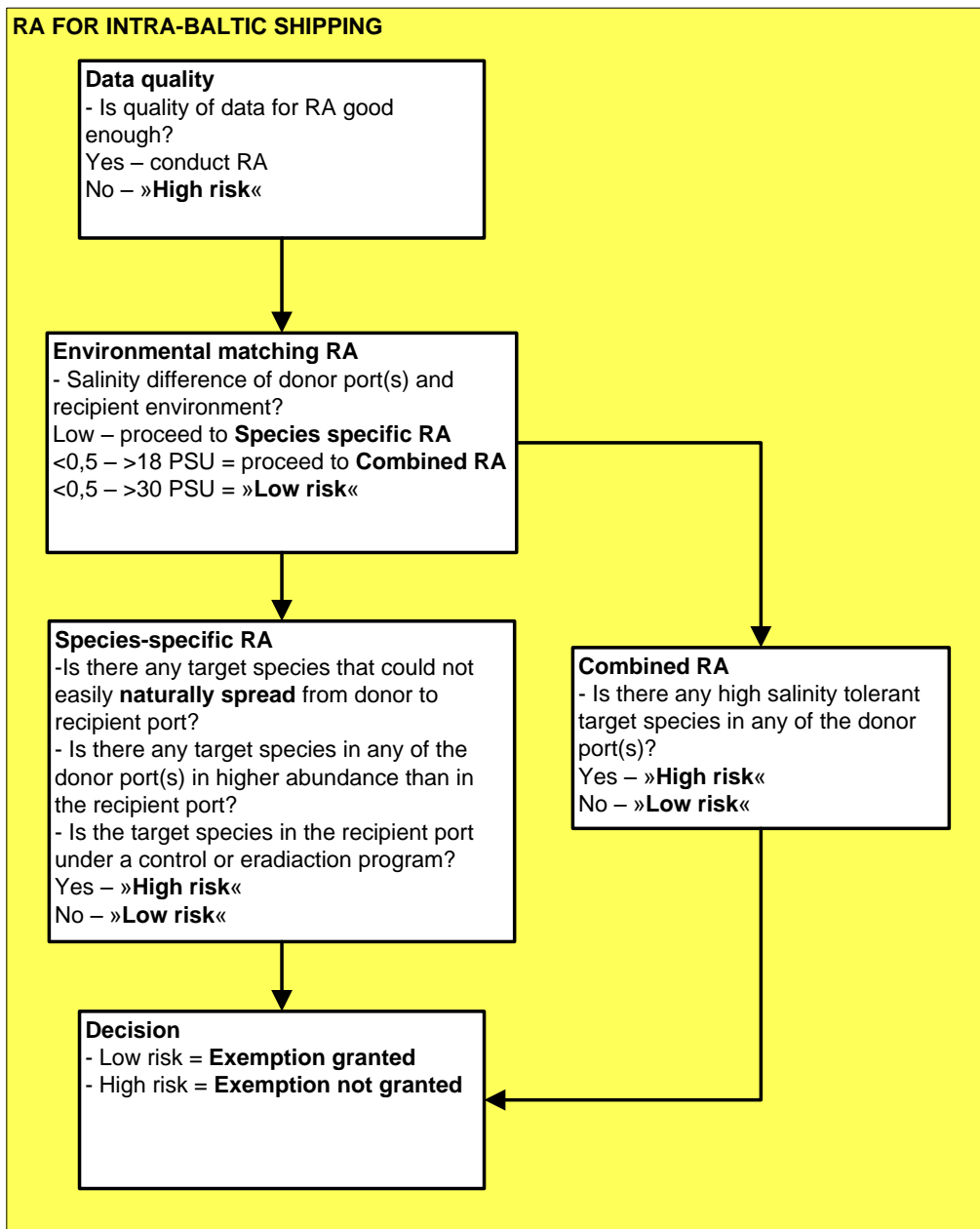
In terms of **vector factors**, the relevance of species survival during a voyage, ballast water discharge quantities and frequencies were considered. As all intra-Baltic **voyages are relatively short** (from hours to a couple of days), it was assumed that if one species is present in the ballast water donor port, it will survive the voyage and will be discharged viable with ballast water in the recipient port. The **quantity of ballast water discharge** is also one of the factors related to the level of risk.

However, considering that also a small number of harmful organisms present in the discharged ballast water may cause critical consequences, this RA considers unacceptable discharge of any quantity of ballast water, if it contains target species not yet present in the recipient port. More **frequent** ballast water discharges from one donor port may increase the



risk, however, one ballast water discharge may already be sufficient to introduce a species, hence is not acceptable.

The RA methods and principles for granting exemptions from BWM in intra-Baltic shipping are organised in a flowchart and presented in *Figure 1*.



*Figure 1. Risk assessment (RA) methods and principles for granting exemptions from ballast water management in intra-Baltic shipping.*

## RA APPLICATION TEST

Based on studying shipping profiles in the Baltic Sea, the following shipping routes were selected:

- St. Petersburg (RU) – Gothenburg (SE),
- Klaipeda (LT) – Kiel (DE), and
- Kiel (DE) – Gothenburg (SE).

The routes recognized show frequent shipping pattern and represent different distances and environmental conditions.

Another route was selected for risk assessment with one donor port outside the Baltic region:

- Terneuzen (NL) – Mönsterås (SE) – Karlshamn (SE).

When starting the target species selection process it became clear that essentially needed data (*i.e.*, on already introduced alien species in the Baltic Sea ports, cryptogenic species and harmful native species) are missing to undertake such an assessment. The most comprehensive data on alien species was recognised to be the HELCOM MONAS list (HELCOM 2009). Target species could still be identified from the data available, but having in mind also the precautionary approach it was recognised that vessels could not be exempted based on RA conducted on such limited data. Further, assessments of the possible natural spread and abundance comparison of target species, as well as the presence of human pathogens in the donor ports were not enabled due to the lack of data.

## Conclusions

RA for granting exemptions from BWM results in vessels continuing to operate on the assessed route without conducting any ballast water management effort. The RA is focused on the identification of acceptable or non-acceptable ballast water discharges from donor ports on a certain route. This makes it clear that for such RA, it is crucial to have reliable data about port and surrounding environments, in terms of biology, as well as salinity.

Nevertheless, the study resulted in an agreement on the methods and principles to be used in RA for exemptions in intra-Baltic shipping, which can be applied when reliable data become available. Data for such RA would need to be obtained with port baseline surveys and monitoring programmes using best available scientific knowledge and methods.

## Acknowledgements

The authors would like to express their grateful thanks to HELCOM for funding this study. The research has received co-funding from the European Community's Seventh Framework Programme (FP7/2007-2013) under Grant Agreement No. 266445 for the project Vectors of Change in Oceans and Seas Marine Life, Impact on Economic Sectors (VECTORS), where David and Gollasch participate.

## REREFENCES

*David M. and S., Gollasch (2008), EU shipping in the dawn of managing the ballast water issue. Mar. Pollut. Bull. 56, 1966-1972.*

*Gollasch S, David M, Voigt M, Dragsund E, Hewitt, C. and Y., Fukuyo (2007), Critical review of the IMO International Convention on the Management of Ships' Ballast Water and Sediments. Harmful Algae 6, 585-600.*

HELCOM (2009) Monitoring and assessment of alien species according to the international regulations. HELCOM MONAS 12/2009, Doc. 7/4, 26 pp.

HELCOM (2010) Guidance to distinguish between unacceptable high risk scenarios and acceptable low risk scenarios – a risk of spreading of alien species by ships on Intra-Baltic voyages ([www.helcom.fi/stc/files/shipping/HELCOM%20Guidance%20on%20risk%20voyages%20July%202010.pdf](http://www.helcom.fi/stc/files/shipping/HELCOM%20Guidance%20on%20risk%20voyages%20July%202010.pdf))

IMO (2004) International Convention for the Control and Management of Ships' Ballast Water and Sediments. International Maritime Organization, 36 pp.

IMO MEPC (2007) Guidelines for Risk Assessment under Regulation A-4 of the BWM Convention (G7). International Maritime Organization. Resolution MEPC.162(56), 16 pp.

## Ballast Water Management in Turkey – an overview

Murat Korçak<sup>1</sup>

---

### Abstract

*The Turkish coasts are one of the most vulnerable coasts because of the intensive maritime traffic. Currently, there are 23 million tons of ballast water discharged to Turkish coastal waters annually. Further, 66 different invasive species are carried by ships to Turkish coasts, of which 19 of them can be categorized as harmful organisms. In particular, three major alien and invasive species – namely *Mnemiopsis leidyi* from the North Atlantic, *Rapana venosa* from the Japan Sea, and *Beroe ovata* from the North Atlantic – were transferred to the Black Sea, where they collapsed the entire fish stock and caused significant economic loss to the region.*

*The Turkish Undersecretariat for Maritime Affairs initiated an in-depth study on 26 July 2006, entitled, "Project on Control and Management of Harmful Organisms Transferred by Ballast Water". The project was undertaken by the Scientific and Technological Research Council of Turkey (TUBITAK), Marmara Research Centre's (MRC's) Environment Institute (EI). The project also aimed to produce a synergy between these two public bodies to develop an operational ballast water management strategy and system in Turkey.*

*Within the framework of the project, an inventory of the shipping activities along Turkish coasts was developed in the form of a database system in order to quantify the amount of ballast water discharges in Turkish ports and to define the sources of the ballast water. An electronic reporting system was used for this purpose. All of the Turkish ports were subjected to a risk assessment process using the GloBallast Risk Assessment Method. Also, a Geographical Information System (GIS) and an invasive species database were produced during the project. All these activities also contributed towards Turkey's participation in the GloBallast project, in which Turkey is a Lead Partnering Country (LPC) for the Mediterranean region. Turkey has also hosted a number of regional meetings, such as "Training on Port Biological Baseline Survey" and "Workshop on Legal Implementation of the BWM Convention", as well as regional BWM strategy development meetings.*

*This paper contains the details of the Turkish national ballast water management project and also gives information of the national system of Turkey and future planned activities.*

---

---

<sup>1</sup> Undersecretariat for Maritime Affairs of TURKEY

## Introduction

The Turkish National Ballast Water Management Project is defined in two main sections. The first section was conducted between 2006-2008, and the second section was conducted between 2010-2011. The first section of the project (2006-2008) consists of 13 different work packages. These are:

1. Inventory Study;
  - a. Shipping traffic data for a 5-year period,
  - b. Ballast water discharge and uptake amounts,
  - c. Ballast water origins and transportation patterns,
  - d. Impacts of invasive species to Turkish Coasts,
  - e. Determination of sensitive coastline areas.
2. Trend Analysis;
  - a. Next 10 years' approximation for maritime traffic,
  - b. Next 10 years' approximation for ballast water discharge amounts.
3. Risk analysis;
  - a. Determination of the risks for Turkish ports with Globallast Risk Assessment Methodology,
  - b. Determination of the risks for Turkish ports with HELCOM Risk Assessment Methodology.
4. Establishment of Geographical Information System;
5. Defining the ballast water management models;
  - a. Ballast water exchange probabilities within Turkish Territorial Areas,
  - b. Defining the roles of the stakeholders on ballast water management,
  - c. Defining the ballast water management strategy for Turkey.
6. Reporting the pros and cons of signing the Ballast Water Management Convention;
7. Preparing the national draft legislations;
8. Defining the procedure on compliance and enforcement;
9. Defining the roles of public bodies, private sectors and NGO's on ballast water management;
10. Defining the relevant technical infrastructure and supply chains;
11. Preparing training material;
12. Preparing an invasive species database;
13. Establishing procedures for sediment reception facilities.

The second section of the project (2010-2011) consists of 5 different work plans. These are:

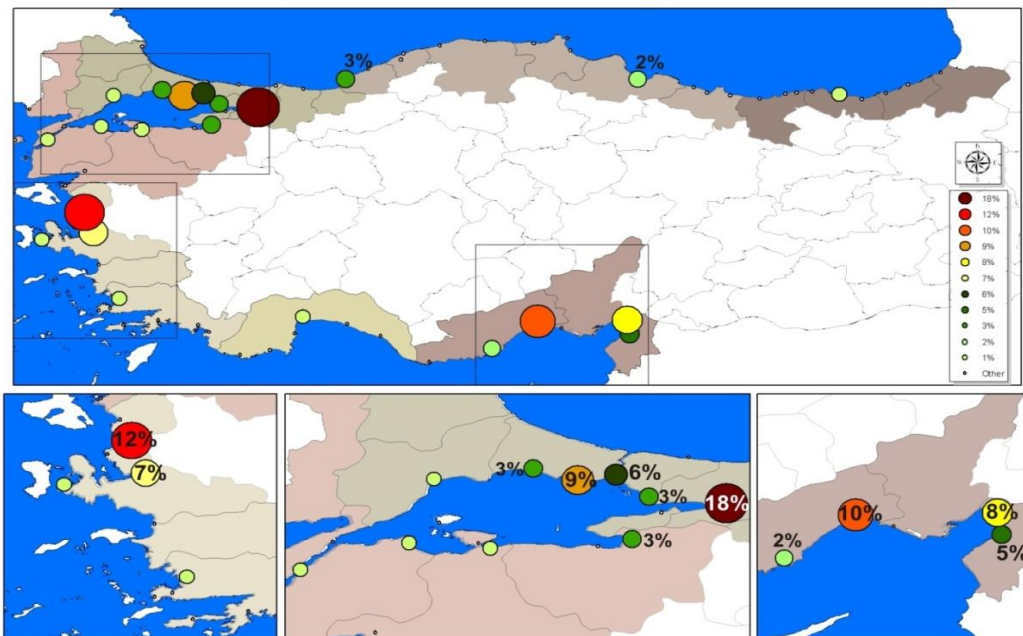
- 1- Ballast Water Risk Assessment Software,
- 2- Ballast Water Exchange Route Analysis Software,
- 3- Preparing a Port Environment Parameters Database,
- 4- Revision of the Invasive Species Database,

5- Revision of the Ballast Water Reporting Form Database,

**ACHIEVEMENTS FROM THE PROJECT**

**Inventory Study**

The time period for the inventory study was 5 years. All of the data were collected between 2002 and 2006. The amount of ballast water discharge and uptake were defined with respect to ship transportation data. Also, the origins and transportation patterns were defined, available literature was scanned, and the known impacts of the **invasive species** to Turkish coasts were defined. The sensitive coastline areas were defined with respect to current legislation.



**Figure 1. Ballast water discharged into the Turkish**

It was determined that 23 million tons of ballast water are discharged into Turkish coastal waters annually. Most of the ballast water is discharged to four hot spots in Izmit, Iskenderun, Izmir and Istanbul bays.

**Ballast Water Reporting Form System**

Ballast water reporting is a voluntary implementation. However, in Turkey a web-based reporting form system was established and defined as mandatory. The agents of the ships fill in the form via the internet, and after the approval of the harbor masters, the ship is allowed to arrive or depart the port.

## KORÇAK

Balast Düzeltme Formu - BTE tarafından sağlanan Microsoft Internet Explorer

File Edit View Favorites Tools Help

Address http://modos.mam.gov.tr/liman/balastlim.asp?mlID=78503567

Google

Ana Sayfa

**Balast Suyu Giriş Formu**

Tank Kodu:	AP	Değişim Günü:		Basım Günü:	
Tank Numarası:		Değişim Limanı:	ALANYA	Basım Limanı:	ALANYA
Alım Günü: (gün/ay/yıl)		Değişim Miktarı:	0.00	Basım Miktarı:	0.00
Alım Limanı:	ALANYA	Değişim Tuzluluğu:	0.00	Basım Tuzluluğu:	0.00
Alım Miktarı:	0.00				
Sıcaklık:	C				

Listeye Ekle

**Balast Değişim Listesi**

Onaya Gönder

Sıra	Tank Kodu	Tank Numarası	B.Alım Günü	B.Alım Limanı	Alım Miktarı	Sıcaklık	Sıcaklık Birimi	B.Değişim Günü	Değişim Limanı	Değişim Miktarı	Değişim Tuzluluğu	Basım Günü	Basım Limanı	Basım Miktarı	Basım Tuzluluğu
------	-----------	---------------	-------------	---------------	--------------	----------	-----------------	----------------	----------------	-----------------	-------------------	------------	--------------	---------------	-----------------

Done

Start Desktop Microsoft Office Ac... Converted Microsoft Excel - N... Microsoft PowerPot... MasterDBConverte... Balast Düzeltme... 11:41 PM

Figure 2. Ballast Water Reporting Form System coasts (Ballast Water Management Project, 2008) .

### Trend Analysis

The maritime transport data and ballast water discharge amounts were studied with a statistical interpolation method, and the amounts of ballast water discharged for 2016 was estimated for all ports.

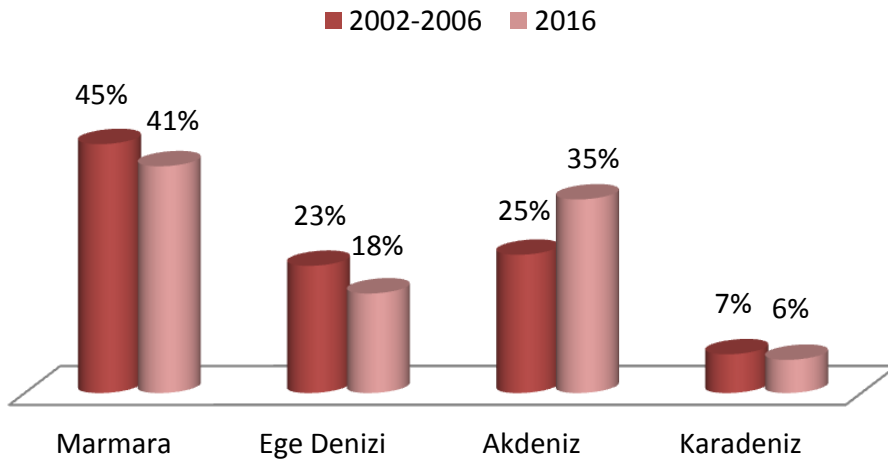
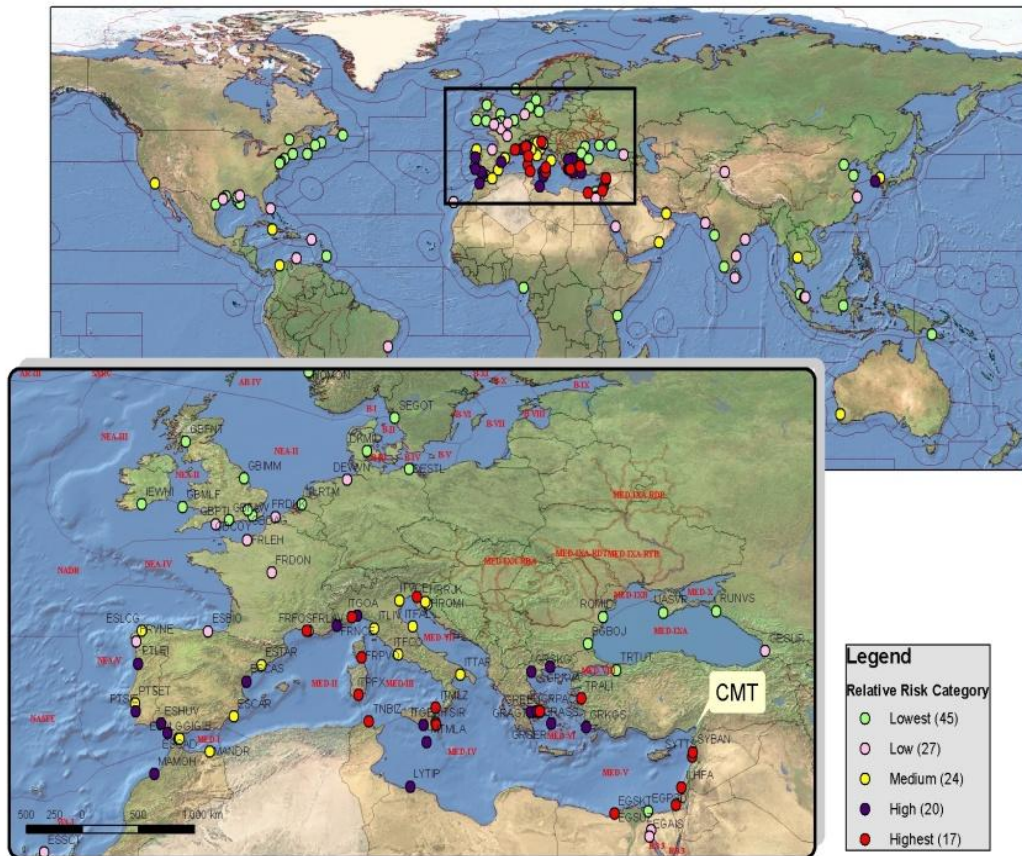


Figure 3. Ballast water discharge trend analysis

## BALLAST WATER MANAGEMENT IN TURKEY – AN OVERVIEW

### Risk Assessment Study

All of the Turkish ports were categorized with two different methods, namely the Globallast Risk Assessment Method and the Developed Baltic Risk Assessment Approach. Also, a target invasive species list was prepared for Turkish Coasts.



**Figure 4. Risk Assessment coasts (Ballast Water Management Project, 2008).**

Ballast water risk assessment methods define the risk of donor ports with respect to discharge port as low, medium, high and very high. In the figure 4, the risk categorization of donor ports to Ceyhan Port (discharge port) is shown.

### Geographical Information System

All of the data collected and all of the results achieved during the project were used to build a geographical information system (Figure 5). This system is a decision support tool for the implementation of the Ballast Water Management Convention.

### Route analysis

All the suitable sea areas are defined with respect to Ballast Water Management Convention's ballast water exchange criteria's. The routes are identified by using ship type,

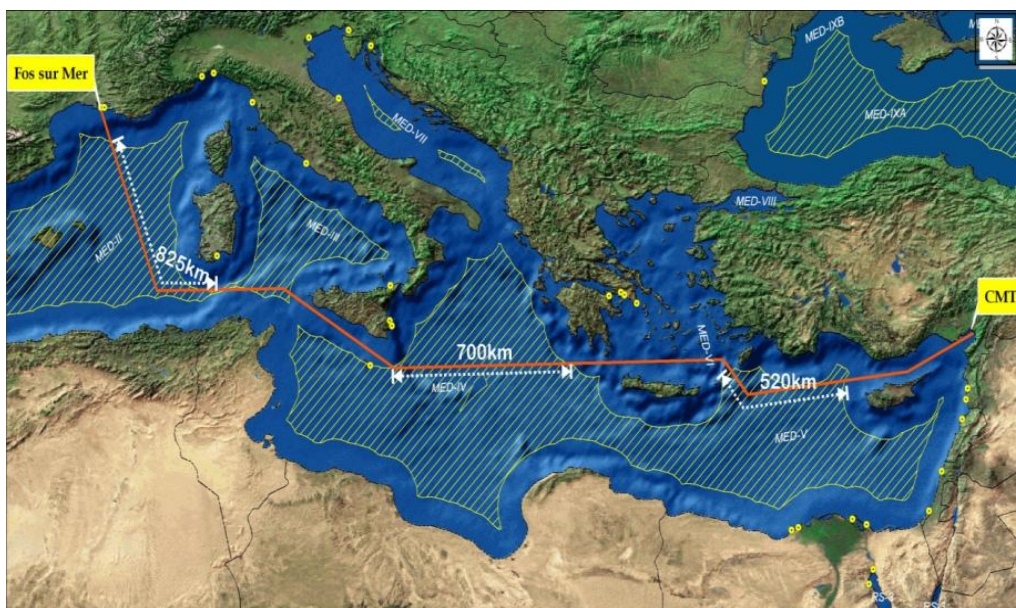


## KORÇAK

GT of ship and average speed. By using that analysis all the routes are classified as suitable or not suitable for exchange (Figure 6).



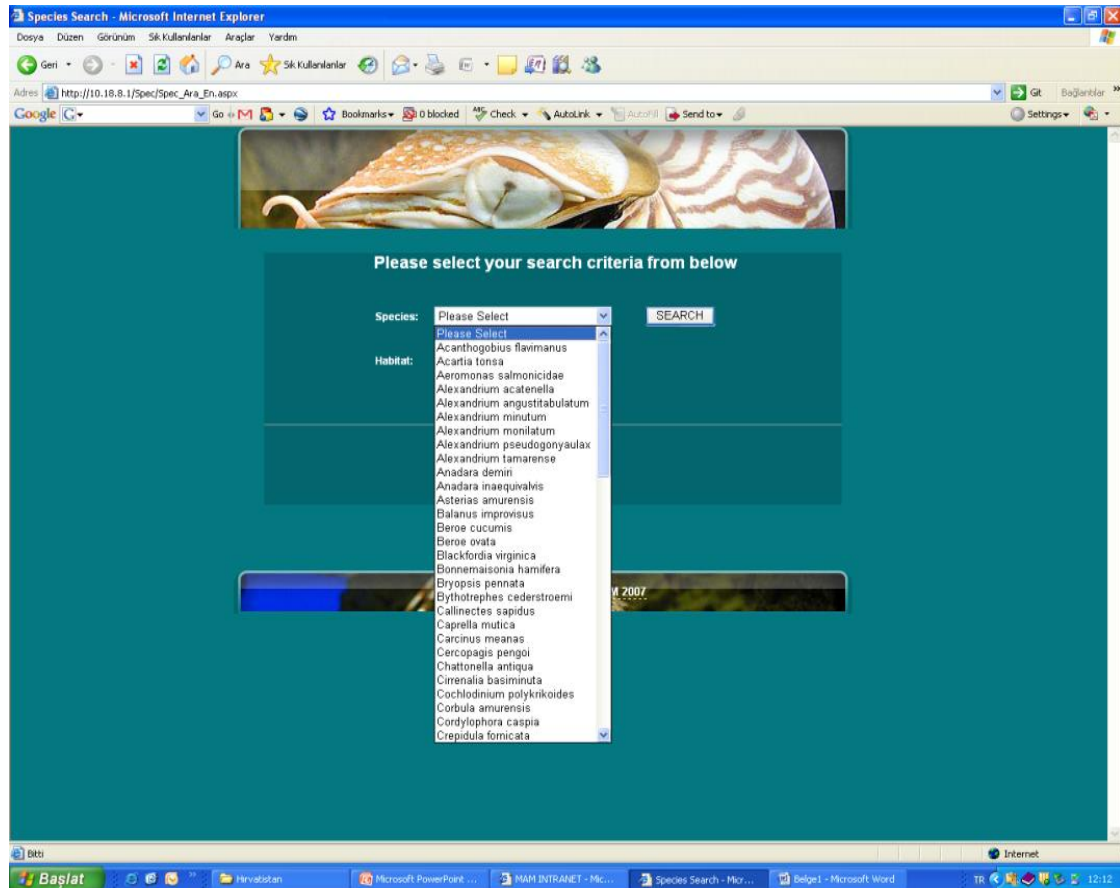
**Figure 5. GIS System coasts (Ballast Water Management Project, 2008) .**



**Figure 6. Route analysis (Ballast Water Management Project, 2008).**

### Invasive Species Data Base

The literature on reported invasive aquatic organisms was studied. Relevant properties of this invasive species were collected in a database system. This database can be accessed from the internet. The users can conduct searches according to the name or habitat of the invasive species.



**Figure 7. Invasive Species Database**

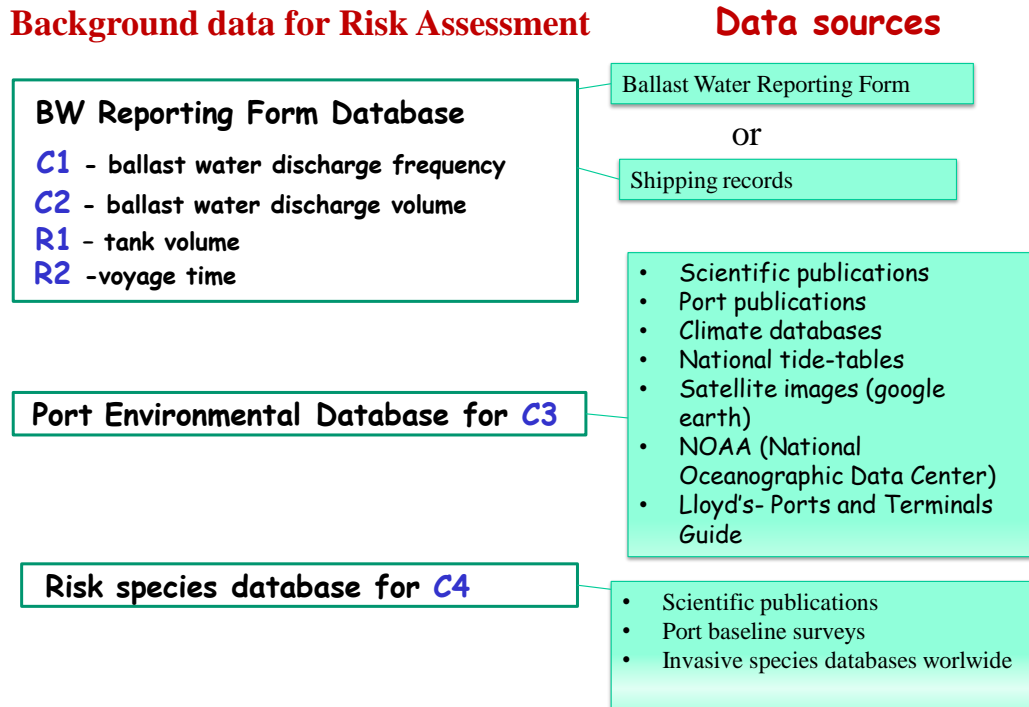
### SECOND SECTION (2010-2011)

#### Risk Assessment Software

This is a Geographical Information System based software which can calculate the risk between ports for ballast water transportation with GloBallast BWRA-Methodology.

The Globallast Risk Assessment methodology is a complex system which uses different calculation software and computer databases. It is a system that you can use to calculate the risk for ports for only a defined time period. For another time period, you have to make calculations from the beginning by using different calculation methods one by one.

## Ballast Water Risk Assessment System



**Figure 8. Risk Assessment Data Resources**

In our software, all calculation methods are modified to work together automatically and give results for different time periods instantaneously. This is a perfect tool for the port state investigation officers to use as a decision support tool for defining the most appropriate ship to be investigated.

This tool was produced to be used on port state investigations, and also it is a useful decision support tool for Turkey on deciding exchange/treatment exemptions for ships with respect to the Ballast Water Management Convention.

There are four different kind of coefficients have to be calculated with respect to the methodology. Also, there are two different risk reduction factors that have to be calculated. These coefficients are related to the frequency of ballast water discharge (C1), amount of ballast water discharge (C2), Environmental similarity (C3) and information on known invasive species (C4).

There are six different parameters that are calculated by using 3 different database systems. All databases and the risk assessment software are working via the web. This makes the system available from all over the world. The databases are the BW Reporting Form Database, Port Environmental Database and Risk Species Database.

## BALLAST WATER MANAGEMENT IN TURKEY – AN OVERVIEW

**BALAST-SUYU RISK DEĞERLENDİRME SİSTEMİ**

**ZARARLI SUCUL ORGANİZMALAR BİLGİ SİSTEMİ**

TÜBİTAK Marmara Araştırma Merkezi – Çevre Enstitüsü tarafından hazırlanmış olan bu sistem doğal ortamları farklı bölgelere peşitli vektörlerle taşınmış yabancı türleri içermektedir. Bu veritabanının hazırlanmasındaki temel amaç T.C. Denizcilik Müsteşarlığı için ulusal limanlarda kullanılması için hazırlanan Balast Suyu Risk Değerlendirme Sistemine limanların yer aldığı biyo-bölgelerdeki canlı türleri ile ilgili gerekli bilgiyi/veriyi sağlamaktır. [Devamı>>](#)

**BALAST SUYU RAPORLAMA SİSTEMİ**

Balast Suyu Risk Analizi Sistemine, limanlara gelen her bir gemi ile ilgili risk analizinde kullanılacak bilgileri sağlamak üzere geliştirilmiş olan bu sistem, IMO – Balast Suyu Raporlama Formuna uygun olarak geliştirilmiştir. [Devamı>>](#)

**BALAST SUYU RISK DEĞERLENDİRME SİSTEMİ**

Günümüzde gerçekleşen Denizcilik faaliyetlerinin ekosistem üzerindeki en ciddi tehditlerinden biri, işgalci tür denilen zararlı sucül organizma ve patojenlerin, gemilerin balast suları ile limanlar, denizler ve/veya kıtalar arasında taşınmasıdır. Bu canlılar, taşıdıkları ortamlarda baskınlığın çökmesine, kültür baskınlığı ile ilgili stokların bozulmasına, üretim maliyetlerinin artmasına, insan sağlığının etkilenmesine ve biyolojik çeşitliliğin değişimine neden olurlar. [Devamı>>](#)

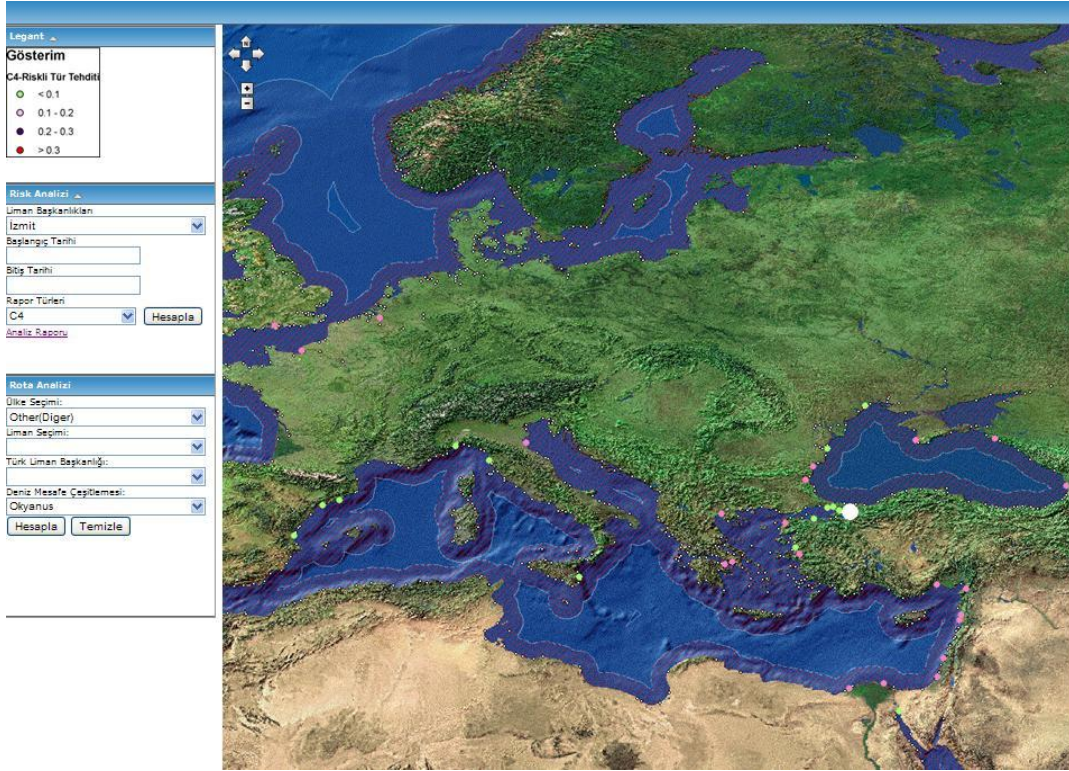
**Figure 9. Screen image of the risk assessment software**

The second section of the software reports the ballast water reporting forms and all information about the shipping traffic for Turkish ports. On the third section, you run the risk assessment software.

Risk assessment software reports the risk evaluation of the ports with respect to the other donor ports. You first choose which port you need to assess the risk. The system automatically gives information about the risk amounts of all possible donor ports.

As shown in the figure 10, the risk assessment for the İzmit port was conducted (plotted with a big white spot), the red plotted ports are the high risk ports, and the green plotted ports are low risk ports. Also, the system gives a report for a risk assessment, and all parameters can be investigated from risk report.

## KORÇAK



**Figure 10. Screen image of the risk assessment**

### Route Analysis

Route analysis is one of the important components of the risk assessment system. It reports if a ship is available to make a ballast water exchange with respect to its route.

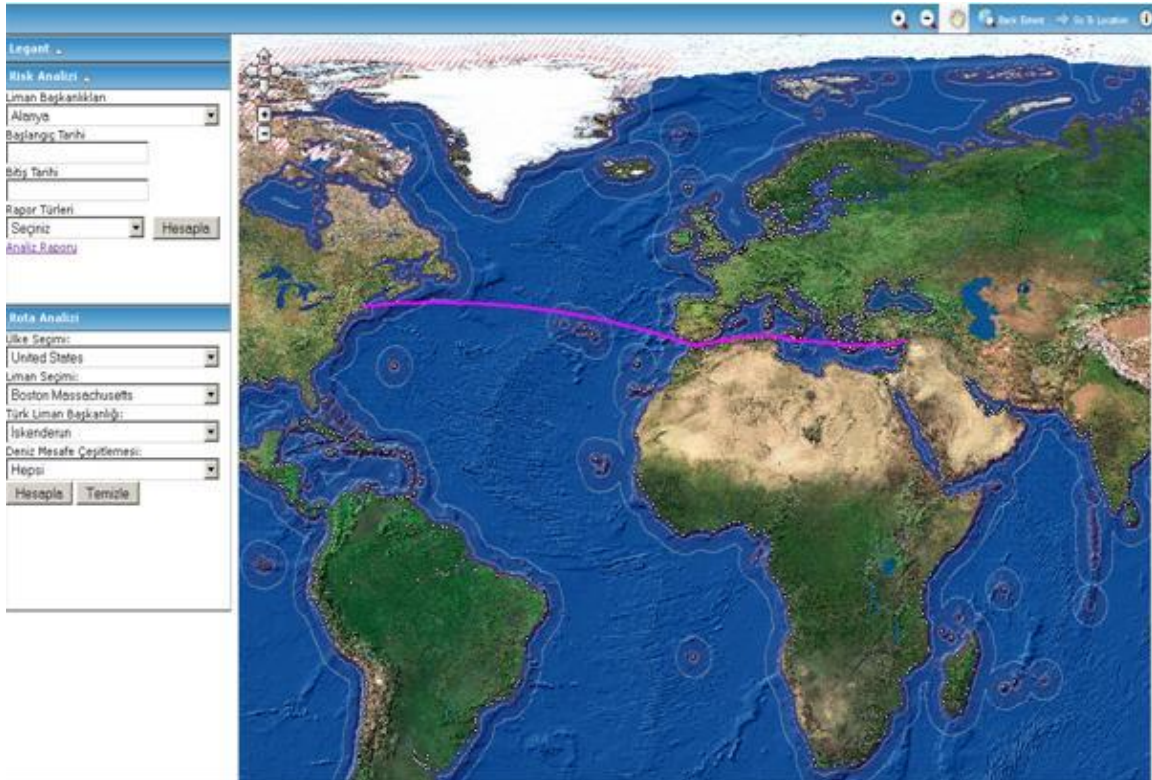
The user only inputs the last port of call and the arrival port from Turkey. The system automatically takes the properties of the ship, such as ballast water amount and the tonnage and the type of the ship. Afterwards, the system draws the most probable route for the ship and calculates the distance and available places to make an exchange. At the end, the system calculates the exchange duration and gives a result regarding whether this ship can make and exchange during this voyage or not.

This system is also a perfect tool for port state control officers as a decision support tool.

### THE TURKISH BALLAST WATER MANAGEMENT SYSTEM

The ratification process of the Ballast Water Convention in Turkey is nearly finalized. All the sub-commissions in the parliament approved the convention. Turkey will be a party of the convention after the approval of the parliament.

## BALLAST WATER MANAGEMENT IN TURKEY – AN OVERVIEW



**Figure 11. Route Analysis**

The national draft legislations are ready and awaiting the ratification process of the convention. After the ratification of the convention, the draft legislation will put into force immediately.

There is a pilot implementation that was carried out during this ratification period in order to test the capabilities of the Turkish port state control officers on ballast water Management inspections. The Botaş Harbor Master was chosen for this pilot implementation because of its intensive maritime traffic. This area is the oil loading terminal for the Baku-Tbilisi-Ceyhan pipeline. All of the ships calling Ceyhan are coming under full ballast conditions and discharge their ballast water into this terminal area.

The main idea of this pilot implementation is to force the ships to make exchanges and try to inspect them. We ordered all ships calling this port to make an exchange before entering the port in suitable places with respect to the Ballast Water Convention. If the ship did not or could not make the exchange, the ship was surveyed and BW samples were taken. After the analysis of the samples, if an invasive species was determined to be present, an exchange will be a “should” for this route. All of the other ships coming from that route would not be allowed to enter the port without exchange. After this pilot implementation, we realized that the training of the port state control officials is one of the most important concerns of ballast

water management system. It is a complicated process, and training dramatically affects the success.

As the maritime authority of Turkey, we can easily say that after the two phases of the national ballast water management project, Turkey is ready to implement all of the aspects of the Ballast Water Management Convention.

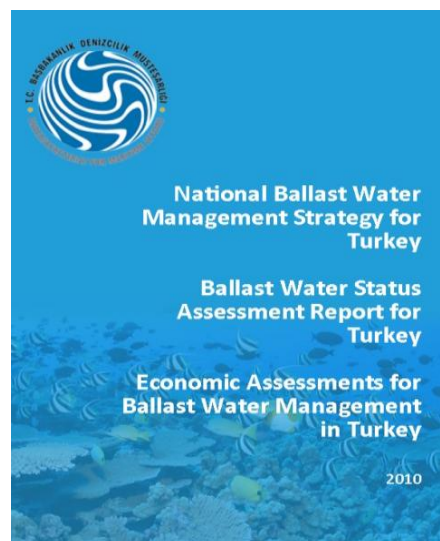
Especially in the second phase of the national project, a decision support tool was prepared which we can use for:

- Deciding to allow or not to allow the ship to enter a port,
- Choosing the highest risk ship for inspection,
- Defining the port rules about Ballast Water Management,
- Evaluating the probability of ballast water exchange of a ship,
- Deciding about exemptions for a ship, and
- Collecting statistical data for scientific studies.

Turkey is also a Leading Partnership Country for the Mediterranean Region with Croatia through the GloBallast Partnership Project. Some of the main activities of the project were held in Turkey. These activities included the Port Baseline Survey Workshop (21-24 October 2008), Legal Training (2-3 December 2009), and the Second Regional Task Force Meeting (1-3 June 2010).

Turkey executes the Chairmanship of the Regional Task Force and plays an important role in the preparation of the Regional Ballast Water Management Strategy. This document was approved by the contracting parties of the Barcelona Convention and put in force.

Turkey also published a report called, "Blue Book about the Ballast Water Management Activities in Turkey". The Blue Book contains three reports, which are the National Ballast Water Management Strategy for Turkey, Ballast Water Status Assessment Report for Turkey and Economic Assessments for Ballast Water Management in Turkey.



**Figure 13. Blue Book**

## BALLAST WATER MANAGEMENT IN TURKEY – AN OVERVIEW

Future plans of Turkey include the successful implementation of the Ballast water Management Convention. Within this context, we will implement all of the activities defined in National Strategy seriously and enact and enforce the national legislation as soon as possible.

### REFERENCES

*Hilliard, Rob., Clarke, C., Stevens, C., Polglaze, J. and C. T.Hayes (2003), Ballast Water Risk Assessment (Activity 3.1), User Guide (v1.4), GEF/UNDP/IMO, Global Ballast Water Management Programme (GloBallast), for the BWRA Database/ GIS System.*

*Leppäkoski, E. and S. Gollasch, Risk Assessment of Ballast Water Mediated Species Introductions –a Baltic Sea Approach, 2006.*

*Olgun, A., Avaz, G., Dönertaş, A. S., Aydöner, C., Bozkaya Ş., Pekdemir, E. A., Murat, S., Oral, N., Başar, E., Feyzioğlu, M. and et al.(2009) The Control and Management of Harmful Aquatic Organisms Transported by Ballast Water, Project Report, TUBITAK-Marmara Research Center-Environment Institute, ÇE.09.10.*

*Olgun, A., Aydöner, C. and T. Atalay (2011) Development of Ballast Water Risk Assessment Software Project, TUBITAK-Marmara Research Center-Environment Institute.*





## Biological Efficacy of Electrolytic BWMS (Electro-Cleen™ System) During Onboard Installation

Yong Seok Park, Dong Hyun Shon<sup>1</sup>, Gwang Ho Lee, Hyun Ju Moon,  
Hyung Geun Jeon

---

### Abstract

*An electrolytic ballast water treatment system (Electo-Cleen™ System, ECS), which obtained a type approval in December 2009, was continuously evaluated to ensure its biological efficacy during onboard installation in newly built vessels. Thirteen shipboard tests were performed to determine the biological efficacy of the system. The evaluations were carried out in the major ship building yards in Korea and Japan between June 2009 and December 2010.*

**Keywords:** 2004 BWM Convention, Electro-Cleen™ System, Shipboard test, biological efficacy, D-2 standard, Total Residual Oxidant

---

### 1 Introduction

Since the International Maritime Organization (IMO) adopted the 2004 BWM Convention ('the International Convention for the Control and Management of Ships' Ballast Water and Sediments') to prevent risks induced by transfer of non-indigenous organisms and pathogens, 14 systems on the market have been type-approved under G8 as of May 2011 (Lloyds Register, 2011). Currently, over 40 ballast water technologies are expected to obtain type approval soon. These commercially available systems, or system that are going to be commercially available soon, need to be evaluated to ensure they always meet the requirements of the IMO D-2 regulation. This study focused on the biological efficacy of an electrolytic ballast water treatment system (Electo-Cleen™ System, ECS), which obtained a type approval by the Korean authority in December 2009. The system was evaluated 13 times during shipboard installation to confirm that the D-2 standards were met between June 2009 and December 2010.

### 2 Materials and Methods

Shipboard tests were carried out to evaluate the viability of organisms specified by D-2 standards after the treatment. A volume of 1 m<sup>3</sup> of water samples was netted for organisms over 50µm (mesh size 32µm). Organisms between 10 µm and 50 µm were collected using a net, which has a mesh size of 5µm. A volume of 10 L of water samples were netted for

---

<sup>1</sup> R&D Division, Techcross Inc., 25-1 Kwanam-ri, Inju-myun, Asan, Chung Nam 336-833, S. Korea.

organisms between 10 µm and 50 µm. All samples were collected in triplicate. Triplicate bacterial samples of *Escherichia coli*, Enterococci and *Vibrio cholera* were collected using 1L sterilized bottles.

Viable organisms larger than 50 µm (mainly zooplankton) were determined based on the appendage's movement under a stereomicroscope. Organisms were considered to be "viable" if they were actively moving or exhibited an escape behavior when probed with a fine needle. If no activity or movement of any kind was observed, after the additional sticking with a fine needle, organisms were considered to be "dead". The viability was confined to the unimpaired body of zooplankton.

Viable organisms between 10 µm and 50 µm (mainly phytoplankton) were assessed using light microscopy and epifluorescence microscopy. Sliding or its own original movement was considered as an indication of viable organisms. The emission of chlorophyll-induced red color (autofluorescence) was also determined as an indicative signal of cell viability (Pouneva, 1997). A working stock solution of FDA (5 mg/mL) was prepared by diluting the primary DMSO solution 100 times with chilled distilled water (50 µg/mL). The solution was mixed during preparation to prevent the precipitation and kept cold in the dark. Each sample was stained by adding 33 µl of the working solution to a 1 mL sample (end concentration: 1.7 µg mL<sup>-1</sup> FDA) (Gervey *et al.*, 2007). Stained samples were kept in a cool and dark place for a minimum of 10 minutes prior to enumeration. The fraction of FDA-stained cells (viability) was determined under an epifluorescence microscope at 100X to 200X magnification, depending on cell size. Organisms, which emitted green-fluorescence and red-fluorescence, were counted under blue light excitation (wavelengths 450 to 500 nm) as viable organisms.

*Escherichia coli* was evaluated by filtrating 10mL of sample water onto the 0.2 µm membrane filter. Filters were placed on the top of *E. coli* Coliform and Coliform Count Plates (3M™ Petrifilm plate). The Petrifilm plates were incubated for 24 hrs at 35°C. The blue to red-blue colonies associated with entrapped gas in the Petrifilm EC plate was considered as *E. coli*.

*Vibrio cholerae* (serotypes O1 and O139) was evaluated by filtrating 5 to 10 mL of sample water onto the 0.2µm membrane filter. Filters were placed on the TCBS (Bisulfate Citrate Bile Sucrose) agar. Pre-treated TCBS agar plates were incubated for 24 hrs at 35°C. The green colored CFU was considered as *Vibrio parahaemolyticus*. The yellow colored CFU was isolated into nutrient agar and incubated for 24 hrs at 35°C. If the cultivated CFU showed purple color, it was considered to be positive. If the incubated CFU was determined as positive, API20E test was carried out.

## BIOLOGICAL EFFICACY OF ELECTROLYTIC BWMS (Electro-Cleen™ System)

Enterococci was evaluated by filtrating 20 ~ 40 mL of sample water onto the 0.2 µm membrane filter. Filters were placed on the Intestinal Enterococci agar plate. The pre-treated agar plates were incubated for 48 hrs at 35°C. The pink to brown coloured CFU with a diameter of 0.5 to 2 mm was considered to be Enterococci.

### 3 Results

Shipboard tests for biological efficacy were performed to evaluate the D-2 criteria. There were 13 shipboard tests for biological efficacy of the equipment (Table 1.).

**Table 1. Shipboard evaluation for ECS during installation; water qualities and operational condition.**

Date	Installation No.	pH	Salinity (PSU)	Temperature (C°)	TRO concentration (mg L <sup>-1</sup> )	Unit installation*	Water flow (m <sup>3</sup> hr <sup>-1</sup> )	Ship Yard
Jun/5/09	S1	8.2	30.6	23.8	6.0	ECS300A X 2	600	A
Sep/15/09	S2	8.4	34.4	23.5	7.1	ECS300A X 2	620	B
Sep/17/09	S3	8.1	34.5	23.3	6.5	ECS300A X 2	580	A
Oct/23/09	S4	8.0	36.2	18.2	8.3	ECS300A X 1	150	C
Nov/20/09	S5	8.3	29.0	13.8	7.8	ECS300A X 2	500	A
Dec/17/09	S6	8.2	31.7	10.2	8.3	ECS300A X 2	480	B
Mar/12/10	S7	8.4	32.8	16.5	6.7	ECS300A X 2	630	A
July/08/10	S8	8.2	35.6	24.1	8.9	ECS300A X 2	580	A
Aug/13/10	S9	8.5	34.3	25.3	8.5	ECS300A X 2	550	A
Oct/13/10	S10	8.1	32.1	17.4	8.9	ECS300A X 2	610	A
Dec/09/10	S11	8.0	34.3	14.9	7.2	ECS600A X 1	620	C
Dec/24/10	S12 (APT)**	8.2	34.5	12.1	8.1	ECS600A X 1	550	D
Dec/27/10	S13 (BWT)**	8.2	34.3	12.3	8.4	ECS600A X 8	5100	D

\* ECS300A: Treatment Rated Capacity 300 m<sup>3</sup> h<sup>-1</sup> / ECS600A: Treatment Rated Capacity 600 m<sup>3</sup> h<sup>-1</sup>

\*\* APT: After Peak Tank / BWT: Ballast Water Tank

The water temperature ranged between 10.2 °C and 25.3 °C, while the range of pH was from 7.7 and 8.5 during the study. The salinity range was between 29.0 PSU and 36.2 PSU. The early installations of 10 vessels were equipped with single or multiple units, which have a treatment rated capacity (TRC) of 300 m<sup>3</sup> h<sup>-1</sup>. Ships' installation numbers of these vessels were S1, S2, S3, S4, S5, S6, S7, S8, S9 and S10. The remaining three tests were carried out with units which have a TRC of 600 m<sup>3</sup> h<sup>-1</sup> (S11, S12 APT, S13 BWT) (Table 1.).

The sufficient biological efficacy to comply with D-2 standard was found if the total residual oxidant (TRO) was maintained between 6.0 mg L<sup>-1</sup> to 8.9 mg L<sup>-1</sup> (Table 1 and Table 2.). The population density of untreated sample larger than 50 µm was higher than 8.6 X 10<sup>2</sup> inds. m<sup>-3</sup> (S6) during all evaluations, while that of untreated sample reached to 6.2 X 10<sup>4</sup> inds. m<sup>-3</sup> on August 13, 2010, during the evaluation of S9 (Table 2). The population densities of treated sample larger than 50 µm were always less than 2 inds. m<sup>-3</sup> (S1, S3). The cell densities of organism between 10 µm and 50 µm showed that the highest population density of untreated sample reached to 2.0 X 10<sup>2</sup> cells. mL<sup>-1</sup> on December 27, 2010, during the evaluation of S13 BWT. The cell densities of viable organisms between 10 µm and 50 µm in treated sample were maintained below 2 cells. mL<sup>-1</sup> (Table 2.).

**Table 2. Biological efficacy of ECS; mean values of triplicate analysis.**

SD: Standard deviation

Installation No.	Samples	Test Items (D-2 Criteria)				
		>50µm inds m <sup>-3</sup>	10-50µm cells mL <sup>-1</sup>	<i>E.coli</i> CFU 100mL <sup>-1</sup>	Enterococcus CFU 100mL <sup>-1</sup>	<i>Vibrio cholerae</i> CFU 100mL <sup>-1</sup>
S1	Treatment	2	1	0	0	0
	SD	2	0	0	0	0
	Control	6080	12	0	0	0
	SD	1990	1	0	0	0
S2	Treatment	0	0	0	0	0
	SD	0	0	0	0	0
	Control	9533	2	0	0	0
	SD	1384	1	0	0	0
S3	Treatment	2	2	0	0	0
	SD	2	1	0	0	0
	Control	11897	20	0	0	0
	SD	2411	7	0	0	0
S4	Treatment	1	0	0	0	0
	SD	2	0	0	0	0
	Control	2167	165	0	0	0
	SD	430	8	0	0	0
S5	Treatment	0	0	0	0	0
	SD	0	0	0	0	0
	Control	2255	26	1	0	0
	SD	400	4	1	0	0
S6	Treatment	0	0	0	0	0
	SD	0	0	0	1	0
	Control	863	39	0	0	0
	SD	58	11	0	1	0
S7	Treatment	0	0	0	0	0
	SD	0	0	0	0	0
	Control	39330	17	100	65	0
	SD	8048	4	20	22	0
S8	Treatment	0	0	0	0	0
	SD	0	0	0	0	0
	Control	5105	106	0	0	0
	SD	2151	19	0	0	0

## BIOLOGICAL EFFICACY OF ELECTROLYTIC BWMS (Electro-Cleen™ System)

Installation No.	Samples	Test Items (D-2 Criteria)				
		>50µm inds m <sup>-3</sup>	10-50µm cells mL <sup>-1</sup>	<i>E.coli</i> CFU 100mL <sup>-1</sup>	Enterococcus CFU 100mL <sup>-1</sup>	<i>Vibrio cholerae</i> CFU 100mL <sup>-1</sup>
S9	Treatment	0	0	0	0	0
	SD	0	0	0	0	0
	Control	62435	156	8100	0	0
	SD	3728	31	2022	0	0
S10	Treatment	1	0	0	0	0
	SD	1	0	0	1	0
	Control	2378	23	47770	919	0
	SD	362	3	3233	341	0
S11	Treatment	0	0	0	0	0
	SD	0	0	0	0	0
	Control	2546	13	100	1	0
	SD	283	4	100	1	0
S12 (APT)	Treatment	0	0	0	0	0
	SD	0	0	0	0	0
	Control	1317	96	0	23	0
	SD	147	5	0	4	0
S13 (BWT)	Treatment	0	0	0	0	0
	SD	0	0	0	0	0
	Control	1253	197	0	4	0
	SD	47	25	0	4	0

The results of bacterial analysis showed that no countable CFU was found in treated samples except during the evaluation of S10 for enterococcus on October 13, 2010 (SD = 1) (Table 2.). The viable *E. coli* collected from untreated samples reached over  $4.7 \times 10^4$  CFU 100 mL<sup>-1</sup> on October 13, 2010 (S10), while the density of viable enterococcus was  $9.2 \times 10^2$  CFU 100 mL<sup>-1</sup>. There were no viable *V. cholerae* for both untreated and treated water samples during evaluations.

## 4 Discussion

All 13 shipboard evaluations for biological efficacy satisfied D-2 standard under various water conditions when TRO concentration was over 6.0 mg L<sup>-1</sup>. The dominant group of organisms bigger than 50 µm was barnacle larvae during the installation of S9, while copepoda dominated during the installation of S3 and S7. Diatom predominated organisms between 10 µm and 50 µm during the installation of S4 and S13. However, dinoflagellate dominated during the installation of S9.

## REFERENCES

Garvey, M., B. Moriceau and Passow, U. (2007), Applicability of the FDA assay to determine the viability of marine phytoplankton under different environmental conditions. *Marine Ecology Progress Series*, **352**, 17-26.

Lloyds Register (2011), Ballast water treatment technology: current status, London. June.

Pouneva, I. (1997) Evaluation of algal culture viability and physiological state by fluorescent microscopic methods. *Bulg. J. Plant Physiol.*, **23(1-2)**, 67-76

## Assessing of the Ballast Water Risk in Ceyhan Marine Terminal

Arzu Olgun<sup>1</sup>, Aslı Sha Dnertaş, Cihangir Aydner, Yasemin Gmşlođlu<sup>2</sup>,

---

### **Abstract**

*Ship's ballast water and sediments serve as a main vector in the transportation and spreading of planktonic organisms, toxic dinoflagellates, bacteria and other unicellular organisms. A proportion of these species are capable of causing serious harm to native biodiversity, industries and human health.*

*Ceyhan Marine Terminal (CMT) which is located on the N-NW coast of the Gulf of Iskenderun, (Eastern Mediterranean Sea in Turkey) is an export terminal which transports crude oil from the Azeri Caspian Sea to the world market via tankers. With the starting of tanker traffic in Ceyhan Marine Terminal in June-2006, the volume of the discharged ballast water from various seas of the world into the CMT and the possibility of the introduction of invasive species to Iskenderun Bay have increased significantly. And, this site has been the most risky zone of Turkey coasts in the scope of ship-borne species introduction.*

*The main aim of this study is to assess the ballast water risk of the tankers on Iskenderun Bay (Turkey). The relative overall risk (ROR) posed by each BW source port to CMT has been identified by using four-year shipping traffic data and Ballast Water Reporting Form System data. According to data obtained from the Ballast Water Reporting Forms and the shipping traffic records, 45.551.876 tonnes of BW were discharged to CMT between 4.June.2006 and 02.June.2010 (annual average 11.300.000 tonnes) from 1126 visits. In the BWRA, 20 ports from the 133 source ports have been identified as "high" risk ports. 17 ports have been identified as "highest" risk ports, also.*

**Keywords:** Ballast Water Risk Analysis, Invasive species, Iskenderun Bay, Turkey

---

### **Introduction**

The Mediterranean Sea as an enclosed sea is particularly vulnerable to ship-associated impacts due to a high-volume of shipping routes, long history of use, and sensitive shallow and deep-sea habitats. One of the major threats to marine biodiversity changes in the Mediterranean Sea is biological invasion. It is well known that the opening of the Suez Canal (19th Century) has led to the introduction of hundreds of species of Indo-Pacific and Erythraean origin which have established permanent populations particularly in the eastern Mediterranean (Levantine Basin). According to recent scientific study reports, approximately

---

<sup>1</sup> TBİTAK Marmara Research Center – Environment Institute, Gebze Kocaeli, TURKEY.

<sup>2</sup> Baku-Tbilisi Ceyhan Pipeline Company, Environment Department , Ankara, TURKEY



400 non-native species were reported along the Turkish coast. 331 of these alien species were recorded from East Mediterranean sea coasts and 56 of 331 species are ship-borne species (Çınar et al, 2011).

Ceyhan Marine Terminal (CMT) which is located on the N-NW coast of the Gulf of Iskenderun is one of the major oil export ports of Eastern Mediterranean and the port area is also susceptible to invasion of ship-borne organisms. With the starting of tanker traffic in June - 2006, this site has been the highest risk area of Turkey coasts because of ship-borne species introduction

Under Regulation A-4 of the Ballast Water Convention, parties may grant exemptions to ballast water management requirements of the ships which only operate between specified ports or locations. Vessels may hence be exempt from applying any measures, as long as it can be documented that the risk of introduction is low or acceptable. The IMO Guidelines for Risk Assessment under Regulation A-4 of the BWM Convention (G7) provide advice and information regarding risk assessment principles, methods, and procedures for granting exemptions.

In this study was undertaken a ballast water risk assessment (BWRA) study, according to the IMO – GloBallast BWRA methodology, for tanker movements between ports of tanker origin (source ports) and Ceyhan Marine Terminal (CMT) port to determine the risk of biological contamination between the ports for last 4- year period (June/2006–June/2010). The discharged ballast water amount into the Iskenderun Bay and their origins was also determined.

## **Methodology**

IMO Globallast BWRA methodology was used during the BWRA studies for CMT. The BWRA Database software was developed by GloBallast project team to provide a 'first-pass' risk assessment for training, demonstration and evaluation purposes. The database employed the BW discharge, port environmental matching and bioregion species distribution/threat data to calculate, as objectively as possible, the relative risk of a harmful species introduction to a port site, as posed by discharges of BW and associated organisms that were ballasted at each of its identified source ports [1].

The database calculates the ROR (Relative Overall Risk of a potentially harmful introduction for all source ports that have C1-C4 coefficients and R1-R2 risk reduction factors. The ROR value for each source port represents a proportion of the threat posed to the receiver port as result of its contemporary trading pattern. Figure 1 and Figure 2 show schematic of the GloBallast BWRA System and the Risk Coefficients, respectively.

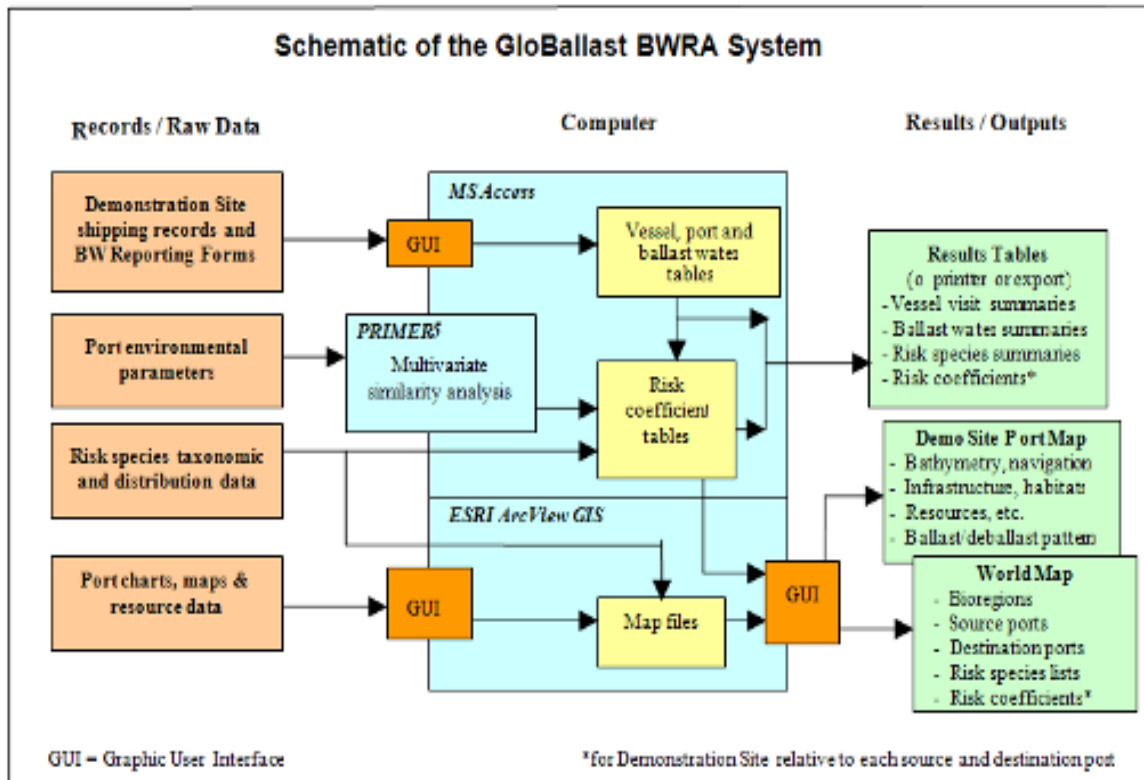


Figure 1. Schematic of the GloBallast BWRA System [1]

The formula for calculating the relative overall risk (ROR) posed by a source port is:

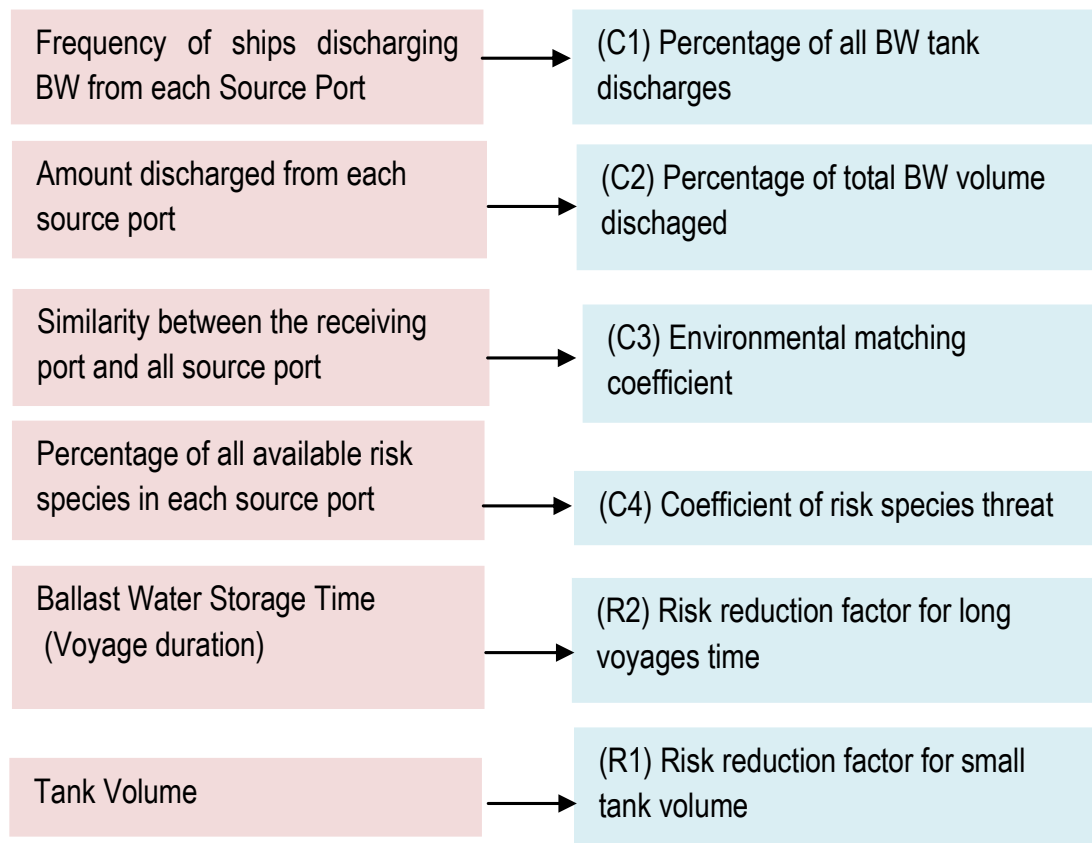
$$ROR = (C1 + [C2 \times R1] + C3 + [C4 \times R2]) / 4$$

The shipping data used in the CMT-BWRA study was provided by BOTAŞ International Limited (BIL), Designated Operator for BTC, and from the Ballast Water Reporting Form (BWRf) system between the dates 4 June 2006 – 04 June 2010.

### Environmental Similarity Analysis and Port Environmental Data (C3)

The more a BW receiver port is environmentally similar to a BW source port, the greater the change that organisms discharged with the imported BW can tolerate their new environment and maintain sufficient numbers to grow reproduce and develop a viable population. Comparing port to port environmental similarities provides a relative measure of the risk of organism's survival, establishment and potential spread. The environmental distances between the receiver port and the source port are determined using a multivariate method in the Primer package. Table 3 shows environmental parameters used for determining the environmental similarities (C3) between two ports. Totally 133 source ports were analysed to

identify their environmental similarities with Ceyhan Marine Terminal by using Primer program.



**Figure 2. Risk Coefficients**

### **Risk species and NIS Data for C4 Calculation**

One of the BWRA objectives was to identify 'high-risk' species that may be transferred to receiver port. The Access database was therefore provided with tables for storing the names, distribution and other information on risk species. For the purposes of the BWRA and its 'first-pass' risk assessment, a risk species was considered to be any introduced, cryptogenic or native species that might pose a threat if transferred from a source port to a receiver port. The database manages the bioregional locations and status of each entered species using the same bioregions displayed on the GIS world map. Bioregion map provided by the Australian Centre for Research on Introduced Marine Pests (CRIMP).

**ASSESSING OF THE BALLAST WATER RISK IN CEYHAN MARINE TERMINAL**

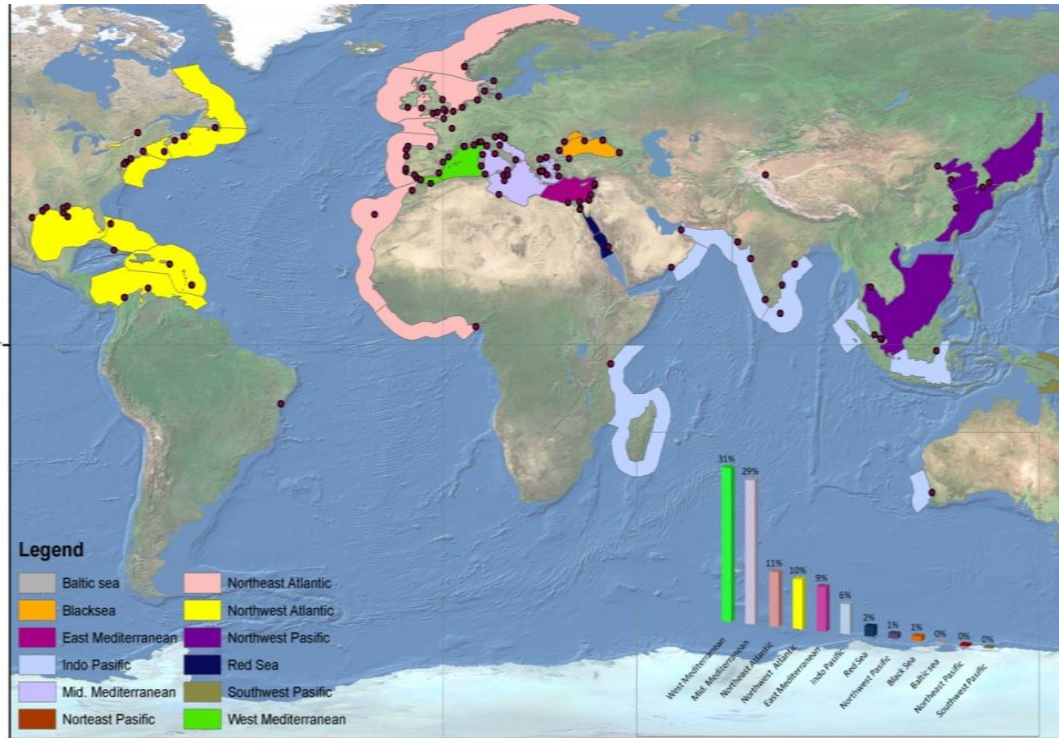
**Table 1. Port Environmental Parameters used by the Environmental Similarity Analysis.**

<b>No</b>	<b>Name</b>	<b>Variable Type</b>
1.	Port type	Categorical
2.	Mean water temperature during warmest season (°C)	Scalable
3.	Maximum water temperature at warmest time of year (°C)	"
4.	Mean water temperature during coolest season (°C)	"
5.	Minimum water temperature at coolest time of year (°C)	"
6.	Mean day-time air temperature recorded in warmest season (°C)	"
7.	Maximum day-time air temperature recorded in warmest season (°C)	"
8.	Mean night-time air temperature recorded in coolest season(°C)	"
9.	Minimum night-time air temperature recorded in coolest season (°C)	"
10.	Mean water salinity during wettest period of the year (ppt)	"
11.	Lowest water salinity at wettest time of the year (ppt)	"
12.	Mean water salinity during driest period of year (ppt)	"
13.	Maximum water salinity at driest time of year (ppt)	"
14.	Mean spring tidal range (metres)	"
15.	Mean neap tidal Range (metres)	"
16.	Total rainfall during driest 6 months (millimetres)	"
17.	Total rainfall during wettest 6 months (millimetres)	"
18.	Fewest months accounting for 75% of total annual rainfall	Integer
19.	Distance to nearest river mouth (kilometres) - negative value if upstream	Scalable
20.	Catchment size of nearest river with significant flow (square kilometres)	"
<u>Logarithmic habitat-distance category - from closest BW discharge site to nearest:</u>		
21.	Smooth artificial wall	Categorical
22.	Rocky artificial wall	"
23.	Wooden pilings	"
24.	High tide salt marsh, saline flats	"
25.	Sand beach	"
26.	Stony beach	"
27.	Low tide mud flat	"
28.	Mangroves	"
29.	Natural rocky shore or cliff	"
30.	Subtidal firm sands	"
31.	Subtidal soft mud	"
32.	Seagrass meadow	"
33.	Rocky reef or pavement	"
34.	Coral reef (carbonate framework)	"

## Results

According to data obtained from the Ballast Water Reporting Forms and the shipping traffic records, 45.551.876 tonnes of BW were discharged to CMT between 4.June.2006 and 02.June.2010 (annual average 11.300.000 tonnes) from 1126 visits. The majority of the BW volume discharged to CMT area was from the Mediterranean Sea (69%) which was followed

by North East Atlantic (11%), North West Atlantic (10%) and Indo-Pacific Ocean (6%). The highest BW discharge volume belongs to the Western Mediterranean Sea with ~ 14.061.894 tonnes (Figure 3).



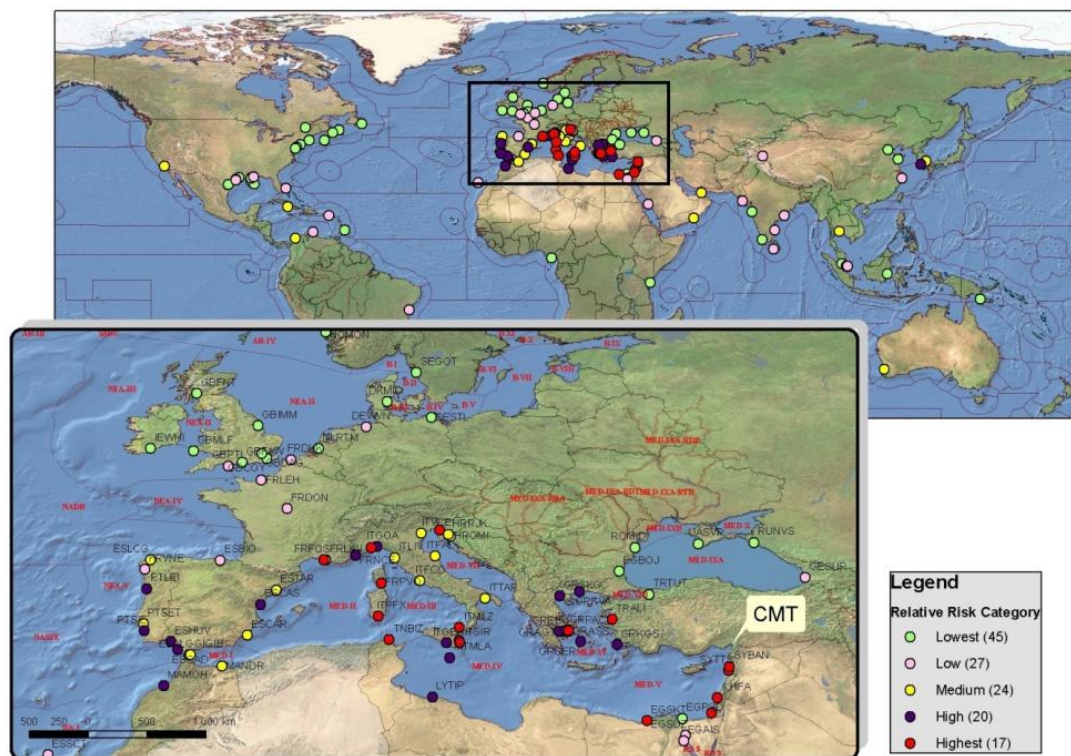
**Figure 3. Proportion of BW volume discharges according to the seas in the Iskenderun Gulf (June 2006 – June 2010).**

### Risk Assessment Results

From the 1126 visit records in the database, it was identified 17 of the 133 source ports as representing the “highest” risk group (in terms of their BW source frequency, volume, environmental similarity and assigned risk species). These ports, which all were Mediterranean, provided the top 19.71% of the total ROR, with individual values in the 0.23-0.19 range (Table 4). The highest risk port was led by Haifa (ROR = 0.23) followed by Ashkelon with the same risk values (ROR = 0.23). The other highest risk ports are Augusta/Priolo, Trieste, Sidi Kerir, Tartous and Porto Foxi (Sarroch) with 0.22 risk values, Fos Sur Mer, Santa Panagia and Banias with 0.21 risk values, Savona, Aliaga and Porto Vecchio with 0.20 risk values and Piraeus, Milazzo, Bizerte and Skaramanga with 0.19 risk values. 6 ports from highest risk ports were from MED-III and MED-II bioregions in the West Mediterranean, 5 ports were from the same bioregion (MED-V) with CMT. Other 6 ports were from Mid Mediterranean.

## ASSESSING OF THE BALLAST WATER RISK IN CEYHAN MARINE TERMINAL

20 ports have been detected as high risk ports. 14 ports from 20 “high” risk ports (19.67%) were also in the Mediterranean. Their ROR values are between 0.19 and 0.17. 6 non-Mediterranean ports; Leixoes (France-North East Atlantic; ROR: 0.18), Cadiz and Huelva (Spain- North East Atlantic; ROR: 0.17) and Sines (Portugal- North East Atlantic) from NEA-V bioregion and Mohammedia (Morocco-North East Atlantic; ROR: 0.17) from WA-I bioregion and Yosu (Korea- North West Pacific; ROR: 0.17) from NWP-3a bioregion were identified in the high risk category.



**Figure 4. GIS world map outputs showing the location and categories of relative overall risk (ROR) of the BW source ports identified for CMT.**

The number of BW source ports in the “medium”, “low” and “lowest” risk categories were 23, 28 and 45 respectively. 14 ports from 23 “medium” risk ports were from Mediterranean. Their ROR values are between 0,17 and 0,14. Also, 3 ports from North East Atlantic, 1 port from North East Pacific, 2 ports from North West Pacific and 3 ports from Indian Ocean were other ports in the medium risk category.

The 73 source ports in the “low” (28) and “lowest” (45; ROR; 0,12-0,2) risk categories were generally a mixture of cool and very warm water ports, plus river/brackish ports with a wide distribution. The source port with the lowest ROR value (0,02) was New Orleans from United

States (Table 9). New Orleans is located near the river, and its salinity is 0. Becancour Quebec from Canada was also in the lowest risk categories (ROR=0,03). This port is also located near the river, and its salinity is 0. Most of the other lowest risk ports are also located near the river or in the estuary. The water salinity of the CMT is generally around 0,39%. Organisms in the lower saline brackish water or fresh water taken onboard during BW operations will not likely survive when being discharged in higher saline waters. The species introduction risk is also minimal. Results from the BWRA for the CMT are shown on Figure 4.

### **Acknowledgements**

This study is a part of the project “Ceyhan Marine Terminal Ballast Water Risk Assessment” conducted by TUBITAK MRC Environment Institute and supported by Baku-Tbilisi Ceyhan Pipeline Company.

### **REFERENCES**

1. *Hilliard, Rob., Clarke, C., Stevens, C., Polglaze, J. and C. T.Hayes* (2003), Ballast Water Risk Assessment (Activity 3.1), User Guide (v1.4), GEF/UNDP/IMO, Global Ballast Water Management Programme (GloBallast), for the BWRA Database/ GIS System.
2. *Olgun, A., Avaz, G., Dönertaş, A. S., Aydöner, C., Bozkaya Ş., Pekdemir, E. A., Murat, S., Oral, N., Başar, E., Feyzioğlu, M.* and et al..(2009), The Control and Management of Harmful Aquatic Organisms Transported by Ballast Water, Project Report, TUBITAK-Marmara Research Center-Environment Institute, ÇE.09.10.
3. *Olgun, A., Avaz,G, Bozkaya, Ş., Aydöner, C ve A. Dönertaş*, “Ceyhan Marine Terminal Ballast Water Risk Assessment-3 and potential Invasive Species in İskenderun Bay”, Project Report, ÇE.10.48, 15/09/2010.

**Global R&D Forum on Ballast Water Management**  
**“Compliance monitoring and enforcement: the next R&D Challenge”**  
**Istanbul, Turkey**  
**26-28 October 2011**

Closing remarks by Mr. Jo Espinoza-Ferrey  
Director, Marine Environment Division, IMO

Colleagues and friends,  
Ladies and Gentlemen,

As we conclude this fourth IMO-GloBallast R&D Forum on Ballast Water Management, we can look back at a very successful event designed to let us all take stock of where we are today, in terms of our capacity to monitor and enforce compliance with the Ballast Water Management Convention, and if the current R&D efforts are sufficient and also in alignment with what is needed.

It has been a very busy week, with activities spanning the entire ballast water management field. The test facilities met first and came ever closer to the signing of an MOU on the establishment of the GloBalTestNet. Through their commitment to improve and harmonize the testing and reporting of ballast water treatment technologies, the world's test facilities are showing leadership and vision, and we should all encourage them to continue their efforts towards a global network which will be extremely valuable not only to the test facilities themselves, but also to those who will buy the systems, as well as the wider ballast water management community.

Next, we had the Shipbuilders' Forum. This was an opportunity for dialogue among a wide range of stakeholders, and I hope this exchange of ideas continues long after this week's activities. The future entry into force of the Convention puts great responsibility on the ship



owners, shipbuilders and ship repair yards, and dialogue amongst them will be crucial in meeting the deadlines for installation and retrofitting of technologies onboard ships.

Over the last three days, the R&D Forum itself saw cutting-edge presentations and challenging discussions. We have heard about technical and regulatory aspects of compliance monitoring and enforcement, and various ideas on how to meet the challenge. In addition, we were able to appreciate the progress that has been made in the continuous development of ballast water treatment systems.

I am sure that the stimulating discussions and cooperative spirit of this week will continue even after we have, reluctantly, left the beautiful city of Istanbul and returned to our respective countries. We have all learnt a great deal, both in terms of developing solutions to treat ballast water, but also when it comes to testing, verifying and monitoring compliance with the Convention.

This Forum, in the series of IMO-GloBallast R&D conferences on Ballast Water Management, also illustrated another important fact; that continuous innovation and collaborative R&D efforts have been, and will continue to be, instrumental to the success of the global efforts to address marine biosafety issues in general and ballast water issues, specifically. It has, therefore, been very encouraging to see that all of you – representing the majority of the world's expertise on Ballast Water Management from the shipping industry, academia and Administrations – chose to come to Istanbul for this, our Forum, **your** Forum. This is a great vote of confidence for our joint determination to meet the challenges ahead of us, and it shows what we can accomplish, in the maritime sector, when we work together towards a common goal.

This R&D Forum could not have come at a better time. IMO has been actively seeking a solution to the ballast water issue since the late 1980s — first, through the adoption of voluntary guidelines and, later, through the adoption of the Convention in February 2004. As you know, we have already met the requirements for the Convention's entry into force when it comes to the number of contracting Parties. I sincerely hope it will not be long until we also

meet the tonnage criteria, 35% of the world's merchant tonnage, after which the Convention will enter into force within twelve months.

But regardless of when that happens, this will not be an end-point. The work of IMO continues through our committees and sub-committees, our Integrated Technical Cooperation Programme, the Biosafety Section of the Secretariat itself, as well as the GloBallast Programme and the Global Industry Alliance. A Convention is a living instrument, and we will continue to work with our Member States, intergovernmental and non-governmental organizations and all our other partners to ensure that the transfer of invasive alien species, through the pathway of ships, is reduced and ultimately eliminated. In this respect, you may know that the Organization is also pursuing the other vector for transferring invasive species by ships – hull fouling. In fact, as a first but significant step, the latest meeting of the Marine Environment Protection Committee, held at IMO in July this year, adopted the 2011 Guidelines for the control and management of ships' biofouling to minimize the transfer of invasive aquatic species.

Ladies and Gentlemen, allow me to conclude by thanking those that have been involved in the lead up to and coordination of this very busy week of activities, and I know that you are many. Preparations for the various activities started almost a year ago and, since then, a number of people in several organisations have worked together to make sure that it came to fruition.

First and foremost, allow me to thank our hosts, the Government of the Republic of Turkey, for having the vision to embrace this extremely important and timely Forum. I would, in particular, single out the Turkish Prime Ministry's Undersecretariat for Maritime Affairs and the Scientific and Technological Research Council of Turkey, for the coordination of all of the events, for making all the logistical arrangements and for their very generous hospitality. In this regard, special mention should be made of Mr. Murat Korçak from the Undersecretariat for Maritime Affairs, and Dr. Arzu Olgun and Dr. Özen Arlı from TUBITAK, for their outstanding and relentless dedication during the preparations. Thank you very much, and our

thanks go also to all of your colleagues who have been involved in the preparations for this week.

I would also like to thank our other partners in this week's events — the International Chamber of Shipping and the Institute for Marine Engineering, Science and Technology, for their support during the organization and promotion of these activities.

I cannot close without thanking my colleagues in the Marine Environment Division of IMO for their hard work – the GloBallast Partnerships Project Coordination Unit with Jose Matheickal, Fredrik Haag and AichaCherif, as well as DanduPughiuc and the Biosafety Section. I know that they have been working on the preparations for this week's activities for a long time, and I am sure that they are extremely pleased to see the excellent fruit of all this work during this highly successful week.

Ladies and Gentlemen,

As I now officially close this Forum, my final vote of thanks goes to all of you who made the effort to join us here in Istanbul this week – fellow participants, exhibitors, presenters and keynote speakers. Allow me, once again, to commend your dedication to the ballast water management issue and the fight against the transfer of harmful aquatic organisms and pathogens. Your efforts, your resourcefulness and your determination to find solutions to this threat against the world's oceans and seas have shown what is possible to accomplish when we all work together. Let us keep up these efforts in the months to come so that we are ready when the Convention enters into force.

With that, I would like to acknowledge all of you for your active participation in the R&D Forum and the pre-conference workshops. I look forward to seeing you at the next R&D Forum, and I wish you all a safe trip home.



**THE SCIENTIFIC AND TECHNOLOGICAL RESEARCH COUNCIL OF TURKEY**  
**MARMARA RESEARCH CENTER**  
**(TUBITAK - MRC)**

TUBITAK-The Scientific and Technological Research Council of Turkey is the leading agency for management, funding and conduct of research in Turkey. It was established in 1963 with a mission to advance science and technology, conduct research and support Turkish researchers.

It was established in 1963 with a mission to advance science and technology, conduct research and support Turkish researchers. TÜBİTAK is responsible for promoting, developing, organizing, conducting and coordinating research and development in line with national targets and priorities.

More than 1,500 researchers work in 15 different research institutes of TÜBİTAK where contract research as well as targeted and nation-wide research is conducted.

Marmara Research Center (MRC) was found in 1968 under the fold of TUBITAK and its activities started in 1972. MRC has a proven record of supplying technical assistance to industry and local government on many different levels. Originally intended as a platform to allow Turkish industry access to current technology and applications, the Center has expanded to a level where internationally accredited research and development is routinely undertaken. The accumulated knowledge and experience base together with the extensive facilities available within the Center are made accessible to clients under one of several possible research and collaboration schemes. The multi-disciplinary nature of the Center provides a breadth of coverage of scientific skill unmatched by many other organizations.





## **GloBallast Partnerships**

*Following the success of the original Global Ballast Water Management Project, known as 'GloBallast', The International maritime Organization (IMO) has again joined forces with the Global Environment Facility (GEF), the United Nations Development Programme (UNDP), Member Governments and the shipping industry to implement a five-year follow-up project, to sustain the global momentum in tackling the ballast water problem and to catalyze innovative global partnerships to develop solutions.*

The main aim of GloBallast Partnerships (GBP) is to assist developing countries to reduce the risk of aquatic bio-invasions mediated by ships' ballast water and sediments. The project is being implemented by UNDP and executed by IMO, under the GEF International Waters portfolio, using a multicomponent, multi-tiered approach involving global, regional and country-specific partners, representing government, industry and non-governmental organizations (NGOs):

- A global component, managed through a Programme Coordination Unit at IMO in London, providing inter national coordination and information dissemination, including the development of tool - kits and guidelines, and establishing a strong co-operation with industry and NGOs.
- A regional component, providing regional coordination and harmonization, information sharing, training, and capacity building in the application of ballast water management tools and guidelines.
- A significant country component to initiate legal, policy and institutional reforms to address the issue and to implement the International Convention for the Control and Management of Ships' Ballast Water and Sediments. In fact, 13 countries, from 5 high priority regions, are taking a lead partnering role focusing especially on legal, policy and institutional reform. All told, more than 70 countries, in 14 regions, across the globe are directly or indirectly participating and benefiting from the Project.





## **The International Maritime Organization (IMO)**

The International Maritime Organization (IMO) is the specialized agency of the United Nations with responsibility for ensuring that lives at sea are not put at risk and that the environment is not polluted by international shipping. The Convention establishing IMO was adopted in 1948 and IMO first met in 1959. IMO's 168 member States use IMO to develop and maintain a comprehensive regulatory framework for shipping. IMO has adopted more than 50 Conventions, covering safety, environmental concerns, legal matters, technical co-operation, maritime security and the efficiency of shipping. IMO's main Conventions are applicable to almost 100% of all merchant ships engaged in international trade.

For more information about IMO please contact us or refer to our website below:

International Maritime Organization  
4 Albert Embankment  
London SE1 7SR  
United Kingdom  
Tel: +44 (0)20 7735 7611  
Fax: +44 (0)20 7587 3210  
Email: [info@imo.org](mailto:info@imo.org)  
Web: [www.imo.org](http://www.imo.org)







## **Undersecretariat for Maritime Affairs**

UMA-Turkish Prime Ministry Undersecretariat for Maritime Affairs is the maritime administration that is responsible for establishing ballast water management issues for Turkey.

---



# Ballast Water Management Systems

