

SHARP

**OPERATION MANUAL
AND
COOKBOOK**



Carousel®
MICROWAVE OVEN

MODELS **R-395Y(S)/(BK)** (J)

SHARP WARRANTY

Consumer Electronic Products

Congratulations on Your Purchase!

This Sharp product is warranted against faults in materials and manufacture for a period of twelve(12) months from the date of original purchase.

If service is required during the warranty period, please contact your nearest Sharp Approved Service Centre. These repairs would be carried out at no charge to the owner, subject to the conditions specified herein.

The owner is responsible for any transportation and insurance costs if the product has to be returned for repair.

This warranty does not extend to accessories or defects or injuries caused by or resulting from causes not attributable to faulty parts or the manufacture of the product, including but not limited to, defect or injury caused by or resulting from misuse, abuse, neglect, accidental damage, improper voltage, liquid spillage, vermin infestation, software, or any alterations made to the product which are not authorised by Sharp.

Please retain your sales documentation, as this should be produced to validate a warranty claim.

This warranty is in addition to and in no way limits, varies or excludes any express and implied rights and remedies under any relevant legislation in the country of sale.

IMPORTANT DO NOT RETURN THIS DOCUMENT TO SHARP

For your reference, please enter the particulars of your purchase below and retain, with your purchase documentation.

Model No. _____

Serial No. _____

Date of Purchase _____

Retailer _____

SHARP
SHARP CORPORATION OF AUSTRALIA PTY LIMITED
ABN 40 003 039 405
1 Huntingwood Drive
Huntingwood NSW 2148
SHARP CORPORATION OF NEW ZEALAND LIMITED
59 Hugo Johnson Drive
Penrose, Auckland

IMPORTANT NOTICE: This warranty applies only to products sold in Australia & New Zealand

SHARP

FOR LOCATION ENQUIRIES WITHIN

AUSTRALIA

REGARDING YOUR LOCAL

SHARP APPROVED SERVICE CENTRE

VISIT OUR WEBSITE AT

www.sharp.net.au

OR CALL SHARP CUSTOMER CARE

1300 135 022

(LOCAL CALL COST APPLY WITHIN AUSTRALIA)

SHARP CORPORATION OF AUSTRALIA PTY LTD

SHARP

FOR LOCATION ENQUIRIES WITHIN

NEW ZEALAND

REGARDING YOUR LOCAL

SHARP APPROVED SERVICE CENTRE

VISIT OUR WEBSITE AT

www.sharp.net.nz

CONTACT YOUR SELLING DEALER/RETAILER

OR CALL

SHARP CUSTOMER SERVICES

TELEPHONE: 09 573 0111

FACSIMILE: 09 573 0113

SHARP CORPORATION OF NEW ZEALAND LIMITED

INTRODUCTION

SHARP®

INFO DISPLAY COOKING SYSTEM

Thank you for buying a Sharp Microwave Oven. Your new oven has an "Information Display System" which offers you step-by-step instructions to easily guide you through each feature.

We strongly recommend however that you read this operation manual thoroughly before operating your oven, paying particular attention to the safety warnings and special notes.

The manual is divided into two sections:

1. OPERATION (P2~P23)

This section describes your oven and teaches you how to use all the features.

2. COOKING GUIDE

This section is at the back of the manual, it contains the more commonly used information such as how to prepare food, which cooking utensil to use, standing time.

It also contains recipes for automatic cooking and manual cooking.

Please take some time to read your operation manual carefully, the automatic cooking menus programmed into your new oven have been carefully developed to give optimum results when the step by step instructions are followed.

When selecting another home appliance, please again consider our full range of Sharp products.

CONTENTS page

Warranty	Inside of front cover
Introduction	1
Important Safety Instructions	2
Special Notes and Warning	4
Installation Instructions	5
Oven Diagram	5
Operation of Touch Control Panel	6
Control Panel Display	6
Touch Control Panel Layout	6
Before Operating	7
Getting Started	7
Clock Setting	7
Stop/Clear	7
To Cancel a Programme During Cooking	7
Manual Operations	8
Microwave Time Cooking	8
Sequence Cooking	9
Instant Cook	9
Increasing Time During a Cooking Programme	10
Automatic Operations	11
Notes for Automatic Operations	11
Sensor Instant Action	11
Sensor Cook	12
Quick and Easy Meals	13
Melt/Soften	14
Express Defrost	15
Easy Defrost	16
Other Convenient Features	17
Less/More Setting	17
Timer	18
Info	19
Alarm	22
Care and Cleaning	23
Service Call Check	23
Specifications	23
Cooking Guides	①-⑳
Quick Reference Guide	See last page

IMPORTANT SAFETY INSTRUCTIONS

IMPORTANT SAFETY INSTRUCTIONS : READ CAREFULLY AND KEEP FOR FUTURE REFERENCE.

This oven is designed to be used on a countertop, in a cabinet or built-in. See page 5 for the installation instructions.

Ensure there is a minimum of free space above the oven of 15 cm. See page 5 for the other necessary spaces.

This appliance is not intended for use by persons (including children) with reduced physical, sensory or mental capabilities, or lack of experience and knowledge, unless they have been given supervision or instruction concerning use of the appliance by a person responsible for their safety.

Children should be supervised to ensure that they do not play with the appliance.

WARNING: Only allow children to use the oven without supervision when adequate instructions have been given so that the child is able to use the oven in a safe way and understands the hazards of improper use.

WARNING: If the door or door seals are damaged, the oven must not be operated until it has been repaired by an authorised SHARP service agent or microwave technician.

WARNING: Never adjust, repair or modify the oven yourself. It is hazardous for anyone other than an authorised SHARP service agent or microwave technician to carry out any service or repair operation which involves the removal of a cover which gives protection against exposure to microwave energy.

If the power supply cord of this appliance is damaged, it must be replaced with a special cord. The exchange must be made by a service centre approved by SHARP.

WARNING: Liquids and other foods must not be heated in sealed containers since they are liable to explode.

Microwave heating of beverages can result in delayed eruptive boiling, therefore care must be taken when handling the container.

Do not cook eggs in their shells, and whole hard boiled eggs should not be heated in microwave ovens since they may explode even after microwave cooking has ended. To cook or reheat eggs which have not been scrambled or mixed, pierce the yolks and the whites, or the eggs may explode. Shell and slice hard boiled eggs before reheating them in the microwave oven.

Utensils should be checked to ensure that they are suitable for use in the oven. See Page ②. Use only microwave safe containers and utensils on microwave modes.

The contents of feeding bottles and baby food jars must be stirred or shaken and the temperature checked before consumption, in order to avoid burns.

When heating food in plastic or paper containers, keep an eye on the oven due to the possibility of ignition.

If smoke is observed, switch off or unplug the oven and keep the door closed in order to stifle any flames.

The oven should be cleaned regularly and any food deposits removed.

Failure to maintain the oven in a clean condition could lead to deterioration of the surface that could adversely affect the life of the appliance and possibly result in a hazardous situation.

See instructions for cleaning door seals, cavities and adjacent parts on page 23.

Other warnings

1. To reduce the risk of fire in the oven cavity:
 - a. Do not overcook food.
 - b. Remove wire twist-ties from paper or plastic bags before placing bag in the oven.
 - c. Do not heat oil or fat for deep frying. The temperature of the oil cannot be controlled.
2. To reduce the risk of an explosion or delayed eruptive boiling when handling the container.

Your microwave oven is capable of heating food and beverages very quickly therefore, it is very important that you select the appropriate cooking time and power level for the type and quantity of food to be heated. If you are unsure of the cooking time and power level required, begin with low cooking times and power levels until the food is sufficiently heated evenly throughout.

Additionally:

 - a. Do not place sealed containers in the oven. Babies bottles fitted with a screw cap or teat are considered to be sealed containers.
 - b. Do not use excessive amount of time.
 - c. When boiling liquids in the oven, use a wide-mouthed container.
 - d. Stand at least for 20 seconds at the end of cooking to avoid delayed eruptive boiling of liquids.
 - e. Stir the liquid before and during cooking. Use extreme care when handling the container or inserting a spoon or other utensil into the container.

3. This oven is for home food preparation only and should only be used for heating, cooking and defrosting food and beverage.
It is not suitable for commercial, laboratory use, or heating therapeutic devices eg. Wheat bags.
4. Never operate the oven whilst any object is caught or jammed between the door and the oven.
5. Do not bump, or catch utensils, loose clothes and your accessories on the door safety latches when removing food from the oven.
6. Never poke an object, particularly a metal object, through a grille or between the door and the oven while the oven is operating.
7. Never tamper with or deactivate the door safety latches.
8. Always use oven gloves to prevent burns when handling utensils that are in contact with hot food. Enough heat from the food can transfer through utensils to cause skin burns.
9. If the oven lamp fails please consult your dealer or a qualified service technician trained by SHARP.
10. Avoid steam burns by directing steam away from the face and hands.
Slowly lift the furthest edge of a dish's cover including microwave plastic wrap etc., and carefully open popcorn and oven cooking bags away from the face.
11. Make sure that the power supply cord is undamaged, and that it does not run under the oven or over any hot surfaces or sharp edges.
12. To prevent the turntable from breaking:
 - a. Before cleaning the turntable with water, leave the turntable to cool.
 - b. Do not place anything hot on a cold turntable.
 - c. Do not place anything cold on a hot turntable.
13. Do not place anything on the outer cabinet.
14. Do not store food or any other items inside the oven.
15. Make sure the utensil does not touch the interior walls during cooking.

SPECIAL NOTES AND WARNING

	DO	DON'T
Eggs, fruits, nuts, seeds, vegetables, sausages and oysters	<ul style="list-style-type: none"> * Puncture egg yolks and whites and oysters before cooking to prevent "explosion". * Pierce skins of potatoes, apples, squash, hot dogs, sausages and oysters so that steam escapes. 	<ul style="list-style-type: none"> * Cook eggs in shells. This can cause the egg to "explode", which may damage the oven or cause injury to yourself. * Cook hard/soft boiled eggs. * Overcook oysters. * Dry nuts or seeds in shells.
Popcorn	<ul style="list-style-type: none"> * Use specially bagged popcorn for the microwave oven. * Listen while popping corn for the popping to slow to 1-2 seconds. 	<ul style="list-style-type: none"> * Pop popcorn in regular brown bags or microwave safe glass bowls. * Exceed maximum time on popcorn package.
Baby food	<ul style="list-style-type: none"> * Transfer baby food to small dish and heat carefully, stirring often. Check for suitable temperature to prevent burns. * Remove the screw cap and teat before warming baby bottles. After warming shake thoroughly. Check for suitable temperature. 	<ul style="list-style-type: none"> * Heat disposable bottles. * Overheat baby bottles. Only heat until warm. * Heat bottles with nipples on. * Heat baby food in original jars.
General	<ul style="list-style-type: none"> * Food with filling should be cut after heating, to release steam and avoid burns. * Use a deep microwave safe glass bowl when cooking liquids or cereals to prevent boiling over. 	<ul style="list-style-type: none"> * Heat or cook in closed glass jars or air tight containers. * Deep fat fry. * Heat or dry wood, herbs, wet papers, clothes or flowers. * Operate the oven without a load (i.e. an absorbing material such as food or water) in the oven cavity.
Liquids (Beverages)	<ul style="list-style-type: none"> * For boiling or cooking liquids see IMPORTANT SAFETY INSTRUCTIONS on page 2 to prevent explosion and delayed eruptive boiling. 	<ul style="list-style-type: none"> * Heat for longer than recommended time. See REHEATING-FOOD CHART on page 25.
Canned foods	<ul style="list-style-type: none"> * Remove food from can. 	<ul style="list-style-type: none"> * Heat or cook food while in cans.
Sausage rolls, Pies, Christmas pudding	<ul style="list-style-type: none"> * Cook for the recommended time. (These foods have high sugar and/or fat contents.) 	<ul style="list-style-type: none"> * Overcook as they may catch fire.
Meats	<ul style="list-style-type: none"> * Use a microwave proof roasting rack to collect drained juices. 	<ul style="list-style-type: none"> * Place meat directly on the turntable for cooking.
Utensils	<ul style="list-style-type: none"> * Check the utensils are suitable for MICROWAVE cooking before you use them. 	<ul style="list-style-type: none"> * Use metal utensils for MICROWAVE cooking. Metal reflects microwave energy and may cause an electrical discharge known as arcing.
Aluminium foil	<ul style="list-style-type: none"> * Use to shield food to prevent over cooking. * Watch for sparking. Reduce foil or keep clear of cavity walls. 	<ul style="list-style-type: none"> * Use too much. * Shield food close to cavity walls. Sparking can damage the cavity.
Browning dish	<ul style="list-style-type: none"> * Place a suitable insulator such as a microwave and heat proof dinner plate between the turntable and the browning dish. 	<ul style="list-style-type: none"> * Exceed the preheating time recommended by the manufacturer. Excessive preheating can cause the glass turntable to shatter and/or damage internal parts of the oven.

INSTALLATION INSTRUCTIONS

1. Remove all packing materials from the oven cavity, **(do not remove the waveguide cover)**, and the feature sticker from the outside of the door, if there is one. Check the unit for any damage, such as a misaligned door, damaged door seals around the door or dents inside the oven cavity or on the door. If there is any damage, please do not operate the oven until it has been checked by a **SERVICE CENTRE APPROVED BY SHARP** and repaired, if necessary.
2. Accessories provided
 - 1) Turntable 2) Roller stay 3) Operation manual and Cook book
3. Place the roller stay in the coupling on the oven floor, then place the turntable on to the roller stay, ensuring it is located firmly. Refer to **OVEN DIAGRAM** below. **NEVER** operate the oven without the roller stay and turntable.
4. This oven is designed to be used on a countertop, in a cabinet or built-in. It should not be installed in any area where excessive heat and steam are generated, for example, next to a conventional oven unit. The oven should be installed so as not to block ventilation openings.
 Allow a space of at least 15cm on the top, 10cm on both sides and 5cm at the rear of the oven for adequate air circulation. When installing in a cabinet, the minimum inside dimension of the cabinet should be 720mm(W) x 460mm(H) x 498mm(D).
 When building the oven into a cabinet or wall, a Sharp built-in kit model number RK-J39S (stainless steel), is available which enables the microwave oven to be integrated within a kitchen. The kit is available from your retailer. Read carefully the installation instructions for the built-in kit before installation. This built-in kit has been tested according to Australian Standards. Sharp does not recommend the use of any other built-in kit. If the oven is to be positioned near a conventional oven, ensure that adequate space is allowed, and a suitable heat shield is incorporated between the two to prevent damage to the oven and the built-in kit caused by heat.
WARNING: The electrical outlet must be readily accessible so that the unit can be unplugged easily in an emergency.
5. Neither the manufacturer nor the distributors can accept any liability for damage to the machine or personal injury for failure to observe the correct electrical connecting procedure.
 The A.C. voltage must be single phase 230 – 240V, 50Hz.
6. This appliance must be earthed.
7. Operate the oven from a general purpose domestic outlet.
 If a generator is used, do not operate the oven with non-sinusoidal outputs.

OVEN DIAGRAM

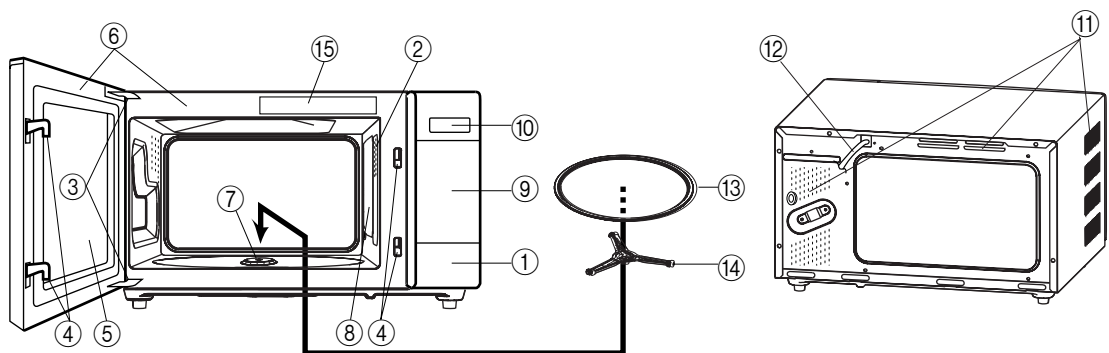

- | | |
|------------------------------------|-------------------------------------|
| 1. Door open button | 9. Touch control panel (See page 6) |
| 2. Oven lamp | 10. Liquid crystal display |
| 3. Door hinges | 11. Ventilation openings |
| 4. Door safety latches | 12. Power supply cord |
| 5. See through door | 13. Turntable |
| 6. Door seals and sealing surfaces | 14. Roller stay |
| 7. Coupling | 15. Menu label |
| 8. Waveguide cover (Do not remove) | |

OPERATION OF TOUCH CONTROL PANEL

The operation of the oven is controlled by pressing the appropriate pads arranged on the surface of the control panel.

An entry signal tone should be heard each time you press the control panel to make a correct entry.

In addition an audible signal will sound for approximately 2 seconds at the end of the cooking cycle, or 4 times when cooking procedure is required.

Control Panel Display



Touch Control Panel Layout

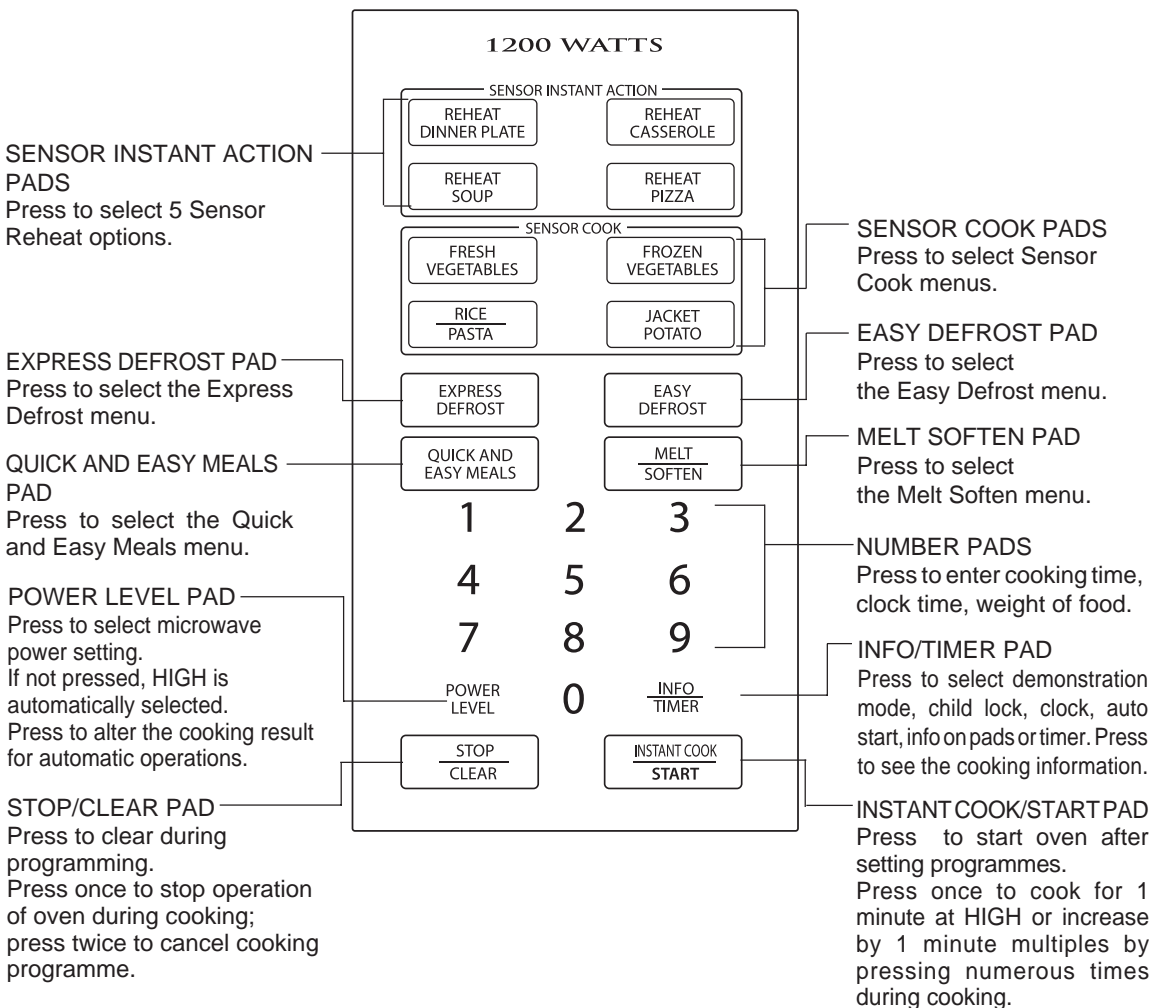

BEFORE OPERATING

* This oven is preset with the INFORMATION GUIDE.

To assist you in operating your oven, useful information will appear on the display.

In this manual, the display information guide is abbreviated.

Getting Started

Step	Procedure	Pad Order	Display
1	Plug the oven into a power point and switch on the power. Ensure the oven door is closed.		MICRO- WAVE OVEN
2	Press the STOP/CLEAR pad.	STOP CLEAR	. 0

Clock Setting

* To enter the present time of day 11:34 (AM or PM).

Step	Procedure	Pad Order	Display
1	Press the INFO/TIMER pad and the number 3.	INFO TIMER 3	CLOCK ENTER TIME
2	Enter the correct time of day by pressing the numbers in sequence.	1 1 3 4	11:34 HELP The dots (:) will flash on and off.
3	Press the INSTANT COOK/START pad.	INSTANT COOK START	11:34

This is a 12 hour clock. If you attempt to enter an incorrect clock time (eg. 13:45), **ERROR** will appear in the display. Press the STOP/CLEAR pad and re-enter the time of day (eg. 1:45).

Stop/Clear

Press the STOP/CLEAR pad once to:

1. Stop the oven temporarily during cooking.
2. Clear if you make a mistake during programming.

To Cancel a Programme During Cooking

Press the STOP/CLEAR pad twice.

MANUAL OPERATIONS

Microwave Time Cooking

This is a manual cooking feature, first enter the cooking time then the power level.

There are eleven different power levels. You can programme up to 99 minutes, 99 seconds.





This variable cooking control allows you to select the rate of microwave cooking.

After cooking, the fan will continue to operate. COOLING may be displayed when the door is opened or STOP/CLEAR pad is pressed while fan is operating.

Display	Power level		Examples
100P	100%	High	Raw meat, Vegetables, Rice or Pasta
90P	90%		
80P	80%		
70P	70%	Medium High	Delicate Food such as Eggs or Seafood.
60P	60%		
50P	50%	Medium	
40P	40%		
30P	30%	Medium Low	Defrost, Softening butter
20P	20%		
10P	10%	Low	Keep food warm
0P	0%		







If a power level is not selected, then 100% power is automatically used.

* Suppose you want to time cook for 2 minutes 30 seconds on 100% power.

Step	Procedure	Pad Order	Display
1	Enter desired cooking time.		
2	Press the INSTANT COOK/START pad.		 The timer begins to count down.

To lower the power press the POWER LEVEL pad until desired power level is displayed.

* Suppose you want to cook Fish Fillets for 10 minutes on 50% power.

Step	Procedure	Pad Order	Display
1	Enter desired cooking time.		
2	Select power level by pressing the POWER LEVEL pad as required (for 50% press six times).	 x 6	
3	Press the INSTANT COOK/START pad.		 The timer begins to count down.

If the door is opened during cooking process, the cooking time in the readout automatically stops. The cooking time starts to count down again when the door is closed and the INSTANT COOK/START pad is pressed.

Sequence Cooking

Your oven can be programmed with up to 3 automatic cooking sequences, automatically switching from one variable power setting to the next.

* Suppose you want to cook for 10 minutes on 50% followed by 3 minutes on 100%.

Step	Procedure	Pad Order	Display
1	Enter desired cooking time.		
2	Select desired power level by pressing the POWER LEVEL pad (for 50% press six times).	 x 6	
3	For second sequence, enter desired cooking time. If power is not selected, the oven will operate at 100% power.		
4	Press the INSTANT COOK/START pad.		 The timer begins to count down to zero. When it reaches zero, the second sequence will appear and the timer will begin counting down to zero again.

Instant Cook™

For your convenience Sharp's Instant Cook allows you to easily cook for one minute on 100% power.

Step	Procedure	Pad Order	Display
1	Press the INSTANT COOK/START pad. Within 3 minutes of closing the door, cooking completion or pressing the STOP/CLEAR pad.		 The timer begins to count down.

Press the INSTANT COOK/START pad until desired time is displayed.
Each time the pad is pressed, the cook time is increased by 1 minute.

Increasing Time During a Cooking Programme

Microwave time can be added during a manual cooking programme using the INSTANT COOK/START pad.

* Suppose you want to increase the cooking time by 2 minutes during 5 minutes on 50% power cooking. (at the moment the remaining cooking time is 1 min. 30 sec.)

Step	Procedure	Pad Order	Display
1	Enter desired cooking time.	5 0 0	5.00
2	Select power level by pressing the POWER LEVEL pad as required (for 50% press six times).	POWER LEVEL x 6	5.0P
3	Press the INSTANT COOK/START pad.	INSTANT COOK START	5.00 COOK The timer starts to count down. 1.30 COOK
4	Press the INSTANT COOK/START pad twice to increase the cooking time by two minutes.	INSTANT COOK START x 2	3.30 COOK

AUTOMATIC OPERATIONS

Notes for Automatic Operations

- Wipe off any moisture from the outside of cooking containers and the interior of the oven with a dry cloth or paper towel prior to cooking on any SENSOR INSTANT ACTION or SENSOR COOK menus.
- After oven is plugged in, wait 2 minutes before using SENSOR INSTANT ACTION or SENSOR COOK menus.
- When cooking small quantities of food on SENSOR INSTANT ACTION or SENSOR COOK menus, the food may be cooked without displaying any remaining cooking time or requiring any operations during the cooking.
- When using the automatic features, carefully follow the instructions provided in each MENU GUIDE to achieve the best result.
If the instructions are not followed carefully, the food may be overcooked or undercooked or **ERROR** may be displayed.
- Food weighing more or less than the quantity or weight listed in each MENU GUIDE, cook manually. Refer to manual cooking charts in RECIPES section.
- To change the final cooking or defrosting result from the standard setting, press the POWER LEVEL pad once (for more) or twice (for less) after selecting desired setting. Refer to page 17.
- The final cooking result will vary according to the food condition (e.g. initial temperature, shape, quality). Check the food after cooking and if necessary continue cooking manually.
- To avoid children's misuse, each SENSOR INSTANT ACTION pad can be used only within 3 minutes of a preceding operation.
- To defrost foods above or below the weights allowed on the EXPRESS DEFROST MENU GUIDE, use EASY DEFROST or defrost manually.
- ERROR** will be displayed if:
more or less than weight of foods suggested in EASY DEFROST MENU GUIDE or MELT/SOFTEN MENU GUIDE is programmed when the INSTANT COOK/START pad is pressed.
To clear, press the STOP/CLEAR pad and reprogramme.
- When entering the weight of the food, round off the weight to the nearest 0.1kg(100g). For example, 1.65kg would become 1.7kg. When entering the weight of Butter, Chocolate and Cream Cheese, round off the weight to the nearest 0.01kg (10g).
- After cooking, the fan will continue to operate. COOLING may be displayed when the door is opened or STOP/CLEAR pad is pressed while fan is operating.

Sensor Instant Action

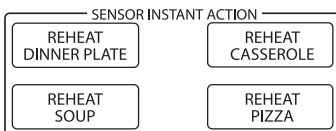

SENSOR INSTANT ACTION will automatically compute the power level and cooking time. SENSOR INSTANT ACTION has 5 reheat options. To select a menu, press the desired SENSOR INSTANT ACTION pad. Follow the instructions provided in the SENSOR INSTANT ACTION MENU GUIDE on page ③ of the cooking guide.

* Suppose you want to reheat 1 Dinner Plate.

Step	Procedure	Pad Order	Display
1	<p>Press the REHEAT DINNER PLATE pad.</p> <p>* When the sensor detects the vapour from the food, the remaining reheating time will appear. (eg. remaining reheating time is approximately 25 sec.)</p>	<p>REHEAT DINNER PLATE</p> <p>x 1</p>	<p>DINNER PLATE SENSOR HELP SENSOR HELP</p> <p>↓ After about 2 sec.</p> <p>DINNER PLATE COOK SENSOR HELP COOK SENSOR HELP</p> <p>SENSOR REHEAT COOK SENSOR HELP COOK SENSOR HELP</p> <p>.25 COOK SENSOR HELP</p> <p>The timer begins to count down. When the cooking time reaches zero, STAND, COVERED, 5MIN will be displayed.</p>

NOTE:

When using REHEAT SOUP pad, press once for Thin Soup, press twice for Thick Soup.

Sensor Cook

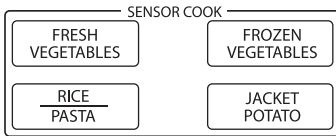

FRESH VEGETABLES
 1. Hard Vegetables
 2. Soft Vegetables









FROZEN VEGETABLES
 1. Mixed Small Vegetables
 2. Mixed Chunky Vegetables

RICE/PASTA
 1. White Rice
 2. Dry Pasta
 3. Fresh Pasta
 4. Frozen Pasta

JACKET POTATO
 1. Jacket Potato

SENSOR COOK will automatically compute the power level and cooking time. SENSOR COOK has 4 categories. To select a menu, press the desired SENSOR COOK pad until the menu of your choice is displayed. Follow the instructions provided in the SENSOR COOK MENU GUIDE on pages ④ - ⑤ of the cooking guide.

* Suppose you want to use Sensor Cook to cook 2 Jacket Potatoes.

Step	Procedure	Pad Order	Display
1	Press the JACKET POTATO pad once.	 x 1	
2	Press the INSTANT COOK/START pad. * When the sensor detects the vapour from the food, the remaining cooking time will appear. (eg. remaining cooking time is approximately 3 min. 30 sec.)		    The cooking time will begin counting down. The oven will "beep" 4 times and will stop. TURN, OVER will be displayed.
3	Open the door. Turn over potatoes. Close the door.		PRESS, START will be displayed.
4	Press the INSTANT COOK/START pad.		 The cooking time will begin counting to zero, when it reaches zero, the oven will "beep". STAND, COVERED, 3-10MIN, FOIL will be displayed repeatedly.





Quick and Easy Meals

QUICK AND EASY MEALS

1. Garlic Prawns
2. Fish in Chinese Cabbage Leaves
3. San Choy Bau
4. Spinach and Ricotta Cannelloni
5. Chicken Cacciatore
6. Lemon Fish Fillets

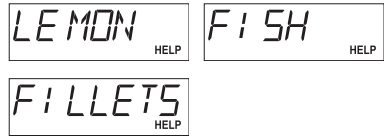
QUICK AND EASY MEALS allows you to cook 6 popular recipes. Follow the instructions provided in the QUICK AND EASY MEALS RECIPES on pages ⑥ - ⑦ of the cooking guides.

* Suppose you want to cook Lemon Fish Fillets.

Step	Procedure	Pad Order	Display
1	Press the QUICK AND EASY MEALS pad until the desired menu is displayed (for Lemon Fish Fillets press six times).	 x 6	
2	Press the INSTANT COOK/START pad.		 The cooking time will begin counting down. The oven will "beep" 4 times and will stop. TURN, OVER will be displayed repeatedly.
3	Open the door. Turn fish over. Close the door.		PRESS START will be displayed.
4	Press the INSTANT COOK/START pad.		 The cooking time will begin counting down. The oven will "beep" and will stop. STAND, COVERED, 3 MIN, GARNISH, WITH, LEMON, RIND will be displayed repeatedly.







Melt/Soften



- 1.Butter
- 2.Chocolate
- 3.Cream Cheese
- 4.Ice Cream

MELT/SOFTEN allows you to melt 4 recipes. Follow the instructions provided in the MELT/SOFTEN MENU GUIDE on page ⑧ of the cooking guides.

* Suppose you want to melt 0.2 kg Chocolate.

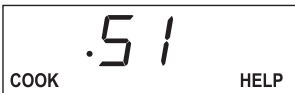
Step	Procedure	Pad Order	Display
1	Press the MELT SOFTEN pad until the desired menu is displayed (for Chocolate press twice).	 x 2	
2	Press the number pads to enter weight.		
3	Press the INSTANT COOK/START pad.		 The cooking time will begin counting down. The oven will "beep" 4 times and will stop. STIR will be displayed repeatedly.
4	Open the door. Stir. Close the door.		PRESS START will be displayed.
5	Press the INSTANT COOK/START pad.		 The cooking time will begin counting down. When it reaches zero, the oven will "beep". STIR will be displayed repeatedly.

Express Defrost

EXPRESS
DEFROST

1. Fish Fillets
2. Chicken Fillets

EXPRESS DEFROST rapidly defrosts 0.5 kg of specific foods. Follow the instructions provided in the EXPRESS DEFROST MENU GUIDE on page ⑨ of the cooking guides.

* Suppose you want to defrost 0.5 kg of Chicken Fillets.

Step	Procedure	Pad Order	Display
1	Press the EXPRESS DEFROST pad until the desired menu is displayed (for Chicken Fillets press twice).	<div style="border: 1px solid black; padding: 2px; display: inline-block;">EXPRESS DEFROST</div> x 2	<div style="display: flex; justify-content: space-around;"> <div style="border: 1px solid black; padding: 2px;">CHICKEN DEF HELP</div> <div style="border: 1px solid black; padding: 2px;">FILLETS DEF HELP</div> </div> <div style="border: 1px solid black; padding: 2px; margin-top: 5px; display: flex; justify-content: center;"> 0.5 KG DEF HELP </div>
2	Press the INSTANT COOK/ START pad.	<div style="border: 1px solid black; padding: 2px; display: inline-block;">INSTANT COOK START</div>	<div style="border: 1px solid black; padding: 5px; display: flex; justify-content: space-between;"> 5.00 DEF HELP </div> <p>COOK</p> <p>The defrosting time will begin counting down. The oven will "beep" 4 times and stop. TURN, OVER, SEPARATE, INTO, PIECES, SHIELD, WARM, PORTION will be displayed repeatedly.</p>
3	Open the door. Remove defrosted pieces, turn over remaining pieces and shield warm portion. Close the door.		<p>PRESS, START will be displayed repeatedly.</p>
4	Press the INSTANT COOK/ START pad.	<div style="border: 1px solid black; padding: 2px; display: inline-block;">INSTANT COOK START</div>	<div style="border: 1px solid black; padding: 5px; display: flex; justify-content: space-between;"> 3.00 DEF HELP </div> <p>COOK</p> <p>The defrosting time will begin counting down. When it reaches zero, the oven will "beep". STAND, COVERED, 10 MIN, FOIL will be displayed repeatedly.</p>

Easy Defrost







EASY DEFROST

1. Mince
2. Steak/Chops
3. Chicken Pieces
4. Whole Chicken
5. Roast Meat

EASY DEFROST will automatically compute the microwave power and defrosting time.

Follow the instructions provided in the EASY DEFROST MENU GUIDE on page 10 of the cooking guides.

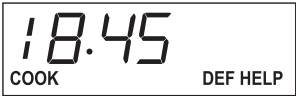
* Suppose you want to defrost 1.0 kg of Chicken Pieces.

Step	Procedure	Pad Order	Display
1	Press the EASY DEFROST pad until the desired menu is displayed (for Chicken Pieces press three times).	 x 3	
2	Press the number pads to enter weight.		
3	Press the INSTANT COOK/ START pad.		 The defrosting time will begin counting down. The oven will "beep" 4 times and stop. REMOVE, DE-, FROSTED, PORTION, TURN, OVER, SHIELD, WARM, PORITON will be displayed repeatedly.
4	Open the door. Remove defrosted pieces, turn over remaining pieces and shield warm portion. Close the door.		PRESS START will be displayed repeatedly.
5	Press the INSTANT COOK/ START pad.		 The defrosting time will begin counting down. When it reaches zero, the oven will "beep". STAND, COVERED, 5-15 MIN, FOIL will be displayed repeatedly.

OTHER CONVENIENT FEATURES

Less/More Setting

The cooking times programmed into the automatic menus are tailored to the most popular tastes. To adjust the cooking time to your individual preference use the "more" or "less" feature to either add (more) or reduce (less) cooking time.

The Less/More setting can be used to adjust the cooking time of the following features

- SENSOR INSTANT ACTION - MELT SOFTEN
- SENSOR COOK - EXPRESS DEFROST
- QUICK AND EASY MEALS - EASY DEFROST

(1) SENSOR INSTANT ACTION

To adjust cooking time press POWER LEVEL pad after pressing menu pad within 2 seconds.

* Suppose you want to reheat 1 serve of Dinner Plate for less time than the standard setting.

Step	Procedure	Pad Order	Display
1	Press the REHEAT DINNER PLATE pad once.	<div style="border: 1px solid black; padding: 5px; display: inline-block;"> REHEAT DINNER PLATE </div> x 1	<div style="display: flex; justify-content: space-around;"> <div style="border: 1px solid black; padding: 5px; text-align: center;"> DINNER <small>SENSOR HELP</small> </div> <div style="border: 1px solid black; padding: 5px; text-align: center;"> PLATE <small>SENSOR HELP</small> </div> </div>
2	Press the POWER LEVEL pad twice within 2 seconds.	<div style="border: 1px solid black; padding: 5px; display: inline-block;"> POWER LEVEL </div> x 2	<div style="border: 1px solid black; padding: 5px; text-align: center;"> LESS <small>SENSOR HELP</small> </div>

(2) SENSOR COOK/QUICK AND EASY MEALS/MELT SOFTEN/EXPRESS DEFROST/EASY DEFROST

To adjust cooking time press POWER LEVEL pad before pressing INSTANT COOK/START pad.

* Suppose you want to defrost 1.0kg of Chicken Pieces (Easy Defrost) for more time than the standard setting.





Step	Procedure	Pad Order	Display
1	Press the EASY DEFROST pad three times for Chicken Pieces.	<div style="border: 1px solid black; padding: 5px; display: inline-block;"> EASY DEFROST </div> x 3	<div style="display: flex; justify-content: space-around;"> <div style="border: 1px solid black; padding: 5px; text-align: center;"> CHICKEN <small>DEF HELP</small> </div> <div style="border: 1px solid black; padding: 5px; text-align: center;"> PIECES <small>DEF HELP</small> </div> </div> <div style="display: flex; justify-content: space-around; margin-top: 5px;"> <div style="border: 1px solid black; padding: 5px; text-align: center;"> ENTER <small>DEF HELP</small> </div> <div style="border: 1px solid black; padding: 5px; text-align: center;"> WEIGHT <small>DEF HELP</small> </div> </div>
2	Press the number pads to enter weight.	<div style="display: flex; justify-content: space-around; align-items: center;"> <div style="border: 1px solid black; padding: 5px; text-align: center; width: 30px;">1</div> <div style="border: 1px solid black; padding: 5px; text-align: center; width: 30px;">0</div> </div>	<div style="border: 1px solid black; padding: 5px; text-align: center;"> 1.0 KG <small>DEF HELP</small> </div>
3	Press the POWER LEVEL pad once.	<div style="border: 1px solid black; padding: 5px; display: inline-block;"> POWER LEVEL </div> x 1	<div style="border: 1px solid black; padding: 5px; text-align: center;"> MORE <small>DEF HELP</small> </div> <div style="display: flex; justify-content: space-around; margin-top: 5px;"> <div style="border: 1px solid black; padding: 5px; text-align: center;"> 1.0 KG <small>DEF HELP</small> </div> <div style="border: 1px solid black; padding: 5px; text-align: center;"> MORE <small>DEF HELP</small> </div> </div>
4	Press the INSTANT COOK/START pad.	<div style="border: 1px solid black; padding: 5px; display: inline-block;"> INSTANT COOK START </div>	<div style="border: 1px solid black; padding: 5px; text-align: center;"> 20.37 <small>COOK DEF HELP</small> </div>

Timer

Use this feature as a general purpose timer. Examples include:
 timing boiled eggs cooked on the stove top.
 timing the recommended standing time of food.

You can enter any time up to 99 minutes, 99 seconds. If you want to cancel the timer during the count down phase simply press STOP/CLEAR.

* Suppose you want to set the timer for 3 minutes to boil an egg on the stove top.

Step	Procedure	Pad Order	Display
1	Enter desired time.		 PRESS, START, OR, SELECT, POWER will be displayed.
Once the egg has come to the boil in the saucepan you can start the timer.			
2	Press the INFO/TIMER pad.		 The timer begins to count down. When the timer reaches zero, the oven will "beep".

Info



**INFO
TIMER**

The INFO feature has 6 different programs.

Demonstration Mode

This feature is mainly for use by retail outlets, and also allows you to practice key operations.



* To demonstrate.

Step	Procedure	Pad Order	Display
1	Press the INFO/TIMER pad.		DEMO, PRESS 1, LOCK, PRESS 2, CLOCK, PRESS 3, AUTO START, PRESS 4, INFOON, PADS, PRESS DESIRED, PAD will be displayed repeatedly.
2	Press the number 1 pad.		DEMO, MODE, TO TURN, ON, PRESS, START will be displayed repeatedly.
3	Press the INSTANT COOK/START pad.		DEMO, MICRO-, WAVE, OVEN will be displayed repeatedly.

Cooking operations can now be demonstrated with no power in the oven.



* Suppose you demonstrate Instant Cook.

After step 3 for Demonstration Mode.

Step	Procedure	Pad Order	Display
4	Press the INSTANT COOK/START pad.		 <p>The cooking time will begin counting down to zero at ten times the speed.</p>

* To cancel the Demonstration Mode.

After step 2 for Demonstration Mode.





Step	Procedure	Pad Order	Display
3	Press the INSTANT COOK/START pad.		 <p>The time of day will appear in the display.</p>

Child Lock

If the oven is accidentally started with no food or liquid in the cavity, the life of the oven can be reduced. To prevent accidents like this, your oven has a "Child Lock" feature that you can set when the oven is not in use.

* To set the Child Lock.



After step 1 for Demonstration Mode on page 19.

Step	Procedure	Pad Order	Display
2	Press the number 2 pad.		
3	Press the INSTANT COOK/START pad.		 The time of day will appear in the display.

The control panel is now locked, each time a pad is pressed, the display will show "LOCK".

* To cancel the Child Lock.

After step 2 for Child Lock.

Step	Procedure	Pad Order	Display
3	Press the INSTANT COOK/START pad.		 The time of day will appear in the display. The oven is ready to use.

Clock Setting















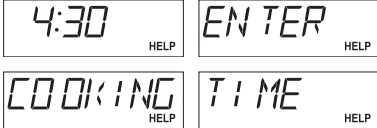

To set the present time of day. See page 7.

Auto Start

The Auto Start feature allows you to set your oven to start automatically.

* Suppose you want to start cooking a casserole for 20 minutes at 50% power level at 4:30. (AM or PM)
(Check that the correct time of day is displayed.)

After step 1 for Demonstration Mode on page 19.

Step	Procedure	Pad Order	Display
2	Press the number 4 pad.		
3	Enter the desired start time.	  	 The dots (:) will flash on and off.
4	Press the INSTANT COOK/START pad.		
5	Enter the desired cooking time.	   	
6	Set the desired cooking mode. (for microwave cooking at 50% power level, press the POWER LEVEL pad 6 times)	 x6	
7	Press the INSTANT COOK/START pad.		 The oven will start cooking at 4:30. The timer begins to count down. When the timer reaches zero, all indicators will go off and the oven will "beep".

NOTE:

If the door is opened after step 7, close the door and press the START pad to continue with Auto Start. Press the STOP/CLEAR pad to cancel Auto Start.

The correct time of day must be set before using Auto Start, see clock setting on page 7.

AUTO START can be set in manual microwave cooking only.

Info on Pads

Each pad carries useful guide.

* **To get the guide for FRESH VEGETABLES pad.** After step 1 for Demonstration Mode on page 19.

Step	Procedure	Pad Order	Display
2	Press the FRESH VEGETABLES pad.		PRESS, TO, SELECT, 1-2, PRESET, FRESH, VEGE-, TABLE, MENUS will be displayed twice.

The guide message will be repeated twice, and then the display will show the time of day.
If you want to cancel the guide, press the STOP/CLEAR pad.

Help

Each setting of Automatic Operations has a cooking hint.

If you wish to check, press the INFO/TIMER pad whenever HELP is lit in the display.

Alarm

Your oven has an alarm function. If you leave food in the oven after cooking, the oven will "beep" 3 times and REMOVE FOOD will be displayed in the display after 1 minute.

If you do not remove the food at that time, the oven will "beep" 3 times after 2 minutes and 3 minutes.

CARE AND CLEANING

Disconnect the power supply cord before cleaning or leave the door open to inactivate the oven.

CLEAN THE OVEN AT REGULAR INTERVALS - Keep the oven clean and remove any food deposits, or it could lead to deterioration of the surface. This could adversely affect the life of the appliance and possibly result in a hazardous situation.

Exterior:

The outside may be cleaned with mild soap and warm water, wipe clean with a damp cloth. Avoid the use of harsh abrasive cleaners. Keep the ventilation openings free of dust.

Door:

Wipe the door and window on both sides, the door seals and adjacent parts frequently with a damp cloth to remove any spills or splatters. Do not use abrasive cleaners.

Touch Control Panel:

Wipe the panel with a slightly dampened cloth with water only.

Do not scrub or use any sort of chemical cleaners. Avoid the use of excess water.

Interior walls:

To clean the interior surfaces, wipe with a soft cloth and warm water. After use wipe the waveguide cover in the oven with a soft damp cloth to remove any food splashes. Built-up splashes may overheat and begin to smoke or catch fire. Do not remove the waveguide cover. **DO NOT USE A COMMERCIAL OVEN CLEANER, ABRASIVE OR HARSH CLEANERS AND SCOURING PADS ON ANY PART OF YOUR MICROWAVE OVEN. NEVER SPRAY OVEN CLEANERS DIRECTLY ONTO ANY PART OF YOUR OVEN.** Avoid using excess water. After cleaning the oven, ensure any water is removed with a soft cloth.

Turntable/Roller Stay:

Wash with mild soapy water and dry thoroughly.

SERVICE CALL CHECK

Please check the following before calling for service:

1. Does the display light up? YES _____ NO _____
2. When the door is opened, does the oven lamp come on? YES _____ NO _____
3. Place one cup of water (approx. 250 ml) in a glass measure in the oven and close the door securely. Oven lamp should go off if door is closed properly. Press the INSTANT COOK/START pad once.
 - A. Does the oven lamp come on? YES _____ NO _____
 - B. Does the cooling fan work? YES _____ NO _____
(Put your hand over the rear ventilation openings.)
 - C. Does the turntable rotate? YES _____ NO _____
(The turntable can rotate clockwise or counterclockwise. This is quite normal.)
 - D. After one minute, did an audible signal sound and COOK indicator go off? YES _____ NO _____
 - E. Is the water inside the oven hot? YES _____ NO _____

If "NO" is the answer to any of the above questions, please check your wall socket and the fuse in your meter box. If both the wall socket and the fuse are functioning properly, CONTACT YOUR NEAREST SERVICE CENTRE APPROVED BY SHARP.

NOTE: 1. If time in the display is counting down rapidly, check Demonstration Mode. (See page 19 for detail.)
2. In high / medium high power, output power will gradually be reduced to avoid overheating.

SPECIFICATIONS

AC Line Voltage:	Single phase 230–240V, 50Hz
AC Power Consumption:	1.15kW*, 5.0 A*(IEC test procedure)
AC Power Requirement:	1.90 kW, 8.0 A
Output Power:	1200 W* (IEC test procedure)
Microwave Frequency:	2450 MHz (Class B/Group 2)**
Outside Dimensions:	520mm(W) x 310mm(H) x 442mm(D)
Depth with the door open:	826mm
Cooking Uniformity:	Turntable (ø320mm tray) system
Weight:	Approx. 12 kg

* When tested in accordance with AS/NZS 2895.1.2007

** This is the classification of ISM (Industrial, Scientific and Medical) equipment described in the International Standard CISPR11.

HINTS

- Always place the stems of vegetables – e.g. cauliflower, broccoli – toward the outside of the dish. The stems are tougher than the flower, so this will ensure even cooking.
- Ice-cream containers were made for freezing food and are not suitable for use in a microwave oven.
- Remember: When melting chocolate in the microwave oven, it holds its shape until stirred. Refer to MELT/SOFTEN MENU GUIDE on page 8 for instructions.
- Jams and chutneys are great when made in the microwave, as they retain their colour and flavour.
As cooking time is so short, less evaporation occurs. Therefore pectin or a jam setting agent is required to make jam set.
- To obtain more juice from oranges, lemons or limes, prick skin, microwave 30 seconds on HIGH and stand 2 minutes before squeezing.
- Warm jam for a quick glaze. Heat 2-3 tablespoons for 30 seconds on HIGH; strain if necessary while hot.
- Soften cream cheese for dips or beating by removing foil wrapper and cooking for 1 minute on MEDIUM LOW.
- To melt marshmallows, place 100 g in a large bowl. Cook for 30 seconds on HIGH.
- To dissolve gelatine, mix 1 teaspoon gelatine with 2 tablespoons water and cook for 20-30 seconds on HIGH. Stir well.
- To blanch almonds place 100 g in a bowl with 1 cup of water. Cook for 5 minutes on HIGH.
- If brown sugar becomes hard, simply soften in the microwave oven. Place a cup at a time in a bowl with a slice of bread. Cover with plastic wrap and cook for 40 seconds on HIGH.
- Soften 6-8 honey-snap biscuits for 30 seconds on HIGH. Shape into base of patty dish for quick tartlet cases.
- Place a chocolate after-dinner mint on top of 6 patty cakes; arrange cakes evenly on turntable. Cook about 50-60 seconds on HIGH, or until chocolate is soft.

Gently spread chocolate mint evenly over patty cake for a quick icing.

- To soften honey, remove metal lid from jar and microwave on HIGH for 30 seconds.
- Stuffed mushrooms are a terrific idea. Provided the filling is cooked, twelve mushrooms placed on a layer of paper towel will take approximately 3 minutes to heat on HIGH.
- To remove odours, place 1-litre water with slice of lemon or 1 teaspoon vanilla essence in the micro wave. Cook for 20 minutes on HIGH.
- As microwave cooking time is so quick, food should be seasoned to taste with herbs and spices after cooking.
- To peel a tomato, pierce the skin with a fork 3-4 times. Place on a rack and cook for 45-60 seconds on HIGH. Stand for 3 minutes before peeling.
- Lightly prick the skin of chicken before cooking. This prevents the loud popping noises.
- Peeling garlic is made easier by placing a clove in the microwave for 10 seconds on HIGH.
- Pierce the skin of chicken livers with a fork before cooking to prevent popping of the internal fat. Cover with paper towel when cooking.
- The flavour of wine in food is highlighted with the short microwave cooking time, so adjust the quantity to your taste.
- Tomato sauce can be warmed for 30 seconds on HIGH to give it a pouring consistency. (ensure lid is removed.)
- When cooking sauces in the microwave use less liquid: the absence of direct heat means sauces do not reduce as much as stovetop-prepared sauces.
- Rice and pasta cook well in small quantities. Use a large container to prevent boiling over.
- FOIL. Contrary to popular belief, foil can be used in the microwave – for shielding, not covering. It must not come in contact with the walls of the microwave.

Foil directs microwave energy away from delicate or thin areas of food, toward areas that need more cooking. It is essential for even defrosting. Place foil over the thawed sections, allowing the frozen portions to continue defrosting.

- To enhance the colour and flavour when roasting chicken, mix some brown sugar, honey and a little soy sauce together and brush both sides of poultry before and during cooking.
- To blanch vegetables for freezing, place 150 g of vegetables in a dish with 1 tablespoon of water. Cover and cook on HIGH for 1/3 of the usual cooking time. After cooking, immerse immediately in iced water, package, label, and freeze for up to 3 months.
- Do not add salt to vegetables before cooking, as salt draws out the moisture and causes vegetables to toughen.

COMMONLY ASKED QUESTIONS AND ANSWERS

MICROWAVES COOK FROM THE INSIDE OUT. They certainly do not. Microwaves penetrate foods from the outside to a depth of about 2.5 cm. Small foods, under 5 cm in diameter, are penetrated to the centre from all sides. With large foods, energy creates heat in the outer layer; then the heat moves to the centre by conduction, as it does conventionally. A few foods may appear to cook more on the inside. One example is an egg. Energy penetrates to the centre, where the fatty yolk becomes hotter than the white, and cooks quicker.

YOU CAN'T USE METAL IN A MICROWAVE OVEN.

False. Metal reflects microwaves; the oven itself is made of metal so microwave energy can't escape. Inside the oven, metal slows cooking because it keeps energy from reaching parts of the food. You can use the reflective properties of metal to protect foods which might overcook in some areas.

DISHES DON'T GET HOT IN A MICROWAVE OVEN.

Keep your oven mitts handy. A microwave-safe utensil will not be heated by microwave energy, but it will become hot from contact with hot food. Heat tends to equalise. A warm object heats the air around it, like a radiator in a cool room. When food becomes hot, some of this heat is transferred to the dish.

POINTS TO REMEMBER

As a general guide:

HIGH – is ideal for vegetables, fruit, soup, beverages, bacon and sauces.

MEDIUM HIGH – for roasting lamb, roasting chicken and fish fillets.

MEDIUM – is for roasting beef, pork and simmering; great for casseroles or stews and cooking seafood.

MEDIUM LOW – allows you to defrost.

LOW – is used to keep foods warm once they are cooked.

- The more food in the microwave oven, the longer it takes to cook.
 - Reduce liquids in a microwave recipe because there is not as much evaporation, due to the shorter cooking time.
 - Reduce seasonings slightly because flavours will be unbalanced by quantity of liquid. Do not add salt until the end of the cooking process.
 - Microwaves cook from the outside to the centre, so when arranging foods always place the thicker or more dense portions of food at the outside, with the thinner, less-dense pieces on the inside.
 - Foil can be used in the microwave oven successfully. Just remember two rules:
 - (a) There must be at least half of the food exposed to the microwaves.
 - (b) Do not let the foil touch the sides of the oven.
- Use foil to shield thinner parts of food when defrosting, to prevent over-cooking and drying out.
- All food continues to cook after it leaves the microwave oven because the heat is stored in the food and not in the oven.

Standing time required will vary according to the volume and density of food.

e.g. Fish and vegetables – 1-5 minutes

Cakes – 3-10 minutes

Roasts – 10-15 minutes

Cover foods with a lid or foil when standing.

- When reheating foods always cover with a lid, plastic wrap or paper towel to prevent foods from drying out. Reheat on **MEDIUM** for best results.
- Always pierce food that has a membrane – for example eggs, tomatoes, potatoes and kidneys.
- Remember to cover vegetables with a lid or plastic wrap when cooking.

GLOSSARY OF TERMS

SPOON MEASURES

1 tablespoon	=	20 mL
1 teaspoon	=	5 mL
1/2 teaspoon	=	2.5 mL
1/4 teaspoon	=	1.25 mL

LIQUID MEASURES

Cups	Metric	Imperial
1 cup	= 250 mL	= 8 fl. oz.
1/2 cup	= 125 mL	= 4 fl. oz.
1/3 cup	= 80 mL	= 2.5 fl. oz.
1/4 cup	= 60 mL	= 2 fl. oz.

CUP MEASURES

	Metric	Imperial
1 cup flour	140 g	4 1/2 oz.
1 cup sugar	250 g	8 oz.
1 cup brown sugar	185 g	6 oz.
1 cup icing sugar	185 g	6 oz.
1 cup butter/margarine	250 g	8 oz.
1 cup honey/golden syrup	375 g	12 oz.
1 cup fresh breadcrumbs	60 g	2 oz.
1 cup crushed biscuits	125 g	4 oz.
1 cup uncooked rice	220 g	7 oz.
1 cup mixed fruit	185 g	6 oz.
1 cup chopped nuts	125 g	4 oz.
1 cup coconut	90 g	3 oz.

DRY INGREDIENTS

Metric	=	Imperial
15 g	=	1/2 oz.
30 g	=	1 oz.
60 g	=	2 oz.
90 g	=	3 oz.
125 g	=	4 oz.
185 g	=	6 oz.
250 g	=	8 oz.
500 g	=	1 lb.
1000 g (1 kg)	=	2 lb.

NOTE

- Recipes in this book use standard metric equipment approved by the Australian Standards Association.
- All spoon and cup measures are level.
- All recipes in this book that include eggs require 55 g unless otherwise specified.

GENERAL INFORMATION

DEFROSTING

Thawing food, especially meats, using the microwave oven is not only faster than any other method but it can also give better results.

Once frozen meat is thawed, it begins to lose its juices.

With a microwave oven you can thaw meat just before you plan to cook it, thus preserving the quality.

Microwave thawing doesn't mean a lot of fuss, but some attention is needed to make sure that parts of food do not start to cook before the centre is thawed. MEDIUM LOW is fast enough to be convenient but gentle enough to give good results.

POULTRY

Start thawing poultry breast-side down; shield warm areas and turn over halfway through defrosting. Let poultry stand 30 to 60 minutes after thawing, until giblets and neck can be removed and breast meat under wings is completely thawed.

CUTS OF MEAT

Break up or separate minced beef, cubed meat, chicken pieces or fish fillets after one-third of thawing time.

Remove any thawed pieces. Place remainder in baking dish to complete thawing. Turn over roasts, steaks, chops or chicken. Separate as soon as possible.

JOINTS

Turn over large roasts halfway through defrosting. As you turn, touch the meat to find warm areas and shield these with small pieces of foil. Let roasts stand 30 to 45 minutes after defrosting time. Thaw meats and poultry only until they can be pierced in the centre with a skewer. Surface or cavity should feel cool but not icy. Cook as soon as possible to prevent loss of juices.

REHEATING

Foods reheated in the microwave oven taste freshly cooked, not reheated. Suit the power level to the food. A bowl of leftover vegetables can be reheated at HIGH, while lasagne, which contains sensitive cheese and cannot be stirred, should be reheated at MEDIUM HIGH or MEDIUM.

CASSEROLES

Cover dish tightly with plastic wrap or a lid. Stir several times during reheating, especially if casserole has been refrigerated. If casserole cannot be stirred, reheat at MEDIUM.

MEATS

Medium to thin slices reheat best. Cover meat with sauce or gravy. Cover with microwave plastic wrap to hold in heat. Reheat on MEDIUM.

PLATES OF FOOD

Arrange food with thickest parts of meat and bulky vegetables to outside of the plate. Place quick-to-heat foods in the centre. Cover with microwave plastic wrap. Reheat on MEDIUM.

VEGETABLES

Wrap large, whole vegetables in microwave plastic wrap. Cover dishes of vegetables and stir during reheating, if possible.

TOASTING

ALMONDS

Place 100 g almonds in a glass dish; cook for 3-3 1/2 minutes on HIGH, or until golden brown. Stir almonds every minute during cooking.

SESAME SEEDS

Place 1/4 cup sesame seeds in a glass bowl; cook for 2-3 minutes on HIGH, or until golden. Stir every minute.

RECONSTITUTING DRIED FOODS

DRIED FRUITS

Place 1 cup of fruit in a bowl, cover with cold water, and cook for 4 1/2-5 minutes on HIGH. Stand covered for 5 minutes before using.

DRIED MUSHROOMS

Place in a bowl with 2 cups of water and heat, slowly, 8-10 minutes on LOW.

REHEATING CONVENIENCE – FOOD CHART DEFROSTING CONVENIENCE

FOOD	AMOUNT	MICROWAVE TIME AND POWER LEVEL	SPECIAL INSTRUCTIONS	STANDING TIME
Beverage (room temp.) 250mL per cup	1 cup 2 cups	1 minute on HIGH (100%) 2 minutes on HIGH (100%)	Stir after heating.	—
Canned Food (room temp.) (e.g. Spaghetti, Baked Beans)	1 cup 2 cups	1 ½ minutes on HIGH (100%) 4 minutes on HIGH (100%)	Place food in bowl. Cover with plastic wrap or lid. Stir halfway.	1-3 minutes
Canned Soup (room temp.) 250mL per cup (thin soup)	1 cup 2 cups	1 ½ minutes on HIGH (100%) 2 ½ minutes on HIGH (100%)	Place food in bowl. Cover with plastic wrap or lid. Stir halfway.	—
Meat Pie (refrigerated) Individual 180g each	1 pie 4 pies	5 minutes on MEDIUM (50%) 10 minutes on MEDIUM (50%)	Place directly on turntable, face side down. Cover with paper towel. Turn over halfway.	3 minutes
Pizza (refrigerated) 90g per slice	1 slice 2 slices	1 minute on MEDIUM HIGH (70%) 1 ½ minutes on MEDIUM HIGH (70%)	Place on paper towel. Place directly on turntable.	—
Dinner Plate (refrigerated) 350g-400g per serve	1 serve	3 ½-4 minutes on MEDIUM HIGH (70%)	Slice potato. Cover plate with plastic wrap and pierce 5 times with a skewer. Place directly on turntable. Allow to stand.	5 minutes
Casserole (refrigerated) 250g per serve	1 serve 2 serves	2 ½ minutes on MEDIUM HIGH (70%) 5 minutes on MEDIUM HIGH (70%)	Place in a bowl, cover with plastic wrap. Place directly on turntable. Stir halfway. Allow to stand, then stir.	1-3 minutes
Frozen Rice/Pasta Dinners (e.g. Lasange, Risotto)	300-500g	8-9 minutes on MEDIUM HIGH (70%)	Remove from foil container. Cover with plastic wrap or lid. Allow to stand.	2 minutes
Croissants (frozen)	1 2	40-45 seconds on MEDIUM LOW (30%) 1 minute 10 seconds on MEDIUM LOW (30%)	Place between paper towels. Place directly on the turntable.	—
Fruit Pie individual (frozen) 135g each	1 2	2 ½-3 minutes on MEDIUM LOW (30%) 4-4 ½ minutes on MEDIUM LOW (30%)	Remove from foil container. Place on a plate and then onto the turntable. Allow to stand.	2 minutes
Danish Pastry whole (frozen)	400g	3 ½ minutes on MEDIUM HIGH (70%) followed by 3-3 ½ minutes on MEDIUM LOW (30%)	Remove from foil container. Place on dinner plate. Allow to stand.	2 minutes

NOTE: Room Temperature +20°C
Refrigerator Temperature +3°C
Frozen Temperature -18°C

FROZEN VEGETABLE CHART

1. Place vegetables in a medium/large microwave safe bowl and cover with plastic wrap.
2. Allow to stand for 2 minutes before draining any water and serving.

VEGETABLE	AMOUNT	MICROWAVE TIME AT MEDIUM HIGH (70%)	SPECIAL PROCEDURES
Beans (green, cut)	500 g	9½ minutes	
Broccoli	500 g	9½ minutes	Break apart as soon as possible. Arrange with flower towards the centre.
Carrots (whole)	500 g	9 minutes	Stir halfway through.
Carrots (sliced)	500 g	9½ minutes	Stir halfway through.
Cauliflower	500 g	9½ minutes	Break apart as soon as possible. Arrange with flower towards the centre.
Corn on the Cob	4 pieces	9 minutes	
Peas (green)	500 g	9 minutes	
Spinach	250 g	5 minutes	Break apart as soon as possible.
Mixed Vegetables (i.e. carrots, beans and corn kernels)	500 g	9 minutes	Break apart as soon as possible.

RICE AND PASTA COOKING CHART

1. Wash and strain rice before measuring amounts.
2. Place rice/pasta in a medium/large microwave safe bowl with water. Cook uncovered, stirring halfway through cooking. Allow to stand for 2 minutes before straining any remaining water and serving.

FOOD	OTHER INGREDIENTS	MICROWAVE TIME AT MEDIUM HIGH (70%)	
Pasta	1 Cup	2 cups Hot Water	12 minutes
	2 Cups	4 cups Hot Water	14 minutes
	4 Cups	6 cups Hot Water	18 minutes
White Rice	1 Cup	2 cups Hot Water	14 minutes
	2 Cups	4 cups Hot Water	20 minutes
	4 Cups	6 cups Hot Water	28 minutes
Brown Rice	1 Cup	2½ cups Hot Water	28 minutes
Quick Oats	1 Cup	2¼ cups Milk	6 minutes

GUIDE TO COOKING EGGS

SCRAMBLED EGG GUIDE

Place butter, eggs and milk in a small/medium microwave safe bowl. Beat with a fork until well combined and yolks of eggs are completely stirred in. Cook uncovered, stirring halfway through cooking.

Egg(s)	Butter	Milk	MICROWAVE TIME AT MEDIUM HIGH (70%)
1	1 tsp	1 tbsp	1 minute
2	2 tsp	1 tbsp	1 minutes 30 seconds
3	1 tbsp	2 tbsp	2 minutes 30 seconds
4	1 tbsp	¼ cup	3 minutes

MICROWAVE: FRESH VEGETABLE CHART

1. Cover required dishes with plastic wrap or a lid.
2. Drain any remaining water after standing before serving.

VEGETABLE	AMOUNT	MICROWAVE TIME AT MEDIUM HIGH (70%)	COOKING PROCEDURE
Asparagus (halved)	500 g	5-5½ minutes	Place in a shallow microwave safe dish. Cover. Stand for 3 minutes.
Beans (top and tailed)	500 g	6 minutes	Place in a shallow casserole dish with 1 tablespoon of water. Cover. Stand for 3 minutes.
Broccoli (uniform florets)	500 g	5-6 minutes	Place in a shallow casserole dish. Cover. Stand for 3 minutes.
Brussels sprouts	500 g	5½-6 minutes	Place in a shallow casserole dish. Cover. Stand for 3 minutes.
Cabbage (shredded)	500 g	5½ minutes	Place in a shallow casserole dish with 2 tablespoons of water. Cover. Stand for 3 minutes.
Carrots (sliced)	500 g	6 minutes	Place in a shallow microwave safe dish. Cover. Stand for 3 minutes (cook for longer for less crunch).
Cauliflower (uniform florets)	500 g	6-7 minutes	Place in a shallow casserole dish with 1 tablespoon of water. Cover. Stand for 3 minutes.
Corn on the Cob	2 pieces	7 minutes	Rinse corn under cold water. Place corn in husk and place directly on the turntable. Turn over during cooking. Stand for 3 minutes.
	4 pieces	15 minutes	Rinse corn under cold water. Place corn in husk and place directly on the turntable. Turn over during cooking. Stand for 5 minutes.
Mushrooms (quartered)	500 g	5-5½ minutes	Place in a shallow casserole dish with 2 tablespoons of butter. Cover. Stand for 3 minutes.

VEGETABLE	AMOUNT	MICROWAVE TIME AT MEDIUM HIGH (70%)	COOKING PROCEDURE
Peas (green; top and tailed)	500 g	4-4½ minutes	Place in a shallow casserole dish with 1 tablespoon of water and 1 teaspoon of sugar. Cover. Stand for 3 minutes.
Potatoes - Jacket	4 medium	9 minutes	Pierce with a fork. Turn over during cooking. Stand for 3 minutes.
Potatoes - Baked	4 small	7 minutes	Peel and quarter potatoes. Cook in a dish with ⅓ cup water. Cook covered. Stand for 3 minutes.
Pumpkin (2cm cubes)	500 g	6 minutes	Place in a shallow casserole dish. Cover. Stand for 3 minutes.
Spinach (shredded)	500 g	5-5½ minutes	Place in a shallow casserole dish with 2 tablespoons of water. Cover. Stand for 3 minutes.
Snow Peas (top and tailed)	500 g	3½-4 minutes	Place in a shallow casserole dish with 1 tablespoon of water. Cover. Stand for 3 minutes (cook for longer for less crunch).
Squash (whole)	500 g	5-5½ minutes	Pierce with a fork. Place in a shallow casserole dish. Cover. Stand for 3 minutes.
Sweet Potato (2cm cubes)	500 g	8 minutes	Place in a shallow casserole dish. Cover. Stand for 5 minutes.
Zucchini (sliced or quartered)	500 g	5 minutes	Place in a shallow casserole dish with 1 tablespoon of water and 1 tablespoon of butter. Cover. Stand for 3 minutes.

MICROWAVE OVEN ROASTING CHART

FOOD	AMOUNT	MICROWAVE TIME AND POWER LEVEL	INSTRUCTIONS	STANDING TIME
BEEF Medium	1 kg	18-20 minutes on MEDIUM HIGH (70%)	Season with cracked pepper. Place fat-side down on a microwave safe rack. Turn over halfway through cooking. Stand covered with foil before carving.	15 minutes
Well done	1 kg	25-28 minutes on MEDIUM HIGH (70%)		
PORK Well done	1 kg	25 minutes on MEDIUM HIGH (70%)	Brush rind with oil and sprinkle with salt. Place on a microwave safe rack. Turn over halfway through cooking. Stand covered with foil before carving.	15 minutes
LAMB Medium	1 kg	13-15 minutes on MEDIUM HIGH (70%)	Season with "Season All" or as desired. Place fat-side down on a microwave safe rack. Turn over halfway through cooking. Stand covered with foil before carving.	15 minutes
Well done	1 kg	16-18 minutes on MEDIUM HIGH (70%)		
CHICKEN Whole	1 kg	22 minutes on MEDIUM HIGH (70%)	Brush with melted butter. Season as desired. Place chicken breast-side down on a microwave safe rack. Turn over and shield wings and legs halfway through cooking. Stand covered with foil before carving.	15 minutes
Pieces (legs)	500 g	12 minutes on MEDIUM (50%)	Season as desired. Place chicken skin-side down on a microwave safe rack. Turn over halfway through cooking. Stand covered with foil before serving.	5 minutes

CHARTS

DEFROSTING FROZEN FOODS

Procedure:

1. Remove wrapping from meat.
2. Place frozen meat on a defrost rack. Shield.
3. Defrost using MEDIUM LOW power level (30%).
4. Halfway through defrosting, remove any defrosted portions, e.g. steak, mince.
Turn over and shield. Continue defrosting.

DEFROSTING TIMES AND TECHNIQUES FOR MEAT AND POULTRY

CUT	MICROWAVE TIME	STANDING TIME
BEEF (Roast)	5-7 minutes/500 g	10-15 minutes
Steaks	5-7 minutes/500 g	5-10 minutes
Minced Beef	5-7 minutes/500 g	5-10 minutes
PORK (Roast)	4-6 minutes/500 g	10-15 minutes
Chops	4-6 minutes/500 g	5-10 minutes
Ribs	5-7 minutes/500 g	5-10 minutes
Minced Pork	5-7 minutes/500 g	5-10 minutes
LAMB (Roast)	4-6 minutes/500 g	10-15 minutes
Shoulder	3 ¹ / ₂ -5 ¹ / ₂ minutes/500 g	10-15 minutes
Chops	5-7 minutes/500 g	5-10 minutes
POULTRY		
Chicken (Whole)	5-7 minutes/500 g	10-15 minutes
Pieces	4-6 minutes/500 g	5-10 minutes

DEFROSTING TIMES AND TECHNIQUES FOR SEAFOOD, BREAD AND PIES

SEAFOOD	MICROWAVE TIME	STANDING TIME	PROCEDURES
Whole Fish	5-7 minutes/500 g	10 minutes	Shield head and tail with foil. Turn over and shield any warm area halfway through defrosting.
Scallops	4-6 minutes/500 g	5 minutes	Turn over halfway through defrosting. Separate as soon as possible.
Prawns	3 ¹ / ₂ -5 ¹ / ₂ minutes/500 g	5 minutes	Turn over halfway through defrosting. Separate as soon as possible.

BREAD	MICROWAVE TIME	PROCEDURES
2 slices	15-20 seconds	Place bread between 2 pieces of paper towel. Place directly on the turntable.
4 slices	25-30 seconds	
6 slices	35-40 seconds	
Bread Rolls	15-20 seconds per roll	

PIES	MICROWAVE TIME	PROCEDURES
Individual	2-3 minutes	Remove from packaging. Place between paper towel on a rack. Turn over halfway. Allow to stand 2 minutes.
Whole	6-7 minutes	

JAM

CASHEW FUDGE

Serves 8

125 g butter
2 tablespoons golden syrup
1x 400 g can sweetened condensed milk
1 cup brown sugar
100 g packet choc bits
1 cup 125 g chopped cashews (unsalted)
1/2 teaspoon vanilla essence

1. In a large microwave safe glass bowl, combine the butter, golden syrup, condensed milk and sugar. Mix well. Cook for 6 minutes on MEDIUM HIGH (70%), stirring every minute. To avoid a grainy texture, do not scrape the undissolved sugar crystals from the sides down into the bowl during cooking.
2. Stir in the choc bits, cashews and vanilla essence.
3. Pour the mixture into a greased and lined 28x18cm lamington tin.
4. Refrigerate until firm. Cut into squares.

PUMPKIN PIE

Serves 8

CRUST

60 g butter or margarine
1 cup crushed sweet biscuits
1/4 cup brown sugar

FILLING

250g cream cheese
1 cup cooked pumpkin
3/4 cup brown sugar
2 eggs
1 1/2 tablespoons plain flour
1/2 teaspoon ground cinnamon
1/4 teaspoon ground nutmeg
1/2 teaspoon vanilla essence

1. To make the pie crust, place the butter in a medium pyrex dish. Cook for 40 seconds on HIGH (100%) until the butter is melted.
2. Add the biscuit crumbs and sugar. Mix thoroughly. Press the mixture firmly into the bottom and side of a 23cm microwave safe pie dish. Cook for 3 minutes on MEDIUM HIGH (70%) until hot. Set aside to cool completely.
3. To make the filling add the cream cheese in a large microwave safe glass bowl. Cook for 1 minute on MEDIUM (50%) until soft.
4. Add remaining ingredients. Beat at medium speed with an electric mixer, until smooth and well blended. Cook for 5 minutes on MEDIUM HIGH (70%) until hot and thick, stirring every minute.
5. Pour the filling into cooled crust. Cook for 10 minutes on MEDIUM (50%) until the filling is firm to touch, centre may appear soft set.
6. Refrigerate until completely set. Serve with cream or ice cream.

STRAWBERRY JAM

Makes approximately 2 x 500g jars.

2 punnets strawberries
1/4 cup lemon juice
2 cups sugar

1. Wash, hull and cut the strawberries in half.
2. In a large microwave safe glass bowl, combine the strawberries and lemon juice. Cook, uncovered for 3 minutes on HIGH (100%).
3. Add the sugar and mix well. Cook uncovered, stirring occasionally, for 20 minutes on MEDIUM HIGH (70%). Caution: watch the jam closely the entire cooking time to ensure it does not boil over.
4. To test that the jam sets place 1 teaspoon on a small plate and let it cool. If it gels slightly, it is set.
5. Pour the jam into hot sterilised jars, seal and label.

MIXED BERRY AND

APPLE JAM

Makes approximately 2 x 500g jars.

600 g frozen mixed berries
2 large Granny Smith apples, peeled and grated
1/2 cup apple juice
2 cups sugar

1. In a large microwave safe glass bowl, combine the frozen mixed berries, apples and juice. Cover with plastic cling-wrap and cook for 13 minutes on MEDIUM HIGH (70%).
2. Add the sugar and stir well. Cook, uncovered for 18 minutes on MEDIUM HIGH (70%), stirring twice during cooking and then once again after cooking is complete.
3. To test that the jam sets, place 1 teaspoon on a small plate and let it cool. If it gels slightly, it is set.
4. Pour the jam into hot sterilised jars, seal and label.

DESSERTS

BREAD AND BUTTER PUDDING

Serves 4-6

6 slices white bread, crusts removed
Butter for spreading
6 tablespoons fruit jam of choice
3 tablespoons caster sugar
1/4 cup sultanas

300ml cream
1/2 teaspoon vanilla essence
1 egg, lightly beaten
1/4 teaspoon ground nutmeg
extra sugar to sprinkle

1. Spread one side of the bread with butter and jam.
2. Cut the bread into 2cm squares.
3. In a 2 litre microwave safe pudding bowl, add the bread and sultanas and set aside.
4. In a medium bowl, whisk the egg. Add the cream, vanilla essence and sugar, continue to mix.
5. Pour the mixture over the bread and sultanas and sprinkle with nutmeg and extra sugar. Cook for 20 minutes on MEDIUM LOW (30%).
6. Allow to stand for 5-10 minutes. Serve with cream or ice cream.

CHOCOLATE FUDGE CAKE

2 cups sugar
3/4 cup cocoa powder
1 teaspoon baking powder
1 1/2 cups milk

1/2 cup oil
1 3/4 cups plain flour
2 eggs
2 teaspoons vanilla essence

ICING

125 g butter
1 cup icing sugar
1 tablespoon vanilla essence

125 g cream cheese
2 dessert spoons cocoa

1. In a large bowl, combine all the ingredients together. Using an electric hand mixer beat together for 3 minutes on a high setting.
2. Pour the batter into a greased microwave safe round cake dish.
3. Cook for 16-18 minutes on MEDIUM (50%). Allow to stand for 5-10 minutes before turning out.
4. To make the icing, beat together all the ingredients until light and creamy.
5. Ice the cooled cake and serve.

PEPPERMINT CHOC HAZELNUT MOUSSE

Serves 4

100 g dark chocolate chopped
100 g milk chocolate chopped
2 eggs separated
1 cup thickened cream whipped

1/2 cup hazelnuts finely chopped
2 teaspoons peppermint essence

1. Place dark chocolate and milk chocolate in a microwave safe bowl. Microwave on HIGH (100%) for 2 minutes, stirring with a metal spoon halfway through cooking or until smooth. Cool slightly.
2. Stir in egg yolks until just combined, stir cream, hazelnuts and peppermint essence using an electric mixer, beat the egg whites in a separated bowl, until stiff peaks form. Fold egg whites in 2 batches into the chocolate mixture.
3. Spoon mixture into 4 glasses. Cover and refrigerate for 3 hours or until set.

CARAMEL RICE PUDDING

Serves 4-6

1 cup Arborio rice
3 cups hot water
395 g can sweetened condensed milk
1 tablespoon vanilla essence
Cinnamon sugar, to garnish

20 g butter
1 tablespoon lemon juice
3 eggs, separated
2 tablespoons caster sugar

1. In a large microwave safe glass bowl, combine the rice and hot water. Cook for 12-15 minutes on HIGH (100%), stirring after 6-7 minutes until the rice is tender.
Drain and set aside.
2. In a microwave safe glass jug, combine the condensed milk and butter. Cook for 6 minutes on 60%, stirring every 20 seconds to prevent the mixture from boiling over.
3. Stir the rice, lemon juice, egg yolk and vanilla essence into the caramel. Transfer the mixture to a 2 litre microwave safe pudding bowl. Set aside.
4. Beat egg whites until stiff in a separate bowl, gradually beat in sugar.
5. Spoon the egg whites mixture over the rice pudding and sprinkle with the cinnamon sugar. Cook for 5 minutes on MEDIUM (50%).
6. Allow to stand for 5 minutes and serve with cream or ice cream.

MOIST CARROT CAKE

1 cup oil
1 cup brown sugar
3 eggs
1 1/2 cups self raising flour, sifted
1 teaspoon bicarbonate of soda

1 teaspoon ground cinnamon
Salt to taste
2 large carrots, grated
3/4 cup chopped walnuts

CREAM CHEESE ICING

250 g cream cheese
2 1/2 cups icing sugar

2 tablespoons lemon juice

1. In a large bowl, beat the oil, sugar and eggs until well combined.
2. Add flour, bicarbonate soda, cinnamon and salt.
3. Fold in the carrots and walnuts.
4. Pour into a greased 20cm microwave safe cake dish. Cook for 12 minutes on MEDIUM HIGH (70%).
5. Allow to stand for 5 minutes. Turn out and cool.
6. To make icing, beat cream cheese until smooth.
7. Add icing sugar and lemon juice and beat until smooth.
8. Ice the cake when cool.

CHILLI AND TOMATO SPAGHETTI Serves 4-6

350 g spaghetti, snapped in half
1 1/2 litres hot water
1 birdseye chilli, finely chopped
1 spanish onion, finely chopped
2 cloves garlic finely chopped

1 can diced tomatoes
3 tablespoons extra virgin olive oil
salt and pepper to taste
2 handful of chopped continental parsley

1. In a large microwave safe glass bowl combine the spaghetti and hot water. Cook for 14 minutes on HIGH (100%), stirring after 7 minutes. Drain and set aside.
2. In a medium microwave safe glass bowl add the oil onion and chilli. Cook for 3 minutes on 60%.
3. Add garlic, cook for 2 minutes on 60%.
4. Add tomatoes, salt and pepper, cook for 6 minutes on 60% stirring half way through.
5. Place spaghetti in serving dish, add parsley and sauce. Stir until well combined.
6. Serve with freshly grated parmesan cheese.

CHUNKY VEGETABLE SOUP Serves 4-6

1/4 cup oil
60 g butter
2 onions peeled and chopped
3 carrots finely chopped
1 potato peeled and chopped
3 sticks celery chopped

2 zucchinis chopped
1/4 cabbage shredded
3 cups beef stock
2 cans chopped tomatoes
salt and pepper
parmesan cheese

1. Combine oil, butter and onion in a large casserole dish. Cook for 3 minutes on HIGH (100%).
2. Add carrots and potato. Cover and cook for 6 minutes on MEDIUM HIGH (70%).
3. Add celery, zucchini and cabbage. Cover and cook for 4 minutes on MEDIUM HIGH (70%). Add stock, undrained tomatoes, salt and pepper. Cook covered for 27 minutes on 60% stirring occasionally
4. Serve hot, topped with parmesan cheese.

POTATO BAKE Serves 4-6

4 large potatoes, peeled and sliced
1/4 cup hot water
1 onion, diced
2 teaspoons finely chopped garlic
2 rashers bacon, chopped

1/3 cup grated tasty cheese
1 tablespoon fresh parsley, chopped
cracked black pepper and salt, to taste
1/2 cup thickened cream

1. In a large microwave safe casserole dish, combine the potato and hot water. Cover and cook for 12 minutes on MEDIUM HIGH (70%). Drain.
2. Arrange the potato to cover the base of the dish. Place a layer of onion, one third of the garlic and bacon, and a quarter of the cheese on top of the potato layer. Sprinkle with one third of the parsley and season to taste.
3. Repeat this layering twice, beginning with potato.
4. Pour the cream over the top. Sprinkle with the remaining cheese and parsley. Add the salt and pepper to taste. Cook uncovered for 8 minutes on MEDIUM HIGH (70%), until the cheese has melted.
5. Allow to stand for 1 minute and serve as a side dish with a main meal.

THAI VEGETABLE NOODLE SOUP Serves 4

1 teaspoon sesame oil
2 cloves garlic, crushed
100 g rice vermicelli noodles
2 cups vegetable stock
2 cm piece fresh ginger, grated
1 1/2 tablespoons oyster sauce
2 teaspoons hoisin sauce

1 carrot, thinly sliced
50 g cabbage, sliced
100 g cauliflower, cut into florets
200 g canned baby corn (drained)
1 shallot, sliced
100 g snow peas, topped and tailed
1 teaspoon fresh coriander, chopped

1. In a large bowl, add the noodles and cover with the boiling water. Leave to soak until soft, then drain. Set aside.
2. In a large microwave safe glass bowl, combine the oil and garlic. Cook for 1 minute on MEDIUM HIGH (70%), then stir.
3. Add the stock, ginger, sauces, carrot, cabbage and cauliflower. Cook for 5 minutes on MEDIUM HIGH (70%).
4. Add the remaining ingredients. Cook for 7 minutes on MEDIUM HIGH (70%).
5. Place the noodles into a serving bowl and pour the soup over the top.

VEGETABLES

POTATO, AVOCADO AND ONION SALAD Serves 6

1 kg small potatoes
1 large onion, cut in half then sliced
1 tablespoon caster sugar
20 g butter
1/2 cup mayonnaise

150ml sour cream
black pepper
1 large avocado, cubed
chives, for garnish

1. Cut unpeeled potatoes in half. Place in a large microwave safe glass dish and cover with cold water. Cook, covered with a lid, for 23 minutes on HIGH (100%).
(potatoes should be tender but holding their shape) Drain.
2. Place onion, caster sugar and butter in a microwave safe glass dish. Cook for 5 minutes on 60%, stirring twice.
3. Combine mayonnaise, sour cream and black pepper. Pour over potatoes.
4. Toss on onions and avocado, sprinkle with chives.

HONEY GINGERED VEGETABLES Serves 6

2 teaspoons grated ginger
2 tablespoons honey
1 tablespoon soy sauce
2 teaspoons lemon juice
500 g butternut pumpkin, peeled and thinly sliced
1 cup frozen beans
2 zucchinis, sliced
1 tablespoon sesame seeds

1. In a large microwave safe glass bowl, add ginger, honey, soy sauce and lemon juice stir and cook for 1 minute on HIGH (100%).
2. Add pumpkin and cook covered 6 minutes on MEDIUM HIGH (70%), until just tender.
3. Stir in beans and zucchini, cook covered for a further 6 minutes on MEDIUM HIGH (70%).
4. Spoon onto a serving plate, Sprinkle with sesame seeds.

HONEY CARROTS Serves 4

500 g carrots, sliced lengthwise
60 g butter
1 tablespoon honey

1 teaspoon garlic, crushed
1 teaspoon sesame seeds

1. Combine all ingredients in a casserole dish.
2. Cover and cook for 8 minutes on MEDIUM HIGH (70%). Stir halfway through cooking.
3. Stand covered for 3 minutes before serving.
4. Sprinkle with sesame seeds.

VEGETABLE PLATTER Serves 4

200 g carrots, sliced
200 g broccoli, cut into florets
100 g zucchini, sliced

1. Arrange vegetables in a microwave safe shallow casserole dish with the harder vegetables positioned around the outside and the softer vegetables in the centre.
2. Cover with lid or plastic wrap.
3. Cook for 7 minutes on HIGH (100%).
4. Stand covered for 3 minutes, before serving.

CRAB MORNAV

Serves 6

350 g fresh crab meat or 2 x 170 g Cans crab meat drained
5 garlic cloves crushed
60 g butter
1/3 cup plain flour
1/2 teaspoon dry mustard
2 cups milk

1 onion, finely chopped
1/2 cup grated cheese
4 tablespoons tomato sauce
1/2 teaspoon Tabasco sauce
2 teaspoons Worcestershire sauce
3 tablespoons cream

1. In a large microwave safe glass bowl, melt butter for 30 seconds on HIGH (100%), stir in flour and mustard. Cook for a further 1 minute on HIGH (100%).
2. Gradually stir in milk, cook for 4 minutes on MEDIUM HIGH (70%), stirring every minute.
3. Place oil, onion and garlic in a small microwave safe glass bowl. Cook for 2 minutes on MEDIUM HIGH (70%), stir halfway.
4. Stir in onion and garlic, crab meat, salt and pepper, 1/4 cup cheese, tomato sauce, worcestershire sauce, Tabasco sauce, cream and garlic.
5. Place into a 1 litre serving dish, sprinkle with remaining cheese.
6. Cook for 9 minutes on MEDIUM (50%).
7. Serve with a garden salad.

CHEESY SALMON CANNELLONI

Serves 4-6

12 fresh cannelloni sheets
250 g ricotta cheese
90 g cheddar cheese
Salt and pepper to taste
2 eggs lightly beaten
210 g red salmon, drained with bones removed

2 teaspoons lemon juice
2 tablespoons fresh parley chopped
2 tablespoons of extra cheddar cheese
375 g jar pasta sauce

1. Combine ricotta cheese, cheddar cheese, salt and pepper, eggs, salmon and lemon juice and mix well.
2. Place spoonfuls of salmon mixture into cannelloni sheets and roll to form tubes.
3. Place tubes in a single layer in a shallow microwave safe glass dish.
4. Pour pasta sauce over cannelloni and smooth over with the back of a spoon to ensure all sections of the pasta are covered with sauce.
5. Cook for 15 minutes on MEDIUM HIGH (70%).
6. Remove dish and sprinkle with extra cheese. Continue cooking on 60% for a further 3 minutes. Allow to stand for 10 minutes before serving.
7. Sprinkle with chopped parsley to serve.

BOUILLABAISSE

Serves 8

6 frozen mussels half shell (thawed)
400 g scallops
300 g green prawns
peeled and deveined
500 g firm fish fillets, cut into bite sized pieces
300 g seafood extender
1 onion finely diced
1 tablespoon olive oil

1 clove garlic crushed
1 1/2 cups fish stock
425 g can tomatoes pureed
1/2 cup white wine
2 tablespoons tomato paste
1/4 teaspoon turmeric
grated rind of 1 lemon
salt and pepper
1/4 cup chopped fresh basil

1. Wash and clean seafood.
2. Cook oil, onion and garlic in a large casserole dish for 1 1/2 minutes on MEDIUM HIGH (70%).
3. Stir in fish stock, tomatoes, white wine and tomato paste. Cover and cook for 8 minutes on MEDIUM HIGH (70%), stirring halfway through cooking.
4. Stir in scallops, prawns, turmeric, lemon rind, salt and pepper. Cover and cook for 6 minutes on 60%.
5. Stir in fish fillets, seafood extender and mussels. Cover and cook for 14 minutes on 60%, or until fish flakes.
6. Garnish with fresh chopped basil.

PRAWN CREOLE

Serves 4

20 g butter
1 medium onion chopped
1 capsicum chopped
1 stick celery sliced
2 tablespoons flour
1 400g can whole tomatoes
1/2 cup tomato paste

1 cup chicken stock
1 tablespoon chopped fresh parsley
2 teaspoons sugar
1/2 teaspoon salt
1/2 teaspoon chilli powder
500 g green prawns peeled and deveined

1. In a large microwave safe glass bowl, combine the butter, onion, capsicum and celery. Cook for 4 minutes on HIGH (100%).
2. Stir in the flour, tomatoes, tomato paste, stock, sugar, salt and chilli powder. Mix well. Cook, uncovered for 5 minutes on MEDIUM HIGH (70%) stirring halfway.
3. Add the prawns and cook for 5 minutes on MEDIUM HIGH (70%) stirring halfway.
4. Sprinkle with chopped parsley.
5. Serve with rice.

CHILLI PRAWNS WITH SNOW PEAS

Serves 4

20 g butter
24 green prawns, peeled and deveined
1 small red capsicum, cut into thin strips
1 tablespoon fresh chives, chopped

100 g snow peas, topped and tailed
3 tablespoons sweet chilli sauce
grated rind of one lemon
freshly ground black pepper, to taste

1. In a large microwave safe glass bowl, add the butter, heat for 30 seconds on HIGH (100%), until melted.
2. Add the prawns, capsicum, chives, chilli sauce, lemon rind and black pepper. Mix well. Cook for 5 minutes on MEDIUM (50%), stirring after 3 minutes.
3. Stir in the snow peas. Cook for 3 minutes on MEDIUM (50%).
4. Serve immediately with rice.

SEAFOOD

CRUNCHY CAMEMBERT CHICKEN

Serves 6

125g camembert cheese
Finely chopped
2 rashers bacon finely chopped
1/2 cup toasted slivered almonds chopped

2 tablespoons seeded mustard
1.5 kg chicken (approximately)
2 tablespoons honey

1. Mix camembert, bacon, almonds and 1 tablespoon mustard together.
2. Press camembert mixture between skin and flesh of chicken.
3. Tie chicken legs together.
4. Mix remaining mustard and honey. Brush over chicken, save some mixture to brush over chicken at halfway stage.
5. Place breast side down on a roast rack, cook for 35 minutes on MEDIUM HIGH (70%). Turn over halfway through cooking, and brush with remaining mixture.
6. Allow to stand covered with foil for 10 minutes before serving.

CHICKEN SKEWERS IN FAMOUS PEANUT SAUCE

Serves 4

1/2 cup smooth peanut butter
2 tablespoons soy sauce
1 1/2 teaspoons water
1/2 teaspoon sugar
1 clove garlic crushed
2 drops Tabasco sauce

1/4 cup water extra
400 g chicken breast fillets (sliced approximately 1cm thick)
chopped coriander to garnish

1. In a small bowl, combine the peanut butter, soy sauce and water. Stir well. Add sugar, garlic and Tabasco then gradually stir in extra water. Refrigerate for at least 30 minutes to allow the flavours to develop.
2. Place 2 tablespoons of the sauce into a separate dish and set aside.
3. Thread the chicken onto six soaked wooden skewers. Brush the chicken with the Larger amount of peanut sauce and arrange them onto a microwave safe rack in a circle. Cook for 2 1/2 minutes on MEDIUM HIGH (70%).
4. Turn the skewers and brush with the sauce. Cook for 2 1/2 minutes on MEDIUM HIGH (70%). Allow to stand for 2 minutes.
5. Garnish with the coriander and serve with the reserved peanut sauce.

SEAFOOD LAKSA

Serves 4-6

1 tablespoon lemon grass, finely sliced
270ml coconut cream
2 fish fillets or 300g king prawns or both
1 tablespoon oil
1-2 tablespoons laksa paste
Coriander

1 tablespoon fish sauce
1/2 packet of beans shoots
2 cloves garlic, crushed
100 g rice vermicelli noodles
1 125ml fish stock
fried onion flakes

1. In a large microwave safe glass cook laksa paste, oil, lemon grass and garlic for 1 minute on MEDIUM HIGH (70%). Stir once during cooking.
2. Add fish sauce, fish stock and cook for 2 minutes on MEDIUM HIGH (70%).
3. Add cubed fish and / or peeled deveined prawns and cook for 6 minutes on MEDIUM (50%). Stir halfway through cooking.
4. Stir through coconut cream and cook for a further 3 minutes on MEDIUM (50%).
5. Add noodles to a large bowl of boiling water and let stand for 5-10 minutes or until noodles collapse.
6. In a large serving bowl place bean shoots, noodles and then laksa soup.
7. Garnish with freshly torn coriander and fried onion flakes.

SMOKED SALMON FETTUCCHINE

Serves 4

250 g fettuccine pasta, broken in half
60g butter
100 g smoked salmon (sliced)
100 g snow peas trimmed
100 g button mushrooms
Finely sliced

2 cloves garlic, crushed
1 brown onion, finely chopped
300 g thickened cream
1 tablespoon fresh dill
1 cup parmesan cheese

1. Place fettuccine in a large microwave safe glass bowl with 6 cups of hot water. Cook for 15 minutes on MEDIUM HIGH (70%), stirring halfway. Stand for 5 minutes then drain.
2. In a large microwave safe glass bowl cook garlic, butter and onions for 1 1/2 minutes on 60%.
3. Add trimmed whole snow peas and button mushrooms and cook for a further 2 minutes on 60%.
4. In a large microwave safe bowl, place cream and cook for 4 minutes on MEDIUM (50%), stirring once during cooking.
5. In a large shallow dish, combine pasta, snow peas, button mushrooms, smoked salmon, dill and cream.
6. Sprinkle with parmesan cheese and cook for 3 minutes on 60%.

POULTRY

CHICKEN WITH BACON AND LEEK SEASONING

Serves 4

1.5 kg chicken (approximately)
60 g butter, melted
1 leek, finely chopped
1 rash bacon, chopped

3/4 cup wholemeal breadcrumbs
1 egg yolk
salt and pepper
20 g butter, melted extra

1. Combine butter, leek and bacon in a microwave safe glass bowl. Cook for 2 minutes on MEDIUM HIGH (70%).
2. Stir breadcrumbs, egg yolk and seasoning. Mix well.
3. Fill cavity of chicken with stuffing and tie the legs together with string.
4. Brush chicken with melted butter.
5. Place chicken on rack, breast-side down, cook for 15 minutes on MEDIUM HIGH (70%).
6. Turn over, cook for a further 20 minutes on 60%.
7. Stand covered with foil for 10 minutes before serving.

CHICKEN PENNE SALAD

Serves 6

1.5 kg chicken (approximately)
20 g butter
1 packet picador cheese (soft capsicum - flavored cheese)
1 cup chicken stock
1/2 red capsicum chopped
1/2 yellow capsicum chopped
1 stick celery chopped
2 cups penne pasta
4 cups hot tap water
1 tablespoon fresh chives

1. Brush chicken with butter melted for 20 seconds on HIGH (100%).
2. Cook chicken for 35 minutes on MEDIUM HIGH (70%), turning halfway through cooking.
3. Cool and then remove chicken fresh from the bone.
4. Cook pasta in a large bowl for 15 minutes on MEDIUM HIGH (70%). Stand for 5 minutes stir and strain. Set aside to cool.
5. To melt cheese, place cheese and chicken stock in a microwave safe bowl and cook on 60% for 2 minutes. Mix well.
6. Combine all other ingredients and mix well with chicken pasta and sauce.

TANDOORI CHICKEN

Serves 4-6

2 fresh red chillies seeded
1 onion
2 cloves garlic crushed
2 teaspoons crushed ginger
2 tablespoons lemon juice
2 teaspoons ground cumin
1/2 salt and pepper
3 teaspoons ground coriander
2 whole cloves

1/4 teaspoon cinnamon
1 bay leaf
1/2 teaspoon turmeric
1/2 teaspoon nutmeg
2 teaspoons paprika
6 chicken thighs, skin removed
200 g low fat yoghurt

1. In a food processor, puree chillies, onion, garlic, ginger and lemon juice until smooth.
2. Mix cumin, pepper, coriander, cloves, cinnamon, bay leaf, turmeric, nutmeg and paprika in a small microwave safe glass bowl.
3. Cook for 1 minute on HIGH (100%), stirring halfway through cooking. Remove bay leaf and cloves.
4. Combine chilli mixture, spices and yoghurt together. Spread over chicken.
5. Cover and marinate overnight, stirring occasionally.
6. Place on a roasting rack, cook for 20 minutes on MEDIUM HIGH (70%). Turn over halfway through cooking time.
7. Serve with boiled rice.

HONEY CHICKEN LEGS

Serves 4

250 ml soy sauce
4 tablespoons honey
1 tablespoon lemon juice
1 clove garlic crushed

1/2 teaspoon freshly grated ginger
2 tablespoons oil
8 large chicken legs
sesame seeds

1. Combine soy sauce, honey, lemon juice, garlic, ginger and oil in a small bowl. Pour over chicken and marinate for 2-3 hours.
2. Sprinkle with sesame seeds.
3. Arrange chicken legs on a roasting rack. Cook for 22 minutes on MEDIUM HIGH (70%) turning halfway through cooking time.
4. Allow to stand for 5 minutes.

CHILLI CON CARNE

Serves 4-6

1 kg mince
1 large onion finely chopped
825 g can peeled tomatoes
Salt and pepper
1-2 teaspoons chilli powder

1 tablespoon vinegar
1 teaspoon sugar
375 g jar tomato paste
425 can red kidney beans drained

1. Mix mince and onion together in a large microwave safe glass bowl. Cook for 10 minutes on MEDIUM HIGH (70%), stirring every 2 minutes. Drain excess liquid.
2. Stir in tomatoes, salt and pepper, chilli powder, vinegar, sugar, tomato paste and kidney beans.
3. Cook for 18-20 minutes on MEDIUM HIGH (70%), stirring twice during cooking.
4. Serve with boiled rice.

HONEY ROAST LAMB

Serves 4-6

1.5 kg leg of lamb
3 tablespoons honey
1 tablespoons Dijon mustard

1. Combine honey and Dijon mustard. Brush over lamb, save some mixture to brush over lamb at halfway stage
2. Place fat side down on a roasting rack.
3. Cook for 28 minutes on MEDIUM HIGH (70%).
4. Turn over halfway through cooking shielding shank with foil to prevent overcooking. Brush saved mixture over leg of lamb.
5. When cooked cover with foil and allow to stand for 10 minutes before carving.

SPECIAL FRIED RICE

Serves 6

2 cups jasmine rice (rinsed)
1 teaspoon vegetable stock powder
4 cups water
30 g butter
1 carrot grated
100 g green beans sliced

1/2 leek sliced (cut into quarters)
1 x 125 g can corn kernels
150 g bacon diced
2 eggs lightly whisked
2 tablespoons lite soy sauce
2 tablespoons sweet chilli sauce
1 tablespoon oyster sauce

1. In a large microwave safe glass bowl, add the rice, vegetable stock and water.
Cook uncovered for 17 minutes on MEDIUM HIGH (70%). Stirring after 7-8 minutes. Stir with a fork and set aside.
2. In a large microwave safe glass bowl, melt butter on 60% for 30 seconds. Add the grated carrots, beans, leek and mix. Cook for 3 minutes on 60%, stirring every minute.
3. Add corn, bacon, lite soy sauce, sweet chilli sauce and oyster sauce and cook for 2 1/2 minutes on 60%.
4. In a small microwave safe glass bowl, cook eggs on 60% for 1 1/2 minutes, stirring every 30 seconds.
5. Add all the ingredients together and mix well.

MEAT

LASAGNE

Serves 8

MEAT SAUCE INGREDIENTS

30g butter
1 onion chopped
1 kg topside mince
1/4 cup tomato paste
300 g jar Napolitana
1 cup fresh butter mushrooms sliced
2 cloves garlic crushed (optional)
1 tablespoon fresh oregano
Salt and pepper to taste

MEAT SAUCE METHOD

1. Place butter and onion in a large microwave safe glass bowl, Cook for 2 minutes on HIGH (100%).
2. Stir mince. Cook uncovered for 10 minutes on MEDIUM HIGH (70%), stirring every 2 minutes. Drain excess fat.
3. Stir tomato paste, napolitana sauce, mushrooms, garlic, oregano, salt and pepper.

CHEESE SAUCE METHOD

1. Melt butter in a medium sized microwave safe glass bowl for 40 seconds on MEDIUM HIGH (70%). Stir in flour, cook for a further 40 seconds on MEDIUM HIGH (70%).
2. Gradually stir in milk. Cook for 4 minutes on 60%, stirring every minute.
3. Stir in cheese to taste.

TO ASSEMBLE

1. Use a 3 litre deep casserole dish.
2. Spoon meat sauce to just cover base of dish. Cover with a single layer of lasagna sheets.
3. Spoon over sheets one-third of meat sauce. Cover with one-third with cheese sauce.
4. Repeat the process 3 times, ending with cheese sauce.
5. Sprinkle with mozzarella cheese.
6. Cook for 10 minutes on MEDIUM HIGH (70%) with lid on. Remove lid and continue cooking for a further 8 minutes on MEDIUM HIGH (70%).
7. Allow to stand for 10 minutes before serving.
8. Serve with a fresh garden salad and bread.

CHEESE SAUCE INGREDIENTS

90 g butter
1/3 cup flour
1 1/4 cups milk
125 g tasty cheese, grated
200 g packet fresh lasagna sheets
100 g mozzarella cheese grated

GOLDEN CURRY SAUSAGES

Serves 4-6

1 kg sausages
1 onion finely chopped
40 g butter
3 teaspoons curry powder
1 1/2 cups water
2 tablespoons plain flour
1 carrot grated
2 tablespoons Worcestershire sauce
1 tablespoon brown sugar
2 tablespoons brown vinegar

1. Pierce sausages with a fork twice. Arrange on microwave safe rack.
2. Cook sausages for 14 minutes on MEDIUM (50%), turning halfway through cooking. After cooking slice into rounds.
3. Mix sugar, vinegar, curry powder, flour Worcestershire sauce and water together in a jug.
4. In a 3 litre casserole dish combine butter, onions and cook for 3 minutes on MEDIUM HIGH (70%) or until onions become transparent.
5. Add carrots, sausages and sauce. Mix well and cook for a extra 6 minutes on MEDIUM (50%).
6. Serve hot with Basmati rice and pappadums.

SHEPHERD'S PIE

Serves 6-8

4 large potatoes (approx 1kg)
Butter
Milk
2 tablespoons fresh chives chopped
Salt and pepper
1 kg minced beef
1 onion diced
2 tablespoons gravy powder
250 g frozen mixed vegetables
1 tablespoon Worcestershire sauce
1 can chopped tomatoes
2 tablespoons chopped parsley
60 g grated cheddar cheese
salt and pepper to taste

1. Peel and cut potatoes into 2.5 cm cubes. Place in a large microwave safe glass bowl. Add 2 tablespoons water, cover and cook for 15 minutes on HIGH (100%) or until tender. Stir halfway through cooking. Drain.
2. Mash potatoes, add butter, milk, chives, salt and pepper until it forms a smooth consistency.
3. In a large bowl, combine mince and onion and cook for 9 minutes on 60% stirring every 2 minutes. Drain juice from meat.
4. Place frozen mixed vegetables in a shallow dish and cook for 3 minutes on 60%.
5. Add gravy powder, mixed vegetables, Worcestershire sauce, tomatoes, parsley and seasoning. Mix well.
6. Spoon mixture into a 25-20cm rectangular dish.
7. Spread mashed potato evenly over top of mixture. Sprinkle cheese on top.
8. Cook for 23 minutes on 60%.
9. Allow to stand covered with foil for 10 minutes before serving.

RECIPES

INDEX

MEAT

CHILLI CON CARNE	13
GOLDEN CURRY SAUSAGES	12
HONEY ROAST LAMB	13
LASAGNE	12
SHEPHERD'S PIE	12
SPECIAL FRIED RICE	13

POULTRY

CHICKEN PENNE SALAD	14
CHICKEN SKEWERS IN FAMOUS PEANUT SAUCE	15
CHICKEN WITH BACON AND LEEK SEASONING	14
CRUNCHY CAMEMBERT CHICKEN	15
HONEY CHICKEN LEGS	14
TANDOORI CHICKEN	14

SEAFOOD

BOUILLABAISSE	16
CHEESY SALMON CANNELLONI	16
CHILLI PRAWNS WITH SNOW PEAS	16
CRAB MORNAY	16
PRAWN CREOLE	16
SEAFOOD LAKSA	15
SMOKED SALMON FETTUCINE	15

VEGETABLES

CHILLI AND TOMATO SPAGHETTI	18
CHUNKY VEGETABLE SOUP	18
HONEY CARROTS	17
HONEY GINGERED VEGETABLES	17
POTATO, AVOCADO AND ONION SALAD	17
POTATO BAKE	18
THAI VEGETABLE NOODLE SOUP	18
VEGETABLE PLATTER	17

DESSERTS

BREAD AND BUTTER PUDDING	19
CARAMEL RICE PUDDING	19
CASHEW FUDGE	20
CHOCOLATE FUDGE CAKE	19
MOIST CARROT CAKE	19
PEPPERMINT CHOC HAZELNUT MOUSSE	19
PUMPKIN PIE	20

JAM

MIXED BERRY AND APPLE JAM	20
STRAWBERRY JAM	20





CHARTS

DEFROSTING	21
FROZEN VEGETABLE CHART	24
GENERAL INFORMATION	26-28
GLOSSARY OF TERMS	26
GUIDE TO COOKING EGGS	24
MICROWAVE: FRESH VEGETABLE CHART	23
MICROWAVE OVEN ROASTING CHART	22
REHEATING CONVENIENCE DEFROSTING CONVENIENCE-FOOD CHART	25
RICE AND PASTA COOKING CHART	24

EASY DEFROST MENU GUIDE

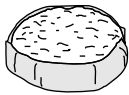
EASY DEFROST

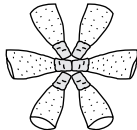
When you defrost the following menus with EASY DEFROST, press the EASY DEFROST pad until the desired menu appears in the display.

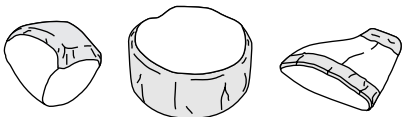
No.	Menu	Weight Range (kg's)	Procedure	Standing Time (minutes)
1	Mince Beef 	0.1-1.0	<ul style="list-style-type: none"> Place frozen mince on a defrost rack. Shield edges. When the oven stops, remove defrosted portions of mince, turn over and shield edges with foil strips. After defrost time, stand covered with aluminium foil. See NOTE below. 	5-15
2	Steak/Chops Fish Fillets 	0.1-1.0 0.2-0.6	<ul style="list-style-type: none"> Shield thin end of chops or steaks with foil. Position the food with thinner parts in the centre in a single layer on a defrost rack. If pieces are stuck together, try to separate as soon as possible. When the oven stops, remove defrosted pieces, turn over and shield the warm portions of remaining pieces. After defrost time, stand covered with aluminium foil. See NOTE below. 	5-15 (Steak/ Chops) 5-15 (Fish fillets)
3	Chicken Pieces 	0.2-1.0	<ul style="list-style-type: none"> Shield the exposed bone with foil. Place chicken pieces on a defrost rack. When the oven stops, remove any defrosted pieces, turn over and shield the warm portions of remaining pieces. After defrost time, stand covered with aluminium foil. See NOTE below. 	5-15
4	Whole Chicken 	1.0-2.0	<ul style="list-style-type: none"> Remove from original wrapper. Shield wing and leg tips with foil. Place breast side down on a defrost rack. When the oven stops, turn over and shield the warm portions. After defrost time, stand covered with aluminium foil. <p>N.B. After standing run under cold water to remove giblets if necessary.</p>	30-60
5	Roast Meat Beef/Pork Lamb 	1.0-2.0 1.0-2.0	<ul style="list-style-type: none"> Shield the bone and the edge with foil strips about 2.5cm wide. Place joint with lean side face upwards (if possible) on a defrost rack. When the oven stops, turn over and shield the warm portions. After defrost time, stand covered with aluminium foil. 	30-60

Foods not listed in the Guide can be defrosted manually using M•LOW setting.

NOTE: When freezing mince, shape it into flat even sizes.

For chicken pieces, steaks and chops, freeze separately in single flat layers and if necessary separate into layers with freezer plastic.





This will ensure even defrosting.

It is also a good idea to label the packs with the correct weights.

EXPRESS DEFROST MENU GUIDE

EXPRESS DEFROST

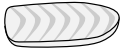
When you cook the following menus with EXPRESS MENUS, press the EXPRESS DEFROST pad until the desired menu appears in the display.

No.	Menu	 Weight Range	Initial Temperature (approx.) 	Procedure	 Standing Time (minutes)
1	Fish Fillets 	0.5 kg	- 18°C	<ul style="list-style-type: none"> Place fish fillets on a defrost rack. When the oven stops, turn over and separate into pieces. Shield warm portions with foil strips. After defrost time, stand covered with aluminium foil. 	10
2	Chicken Fillets 	0.5 kg	- 18°C	<ul style="list-style-type: none"> Place chicken fillets on a defrost rack. When the oven stops, turn over and separate into pieces. Shield warm portions with foil strips. After defrost time, stand covered with aluminium foil. 	10

NOTE: When freezing minced meat, shape it into flat even sizes.
For fish fillets, chicken fillets and sausages freeze separately in single flat layers and if necessary separate into layers with freezer plastic.
This will ensure even defrosting.
It is also a good idea to label the packs with the correct weights.

MELT/SOFTEN MENU GUIDE

MELT
SOFTEN

When you melt the following menus with MELT/SOFTEN, press the MELT/SOFTEN pad until the desired menu appears in the display.

No.	Menu	 Weight Range	Procedure
1	Butter	0.05-0.20 kg	<ul style="list-style-type: none">• Place into a microwave safe glass bowl (e.g. pyrex bowl).• Cook uncovered.• When oven stops and STIR is displayed, stir and continue cooking.• After cooking, stir.
2	Chocolate	0.05-0.20 kg	<ul style="list-style-type: none">• Place into a microwave safe glass bowl (e.g. pyrex bowl).• Cook uncovered.• When oven stops and STIR is displayed, stir and continue cooking.• After cooking, stir.
3	Cream Cheese	0.10-0.25 kg	<ul style="list-style-type: none">• Place into a microwave safe glass bowl (e.g. pyrex bowl).• Cook uncovered.• When oven stops and STIR is displayed, stir and continue cooking.• After cooking, stir.
4	Ice Cream	0.5-2.0 litres	<ul style="list-style-type: none">• Place into a microwave safe glass bowl (e.g. pyrex bowl).• Cook uncovered.• When oven stops and STIR is displayed, stir and continue cooking.• After cooking, stir.

QUICK AND EASY MEALS RECIPES

4. *Spinach and Ricotta Cannelloni*

- 1 250g packet frozen spinach, thawed and drained or 250g fresh spinach, finely chopped.
- 375 g reduced fat ricotta cheese
- 12 fresh cannelloni sheets
- pinch of ground nutmeg
- salt and pepper to season
- 500 g jar Summer Tomato Basil Pasta Sauce
- 75 g grated cheddar cheese

1. Place the ricotta cheese, spinach, nutmeg and seasoning in a bowl. Mix until well combined.
2. Place the mixture into a piping bag. Fill the cannelloni sheets by gently squeezing the piping bag until a thick line of mixture is produced along the edge of one side of the sheet. Gently roll the sheet until a tube is formed with the mixture in the middle. Place the tubes in a single layer in a shallow casserole dish.
3. Pour the pasta sauce over the tubes. Smooth over with the back of a spoon to ensure all sections of the tubes are covered with the sauce. Cover with lid. Cook on Quick and Easy Meals No.4 - "Spinach and Ricotta Cannelloni".
4. When the oven stops and ADD THE CHEESE is displayed, sprinkle the cheddar cheese over the top of the cannelloni and continue cooking, uncovered.
5. After cooking, stand covered for 2 minutes.
6. Serve with a green salad and a little freshly grated Parmesan cheese.

Serves 4

5. *Chicken Cacciatore*

- 6 chicken thigh fillets
- 1/4 cup plain flour
- 1 tablespoon salt and pepper
- 1 onion, sliced
- 30 g butter
- 1 clove garlic, crushed
- 2 tablespoons tomato paste
- 1 x 400 g can chopped tomatoes
- 2 chicken stock cubes
- 1/2 cup white wine
- sprig of fresh rosemary
- 1 green capsicum, thinly sliced
- lemon rind, to garnish

1. In a plastic bag, combine the chicken, flour and seasoned salt. Shake until the chicken is coated.
2. In a 3 litre microwave safe casserole dish, combine the chicken, any flour remaining in the bag, the onion, butter, garlic, tomato paste, the juice from the tomatoes, the stock cubes and the wine. Cover and cook on Quick and Easy Meals No.5 - "Chicken Cacciatore". When the oven stops and STIR is displayed, stir and continue cooking.
3. When the oven stops and STIR AND ADD TOMATO AND CAPSICUM is displayed, add the tomatoes with the capsicum to the chicken dish. Cover and continue cooking.
4. After cooking, garnish with lemon rind and the sprig of fresh rosemary. Serve with fresh bread.

Serves 6

6. *Lemon Fish Fillets*

- 4 x 150 g fish fillets
- 1 tablespoon lemon juice
- salt and pepper to taste
- 1 tablespoon fresh flat leaf parsley, finely chopped
- lemon rind, to garnish

1. Place the fish in a single layer into a shallow casserole dish.
2. Pour the lemon juice. Season with salt and pepper.
3. Cover with lid or plastic wrap. Cook on Quick and Easy Meals No. 6- "Lemon Fish Fillets".
4. When the oven stops and TURN OVER is displayed, turn the fish over and continue cooking.
5. After cooking, stand covered for 3 minutes.
6. Garnish with lemon rind, sprinkle with the parsley and serve with a green salad.

Serves 4

QUICK AND EASY MEALS RECIPES

1. *Garlic Prawns*

- 60 g butter
- 3 cloves garlic, crushed
- 24 green king prawns, peeled, tails intact, deveined (Approximately 500 g)
- 1 tablespoon chopped fresh parsley

1. Combine the butter and garlic in a large microwave-safe bowl. Cook on Quick and Easy Meals No.1- "Garlic prawns".
2. When the oven stops and ADD PRAWNS is displayed, add prawns and continue cooking.
3. When the oven stops and STIR is displayed, stir and continue cooking.
4. Serve in individual dishes sprinkled with parsley.

Serves 4

2. *Fish in Chinese Cabbage Leaves*

- 2 Chinese Cabbage Leaves, Rinsed
- 2 x 100 g fish fillets
- juice of half a lemon
- 1/2 teaspoon lemon zest
- 4 large continental parsley leaves
- lemon or lime wedge, to serve

Ginger Sauce:

- 1/2 teaspoon grated fresh ginger
- 2 tablespoons white wine
- 1/2 shallot, finely sliced
- 1/2 tablespoon light soy sauce
- 3 tablespoons water

1. In a small bowl, combine all of the sauce ingredients and mix well. Set aside to allow the flavours to develop.
2. Place the cabbage leaves directly onto the microwave turntable. Cook on Quick and Easy Meals No. 2 - Fish in Chinese Cabbage Leaves. When the oven stops, allow to stand until cool enough to handle.
3. Place each of the fish fillets in the centre of the cabbage leaf. Pour the lemon juice over the fish and sprinkle with the lemon zest and parsley. Wrap the fish in the leaves to make two parcels.
4. Place the fish parcels in a shallow microwave safe pie plate. Continue cooking.
5. After cooking, stand uncovered for 2 minutes.
6. Drizzle the ginger sauce over the fish parcels and serve with wedges of lemon or lime and rice.

Serves 2

3. *San Choy Bau*

- 1 tablespoon sesame oil
- 2 cloves garlic, grated
- 5 cm fresh ginger, finely chopped
- 500 g pork or chicken mince
- 100 g button mushrooms, finely diced
- 4 tablespoons oyster sauce
- 1 tablespoon finely chopped red capsicum
- 1 tablespoon finely chopped green capsicum
- 1 x 240 g can water chestnuts, drained and finely diced
- 3 teaspoons fish sauce
- 50 g bean sprouts
- 2 green onions, sliced
- 1 teaspoon chopped fresh coriander (cilantro)
- 12 evenly sized iceberg lettuce leaves, washed



1. Place the oil, garlic and ginger into a large microwave-safe bowl. Cook on Quick and Easy Meals No.3- "San choy bau"
2. When the oven stops and ADD MINCE is displayed, add the mince and separate with a fork and continue cooking.
3. When the oven stops and STIR is displayed, stir mince and continue cooking.
4. When the oven stops and STIR AND ADD MUSHROOMS is displayed, stir and add mushrooms, and continue cooking.
5. When the oven stops and ADD REMAINING INGREDIENTS EXCEPT LETTUCE is displayed, add the remaining ingredients, except the lettuce, and combine well, and continue cooking.
6. After cooking, stand for 2 minutes.
7. Place a few spoonfuls of the cooked mixture in the centre of each lettuce leaf and roll up to eat.

Serves 4-6

RICE / PASTA MENU GUIDE

RICE
PASTA

When you cook the following menus with SENSOR COOK, press the RICE/PASTA pad until the desired menu appears in the display.

No.	Menu	Weight Range 	Initial Temperature (approx.) 	Procedure	Standing Time (minutes) 														
1	White Rice	1/2 - 4 cups	+60°C hot tap water or soup stock	<ul style="list-style-type: none"> Wash rice until water runs clear. Place into a microwave safe glass bowl and cover with hot tap water or soup stock. Cook uncovered. After cooking stand and stir. 	3-5														
	<table border="1"> <tr> <td>Rice</td> <td>1/2 cup</td> <td>1 cup</td> <td>1 1/2 cups</td> <td>2 cups</td> <td>3 cups</td> <td>4 cups</td> </tr> <tr> <td>Hot tap water or soup stock (1 cup=250ml)</td> <td>1 1/2 cups</td> <td>2 cups</td> <td>3 cups</td> <td>4 cups</td> <td>4 1/2 cups</td> <td>6 cups</td> </tr> </table>	Rice	1/2 cup			1 cup	1 1/2 cups	2 cups	3 cups	4 cups	Hot tap water or soup stock (1 cup=250ml)	1 1/2 cups	2 cups	3 cups	4 cups	4 1/2 cups	6 cups		
Rice	1/2 cup	1 cup	1 1/2 cups	2 cups	3 cups	4 cups													
Hot tap water or soup stock (1 cup=250ml)	1 1/2 cups	2 cups	3 cups	4 cups	4 1/2 cups	6 cups													
2	Dry Pasta	1/2 - 4 cups	+60°C hot tap water	<ul style="list-style-type: none"> Place into a microwave safe glass bowl and cover with hot tap water. Cook uncovered. After cooking, stand and stir. 	3-5														
	<table border="1"> <tr> <td>Pasta</td> <td>1/2 cup</td> <td>1 cup</td> <td>1 1/2 cups</td> <td>2 cups</td> <td>3 cups</td> <td>4 cups</td> </tr> <tr> <td>Hot tap water (1 cup=250ml)</td> <td>1 1/2 cups</td> <td>2 cups</td> <td>3 cups</td> <td>4 cups</td> <td>5 cups</td> <td>6 cups</td> </tr> </table>	Pasta	1/2 cup			1 cup	1 1/2 cups	2 cups	3 cups	4 cups	Hot tap water (1 cup=250ml)	1 1/2 cups	2 cups	3 cups	4 cups	5 cups	6 cups		
Pasta	1/2 cup	1 cup	1 1/2 cups	2 cups	3 cups	4 cups													
Hot tap water (1 cup=250ml)	1 1/2 cups	2 cups	3 cups	4 cups	5 cups	6 cups													
3	Fresh Pasta Tortellini Ravioli Fettuccine	1/2 - 4 cups	+60°C hot tap water	<ul style="list-style-type: none"> Place into a microwave safe glass bowl and cover with hot tap water. Cook uncovered. When oven stops and STIR is displayed, stir and continue cooking. After cooking, stand and stir. 	3-5														
	<table border="1"> <tr> <td>Pasta</td> <td>1/2 cup</td> <td>1 cup</td> <td>1 1/2 cups</td> <td>2 cups</td> <td>3 cups</td> <td>4 cups</td> </tr> <tr> <td>Hot tap water (1 cup=250ml)</td> <td>1 1/2 cups</td> <td>2 cups</td> <td>3 cups</td> <td>4 cups</td> <td>5 cups</td> <td>6 cups</td> </tr> </table>	Pasta	1/2 cup			1 cup	1 1/2 cups	2 cups	3 cups	4 cups	Hot tap water (1 cup=250ml)	1 1/2 cups	2 cups	3 cups	4 cups	5 cups	6 cups		
Pasta	1/2 cup	1 cup	1 1/2 cups	2 cups	3 cups	4 cups													
Hot tap water (1 cup=250ml)	1 1/2 cups	2 cups	3 cups	4 cups	5 cups	6 cups													
4	Frozen Pasta Tortellini Ravioli	1/2 - 4 cups	+60°C hot tap water	<ul style="list-style-type: none"> Place into a microwave safe glass bowl and cover with hot tap water. Cook uncovered. When oven stops and STIR is displayed, stir and continue cooking. After cooking, stand and stir. 	3-5														
	<table border="1"> <tr> <td>Pasta</td> <td>1/2 cup</td> <td>1 cup</td> <td>1 1/2 cups</td> <td>2 cups</td> <td>3 cups</td> <td>4 cups</td> </tr> <tr> <td>Hot tap water (1 cup=250ml)</td> <td>1 1/2 cups</td> <td>2 cups</td> <td>3 cups</td> <td>4 cups</td> <td>5 cups</td> <td>6 cups</td> </tr> </table>	Pasta	1/2 cup			1 cup	1 1/2 cups	2 cups	3 cups	4 cups	Hot tap water (1 cup=250ml)	1 1/2 cups	2 cups	3 cups	4 cups	5 cups	6 cups		
Pasta	1/2 cup	1 cup	1 1/2 cups	2 cups	3 cups	4 cups													
Hot tap water (1 cup=250ml)	1 1/2 cups	2 cups	3 cups	4 cups	5 cups	6 cups													

JACKET POTATO MENU GUIDE

JACKET POTATO

When you cook the following menus with SENSOR COOK, press the JACKET POTATO pad.

1	Jacket Potato Potato (whole)	1-8 pieces 1 piece, approx. 180-200 g	+ 20°C Room temperature	<ul style="list-style-type: none"> Use washed new potatoes. Pierce twice with fork on each side. Place on outside of turntable. When oven stops and TURN, OVER is displayed, turn potatoes over and continue cooking. After cooking, stand covered with aluminium foil. <p><u>N.B.</u> For small quantities, the food may not require a turn over during cooking.</p>	3-10
---	--	---	----------------------------	--	------



SENSOR COOK MENU GUIDE

The final cooking result will vary according to the food condition (e.g. initial temperature, shape, quality). Check the food after cooking and if necessary continue cooking manually.

FRESH VEGETABLES MENU GUIDE

FRESH VEGETABLES

When you cook the following menus with SENSOR COOK, press the FRESH VEGETABLES pad until the desired menu appears in the display.

No.	Menu	Weight Range 	Initial Temperature (approx.) 	Procedure	Standing Time (minutes) 
1	Hard Vegetables Carrots Cauliflower Beans Pumpkin Brussels Sprouts	0.1-1.0 kg	+ 3°C Refrigerared	<ul style="list-style-type: none"> Wash the vegetables. Arrange the vegetables in a shallow dish. Cover with plastic wrap. After cooking, stir then stand covered. 	1-5
2	Soft Vegetables Zucchini Squash Capsicum Mushroom Eggplant Broccoli	0.1-1.0 kg	+ 3°C Refrigerared	<ul style="list-style-type: none"> Wash the vegetables. Pierce skin of squash with fork. Arrange the vegetables in a shallow dish. Cover with plastic wrap. After cooking, stir then stand covered. 	1-5









FROZEN VEGETABLES MENU GUIDE

FROZEN VEGETABLES

When you cook the following menus with SENSOR COOK, press the FROZEN VEGETABLES pad until the desired menu appears in the display.







1	Mixed Small Vegetables Peas Corn Diced carrot	0.1-10 kg	- 18°C	<ul style="list-style-type: none"> Before cooking, separate vegetables as much as possible. Arrange the vegetables in a shallow dish. Cover with plastic wrap. After cooking, stir then stand covered. 	1-5
2	Mixed Chunky Vegetables Broccoli Sliced carrots Cauliflower Beans	0.1-10 kg	- 18°C	<ul style="list-style-type: none"> Before cooking, separate vegetables eg. broccoli as much as possible. Arrange the vegetables in a shallow dish. Cover with plastic wrap. After cooking, stir then stand covered. 	1-5

SENSOR INSTANT ACTION MENU GUIDE

No.	Pad	Menu	 Weight Range	 Initial Temperature (approx.)	Procedure	 Standing Time (minutes)										
1	 x 1	Reheat Dinner Plate	1 serve (approx. 400 g)	+ 3°C Refrigerated	<ul style="list-style-type: none"> • Cover with plastic wrap. • After cooking, stand covered. 	5										
			<table border="1" style="width: 100%; border-collapse: collapse;"> <thead> <tr> <th style="width: 33%;">MEAT</th> <th style="width: 33%;">POTATO</th> <th style="width: 33%;">VEGETABLES</th> </tr> </thead> <tbody> <tr> <td style="text-align: center;">175-180g</td> <td style="text-align: center;">125g</td> <td style="text-align: center;">100g</td> </tr> <tr> <td style="text-align: center;">Beef, Lamb Chicken, T-Bone</td> <td style="text-align: center;">sliced</td> <td style="text-align: center;">2 varieties eg. sliced Carrot, Zucchini Broccoli</td> </tr> </tbody> </table>	MEAT	POTATO	VEGETABLES	175-180g	125g	100g	Beef, Lamb Chicken, T-Bone	sliced	2 varieties eg. sliced Carrot, Zucchini Broccoli				
MEAT	POTATO	VEGETABLES														
175-180g	125g	100g														
Beef, Lamb Chicken, T-Bone	sliced	2 varieties eg. sliced Carrot, Zucchini Broccoli														
2	 x 1	Reheat Casserole Casserole Beef Stroganoff Chicken Fricasse Canned Food Baked Beans Spaghetti	1 – 4 cups (1 cup, 250 ml)	+ 3°C Refrigerated	<ul style="list-style-type: none"> • Place into a casserole dish, and cover with plastic wrap and pierce 5 times with skewer. • After cooking, stand covered then stir. 	1-5										
3	 x 1	Reheat Thin Soup Pumpkin, Tomato	1 – 4 cups (1 cup, 250 ml)	+ 20°C Refrigerated	<ul style="list-style-type: none"> • Place in a microwave safe glass bowl. • Cover with plastic wrap and pierce 5 times with a skewer. • Press REHEAT SOUP pad once for Thin Soup. • After cooking, stir. 	-										
4	 x 2	Reheat Thick Soup Pumpkin, Cream of chicken and corn	1 – 4 cups (1 cup, 250 ml)	+ 20°C Room temperature	<ul style="list-style-type: none"> • Place in a microwave safe glass bowl. • Cover with plastic wrap and pierce 5 times with a skewer. • Press REHEAT SOUP pad twice for Thick Soup. • After cooking, stir. 	-										
5	 x 1	Reheat Pizza	1 – 4 pieces (1 piece, approx. 90 g)	+ 3°C Refrigerated	<ul style="list-style-type: none"> • Place pizza on paper towel on the turntable. 	-										

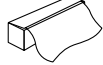
Final cooking results will vary according to the conditions of food (e.g. initial temperature, shape, quality), utensils and the oven. Please check the cooking result and if necessary, extend cooking times by manual Microwave.

COOKWARE AND UTENSIL GUIDE

Utensil	Use	Advice
GLASSWARE/CERAMIC (HEAT RESISTANT) 	YES	GLASSWARE <ul style="list-style-type: none"> • Ordinary glass is not suitable for cooking but may be used for short periods for heating foods. CERAMIC <ul style="list-style-type: none"> • Most ovenproof china, and ceramics, are suited. • Avoid dishes that are decorated with gold or silver leaf. • Avoid using antique pottery. • If unsure, check with the manufacturer.
METAL COOKWARE 	NO	<ul style="list-style-type: none"> • Metal cookware should be avoided when cooking in the microwave oven. • Microwave energy is reflected by metal.
PLASTIC WRAP/ OVEN BAGS (MICROWAVE) (SAFE ONLY) 	YES	<ul style="list-style-type: none"> • Plastic wrap can be used to cover food. • Some shrinkage of the wrap may occur, over an extended cooking time. • When removing wrap, lift it in such a way to avoid steam burns. • Do not tie oven bags with metal twist ties, substitute with string. • For cooking food with high fat content, do not bring the wrap in contact with the food as it may melt.
ALUMINIUM FOIL 	FOR SHIELDING	<ul style="list-style-type: none"> • Small amounts may be used to shield certain parts of meat and fish when cooking or defrosting. • Remove food in foil trays, if possible, and place in a microwave safe dish. • If not possible, place the foil tray onto a heat proof plate allowing 2.5 cm between the walls of the oven.
STRAW AND WOOD 	NO	<ul style="list-style-type: none"> • Excessive over heating of these materials may cause a fire in the microwave oven.
PAPER 	YES	<ul style="list-style-type: none"> • Paper towels and waxed paper are suitable to use to prevent splatters. • These are suitable for use when reheating foods or for short cooking times.
PLASTIC COOKWARE MICROWAVE SAFE 	YES	<ul style="list-style-type: none"> • Ideal for cooking, reheating and defrosting. • Some microwave safe plastic cookware are not suitable for cooking foods with high fat and sugar content.
BROWNING DISH	YES	<ul style="list-style-type: none"> • Ensure that the preheating time of the dish is not exceeded. • Ensure that a microwave heat proof dinner plate or suitable insulator be placed between the turntable and the browning dish.
THERMOMETERS <ul style="list-style-type: none"> • MICROWAVE SAFE • CONVENTIONAL 	YES NO	

COOKING GUIDES

HELPFUL HINTS ①	COOKWARE AND UTENSIL GUIDE ②	SENSOR INSTANT ACTION MENU GUIDE ③	SENSOR COOK MENU GUIDE ④,⑤	QUICK AND EASY MEALS RECIPE ⑥,⑦	MELT/SOFTEN MENU GUIDE ⑧	EXPRESS DEFROST MENU GUIDE ⑨	EASY DEFROST MENU GUIDE ⑩	RECIPES ⑪~⑳
--------------------	------------------------------------	--	----------------------------------	---------------------------------------	--------------------------------	------------------------------------	---------------------------------	----------------

HELPFUL HINTS

1. THE ARRANGEMENT

Arrange foods carefully. Place thickest areas toward outside of dish.

3. COVERING

Cover foods in the microwave if you would normally cover the food in your ordinary oven, or to retain moisture. Cover foods such as Vegetables, Casseroles, or when Reheating.

5. SHIELDING

Shield using small pieces of aluminium foil to shield thin areas of meat, fish and poultry or edges of cakes to prevent overcooking.

7. STIRRING

Stir foods from the outside to the centre of the dish, once or twice during cooking if possible.
Eg. Casseroles and Sauces.

9. DENSITY

The depth to which microwaves penetrate food varies depending on the food's density. Porous foods like minced beef or mashed potatoes microwave faster than dense ones like steak or whole potatoes.

11. STARTING TEMPERATURE

Frozen or refrigerated foods take longer to heat than food at room temperature. Cooking times in this book are based on normal storage temperatures. Since rooms, refrigerators and freezers differ in temperature, check cooking result at the minimum time.

13. CONDENSATION

Condensation is a normal part of microwave cooking. The humidity and moisture in food will influence the amount of condensation in the oven. Generally, covered foods will not cause as much condensation as uncovered foods. Ensure that the ventilation openings are not blocked.

2. TURNING

Foods such as poultry and joints of meat should be turned over after half the cooking time.

4. PIERCING

Pierce potatoes, eggs, tomatoes or any foods with a skin or membrane to allow steam to escape.

6. STANDING TIME

Standing time is important. After cooking or defrosting ensure adequate standing time. This allows the food to continue cooking or heating. Refer to cooking guides for each menu or according to manufacturers instructions.

8. SIZE

Small pieces cook faster than large ones. To speed up cooking, cut pieces smaller than 5 cm so microwaves can penetrate to the centre from all sides. For even cooking, make all the pieces the same size.

10. FAT AND BONE

Marbling within meat, or a thin, even layer of fat on a roast, speeds cooking. Large fatty areas or excess drippings in dish attract energy away from meat, and slows cooking. Centre bones do not affect cooking, but bone on the side of meat conducts heat to the areas next to it.































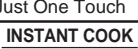

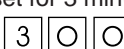

12. QUANTITY

Microwave cooking times are directly related to the amount of food in the oven. Because energy is absorbed by the food itself, one potato or a single piece of chicken cooks rapidly. When the energy is divided among several items, cooking takes more time.

14. GENERAL

Your microwave oven is capable of heating food and beverages very quickly therefore, it is very important that you select the appropriate cooking time and power level for the type and quantity of food to be heated. If you are unsure of the cooking time and power level required, begin with low cooking times and power levels until the food is sufficiently heated evenly throughout.

QUICK REFERENCE GUIDE

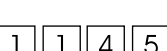
FEATURE	QUICK OPERATION GUIDE
Sensor Instant Action	To reheat 1 cup of thin soup.  x 1
Sensor Cook	To reheat 1 soft vegetable.  x 2 → 
Quick and Easy Meals	To cook Lemon Fish Fillets.  x 6 → 
Melt/Soften	To melt 0.1kg Chocolate.  x 2 →  → 
Express Defrost	To defrost 0.5kg of Chicken Fillets. Menu  x 2 → 
Easy Defrost	To defrost 1.0kg of Chicken Pieces. Menu  x 3 →  → 
Less/More Setting For Sensor Instant Action	For More setting  →  x 1 or  x 2 For Less setting Within 2 seconds
Less/More Setting For Sensor Cook, Quick and Easy Meals, Melt Soften, Express Defrost, Easy Defrost	Menu  x 3 →  eg. 1.0 kg →  x 1 or  x 2 →  eg. Chicken Pieces * Press POWER LEVEL pad before pressing INSTANT COOK/START pad.
Instant Cook	Just One Touch  Within 3 minutes of closing the door, cooking completion or pressing the STOP/CLEAR pad.
Variable Cooking Control	To soften Cream or Butter for 40 seconds on 30%. Cooking Time  →  x 8 → 
Timer	To set for 3 minutes.  → 
Child Lock	To lock.  →  →  Press for 3 seconds To unlock.  →  →  Press for 3 seconds
Clock	To set for 11:45 am  →  →  → 