

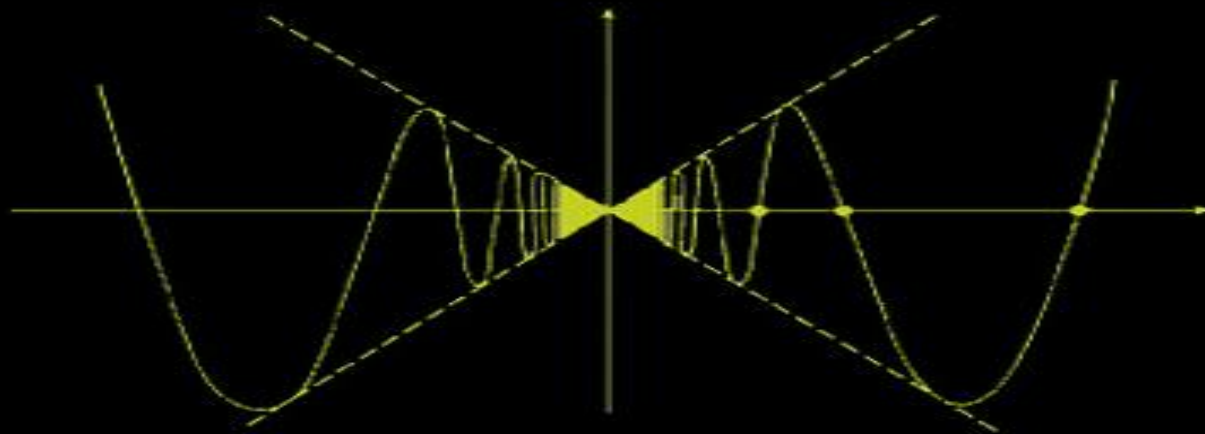



# ANALISIS REAL 2 TERJEMAHAN DAN PEMBAHASAN

FOURTH EDITION



**Dari Introduction To Real Analysis**  
**Robert G. Bartle I Donald R. Sherbert**

**OLEH: AREZQI TUNGGAL ASMANA, S.Pd., M.Pd.**

**Tahun 2018**

# **ANALISIS REAL 2: TERJEMAHAN DAN PEMBAHASAN**

**Dari: Introduction to Real Analysis (Fourth Edition) Oleh: Robert G. Bartle dan Donald R. Sherbert**

**Oleh: Arezqi Tunggal Asmana, S.Pd., M.Pd.**

**Bagi:**

**Para Mahasiswa**

**Para Guru atau Dosen**

**Tahun 2018**

## KATA PENGANTAR

Puji syukur kami haturkan atas keridhoan Allah SWT. Sampai saat ini masih memberikan kenikmatan sepanjang zaman yaitu nikmat iman dan islam karena dengan kedua nikmat inilah kita manusia dapat menjalani hidup dunia dan di akhirat yakni selamat dunia dan akhirat.

Shalawat serta salam senaniasa terlimpahkan kepada nabi Muhammad SAW yang telah menyebarkan agama Islam dengan tetesan darah dan kucuran keringat beserta keluarga dan sahabat yang selalu setia sampai akhir zaman.

Dengan ridho Allah buku Analisis Real 2 ini dapat penulis selesaikan tentunya juga ada beberapa pihak yang sangat membantu dan memberikan dukungan dalam menyelesaikan Buku ini sehingga perlu kiranya penyusun mengucapkan terima kasih kepada:

1. Ayah dan Ibu tercinta yang selalu memberikan dukungan serta do'a dalam penulisan buku.
2. Teman-temanku di Universitas Islam Darul 'Ulum Lamongan atas kebersamaan dan kerja samanya sehingga dapat terselesaikan.
3. Tak lupa pula ucapan terimakasih kepada Mahasiswa Angkatan Tahun 2014 dan 2015.

Akhirnya semoga Buku yang berisi materi seperti di buku *Introduction to Real Analysis (Fourth Edition)* untuk Bab 4 ini dapat bermanfaat bagi penulis khususnya dan umumnya kepada Semuanya.

Lamongan, 22 Juni 2018

Penyusun

Editor : Khoristiana Widyawati

Desainer Sampul : Khoristiana Widyawati

Isi Buku : FKIP MATEMATIKA PAGI TA.2014 dan TA.2015

Buku *Analisis Real 2* dari ***INTRODUCTION TO REAL ANALYSIS ROBERT G.BAERTLE / DONALD R. SHERBER*** di sertai dengan pembuktian dan pembahasan ini dibuat Tahun 2018 yang tercantum adalah **BAB 4** yang di bimbing oleh Bapak **Arezqi Tunggal Asmana, S.Pd., M.Pd.**

## CONTENTS

<b>CHAPTER 4 LIMITS</b>	<b>1</b>
Section 4.1 Limits Of Functions	4
4.1.1 Definition	4
4.1.2 Theorem	6
4.1.3 Example	13
4.1.4 Definition	15
4.1.5 Theorem	18
4.1.6 Theorem	21
4.1.7 Example	22
4.1.8 Theorem	33
4.1.9 Divergen Criteria	36
4.1.10 Example	37
<b>Exercises for Section 4.1</b>	<b>43</b>
Section 4.2 Limits Theorem	46
4.2.1 Definition	46
4.2.2 Theorem	47
4.2.3 Definition	49
4.2.4 Theorem	50
4.2.5 Example	56
4.2.6 Theorem	64
4.2.7 Squeeze Theorem	65
4.2.8 Example	67
4.2.9 Theorem	73
<b>Exercises for Section 4.2</b>	<b>74</b>
Section 4.3 Some Extensions Of the Limits Concept	77
4.3.1 Definition	77
4.3.2 Theorem	80
4.3.3 Theorem	83
4.3.4 Example	85
4.3.5 Definition	91

## DAFTAR ISI

<b>BAB 4 LIMIT</b>	<b>1</b>
Bagian 4.1 Fungsi Limit	4
4.1.1 Definisi	4
4.1.2 Teorema	6
4.1.3 Contoh	13
4.1.4 Definisi	15
4.1.5 Teorema	18
4.1.6 Teorema	21
4.1.7 Contoh	22
4.1.8 Teorema	33
4.1.9 Kriteria Divergen	36
4.1.10 Contoh	37
<b>Latihan Soal 4.1</b>	<b>43</b>
Bagian 4.2 Teorema Limit	46
4.2.1 Definisi	46
4.2.2 Teorema	47
4.2.3 Definisi	49
4.2.4 Teorema	50
4.2.5 Contoh	56
4.2.6 Teorema	64
4.2.7 Teorema Apit	65
4.2.8 Contoh	67
4.2.9 Teorema	73
<b>Latihan Soal 4.2</b>	<b>74</b>
Bagian 4.3 Beberapa Ekstensi dari Konsep Limit	77
4.3.1 Definisi	77
4.3.2 Teorema	80
4.3.3 Teorema	83
4.3.4 Contoh	85
4.3.5 Definisi	91

4.3.6 Example	91
4.3.7 Theorem	92
4.3.8 Definition	94
4.3.9 Example	95
4.3.10 Definition	97
4.3.11 Theorem	99
4.3.12 Example	101
4.3.13 Definition	103
4.3.14 Theorem	104
4.3.15 Theorem	106
4.3.16 Example	108

**Exercises for Section 4.3 111**

**REFERENCE 370**

4.3.6 Contoh	91
4.3.7 Teorema	92
4.3.8 Definisi	94
4.3.9 Contoh	95
4.3.10 Definisi	97
4.3.11 Teorema	99
4.3.12 Contoh	101
4.3.13 Definisi	103
4.3.14 Teorema	104
4.3.15 Teorema	106
4.3.16 Contoh	108

**Latihan soal 4.3 111**

**DAFTAR PUSTAKA 370**

## CHAPTER 4

## LIMITS

## LIMIT

“Mathematical analysis” is generally understood to refer to that area of mathematics in which systematic use is made of various limiting concepts. In the preceding chapter we studied one of these basic limiting concepts: the limit of a sequence of real numbers. In this chapter we will encounter the notion of the limit of a function.

The rudimentary notion of a limiting process emerged in the 1680s as Isaac Newton (1642-1727) and Gottfried Leibniz (1646-1716) struggled with the creation of the Calculus. Though each person’s work was initially unknown to the other and their creative insights were quite different, both realized the need to formulate a notion of function and the idea of quantities being “close to” one another. Newton used the word “fluent” to denote a relationship between variables, and in his major work *Principia* in 1687 he discussed limits “to which they approach nearer than by any given difference, but never go beyond, nor in effect attain to, till the quantities are diminished *in infinitum*.” Leibniz introduced the term “function” to indicate a quantity that depended on a variable, and he invented “infinitesimally small” numbers as a way of handling the concept of a limit. The term “function” soon became standard terminology, and Leibniz also introduced the term “calculus” for this new method of calculation.

In 1748, Leonhard Euler (1707–1783) published his two-volume treatise *Introductio in Analysin Infinitorum*, in which he

“Analisis matematika” umumnya dipahami untuk merujuk pada bidang matematika dimana penggunaan sistematis dibuat dari berbagai konsep yang membatasi. Pada bab sebelumnya kita telah mempelajari salah satu konsep dasar yang membatasi ini: batas urutan bilangan asli. Dalam bab ini kita akan menemukan gagasan tentang batas fungsi.

Gagasan yang belum sempurna dari proses yang membatasi muncul pada 1680-an ketika Isaac Newton (1642-1727) dan Gottfried Leibniz (1646-1716) berjuang dengan penciptaan Kalkulus. Meskipun pekerjaan masing-masing pada awalnya tidak diketahui oleh yang lain dan wawasan kreatif mereka sangat berbeda, keduanya menyadari kebutuhan untuk merumuskan gagasan fungsi dan gagasan kuantitas menjadi “dekat dengan” satu sama lainnya. Newton menggunakan kata “fasih” untuk menunjukkan hubungan antara variabel, dan dalam karya utamanya *Principia* pada 1687 ia membahas batas “yang mereka mendekati lebih dekat daripada dengan perbedaan yang diberikan, tetapi tidak pernah melampaui, atau tidak berpengaruh mencapai, sampai jumlah berkurang *di infinitum*.” Leibniz memperkenalkan istilah “fungsi” untuk menunjukkan kuantitas yang bergantung pada suatu variabel, dan ia menciptakan angka “sangat kecil” sebagai cara menangani konsep batas. Istilah “fungsi” segera menjadi terminologi standar, dan Leibniz juga memperkenalkan istilah “kalkulus” untuk metode penghitungan baru ini.

Pada tahun 1748, Leonhard Euler (1707–1783) menerbitkan



discussed power series, the exponential and logarithmic functions, the trigonometric functions, and many related topics. This was followed by *Institutiones Calculi Differentialis* in 1755 and the three-volume *Institutiones Calculi Integralis* 1768–1770. These works remained the standard textbooks on calculus for many years. But the concept of limit was very intuitive and its looseness led to a number of problems. Verbal descriptions of the limit concept were proposed by other mathematicians of the era, but none was adequate to provide the basis for rigorous proofs.

In 1821, Augustin-Louis Cauchy (1789–1857) published his lectures on analysis in his *Cours d'Analyse*, which set the standard for mathematical exposition for many years. He was concerned with rigor and in many ways raised the level of precision in mathematical discourse. He formulated definitions and presented arguments with greater care than his predecessors, but the concept of limit still remained elusive. In an early chapter he gave the following definition:

If the successive values attributed to the same variable approach indefinitely a fixed value, such that they finally differ from it by as little as one wishes, this latter is called the limit of all the others.

The final steps in formulating a precise definition of limit were taken by Karl Weierstrass (1815–1897). He insisted on precise language and rigorous proofs, and his definition of limit is the one we use today.

pengantar risalah dua jilidnya di *Analysin Infinitorum*, di mana ia membahas seri daya, fungsi eksponensial dan logaritma, fungsi trigonometri, dan banyak topik terkait. Hal ini diikuti oleh *Institutiones Calculi Differentialis* pada tahun 1755 dan tiga jilid *Institutiones Calculi Integralis* 1768–1770. Karya-karya ini tetap menjadi buku teks standar tentang kalkulus selama bertahun-tahun. Tapi konsep limit sangat intuitif dan kelonggarannya menyebabkan sejumlah masalah. Deskripsi verbal dari konsep batasan diajukan oleh ahli matematika lainnya di era tersebut, tapi tidak ada yang memadai untuk memberikan dasar untuk bukti yang ketat.

Pada tahun 1821, Augustin-Louis Cauchy (1789–1857) mempublikasikan ceramahnya tentang analisis di *Cours d'Analyse*, yang menetapkan standar untuk eksposisi matematis selama bertahun-tahun. Dia prihatin dengan ketelitian dan dalam banyak hal meningkatkan tingkat presisi dalam wacana matematis. Dia merumuskan definisi dan mempresentasikan argumen dengan perhatian lebih besar dari pendahulunya, namun konsep batasan masih tetap sulit di pahami. Pada bab awal dia memberikan definisi baru:

Jika nilai-nilai yang berturut-turut dikaitkan dengan pendekatan variabel yang sama tanpa batas nilai tetap, sehingga mereka akhirnya mereka berbeda dari yang diinginkan, yang terakhir ini disebut batas dari semua yang lain.

Langkah terakhir dalam merumuskan definisi batas yang tepat diambil oleh Karl Weierstrass (1815–1897). Ia menekankan pada bahasa yang tepat dan bukti yang teliti, dan definisi batasnya adalah yang kita gunakan saat ini.

**Gottfried Leibniz**

Gottfried Wilhelm Leibniz (1646–1716) was born in Leipzig, Germany. He was six years old when his father, a professor of philosophy, died and left his son the key to his library and a life of books and learning. Leibniz entered the University of Leipzig at age 15, graduated at age 17, and received a Doctor of Law degree from the University of Altdorf four years later. He wrote on legal matters, but was more interested in philosophy. He also developed original theories about language and the nature of the universe. In 1672, he went to Paris as a diplomat for four years. While there he began to study mathematics with the Dutch mathematician Christiaan Huygens. His travels to London to visit the Royal Academy further stimulated his interest in mathematics. His background in philosophy led him to very original, though not always rigorous, results.



Unaware of Newton's unpublished work, Leibniz published papers in the 1680s that presented a method of finding areas that is known today as the Fundamental Theorem of Calculus. He coined the term "calculus" and invented the  $dy/dx$  and elongated S notations that are used today. Unfortunately, some followers of Newton accused Leibniz of plagiarism, resulting in a dispute that lasted until Leibniz's death. Their approaches to calculus were quite different and it is now evident that their discoveries were made independently. Leibniz is now renowned for his work in philosophy, but his mathematical fame rests on his creation of the calculus.

**Gottfried Leibniz**

Gottfried Wilhelm Leibniz (1646–1716) lahir di Leipzig, Jerman. Dia berusia enam tahun ketika ayahnya, seorang professor filsafat, meninggal dan memberi anaknya kunci untuk pindah ke Universitas Leibzig pada usia 15 tahun, lulus pada usia 17 tahun, dan mendapatkan gelar Doctor Hukum dari University Altdorf empat tahun kemudian. Dia menulis tentang masalah hukum, tetapi lebih tertarik pada filosofi. Dia juga mengembangkan teori asli tentang bahasa dan sifat alam semesta. Pada 1672, ia pergi ke Paris sebagai diplomat selama empat tahun. Sementara disini ia mulai belajar matematika dengan matematikawan Belanda Christiaan Huygens. Perjalanannya ke London untuk mengunjungi Royal Academy lebih lanjut mendorong minatnya dalam matematika. Latar belakangnya dalam filsafat membawanya ke hasil yang sangat asli, meskipun tidak selalu ketat.



Tidak mengetahui pekerjaan yang tidak dipublikasikan Newton. Leibniz menerbitkan makalah di tahun 1680-an mempresentasikan metode menemukan daerah yang dikenal saat ini sebagai Teorema Fundamental kalkulus. Ia menciptakan istilah "kalkulus" dan menemukan  $dy/dx$  dan notasi S memanjang yang digunakan saat ini. Sayangnya, beberapa pengikut Newton menuduh Leibniz plagiarisme, mengakibatkan perselisihan yang berlangsung sampai kematian Leibniz. Pendekatan mereka ke kalkulus sangat berbeda dan sekarang terbukti bahwa penemuan mereka dibuat secara sungguh-sungguh. Leibniz sekarang terkenal karena bekerja dalam filsafat, tetapi ketenaran matematisannya bersandar pada ciptaannya dari kalkulus.

## Section 4.1 Limits of Functions

## Bagian 4.1 Fungsi Limit

In this section we will introduce the important notion of the limit of a function. The intuitive idea of the function  $f$  having a limit  $L$  at the point  $c$  is that the values  $f(x)$  are close to  $L$  when  $x$  is close to (but different from)  $c$ . But it is necessary to have a technical way of working with idea of “close to” and this is accomplished in the  $\varepsilon - \delta$  definition given below.

In order for the idea of the limit of a function  $f$  at point  $c$  to be meaningful, it is necessary that  $f$  be defined at points near  $c$ . It need not be defined at the point  $c$ , but it should be defined at enough points close to  $c$  to make the study interesting. This is the reason for the following definition.

**4.1.1 Definition** Let  $A \subseteq \mathbb{R}$ . A point  $c \in \mathbb{R}$  is a **cluster point** of  $A$  if for every  $\delta > 0$  there exists at least one point  $x \in A$ ,  $x \neq c$  such that  $|x - c| < \delta$ .

This definition is rephrased in the language of neighborhoods as follows: A point  $c$  is a cluster point of the set  $A$  if every  $\delta$ -neighborhood  $V_\delta(c) = (c - \delta, c + \delta)$  of  $c$  contains at least one point of  $A$  distinct from  $c$ .

**Note** The point  $c$  may or may not be a member of  $A$ , but even if it is in  $A$ , it is ignored when deciding whether it is a cluster point of  $A$  or not, since we explicitly require that there be points in

Pada bagian ini akan memperkenalkan pengertian penting tentang limit suatu fungsi. Ide intuitif dari fungsi  $f$  yang mewakili batas  $L$  pada titik  $c$  adalah bahwa nilai  $f(x)$  mendekati  $L$  jika  $x$  mendekati (tapi berbeda dari)  $c$ . Tetapi perlu memiliki cara teknis untuk bekerja dengan gagasan “dekat dengan” dan ini dicapai dalam definisi  $\varepsilon - \delta$  yang diberikan dibawah ini.

Agar gagasan tentang limit suatu fungsi  $f$  pada titik  $c$  menjadi bermakna, perlu  $f$  didefinisikan pada titik-titik didekat  $c$ . Ini tidak perlu didefinisikan pada titik  $c$ , tapi perlu didefinisikan pada titik yang cukup dekat dengan  $c$  untuk membuat penelitian menjadi menarik. Inilah alasan definisi berikut.

**4.1.1 Definisi** Misalkan  $A \subseteq \mathbb{R}$ .  $c \in \mathbb{R}$ ,  $c$  adalah **titik kumpul** dari  $A$  untuk setiap  $\delta > 0$  dimana paling sedikit ada satu titik  $x \in A$ ,  $x \neq c$  berlaku  $|x - c| < \delta$ .

Definisi ini mengatakan kembali sebagai berikut: A titik  $c$  adalah sebuah titik kumpul dari himpunan  $A$  jika setiap  $\delta$ -daerah sekitaran/lingkungan  $V_\delta(c) = (c - \delta, c + \delta)$  dari  $c$  yang terdiri sedikitnya ada satu titik terkecil dari  $A$  yang berbeda dari  $c$ .

**Catatan** Titik  $c$  mungkin atau mungkin bukan anggota  $A$ , tetapi walaupun ada di  $A$ , itu diabaikan saat menentukan apakah itu titik kumpul  $A$  atau tidak, karena kita secara eksplisit mengharuskan

## 4.1 Limits of Functions

## 4.1 Fungsi Limit

$V_\delta(c) \cap A$  distinct from  $c$  in order for  $c$  to be a cluster point of  $A$ .

For example, if  $A := \{1, 2\}$ , then the point 1 is not a cluster point of  $A$ , since choosing  $\delta := \frac{1}{2}$  gives a neighborhood of 1 that contains no point of  $A$  distinct from 1. The same is true for the point 2, so we see that  $A$  has no cluster point.

ada titik di  $V_\delta(c) \cap A$  berbeda dari  $c$  agar  $c$  menjadi titik kumpul  $A$ .

Misalnya, jika  $A := \{1, 2\}$ , maka titik 1 bukan titik kumpul  $A$ , karena memilih  $\delta := \frac{1}{2}$  memberi daerah sekitaran 1 yang tidak mengandung titik  $A$  yang berbeda dari 1. Hal yang sama berlaku untuk titik 2, jadi kita lihat bahwa  $A$  tidak memiliki titik kumpul.

<p><b>Notasi Matematika dari D. 4.1.1</b>  <math>A \subseteq \mathbb{R}, c \in \mathbb{R}, c</math> adalah titik kumpul dari <math>A \forall \delta &gt; 0, \exists x \in A, x \neq c \ni  x - c  &lt; \delta</math>.</p>	<p><b>Kontrapositif dari D. 4.1.1</b>  <math>\exists \delta &gt; 0, \forall x \in A, x \neq c \ni  x - c  &lt; \delta \Rightarrow A \subseteq \mathbb{R}, c \in \mathbb{R}, c</math> bukan titik kumpul dari <math>A</math>.</p>
<p><b>Poin Penting dari D. 4.1.1</b></p> <ol style="list-style-type: none"> <li>1. <math>A \subseteq \mathbb{R}</math></li> <li>2. <math>c \in \mathbb{R}</math></li> <li>3. <math>c</math> titik kumpul dari <math>A</math></li> <li>4. <math>\delta &gt; 0</math> (Koefisien <math>\in \mathbb{R}</math>)</li> <li>5. <math> x - c </math> (Jarak <math>x</math> ke <math>c</math>)</li> <li>6. <math>V_\delta(c) = (c - \delta, c + \delta) \rightarrow</math> Daerah sekitaran <math>\delta</math> dari <math>c</math> (Interval terbuka)</li> </ol>	<p><b>Poin Penting dari Kontrapositif dari D. 4.1.1</b></p> <ol style="list-style-type: none"> <li>1. <math>\delta &gt; 0</math></li> <li>2. <math>x \in A</math></li> <li>3. <math>x \neq c</math></li> <li>4. <math> x - c  &lt; \delta</math></li> <li>5. <math>A \subseteq \mathbb{R}</math></li> <li>6. <math>c \in \mathbb{R}</math></li> <li>7. <math>c</math> bukan titik kumpul dari <math>A</math>.</li> </ol>

### Ilustrasi:

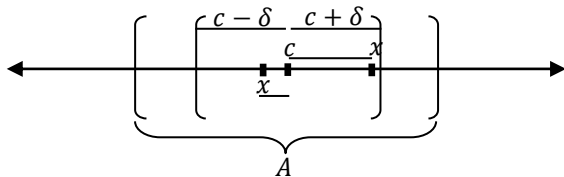

\*Semua bilangan yang berada didaerah sekitaran  $V_\delta(c)$  termasuk nilai anggota dari  $A$ , kecuali batasnya yaitu  $(c - \delta, c + \delta)$ .

\*Karena  $x \neq c$ , maka terdapat  $x$  disebelah  $c$  sehingga

### Contoh dari D. 4.1.1

$A = \{1, 2\} \rightarrow$  Bukti  $A$  tidak mempunyai titik kumpul?

Alternatif Bukti:

Bukti:

Misal:  $\delta = \frac{1}{2}$

(i) Pilih 1 sebagai titik kumpul dari  $A$ . Sehingga,

Dipilih  $c = 1$ , maka pilih  $x \neq 1, x \in A$  yang berada didalam sekitaran  $V_\delta(c)$ .

$$|x - c| < \delta.$$

\*Semua yang didalam himpunan  $A$  dimanapun  $x$ , sedikitnya ada satu  $x < \delta$  sehingga  $c$  dikatakan titik kumpul.

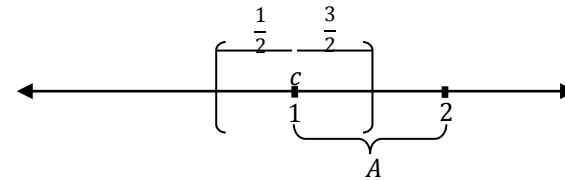

Diperoleh tidak ada  $x \in A$  didalam  $V_\delta(c)$  sehingga berdasarkan **D.4.1.1** maka 1 bukan titik kumpul dari  $A$ .

(ii) Pilih 2 sebagai titik kumpul dari  $A$ . Sehingga,

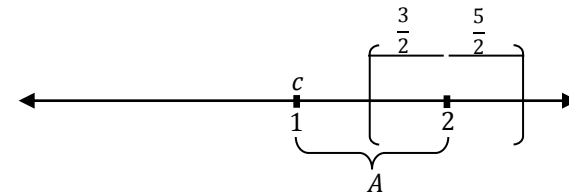

Dipilih  $c = 2$ , maka pilih  $x \neq 2, x \in A$  yang berada didalam sekitaran  $V_\delta(c)$ .

Diperoleh tidak ada  $x \in A$  didalam  $V_\delta(c)$  sehingga berdasarkan **D.4.1.1** maka 2 bukan titik kumpul dari  $A$ .

Dari (i) & (ii),  $A$  tidak mempunyai titik kumpul.

**4.1.2 Theorem** A number  $c \in \mathbb{R}$  is a cluster point of a subset  $A$  of  $\mathbb{R}$  if and only if there exists a sequence  $(a_n)$  in  $A$  such that  $\lim(a_n) = c$  and  $a_n \neq c$  for all  $n \in \mathbb{N}$ .

**Proof.** If  $c$  cluster point of  $A$ , then for any  $n \in \mathbb{N}$  the  $\frac{1}{n}$  neighborhood  $V_{\frac{1}{n}}(c)$  contains at least one point  $a_n$  in  $A$  distinct from  $c$ . Then  $a_n \in A, a_n \neq c$ , and  $|a_n - c| < \frac{1}{n}$  implies  $\lim(a_n) = c$ .

**Teorema 4.1.2** Suatu bilangan  $c \in \mathbb{R}$  adalah titik kumpul dari himpunan  $A \subseteq \mathbb{R}$  jika dan hanya jika ada barisan  $(a_n)$  di  $A$  sedemikian sehingga  $\lim(a_n) = c$ , dan  $a_n \neq c$  untuk setiap  $n \in \mathbb{N}$ .

**Bukti:**

Jika  $c$  adalah titik kumpul dari  $A$ , maka untuk setiap  $n \in \mathbb{N}$  ada  $\frac{1}{n}$  daerah persekitaran  $V_{\frac{1}{n}}(c)$  memuat paling sedikit satu titik  $a_n$  di  $A$  yang berbeda dengan  $c$ . Jika  $a_n$ , untuk setiap  $n \in \mathbb{N}$

Conversely, if there exists a sequence  $(a_n)$  in  $A \setminus \{c\}$  with  $\lim(a_n) = c$ , then for any  $\delta > 0$  there exists  $K$  such that if  $n \geq K$ , then  $a_n \in V_\delta(c)$ . Therefore the  $\delta$ -neighborhood  $V_\delta(c)$  of  $c$  contains the points  $a_n$ , for  $n \geq K$ , which belong to  $A$  and are distinct from  $c$ . Q.E.D.

The next examples emphasize that a cluster point of a set may or may not belong to the set.

merupakan titik-titik tersebut, maka  $a_n \in A, a_n \neq c$  dan  $|a_n - c| < \frac{1}{n}$  menjadi  $\lim(a_n) = c$ .

Sebaliknya jika ada sebuah barisan  $(a_n)$  di  $A \setminus \{c\}$  dengan  $\lim(a_n) = c$ , maka untuk sebarang  $\delta > 0$  terdapat  $K$ , sedemikian sehingga jika  $n \geq K$  maka  $a_n \in V_\delta(c)$ . Oleh karena itu,  $\delta$  daerah persekitaran  $V_\delta(c)$  dari  $c$  memuat titik  $a_n$ , untuk setiap  $n \geq K$ , dimana anggota dari  $A$  berbeda dengan  $c$ .

Contoh-contoh berikut ini menekankan bahwa suatu titik kumpul dari suatu himpunan bisa masuk dalam himpunan tersebut atau tidak.

<p><b>Notasi Matematika dari T. 4.1.2</b>  <math>c \in \mathbb{R}</math>, <math>c</math> titik kumpul dari <math>A</math>, <math>A \subseteq \mathbb{R} \Leftrightarrow \exists (a_n)</math> di <math>A \ni \lim(a_n) = c \wedge a_n \neq c, \forall n \in \mathbb{N}</math>.</p>	<p><b>Kontrapositif Matematika dari T. 4.1.2</b>  <math>c \in \mathbb{R}</math>, <math>c</math> bukan titik kumpul dari <math>A</math>, <math>A \subseteq \mathbb{R} \Leftrightarrow \forall (a_n)</math> di <math>A \ni \lim(a_n) \neq c \vee a_n = c, \exists n \in \mathbb{N}</math>.</p>
<p><b>Poin Penting dari T. 4.1.2</b></p> <ol style="list-style-type: none"> <li><math>c</math> titik kumpul dari <math>A</math></li> <li><math>c \in \mathbb{R}</math></li> <li><math>A \subseteq \mathbb{R}</math></li> <li><math>(a_n)</math> adalah barisan di <math>A</math></li> <li><math>\lim(a_n) = c</math></li> <li><math>a_n \neq c, \forall n \in \mathbb{N}</math></li> </ol>	<p><b>Poin Penting Kontrapositif dari T. 4.1.2</b></p> <ol style="list-style-type: none"> <li><math>c</math> bukan titik kumpul dari <math>A</math></li> <li><math>c \in \mathbb{R}</math></li> <li><math>A \subseteq \mathbb{R}</math></li> <li><math>\forall (a_n)</math> adalah barisan di <math>A</math></li> <li><math>\lim(a_n) \neq c</math></li> <li><math>a_n = c, \exists n \in \mathbb{N}</math></li> </ol>
<p><b>Alternatif Bukti dari T. 4.1.2</b>  i. <math>\exists</math> barisan <math>(a_n)</math> di <math>A \wedge x \neq c, \forall n \in \mathbb{N} \ni \lim(a_n) = c \Rightarrow</math> Bukti ?  <b>Bukti:</b>  <math>c</math> titik kumpul dari <math>A \rightarrow \forall n \in \mathbb{N}, \exists \frac{1}{n}</math> daerah sekitaran <math>V_{\frac{1}{n}}(c)</math>, satu titik <math>a_n</math> di <math>A</math> yang berbeda dengan <math>c \ni a_n \in A, a_n \neq c \wedge</math></p>	<p><b>Ilustrasi Bukti dari T. 4.1.2</b>  <math>c \in \mathbb{R}</math>, <math>c</math> titik kumpul dari <math>A</math>, <math>A \subseteq \mathbb{R} \Leftrightarrow \exists (a_n)</math> di <math>A \ni \lim(a_n) = c \wedge a_n \neq c, \forall n \in \mathbb{N}</math>.</p>

$|a_n \neq c| < \frac{1}{n}$  sehingga  $\lim(a_n) = c$ .

ii.  $c$  adalah titik kumpul dari  $A \Rightarrow$  Bukti ?

**Bukti:**

Sebaliknya,  $\exists a_n$  di  $A \setminus \{c\}$  dengan  $\lim(a_n) = c, \forall \delta > 0 \exists K$  jika  $n \geq K \rightarrow a_n \in V_\delta(c)$ , sehingga  $\delta$  daerah sekitaran  $V_\delta(c)$  dari  $c$  memuat titik  $a_n, \forall n \in \mathbb{N}$ , dimana anggota  $A$  berbeda dengan  $c$ .

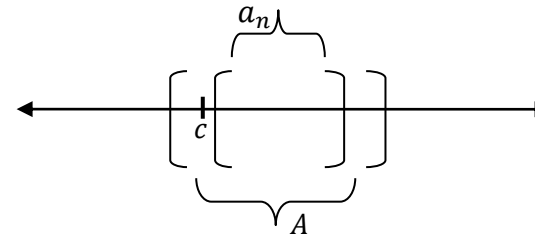

i.  $|a_n \neq c| < \frac{1}{n}$  sehingga  $\lim(a_n) = c$ .

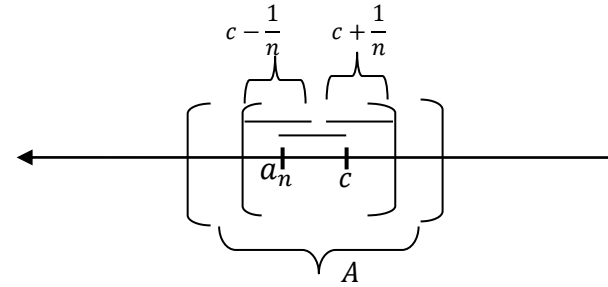

ii. Misal :  $(a_n) = \{1, \frac{1}{2}, \frac{1}{4}, \dots\}$

$\lim(a_n) = 0, \forall n \in \mathbb{N}$

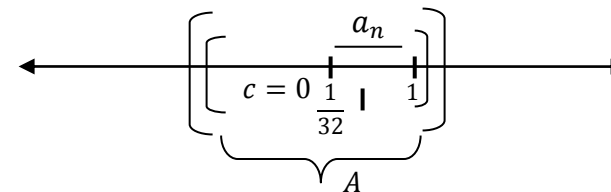

Dari (i) dan (ii) maka T.4.1.2 Q.E.D

**Poin Penting Alternatif Bukti dari T. 4.1.2**

1.  $c$  titik kumpul dari  $A, \forall n \in \mathbb{N}$
2.  $\exists \frac{1}{n}$  daerah sekitaran  $V_{\frac{1}{n}}(c)$
3. Satu titik  $a_n$  di  $A$  yang berbeda dengan  $c$
4.  $a_n \in A$
5.  $a_n \neq c \wedge |a_n - c| < \frac{1}{n}$
6.  $\lim(a_n) = c$
7.  $\exists a_n$  di  $A \setminus \{c\}$
8.  $\lim(a_n) = c, \forall \delta > 0 \exists K$
9.  $n \geq K \rightarrow a_n \in V_\delta(c)$
10.  $V_\delta(c)$  dari  $c$  memuat titik  $a_n, \forall n \in A$
11. Anggota  $A$  berbeda dengan  $c$

**4.1.3 Examples (a)** For the open interval  $A_1 := (0,1)$ , every point of the closed interval  $[0,1]$  is a cluster point of  $A_1$ . Note that the points 0,1 are cluster points of  $A_1$ , but do not belong to  $A_1$ . All the points of  $A_1$  are cluster points of  $A_1$ .

(b) A finite set has no cluster points.

(c) The infinite set  $\mathbb{N}$  has no cluster points.

**Contoh 4.1.3 (a)** Jika  $A_1$  interval terbuka  $(0,1)$ , setiap titik pada interval tertutup  $[0,1]$  adalah titik kumpul dari  $A_1$ . Sebagai catatan bahwa 0 dan 1 adalah titik kumpul dari  $A_1$ , tetapi titik tersebut tidak terdapat di  $A_1$ . Semua nilai pada  $A_1$  adalah titik kumpul dari  $A_1$ .

(b) Setiap himpunan berhingga tidak mempunyai titik kumpul.

(c) Himpunan pada  $\mathbb{N}$  meskipun himpunan takberhingga tetapi tidak memiliki titik kumpul.

**Alternatif Jawaban dari C. 4.1.3 (a)**

Misalkan  $a, b \in \mathbb{R}, a > b$

Interval terbuka  $(0,1) = \{x \in \mathbb{R} : a < x < b\}$ ,  $a$  dan  $b$  tidak termasuk  $A_1$ .

Interval tertutup  $[0,1] = \{x \in \mathbb{R} : a \leq x \leq b\}$ ,  $a$  dan  $b$  termasuk

**Poin Penting dari C. 4.1.3 (a)**

1. Interval terbuka =  $(0,1)$
2. Interval tertutup =  $[0,1]$
3. 0 dan 1 adalah titik kumpul dari  $A_1$
4. 0 dan 1 tidak terdapat di  $A_1$

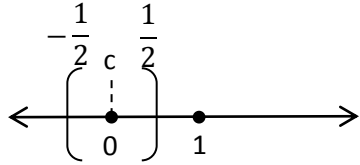

<p><math>A_1</math>.</p> <p>Catatan :</p> <ol style="list-style-type: none"> <li>0 dan 1 adalah titik kumpul dari <math>A_1</math>.</li> <li>0 dan 1 tidak terdapat di <math>A_1</math>.</li> <li>Semua nilai <math>A_1</math> adalah titik kumpul dari <math>A_1</math>.</li> </ol> <p>Jika <math>A_1 = [0,1]</math>, apakah 0 titik kumpul dari <math>A_1</math>?</p> <p><math>c = 0</math> berdasarkan D.4.1.1 <math>x \in \mathbb{R}</math> adalah titik kumpul dari <math>A_1 \subseteq \mathbb{R} \ni V_\delta(c) = (c - \delta, c + \delta)</math>, <math>x</math> memuat sekurang-kurangnya satu titik berbeda dari <math>x(x \neq c)</math> dan <math> x - c  &lt; \delta</math>.</p> <p>Misalkan <math>\delta = \frac{1}{2}</math></p> $V_\delta(c) = (c - \delta, c + \delta)$ $V_\delta(0) = \left(0 - \frac{1}{2}, 0 + \frac{1}{2}\right)$ $V_\delta(0) = \left(-\frac{1}{2}, \frac{1}{2}\right)$  <p>Jadi, 0 merupakan titik kumpul dari <math>A_1</math>.</p>	<ol style="list-style-type: none"> <li>Semua nilai <math>A_1</math> adalah titik kumpul dari <math>A_1</math></li> <li><math>A_1 = [0,1]</math></li> <li><math>c = 0</math></li> <li><math>\delta = \frac{1}{2}</math></li> <li>0 merupakan titik kumpul dari <math>A_1</math>.</li> </ol>
<p><b>Alternatif Jawaban dari C. 4.1.3 (b)</b></p> <p>Misalkan : <math>A_2 = \{1,2,3,4,5\}, A_2 \subseteq \mathbb{N}</math> atau</p> $A_2 = \{x : 1 \leq x \leq 5, x \in \mathbb{N}\}$ <p>Apakah 1 termasuk titik kumpul dari <math>A_2</math>?</p> <p><math>c = 1</math> berdasarkan D.4.1.1 <math>x \in \mathbb{R}</math> adalah titik kumpul dari <math>A_1 \subseteq \mathbb{R} \ni V_\delta(c) = (c - \delta, c + \delta)</math>, <math>x</math> memuat sekurang-kurangnya satu titik berbeda dari <math>x(x \neq c)</math> dan <math> x - c  &lt; \delta</math>.</p>	<p><b>Poin Penting dari C. 4.1.3 (b)</b></p> <ol style="list-style-type: none"> <li><math>A_2 = \{1,2,3,4,5\}</math></li> <li><math>A_2 \subseteq \mathbb{N}</math></li> <li><math>A_2 = \{x : 1 \leq x \leq 5, x \in \mathbb{N}\}</math></li> <li><math>\delta = \frac{1}{4}</math></li> <li>1 termasuk titik kumpul dari <math>A_2</math></li> </ol>

Misalkan  $\delta = \frac{1}{4}$

$$V_\delta(c) = (c - \delta, c + \delta)$$

$$V_\delta(1) = \left(1 - \frac{1}{4}, 1 + \frac{1}{4}\right)$$

$$V_\delta(1) = \left(-\frac{3}{4}, \frac{5}{4}\right)$$

Jadi, 1 merupakan titik kumpul dari  $A_2$ .

**Alternatif Jawaban dari C. 4.1.3 (c)**

1. Setiap mengambil sebarang  $n \in \mathbb{N}$  sebagai titik kumpul maka  $c = n$ .
2. Dipilih  $\delta = \frac{1}{2}$  maka tidak ada sebarang  $n \in \mathbb{N}, x \neq n$  yang berada di  $V_\delta(n)$  sehingga berdasarkan D.4.1.1  $n$  bukan titik kumpul.

Misalkan :  $A_3 = \{1,2,3, \dots\}, A_3 \subseteq \mathbb{N}$  atau  
 $A_3 = \{x : x \geq 1, x \in \mathbb{N}\}$

Apakah 2 termasuk titik kumpul dari  $A_2$ ?  
 $c = 2$  berdasarkan D.4.1.1  $x \in \mathbb{R}$  adalah titik kumpul dari  $A_1 \subseteq \mathbb{R} \ni V_\delta(c) = (c - \delta, c + \delta), x$  memuat sekurang-kurangnya satu titik berbeda dari  $x(x \neq c)$  dan  $|x - c| < \delta$ .

Misalkan  $\delta = \frac{1}{2}$

$$V_\delta(c) = (c - \delta, c + \delta)$$

$$V_\delta(2) = \left(2 - \frac{1}{2}, 2 + \frac{1}{2}\right)$$

**Poin Penting dari C. 4.1.3 (c)**

1.  $n \in \mathbb{N}$  sebagai titik kumpul
2.  $c = n$
3.  $\delta = \frac{1}{2}$
4.  $n \in \mathbb{N}, x \neq n$  yang berada di  $V_\delta(n)$
5. berdasarkan D.4.1.1  $n$  bukan titik kumpul.
6.  $A_3 = \{1,2,3, \dots\}, A_3 \subseteq \mathbb{N}$   
 $A_3 = \{x : x \geq 1, x \in \mathbb{N}\}$
7.  $c = 2$
8.  $\delta = \frac{1}{2}$
9. 2 merupakan titik kumpul dari  $A_3$

$V_\delta(2) = \left(-\frac{3}{2}, \frac{5}{2}\right)$ <p>Jadi, 2 merupakan titik kumpul dari <math>A_3</math>.</p>	
---	--

**4.1.3 Exemple**

- (d) The set  $A_4 := \{1/n : n \in \mathbb{N}\}$  has only the point 0 as a cluster point. None of the points in  $A_4$  is a cluster point of  $A_4$ .
- (e) If  $I := [0,1]$ , then the set  $A_5 := I \cap \mathbb{Q}$  consists of all the rational numbers in  $I$ . It follows from the Density Theorem 2.4.8 that every point in  $I$  is a cluster point of  $A_5$ .

**Contoh 4.1.3**

- (d) Himpunan  $A_4 := \{1/n : n \in \mathbb{N}\}$  hanya memiliki titik 0 sebagai titik kumpul. Tidak ada satupun titik  $A_4$  yang merupakan titik kumpul dari  $A_4$ .
- (e) Jika  $I := [0,1]$ , maka himpunan  $A_5 := I \cap \mathbb{Q}$  terdiri dari semua bilangan rasional di  $I$ . Ini mengikuti dari Teorema Densitas 2.4.8 bahwa setiap titik dalam  $I$  adalah titik kumpul dari  $A_5$ .

<p><b>Alternatif Jawaban dari C. 4.1.1 (d)</b></p> <p><math>A_4 := \{\frac{1}{n} : n \in \mathbb{N}\} \Rightarrow 0</math> titik kumpul dari <math>A_4</math></p> <p><b>Bukti:</b></p> <p><math>\forall \varepsilon &gt; 0, \quad \frac{1}{\varepsilon} &gt; 0</math></p> <p>Berdasarkan sifat Archimedes, <math>\exists k = k(\varepsilon) \ni \frac{1}{k} &lt; \varepsilon</math></p> <p>Jika <math>n \geq k</math> maka <math>\frac{1}{n} \leq \frac{1}{k} &lt; \varepsilon</math></p> <p>Kemudian <math> x_n - x  = \left \frac{1}{n} - 0\right  = \left \frac{1}{n}\right  = \frac{1}{n} &lt; \varepsilon</math></p>	<p><b>Poin Penting dari C. 4.1.1 (d)</b></p> <ol style="list-style-type: none"> <li>1. <math>A_4 := \{\frac{1}{n} : n \in \mathbb{N}\}</math>.</li> <li>2. Tidak ada satupun <math>A_4</math> yang merupakan titik kumpul.</li> <li>3. <math>\forall \varepsilon &gt; 0, \frac{1}{\varepsilon} &gt; 0</math></li> <li>4. <math>\exists k = k(\varepsilon) \ni \frac{1}{k} &lt; \varepsilon</math></li> <li>5. <math>n \geq k \rightarrow \frac{1}{n} \leq \frac{1}{k} &lt; \varepsilon</math></li> <li>6. <math> x_n - x  = \left \frac{1}{n} - 0\right  = \left \frac{1}{n}\right  = \frac{1}{n} &lt; \varepsilon</math></li> </ol>
---	--

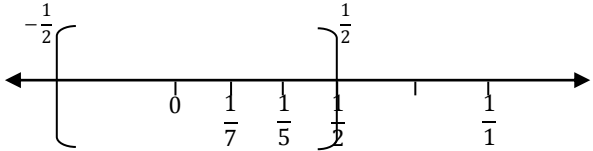
<p>Berdasarkan <b>definisi 3.1.3</b> diperoleh <math>\left(\frac{1}{n}\right)</math> konvergen ke 0                  Sehingga <math>\lim\left(\frac{1}{n}\right) = 0</math> atau <math>\left(\frac{1}{n}\right) \rightarrow 0</math> terbukti.</p> $A_4 = \left\{\frac{1}{1}, \frac{1}{2}, \frac{1}{3}, \frac{1}{4}, \frac{1}{5}, \dots, \frac{1}{n}\right\}, \delta = \frac{1}{2}$ 	<p>7. <math>\lim\left(\frac{1}{n}\right) = 0</math></p>
<p><b>Alternatif Jawaban dari C. 4.1.1 (e)</b>  <math>A_5 = I \cap \mathbb{Q}</math>, dengan <math>\mathbb{Q} = \left\{x = \frac{a}{b} \mid a, b \in \mathbb{Z}, b \neq 0\right\}</math>  <math>A_5</math> = terdiri dari semua bilangan rasional yang terdapat pada <math>I</math>.                  Berdasarkan <b>Teorema 2.4.8</b> jika <math>x, y \in \mathbb{R}</math> dengan <math>x &lt; y</math>, kemudian disini terdapat sebuah bilangan rasional <math>r \in \mathbb{Q}</math> sehingga <math>x &lt; r &lt; y</math></p> <p><b>Bukti:</b>                  Kita asumsikan bahwa <math>x &gt; 0</math>. Sejak <math>y - x &gt; 0</math>. Mengikuti <b>Akibat 2.4.5</b>, kemudian disini terdapat <math>n \in \mathbb{N}</math> sehingga <math>\frac{1}{n} &lt; y - x</math> (masing-masing dikalikan dengan <math>n</math>). Oleh karena itu kita mendapatkan:  <math>nx + 1 &lt; ny</math>. Tetapi jika kita memakai <b>Akibat 2.4.6</b> yang menyebutkan <math>nx &gt; 0</math>, dan <math>m \in \mathbb{N}</math> dengan <math>m - 1 \leq nx &lt; m</math>. Oleh karena itu, <math>m \leq nx + 1 &lt; ny</math>, sehingga <math>nx &lt; m &lt; ny</math>, jadi bilangan rasional <math>\frac{m}{n}</math>, jika <math>nx &lt; m &lt; ny</math> (masing-masing dibagi dengan <math>n</math>). Maka didapatkan <math>x &lt; r &lt; y</math></p>	<p><b>Poin Penting dari C. 4.1.1 (e)</b></p> <ol style="list-style-type: none"> <li><math>I = [0,1] \rightarrow</math> (interval tertutup dimana 0 dan 1 masuk menjadi anggota).</li> <li>Himpunan <math>A_5 = I \cap \mathbb{Q}</math> terdiri dari semua bilangan rasional antara 0 sampai 1.</li> <li><math>\mathbb{Q} = \left\{x = \frac{a}{b} \mid a, b \in \mathbb{Z}, b \neq 0\right\}</math></li> <li><b>T. 2.4.8</b> (teorema kepadatan) yaitu diantara bilangan real selalu ada bilangan rasional.</li> <li><math>y \in \mathbb{R}</math> dengan <math>x &lt; y</math></li> <li><math>r \in \mathbb{Q}</math> sehingga <math>x &lt; r &lt; y</math></li> <li>Setiap titik dalam <math>I</math> adalah titik kumpul dari <math>A_5</math>.</li> <li><math>x &gt; 0</math>.</li> <li><math>y - x &gt; 0</math></li> <li><math>\frac{1}{n} &lt; y - x \rightarrow nx + 1 &lt; ny</math></li> <li><math>x &lt; r &lt; y</math></li> </ol>

Ilustrasi gambar dari C. 4.1.1 (e)

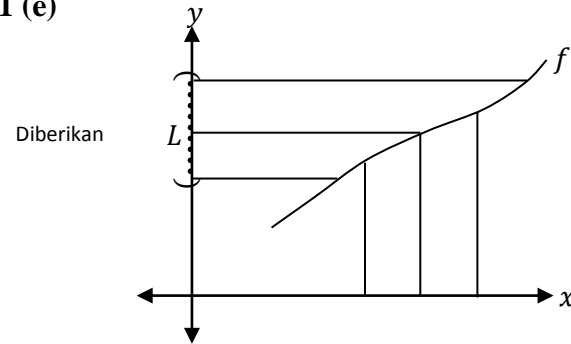

**The Definition of the Limit**

We now state the precise definition of the limit of a function  $f$  at a point  $c$ . It is important to note that in this definition, it is immaterial whether  $f$  is defined at  $c$  or not. In any case, we exclude  $c$  from consideration in the determination of the limit.

**4.1.4 Definition** Let  $A \subseteq \mathbb{R}$ , and let  $c$  be a cluster point of  $A$ . For a function  $f: A \rightarrow \mathbb{R}$ , a real number  $L$  is said to be a **limit of  $f$  at  $c$**  if, given any  $\varepsilon > 0$ , there exists a  $\delta > 0$  such that if  $x \in A$  and  $0 < |x - c| < \delta$ , then  $|f(x) - L| < \varepsilon$ .

**Remarks (a)** Since the value of  $\delta$  usually depends on  $\varepsilon$ , we will sometimes write  $\delta(\varepsilon)$  instead of  $\delta$  to emphasize this dependence.

**(b)** The inequality  $0 < |x - c|$  is equivalent to saying  $x \neq c$ .

If  $L$  is a limit of  $f$  at  $c$ , then we also say that  $f$  **converges to  $L$  at  $c$** . We often write

$$L = \lim_{x \rightarrow c} f(x) \quad \text{or} \quad L = \lim_{x \rightarrow c} f.$$

We also say that “ $f(x)$  approaches  $L$  as  $x$  approaches  $c$ .” (But it is should be noted that the points do not actually move anywhere).

The symbolism

$$f(x) \rightarrow L \quad \text{as} \quad x \rightarrow c$$

is also used sometimes to express the fact that  $f$  has limit  $L$  at  $c$ .

If the limit of  $f$  at  $c$  does not exist, we say that  $f$  **diverges** at  $c$ .

Our first result is that the value  $L$  of the limit is uniquely determined. This uniqueness is not part of the definition of limit, but must be deduced.

**Definisi Limit**

Kita sekarang menyatakan definisi limit fungsi  $f$  pada titik  $c$ . Penting untuk dicatat bahwa dalam definisi ini, tidak penting apakah  $f$  ditetapkan pada  $c$  atau tidak. Bagaimanapun, kita mengecualikan  $c$  dari pertimbangan dalam penentuan limit.

**Definisi 4.1.4** Misalkan  $A \subseteq \mathbb{R}$ , dan  $c$  adalah titik kumpul dari  $A$ . Untuk sebuah fungsi  $f: A \rightarrow \mathbb{R}$ , suatu bilangan real  $L$  dikatakan sebuah **limit dari  $f$  pada  $c$**  jika, diberikan sebarang  $\varepsilon > 0$ , terdapat  $\delta > 0$  sedemikian hingga jika  $x \in A$  dan  $0 < |x - c| < \delta$ , maka  $|f(x) - L| < \varepsilon$ .

**Keterangan (a)** Nilai  $\delta$  biasanya bergantung pada nilai  $\varepsilon$ , kita terkadang menulis  $\delta(\varepsilon)$  untuk menunjukkan keterkaitan nilai  $\delta$ .

**(b)** Pertidaksamaan  $0 < |x - c|$  bisa dikatakan  $x \neq c$ .

Jika  $L$  adalah limit dari  $f$  pada  $c$ , maka kita juga mengatakan bahwa  $f$  **konvergen untuk  $L$  pada  $c$** . Kita sering menulis

$$L = \lim_{x \rightarrow c} f(x) \quad \text{atau} \quad L = \lim_{x \rightarrow c} f.$$

Kita juga mengatakan bahwa “ $f(x)$  mendekati  $L$  sebagai  $x$  mendekati  $c$ .” (tetapi harus dicatat bahwa intinya tidak benar-benar bergerak ke mana-mana.) Simbolisme

$$f(x) \rightarrow L \quad \text{sebagai} \quad x \rightarrow c$$

terkadang juga digunakan untuk mengungkapkan fakta bahwa  $f$  memiliki limit  $L$  pada  $c$ .

Jika limit  $f$  pada  $c$  tidak ada, kita katakan bahwa  $f$  **divergen** pada  $c$ . Hasil pertama kami adalah bahwa nilai  $L$  dari limit ditentukan secara unik. Keunikan ini bukan bagian dari definisi limit, tapi harus disimpulkan.

<p><b>Notasi Matematika dari D. 4.1.4</b>  <math>A \subseteq \mathbb{R}, c</math> titik kumpul <math>A, f: A \rightarrow \mathbb{R}</math> lalu  <math>\forall \varepsilon &gt; 0, \exists \delta &gt; 0 \exists x \in A, 0 &lt;  x - c  &lt; \delta \rightarrow  f(x) - L  &lt; \varepsilon \Rightarrow L</math>            limit dari <math>f</math> di <math>c</math>.            Keterangan: (a) <math>\delta</math> bergantung pada nilai <math>\varepsilon</math>, <math>\delta(\varepsilon)</math> menunjukkan keterkaitan <math>\delta</math>.            (b) Pertidaksamaan <math>0 &lt;  x - c , x \neq c</math>  <math>L</math> limit <math>f</math> pada <math>c</math>, <math>f</math> konvergen <math>L</math> pada <math>c</math>.  <math display="block">L = \lim_{x \rightarrow c} f(x) \quad \text{or} \quad L = \lim_{x \rightarrow c} f.</math> <math>f(x) \rightarrow L</math> sebagai <math>x \rightarrow c</math>            Limit <math>f</math> pada <math>c</math> tidak ada, <math>f</math> divergen <math>c</math>.</p>	<p><b>Kontrapositif dari D. 4.1.4</b>  <math>A \subseteq \mathbb{R}, c</math> bukan titik kumpul <math>A, f: A \rightarrow \mathbb{R}</math>, lalu  <math>\exists \varepsilon &gt; 0, \forall \delta &gt; 0 \exists x \in A, 0 &lt;  x - c  &lt; \delta \rightarrow  f(x) - L  &gt; \varepsilon \Rightarrow</math>  <math>L</math> bukan limit dari <math>f</math> di <math>c</math>.            Keterangan: (a) <math>\delta</math> tidak bergantung pada nilai <math>\varepsilon</math>, <math>\delta(\varepsilon)</math> tidak menunjukkan keterkaitan <math>\delta</math>.            (b) Persamaan <math>0 &lt;  x - c , x = c</math>  <math>L</math> bukan limit <math>f</math> pada <math>c</math>, <math>f</math> konvergen <math>L</math> pada <math>c</math>.  <math display="block">L = \lim_{x \rightarrow c} f(x) \quad \text{or} \quad L = \lim_{x \rightarrow c} f.</math> <math>f(x) \rightarrow L</math> sebagai <math>x \rightarrow c</math>            Limit <math>f</math> pada <math>c</math> ada, <math>f</math> divergen <math>c</math>.</p>
<p><b>Poin Penting dari D. 4.1.4</b></p> <ol style="list-style-type: none"> <li><math>c</math> titik kumpul <math>A</math></li> <li><math>f: A \rightarrow \mathbb{R}</math></li> <li><math>\forall \varepsilon &gt; 0</math> (anggota dari <math>\mathbb{R}</math>)</li> <li><math>\exists \delta &gt; 0</math> (anggota dari <math>\mathbb{R}</math>)</li> <li><math>0 &lt;  x - c  &lt; \delta</math></li> <li><math> f(x) - L  &lt; \varepsilon</math></li> <li><math>L</math> lim <math>f</math> di <math>c</math></li> </ol>	<p><b>Poin Penting dari Kontrapositif</b></p> <ol style="list-style-type: none"> <li><math>c</math> bukan titik kumpul <math>A</math></li> <li><math>f: A \rightarrow \mathbb{R}</math></li> <li><math>\exists \varepsilon &gt; 0</math> (anggota dari <math>\mathbb{R}</math>)</li> <li><math>\forall \delta &gt; 0</math> (anggota dari <math>\mathbb{R}</math>)</li> <li><math>0 &lt;  x - c  &lt; \delta</math></li> <li><math> f(x) - L  &gt; \varepsilon</math></li> <li><math>L</math> bukan limit dari <math>f</math> di <math>c</math>.</li> </ol>

**Ilustrasi dari D. 4.1.4**

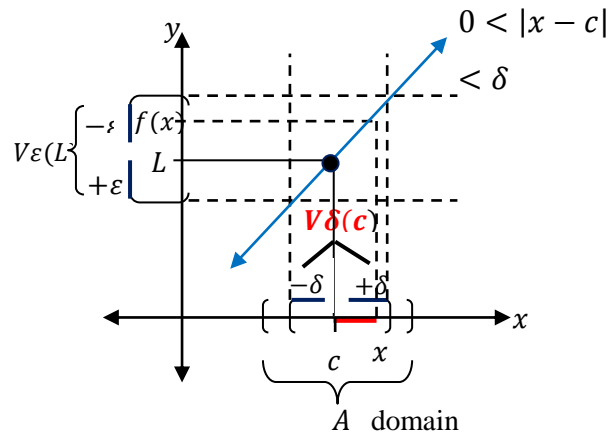

Himpunan  $A$  terletak di  $x$  karena  $A \subseteq \mathbb{R}$ , maka  $A$  nantinya domain. Jika terdapat  $x$  didalam  $c$  maka terdapat  $f(x)$  didalam  $L$  juga. Sebesar apapun ukuran  $\delta$  akan sama dengan ukuran  $\epsilon$ .  $|x - c|$  di dalam  $\delta$  domainnya sekitaran  $V\delta(c)$ . Jika itu terjadi, maka  $c$  titik kumpul dari  $A$ ,  $f: A \rightarrow \mathbb{R}$ ,  $L$  lim dari  $f$  di  $c$ .

**Ilustrasi dari Kontrapositif**

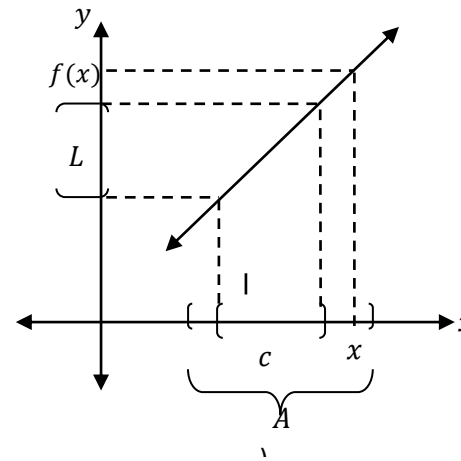

Jika terdapat  $x$  diluar  $c$ , maka  $f(x)$  berada diluar  $L$ . Sehingga  $c$  bukan titik kumpul  $A$ ,  $f: A \rightarrow \mathbb{R}$ ,  $L$  bukan limit dari  $f$  di  $c$ .



**4.1.5 Theorem** *If  $f: A \rightarrow \mathbb{R}$  and if  $c$  is a cluster point of  $A$ , then  $f$  can have only one limit at  $c$ .*

**Proof.** Suppose that number  $L$  and  $L'$  satisfy Definition 4.1.4. for any  $\varepsilon > 0$ , there exists  $\delta\left(\frac{\varepsilon}{2}\right) > 0$  such that if  $x \in A$  and  $0 < |x - c| < \delta\left(\frac{\varepsilon}{2}\right)$ , then  $|f(x) - L| < \varepsilon/2$ . Also there exists  $\delta'\left(\frac{\varepsilon}{2}\right)$  such that if  $x \in A$  and  $0 < |x - c| < \delta'\left(\frac{\varepsilon}{2}\right)$ , then  $|f(x) - L'| < \varepsilon/2$ . Now let  $\delta := \inf\left\{\delta\left(\frac{\varepsilon}{2}\right), \delta'\left(\frac{\varepsilon}{2}\right)\right\}$ . Then if  $x \in A$  and  $0 < |x - c| < \delta$ , the Triangle Inequality implies that

$$|L - L'| \leq |L - f(x)| + |f(x) - L'| < \frac{\varepsilon}{2} + \frac{\varepsilon}{2} = \varepsilon.$$

Since  $\varepsilon > 0$  is arbitrary, we conclude that  $L - L' = 0$ , so that  $L = L'$ . Q.E.D

The definition of limit can be very nicely described in terms of neighborhoods. (See Figure 4.1.1.) We observe that because

$$V_\delta = (c - \delta, c + \delta) = \{x: |x - c| < \delta\}.$$

The inequality  $0 < |x - c| < \delta$  is equivalent to saying that  $x \neq c$  and  $x$  belongs to the  $\delta$ -neighborhood  $V_\delta(c)$  of  $c$ . Similarly, the inequality  $|f(x) - L| < \varepsilon$  is equivalent to saying that  $f(x)$  belongs to the  $\varepsilon$ -neighborhood  $V_\varepsilon(L)$  of  $L$ . In this way, we obtain the following result. The reader should write out a detailed argument to establish the theorem.

**Teorema 4.1.5** *Jika  $f: A \rightarrow \mathbb{R}$  dan jika  $c$  suatu titik kumpul dari  $A$ , maka  $f$  hanya dapat mempunyai satu limit pada  $c$ .*

**Bukti.** Misalkan bilangan real  $L$  dan  $L'$  memenuhi dari Definisi 4.1.4 ada  $\varepsilon > 0$ , terdapat  $\delta\left(\frac{\varepsilon}{2}\right) > 0$  sedemikian sehingga  $x \in A$  dan  $0 < |x - c| < \delta\left(\frac{\varepsilon}{2}\right)$ , kemudian  $|f(x) - L| < \frac{\varepsilon}{2}$  ada juga  $\delta'\left(\frac{\varepsilon}{2}\right)$ . Jika  $x \in A$  dan  $0 < |x - c| < \delta'\left(\frac{\varepsilon}{2}\right)$ , kemudian  $|f(x) - L'| < \frac{\varepsilon}{2}$ . Sekarang misalkan  $\delta := \inf\left\{\delta\left(\frac{\varepsilon}{2}\right), \delta'\left(\frac{\varepsilon}{2}\right)\right\}$ . Kemudian jika  $x \in A$  dan  $0 < |x - c| < \delta$ , ketaksamaan segitiga

$$|L - L'| \leq |L - f(x)| + |f(x) - L'| < \frac{\varepsilon}{2} + \frac{\varepsilon}{2} = \varepsilon$$

Karena  $\varepsilon > 0$ , dapat disimpulkan bahwa  $|L - L'| < \varepsilon$  sehingga  $L - L' = 0$ , sehingga  $L = L'$ . Q.E.D

Definisi batas bisa digambarkan dengan sangat baik dalam hal lingkungan sekitaran. (Lihat Gambar 4.1.1) kita amati itu karena

$$V_\delta(c) = (c - \delta, c + \delta) = \{x: |x - c| < \delta\}$$

Ketidaksamaan  $0 < |x - c| < \delta$  sama dengan mengatakan bahwa  $x \neq c$  dan  $x$  termasuk dalam  $\delta$ -lingkungan  $V_\delta(c)$  pada  $c$ . Demikian pula, ketidaksamaan  $|f(x) - L| < \varepsilon$  sama dengan mengatakan bahwa  $f(x)$  dimiliki oleh lingkungan  $\varepsilon$ - $V_\varepsilon(L)$  pada  $L$ . Dengan cara ini kami mendapatkan hasil sebagai berikut. Pembaca harus menulis argumen terperinci untuk menetapkan teorema.

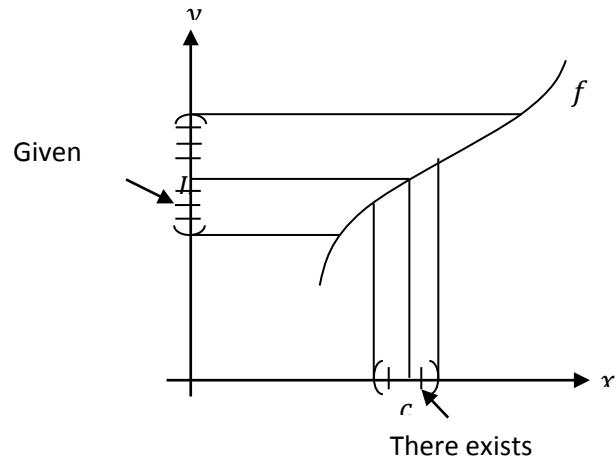
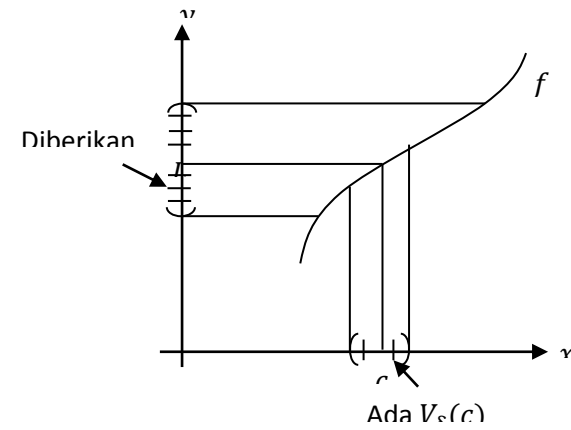

Figure 4.1.1 The limit of  $f$  at  $c$  is  $L$



Figur 4.1.1 Limit dari  $f$  pada  $c$  adalah  $L$

<p><b>Notasi Matematika dari T.4.1.5</b>  <math>f: A \rightarrow \mathbb{R}</math>, <math>c</math> titik kumpul dari <math>A \Rightarrow f</math> mempunyai limit tunggal pada <math>c</math>.</p>	<p><b>Kontrapositif dari T.4.1.5</b>  <math>f</math> tidak mempunyai limit tunggal pada <math>c \Rightarrow f: A \rightarrow \mathbb{R}</math>, <math>c</math> bukan titik kumpul dari <math>A</math>.</p>
<p><b>Poin Penting dari T.4.1.5</b></p> <ol style="list-style-type: none"> <li><math>f: A \rightarrow \mathbb{R}</math>.</li> <li><math>c</math> titik kumpul dari <math>A</math>.</li> <li><math>f</math> mempunyai satu limit pada <math>c</math>.</li> </ol>	<p><b>Poin Penting Kontrapositif dari T.4.1.5</b></p> <ol style="list-style-type: none"> <li><math>f</math> tidak mempunyai limit tunggal pada <math>c</math>.</li> <li><math>f: A \rightarrow \mathbb{R}</math>.</li> <li><math>c</math> bukan titik kumpul dari <math>A</math>.</li> </ol>
<p><b>Alternatif Bukti dari T.4.1.5</b>  <math>f: A \rightarrow \mathbb{R}</math>, <math>c</math> titik kumpul dari <math>A \Rightarrow</math> Bukti <math>f</math> mempunyai limit tunggal pada <math>c</math>?</p> <p><b>Bukti:</b>  Berdasarkan D.4.1.4 didapat  <math>\forall \varepsilon &gt; 0, \exists \delta &gt; 0, x \in A \ni 0 &lt;  x - c  &lt; \delta \rightarrow  f(x) - L  &lt; \varepsilon \rightarrow A \subseteq \mathbb{R}, f: A \rightarrow \mathbb{R}, c</math> titik kumpul dari <math>A</math>, <math>L</math> limit dari <math>f(x)</math> di <math>c</math>.  Misal <math>L</math> dan <math>L'</math> ada limit dari <math>f</math> di <math>c</math> sehingga berdasarkan D.4.1.4 maka  <math>0 &lt;  x - c  &lt; \delta \left(\frac{\varepsilon}{2}\right)</math> sehingga <math> f(x) - L  &lt; \frac{\varepsilon}{2}</math> dan <math> f(x) - L'  &lt; \frac{\varepsilon}{2}</math></p> $ \begin{aligned}  L - L'  &=  L - f(x) + f(x) - L'  \\ &=  -(f(x) - L) + (f(x) - L')  \\ &\leq  -(f(x) - L)  +  f(x) - L'  \\ &=  f(x) - L  +  f(x) - L'  \\ &\leq \frac{\varepsilon}{2} + \frac{\varepsilon}{2} = \varepsilon \end{aligned} $ <p>Sehingga <math> L - L'  &lt; \varepsilon</math> dan <math>\varepsilon &gt; 0</math> sehingga <math> L - L'  = 0 \Leftrightarrow L - L' = 0</math>  <math>L = L'</math>  <math>L = L'</math></p>	<p><b>Poin Penting Alternatif Bukti dari T.4.1.5</b></p> <ol style="list-style-type: none"> <li><math>\forall \varepsilon &gt; 0, \exists \delta &gt; 0, x \in A</math></li> <li>Sehingga <math>0 &lt;  x - c  &lt; \delta</math></li> <li><math> f(x) - L  &lt; \varepsilon</math></li> <li><math>A \subseteq \mathbb{R}, f: A \rightarrow \mathbb{R}</math></li> <li><math>c</math> titik kumpul dari <math>A</math></li> <li><math>L</math> limit dari <math>f(x)</math> di <math>c</math></li> <li><math>L</math> dan <math>L'</math> ada limit dari <math>f</math> di <math>c</math></li> <li>Sehingga berdasarkan D.4.1.4 maka <math>0 &lt;  x - c  &lt; \delta \left(\frac{\varepsilon}{2}\right)</math></li> <li>Sehingga <math> f(x) - L  &lt; \frac{\varepsilon}{2}</math></li> <li><math> f(x) - L'  &lt; \frac{\varepsilon}{2}</math></li> <li><math> L - L'  =  L - f(x) + f(x) - L' </math></li> <li><math>=  -(f(x) - L) + (f(x) - L') </math></li> <li><math>\leq  -(f(x) - L)  +  f(x) - L'  =  f(x) - L  +  f(x) - L' </math></li> <li><math>\leq \frac{\varepsilon}{2} + \frac{\varepsilon}{2} = \varepsilon</math></li> <li>Sehingga <math> L - L'  &lt; \varepsilon</math> dan <math>\varepsilon &gt; 0</math></li> <li>Sehingga <math> L - L'  = 0</math></li> <li><math>L - L' = 0</math></li> <li><math>L = L'</math>.</li> <li>Karena <math>L = L'</math> sehingga limitnya tunggal.</li> </ol>

Karena $L = L'$ sehingga limitnya tunggal. Jadi, T.4.1.5 ■	
---	--

**4.1.6 Theorem** Let  $f: A \rightarrow \mathbb{R}$  and let  $c$  be a cluster point of  $A$ . Then the following statements are equivalent.

- (i)  $\lim_{x \rightarrow c} f(x) = L$
- (ii) Given any  $\varepsilon$ -neighborhood  $V_\varepsilon(L)$  of  $L$ , there exists a  $\delta$ -neighborhood  $V_\delta(c)$  of  $c$  such that if  $x \neq c$  is any point in  $V_\delta(c) \cap A$ , then  $f(x)$  belongs to  $V_\varepsilon(L)$ .

**Teorema 4.1.6** Misal  $f: A \rightarrow \mathbb{R}$  dan  $c$  titik kumpul  $A$ . Maka pernyataan berikut adalah ekuivalen.

- (i)  $\lim_{x \rightarrow c} f(x) = L$
- (ii) Diberikan sebarang  $-\varepsilon V_\varepsilon(L)$  dari  $L$ , terdapat sebuah persekitaran  $-\delta V_\delta(c)$  sedemikian hingga jika  $x \neq c$  merupakan sebuah titik di  $V_\delta(c) \cap A$ , maka  $f(x)$  mendekati  $V_\varepsilon(L)$ .

<p><b>Notasi Matematika dari T. 4.1.6</b></p> <p><math>f: A \rightarrow \mathbb{R}</math>, <math>c</math> titik kumpul  <math>A \ni \lim_{x \rightarrow c} f(x) = L \Leftrightarrow \forall V_\varepsilon(L) \exists V_\delta(c) \ni x \neq c, \forall x \in V_\delta(c) \cap A \rightarrow f(x) \in V_\varepsilon(L)</math>.</p>	<p><b>Kontrapositif dari T. 4.1.6</b></p> <p><math>f: A \rightarrow \mathbb{R}</math>, <math>c</math> bukan titik kumpul <math>A</math>, <math>\lim_{x \rightarrow c} f(x) \neq L \Leftrightarrow \exists V_\varepsilon(L), \forall V_\delta(c) \ni x \neq c, \exists x \in V_\delta(c) \cap A \rightarrow f(x) \notin V_\varepsilon(L)</math>.</p>
<p><b>Poin Penting dari T. 4.1.6</b></p> <ol style="list-style-type: none"> <li>1. <math>f: A \rightarrow \mathbb{R}</math></li> <li>2. <math>c</math> titik kumpul <math>A</math></li> <li>3. <math>\lim_{x \rightarrow c} f(x) = L</math></li> <li>4. <math>\forall V_\varepsilon(L)</math></li> <li>5. <math>\exists V_\delta(c)</math></li> <li>6. <math>x \neq c</math></li> <li>7. <math>\forall x \in V_\delta(c) \cap A \rightarrow f(x) \in V_\varepsilon(L)</math></li> </ol>	<p><b>Poin Penting Kontrapositif dari T. 4.1.6</b></p> <ol style="list-style-type: none"> <li>1. <math>f: A \rightarrow \mathbb{R}</math></li> <li>2. <math>c</math> bukan titik kumpul <math>A</math></li> <li>3. <math>\lim_{x \rightarrow c} f(x) \neq L</math></li> <li>4. <math>\exists V_\varepsilon(L)</math></li> <li>5. <math>\forall V_\delta(c)</math></li> <li>6. <math>x \neq c</math></li> <li>7. <math>\exists x \in V_\delta(c) \cap A \rightarrow f(x) \notin V_\varepsilon(L)</math></li> </ol>
<p><b>Alternatif Bukti dari T. 4.1.6</b></p> <p><b>(i)→(ii)</b>                  Anggaplah bahwa <math>f</math> mempunyai limit <math>L</math> pada <math>c</math> maka diberikan <math>V_\varepsilon &gt; 0, \exists \delta = \delta(c) &gt; 0 \Leftrightarrow \forall x \in A</math> unsur dari <math>V_\delta(c)</math>, <math>x \neq c</math>, nilai <math>f(x)</math> termasuk dalam lingkungan <math>\varepsilon</math> dari <math>L(V_\varepsilon(L))</math> akan tetapi, <math>x \in V_\delta(c)</math> dan <math>x \neq c \Leftrightarrow 0 &lt;  x - c  &lt; \delta</math>. (Perhatikan bahwa</p>	<p><b>Poin Penting Alternatif Bukti dari T. 4.1.6</b></p> <p><b>(i)→(ii)</b></p> <ol style="list-style-type: none"> <li>1. <math>f</math> mempunyai limit <math>L</math> pada <math>c</math></li> <li>2. <math>V_\varepsilon &gt; 0, \exists \delta = \delta(c) &gt; 0</math></li> <li>3. <math>\forall x \in A</math></li> <li>4. <math>V_\delta(c)</math>, <math>x \neq c</math></li> </ol>

<p><math>0 &lt;  x - c </math> adalah cara lain untuk menentukan bahwa <math>x \neq c</math>. <math>f(x)</math> termasuk <math>V_\varepsilon(L) \leftrightarrow  f(x) - L  &lt; \varepsilon</math>. Jadi, jika <math>x \in A</math> memenuhi <math>0 &lt;  x - c  &lt; \delta</math> maka <math>f(x)</math> menentukan <math> f(x) - L  &lt; \varepsilon</math> menurut D 4.1.4.</p>	<p>5. <math>f(x)</math> termasuk dalam lingkungan <math>\varepsilon</math> dari <math>L(V_\varepsilon(L))</math>          6. <math>x \in V_\delta(c)</math>          7. <math>x \neq c \leftrightarrow 0 &lt;  x - c  &lt; \delta</math>          8. <math>V_\varepsilon(L) \leftrightarrow  f(x) - L  &lt; \varepsilon</math></p>
<p><b>Alternatif Bukti dari T. 4.1.6</b>  <b>(ii)→(i)</b>          Jika syarat (ii) berlaku maka ambil lingkungan <math>V_\delta(c) = (c - \delta, c + \delta)</math> maka syarat (ii) berakibat jika <math>x</math> masuk dalam <math>V_\delta(c)</math> dimana <math>x \in A</math> dan <math>x \neq c</math>, maka <math>f(x)</math> termasuk dalam <math>V_\varepsilon(L)</math>. Oleh karena itu menurut D 4.1.4 diperoleh <math>\lim_{x \rightarrow c} f(x) = L</math>.</p>	<p><b>Poin Penting Alternatif Bukti dari T. 4.1.6</b>  <b>(ii)→(i)</b>          1. <math>V_\delta(c) = (c - \delta, c + \delta)</math>          2. <math>x</math> masuk dalam <math>V_\delta(c)</math>          3. <math>\forall x \in A</math> dan <math>x \neq c</math>          4. <math>f(x)</math> termasuk dalam <math>V_\varepsilon(L)</math>          5. <math>\lim_{x \rightarrow c} f(x) = L</math></p>

**4.1.7 Examples** (a)  $\lim_{x \rightarrow c} b = b$

To be more explicit, let  $f(x) = b$  for all  $x \in \mathbb{R}$ . We want to show that  $\lim_{x \rightarrow c} f(x) = b$ . If  $\varepsilon > 0$  is given, we let  $\delta = 1$ . (In fact, any strictly positive  $\delta$  will serve the purpose). Then if  $0 < |x - c| < 1$  we have  $|f(x) - b| = |b - b| = 0 < \varepsilon$ . Since  $\varepsilon > 0$  is arbitrary, we conclude from Definition 4.1.4 that  $\lim_{x \rightarrow c} f(x) = b$ .

**(b)  $\lim_{x \rightarrow c} x = c$**

Let  $g(x) = x$  for all  $x \in \mathbb{R}$ . If  $\varepsilon > 0$ , we choose  $\delta(\varepsilon) = \varepsilon$ . Then if  $0 < |x - c| < \delta(\varepsilon)$ , we have  $|g(x) - c| = |x - c| < \varepsilon$ . Since  $\varepsilon > 0$  is arbitrary, we deduce that  $\lim_{x \rightarrow c} g = c$ .

**Contoh 4.1.7** (a)  $\lim_{x \rightarrow c} b = b$

Untuk lebih jelas, misal  $f(x) = b$  untuk semua  $x \in \mathbb{R}$ , kita dapat menunjukkan bahwa  $\lim_{x \rightarrow c} f(x) = b$ . Jika  $\varepsilon > 0$  diberikan, kita misalkan  $\delta = 1$  (menggukan sebarang positif). Maka  $0 < |x - c| < 1$  di peroleh  $|f(x) - b| = |b - b| = 0 < \varepsilon$ . Karena  $\varepsilon > 0$  adalah sewenang-wenang, kita melihat dari Definisi 4.1.4 bahwa  $\lim_{x \rightarrow c} f(x) = b$ .

**(b)  $\lim_{x \rightarrow c} x = c$**

Misal  $g(x) = x$  untuk semua  $x \in \mathbb{R}$ . Jika  $\varepsilon > 0$ , kita pilih  $\delta(\varepsilon) = \varepsilon$ . Jika  $0 < |x - c| < \delta(\varepsilon)$ , kita peroleh  $|g(x) - c| = |x - c| < \varepsilon$ . Karena sebarang  $\varepsilon > 0$ , kita simpulkan bahwa  $\lim_{x \rightarrow c} g = c$ .

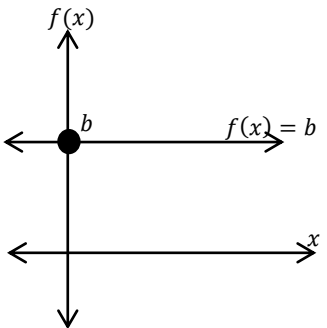
<p><b>Alternatif Jawaban dari C. 4.1.7 (a)</b></p> <p>(a) <math>\lim_{x \rightarrow c} b = b</math>            Jawab:  <math>\lim_{x \rightarrow c} b = b</math>, bukti?  <b>Bukti:</b>            Misal  <math>f(x) = b, \forall x \in \mathbb{R}</math>  <math>L = b</math>  <math>\forall \varepsilon &gt; 0</math>, kita pilih <math>\delta = 1</math>            Berdasarkan D.4.1.4  <math>\forall \varepsilon &gt; 0, \exists \delta &gt; 0 \ni x \in A, 0 &lt;  x - c  &lt; \delta \rightarrow  f(x) - L  &lt; \varepsilon</math>. Maka <math>0 &lt;  x - c  &lt; \delta = 1</math> sehingga <math> f(x) - L  =  b - b  =  0  = 0 &lt; \varepsilon (\forall \varepsilon &gt; 0)</math>.</p>  <p><u>Jadi</u>, <math>\lim_{x \rightarrow c} b = b</math> terbukti ■</p>	<p><b>Point Penting dari C. 4.1.7 (a)</b></p> <p>(a) <math>f(x) = b</math>            (b) <math>\forall x \in \mathbb{R}</math>            (c) <math>L = b</math>            (d) <math>\forall \varepsilon &gt; 0</math>            (e) <math>\delta = 1</math>            (f) <math>\lim_{x \rightarrow c} f(x) = b</math> jika <math>\varepsilon &gt; 0</math>            (g) <math> f(x) - b  =  b - b  = 0 &lt; \varepsilon</math></p>
<p><b>Alternatif Jawaban dari C. 4.1.7 (b)</b></p> <p>(b) <math>\lim_{x \rightarrow c} x = c</math>            Jawab:  <math>\lim_{x \rightarrow c} x = c</math>, bukti?  <b>Bukti:</b>            Misal:  <math>g(x) = x, \forall x \in \mathbb{R}</math></p>	<p><b>Point Penting dari C. 4.1.7 (b)</b></p> <p>(a) <math>g(x) = x</math>            (b) <math>\forall x \in \mathbb{R}</math>            (c) <math>L = c</math>            (d) <math>\forall \varepsilon &gt; 0</math>            (e) <math>\delta = \delta(\varepsilon) = \varepsilon &gt; 0</math>            (f) <math>0 &lt;  x - c  &lt; \delta(\varepsilon)</math></p>

$L = c$ $\forall \varepsilon > 0$ , pilih $\delta = \delta(\varepsilon) = \varepsilon > 0$ Berdasarkan D.4.1.4 $\forall \varepsilon > 0, \exists \delta > 0 \ni x \in A, 0 <  x - c  < \delta \rightarrow  f(x) - L  < \varepsilon$ . Maka $0 <  x - c  < \delta(\varepsilon)$ sehingga $ g(x) - L  =  x - c  < \delta(\varepsilon) = \varepsilon$ Jadi, $\lim_{x \rightarrow c} g = c$ terbukti ■	(g) $ g(x) - c  =  x - c  < \varepsilon$
--	--

**4.1.7 Example**

(c)  $\lim_{x \rightarrow c} x^2 = c^2$ .

Let  $h(x) := x^2$  for all  $x \in \mathbb{R}$ . We want to make the difference

$$|h(x) - c^2| = |x^2 - c^2|$$

less than a preassigned  $\varepsilon > 0$  by taking  $x$  sufficiently close to  $c$ . To do so, we note that  $x^2 - c^2 = (x + c)(x - c)$ .

Moreover, if  $|x - c| < 1$ , Then

$$|x| < |c| + 1 \text{ so that } |x + c| \leq |x| + |c| < 2|c| + 1.$$

Therefore, if  $|x - c| < 1$ , we have (1)  $|x^2 - c^2| = |x + c||x - c| < (2|c| + 1)|x - c|$ .

Moreover this last term will be less than  $\varepsilon$  provided we take  $\frac{|x-c|<\varepsilon}{(2|c|+1)}$ . Consequently, if we choose

$$\delta(\varepsilon) := \inf \left\{ 1, \frac{\varepsilon}{2|c|+1} \right\},$$

Then if  $0 < |x - c| < \delta(\varepsilon)$ , it will follow first that

$$|x - c| < 1 \text{ so that (1) is valid, and therefore, since } \frac{|x-c|<\varepsilon}{(2|c|+1)}$$

that

$$|x^2 - c^2| < (2|c| + 1)|x - c| < \varepsilon.$$

Since we have a way of choosing  $\delta(\varepsilon) > 0$  for an arbitrary choice of  $\varepsilon > 0$ , we infer that

$$\lim_{x \rightarrow c} h(x) = \lim_{x \rightarrow c} x^2 = c^2.$$

**Contoh 4.1.7**

(c)  $\lim_{x \rightarrow c} x^2 = c^2$ .

Misalkan  $h(x) := x^2, \forall x \in \mathbb{R}$ . Kita ingin membuat selisih

$$|h(x) - c^2| = |x^2 - c^2|$$

Lebih kecil dari  $\varepsilon > 0$  yang diberikan dengan pengambilan

$x$  cukup dekat dengan  $c$ . Untuk itu, perhatikan bahwa

$x^2 - c^2 = (x + c)(x - c)$ . Selain itu, jika  $|x - c| < 1$ ,

maka

$$|x| < |c| + 1 \text{ dengan } |x + c| \leq |x| + |c| < 2|c| + 1.$$

Oleh karena itu, jika  $|x - c| < 1$ , kita mempunyai

$$(1) |x^2 - c^2| = |x + c||x - c| < (2|c| + 1)|x - c|.$$

Suku terakhir lebih kecil dari  $\varepsilon$  asal kita mengambil  $\frac{|x-c|<\varepsilon}{(2|c|+1)}$

.

Akibatnya, jika memilih

$$\delta(\varepsilon) := \inf \left\{ 1, \frac{\varepsilon}{2|c|+1} \right\},$$

Jika maka  $0 < |x - c| < \delta(\varepsilon)$ , akan berlaku  $|x - c| < 1$

dengan demikian (1) valid, dan oleh karena itu, karena

$$\frac{|x-c|<\varepsilon}{(2|c|+1)} \text{ maka } |x^2 - c^2| < (2|c| + 1)|x - c| < \varepsilon.$$

Karena mempunyai pilihan  $\delta(\varepsilon) > 0$  untuk sebarang  $\varepsilon > 0$ , maka

$$\lim_{x \rightarrow c} h(x) = \lim_{x \rightarrow c} x^2 = c^2.$$

<p><b>Alternatif Jawaban dari C. 4.1.7</b></p> <p>(c) <math>\lim_{x \rightarrow c} x^2 = c^2</math>.</p> <p>Jawab:</p> <p><math>\lim_{x \rightarrow x} x^2 = c^2 \rightarrow</math> Bukti?</p> <p><b>Bukti:</b></p> <p>Misal:</p> <p><math>h(x) := x^2, \forall x \in \mathbb{R}</math>.</p> <p><math>L = c^2</math></p> <p><math> h(x) - L  =  x^2 - c^2 </math></p> <p><math>\forall \varepsilon &gt; 0</math> sehingga <math>x^2 - c^2 = (x + c)(x - c)</math>.</p> <p>Pilih <math> x - c  &lt; 1</math> sehingga</p> <p><math> x  -  c  \leq  x - c  &lt; 1 \Leftrightarrow  x  -  c  &lt; 1 \Leftrightarrow  x  &lt;  c  + 1</math></p> <p><math> x + c  \leq  x  +  c  &lt;  c  + 1 +  c  = 2 c  + 1</math> sehingga</p> <p><math>x^2 - c^2 = (x + c)(x - c) =  x + c  x - c  &lt; (2 c  + 1) x - c </math>.</p> <p>Agar <math>(2 c  + 1) x - c  &lt; \varepsilon</math>.</p> <p>Didapat <math>\delta(\varepsilon) := \inf\left\{1, \frac{\varepsilon}{2 c +1}\right\}</math> sehingga <math> x - c  &lt; \frac{\varepsilon}{2 c +1}</math></p> <p>Berdasarkan D.4.1.4 maka <math>0 &lt;  x - c  &lt; \delta(\varepsilon)</math> sehingga</p> <p><math> h(x) - L  =  x^2 - c^2  =  x + c  x - c  &lt; (2 c  + 1) \cdot \frac{\varepsilon}{2 c +1} = \varepsilon</math>.</p> <p>Jadi, terbukti <math>\lim_{x \rightarrow c} x^2 = c^2</math>.</p>	<p><b>Poin Penting dari C. 4.1.7</b></p> <ol style="list-style-type: none"> <li><math>h(x) := x^2, \forall x \in \mathbb{R}</math>.</li> <li><math>L = c^2</math></li> <li><math> h(x) - L  =  x^2 - c^2 </math></li> <li><math>\forall \varepsilon &gt; 0</math></li> <li><math>x^2 - c^2 = (x + c)(x - c)</math>.</li> <li><math> x  -  c  \leq  x - c  \leq 1</math></li> <li><math> x + c  &lt; 2 c  + 1</math></li> <li><math> x - c  &lt; \frac{\varepsilon}{2 c +1}</math></li> <li><math>\delta(\varepsilon) := \inf\left\{1, \frac{\varepsilon}{2 c +1}\right\}</math></li> <li><math>\lim_{x \rightarrow c} x^2 = c^2</math></li> </ol>
<p><b>Alternatif Bukti dari T. 2.2.2</b></p> <p>Untuk <math> x  -  c </math> dan <math> x + c </math></p> <p><math>  a  -  b   \leq  a - b  \leq  a  +  b </math></p> <p><math> a + b  \leq  a  +  b </math></p> <p><math> a - b  \leq  a  +  b </math></p> <ol style="list-style-type: none"> <li><math> ab  =  a  b </math></li> <li><math> a ^2 = a^2</math> <ol style="list-style-type: none"> <li><math>a \rightarrow a^2 = a^2</math></li> <li><math>0 \rightarrow 0^2 = 0^2</math></li> <li><math>-a \rightarrow (-a)^2 = a^2</math></li> </ol> </li> <li><math> a  \leq c, c \geq 0</math> <ol style="list-style-type: none"> <li><math>a \leq c</math></li> <li><math>0 \leq c</math></li> </ol> </li> </ol>	<p><b>Point Penting Alternatif Bukti dari T. 2.2.2</b></p> <ol style="list-style-type: none"> <li><math> ab  =  a  b </math></li> <li><math> a ^2 = a^2</math></li> <li><math> a  \leq c, c \geq 0</math></li> <li><math> -a  \leq a \leq  a </math></li> <li><math>\forall a, b \in \mathbb{R}</math></li> </ol>



$-a \leq c$ $-c \leq a \leq c$ <p>d. <math> -a  \leq a \leq  a  \forall a \in \mathbb{R}</math></p> $c =  a  \text{ di } c$	
<p><b>Alternatif Bukti dari Corollary 2.2.4</b></p> <p>Jika <math>a, b \in \mathbb{R}</math></p> <p>a. <math>  a  -  b   \leq  a - b </math></p> <p>b. <math> a - b  \leq  a  +  b </math></p> $ a + b $ $ a - b $ <p><math>a, b \in \mathbb{R}^+ \cup \{0\}</math> sehingga <math> a - b  \leq  a + b </math></p> <p><math>a, b \in \mathbb{R}^-</math> sehingga</p> <p>1) <math>a &gt; b</math> maka <math> a - b  &lt;  a + b </math></p> <p>2) <math>a &lt; b</math> maka <math> a - b  &lt;  a + b </math></p> <p>Sehingga <math> a - b  &lt;  a + b </math></p> <p><math>a \in \mathbb{R}^+, b \in \mathbb{R}^-</math> <math> a + b  &lt;  a - b </math></p> <p><math>a \in \mathbb{R}^-, b \in \mathbb{R}^+</math></p> $ a + b  <  a - b $	<p><b>Point Penting Alternatif Bukti dari Corollary 2.2.4</b></p> <ol style="list-style-type: none"> <li><math>a, b \in \mathbb{R}</math></li> <li><math>  a  -  b   \leq  a - b </math></li> <li><math> a - b  \leq  a  +  b </math></li> <li><math>a, b \in \mathbb{R}^+</math></li> <li><math>a, b \in \mathbb{R}^-</math></li> </ol>

(d)  $\lim_{x \rightarrow c} \frac{1}{x} = \frac{1}{c}$  if  $c > 0$ .

Let  $\varphi(x) := \frac{1}{c} 1/x$  for  $x > 0$  and let  $c > 0$ . To show that  $\lim_{x \rightarrow c} \varphi = 1/c$  we wish to make the difference

$$\left| \varphi(x) - \frac{1}{c} \right| = \left| \frac{1}{x} - \frac{1}{c} \right|$$

less than a preassigned  $\varepsilon > 0$  by taking  $x$  sufficiently close to  $c > 0$ .

We first note that

$$\left| \frac{1}{x} - \frac{1}{c} \right| = \left| \frac{1}{cx} (c - x) \right| = \frac{1}{cx} |x - c|$$

for  $x > 0$ . It is useful to get an upper bound for the term  $1/(cx)$  that holds in some neighborhood of  $c$ . In particular, if  $|x - c| < \frac{1}{2}c$ , then

(d)  $\lim_{x \rightarrow c} \frac{1}{x} = \frac{1}{c}$  jika  $c > 0$ .

Berikan  $\varphi(x) := \frac{1}{c} 1/x$  untuk  $x > 0$  dan biarkan  $c > 0$ . Untuk menunjukkan bahwa  $\lim_{x \rightarrow c} \varphi = 1/c$  kami ingin membuat selisih

$$\left| \varphi(x) - \frac{1}{c} \right| = \left| \frac{1}{x} - \frac{1}{c} \right|$$

kurang dari  $\varepsilon > 0$  yang telah ditetapkan sebelumnya dengan mengambil  $x$  cukup dekat dengan  $c > 0$ . Kami pertama mencatat itu

$$\left| \frac{1}{x} - \frac{1}{c} \right| = \left| \frac{1}{cx} (c - x) \right| = \frac{1}{cx} |x - c|$$

untuk  $x > 0$ . Hal ini berguna untuk mendapatkan batas atas untuk istilah  $1/(cx)$  yang berlaku di beberapa sekitaran  $c$ .

## 4.1 Limits of Functions

$\frac{1}{2}c < x < \frac{3}{2}c$  (why?), so that

$$0 < \frac{1}{cx} < \frac{2}{c^2} \quad \text{for} \quad |x - c| < \frac{1}{2}c.$$

Therefore, for these values of  $x$  we have

$$(2) \quad \left| \varphi(x) - \frac{1}{c} \right| \leq \frac{2}{c^2} |x - c|.$$

In order to make this last term less than  $\varepsilon$  it suffices to take  $|x - c| < \frac{1}{2}c^2\varepsilon$ . Consequently, if we choose

$$\delta(\varepsilon) := \inf \left\{ \frac{1}{2}c, \frac{1}{2}c^2\varepsilon \right\},$$

then if  $0 < |x - c| < \delta(\varepsilon)$ , it will follow first that  $|x - c| < \frac{1}{2}c$  so that

(2) is valid, and therefore, since  $|x - c| < \left(\frac{1}{2}c^2\right)\varepsilon$ , that

$$\left| \varphi(x) - \frac{1}{c} \right| = \left| \frac{1}{x} - \frac{1}{c} \right| < \varepsilon.$$

Since we have a way of choosing  $\delta(\varepsilon) > 0$  for an arbitrary choice of  $\varepsilon > 0$ , we infer that  $\lim_{x \rightarrow c} \varphi = \frac{1}{c}$ .

## 4.1 Fungsi Limit

Khususnya, jika  $|x - c| < \frac{1}{2}c$ , lalu  $\frac{1}{2}c < x < \frac{3}{2}c$  (mengapa?), sehingga

$$0 < \frac{1}{cx} < \frac{2}{c^2} \quad \text{for} \quad |x - c| < \frac{1}{2}c.$$

Oleh karena itu, untuk nilai-nilai ini  $x$  yang kita miliki

$$(2) \quad \left| \varphi(x) - \frac{1}{c} \right| \leq \frac{2}{c^2} |x - c|.$$

Untuk membuat istilah terakhir ini kurang dari  $\varepsilon$ , cukup untuk mengambil  $|x - c| < \frac{1}{2}c^2\varepsilon$ . Konsekuensinya, jika kita memilih

$$\delta(\varepsilon) := \inf \left\{ \frac{1}{2}c, \frac{1}{2}c^2\varepsilon \right\},$$

kemudian jika  $0 < |x - c| < \delta(\varepsilon)$ , maka akan terlebih dahulu bahwa  $|x - c| < \frac{1}{2}c$  sehingga (2) valid, dan karena itu, sejak

$|x - c| < \left(\frac{1}{2}c^2\right)\varepsilon$ , sehingga

$$\left| \varphi(x) - \frac{1}{c} \right| = \left| \frac{1}{x} - \frac{1}{c} \right| < \varepsilon.$$

Karena kita memiliki cara memilih  $\delta(\varepsilon) > 0$  untuk pilihan acak  $\varepsilon > 0$ , kita menyimpulkan bahwa  $\lim_{x \rightarrow c} \varphi = \frac{1}{c}$ .

### Alternatif Jawaban Dari C. 4.1.7 (d)

$$(d) \lim_{x \rightarrow c} \frac{1}{x} = \frac{1}{c}$$

Jawab:

$$\lim_{x \rightarrow c} \frac{1}{x} = \frac{1}{c} \text{ jika } c > 0 \rightarrow \text{Bukti?}$$

**Bukti :**

$$\varphi(x) = \frac{1}{x} \text{ untuk } x > 0 \text{ dan } c > 0$$

$$L = \frac{1}{c}$$

$$|\varphi(x) - L| = \left| \frac{1}{x} - \frac{1}{c} \right|$$

### Point Penting Dari C. 4.1.7 (d)

1.  $\varphi(x) = \frac{1}{x}$  untuk  $x > 0$  dan  $c > 0$
2.  $L = \frac{1}{c}$
3.  $|\varphi(x) - L| = \left| \frac{1}{x} - \frac{1}{c} \right|$
4.  $\forall \varepsilon > 0$
5.  $\left| \frac{1}{x} - \frac{1}{c} \right| = \frac{1}{xc} |x - c|$
6.  $x > 0$
7.  $0 < \frac{1}{cx} < \frac{2}{c^2}$  untuk  $|x - c| < \frac{1}{2}c$

$$\begin{aligned}
 \forall \varepsilon > 0 \text{ sehingga } \left| \frac{1}{x} - \frac{1}{c} \right| &= \left| \frac{c-x}{cx} \right| \\
 &= \left| \frac{1}{cx} (c-x) \right| \\
 &= \left| \frac{1}{cx} \right| |(c-x)| \\
 &= \left| \frac{1}{cx} \right| |-(x-c)| \\
 &= \left| \frac{1}{cx} \right| |-1| |(x-c)| \\
 &= \frac{1}{cx} |x-c| \text{ (karena } c > 0, x > 0)
 \end{aligned}$$

$$\begin{aligned}
 \text{Pilih } |x-c| < \frac{1}{2}c &\Leftrightarrow -\frac{1}{2}c < x-c < \frac{1}{2}c \\
 &\Leftrightarrow -\frac{1}{2}c + c < x < \frac{1}{2}c + c \\
 &\Leftrightarrow \frac{1}{2}c < x < \frac{3}{2}c
 \end{aligned}$$

Ambil  $\frac{1}{2}c < x$

$$\begin{aligned}
 &\Leftrightarrow \frac{c}{2} < x \\
 &\Leftrightarrow \frac{c}{2} > \frac{1}{x} \\
 &\Leftrightarrow \frac{1}{x} < \frac{c}{2} \\
 &\Leftrightarrow 0 < \frac{1}{x} < \frac{2}{c} \\
 &\Leftrightarrow 0 \cdot \frac{1}{c} < \frac{1}{x} \cdot \frac{1}{c} \\
 &\quad < \frac{2}{c} \cdot \frac{1}{c} \\
 &\Leftrightarrow 0 < \frac{1}{cx} < \frac{2}{c^2}
 \end{aligned}$$

sehingga

$$0 < \frac{1}{cx} < \frac{2}{c^2} \text{ untuk } |x-c| < \frac{1}{2}c$$

$$8. \left| \varphi(x) - \frac{1}{c} \right| \leq \frac{2}{c^2} |x-c|$$

$$9. |x-c| < \frac{1}{2}c^2\varepsilon$$

$$10. \delta(\varepsilon) = \inf \left\{ \frac{1}{2}c, \frac{1}{2}c^2\varepsilon \right\}$$

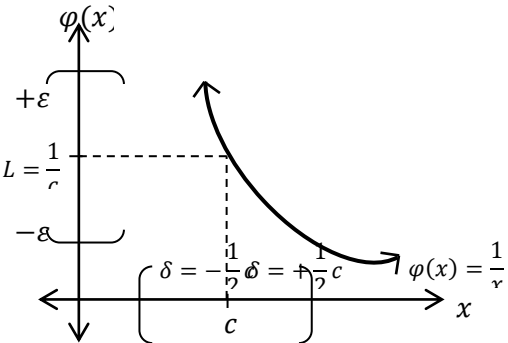
$\left  \varphi(x) - \frac{1}{c} \right  = \frac{1}{cx}  x - c  < \frac{2}{c^2}  x - c $ <p>Agar <math>\frac{2}{c^2}  x - c  &lt; \varepsilon</math> sehingga <math> x - c  &lt; \frac{1}{2} c^2 \varepsilon</math></p> <p>Didapat <math>\delta(\varepsilon) = \inf \left\{ \frac{1}{2} c, \frac{1}{2} c^2 \varepsilon \right\}</math></p> <p>Berdasarkan D. 4.1.4 <math>0 &lt;  x - c  &lt; \delta c x</math> sehingga</p> $ \varphi(x) - L  = \left  \frac{1}{x} - \frac{1}{c} \right  = \frac{1}{cx}  x - c  < \frac{2}{c^2} \cdot \frac{1}{2} c^2 \varepsilon = \varepsilon$ <p>Jadi, <math>\lim_{x \rightarrow c} \frac{1}{x} = \frac{1}{c}</math> jika <math>c &gt; 0</math> ter</p>	
<p><b>Ilustrasi Dari C. 4.1.7 (d)</b></p> 	

## 4.1.7 Examples

$$(e) \lim_{x \rightarrow 2} \frac{x^3 - 4}{x^2 + 1} = \frac{4}{5}.$$

Let  $\psi(x) := (x^3 - 4) / (x^2 + 1)$  for  $x \in \mathbb{R}$ . Then a little algebraic manipulation gives us

$$\begin{aligned} |\psi(x) - L| &= \left| \frac{5x^3 - 4x^2 - 24}{5(x^2 + 1)} \right| \\ &= \frac{|5x^2 + 6x + 12|}{5(x^2 + 1)} \cdot |x - 2|. \end{aligned}$$

To get a bound on the coefficient of  $|x - 2|$ , we restrict  $x$  by the condition  $1 < x < 3$ . For  $x$  in this interval, we have  $5x^2 + 6x + 12 \leq 5 \cdot 3^2 + 6 \cdot 3 + 12 = 75$  and  $5(x^2 + 1) \geq 5(1^2 + 1) = 10$ , so that

$$\left| \psi(x) - \frac{4}{5} \right| \leq \frac{75}{10} |x - 2| = \frac{15}{2} |x - 2|.$$

Now for give  $\varepsilon > 0$ , we choose

$$\delta(\varepsilon) := \inf \left\{ 1, \frac{2}{15} \varepsilon \right\}.$$

Then if  $0 < |x - 2| < \delta(\varepsilon)$ , we have  $|\psi(x) - (4/5)| \leq (15/2)|x - 2| < \varepsilon$ . Since  $\varepsilon > 0$  is arbitrary, the assertion is proved.

## Contoh 4.1.7

$$(e) \lim_{x \rightarrow 2} \frac{x^3 - 4}{x^2 + 1} = \frac{4}{5}.$$

Misalkan  $\psi(x) := (x^3 - 4) / (x^2 + 1)$  untuk setiap  $x \in \mathbb{R}$ . Maka sedikit manipulasi secara aljabar memberi kita

$$\begin{aligned} |\psi(x) - L| &= \left| \frac{5x^3 - 4x^2 - 24}{5(x^2 + 1)} \right| \\ &= \frac{|5x^2 + 6x + 12|}{5(x^2 + 1)} \cdot |x - 2|. \end{aligned}$$

Untuk mendapatkan batasan pada koefisien  $|x - 2|$ , kita membatasi  $x$  dengan syarat  $1 < x < 3$ . Untuk  $x$  dalam interval ini, kita mempunyai  $5x^2 + 6x + 12 \leq 5 \cdot 3^2 + 6 \cdot 3 + 12 = 75$  dan  $5(x^2 + 1) \geq 5(1^2 + 1) = 10$ , maka

$$\left| \psi(x) - \frac{4}{5} \right| \leq \frac{75}{10} |x - 2| = \frac{15}{2} |x - 2|.$$

Sekarang untuk  $\varepsilon > 0$ , kita memilih

$$\delta(\varepsilon) = \inf \left\{ 1, \frac{2}{15} \varepsilon \right\}.$$

Kemudian jika  $0 < |x - 2| < \delta(\varepsilon)$ , kita mempunyai  $|\psi(x) - (4/5)| \leq (15/2)|x - 2| < \varepsilon$ . Karena  $\varepsilon > 0$  sebarang, pernyataan itu terbukti.

## Alternatif Jawaban dari C. 4.1.7 (e)

$$(e) \lim_{x \rightarrow 2} \frac{x^3 - 4}{x^2 + 1} = \frac{4}{5}$$

Jawab:

## Poin Penting dari C. 4.1.7 (e)

$$1. \psi(x) = \frac{x^3 - 4}{x^2 + 1}, \forall x \in \mathbb{R}$$

$$\lim_{x \rightarrow 2} \frac{x^3 - 4}{x^2 + 1} = \frac{4}{5} \Rightarrow \text{Bukti?}$$

**Bukti:**

$$\text{Misalkan } \psi(x) = \frac{x^3 - 4}{x^2 + 1}, \forall x \in \mathbb{R}$$

$$L = \frac{4}{5}$$

$\forall \varepsilon > 0$  sehingga:

$$\begin{aligned} |\psi(x) - L| &= \left| \frac{x^3 - 4}{x^2 + 1} - \frac{4}{5} \right| \\ &= \left| \frac{5(x^3 - 4) - 4(x^2 + 1)}{5(x^2 + 1)} \right| \\ &= \left| \frac{5x^3 - 20 - 4x^2 - 4}{5(x^2 + 1)} \right| \\ &= \left| \frac{5x^3 - 4x^2 - 24}{5(x^2 + 1)} \right| \\ &= \frac{|5x^2 + 6x + 12|}{5(x^2 + 1)} \cdot |x - 2| \end{aligned}$$

Pilih  $|x - 2| < 1$  sehingga  $-1 < x - 2 < 1 \Leftrightarrow 1 < x < 3$  untuk

$\frac{|5x^2 + 6x + 12|}{5(x^2 + 1)}$  sehingga

$$5x^2 + 6x + 12 \leq 5 \cdot 3^2 + 6 \cdot 3 + 12 = 75 \text{ dan } 5(x^2 + 1) \geq 5(1^2 + 1) = 10 \text{ kemudian } |\psi(x) - L| \leq \frac{75}{10} |x - 2| = \frac{15}{2} |x - 2|.$$

Agar  $\frac{15}{2} |x - 2| < \varepsilon$  sehingga  $|x - 2| < \frac{2}{15} \varepsilon$  didapat

$$\delta(\varepsilon) = \inf \left\{ 1, \frac{2}{15} \varepsilon \right\}.$$

Berdasarkan D.4.1.4 maka  $0 < |x - 2| < \delta(\varepsilon)$  sehingga

$$\begin{aligned} |\psi(x) - L| &= \left| \frac{x^3 - 4}{x^2 + 1} - \frac{4}{5} \right| \\ &= \frac{|5x^2 + 6x + 12|}{5(x^2 + 1)} \cdot |x - 2| < \frac{15}{2} \cdot \frac{2}{15} \varepsilon = \varepsilon \end{aligned}$$

$$2. L = \frac{4}{5}$$

$$3. |\psi(x) - L| = \left| \frac{x^3 - 4}{x^2 + 1} - \frac{4}{5} \right|$$

$$4. \left| \frac{x^3 - 4}{x^2 + 1} - \frac{4}{5} \right| = \frac{|5x^3 + 6x + 12|}{5(x^2 + 1)} \cdot |x - 2|$$

$$5. 5x^2 + 6x + 12 \leq 5 \cdot 3^2 + 6 \cdot 3 + 12 = 75$$

$$6. 5(x^2 + 1) \geq 5(1^2 + 1) = 10$$

$$7. |\psi(x) - L| \leq \frac{75}{10} |x - 2| = \frac{15}{2} |x - 2|$$

$$8. |x - 2| < \frac{2}{15} \varepsilon$$

$$9. \delta(\varepsilon) = \inf \left\{ 1, \frac{2}{15} \varepsilon \right\}$$

$$10. |\psi(x) - L| = \frac{|5x^2 + 6x + 12|}{5(x^2 + 1)} \cdot |x - 2| < \frac{15}{2} \cdot \frac{2}{15} \varepsilon = \varepsilon$$

$$11. \lim_{x \rightarrow 2} \frac{x^3 - 4}{x^2 + 1} = \frac{4}{5}$$

Jadi, terbukti  $\lim_{x \rightarrow 2} \frac{x^3 - 4}{x^2 + 1} = \frac{4}{5}$ .

Ilustrasi dari C. 4.1.7 (e)

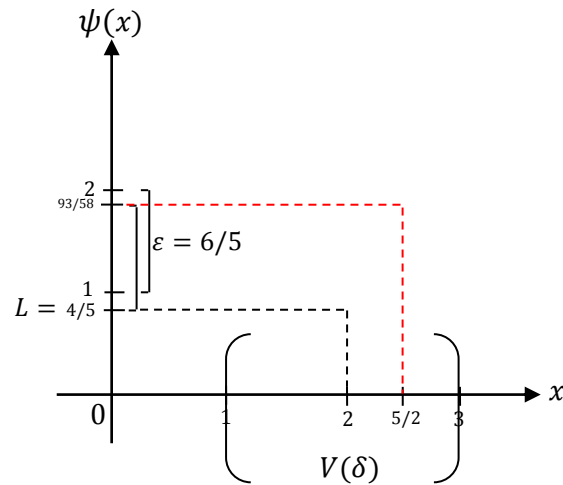

Penjelasan Ilustrasi dari C. 4.1.7 (e)

$$\psi\left(\frac{5}{2}\right) = \frac{\left(\frac{5}{2}\right)^3 - 4}{\left(\frac{5}{2}\right)^2 + 1}$$

$$= \frac{\frac{125}{8} - \frac{32}{8}}{\frac{25}{4} + \frac{4}{4}}$$

$$= \frac{\frac{93}{8}}{\frac{29}{4}}$$

$$= \frac{93}{8} \cdot \frac{4}{29}$$

$$= \frac{93}{58}$$

$$\begin{aligned} \delta(\varepsilon) &= \inf\left\{1, \frac{2}{15}\varepsilon\right\} \\ \delta\left(\frac{6}{5}\right) &= \inf\left\{1, \frac{2}{15} \cdot \frac{6}{5}\right\} \\ &= \inf\left\{1, \frac{12}{75}\right\} \\ &= 1 \end{aligned}$$

$\inf$  adalah batas bawah terbesar

**Sequential Criterion for Limits**

The following important formulation of limit of a function is in terms of limits of sequences. This characterization permits the theory of Chapter 3 to be applied to the study of limits of functions.

**4.1.8 Theorem** (*Sequential Criterion*) Let  $f: A \rightarrow \mathbb{R}$  and let  $c$  be a cluster point of  $A$ . Then the following are equivalent.

- (i)  $\lim_{x \rightarrow c} f = L$   
 (ii) For every sequence  $(x_n)$  in  $A$  that converges to  $c$  such that  $x_n \neq c$  for all  $n \in \mathbb{N}$ , the sequence  $(f(x_n))$  converges to  $L$ .

**Proof.** (i)  $\Rightarrow$  (ii). Assume  $f$  has limit  $L$  at  $c$ , and suppose  $(x_n)$  is a sequence in  $A$  with  $\lim(x_n) = c$  and  $x_n \neq c$  for all  $n \in \mathbb{N}$ . We must prove that the sequence  $(f(x_n))$  converges to  $L$ . Let  $\varepsilon > 0$  be given. Then by definition 4.1.4., there exists  $\delta > 0$  such that if  $x \in A$  satisfies  $0 < |x - c| < \delta$ , then  $f(x)$  satisfies  $|f(x) - L| < \varepsilon$ . We now apply the definition of convergent sequence for the given  $\delta$  to obtain a natural number  $K(\delta)$  such that if  $n > K(\delta)$  then  $|x_n - c| < \delta$ . But for each such  $x_n$  we have  $|f(x_n) - L| < \varepsilon$ . Thus if  $n > K(\delta)$ , then  $|f(x_n) - L| < \varepsilon$ . Therefore, the sequence  $(f(x_n))$  converges to  $L$ .

(ii)  $\Rightarrow$  (i). [The proof is a contrapositive argument]. If (i) is not true, then there exists an  $\varepsilon_0$ -neighborhood  $V_{\varepsilon_0}(L)$  such that no matter what  $\delta$ -neighborhood of  $c$  we pick, there will be a least one number  $x_\delta$  in  $A \cap V_\delta(c)$  with  $x_\delta \neq c$  such that  $f(x_\delta) \notin V_{\varepsilon_0}(L)$ . Hence for every  $n \in \mathbb{N}$ , the  $(\frac{1}{n})$ -neighborhood of  $c$  contains a number  $x_n$  such that

$$0 < |x_n - c| < \frac{1}{n} \text{ and } x_n \in A,$$

but such that

$$|f(x_n) - L| \geq \varepsilon_0 \text{ for all } n \in \mathbb{N}.$$

We conclude that the sequence  $(x_n)$  in  $A \setminus \{c\}$  converges to  $c$ , but the sequence  $(f(x_n))$  does not converge to  $L$ . Therefore we have

**Kriteria Barisan untuk Limit**

Perumusan penting berikut dari limit fungsi adalah dalam urutan limit. Karakterisasi ini memungkinkan teori Bab 3 diterapkan pada studi limit fungsi.

**Teorema 4.1.8** (*Kriteria Barisan*) Misalkan  $f: A \rightarrow \mathbb{R}$  dan misalkan  $c$  adalah titik kumpul  $A$ . Lalu ekuivalennya.

- (i)  $\lim_{x \rightarrow c} f = L$   
 (ii) Untuk setiap barisan  $(x_n)$  di  $A$  konvergen ke  $c$  sedemikian sehingga  $x_n \neq c$  untuk semua  $n \in \mathbb{N}$ , barisan  $(f(x_n))$  konvergen ke  $L$ .

**Bukti.** (i)  $\Rightarrow$  (ii). Asumsikan  $f$  mempunyai limit  $L$  di  $c$ , dan andaikan  $(x_n)$  adalah barisan di  $A$  dengan  $\lim(x_n) = c$  dan  $x_n \neq c$  untuk semua  $n \in \mathbb{N}$ . Kita harus membuktikan bahwa barisan  $(f(x_n))$  konvergen ke  $L$ . Misal diberikan  $\varepsilon > 0$ . Kemudian dari Definisi 4.1.4., ada  $\delta > 0$  sedemikian sehingga jika  $x \in A$  memenuhi  $0 < |x - c| < \delta$ , kemudian  $f(x)$  memenuhi  $|f(x) - L| < \varepsilon$ . Sekarang kita menggunakan definisi barisan konvergen (D.3.1.3) pada  $\delta$  yang diberikan untuk memperoleh bilangan asli  $K(\delta)$  sedemikian sehingga jika  $n > K(\delta)$  maka  $|x_n - c| < \delta$ . Tetapi setiap  $x_n$  kita mempunyai  $|f(x_n) - L| < \varepsilon$ . Jadi jika  $n > K(\delta)$ , maka  $|f(x_n) - L| < \varepsilon$ . Oleh karena itu, barisan  $(f(x_n))$  konvergen ke  $L$ .

(ii)  $\Rightarrow$  (i). [Pembuktian ini merupakan argumen kontrapositif]. Jika (i) tidak benar, maka terdapat daerah persekitaran  $\varepsilon_0$  dari  $V_{\varepsilon_0}(L)$  sedemikian sehingga daerah persekitaran apapun  $\delta$  dari  $c$  yang kita pilih, akan selalu terdapat paling sedikit satu  $x_\delta$  di  $A \cap V_\delta(c)$  dengan  $x_\delta \neq c$  sedemikian sehingga  $f(x_\delta) \notin V_{\varepsilon_0}(L)$ . Dari sini untuk setiap  $n \in \mathbb{N}$ , daerah persekitaran  $(\frac{1}{n})$  dari  $c$  memuat suatu bilangan  $x_n$  sedemikian sehingga

$$0 < |x_n - c| < \frac{1}{n} \text{ dan } x_n \in A,$$



shown that if (i) is not true, then (ii) is not true. We conclude that (ii) implies (i).

Q.E.D

We shall see in the next section that many of the basic limit properties of functions can be established by using corresponding properties for convergent sequences. For example, we know from our work with sequences that if  $(x_n)$  is any sequence that converges to a number  $c$ , then  $x_n^2$  converges to  $c^2$ . Therefore, by the sequential criterion, we can conclude that the function  $h(x) := x^2$  has limit  $\lim_{x \rightarrow c} h(x) = c^2$ .

tetapi sedemikian sehingga

$$|f(x_n) - L| \geq \varepsilon_0 \text{ untuk semua } n \in \mathbb{N}.$$

Kita menyimpulkan bahwa barisan  $(x_n)$  dalam  $A \setminus \{c\}$  konvergen ke  $c$ , tetapi barisan  $(f(x_n))$  tidak konvergen ke  $L$ . Oleh karena itu kita telah menunjukkan bahwa jika (i) tidak benar, maka (ii) juga tidak benar. Kita simpulkan bahwa (ii) menyebabkan (i).

Q.E.D

Kita akan melihat di bagian selanjutnya bahwa banyak sifat dasar dari limit fungsi dapat ditetapkan dengan menggunakan sifat yang sesuai untuk barisan konvergen. Sebagai contoh, kita tahu dari pekerjaan kita dengan barisan bahwa jika  $(x_n)$  adalah barisan yang konvergen ke bilangan  $c$ , maka  $x_n^2$  konvergen ke  $c^2$ . Oleh karena itu, dengan kriteria barisan, kita dapat menyimpulkan bahwa fungsi  $h(x) := x^2$  memiliki batasan  $\lim_{x \rightarrow c} h(x) = c^2$ .

<p><b>Notasi Matematika dari T. 4.1.8</b>  <math>f: A \rightarrow \mathbb{R}, c</math> titik kumpul <math>A</math> lalu  <i>(i)</i> <math>\lim_{x \rightarrow c} f = L \Leftrightarrow</math> <i>(ii)</i> <math>\forall (x_n) \rightarrow c, (x_n) \text{ di } A \ni x_n \neq c, \forall n \in \mathbb{N}</math> sehingga <math>(f(x_n)) \rightarrow L</math></p>	<p><b>Kontrapositif dari T. 4.1.8</b>  <math>f: A \rightarrow \mathbb{R}, c</math> bukan titik kumpul <math>A</math> lalu  <i>(ii)</i> <math>\exists (x_n) \nrightarrow c, (x_n) \text{ di } A \ni x_n = c, \exists n \in \mathbb{N}</math> sehingga <math>(f(x_n)) \nrightarrow L \Leftrightarrow</math> <i>(i)</i> <math>\lim_{x \rightarrow c} f \neq L</math></p>
<p><b>Poin Penting dari T. 4.1.8</b></p> <ol style="list-style-type: none"> <li><math>f: A \rightarrow \mathbb{R}</math></li> <li><math>c</math> titik kumpul <math>A</math></li> <li><math>\lim_{x \rightarrow c} f = L</math></li> <li><math>\forall</math> barisan <math>(x_n)</math> di <math>A</math> konvergen ke <math>c</math> [<math>\forall (x_n) \rightarrow c, (x_n) \text{ di } A</math>]</li> <li><math>x_n \neq c, \forall n \in \mathbb{N}</math></li> <li>Barisan <math>(f(x_n))</math> konvergen ke <math>L</math> [<math>(f(x_n)) \rightarrow L</math>]</li> </ol>	<p><b>Poin Penting dari Kontrapositif</b></p> <ol style="list-style-type: none"> <li><math>f: A \rightarrow \mathbb{R}</math></li> <li><math>c</math> bukan titik kumpul <math>A</math></li> <li><math>\exists</math> barisan <math>(x_n)</math> di <math>A</math> tidak konvergen ke <math>c</math> [<math>\exists (x_n) \nrightarrow c, (x_n) \text{ di } A</math>]</li> <li><math>x_n = c, \exists n \in \mathbb{N}</math></li> <li>Barisan <math>(f(x_n))</math> tidak konvergen ke <math>L</math> [<math>(f(x_n)) \nrightarrow L</math>]</li> <li><math>\lim_{x \rightarrow c} f \neq L</math></li> </ol>
<p><b>Alternatif Bukti dari T. 4.1.8</b>  <math>f: A \rightarrow \mathbb{R}, c</math> titik kumpul <math>A</math> lalu  <i>(i)</i> <math>\lim_{x \rightarrow c} f = L \Leftrightarrow</math> <i>(ii)</i> <math>\forall (x_n) \rightarrow c, (x_n) \text{ di } A \ni x_n \neq c, \forall n \in \mathbb{N}</math> sehingga <math>(f(x_n)) \rightarrow L \rightarrow</math> Bukti?</p>	<p><b>Poin Penting Alternatif Bukti dari T. 4.1.8</b></p> <ol style="list-style-type: none"> <li><math>f: A \rightarrow \mathbb{R},</math></li> <li><math>c</math> titik kumpul <math>A</math></li> <li><math>\lim_{x \rightarrow c} f = L</math></li> </ol>

**Bukti:****(i)  $\Rightarrow$  (ii)**

Karena  $\lim_{x \rightarrow c} f = L$  sehingga  $L$  adalah limit  $f$  pada  $c$ .

Misal  $(x_n)$  di  $A$  dengan  $\lim(x_n) = c$  sehingga  $x_n \neq c, \forall n \in \mathbb{N}$ .

Ambil  $\forall \varepsilon > 0$  dan berdasarkan D.4.1.4 maka  $\exists \delta > 0 \exists x \in A, 0 < |x - c| < \delta$  sehingga  $|f(x) - L| < \varepsilon$ .

Berdasarkan D.3.1.3 dan  $\delta > 0$  maka  $\exists K(\delta), K(\delta) \in \mathbb{N} \exists n > K(\delta), |x_n - c| < \delta$  sehingga  $|f(x_n) - L| < \varepsilon$ .

Kemudian  $n > K(\delta)$  maka  $|f(x_n) - L| < \varepsilon$  sehingga  $(f(x_n)) \rightarrow L$ .

Jadi, terbukti **(ii)**  $\forall (x_n) \rightarrow c, (x_n)$  di  $A \ni x_n \neq c, \forall n \in \mathbb{N}$  sehingga  $(f(x_n)) \rightarrow L$ .

**(ii)  $\Rightarrow$  (i)**

Anggap  $\lim_{x \rightarrow c} f \neq L$  sehingga  $\exists V_{\varepsilon_0}(L) \ni \exists V_\delta(c)$ .

Lalu  $x_\delta$  di  $A \cap V_\delta(c), x_\delta \neq c \ni f(x_\delta) \notin V_{\varepsilon_0}(L)$ .

Jika  $\forall n \in \mathbb{N}, x_n$  di  $V_{\frac{1}{n}}(c) \ni 0 < |x_n - c| < \frac{1}{n}, x_n \in A$ ,

tetapi  $|f(x_n) - L| \geq \varepsilon_0, \forall n \in \mathbb{N}$ .

Kemudian kita simpulkan bahwa  $(x_n)$  di  $A \setminus \{c\}, (x_n) \rightarrow c$  akan tetapi  $(f(x_n)) \not\rightarrow L$ .

Jadi, berdasarkan kontraposisi jika **(i)** tidak benar, maka **(ii)** juga tidak benar sehingga terbukti **(ii)  $\Rightarrow$  (i)**.

4.  $\forall (x_n) \rightarrow c, (x_n)$  di  $A$ 5.  $x_n \neq c, \forall n \in \mathbb{N}$ 6.  $(f(x_n)) \rightarrow L$ 7.  $\exists \delta > 0$ 8.  $x \in A$ 9.  $0 < |x - c| < \delta$ 10.  $|f(x) - L| < \varepsilon$ 11.  $\exists K(\delta), K(\delta) \in \mathbb{N} \exists n > K(\delta)$ 12.  $|x_n - c| < \delta$ 13.  $|f(x_n) - L| < \varepsilon$ 14.  $(f(x_n)) \rightarrow L$ 15.  $\lim_{x \rightarrow c} f \neq L$ 16.  $\exists V_{\varepsilon_0}(L) \ni \exists V_\delta(c)$ 17.  $x_\delta$  di  $A \cap V_\delta(c), x_\delta \neq c \ni f(x_\delta) \notin V_{\varepsilon_0}(L)$ 18.  $\forall n \in \mathbb{N}, x_n$  di  $V_{\frac{1}{n}}(c)$ 19.  $0 < |x_n - c| < \frac{1}{n}, x_n \in A$ 20.  $|f(x_n) - L| \geq \varepsilon_0, \forall n \in \mathbb{N}$ 21.  $(x_n)$  di  $A \setminus \{c\}, (x_n) \rightarrow c$ 22.  $(f(x_n)) \not\rightarrow L$

**Divergence Criteria -**

It is often important to be able to show (i) that a certain number is not the limit of a function at a point, or (ii) that the function does not have a limit at a point. The following result is a consequence of (the proof of) Theorem 4.1.8. We leave the details of its proof as an important exercise.

**4.1.9 Divergence Criteria** Let  $A \subseteq \mathbb{R}$ , let  $f : A \rightarrow \mathbb{R}$  and let  $c \in \mathbb{R}$  be a cluster point of  $A$ .

- (a) If  $L \in \mathbb{R}$ , then  $f$  does not have limit  $L$  at  $c$  if and only if there exists a sequences  $(x_n)$  in  $A$  with  $x_n \neq c$  for all  $n \in \mathbb{N}$  such that the sequence  $(x_n)$  converges to  $c$  but the sequence  $(f(x_n))$  does not converge to  $L$ .
- (b) The function  $f$  does not have a limit at  $c$  if and only if there exists a sequence  $(x_n)$  in  $A$  with  $x_n \neq c$  for all  $n \in \mathbb{N}$  such that the sequence  $(x_n)$  converges to  $c$  but the sequence  $(f(x_n))$  does not converge in  $\mathbb{R}$ .

We now give some applications of this result to show how it can be used.

**Kriteria**

Seringkali penting untuk dapat menunjukkan (i) bahwa suatu bilangan tertentu bukan limit fungsi pada suatu titik, atau (ii) bahwa suatu fungsi tidak mempunyai limit pada suatu titik. Hasil berikut merupakan suatu konsekuensi dari pembuktian teorema 4.1.8. Kami meninggal rincian buktinya sebagai latihan penting.

**4.1.9 Kriteria Divergen** Misalakan  $A \subseteq \mathbb{R}$ , misalkan  $f : A \rightarrow \mathbb{R}$  dan  $c \in \mathbb{R}$  adalah titik kumpul dari  $A$ , maka:

- (a) jika  $L \in \mathbb{R}$ , maka  $f$  Tidak mempunyai limit  $L$  di  $c$  jika dan hanya jika ada suatu barisan  $(x_n)$  di  $A$  dengan  $x_n \neq c$  untuk semua  $n \in \mathbb{N}$  sedemikian sehingga barisan  $(x_n)$  konvergen ke  $C$  tetapi barisan  $(f(x_n))$  tidak konvergen ke  $L$ .
- (b)  $f$  Tidak mempunyai limit di  $C$  jika dan hanya jika ada suatu barisan  $(x_n)$  di  $A$  dengan  $x_n \neq c$  untuk semua  $n \in \mathbb{N}$  sedemikian sehingga barisan  $(x_n)$  konvergen ke  $C$  tetapi barisan  $(f(x_n))$  tidak konvergen dalam  $\mathbb{R}$ .

Kami sekarang memberikan beberapa aplikasi dari hasil ini untuk menunjukkan bagaimana penggunaannya.

<p><b>Notasi Matematika dari D. 4.1.9</b>  <math>A \subseteq \mathbb{R}</math>  <math>f : A \rightarrow \mathbb{R}, C</math> adalah titik kumpul <math>A</math>                  (a) <math>L \in \mathbb{R} \rightarrow f</math> Tidak mempunyai limit <math>L</math> di <math>c \Leftrightarrow \exists(x_n)</math> di <math>A</math>, <math>x_n \neq c, \forall n \in \mathbb{N} \ni (x_n) \rightarrow C</math> tetapi <math>(f(x_n)) \nrightarrow L</math>.                  (b) <math>f</math> Tidak mempunyai limit <math>L</math> di <math>c \Leftrightarrow \exists(x_n)</math> di <math>A, x_n \neq c, \forall n \in \mathbb{N} \ni (x_n) \rightarrow C</math> tetapi <math>(f(x_n)) \nrightarrow \mathbb{R}</math>.</p>	<p><b>Kontrapotif dari D. 4.1.9</b>  <math>A \subseteq \mathbb{R}</math>  <math>f : A \rightarrow \mathbb{R}, C</math> bukan titik kumpul <math>A</math>                  (a) <math>L \in \mathbb{R} \rightarrow f</math> mempunyai limit <math>L</math> di <math>c \Leftrightarrow \forall(x_n)</math> di <math>A, x_n = c, \exists n \in \mathbb{N} \ni (x_n) \rightarrow C</math> sehingga <math>(f(x_n)) \rightarrow L</math>.                  (b) <math>f</math> mempunyai limit <math>L</math> di <math>c \Leftrightarrow \forall(x_n)</math> di <math>A, x_n = c, \exists n \in \mathbb{N} \ni (x_n) \rightarrow C</math> sehingga <math>(f(x_n)) \rightarrow \mathbb{R}</math>.</p>
--	--

<p><b>Poin Penting dari D. 4.1.9</b></p> <ol style="list-style-type: none"> <li>(1) <math>A \subseteq \mathbb{R}</math></li> <li>(2) <math>f : A \rightarrow \mathbb{R}, C</math> adalah titik kumpul <math>A</math></li> <li>(3) <math>L \in \mathbb{R} \rightarrow f</math> Tidak mempunyai limit <math>L</math> di <math>c</math></li> <li>(4) <math>(x_n)</math> di <math>A</math></li> <li>(5) <math>x_n \neq c, \forall n \in \mathbb{N}</math></li> <li>(6) <math>(x_n) \rightarrow C</math></li> <li>(7) <math>(f(x_n)) \nrightarrow L</math></li> <li>(8) <math>(f(x_n)) \nrightarrow \mathbb{R}</math></li> </ol>	<p><b>Poin Penting dari Kontrapositif D. 4.1.9</b></p> <ol style="list-style-type: none"> <li>(1) <math>A \subseteq \mathbb{R}</math></li> <li>(2) <math>f : A \rightarrow \mathbb{R}, C</math> bukan titik kumpul <math>A</math></li> <li>(3) <math>L \in \mathbb{R} \rightarrow f</math> mempunyai limit <math>L</math> di <math>c</math></li> <li>(4) <math>(x_n)</math> di <math>A</math></li> <li>(5) <math>x_n = c, \exists n \in \mathbb{N}</math></li> <li>(6) <math>(x_n) \rightarrow C</math></li> <li>(7) <math>(f(x_n)) \rightarrow L</math></li> <li>(8) <math>(f(x_n)) \rightarrow \mathbb{R}</math></li> </ol>
---	---

**4.1.10 Examples** (a)  $\lim_{x \rightarrow c} \left(\frac{1}{x}\right)$  does not exist in  $\mathbb{R}$ .

As in example 4. 1.7(d), let  $\varphi(x) := \left(\frac{1}{x}\right)$  for  $x > 0$ . However, here we consider  $c = 0$ . The argument given in example 4. 1.7 (d) breaks down if  $c = 0$  since we cannot obtain a bound such as that in (2) of that example. Indeed, if we take the sequence  $(x_n)$  with  $x_n := \frac{1}{n}$  for  $n \in \mathbb{N}$ . Then  $\lim(x_n) = 0$ . But  $\varphi(x_n) = \frac{1}{\left(\frac{1}{n}\right)} = n$ . As we know. The sequence  $(\varphi(x_n)) = (n)$  is not convergent in  $\mathbb{R}$ . Since it is not bounded. Hence. By theorem 4. 1.9 (b).  $\lim_{x \rightarrow c} \left(\frac{1}{x}\right)$  does not exist in  $\mathbb{R}$ .

(b)  $\lim_{x \rightarrow c} \text{sgn}(x)$  does not exist in  $\mathbb{R}$   
 Let the **signum** function  $\text{sgn}$  defined by

**Contoh 4.1.10** (a)  $\lim_{x \rightarrow c} \left(\frac{1}{x}\right)$  tidak ada dalam  $\mathbb{R}$ .

Seperti contoh dalam 4.1.7 (d), misalkan  $\varphi(x) := \left(\frac{1}{x}\right)$  untuk  $x > 0$ . Akan tetapi, disini kita menyelidiki pada  $c = 0$ . Argumen yang diberikan dalam contoh 4.1.7 (d) tidak berlaku jika  $c = 0$  karena kita tidak akan memperoleh suatu batas seperti pada contoh (2) tersebut. Jika kita mengambil barisan  $(x_n)$  dengan  $x_n := \frac{1}{n}$  untuk  $n \in \mathbb{N}$ , kemudian  $\lim(x_n) = 0$ , tapi  $\varphi(x_n) = \frac{1}{\left(\frac{1}{n}\right)} = n$ . Seperti kita ketahui, bahwa barisan  $(\varphi(x_n)) = (n)$  tidak konvergen dalam  $\mathbb{R}$ , karena barisan ini tidak terbatas. Dari sini dengan teorema 4.1.9 (b)  $\lim_{x \rightarrow c} \left(\frac{1}{x}\right)$  tidak ada dalam  $\mathbb{R}$ .

(b)  $\lim_{x \rightarrow c} \text{sgn}(x)$  tidak ada dalam  $\mathbb{R}$   
 Misalkan fungsi signum didefinisikan dengan

$$\text{Sgn} := \begin{cases} +1 & \text{for } x > 0 \\ 0 & \text{for } x = 0 \\ -1 & \text{for } x < 0 \end{cases}$$

Note that  $\text{sgn}(x) = \frac{x}{|x|}$  for  $x \neq 0$ . (see figure 4.1.2), we shall show that  $\text{sgn}$  does not have a limit at  $x = 0$ . We shall do this by showing that there is a sequence  $(x_n)$  such that  $\lim(x_n) = 0$ , but such that  $(\text{sgn}(x_n))$  does not converge.

$$\text{Sgn} := \begin{cases} +1 & \text{for } x > 0 \\ 0 & \text{for } x = 0 \\ -1 & \text{for } x < 0 \end{cases}$$

Perhatikan bahwa  $\text{sgn}(x) = \frac{x}{|x|}$  untuk  $x \neq 0$ . (lihat gambar 4.1.2), kita akan menunjukkan bahwa  $\text{sgn}$  tidak mempunyai limit pada  $x = 0$ . Kita akan mengerjakan ini dengan menunjukkan bahwa terdapat barisan  $(x_n)$  sedemikian sehingga  $\lim(x_n) = 0$ , tetapi sedemikian sehingga  $(\text{sgn}(x_n))$  tidak konvergen.

**Alternatif Jawaban dari C. 4.1.10 (a)**

$\lim_{x \rightarrow c} \left(\frac{1}{x}\right)$  tidak ada dalam  $\mathbb{R} \Rightarrow$  Bukti?

**Bukti:**

Dari contoh 4.1.7(d) didapat:

$$\varphi(x) = \frac{1}{x}, \quad L = \frac{1}{c}, \quad x > 0, \quad C > 0$$

$$x > 0, \quad C > 0$$

$$\varphi(x_n) = \frac{1}{x_n} = \frac{1}{\frac{1}{n}} = n$$

$$|\varphi(x_n) - L| = \left| \frac{1}{x} - \frac{1}{C} \right|$$

$$\varepsilon > 0 \rightarrow \delta(\varepsilon) > 0, |x - C| < \delta(\varepsilon)$$

Sehingga  $|f(x) - L| < \varepsilon$ .

$$\left| \frac{1}{x} - \frac{1}{C} \right| < \varepsilon$$

$$\left| \frac{1}{x} - \frac{1}{C} \right| = \frac{1}{Cx} |x - C|$$

• Jika  $C = 0$ , maka:

$$\left| \frac{1}{x} - \frac{1}{C} \right| = \frac{1}{0 \cdot x} |x - 0| \left| \frac{1}{x} - \frac{1}{C} \right| = \frac{1}{0} |x| = \frac{x}{0} = \infty$$

Sehingga tidak ada batasan  $(x_n) = \frac{1}{x}$ .

$\varepsilon > 0 \rightarrow \delta(\varepsilon) > 0, |x - C| \geq \delta(\varepsilon)$  sehingga  $|f(x) - L| \geq \delta(\varepsilon)$ .

**Poin Penting dari C. 4.1.10 (a)**

$$1) \varphi(x) = \frac{1}{x}, \quad L = \frac{1}{c}, \quad x > 0, \quad C > 0$$

$$2) \varphi(x_n) = \frac{1}{x_n} = \frac{1}{\frac{1}{n}} = n$$

$$3) |\varphi(x_n) - L| = \left| \frac{1}{x} - \frac{1}{c} \right|$$

$$4) \varepsilon > 0 \rightarrow \delta(\varepsilon) > 0, |x - C| < \delta(\varepsilon)$$

$$5) |f(x) - L| < \varepsilon$$

$$6) \left| \frac{1}{x} - \frac{1}{c} \right| < \varepsilon$$

$$7) \left| \frac{1}{x} - \frac{1}{c} \right| = \frac{1}{cx} |x - C|$$

$$8) \text{Jika } C = 0$$

$$9) \left| \frac{1}{x} - \frac{1}{c} \right| = \frac{1}{0 \cdot x} |x - 0|$$

$$10) \left| \frac{1}{x} - \frac{1}{c} \right| = \frac{1}{0} |x|$$

$$11) (x_n) = \frac{1}{x}$$

$$12) \varepsilon > 0 \rightarrow \delta(\varepsilon) > 0$$

$$13) |x - C| \geq \delta(\varepsilon)$$

$$14) |f(x) - L| \geq \delta(\varepsilon)$$

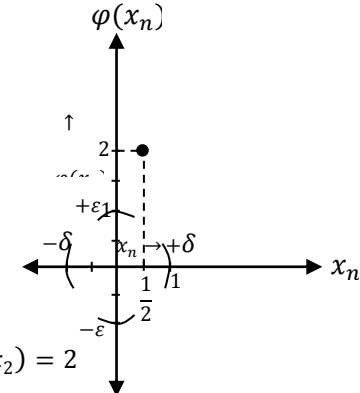
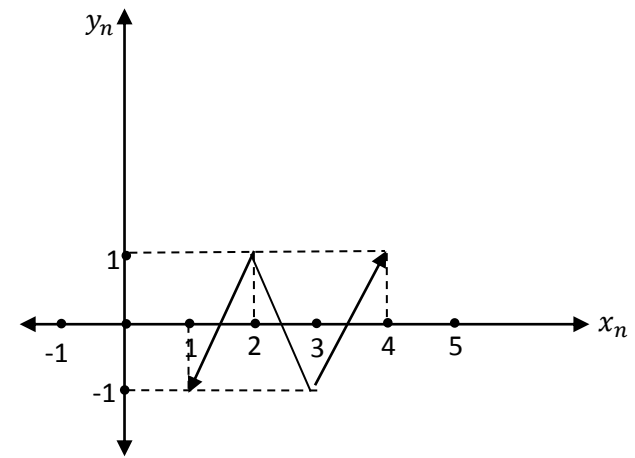
<p><b>Alternatif Jawaban dari C. 4.1.10 (b)</b>                  Contoh 3.4.6 (a)                  Barisan <math>x = ((-1)^n)</math> adalah divergen                  Barisan <math>x' = ((-1)^{2n}) = (1, 1, \dots)</math> konvergen 1 dan                  Barisan <math>x'' = ((-1)^{2n-1}) = (-1, -1, \dots)</math> konvergen                  Jadi, disimpulkan bahwa <math>x</math> adalah divergen.</p>	<p><b>Poin Penting dari C. 4.1.10 (b)</b></p> <ol style="list-style-type: none"> <li>1) <math>Sgn: = \begin{cases} +1 &amp; \text{for } x &gt; 0 \\ 0 &amp; \text{for } x = 0 \\ -1 &amp; \text{for } x &lt; 0 \end{cases}</math></li> <li>2) <math>sgn(x) = \frac{x}{ x }</math> untuk <math>x \neq 0</math></li> <li>3) Barisan divergen <math>x = ((-1)^n)</math></li> <li>4) Barisan konvergen <math>x' = ((-1)^{2n}) = (1, 1, \dots)</math></li> <li>5) Barisan konvergen <math>x'' = ((-1)^{2n-1}) = (-1, -1, \dots)</math></li> </ol>
<p><b>Ilustrasi dari C. 4.1.10 (a)</b></p>  <p>Misal :</p> <p><math>n = 2, x_2 = \frac{1}{2}, \varphi(x_2) = 2</math></p> <p><math>n = 3, x_2 = \frac{1}{3}, \varphi(x_2) = 3</math></p> <p>...</p> <p>Jadi semakin <math>x_n</math> ke kanan maka <math>\varphi(x_2)</math> akan semakin ke atas dan tidak terbatas. Sehingga <math>\varphi(x_2)</math> tidak ada dalam <math>\mathbb{R}</math>.</p>	<p><b>Ilustrasi dari C. 4.1.10 (b)</b></p> 

**4.1.10 Examples**

(c)  $\lim_{x \rightarrow 0} \sin(1/x)$  does not exist in  $\mathbb{R}$ .

Let  $g(x) := \sin(1/x)$  for  $x \neq 0$ . (See Figures 4.1.3.) We shall show that  $g$  does not have a limit at  $c = 0$ , by exhibiting two sequences  $(x_n)$  and  $(y_n)$  with  $x_n \neq 0$  and  $y_n \neq 0$  for all

**Contoh 4.1.10**

(c)  $\lim_{x \rightarrow 0} \sin(1/x)$  tidak ada dalam  $\mathbb{R}$ .

Misalkan  $g(x) := \sin(1/x)$  untuk  $x \neq 0$ . (Lihat Gambar 4.1.3.) Kita akan menunjukkan bahwa  $g$  tidak mempunyai limit pada  $c = 0$ , dengan memperlihatkan dua urutan  $(x_n)$  dan  $(y_n)$  dengan  $x_n \neq 0$

$n \in \mathbb{N}$  and such that  $\lim(x_n) = 0$  and  $\lim(y_n) = 0$ , both such that  $\lim(g(x_n)) \neq \lim(g(y_n))$ . In view of Theorem 4.1.9, this implies that  $\lim_{x \rightarrow 0} g$  cannot exist. (Explain why.)

dan  $y_n \neq 0$  untuk semua  $n \in \mathbb{N}$  dan sedemikian sehingga  $\lim(x_n) = 0$  dan  $\lim(y_n) = 0$ , tetapi sedemikian sehingga  $\lim(g(x_n)) \neq \lim(g(y_n))$ . Mengingat Teorema 4.1.9, ini mengakibatkan  $\lim_{x \rightarrow 0} g$  tidak ada. (Jelaskan mengapa.)

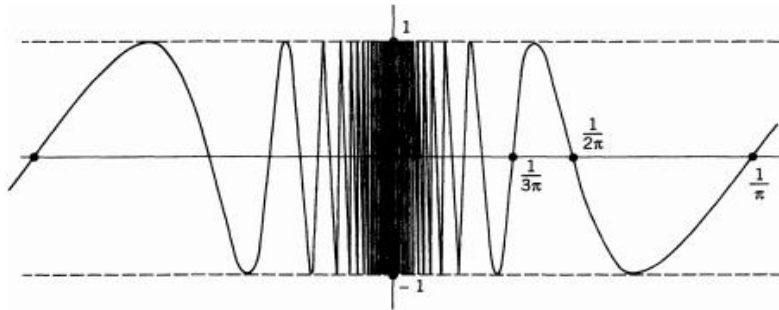

**Figure 4.1.3** The function  $g(x) = \sin(1/x)(x \neq 0)$

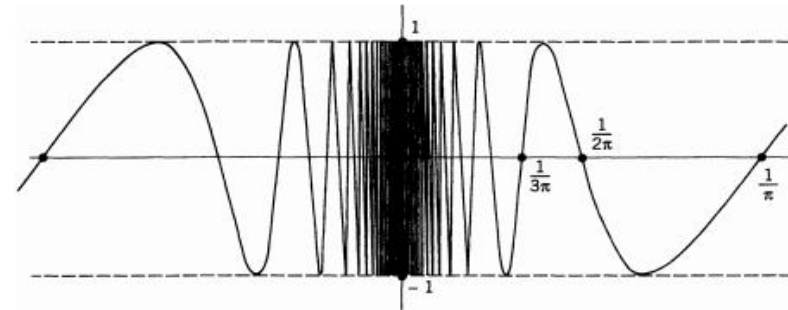

**Figur 4.1.3** Fungsi  $g(x) = \sin(1/x)(x \neq 0)$

Indeed, we recall from calculus that  $\sin t = 0$  if  $t = n\pi$  for  $n \in \mathbb{Z}$ , and that  $\sin t = +1$  if  $t = \frac{1}{2}\pi + 2\pi n$  for  $n \in \mathbb{Z}$ . Now let  $x_n := 1/n\pi$  for  $n \in \mathbb{N}$ ; then  $\lim(x_n) = 0$  and  $g(x_n) = \sin n\pi = 0$  for all  $n \in \mathbb{N}$ , so that  $\lim(g(x_n)) = 0$ . On the other hand, let  $y_n := (\frac{1}{2}\pi + 2\pi n)^{-1}$  for  $n \in \mathbb{N}$ ; then  $\lim(y_n) = 0$  and  $g(y_n) = \sin(\frac{1}{2}\pi + 2\pi n) = 1$  for all  $n \in \mathbb{N}$ , so that  $\lim(g(y_n)) = 1$ . We conclude that  $\lim_{x \rightarrow 0} \sin(1/x)$  does not exist. Q.E.D

Memang, Kita mengingat kembali dari kalkulus bahwa  $\sin t = 0$  jika  $t = n\pi$  untuk  $n \in \mathbb{Z}$ , dan  $\sin t = +1$  jika  $t = \frac{1}{2}\pi + 2\pi n$  untuk  $n \in \mathbb{Z}$ . Sekarang misalkan  $x_n := 1/n\pi$  untuk  $n \in \mathbb{N}$ ; maka  $\lim(x_n) = 0$  dan  $g(x_n) = \sin n\pi = 0$  untuk semua  $n \in \mathbb{N}$ , dengan demikian  $\lim(g(x_n)) = 0$ . Di pihak lain, misalkan  $y_n := (\frac{1}{2}\pi + 2\pi n)^{-1}$  untuk  $n \in \mathbb{N}$ ; maka  $\lim(y_n) = 0$  dan  $g(y_n) = \sin(\frac{1}{2}\pi + 2\pi n) = 1$  untuk semua  $n \in \mathbb{N}$ , dengan demikian  $\lim(g(y_n)) = 1$ . Kita simpulkan bahwa  $\lim_{x \rightarrow 0} \sin(1/x)$  tidak ada terbukti.

**Alternatif Jawaban dari C. 4.1.10 (c)**

$\lim_{x \rightarrow 0} \sin\left(\frac{1}{x}\right)$  tidak ada dalam  $\mathbb{R} \rightarrow$  Bukti?

**Bukti:**

Misal  $g(x) = \sin\left(\frac{1}{x}\right), x \neq 0$  (lihat gambar 4.1.3)

Adib:  $g$  tidak mempunyai limit pada  $c = 0$ . Melalui dua barisan  $(x_n)$  dan  $(y_n)$  dengan  $x_n \neq 0$  dan  $y_n \neq 0, \forall n \in \mathbb{N} \ni \lim(x_n) = 0$  dan  $\lim(y_n) = 0 \ni \lim(g(x_n)) \neq \lim(g(y_n))$ . Berdasarkan T. 4.1.9 sehingga  $\lim_{x \rightarrow 0} g$  tidak ada. Kita mengingat kembali dari kalkulus bahwa

$$\left. \begin{array}{l} t = n\pi \rightarrow \sin t = 0 \\ t = \frac{1}{2}\pi + 2\pi n \rightarrow \sin t = +1 \end{array} \right\} n \in \mathbb{Z}$$

Misal:

$x_n := \frac{1}{n\pi}, n \in \mathbb{N}$  maka  $\lim(x_n) = 0$  dan  $g(x_n) = \sin\left(\frac{1}{x_n}\right)$

$$\begin{aligned} g(x_n) &= \sin\left(\frac{1}{x_n}\right) \\ &= \sin\left(\frac{1}{\frac{1}{n\pi}}\right) \\ &= \sin\left(1 \times \frac{n\pi}{1}\right) \\ &= \sin(n\pi) = \sin t = 0 \ni \lim(g(x_n)) = 0 \end{aligned}$$

$y_n := \left(\frac{1}{2}\pi + 2\pi n\right)^{-1}, n \in \mathbb{N}$  maka  $\lim(y_n) = 0$  dan  $g(y_n) =$

$$\begin{aligned} &\sin \frac{1}{y_n} \\ g(y_n) &= \sin \frac{1}{y_n} \end{aligned}$$

**Point Penting dari C. 4.1.10 (c)**

1.  $g(x) = \sin\left(\frac{1}{x}\right), x \neq 0$
2.  $g$  tidak mempunyai limit pada  $c = 0$
3.  $x_n \neq 0, y_n \neq 0, \forall n \in \mathbb{N}$
4.  $\lim(x_n) = 0, \lim(y_n) = 0 \ni \lim(g(x_n)) \neq \lim(g(y_n))$
5.  $t = n\pi \rightarrow \sin t = 0, \forall n \in \mathbb{Z}$
6.  $t = \frac{1}{2}\pi + 2\pi n \rightarrow \sin t = +1, \forall n \in \mathbb{Z}$
7.  $x_n := \frac{1}{n\pi}, n \in \mathbb{N}$
8.  $y_n := \left(\frac{1}{2}\pi + 2\pi n\right)^{-1}, n \in \mathbb{N}$
9.  $g(x_n) = \sin\left(\frac{1}{x_n}\right) = \sin\left(\frac{1}{\frac{1}{n\pi}}\right) = \sin(n\pi) = \sin t = 0 \ni \lim(g(x_n)) = 0$
10.  $g(y_n) = \sin \frac{1}{y_n} = \sin \frac{1}{\left(\frac{1}{2}\pi + 2\pi n\right)^{-1}} = \sin 1 \times \left(\frac{1}{2}\pi + 2\pi n\right)^1 = \sin\left(\frac{1}{2}\pi + 2\pi n\right) = \sin t = 1 \ni \lim(g(y_n)) = 0$
11.  $\lim_{x \rightarrow 0} \sin\left(\frac{1}{x}\right)$  tidak ada terbukti.



$$= \sin \frac{1}{\left(\frac{1}{2}\pi + 2\pi n\right)^{-1}}$$

$$= \sin 1 \times \left(\frac{1}{2}\pi + 2\pi n\right)^1$$

$$= \sin \left(\frac{1}{2}\pi + 2\pi n\right) = \sin t = 1$$

Dengan demikian  $\lim (g(y_n)) = 1$ , kita simpulkan bahwa

$\lim_{x \rightarrow 0} \sin\left(\frac{1}{x}\right)$  tidak ada terbukti.

## Exercises for Section 4.1

## Exercises for Section 4.1

- Determine a condition on  $|x - 1|$  that assure that:
  - $|x^2 - 1| < \frac{1}{2}$
  - $|x^2 - 1| < \frac{1}{10^{-3}}$
  - $|x^2 - 1| < \frac{1}{n}$  for a given  $n \in \mathbb{N}$
  - $|x^3 - 1| < \frac{1}{n}$  for a given  $n \in \mathbb{N}$
- Determine a condition on  $|x - 1|$  that assure that:
  - $|\sqrt{x} - 2| < \frac{1}{2}$
  - $|\sqrt{x} - 2| < 10^{-2}$
- Let  $c$  be a cluster point of  $A \subseteq \mathbb{R}$  and let  $f: A \rightarrow \mathbb{R}$ . Prove that  $\lim_{x \rightarrow c} f(x) = L$  if and only if  $\lim_{x \rightarrow c} |f(x) - L| = 0$ .
- Let  $f: \mathbb{R} \rightarrow \mathbb{R}$  and let  $c \in \mathbb{R}$ . Show that  $\lim_{x \rightarrow c} f(x) = L$  if and only if  $\lim_{x \rightarrow c} f(x + c) = L$ .
- Let  $I := (0, a)$  where  $a > 0$ , and let  $g(x) := x^2$  for  $x \in I$ . For  $x, c \in I$ , show that  $|g(x) - c^2| \leq 2a|x - c|$ . Use this inequality to prove that  $\lim_{x \rightarrow c} x^2 = c^2$  for any  $c \in I$ .
- Let  $I$  be an interval in  $\mathbb{R}$ , let  $f: I \rightarrow \mathbb{R}$ , and let  $c \in I$ , suppose there exist constants  $K$  and  $L$  such that  $|f(x) - L| \leq K|x - c|$  for  $x \in I$ . Show that  $\lim_{x \rightarrow c} f(x) = L$ .
- Show that  $\lim_{x \rightarrow c} x^3 = c^3$  for any  $c \in \mathbb{R}$ .
- Show that  $\lim_{x \rightarrow c} \sqrt{x} = \sqrt{c}$  for any  $c > 0$ .
- Use either the  $\varepsilon - \delta$  definition of limit or the Sequential Criterion for limits, to establish the following limits:
  - $\lim_{x \rightarrow 2} \frac{1}{1-x} = -1$
  - $\lim_{x \rightarrow 1} \frac{x}{1+x} = \frac{1}{2}$

## Latihan untuk Bagian 4.1

- Tentukan suatu kondisi  $|x - 1|$  yang memastikan bahwa:
  - $|x^2 - 1| < \frac{1}{2}$
  - $|x^2 - 1| < \frac{1}{10^{-3}}$
  - $|x^2 - 1| < \frac{1}{n}$  untuk diberikan  $n \in \mathbb{N}$
  - $|x^3 - 1| < \frac{1}{n}$  untuk diberikan  $n \in \mathbb{N}$
- Tentukan suatu kondisi  $|x - 1|$  yang memastikan bahwa:
  - $|\sqrt{x} - 2| < \frac{1}{2}$
  - $|\sqrt{x} - 2| < 10^{-2}$
- Misalkan  $c$  adalah titik kumpul  $A \subseteq \mathbb{R}$  dan misalkan  $f: A \rightarrow \mathbb{R}$ . Buktikan bahwa  $\lim_{x \rightarrow c} f(x) = L$  jika dan hanya jika  $\lim_{x \rightarrow c} |f(x) - L| = 0$ .
- Misalkan  $f: \mathbb{R} \rightarrow \mathbb{R}$  dan misalkan  $c \in \mathbb{R}$ . Tunjukkan bahwa  $\lim_{x \rightarrow c} f(x) = L$  jika dan hanya jika  $\lim_{x \rightarrow c} f(x + c) = L$ .
- Misalkan  $I := (0, a)$  dimana  $a > 0$ , dan misalkan  $g(x) := x^2$  untuk  $x \in I$ . Untuk titik  $x, c \in I$ , tunjukkan bahwa  $|g(x) - c^2| \leq 2a|x - c|$ . Gunakan ketidaksetaraan ini untuk membuktikan bahwa  $\lim_{x \rightarrow c} x^2 = c^2$  untuk setiap  $c \in I$ .
- Misalkan  $I$  adalah interval di  $\mathbb{R}$ , misalkan  $f: I \rightarrow \mathbb{R}$ , dan misalkan  $c \in I$ , misalkan ada konstanta  $K$  dan  $L$  untuk  $|f(x) - L| \leq K|x - c|$  dimana  $x \in I$ . Tunjukkan bahwa  $\lim_{x \rightarrow c} f(x) = L$ .
- Tunjukkan bahwa  $\lim_{x \rightarrow c} x^3 = c^3$  untuk  $c \in \mathbb{R}$ .
- Tunjukkan bahwa  $\lim_{x \rightarrow c} \sqrt{x} = \sqrt{c}$  untuk  $c > 0$ .
- Gunakan batas  $\varepsilon - \delta$  definisi atau kriteria barisan untuk limit, untuk menetapkan limit berikut:

- (c)  $\lim_{x \rightarrow 0} \frac{x^2}{|x|} = 0$
- (d)  $\lim_{x \rightarrow 1} \frac{x^2 - x + 1}{x^2 + 1} = \frac{1}{2}$
10. Use the definition of limit to show that  
 (a)  $\lim_{x \rightarrow 2} (x^2 + 4x) = 12$ , (b)  $\lim_{x \rightarrow -1} \frac{x+5}{2x+3} = 4$ .
11. Use the definition of limit to prove the following.  
 (a)  $\lim_{x \rightarrow 3} \frac{2x+3}{4x-9} = 3$ , (b)  $\lim_{x \rightarrow 6} \frac{x^2-3x}{x+3} = 2$ .
12. Show that the following limits do *not* exist.  
 (a)  $\lim_{x \rightarrow 0} \frac{1}{x^2} (x > 0)$ , (c)  $\lim_{x \rightarrow 0} \frac{1}{\sqrt{x}} (x > 0)$ ,  
 (b)  $\lim_{x \rightarrow 0} \sin(1/x^2)$ , (d)  $\lim_{x \rightarrow 0} (x + \operatorname{sgn}(x))$ ,
13. Suppose the function  $f : \mathbb{R} \rightarrow \mathbb{R}$  has limit  $L$  at 0, and let  $a > 0$ . If  $g : \mathbb{R} \rightarrow \mathbb{R}$  is defined by  $g(x) := f(ax)$  for  $x \in \mathbb{R}$ , show that  $\lim_{x \rightarrow 0} g(x) = L$ .
14. Let  $c \in \mathbb{R}$  and let  $f : \mathbb{R} \rightarrow \mathbb{R}$  be such that  $\lim_{x \rightarrow c} (f(x))^2 = L$ .  
 (a) Show that if  $L = 0$ , then  $\lim_{x \rightarrow c} f(x) = 0$ .  
 (b) Show by example that if  $L \neq 0$ , then  $f$  may not have a limit at  $c$ .
15. Let  $f : \mathbb{R} \rightarrow \mathbb{R}$  be defined by setting  $f(x) := x$  if  $x$  is rational, and  $f(x) = 0$  if  $x$  is irrational.  
 (a) Show that  $f$  has a limit at  $x = 0$ .  
 (b) Use a sequential argument to show that if  $c \neq 0$ , then  $f$  does not have a limit at  $c$ .
16. Let  $f : \mathbb{R} \rightarrow \mathbb{R}$ , let  $I$  be an *open* interval in  $\mathbb{R}$ , and let  $c \in I$ . If  $f_1$  is the restriction of  $f$  to  $I$ , show that  $f_1$  has a limit at  $c$  if and only if  $f$  has a limit at  $c$ , and that the limits are equal.
17. Let  $f : \mathbb{R} \rightarrow \mathbb{R}$ , let  $J$  be a closed interval in  $\mathbb{R}$ , and let  $c \in J$ . If  $f_2$  is the restriction of  $f$  to  $J$ , show that if  $f$  has a limit at  $c$  then  $f_2$  has a limit at  $c$ . Show by example that it does *not* follow that if  $f_2$  has a limit at  $c$ , then  $f$  has a limit at  $c$ .
- (a)  $\lim_{x \rightarrow 2} \frac{1}{1-x} = -1$
- (b)  $\lim_{x \rightarrow 1} \frac{x}{1+x} = \frac{1}{2}$
- (c)  $\lim_{x \rightarrow 0} \frac{x^2}{|x|} = 0$
- (d)  $\lim_{x \rightarrow 1} \frac{x^2 - x + 1}{x^2 + 1} = \frac{1}{2}$
10. Gunakan definisi limit untuk menunjukkan bahwa.  
 (a)  $\lim_{x \rightarrow 2} (x^2 + 4x) = 12$ , (b)  $\lim_{x \rightarrow -1} \frac{x+5}{2x+3} = 4$ .
11. Gunakan definisi limit untuk membuktikan bahwa:  
 (a)  $\lim_{x \rightarrow 3} \frac{2x+3}{4x-9} = 3$ , (b)  $\lim_{x \rightarrow 6} \frac{x^2-3x}{x+3} = 2$ .
12. Tunjukkan bahwa batasan berikut tidak ada  
 (a)  $\lim_{x \rightarrow 0} \frac{1}{x^2} (x > 0)$ , (c)  $\lim_{x \rightarrow 0} \frac{1}{\sqrt{x}} (x > 0)$ ,  
 (b)  $\lim_{x \rightarrow 0} (x + \operatorname{sgn}(x))$ , (d)  $\lim_{x \rightarrow 0} \sin(1/x^2)$ .
13. Misalkan fungsi  $f : \mathbb{R} \rightarrow \mathbb{R}$  memiliki limit  $L$  pada 0, dan misalkan  $a > 0$ . Jika  $g : \mathbb{R} \rightarrow \mathbb{R}$  ditentukan oleh  $g(x) := f(ax)$  untuk  $x \in \mathbb{R}$ , tunjukkan bahwa  $\lim_{x \rightarrow 0} g(x) = L$ .
14. Misalkan  $c \in \mathbb{R}$  dan misalkan  $f : \mathbb{R} \rightarrow \mathbb{R}$  jadi  $\lim_{x \rightarrow c} (f(x))^2 = L$ .  
 (a) Tunjukkan bahwa jika  $L = 0$ , maka  $\lim_{x \rightarrow c} f(x) = 0$ .  
 (b) Tunjukkan dengan contoh bahwa jika  $L \neq 0$ , maka  $f$  mungkin tidak memiliki limit pada  $c$ .
15. Misalkan  $f : \mathbb{R} \rightarrow \mathbb{R}$  didefinisikan dengan menetapkan  $f(x) := x$  jika  $x$  adalah rasional, dan  $f(x) = 0$  jika  $x$  adalah tidak rasional.  
 (a) Tunjukkan bahwa  $f$  memiliki limit pada  $x = 0$ .  
 (b) Gunakan argumen barisan untuk menunjukkan bahwa jika  $c \neq 0$ , maka  $f$  tidak memiliki limit pada  $c$ .
16. Misalkan  $f : \mathbb{R} \rightarrow \mathbb{R}$ , misalkan  $I$  menjadi interval terbuka di

$\mathbb{R}$ , dan misalkan  $c \in I$ . Jika  $f_1$  adalah pembatas  $f$  terhadap  $I$ , tunjukkan  $f_1$  memiliki batas pada  $c$  jika dan hanya jika  $f$  memiliki limit pada  $c$ , dan batasnya sama.

17. Misalkan  $f : \mathbb{R} \rightarrow \mathbb{R}$ , misalkan  $J$  menjadi interval tertutup di  $\mathbb{R}$ , dan misalkan  $c \in J$ . Jika  $f_2$  adalah pembatas  $f$  terhadap  $J$ , tunjukkan bahwa  $f$  memiliki limit pada  $c$  jika kemudian  $f_2$  memiliki limit pada  $c$ . Tunjukkan dengan contoh bahwa itu tidak mengikuti bahwa jika  $f_2$  memiliki limit pada  $c$ , maka  $f$  memiliki limit pada  $c$ .

## Section 4.2 Limit Theorems

## Bagian 4.2 Teorema Limit

We shall now obtain results that are useful in calculating limits of functions. These results are parallel to the limit theorems established in Section 3.2 for sequences. In fact, in most cases these results can be proved by using Theorems 4.1.8 and results from Section 3.2. Alternatively, the results in this section can be proved by using  $\varepsilon - \delta$  arguments that are very similar to the ones employed in Section 3.2.

**4.2.1 Definition** Let  $A \subseteq \mathbb{R}$ , let  $f : A \rightarrow \mathbb{R}$ , and let  $c \in \mathbb{R}$  be a cluster point of  $A$ . We say that  $f$  is **bounded on a neighborhood of  $c$**  if there exists a  $\delta$ -neighborhood  $V_\delta(c)$  of  $c$  and a constant  $M > 0$  such that we have  $|f(x)| \leq M$  for all  $x \in A \cap V_\delta(c)$ .

Kita sekarang akan mendapatkan hasil yang berguna dalam menghitung limit fungsi. Hasil ini sejajar dengan teorema limit yang ditetapkan dalam Bagian 3.2 untuk barisan. Bahkan, dalam banyak kasus hasil ini dapat dibuktikan dengan menggunakan Teorema 4.1.8 dan hasil dari Bagian 3.2. Sebagai alternatif, hasil di bagian ini dapat dibuktikan dengan menggunakan pernyataan  $\varepsilon - \delta$  yang sangat mirip dengan yang digunakan dalam Bagian 3.2.

**Definisi 4.2.1** Misalkan  $A \subseteq \mathbb{R}$ ,  $f : A \rightarrow \mathbb{R}$ , dan  $c \in \mathbb{R}$  menjadi titik kumpul dari  $A$ . Kita mengatakan bahwa  $f$  **terbatas pada daerah persekitaran/lingkungan dari  $c$**  jika terdapat persekitaran  $\delta$  dari  $c$   $V_\delta(c)$  dan suatu konstanta  $M > 0$  sedemikian sehingga kita mempunyai  $|f(x)| \leq M$  untuk semua  $x \in A \cap V_\delta(c)$ .

**Notasi Matematika dari D. 4.2.1**

$A \subseteq \mathbb{R}$ ,  $f : A \rightarrow \mathbb{R}$ ,  $c \in \mathbb{R}$ ,  $c$  titik kumpul  $A$  lalu  $\exists V_\delta(c)$ ,  $\exists M > 0 \exists |f(x)| \leq M, \forall x \in A \cap V_\delta(c) \Rightarrow f$  terbatas disekitaran  $c$ .

**Kontrapositif dari D. 4.2.1**

$A \subseteq \mathbb{R}$ ,  $f : A \rightarrow \mathbb{R}$ ,  $c \in \mathbb{R}$ ,  $c$  bukan titik kumpul  $A$  lalu  $f$  tidak terbatas disekitaran  $c \Rightarrow \forall V_\delta(c), \forall M > 0 \exists |f(x)| > M, \exists x \in A \cap V_\delta(c)$ .

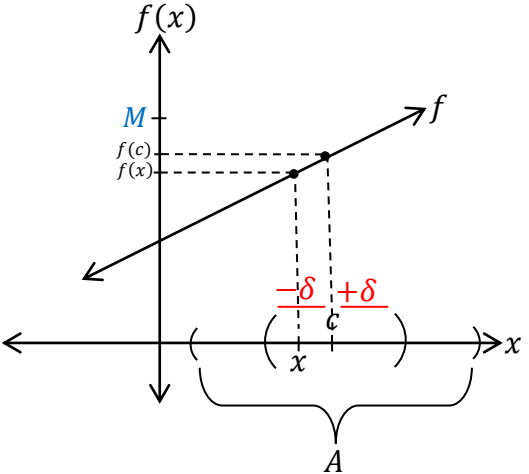
<p><b>Poin Penting dari D. 4.2.1</b></p> <ol style="list-style-type: none"> <li>1. <math>A \subseteq \mathbb{R}</math></li> <li>2. <math>f : A \rightarrow \mathbb{R}</math></li> <li>3. <math>c \in \mathbb{R}</math>, <math>c</math> titik kumpul <math>A</math></li> <li>4. <math>\exists V_\delta(c)</math></li> <li>5. <math>\exists M &gt; 0</math></li> <li>6. <math> f(x)  \leq M</math></li> <li>7. <math>\forall x \in A \cap V_\delta(c)</math></li> <li>8. <math>f</math> terbatas disekitaran <math>c</math></li> </ol>	<p><b>Poin Penting dari Kontrapositif</b></p> <ol style="list-style-type: none"> <li>1. <math>A \subseteq \mathbb{R}</math></li> <li>2. <math>f : A \rightarrow \mathbb{R}</math></li> <li>3. <math>c \in \mathbb{R}</math>, <math>c</math> bukan titik kumpul <math>A</math></li> <li>4. <math>f</math> tidak terbatas disekitaran <math>c</math></li> <li>5. <math>\forall V_\delta(c)</math></li> <li>6. <math>\forall M &gt; 0</math></li> <li>7. <math> f(x)  &gt; M</math></li> <li>8. <math>\exists x \in A \cap V_\delta(c)</math></li> </ol>
<p><b>Ilustrasi dari D. 4.2.1</b></p> 	

**4.2.2 Theorem** If  $A \subseteq \mathbb{R}$  and  $f: A \rightarrow \mathbb{R}$  has a limit at  $c \in \mathbb{R}$ , then  $f$  is bounded on some neighborhood of  $c$ .

**Proof.** If  $L = \lim_{x \rightarrow c} f(x)$ , then for  $\varepsilon = 1$ , there exists  $\delta > 0$  such that if  $0 < |x - c| < \delta$ , then  $|f(x) - L| < 1$ ; hence (by

**Teorema 4.2.2** Jika  $A \subseteq \mathbb{R}$  dan  $f: A \rightarrow \mathbb{R}$  mempunyai suatu limit pada  $c \in \mathbb{R}$ , maka  $f$  terbatas pada suatu lingkungan dari  $c$ .

**Bukti.** Jika  $L = \lim_{x \rightarrow c} f(x)$ , maka oleh teorema 4.1.6, dengan  $\varepsilon = 1$ , terdapat  $\delta > 0$  sedemikian sehingga jika  $0 <$

## 4.2 Limits Theorem

## 4.2 Teorema Limit

Corollary 2.2.4(a).

$$|f(x)| - |L| \leq |f(x) - L| < 1$$

Therefore, if  $x \in A \cap V^\delta(c), x \neq c$ , then  $|f(x)| \leq |L| + 1$ . If  $c$  bukan bagian  $A$ , we take  $M = |L| + 1$ , while if  $c \in A$  we take  $M = \text{Sup} \{|f(c)|, |L| + 1\}$ . It follows that if  $c \in A \cap V^\delta(c)$ , then  $|f(x)| \leq M$ . This shows that  $f$  is bounded on the neighborhood  $V^\delta(c)$  of  $c$ .

$|x - c| < \delta$ , maka  $|f(x) - L| < 1$ ; dari sini (oleh teorema Akibat 2.2.4(a).

$$|f(x)| - |L| \leq |f(x) - L| < 1$$

Oleh karena itu, jika  $x \in A \cap V^\delta(c), x \neq c$ , maka  $|f(x)| \leq |L| + 1$ . Jika  $c$  bukan bagian  $A$ , kita ambil  $M = |L| + 1$ , sedangkan jika  $c \in A$  kita ambil  $M = \text{Sup} \{|f(c)|, |L| + 1\}$ . Ini berarti bahwa jika  $c \in A \cap V^\delta(c)$ , maka  $|f(x)| \leq M$ . Ini menunjukkan bahwa  $f$  terbatas pada  $V^\delta$  suatu lingkungan  $\delta$ .

<p><b>Notasi Matematika dari T. 4.2.2</b>  <math>A \subseteq \mathbb{R}, f: A \rightarrow \mathbb{R}, f</math> mempunyai limit pada <math>c \in \mathbb{R} \Rightarrow f</math> terbatas pada beberapa lingkungan dari <math>c</math>.</p>	<p><b>Kontraposisif dari T. 4.2.2</b>  <math>f</math> tidak terbatas pada semua lingkungan dari <math>c \Rightarrow A \subseteq \mathbb{R}, f: A \rightarrow \mathbb{R}, f</math> tidak mempunyai limit pada <math>c \in \mathbb{R}</math>.</p>
<p><b>Poin Penting dari T. 4.2.2</b></p> <ol style="list-style-type: none"> <li>1. <math>A \subseteq \mathbb{R}</math>.</li> <li>2. <math>f: A \rightarrow \mathbb{R}</math>.</li> <li>3. <math>f</math> mempunyai limit pada <math>c \in \mathbb{R}</math>.</li> <li>4. <math>f</math> terbatas pada beberapa lingkungan dari <math>c</math>.</li> </ol>	<p><b>Poin Penting Kontraposisif dari T. 4.2.2</b></p> <ol style="list-style-type: none"> <li>1. <math>f</math> tidak terbatas pada semua lingkungan dari <math>c</math></li> <li>2. <math>A \subseteq \mathbb{R}</math>.</li> <li>3. <math>f: A \rightarrow \mathbb{R}</math>.</li> <li>4. <math>f</math> tidak mempunyai limit pada <math>c \in \mathbb{R}</math>.</li> </ol>
<p><b>Alternatif Bukti dari T. 4.2.2</b>  <math>A \subseteq \mathbb{R}, f: A \rightarrow \mathbb{R}, f</math> mempunyai limit pada <math>c \in \mathbb{R}, \Rightarrow</math> Bukti <math>f</math> terbatas pada beberapa lingkungan dari <math>c</math>?  <u>Bukti:</u>          Misal: <math>L = \lim_{x \rightarrow c} f(x)</math>          Berdasarkan T. 4.1.6          Dengan <math>\varepsilon = 1</math>, terdapat <math>\delta &gt; 0 \ni 0 &lt;  x - c  &lt; \delta \rightarrow  f(x) - L  &lt; 1</math>          Akibat 2.2.4(a) sehingga  <math> f(x)  -  L  \leq  f(x) - L  &lt; 1</math>          Kemudian, <math>x \in A \cap V^\delta(c), x \neq c, \rightarrow  f(x)  \leq  L  + 1</math>.          Karena <math>c \notin A</math> sehingga <math>M =  L  + 1</math>.          Karena <math>c \in A</math> sehingga <math>M = \text{Sup} \{ f(c) ,  L  + 1\}</math>.          Karena <math>c \in A \cap V^\delta(c)</math> sehingga <math> f(x)  \leq M</math>.</p>	<p><b>Poin Penting Alternatif Bukti dari T. 4.2.2</b></p> <ol style="list-style-type: none"> <li>1. <math>A \subseteq \mathbb{R}</math></li> <li>2. <math>f: A \rightarrow \mathbb{R}</math></li> <li>3. <math>f</math> mempunyai limit pada <math>c \in \mathbb{R}</math></li> <li>4. <math>L = \lim_{x \rightarrow c} f(x)</math></li> <li>5. <math>\varepsilon = 1</math></li> <li>6. <math>\delta &gt; 0 \ni 0 &lt;  x - c  &lt; \delta \rightarrow  f(x) - L  &lt; 1</math></li> <li>7. <math> f(x)  -  L  \leq  f(x) - L  &lt; 1</math></li> <li>8. <math>x \in A \cap V^\delta(c)</math></li> <li>9. <math>x \neq c</math></li> <li>10. <math> f(x)  \leq  L  + 1</math></li> <li>11. <math>c \notin A</math> sehingga <math>M =  L  + 1</math></li> <li>12. <math>c \in A</math> sehingga <math>M = \text{Sup} \{ f(c) ,  L  + 1\}</math></li> </ol>

<p>Jadi, <math>f</math> terbatas pada <math>V^\delta(c)</math>. ■</p>	<p>13. <math>c \in A \cap V^\delta(c)</math> sehingga <math> f(x)  \leq M</math>                  14. <math>f</math> terbatas pada <math>V^\delta(c)</math></p>
---	---

**Ilustrasi dari T. 4.2.2**

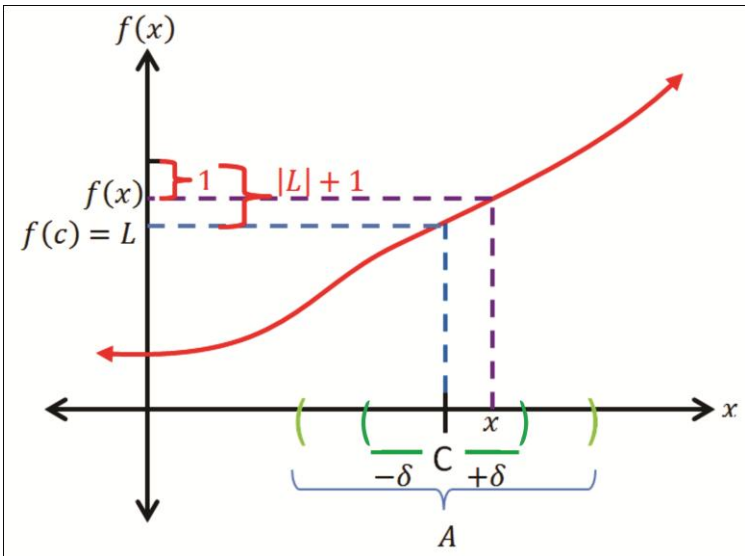

**4.2.3 Definition** Let  $A \subseteq \mathbb{R}$  and let  $f$  and  $g$  be functions defined on  $A$  to  $\mathbb{R}$ . We define the **sum**  $f + g$ , the **difference**  $f - g$ , and the **product**  $fg$  on  $A$  to  $\mathbb{R}$  to be the functions given by

$$(f + g)(x) := f(x) + g(x), \quad (f - g)(x) := f(x) - g(x),$$

$$(fg)(x) := f(x)g(x)$$

For all  $x \in A$ . Further, if  $b \in \mathbb{R}$ , we define **multiple**  $bf$  to be function given by

$$(bf)(x) := bf(x) \text{ for all } x \in A.$$

Finally, if  $h(x) \neq 0$  for  $x \in A$ , we define the **quotient**  $f/h$  to be

**4.2.3 Definisi** Misalkan  $A \subseteq \mathbb{R}$  dan misalkan  $f$  dan  $g$  fungsi yang didefinisikan pada  $A$  ke  $\mathbb{R}$ . Kita mendefinisikan **jumlah**  $f + g$ , **selisih**  $f - g$ , dan **hasilkali**  $fg$  pada  $A$  ke  $\mathbb{R}$  sebagai fungsi yang diberikan oleh

$$(f + g)(x) := f(x) + g(x), \quad (f - g)(x) := f(x) - g(x),$$

$$(fg)(x) := f(x)g(x)$$

untuk semua  $x \in A$ . Selanjutnya, jika  $b \in \mathbb{R}$ , kita definisikan **kelipatan**  $bf$  sebagai fungsi yang diberikan oleh

$$(bf)(x) := bf(x) \text{ untuk semua } x \in A.$$



the function given by

$$\left(\frac{f}{h}\right)(x) := \frac{f(x)}{h(x)} \text{ for all } x \in A.$$

Akhirnya, jika  $h(x) \neq 0$  untuk  $x \in A$ , Kita definisikan **hasilbagi**  $f/h$  adalah fungsi yang diberikan oleh

$$\left(\frac{f}{h}\right)(x) := \frac{f(x)}{h(x)} \text{ untuk semua } x \in A.$$

<p><b>Notasi Matematika dari D. 4.2.3</b>  <math>A \subseteq \mathbb{R}</math>, <math>f</math> dan <math>g</math> fungsi <math>A</math> ke <math>\mathbb{R}</math>. Lalu <math>f + g</math> jumlah, <math>f - g</math> selisih, <math>fg</math> hasilkali pada <math>A</math> ke <math>\mathbb{R} \ni (f + g)(x) := f(x) + g(x)</math>, <math>(f - g)(x) := f(x) - g(x)</math>, <math>(fg)(x) := f(x)g(x)</math>, <math>\forall x \in A</math>.  <math>b \in \mathbb{R}</math>, <math>bf</math> kelipatan <math>\ni (bf)(x) := bf(x)</math>, <math>\forall x \in A</math>.  <math>h(x) \neq 0</math>, <math>\forall x \in A</math>, <math>f/h</math> hasilbagi <math>\ni \left(\frac{f}{h}\right)(x) := \frac{f(x)}{h(x)}</math>, <math>\forall x \in A</math>.</p>	<p><b>Poin Penting dari D. 4.2.3</b></p> <ol style="list-style-type: none"> <li>1. <math>A \subseteq \mathbb{R}</math></li> <li>2. <math>f</math> dan <math>g</math> fungsi <math>A</math> ke <math>\mathbb{R}</math></li> <li>3. <math>f + g</math> jumlah <math>\ni (f + g)(x) := f(x) + g(x)</math></li> <li>4. <math>f - g</math> selisih <math>\ni (f - g)(x) := f(x) - g(x)</math></li> <li>5. <math>fg</math> hasilkali <math>\ni (fg)(x) := f(x)g(x)</math></li> <li>6. <math>\forall x \in A</math></li> <li>7. <math>b \in \mathbb{R}</math></li> <li>8. <math>bf</math> kelipatan <math>\ni (bf)(x) := bf(x)</math>, <math>\forall x \in A</math></li> <li>9. <math>h(x) \neq 0</math></li> <li>10. <math>\forall x \in A</math></li> <li>11. <math>f/h</math> hasilbagi <math>\ni \left(\frac{f}{h}\right)(x) = \frac{f(x)}{h(x)}</math></li> </ol>
---	---

**4.2.4 Theorem** Let  $A \subseteq \mathbb{R}$ , let  $f$  and  $g$  be functions on  $A$  to  $\mathbb{R}$ , and let  $c \in \mathbb{R}$  be a cluster point of  $A$ . Further, let  $b \in \mathbb{R}$ .

(a) If  $\lim_{x \rightarrow c} f = L$  and  $\lim_{x \rightarrow c} g = M$ , then:

$$\begin{aligned} \lim_{x \rightarrow c} (f + g) &= L + M, & \lim_{x \rightarrow c} (f - g) &= L - M, \\ \lim_{x \rightarrow c} (fg) &= LM, & \lim_{x \rightarrow c} (bf) &= bL. \end{aligned}$$

**Proof.** One proof of this theorem is exactly similar to that of Theorem 3.2.3. Alternatively, it can be proved by making use of Theorems 3.2.3 and 4.1.8. For example, let  $(x_n)$  be any sequence in  $A$  such that  $(x_n) \neq c$  for  $n \in \mathbb{N}$ , and  $c = \lim(x_n)$ . It follows

**Teorema 4.2.4** Misalkan  $A \subseteq \mathbb{R}$ , misal  $f$  dan  $g$  adalah fungsi dari  $A$  ke  $\mathbb{R}$ , dan misalkan  $c \in \mathbb{R}$  adalah titik kumpul dari  $A$ . Selanjutnya, misalkan  $b \in \mathbb{R}$ .

(a) Jika  $\lim_{x \rightarrow c} f = L$  dan  $\lim_{x \rightarrow c} g = M$ , maka:

$$\begin{aligned} \lim_{x \rightarrow c} (f + g) &= L + M, & \lim_{x \rightarrow c} (f - g) &= L - M, \\ \lim_{x \rightarrow c} (fg) &= LM, & \lim_{x \rightarrow c} (bf) &= bL. \end{aligned}$$

**Bukti.** Satu bukti teorema ini persis sama dengan Teorema 3.2.3. Atau dapat di buktikan dengan menggunakan Teorema 3.2.3 dan 4.1.8. Sebagai contoh, misalkan  $(x_n)$  adalah barisan di  $A$

## 4.2 Limits Theorem

from Theorem 4.1.8 that

$$\lim(f(x_n)) = L, \quad \lim(g(x_n)) = M.$$

On the other hand, Definition 4.2.3 implies that

$$(fg)(x_n) = f(x_n)g(x_n) \quad \text{for } n \in \mathbb{N}.$$

Therefore an application of Theorem 3.2.3 yields

$$\begin{aligned} \lim((fg)(x_n)) &= \lim(f(x_n)g(x_n)) \\ &= [\lim(f(x_n))][\lim(g(x_n))] = LM. \end{aligned}$$

Consequently, it follows from Theorem 4.1.8 that

$$\lim_{x \rightarrow c}(fg) = \lim((fg)(x_n)) = LM.$$

The other parts of this theorem are proved in a similar manner.

We leave the details to the reader.

*Q.E.D*

## 4.2 Teorema Limit

sedemikian sehingga  $(x_n) \neq c$  untuk  $n \in \mathbb{N}$ , dan  $c = \lim(x_n)$ .

Sehingga Berdasarkan Teorema 4.1.8 diperoleh

$$\lim(f(x_n)) = L, \quad \lim(g(x_n)) = M.$$

Berdasarkan Definisi 4.2.3 sehingga

$$(fg)(x_n) = f(x_n)g(x_n) \quad \text{for } n \in \mathbb{N}.$$

Berdasarkan Teorema 3.2.3 didapat

$$\begin{aligned} \lim((fg)(x_n)) &= \lim(f(x_n)g(x_n)) \\ &= [\lim(f(x_n))][\lim(g(x_n))] = LM. \end{aligned}$$

Kemudian Berdasarkan Teorema 4.1.8 diperoleh

$$\lim_{x \rightarrow c}(fg) = \lim((fg)(x_n)) = LM.$$

Bagian lain dari Teorema ini dapat dibuktikan dengan cara yang sama. Kita memberikan secara detailnya kepada pembaca.

*Q.E.D*

<p><b>Notasi Matematika dari T. 4.1.2 (a)</b>  <math>A \subseteq \mathbb{R}</math>, <math>f</math> dan <math>g</math> fungsi, <math>f: A \rightarrow \mathbb{R}</math>, <math>g: A \rightarrow \mathbb{R}</math>, <math>c \in \mathbb{R}</math>, <math>c</math> titik kumpul dari <math>A</math>. Lalu <math>b \in \mathbb{R}</math> sehingga                      (a) <math>\lim_{x \rightarrow c} f = L</math>, <math>\lim_{x \rightarrow c} g = M</math>, <math>\Rightarrow \lim_{x \rightarrow c} (f + g) = L + M</math>, <math>\lim_{x \rightarrow c} (f - g) = L - M</math>, <math>\lim_{x \rightarrow c} (fg) = LM</math>, <math>\lim_{x \rightarrow c} (bf) = bL</math>.</p>	<p><b>Kontrapositif Matematika dari T. 4.1.2 (a)</b>  <math>A \subseteq \mathbb{R}</math>, <math>f</math> dan <math>g</math> fungsi, <math>f: A \rightarrow \mathbb{R}</math>, <math>g: A \rightarrow \mathbb{R}</math>, <math>c \in \mathbb{R}</math>, <math>c</math> bukan titik kumpul dari <math>A</math>. Lalu <math>b \in \mathbb{R}</math> sehingga                      (a) <math>\lim_{x \rightarrow c} f \neq L</math>, <math>\lim_{x \rightarrow c} g \neq M</math>, <math>\Rightarrow \lim_{x \rightarrow c} (f + g) \neq L + M</math>, <math>\lim_{x \rightarrow c} (f - g) \neq L - M</math>, <math>\lim_{x \rightarrow c} (fg) \neq LM</math>, <math>\lim_{x \rightarrow c} (bf) \neq bL</math>.</p>
<p><b>Poin Penting dari T. 4.2.4 (a)</b></p> <ol style="list-style-type: none"> <li>1. <math>A \subseteq \mathbb{R}</math></li> <li>2. <math>f</math> dan <math>g</math> fungsi</li> <li>3. <math>f: A \rightarrow \mathbb{R}</math>, <math>g: A \rightarrow \mathbb{R}</math></li> <li>4. <math>c \in \mathbb{R}</math>, <math>c</math> titik kumpul dari <math>A</math></li> <li>5. <math>b \in \mathbb{R}</math></li> <li>6. <math>\lim_{x \rightarrow c} f = L</math></li> <li>7. <math>\lim_{x \rightarrow c} g = M</math></li> </ol>	<p><b>Poin Penting Kontrapositif dari T. 4.2.4 (a)</b></p> <ol style="list-style-type: none"> <li>1. <math>A \subseteq \mathbb{R}</math></li> <li>2. <math>f</math> dan <math>g</math> fungsi</li> <li>3. <math>f: A \rightarrow \mathbb{R}</math>, <math>g: A \rightarrow \mathbb{R}</math></li> <li>4. <math>c \in \mathbb{R}</math>, <math>c</math> bukan titik kumpul dari <math>A</math></li> <li>5. <math>b \in \mathbb{R}</math></li> <li>6. <math>\lim_{x \rightarrow c} f \neq L</math></li> <li>7. <math>\lim_{x \rightarrow c} g \neq M</math></li> </ol>

8. $\lim_{x \rightarrow c} (f + g) = L + M$ 9. $\lim_{x \rightarrow c} (f - g) = L - M$ 10. $\lim_{x \rightarrow c} (fg) = LM$ 11. $\lim_{x \rightarrow c} (bf) = bL$	8. $\lim_{x \rightarrow c} (f + g) \neq L + M$ 9. $\lim_{x \rightarrow c} (f - g) \neq L - M$ 10. $\lim_{x \rightarrow c} (fg) \neq LM$ 11. $\lim_{x \rightarrow c} (bf) \neq bL$
<p><b>Alternatif Bukti dari T. 4.2.4 (a)</b></p> <p>1) <math>\lim_{x \rightarrow c} (f + g) = L + M \Rightarrow</math> Bukti ?</p> <p><b>Bukti:</b>          Misalkan <math>(x_n)</math> adalah barisan di <math>A \ni x_n \neq c, \forall n \in \mathbb{N}, \lim(x_n) = c</math>. Karena <math>\lim_{x \rightarrow c} f = L, \lim_{x \rightarrow c} g = M</math> sehingga berdasarkan T. 4.1.8 di peroleh  <math display="block">\lim(f(x_n)) = L \text{ dan } \lim(g(x_n)) = M</math>         Berdasarkan D. 4.2.3 sehingga  <math display="block">(f + g)(x_n) = f(x_n) + g(x_n), \quad \forall n \in \mathbb{N}</math>         Berdasarkan T. 3.2.3 didapat  <math display="block">\begin{aligned} \lim((f + g)(x_n)) &amp;= \lim(f(x_n) + g(x_n)) \\ &amp;= [\lim(f(x_n))] \\ &amp;\quad + [\lim(g(x_n))] \\ &amp;= L + M \end{aligned}</math>         Kemudian berdasarkan T. 4.1.8 diperoleh  <math display="block">\lim_{x \rightarrow c} (f + g) = \lim((f + g)(x_n)) = L + M</math>         Jadi, <math>\lim_{x \rightarrow c} (f + g) = L + M</math> terbukti.</p> <p>2) <math>\lim_{x \rightarrow c} (f - g) = L - M \Rightarrow</math> Bukti ?</p> <p><b>Bukti:</b>          Misalkan <math>(x_n)</math> adalah barisan di <math>A \ni x_n \neq c, \forall n \in \mathbb{N}, \lim(x_n) = c</math>. Karena <math>\lim_{x \rightarrow c} f = L, \lim_{x \rightarrow c} g = M</math> sehingga berdasarkan T. 4.1.8 di peroleh  <math display="block">\lim(f(x_n)) = L \text{ dan } \lim(g(x_n)) = M</math>         Berdasarkan D. 4.2.3 sehingga</p>	<p><b>Poin Penting Alternatif Bukti dari T. 4.2.4 (a)</b></p> <ol style="list-style-type: none"> <li><math>\lim_{x \rightarrow c} (f + g) = L + M</math></li> <li><math>(x_n)</math> adalah barisan di <math>A</math></li> <li><math>x_n \neq c, \forall n \in \mathbb{N}</math></li> <li><math>\lim(x_n) = c</math></li> <li><math>\lim_{x \rightarrow c} f = L</math></li> <li><math>\lim_{x \rightarrow c} g = M</math></li> <li><math>\lim(f(x_n)) = L</math> dan <math>\lim(g(x_n)) = M</math></li> <li><math>(f + g)(x_n) = f(x_n) + g(x_n), \forall n \in \mathbb{N}</math></li> <li><math>\lim((f + g)(x_n)) = \lim(f(x_n) + g(x_n))</math></li> <li><math>[\lim(f(x_n))] + [\lim(g(x_n))] = L + M</math></li> <li><math>\lim_{x \rightarrow c} (f + g) = \lim((f + g)(x_n)) = L + M</math></li> <li><math>\lim_{x \rightarrow c} (f - g) = L - M</math></li> <li><math>(f - g)(x_n) = f(x_n) - g(x_n), \forall n \in \mathbb{N}</math></li> <li><math>\lim((f - g)(x_n)) = \lim(f(x_n) - g(x_n))</math></li> <li><math>[\lim(f(x_n))] - [\lim(g(x_n))] = L - M</math></li> <li><math>\lim_{x \rightarrow c} (f - g) = \lim((f - g)(x_n)) = L - M</math></li> <li><math>\lim_{x \rightarrow c} (fg) = LM</math></li> <li><math>(fg)(x_n) = f(x_n)g(x_n), \forall n \in \mathbb{N}</math></li> <li><math>\lim((fg)(x_n)) = \lim(f(x_n)g(x_n))</math></li> <li><math>[\lim(f(x_n))][\lim(g(x_n))] = LM</math></li> <li><math>\lim_{x \rightarrow c} (fg) = \lim((fg)(x_n)) = LM</math></li> <li><math>\lim_{x \rightarrow c} (bf) = bL</math></li> </ol>

$$(f - g)(x_n) = f(x_n) - g(x_n), \quad \forall n \in \mathbb{N}$$

Berdasarkan T. 3.2.3 didapat

$$\begin{aligned} \lim((f - g)(x_n)) &= \lim(f(x_n) - g(x_n)) \\ &= [\lim(f(x_n))] \\ &\quad - [\lim(g(x_n))] \\ &= L - M \end{aligned}$$

Kemudian berdasarkan T. 4.1.8 diperoleh

$$\lim_{x \rightarrow c} (f - g) = \lim((f - g)(x_n)) = L - M$$

Jadi,  $\lim_{x \rightarrow c} (f - g) = L - M$  terbukti.

3)  $\lim_{x \rightarrow c} (fg) = LM \Rightarrow$  Bukti ?

**Bukti:**

Misalkan  $(x_n)$  adalah barisan di  $A \ni x_n \neq c, \forall n \in \mathbb{N}, \lim(x_n) = c$ . Karena  $\lim_{x \rightarrow c} f = L, \lim_{x \rightarrow c} g = M$  sehingga berdasarkan T. 4.1.8 di peroleh

$$\lim(f(x_n)) = L \text{ dan } \lim(g(x_n)) = M$$

Berdasarkan D. 4.2.3 sehingga

$$(fg)(x_n) = f(x_n)g(x_n), \quad \forall n \in \mathbb{N}$$

Berdasarkan T. 3.2.3 didapat

$$\begin{aligned} \lim((fg)(x_n)) &= \lim(f(x_n)g(x_n)) \\ &= LM \end{aligned}$$

Kemudian berdasarkan T. 4.1.8 diperoleh

$$\lim_{x \rightarrow c} (fg) = \lim((fg)(x_n)) = LM$$

Jadi,  $\lim_{x \rightarrow c} (fg) = LM$  terbukti.

4)  $\lim_{x \rightarrow c} (bf) = bL \Rightarrow$  Bukti ?

**Bukti:**

Misalkan  $(x_n)$  adalah barisan di  $A \ni x_n \neq c, \forall n \in \mathbb{N}, \lim(x_n) = c$ . Karena  $\lim_{x \rightarrow c} f = L, \lim_{x \rightarrow c} g = M$

$$23. \lim(g(x_n)) = b \text{ dan } \lim(f(x_n)) = L$$

$$24. (bf)(x_n) = bf(x_n), \quad \forall n \in \mathbb{N}$$

$$25. \lim((bf)(x_n)) = b \lim(f(x_n)) = bL$$

$$26. \lim_{x \rightarrow c} (bf) = \lim((bf)(x_n)) = bL$$

<p>sehingga berdasarkan T. 4.1.8 di peroleh</p> $\lim(g(x_n)) = b \text{ dan } \lim(f(x_n)) = L$ <p>Berdasarkan D. 4.2.3 sehingga</p> $(bf)(x_n) = bf(x_n), \quad \forall n \in \mathbb{N}$ <p>Berdasarkan T. 3.2.3 didapat</p> $\begin{aligned} \lim((bf)(x_n)) &= b \lim(f(x_n)) \\ &= bL \end{aligned}$ <p>Kemudian berdasarkan T. 4.1.8 diperoleh</p> $\lim_{x \rightarrow c} (bf) = \lim((bf)(x_n)) = bL$ <p>Jadi, <math>\lim_{x \rightarrow c} (bf) = bL</math> terbukti.</p>	
<p><b>T. 3.2.3</b></p> <p><math>X = (x_n)</math> dan <math>Y = (y_n)</math> merupakan barisan-barisan bilangan real yang masing-masing konvergen ke <math>x</math> dan <math>y, c \in \mathbb{R}</math>.</p> <p>Maka akan diperoleh barisan-barisan:</p> <ul style="list-style-type: none"> <li>(a) <math>X + Y</math> konvergen ke <math>x + y</math></li> <li>(b) <math>X - Y</math> konvergen ke <math>x - y</math></li> <li>(c) <math>XY</math> konvergen ke <math>xy</math></li> <li>(d) <math>cX</math> konvergen ke <math>cx</math></li> </ul>	

4.2.4 Theorem

(b) If  $h: A \rightarrow \mathbb{R}$ , if  $h(x) \neq 0$  for all  $x \in A$ , and if  $\lim_{x \rightarrow c} h = H \neq 0$  then  $\lim_{x \rightarrow c} \left(\frac{f}{h}\right) = \frac{L}{H}$ .

Remark

Let  $A \subseteq \mathbb{R}$ , and let  $f_1, f_2, \dots, f_n$  be function on  $A$  to  $\mathbb{R}$  and let  $c$  be a cluster point of  $A$ . If  $L_k := \lim_{x \rightarrow c} f_k$  for  $K = 1, \dots, n$ . then it follows from Theorem 4.2.4 by a induction argument that.

$$L_1 + L_2 + \dots + L_n = \lim_{x \rightarrow c} (f_1 + f_2 + \dots + f_n).$$

and

$$L_1 \cdot L_2 \cdot \dots \cdot L_n = \lim_{x \rightarrow c} (f_1 \cdot f_2 \cdot \dots \cdot f_n).$$

In particular. We deduce that if  $L = \lim_{x \rightarrow c} f$  and  $n \in \mathbb{N}$ , then

$$L^n = \lim_{x \rightarrow c} (f(x))^n$$

Teorema 4.2.4

(b) Jika  $h: A \rightarrow \mathbb{R}$ , jika  $h(x) \neq 0$  untuk semua  $x \in A$ , dan jika  $\lim_{x \rightarrow c} h = H \neq 0$ , maka  $\lim_{x \rightarrow c} \left(\frac{f}{h}\right) = \frac{L}{H}$ .

Catatan:

Misalkan  $A \subseteq \mathbb{R}$ , dan diberikan  $f_1, f_2, \dots, f_n$  suatu fungsi pada  $A$  to  $\mathbb{R}$  dan diberikan  $c$  titik kumpul dari  $A$ . Jika  $L_k := \lim_{x \rightarrow c} f_k$  for  $K = 1, \dots, n$ . maka menurut Teorema 4.2.4 dengan argumen induksi kita peroleh bahwa

$$L_1 + L_2 + \dots + L_n = \lim_{x \rightarrow c} (f_1 + f_2 + \dots + f_n).$$

dan

$$L_1 \cdot L_2 \cdot \dots \cdot L_n = \lim_{x \rightarrow c} (f_1 \cdot f_2 \cdot \dots \cdot f_n).$$

Secara khususnya. Kita simpulkan bahwa jika  $L = \lim_{x \rightarrow c} f$  dan  $n \in \mathbb{N}$ , maka

$$L^n = \lim_{x \rightarrow c} (f(x))^n$$

<p><b>Notasi Matematika dari T. 4.2.4 (b)</b>  <math>h: A \rightarrow \mathbb{R}, h(x) \neq 0 \forall x \in A, \lim_{x \rightarrow c} h = H \neq 0 \Rightarrow \lim_{x \rightarrow c} \left(\frac{f}{h}\right) = \frac{L}{H}</math>.</p>	<p><b>Kontrapositif dari T. 4.2.4 (b)</b>  <math>\lim_{x \rightarrow c} \left(\frac{f}{h}\right) \neq \frac{L}{H} \Rightarrow h: A \rightarrow \mathbb{R}, h(x) = 0 \exists x \in A, \lim_{x \rightarrow c} h = H = 0</math>.</p>
<p><b>Poin Penting dari T. 4.2.4 (b)</b></p> <ol style="list-style-type: none"> <li>1) <math>h: A \rightarrow \mathbb{R}</math></li> <li>2) <math>h(x) \neq 0, x \in A</math></li> <li>3) <math>\lim_{x \rightarrow c} h = H \neq 0</math></li> <li>4) <math>\lim_{x \rightarrow c} \left(\frac{f}{h}\right) = \frac{L}{H}</math></li> </ol>	<p><b>Poin Penting Kontrapositif dari T. 4.2.4 (b)</b></p> <ol style="list-style-type: none"> <li>1) <math>\lim_{x \rightarrow c} \left(\frac{f}{h}\right) \neq \frac{L}{H}</math></li> <li>2) <math>h: A \rightarrow \mathbb{R}</math></li> <li>3) <math>h(x) = 0 \exists x \in A</math></li> <li>4) <math>\lim_{x \rightarrow c} h = H = 0</math></li> </ol>
<p><b>Alternatif Bukti dari T. 4.2.4 (b)</b>  <math>\lim_{x \rightarrow c} \left(\frac{f}{h}\right) = \frac{L}{H} \Rightarrow</math> Bukti?  <u>Bukti:</u>                  Misalkan <math>(x_n)</math> sebarang barisan di <math>A \ni x_n \neq c, \forall n \in \mathbb{N}, \lim(x_n) = c</math>.</p>	<p><b>Point Penting Alternatif Bukti dari T. 4.2.4 (b)</b></p> <ol style="list-style-type: none"> <li>1) <math>A \ni x_n \neq c</math></li> <li>2) <math>\forall n \in \mathbb{N}</math></li> <li>3) <math>\lim(x_n) = c</math></li> <li>4) <math>\lim_{x \rightarrow c} f = L</math></li> <li>5) <math>\lim_{x \rightarrow c} h = H</math></li> </ol>

<p>Karena <math>\lim_{x \rightarrow c} f = L</math> dan <math>\lim_{x \rightarrow c} h = H</math> sehingga berdasarkan T. 4.1.8 diperoleh <math>\lim_{x \rightarrow c} (f(x_n)) = L</math> dan <math>\lim_{x \rightarrow c} (h(x_n)) = H, H \neq 0</math>.</p> <p>Berdasarkan D. 4.2.3 diperoleh <math>\left(\frac{f}{h}\right)(x) = \frac{f(x)}{h(x)}, \forall x \in A</math>.</p> <p>Kemudian dari T. 3.2.3 diperoleh <math>\lim_{x \rightarrow c} \left(\left(\frac{f}{h}\right)(x_n)\right) = \left(\frac{\lim_{x \rightarrow c} f(x)}{\lim_{x \rightarrow c} h(x)}\right) = \frac{L}{H}, H \neq 0</math>.</p> <p>Berdasarkan T. 4.1.8 diperoleh <math>\lim_{x \rightarrow c} \left(\frac{f}{h}\right) = \lim_{x \rightarrow c} \left(\left(\frac{f}{h}\right)(x_n)\right) = \left(\frac{\lim_{x \rightarrow c} f(x)}{\lim_{x \rightarrow c} h(x)}\right) = \frac{L}{H}, H \neq 0</math>.</p> <p>Jadi, <math>\lim_{x \rightarrow c} \left(\frac{f}{h}\right) = \frac{L}{H}</math>. Terbukti</p>	<p>6) <math>\lim(f(x_n)) = L</math></p> <p>7) <math>\lim(h(x_n)) = H, H \neq 0</math></p> <p>8) <math>\left(\frac{f}{h}\right)(x) = \frac{f(x)}{h(x)}</math></p> <p>9) <math>\forall x \in A</math></p> <p>10) <math>\lim_{x \rightarrow c} \left(\frac{f}{h}\right) = \lim_{x \rightarrow c} \left(\left(\frac{f}{h}\right)(x_n)\right) = \left(\frac{\lim_{x \rightarrow c} f(x)}{\lim_{x \rightarrow c} h(x)}\right) = \frac{L}{H}, H \neq 0</math></p>
---	--

**4.2.5 Examples (a)** Some of the limits were established in Section 4.1 can be proved by using Theorem 4.2.4. for example, it follows from this result that since  $\lim_{x \rightarrow c} x = c$ , then  $\lim_{x \rightarrow c} x^2 = c^2$ , and that if  $c > 0$ , then

$$\lim_{x \rightarrow c} \frac{1}{x} = \frac{1}{\lim_{x \rightarrow c} x} = \frac{1}{c}.$$

(b)  $\lim_{x \rightarrow 2} (x^2 + 1)(x^3 - 4) = 20$ .

It follows from Theorem 4.2.4 that

$$\begin{aligned} \lim_{x \rightarrow 2} (x^2 + 1)(x^3 - 4) &= \left(\lim_{x \rightarrow 2} (x^2 + 1)\right) \left(\lim_{x \rightarrow 2} (x^3 - 4)\right) \\ &= 5 \cdot 4 = 20. \end{aligned}$$

(c)  $\lim_{x \rightarrow 2} \left(\frac{x^3 - 4}{x^2 + 1}\right) = \frac{4}{5}$ .

If we apply Theorem 4.2.4(b) we have

$$\lim_{x \rightarrow 2} \frac{x^3 - 4}{x^2 + 1} = \frac{\lim_{x \rightarrow 2} (x^3 - 4)}{\lim_{x \rightarrow 2} (x^2 + 1)} = \frac{4}{5}.$$

**Contoh 4.1.3 (a)** beberapa limit yang ditetapkan 4.1 dapat dibuktikan dengan Theorema 4.2.4. sebagai contoh berdasarkan dari hasil ini bahwa  $\lim_{x \rightarrow c} x = c$ , maka  $\lim_{x \rightarrow c} x^2 = c^2$ , dan jika  $c > 0$ , maka

$$\lim_{x \rightarrow c} \frac{1}{x} = \frac{1}{\lim_{x \rightarrow c} x} = \frac{1}{c}.$$

(b)  $\lim_{x \rightarrow 2} (x^2 + 1)(x^3 - 4) = 20$

Berdasarkan Theorema 4.2.4 bahwa

$$\begin{aligned} \lim_{x \rightarrow 2} (x^2 + 1)(x^3 - 4) &= \left(\lim_{x \rightarrow 2} (x^2 + 1)\right) \left(\lim_{x \rightarrow 2} (x^3 - 4)\right) \\ &= 5 \cdot 4 = 20. \end{aligned}$$

(c)  $\lim_{x \rightarrow 2} \left(\frac{x^3 - 4}{x^2 + 1}\right) = \frac{4}{5}$ .

Jika kita mengaplikasikan Theorema 4.2.4(b) kita mendapatkan

## 4.2 Limits Theorem

## 4.2 Teorema Limit

Note that since the limit in the denominator [i.e.,  $\lim_{x \rightarrow 2}(x^2 + 1) = 5$ ] is not equal to 0, than Theorem 4.2.4(b) is applicable.

$$\lim_{x \rightarrow 2} \frac{x^3 - 4}{x^2 + 1} = \frac{\lim_{x \rightarrow 2}(x^3 - 4)}{\lim_{x \rightarrow 2}(x^2 + 1)} = \frac{4}{5}$$

Catatan bahwa karena limit penyebut [yaitu  $\lim_{x \rightarrow 2}(x^2 + 1) = 5$ ] tidak samadengan 0, maka Theorema 4.2.4(b) dapat diaplikasikan.

<p><b>Alternatif Jawaban dari C. 4.2.5 (a)</b>  <math>\lim_{x \rightarrow c} x = c \rightarrow \text{bukti C. 4.1.7(b)}</math>  <math>\lim_{x \rightarrow c} x^2 = c^2 \rightarrow \text{bukti C. 4.1.7(c)}</math> } jika <math>c &gt; 0</math>, maka  <math display="block">\lim_{x \rightarrow c} \frac{1}{x} = \frac{1}{\lim_{x \rightarrow c} x} = \frac{1}{c}</math></p>	<p><b>Poin Penting dari C. 4.2.5 (a)</b></p> <ol style="list-style-type: none"> <li><math>\lim_{x \rightarrow c} x = c</math></li> <li><math>\lim_{x \rightarrow c} x^2 = c^2</math></li> <li><math>c &gt; 0</math></li> <li><math>\lim_{x \rightarrow c} \frac{1}{x} = \frac{1}{\lim_{x \rightarrow c} x} = \frac{1}{c}</math></li> </ol>
<p><b>Alternatif Jawaban dari C. 4.2.5 (b)</b>  <math>\lim_{x \rightarrow 2}(x^2 + 1)(x^3 - 4) = 20 \Rightarrow \text{Bukti?}</math>  <b>Bukti:</b>            Berdasarkan T.4.2.4 sehingga  <math display="block">\begin{aligned} \lim_{x \rightarrow 2}(x^2 + 1)(x^3 - 4) &amp;= \left(\lim_{x \rightarrow 2}(x^2 + 1)\right) \left(\lim_{x \rightarrow 2}(x^3 - 4)\right) \\ &amp;= (2^2 + 1)(2^3 - 4) \\ &amp;= (4 + 1)(8 - 4) \\ &amp;= 5 \cdot 4 \\ &amp;= 20. \end{aligned}</math>            Jadi, <math>\lim_{x \rightarrow 2}(x^2 + 1)(x^3 - 4) = 20</math> terbukti.</p>	<p><b>Poin Penting dari C. 4.2.5 (b)</b></p> <ol style="list-style-type: none"> <li><math>\lim_{x \rightarrow 2}(x^2 + 1)(x^3 - 4)</math></li> <li><math>x = 2</math></li> <li><math>\lim_{x \rightarrow 2}(x^2 + 1)(x^3 - 4) = 20</math></li> </ol>
<p><b>Alternatif Jawaban dari C. 4.2.5 (c)</b>  <math>\lim_{x \rightarrow 2} \left(\frac{x^3 - 4}{x^2 + 1}\right) = \frac{4}{5} \Rightarrow \text{Bukti?}</math>  <b>Bukti:</b>  <math display="block">\lim_{x \rightarrow 2} \frac{x^3 - 4}{x^2 + 1} = \frac{\lim_{x \rightarrow 2}(x^3 - 4)}{\lim_{x \rightarrow 2}(x^2 + 1)}</math></p>	<p><b>Poin Penting dari C. 4.1.3 (c)</b></p> <ol style="list-style-type: none"> <li><math>\lim_{x \rightarrow 2} \left(\frac{x^3 - 4}{x^2 + 1}\right)</math></li> <li><math>x = 2</math></li> <li><math>\lim_{x \rightarrow 2} \left(\frac{x^3 - 4}{x^2 + 1}\right) = \frac{4}{5}</math></li> </ol>



$$\begin{aligned} &= \frac{2^3 - 4}{2^2 + 1} \\ &= \frac{8 - 4}{4 + 1} \\ &= \frac{4}{5}. \end{aligned}$$

Jadi,  $\lim_{x \rightarrow 2} \left( \frac{x^3 - 4}{x^2 + 1} \right) = \frac{4}{5}$  terbukti.

$$(d) \lim_{x \rightarrow 2} \frac{x^2 - 4}{3x - 6} = \frac{4}{3}.$$

If we let  $f(x) := x^2 - 4$  and  $h(x) := 3x - 6$  for  $x \in \mathbb{R}$ , then we *cannot* use Theorem 4.2.4(b) to evaluate  $\lim_{x \rightarrow 2} (f(x)/h(x))$  because

$$H = \lim_{x \rightarrow 2} h(x) = \lim_{x \rightarrow 2} (3x - 6) = 3 \cdot 2 - 6 = 0.$$

However, if  $x \neq 2$ , then it follows that

$$\frac{x^2 - 4}{3x - 6} = \frac{(x + 2)(x - 2)}{3(x - 2)} = \frac{1}{3}(x + 2).$$

Therefore we have

$$\lim_{x \rightarrow 2} \frac{x^2 - 4}{3x - 6} = \lim_{x \rightarrow 2} \frac{1}{3}(x + 2) = \frac{1}{3}(\lim_{x \rightarrow 2} x + 2) = \frac{4}{3}.$$

Note that the function  $g(x) = (x^2 - 4)/(3x - 6)$  has a limit at  $x = 2$  even though it is not defined there.

$$(e) \lim_{x \rightarrow 0} \frac{1}{x} \text{ does not exist in } \mathbb{R}.$$

Of course  $\lim_{x \rightarrow 0} 1 = 1$  and  $H := \lim_{x \rightarrow 0} x = 0$ . However, since  $H = 0$ , we *cannot* use Theorem 4.2.4(b) to evaluate  $\lim_{x \rightarrow 0} (1/x)$ . In fact, as was seen in Example 4.1.10(a), the function  $\varphi(x) = 1/x$  does not have a limit at  $x = 0$ . This conclusion also follows from Theorem 4.2.2 since the function  $\varphi(x) = 1/x$  is not bounded on neighborhood of  $x = 0$ .

$$(d) \lim_{x \rightarrow 2} \frac{x^2 - 4}{3x - 6} = \frac{4}{3}.$$

Jika kita misalkan  $f(x) := x^2 - 4$  dan  $h(x) := 3x - 6$  untuk  $x \in \mathbb{R}$ , maka kita *tidak dapat* menggunakan Teorema 4.2.4(b) untuk mengevaluasi  $\lim_{x \rightarrow 2} (f(x)/h(x))$  karena

$$H = \lim_{x \rightarrow 2} h(x) = \lim_{x \rightarrow 2} (3x - 6) = 3 \cdot 2 - 6 = 0.$$

Akan tetapi, jika  $x \neq 2$ , maka itu mengikuti bahwa

$$\frac{x^2 - 4}{3x - 6} = \frac{(x + 2)(x - 2)}{3(x - 2)} = \frac{1}{3}(x + 2).$$

Oleh karena itu kita mempunyai

$$\lim_{x \rightarrow 2} \frac{x^2 - 4}{3x - 6} = \lim_{x \rightarrow 2} \frac{1}{3}(x + 2) = \frac{1}{3}(\lim_{x \rightarrow 2} x + 2) = \frac{4}{3}.$$

Catatan bahwa fungsi  $g(x) = (x^2 - 4)/(3x - 6)$  mempunyai limit pada  $x = 2$  bahkan melalui itu *tidak didefinisikan disana*.

$$(e) \lim_{x \rightarrow 0} \frac{1}{x} \text{ tidak ada dalam } \mathbb{R}.$$

Tentu saja  $\lim_{x \rightarrow 0} 1 = 1$  dan  $H := \lim_{x \rightarrow 0} x = 0$ . Akan tetapi, karena  $H = 0$ , kita *tidak dapat* menggunakan 4.2.4(b) untuk mengevaluasi  $\lim_{x \rightarrow 0} (1/x)$ . Faktanya, seperti yang kita lihat pada Contoh 4.1.10(a), fungsi  $\varphi(x) = 1/x$  tidak mempunyai limit pada  $x = 0$ . Kesimpulan ini juga mengikuti dari Teorema 4.2.2 karena fungsi  $\varphi(x) = 1/x$  tidak terbatas pada lingkungan

**Alternatif Jawaban dari C. 4.2.5 (d)**

$$(d) \lim_{x \rightarrow 2} \frac{x^2 - 4}{3x - 6} = \frac{4}{3}$$

Jawab:

$$\lim_{x \rightarrow 2} \frac{x^2 - 4}{3x - 6} = \frac{4}{3} \Rightarrow \text{Bukti?}$$

**Bukti:**

$$f(x) = x^2 - 4, \forall x \in \mathbb{R}$$

$$h(x) = 3x - 6, \forall x \in \mathbb{R}$$

$$\begin{aligned} \lim_{x \rightarrow 2} \left( \frac{f(x)}{h(x)} \right) &= \lim_{x \rightarrow 2} \left( \frac{x^2 - 4}{3x - 6} \right) \\ &= \frac{2^2 - 4}{3 \cdot 2 - 6} \\ &= \frac{4 - 4}{6 - 6} \\ &= \frac{0}{0} \\ &= \text{TD} \end{aligned}$$

Karena  $h(x) = 0$ , maka tidak bisa menggunakan T.4.2.4 (b)

Tetapi jika  $x \neq 2$ , maka

$$\frac{x^2 - 4}{3x - 6} = \frac{(x + 2)(x - 2)}{3(x - 2)} = \frac{x + 2}{3} = \frac{1}{3}(x + 2)$$

Sehingga

$$\begin{aligned} \lim_{x \rightarrow 2} \frac{x^2 - 4}{3x - 6} &= \lim_{x \rightarrow 2} \frac{1}{3}(x + 2) \\ &= \frac{1}{3} \left( \lim_{x \rightarrow 2} (x + 2) \right) \\ &= \frac{1}{3} (2 + 2) \end{aligned}$$

$x = 0$ .

**Poin Penting dari C. 4.2.5 (d)**

$$1. f(x) = x^2 - 4, \forall x \in \mathbb{R}$$

$$2. h(x) = 3x - 6, \forall x \in \mathbb{R}$$

$$3. \lim_{x \rightarrow 2} \left( \frac{f(x)}{h(x)} \right) = \lim_{x \rightarrow 2} \left( \frac{x^2 - 4}{3x - 6} \right)$$

$$\begin{aligned} 4. \lim_{x \rightarrow 2} \left( \frac{x^2 - 4}{3x - 6} \right) &= \frac{2^2 - 4}{3 \cdot 2 - 6} \\ &= \frac{0}{0} = \text{TD} \end{aligned}$$

$$5. x \neq 2, \frac{x^2 - 4}{3x - 6} = \frac{1}{3}(x + 2)$$

$$6. \lim_{x \rightarrow 2} \frac{x^2 - 4}{3x - 6} = \lim_{x \rightarrow 2} \frac{1}{3}(x + 2)$$

$$7. \lim_{x \rightarrow 2} \frac{x^2 - 4}{3x - 6} = \frac{4}{3}$$

$$= \frac{1}{3} (4)$$

$$= \frac{4}{3}$$

Perhatikan, bahwa fungsi  $g(x) = \frac{x^2-4}{3x-6}$  mempunyai limit pada  $x = 2$  meskipun tidak terdefinisi pada titik tersebut.

Jadi,  $\lim_{x \rightarrow 2} \frac{x^2-4}{3x-6} = \frac{4}{3}$  terbukti.

#### Alternatif Jawaban dari C. 4.2.5 (e)

$\lim_{x \rightarrow 0} \frac{1}{x}$  tidak ada dalam  $\mathbb{R} \rightarrow$  Bukti?

Bukti:

$$\lim_{x \rightarrow 0} \frac{1}{x} = \frac{\lim_{x \rightarrow 0} 1}{\lim_{x \rightarrow 0} x} = \frac{1}{0} \Rightarrow \frac{L}{H}$$

Karena  $H = 0$ , maka kita tidak dapat menggunakan T. 4.2.4 (b).

Tetapi, seperti C. 4.1.10 (a) yaitu  $\lim_{x \rightarrow 0} \frac{1}{x}$  tidak ada dalam  $\mathbb{R}$

Misalkan  $\varphi(x) = \frac{1}{x}, \forall x > 0$ .

Akan tetapi, disini kita menyelidiki pada  $c = 0$ . Argumen yang diberikan pada C. 4.1.7 (d) tidak berlaku jika  $c = 0$  karena kita tidak akan memperoleh suatu batas seperti pada contoh (2) tersebut.

Memang, jika kita mengambil barisan  $(x_n)$  dengan  $x_n := \frac{1}{n}, \forall n \in \mathbb{N}$ , kemudian  $\lim_{(x_n)} = 0$  tapi  $\varphi(x_n) = \frac{1}{(\frac{1}{n})} = n$

Seperti kita ketahui bahwa barisan  $(\varphi(x_n)) = n$  tidak konvergen dalam  $\mathbb{R}$ , karena barisan ini tidak terbatas, oleh karena itu teorema  $\lim_{x \rightarrow 0} \left(\frac{1}{x}\right)$  tidak ada dalam  $\mathbb{R}$ . Fungsi  $\varphi(x) = \frac{1}{x}$  tidak

#### Poin Penting dari C. 4.2.5 (e)

1.  $\lim_{x \rightarrow 0} \frac{1}{x} = \frac{\lim_{x \rightarrow 0} 1}{\lim_{x \rightarrow 0} x}$
2.  $\lim_{x \rightarrow 0} \frac{1}{x} = \frac{1}{0}$
3.  $\varphi(x) = \frac{1}{x}, \forall x > 0$
4.  $x_n := \frac{1}{n}, \forall n \in \mathbb{N}$
5.  $\varphi(x_n) = \frac{1}{(\frac{1}{n})} = n$
6. jika  $0 < |x - c| < \delta$ , maka  $|f(x) - L| < 1$
7. jika  $x \in A \cap V_{\delta(c)}, x \neq c$ , maka  $|f(x)| < L + 1$
8. Jika  $c \notin A$ , kita ambil  $M = |L| + 1$
9.  $c \in A$ , kita ambil  $M = \sup\{|f(c)|, |L| + 1\}$
10. jika  $c \in A \cap V_{\delta(c)}$ , maka  $|f(x)| \leq M$
11.  $\lim_{x \rightarrow 0} \frac{1}{x}$  tidak ada dalam  $\mathbb{R}$

mempunyai limit pada  $x = 0$ . Kesimpulan ini juga mengikuti T. 4.2.2 yaitu sebagai berikut:

Jika  $L = \lim_{x \rightarrow c} f(x)$ , maka oleh T. 4.1.6 dengan  $\varepsilon = 1$ , terdapat  $\delta > 0$ . Sedemikian sehingga jika  $0 < |x - c| < \delta$ , maka  $|f(x) - L| < 1$  dari sini (oleh Lemma 2.3.4),  $|f(x) - L| \leq |f(x) - L| < 1$ . Oleh karena itu, jika  $x \in A \cap V_{\delta(c)}$ ,  $x \neq c$ , maka  $|f(x)| < L + 1$ . Jika  $c \notin A$ , kita ambil  $M = |L| + 1$ , sedangkan jika  $c \in A$ , kita ambil  $M = \sup\{|f(c)|, |L| + 1\}$ . Ini berarti jika  $c \in A \cap V_{\delta(c)}$ , maka  $|f(x)| \leq M$ . Ini menunjukkan bahwa  $f$  terbatas pada  $V_{\delta(c)}$  suatu lingkungan  $\delta$  dari  $c$ . Karena fungsi  $\varphi(x) = \frac{1}{x}$  tidak terbatas pada lingkungan dari  $x = 0$ .

#### 4.2.5 Examples

(f) If  $p$  is a polynomial function, then  $\lim_{x \rightarrow c} p(x) = p(c)$ .

Let  $p$  be a polynomial function on  $\mathbb{R}$  so that

$$\begin{aligned} p(x) &= a_n x^n + a_{n-1} x^{n-1} + \cdots + a_1 x + a_0 \text{ for all } x \in \mathbb{R}. \text{ It} \\ \text{follows from Theorem 4.2.4 and the fact that } \lim_{x \rightarrow c} x^k &= c^k \text{ that} \\ \lim_{x \rightarrow c} p(x) &= \lim_{x \rightarrow c} [a_n x^n + a_{n-1} x^{n-1} + \cdots + a_1 x + a_0] \\ &= \\ &= \lim_{x \rightarrow c} a_n x^n + \\ &= \lim_{x \rightarrow c} a_{n-1} x^{n-1} + \cdots + \lim_{x \rightarrow c} a_1 x \\ &\quad + \lim_{x \rightarrow c} a_0 \\ &= a_n c^n + a_{n-1} c^{n-1} + \cdots + a_1 c + a_0 \\ &= p(c). \end{aligned}$$

Hence  $\lim_{x \rightarrow c} p(x) = p(c)$  for any polynomial function  $p$ .

#### Contoh 4.2.5

(f) Jika  $p$  adalah fungsi polinomial, maka  $\lim_{x \rightarrow c} p(x) = p(c)$ .

Misal  $p$  fungsi polinomial pada  $\mathbb{R}$  dengan demikian

$$\begin{aligned} p(x) &= a_n x^n + a_{n-1} x^{n-1} + \cdots + a_1 x + a_0 \text{ untuk setiap } x \in \mathbb{R}. \\ \text{Menurut Teorema 4.2.4 dan fakta bahwa } \lim_{x \rightarrow c} x^k &= c^k \\ \text{sehingga} \\ \lim_{x \rightarrow c} p(x) &= \lim_{x \rightarrow c} [a_n x^n + a_{n-1} x^{n-1} + \cdots + a_1 x + a_0] \\ &= \\ &= \lim_{x \rightarrow c} a_n x^n + \\ &= \lim_{x \rightarrow c} a_{n-1} x^{n-1} + \cdots + \lim_{x \rightarrow c} a_1 x \\ &\quad + \lim_{x \rightarrow c} a_0 \\ &= a_n c^n + a_{n-1} c^{n-1} + \cdots + a_1 c + a_0 \\ &= p(c). \end{aligned}$$

Dari sini  $\lim_{x \rightarrow c} p(x) = p(c)$  untuk sebarang fungsi polinomial  $p$ .

(g) If  $p$  and  $q$  are polynomial function on  $\mathbb{R}$  and if  $q(c) \neq 0$ , then

$$\lim_{x \rightarrow c} \frac{p(x)}{q(x)} = \frac{p(c)}{q(c)}.$$

Since  $q(x)$  is a polynomial function, it follows from theorem in algebra that there are at most a finite number of real number  $\alpha_1, \dots, \alpha_m$  [the real zeroes of  $q(x)$ ] such that  $q(\alpha_j) = 0$  and such that if  $x \notin \{\alpha_1, \dots, \alpha_m\}$ , then  $q(x) \neq 0$ . Hence, if  $x \notin \{\alpha_1, \dots, \alpha_m\}$ , we can define

$$r(x) := \frac{p(x)}{q(x)}.$$

If  $c$  is not a zero of  $q(x)$ , then  $q(c) \neq 0$ , and it follows from part (f) that  $\lim_{x \rightarrow c} q(x) = q(c) \neq 0$ .

Therefore we can apply Theorem 4.2.4 (b) to conclude that

$$\lim_{x \rightarrow c} \frac{p(x)}{q(x)} = \frac{\lim_{x \rightarrow c} p(x)}{\lim_{x \rightarrow c} q(x)} = \frac{p(c)}{q(c)}.$$

□

The next result is a direct analogue of Theorem 3.2.6.

(g) Jika  $p$  dan  $q$  fungsi-fungsi pada  $\mathbb{R}$  dan jika  $q(c) \neq 0$ , maka

$$\lim_{x \rightarrow c} \frac{p(x)}{q(x)} = \frac{p(c)}{q(c)}.$$

Karena  $q(x)$  suatu fungsi polinomial, menurut teorema aljabar bahwa ada paling banyak bilangan terbatas dari bilangan real  $\alpha_1, \dots, \alpha_m$  [bilangan real nol di  $q(x)$ ] sedemikian sehingga  $q(\alpha_j) = 0$  dan sedemikian sehingga jika  $x \notin \{\alpha_1, \dots, \alpha_m\}$ , maka  $q(x) \neq 0$ . Dari sini, jika  $x \notin \{\alpha_1, \dots, \alpha_m\}$ , kita dapat mendefinisikan

$$r(x) := \frac{p(x)}{q(x)}.$$

Jika  $c$  tidak nol di  $q(x)$ , maka  $q(c) \neq 0$ , dan jika menurut bagian (f) bahwa  $\lim_{x \rightarrow c} q(x) = q(c) \neq 0$ .

Oleh karena itu kita dapat menerapkan Teorema 4.2.4 (b) untuk menyimpulkan bahwa

$$\lim_{x \rightarrow c} \frac{p(x)}{q(x)} = \frac{\lim_{x \rightarrow c} p(x)}{\lim_{x \rightarrow c} q(x)} = \frac{p(c)}{q(c)}.$$

□

Hasil berikutnya adalah analog langsung dari Teorema 3.2.6.

**Alternatif Jawaban dari C. 4.2.5 (f)**

Misal  $p$  fungsi polynomial pada  $\mathbb{R}$ , maka  $\lim_{x \rightarrow c} p(x) = p(c) \rightarrow$

Bukti?

**Bukti:**

Misal  $p$  fungsi polinomial pada  $\mathbb{R}$  sehingga

$$p(x) = a_n x^n + a_{n-1} x^{n-1} + \dots + a_1 x + a_0, \forall x \in \mathbb{R}.$$

Menurut T. 4.2.4 dan  $\lim_{x \rightarrow c} x^k = c^k$  sehingga

$$\lim_{x \rightarrow c} p(x) = \lim_{x \rightarrow c} [a_n x^n + a_{n-1} x^{n-1} + \dots + a_1 x + a_0]$$

**Point Penting dari C. 4.2.5 (f)**

1.  $p$  fungsi polynomial pada  $\mathbb{R}$
2.  $p(x) = a_n x^n + a_{n-1} x^{n-1} + \dots + a_1 x + a_0, \forall x \in \mathbb{R}$
3.  $\lim_{x \rightarrow c} x^k = c^k$
4.  $\lim_{x \rightarrow c} p(x) = p(c)$

$=$ $\lim_{x \rightarrow c} a_n x^n +$ $\lim_{x \rightarrow c} a_{n-1} x^{n-1} + \dots + \lim_{x \rightarrow c} a_1 x$ $+ \lim_{x \rightarrow c} a_0$ $= a_n c^n + a_{n-1} c^{n-1} + \dots + a_1 c + a_0$ $= p(c).$ <p>Dari sini <math>\lim_{x \rightarrow c} p(x) = p(c)</math> untuk sebarang fungsi polynomial <math>p</math>.</p>	
<p><b>Alternatif Jawaban dari C. 4.2.5 (g)</b></p> <p>Jika <math>p \wedge q</math> fungsi-fungsi pada <math>\mathbb{R} \wedge q(c) \neq 0 \Rightarrow \lim_{x \rightarrow c} \frac{p(x)}{q(x)} = \frac{p(c)}{q(c)} \rightarrow</math></p> <p>Bukti?</p> <p><b>Bukti:</b></p> <p><math>q(x)</math> fungsi polinomial, menurut teorema aljabar bahwa ada paling banyak bilangan terbatas dari bilangan real <math>\alpha_1, \dots, \alpha_m</math> [bilangan real nol di <math>q(x)</math>] <math>\exists q(\alpha_j) = 0</math> dan <math>x \notin \{\alpha_1, \dots, \alpha_m\}</math> sehingga <math>q(x) \neq 0</math>.</p> <p>Jika <math>x \notin \{\alpha_1, \dots, \alpha_m\}</math></p> $r(x) := \frac{p(x)}{q(x)}.$ <p>Jika <math>c</math> tidak nol di <math>q(x)</math>, maka <math>q(c) \neq 0</math>.</p> <p>Menurut bagian (f) bahwa <math>\lim_{x \rightarrow c} q(x) = q(c) \neq 0</math>.</p> <p>Dengan menerapkan T. 4.2.4 (b) untuk menyimpulkan bahwa</p> $\lim_{x \rightarrow c} \frac{p(x)}{q(x)} = \frac{\lim_{x \rightarrow c} p(x)}{\lim_{x \rightarrow c} q(x)} = \frac{p(c)}{q(c)}.$ <p style="text-align: center;">□</p> <p>Hasil berikutnya adalah analog langsung dari Teorema 3.2.6.</p> <p>Teorema 3.2.6</p> <p>Jika <math>X = (x_n)</math> suatu barisan konvergen dan jika <math>a \leq x_n \leq b, \forall n \in</math></p>	<p><b>Point Penting dari C. 4.2.5 (g)</b></p> <ol style="list-style-type: none"> <li>1. <math>p \wedge q</math> fungsi-fungsi pada <math>\mathbb{R}</math></li> <li>2. <math>q(c) \neq 0</math></li> <li>3. <math>\lim_{x \rightarrow c} \frac{p(x)}{q(x)} = \frac{p(c)}{q(c)}</math></li> <li>4. <math>q(x)</math> fungsi polinomial</li> <li>5. Ada paling banyak bilangan terbatas dari bilangan real <math>\alpha_1, \dots, \alpha_m</math></li> <li>6. <math>q(\alpha_j) = 0</math></li> <li>7. <math>x \notin \{\alpha_1, \dots, \alpha_m\} \exists q(x) \neq 0</math></li> <li>8. <math>r(x) := \frac{p(x)}{q(x)}</math></li> <li>9. <math>c</math> tidak nol di <math>q(x) \rightarrow q(c) \neq 0</math></li> <li>10. <math>\lim_{x \rightarrow c} q(x) = q(c) \neq 0</math></li> <li>11. <math>\lim_{x \rightarrow c} \frac{p(x)}{q(x)} = \frac{\lim_{x \rightarrow c} p(x)}{\lim_{x \rightarrow c} q(x)} = \frac{p(c)}{q(c)}</math></li> </ol>

$\mathbb{N}$ , maka $a \leq \lim (x_n) \leq b$ .	
--	--

**4.2.6 Theorem** Let  $A \subseteq \mathbb{R}$ , let  $f: A \rightarrow \mathbb{R}$ , and let  $c \in \mathbb{R}$  be a cluster point of  $A$ . If  $a \leq f(x) \leq b$  for all  $x \in A, x \neq c$ , and if  $\lim_{x \rightarrow c} f$  exists, then  $a \leq \lim_{x \rightarrow c} f \leq b$ .

**Proof.** Indeed, if  $L = \lim_{x \rightarrow c} f$ , then it follows from Theorem 4.1.8 that if  $(x_n)$  is any sequence of real numbers such that  $c \neq x_n \in A$  for all  $n \in \mathbb{N}$  and if the sequence  $(x_n)$  converges to  $c$ , then the sequence  $(f(x_n))$  converges to  $L$ . Since  $a \leq f(x_n) \leq b$  for all  $n \in \mathbb{N}$ , it follows from Theorem 3.2.6 that  $a \leq L \leq b$ . Q.E.D.

We now state an analogue of the Squeeze Theorem 3.2.7. We leave its proof to the reader.

**Teorema 4.2.6** Misalkan  $A \subseteq \mathbb{R}$ , misalkan  $f: A \rightarrow \mathbb{R}$  dan  $c \in \mathbb{R}$  suatu titik kumpul dari  $A$ . Jika  $a \leq f(x) \leq b$  untuk semua  $x \in A, x \neq c$ , dan jika  $\lim_{x \rightarrow c} f$  ada, maka  $a \leq \lim_{x \rightarrow c} f \leq b$ .

**Bukti.** Memang, jika  $L = \lim_{x \rightarrow c} f$ , maka menurut T.4.1.8 bahwa jika  $(x_n)$  sebarang barisan bilangan real sedemikian sehingga  $c \neq x_n \in A$  untuk semua  $n \in \mathbb{N}$  dan jika barisan  $(x_n)$  konvergen ke  $c$ , maka barisan  $(f(x_n))$  konvergen ke  $L$ . Karena  $a \leq f(x_n) \leq b$  untuk semua  $n \in \mathbb{N}$ , berarti menurut Teorema 3.2.6  $a \leq L \leq b$ . Q.E.D.

Kita sekarang berargumen sebuah analogi dari Teorema Apit 3.2.7. Kita tinggalkan pembuktian ini kepada pembaca.

<p><b>Notasi Matematika dari T. 4.2.6</b>  <math>A \subseteq \mathbb{R}, f: A \rightarrow \mathbb{R}, c \in \mathbb{R}, c</math> titik kumpul dari <math>A</math>. Lalu <math>a \leq f(x) \leq b, \forall x \in A, x \neq c, \exists \lim_{x \rightarrow c} f \Rightarrow a \leq \lim_{x \rightarrow c} f \leq b</math>.</p>	<p><b>Kontrapositif dari T. 4.2.6</b>  <math>A \subseteq \mathbb{R}, f: A \rightarrow \mathbb{R}, c \in \mathbb{R}, c</math> bukan titik kumpul dari <math>A</math>. Lalu <math>\lim_{x \rightarrow c} f &lt; a \vee \lim_{x \rightarrow c} f &gt; b \Rightarrow a \leq f(x) \leq b, \exists x \in A, x = c, \nexists \lim_{x \rightarrow c} f</math>.</p>
<p><b>Poin Penting dari T. 4.2.6</b></p> <ol style="list-style-type: none"> <li>1. <math>A \subseteq \mathbb{R}</math>.</li> <li>2. <math>f: A \rightarrow \mathbb{R}</math>.</li> <li>3. <math>c \in \mathbb{R}, c</math> titik kumpul dari <math>A</math>.</li> <li>4. <math>a \leq f(x) \leq b, \forall x \in A, x \neq c</math>.</li> <li>5. <math>\exists \lim_{x \rightarrow c} f</math>.</li> <li>6. <math>a \leq \lim_{x \rightarrow c} f \leq b</math>.</li> </ol>	<p><b>Poin Penting Kontrapositif dari T. 4.2.6</b></p> <ol style="list-style-type: none"> <li>1. <math>A \subseteq \mathbb{R}</math>.</li> <li>2. <math>f: A \rightarrow \mathbb{R}</math>.</li> <li>3. <math>c \in \mathbb{R}, c</math> bukan titik kumpul dari <math>A</math>.</li> <li>4. <math>\lim_{x \rightarrow c} f &lt; a \vee \lim_{x \rightarrow c} f &gt; b</math>.</li> <li>5. <math>a \leq f(x) \leq b, \exists x \in A, x = c</math>.</li> <li>6. <math>\nexists \lim_{x \rightarrow c} f</math>.</li> </ol>
<p><b>Alternatif Bukti dari T. 4.2.6</b>  <math>A \subseteq \mathbb{R}, f: A \rightarrow \mathbb{R}, c \in \mathbb{R}, c</math> titik kumpul <math>A</math>. <math>a \leq f(x) \leq b, \forall x \in A, x \neq c, \exists \lim_{x \rightarrow c} f \Rightarrow a \leq \lim_{x \rightarrow c} f \leq b \rightarrow</math> Bukti?  <u>Bukti:</u>                  Misal: <math>L = \lim_{x \rightarrow c} f</math></p>	<p><b>Poin Penting Alternatif Bukti dari T. 4.2.6</b></p> <ol style="list-style-type: none"> <li>1. <math>A \subseteq \mathbb{R}</math>.</li> <li>2. <math>f: A \rightarrow \mathbb{R}</math>.</li> <li>3. <math>c</math> titik kumpul <math>A</math>.</li> <li>4. <math>a \leq f(x) \leq b, \forall x \in A, x \neq c</math>.</li> </ol>

<p>Berdasarkan T.4.1.8  <math>(x_n)</math> barisan <math>\mathbb{R} \ni c \neq x_n \in A, \forall n \in \mathbb{N}</math>, barisan <math>(x_n)</math> konvergen ke <math>c</math>, barisan <math>(f(x_n))</math> konvergen ke <math>L</math>.                  Karena <math>a \leq f(x_n) \leq b, \forall n \in \mathbb{N}</math>,                  Berdasarkan T.3.2.6 <math>a \leq L \leq b</math>                  Jadi, <math>a \leq \lim_{x \rightarrow c} f \leq b</math>. ■</p>	<ol style="list-style-type: none"> <li>5. <math>\exists \lim_{x \rightarrow c} f</math>.</li> <li>6. <math>L = \lim_{x \rightarrow c} f</math>.</li> <li>7. <math>(x_n)</math> barisan <math>\mathbb{R} \ni c \neq x_n \in A, \forall n \in \mathbb{N}</math>.</li> <li>8. barisan <math>(x_n)</math> konvergen ke <math>c</math>.</li> <li>9. barisan <math>(f(x_n))</math> konvergen ke <math>L</math>.</li> <li>10. <math>a \leq f(x_n) \leq b, \forall n \in \mathbb{N}</math>.</li> <li>11. <math>a \leq L \leq b</math> (Menurut T.3.2.6).</li> <li>12. <math>a \leq \lim_{x \rightarrow c} f \leq b</math>.</li> </ol>
--	---

**4.2.7 Squeeze Theorem** Let  $A \subseteq \mathbb{R}$ , let  $f, g, h: A \rightarrow \mathbb{R}$ , and let  $c \in \mathbb{R}$  be a cluster point of  $A$ . If

$f(x) \leq g(x) \leq h(x)$  for all  $x \in A, x \neq c$ ,  
 and if  $\lim_{x \rightarrow c} f = L = \lim_{x \rightarrow c} h$ , then  $\lim_{x \rightarrow c} g = L$ .

**Teorema Apit 4.2.7** Misal  $A \subseteq \mathbb{R}$ , misal  $f, g, h: A \rightarrow \mathbb{R}$ , dan  $c \in \mathbb{R}$  titik kumpul dari  $A$ . Jika

$f(x) \leq g(x) \leq h(x)$  untuk semua  $x \in A, x \neq c$ ,  
 dan jika  $\lim_{x \rightarrow c} f = L = \lim_{x \rightarrow c} h$ , maka  $\lim_{x \rightarrow c} g = L$ .

<p><b>Notasi Matematika dari T 4.2.7</b>  <math>A \subseteq \mathbb{R}, f, g, h: A \rightarrow \mathbb{R}, c \in \mathbb{R}</math> titik kumpul dari <math>A</math> lalu  <math>f(x) \leq g(x) \leq h(x), \forall x \in A, x \neq c \wedge \lim_{x \rightarrow c} f = L = \lim_{x \rightarrow c} h \Rightarrow</math>  <math>\lim_{x \rightarrow c} g = L</math>.</p>	<p><b>Kontrapositif dari T 4.2.7</b>  <math>A \subseteq \mathbb{R}, f, g, h: A \rightarrow \mathbb{R}, c \in \mathbb{R}</math> bukan titik kumpul dari <math>A</math> lalu  <math>\lim_{x \rightarrow c} g \neq L \Rightarrow f(x) \leq g(x) \leq h(x), \exists x \in A, x =</math>  <math>c \wedge \lim_{x \rightarrow c} f \neq L \neq \lim_{x \rightarrow c} h</math>.</p>
<p><b>Poin Penting dari T 4.2.7</b></p> <ol style="list-style-type: none"> <li>1. <math>A \subseteq \mathbb{R}</math></li> <li>2. <math>f, g, h: A \rightarrow \mathbb{R}</math></li> <li>3. <math>c \in \mathbb{R}</math> titik kumpul dari <math>A</math></li> <li>4. <math>f(x) \leq g(x) \leq h(x), \forall x \in A, x \neq c</math></li> <li>5. <math>\lim_{x \rightarrow c} f = L = \lim_{x \rightarrow c} h</math></li> <li>6. <math>\lim_{x \rightarrow c} g = L</math></li> </ol>	<p><b>Poin Penting Kontrapositif dari T 4.2.7</b></p> <ol style="list-style-type: none"> <li>1. <math>A \subseteq \mathbb{R}</math></li> <li>2. <math>f, g, h: A \rightarrow \mathbb{R}</math></li> <li>3. <math>c \in \mathbb{R}</math> bukan titik kumpul dari <math>A</math></li> <li>4. <math>\lim_{x \rightarrow c} g \neq L</math></li> <li>5. <math>f(x) \leq g(x) \leq h(x), \exists x \in A, x = c</math></li> <li>6. <math>\lim_{x \rightarrow c} f \neq L \neq \lim_{x \rightarrow c} h</math></li> </ol>
<p><b>Alternatif Bukti dari T 4.2.7</b>  <math>A \subseteq \mathbb{R}, f, g, h: A \rightarrow \mathbb{R}, c \in \mathbb{R}</math>, <math>c</math> titik kumpul dari <math>A</math> lalu  <math>f(x) \leq g(x) \leq h(x), \forall x \in A, x \neq c \wedge \lim_{x \rightarrow c} f = L = \lim_{x \rightarrow c} h \Rightarrow</math>  <math>\lim_{x \rightarrow c} g = L \rightarrow</math> Bukti?</p>	<p><b>Poin Penting Alternatif Bukti dari T 4.2.7</b></p> <ol style="list-style-type: none"> <li>1. <math>A \subseteq \mathbb{R}</math></li> <li>2. <math>f, g, h: A \rightarrow \mathbb{R}</math></li> <li>3. <math>c \in \mathbb{R}</math> titik kumpul dari <math>A</math></li> </ol>



<p><b>Bukti:</b>          Misal <math>A \subseteq \mathbb{R}</math>, <math>f, g, h: A \rightarrow \mathbb{R}</math> dan <math>c \in \mathbb{R}</math>, <math>c</math> titik kumpul dari <math>A</math>.          Adit <math>f(x) \leq g(x) \leq h(x), \forall x \in A, x \neq c</math> dan  <math>\lim_{x \rightarrow c} f = L = \lim_{x \rightarrow c} h</math>.          Ambil sebarang <math>\varepsilon &gt; 0</math> sehingga berdasarkan D. 4.1.4 diperoleh  <math>\lim_{x \rightarrow c} f(x) = L</math> berarti <math>\forall \varepsilon &gt; 0, \exists \delta_1(\varepsilon) &gt; 0 \exists \forall x \in A, 0 &lt;  x - c  &lt; \delta_1(\varepsilon) \Rightarrow  f(x) - L  &lt; \varepsilon</math>  <math>\lim_{x \rightarrow c} h(x) = L</math> berarti <math>\forall \varepsilon &gt; 0, \exists \delta_2(\varepsilon) &gt; 0 \exists \forall x \in A, 0 &lt;  x - c  &lt; \delta_2(\varepsilon) \Rightarrow  h(x) - L  &lt; \varepsilon</math>          Karena <math>f(x) \leq g(x) \leq h(x), \forall x \in A, x \neq c</math> sehingga <math>f(x) - L \leq g(x) - L \leq h(x) - L, \forall x \in A, x \neq c</math> diperoleh <math> g(x) - L  \leq \sup\{ f(x) - L ,  h(x) - L \} &lt; \varepsilon</math>.          Pilih <math>\delta(\varepsilon) = \inf\{\delta_1(\varepsilon), \delta_2(\varepsilon)\}</math> sehingga <math>\forall \varepsilon &gt; 0, \exists \delta(\varepsilon) &gt; 0 \exists \forall x \in A, 0 &lt;  x - c  &lt; \delta(\varepsilon) \Rightarrow  g(x) - L  \leq \sup\{ f(x) - L ,  h(x) - L \} &lt; \varepsilon</math>.          Jadi, <math>\lim_{x \rightarrow c} g(x) = L \square</math></p>	<ol style="list-style-type: none"> <li>4. <math>f(x) \leq g(x) \leq h(x), \forall x \in A, x \neq c</math></li> <li>5. <math>\lim_{x \rightarrow c} f = L = \lim_{x \rightarrow c} h</math></li> <li>6. <math>\lim_{x \rightarrow c} g = L</math></li> <li>7. <math>\varepsilon &gt; 0</math></li> <li>8. <math>\lim_{x \rightarrow c} f(x) = L</math></li> <li>9. <math>\exists \delta_1(\varepsilon) &gt; 0 \exists \forall x \in A</math></li> <li>10. <math>0 &lt;  x - c  &lt; \delta_1(\varepsilon) \Rightarrow  f(x) - L  &lt; \varepsilon</math></li> <li>11. <math>\lim_{x \rightarrow c} h(x) = L</math></li> <li>12. <math>\exists \delta_2(\varepsilon) &gt; 0 \exists \forall x \in A</math></li> <li>13. <math>0 &lt;  x - c  &lt; \delta_2(\varepsilon) \Rightarrow  h(x) - L  &lt; \varepsilon</math></li> <li>14. <math>f(x) - L \leq g(x) - L \leq h(x) - L, \forall x \in A</math></li> <li>15. <math> g(x) - L  \leq \sup\{ f(x) - L ,  h(x) - L \} &lt; \varepsilon</math></li> <li>16. <math>\delta(\varepsilon) = \inf\{\delta_1(\varepsilon), \delta_2(\varepsilon)\}</math></li> <li>17. <math>\forall \varepsilon &gt; 0, \exists \delta(\varepsilon) &gt; 0 \exists \forall x \in A</math></li> <li>18. <math>0 &lt;  x - c  &lt; \delta(\varepsilon) \Rightarrow  g(x) - L  \leq \sup\{ f(x) - L ,  h(x) - L \} &lt; \varepsilon</math></li> </ol>
<p><b>Alternatif Bukti dari T 4.2.7</b>  <math>A \subseteq \mathbb{R}, f, g, h: A \rightarrow \mathbb{R}, c \in \mathbb{R}, c</math> titik kumpul dari <math>A</math> lalu  <math>f(x) \leq g(x) \leq h(x), \forall x \in A, x \neq c \wedge \lim_{x \rightarrow c} f = L = \lim_{x \rightarrow c} h \Rightarrow \lim_{x \rightarrow c} g = L \rightarrow</math> Bukti?  <u>Bukti:</u>          Misal <math>g: A \rightarrow \mathbb{R}, c \in \mathbb{R}</math> <math>c</math> titik kumpul dari <math>A, \forall x \in A, x \neq c</math> sehingga berdasarkan definisi D. 4.1.4  <math>\lim_{x \rightarrow c} f(x) = L</math> berarti <math>\forall \varepsilon &gt; 0, \exists \delta_1(\varepsilon) &gt; 0 \exists \forall x \in A, 0 &lt;  x - c  &lt; \delta_1(\varepsilon) \Rightarrow  f(x) - L  &lt; \varepsilon</math></p>	<p><b>Poin Penting Alternatif Bukti dari T 4.2.7</b></p> <ol style="list-style-type: none"> <li>1. <math>A \subseteq \mathbb{R}</math></li> <li>2. <math>f, g, h: A \rightarrow \mathbb{R}</math></li> <li>3. <math>c \in \mathbb{R}</math> titik kumpul dari <math>A</math></li> <li>4. <math>f(x) \leq g(x) \leq h(x), \forall x \in A, x \neq c</math></li> <li>5. <math>\lim_{x \rightarrow c} f = L = \lim_{x \rightarrow c} h</math></li> <li>6. <math>\lim_{x \rightarrow c} g = L</math></li> <li>7. <math>g: A \rightarrow \mathbb{R}</math></li> <li>8. <math>\forall x \in A, x \neq c</math></li> <li>9. <math>\lim_{x \rightarrow c} f(x) = L</math></li> </ol>

<p><math>\lim_{x \rightarrow c} h(x) = L</math> berarti <math>\forall \varepsilon &gt; 0, \exists \delta_2(\varepsilon) &gt; 0 \exists \forall x \in A, 0 &lt;  x - c  &lt; \delta_2(\varepsilon) \Rightarrow  h(x) - L  &lt; \varepsilon</math> didapat <math>\lim_{x \rightarrow c} g(x) = a</math>.</p> <p>Karena <math>\lim_{x \rightarrow c} g(x) = a</math> sehingga berdasarkan T. 4.2.6 <math>A \subseteq \mathbb{R}, f: A \rightarrow \mathbb{R}, c \in \mathbb{R}, c</math> titik kumpul dari <math>A</math> lalu <math>a \leq f(x) \leq b, \forall x \in A, x \neq c, \exists \lim_{x \rightarrow c} f \Rightarrow a \leq \lim_{x \rightarrow c} f \leq b</math>.</p> <p>didapat <math>\lim_{x \rightarrow c} f(x) \leq \lim_{x \rightarrow c} g(x) \leq \lim_{x \rightarrow c} h(x) \Leftrightarrow L \leq \lim_{x \rightarrow c} g(x) \leq L</math></p> <p>Karena <math>L \leq \lim_{x \rightarrow c} g(x) \leq L</math> sehingga berdasarkan D. 2.1.6 <math>a \leq b \leq c \Rightarrow a = b</math> didapat <math>\lim_{x \rightarrow c} g(x) = L</math>.</p> <p>Jadi, <math>\lim_{x \rightarrow c} g(x) = L \square</math></p>	<p>10. <math>\forall \varepsilon &gt; 0</math></p> <p>11. <math>\exists \delta_1(\varepsilon) &gt; 0 \exists \forall x \in A, 0 &lt;  x - c  &lt; \delta_1(\varepsilon) \Rightarrow  f(x) - L  &lt; \varepsilon</math></p> <p>12. <math>\lim_{x \rightarrow c} h(x) = L</math></p> <p>13. <math>\exists \delta_2(\varepsilon) &gt; 0 \exists \forall x \in A, 0 &lt;  x - c  &lt; \delta_2(\varepsilon) \Rightarrow  h(x) - L  &lt; \varepsilon</math></p> <p>14. <math>\lim_{x \rightarrow c} g(x) = a</math></p> <p>15. <math>A \subseteq \mathbb{R}, f: A \rightarrow \mathbb{R}, c \in \mathbb{R}</math></p> <p>16. <math>a \leq f(x) \leq b \forall x \in A, x \neq c, \exists \lim_{x \rightarrow c} f \Rightarrow a \leq \lim_{x \rightarrow c} f \leq b</math></p> <p>17. <math>\lim_{x \rightarrow c} f(x) \leq \lim_{x \rightarrow c} g(x) \leq \lim_{x \rightarrow c} h(x) \Leftrightarrow L \leq \lim_{x \rightarrow c} g(x) \leq L</math></p> <p>18. <math>L \leq \lim_{x \rightarrow c} g(x) \leq L</math></p> <p>19. <math>a \leq b \leq c \Rightarrow a = b</math></p>
--	--

**4.2.8 Exemples (a)**  $\lim_{x \rightarrow 0} x^{3/2} = 0 (x > 0)$ .

Let  $f(x) = x^{3/2}$  for  $x > 0$ . Since the inequality  $x < x^{1/2} \leq 1$  holds for  $0 < x \leq 1$  (why?), it follows that  $x^2 \leq f(x) = x^{3/2} \leq x$  for  $0 < x \leq 1$ . Since

$$\lim_{x \rightarrow 0} x^2 = 0 \text{ and } \lim_{x \rightarrow 0} x = 0,$$

it follows from the Squeeze Theorem 4.2.7 that  $\lim_{x \rightarrow 0} x^{3/2} = 0$ .

**(b)**  $\lim_{x \rightarrow 0} \sin x = 0$ .

It will be proved later (see Theorem 8.4.8), that

$$-x \leq \sin x \leq x \text{ for all } x \geq 0.$$

Since  $\lim_{x \rightarrow 0} (\pm x) = 0$ , it follows from the Squeeze Theorem that  $\lim_{x \rightarrow 0} \sin x = 0$ .

**Contoh 4.2.8 (a)**  $\lim_{x \rightarrow 0} x^{3/2} = 0 (x > 0)$ .

Misalkan  $f(x) = x^{3/2}$  untuk  $x > 0$ . Karena ketidaksamaan  $x < x^{1/2} \leq 1$  berlaku untuk  $0 < x \leq 1$  (mengapa?), itu mengikuti  $x^2 \leq f(x) = x^{3/2} \leq x$  untuk  $0 < x \leq 1$ .

1. Karena

$$\lim_{x \rightarrow 0} x^2 = 0 \text{ dan } \lim_{x \rightarrow 0} x = 0,$$

**(b)**  $\lim_{x \rightarrow 0} \sin x = 0$ .

Ini akan dibuktikan dengan (lihat Teorema 8.4.8), bahwa

$$-x \leq \sin x \leq x \text{ untuk semua } x \geq 0.$$

Karena  $\lim_{x \rightarrow 0} (\pm x) = 0$ , ini mengikuti dari Teorema Apit bahwa  $\lim_{x \rightarrow 0} \sin x = 0$ .

**Alternatif Jawaban dari C. 4.2.8 (a)**

$\lim_{x \rightarrow 0} x^{3/2} = 0, x > 0. \rightarrow$  Bukti?

Bukti:

**Poin Penting dari C. 4.2.8 (a)**

- $\lim_{x \rightarrow 0} x^{3/2} = 0, x > 0$
- $f(x) = x^{3/2}, \forall x > 0$

<p>Misal <math>f(x) = x^{3/2}, \forall x &gt; 0</math>.          Karena ketidaksamaan <math>x &lt; x^{1/2} \leq 1, 0 &lt; x \leq 1</math>.          Sehingga <math>x^2 \leq x^{3/2} = f(x) \leq x, 0 &lt; x \leq 1</math>.          Karena <math>\lim_{x \rightarrow 0} x^2 = 0</math> dan <math>\lim_{x \rightarrow 0} x = 0</math>, sehingga          berdasarkan Teorema Apit 4.2.7 diperoleh</p> $\lim_{x \rightarrow 0} x^2 \leq \lim_{x \rightarrow 0} x^{3/2} \leq \lim_{x \rightarrow 0} x.$ $\Leftrightarrow 0 \leq \lim_{x \rightarrow 0} x^{3/2} \leq 0.$ <p>Kemudian didapat <math>\lim_{x \rightarrow 0} x^{3/2} = 0</math>.          Jadi, <math>\lim_{x \rightarrow 0} x^{3/2} = 0</math> terbukti.</p>	<ol style="list-style-type: none"> <li>3. <math>x &lt; x^{1/2} \leq 1, 0 &lt; x \leq 1</math></li> <li>4. <math>x^2 \leq x^{3/2} = f(x) \leq x, 0 &lt; x \leq 1</math></li> <li>5. <math>\lim_{x \rightarrow 0} x^2 = 0</math></li> <li>6. <math>\lim_{x \rightarrow 0} x = 0</math></li> <li>7. <math>\lim_{x \rightarrow 0} x^2 \leq \lim_{x \rightarrow 0} x^{3/2} \leq \lim_{x \rightarrow 0} x</math></li> <li>8. <math>0 \leq \lim_{x \rightarrow 0} x^{3/2} \leq 0</math></li> <li>9. <math>\lim_{x \rightarrow 0} x^{3/2} = 0</math></li> </ol>
<p><b>Alternatif Jawaban dari C. 4.2.8 (b)</b>  <math>\lim_{x \rightarrow 0} \sin x = 0, \rightarrow</math> Bukti?  <b>Bukti:</b>  <math>\inf \sin x = -1, \sup \sin x = 1, \forall x \in \mathbb{R}</math>, sehingga  <math>-1 \leq \sin x \leq 1, \forall x \in \mathbb{R}</math>  <math>-x \leq \sin x \leq x, \forall x \in \mathbb{R}</math>          Didapat dari <b>T. 8.4.8</b> karena <math>\lim_{x \rightarrow 0} (\pm x) = 0</math>, sehingga          berdasarkan Teorema Apit diperoleh  <math>\lim_{x \rightarrow 0} -x \leq \lim_{x \rightarrow 0} \sin x \leq \lim_{x \rightarrow 0} x</math>  <math>\Leftrightarrow 0 \leq \lim_{x \rightarrow 0} \sin x \leq 0</math>.          Kemudian didapat <math>\lim_{x \rightarrow 0} \sin x = 0</math>.          Jadi, <math>\lim_{x \rightarrow 0} \sin x = 0</math> terbukti.</p>	<p><b>Poin Penting dari C. 4.1.1 (e)</b></p> <ol style="list-style-type: none"> <li>1. <math>\lim_{x \rightarrow 0} \sin x = 0</math></li> <li>2. <math>\inf \sin x = -1</math></li> <li>3. <math>\sup \sin x = 1</math></li> <li>4. <math>\forall x \in \mathbb{R}</math></li> <li>5. <math>-1 \leq \sin x \leq 1</math></li> <li>6. <math>-x \leq \sin x \leq x</math></li> <li>7. <math>\lim_{x \rightarrow 0} (\pm x) = 0</math></li> <li>8. <math>\lim_{x \rightarrow 0} -x \leq \lim_{x \rightarrow 0} \sin x \leq \lim_{x \rightarrow 0} x</math></li> <li>9. <math>0 \leq \lim_{x \rightarrow 0} \sin x \leq 0</math></li> </ol>

### 4.2.8 Examples

(c)  $\lim_{x \rightarrow 0} \cos x = 1$ .

It will be proved later (see Theorem 8.4.8) that

(1)  $1 - \frac{1}{2}x^2 \leq \cos x \leq 1$  for all  $x \in \mathbb{R}$ .

Since  $\lim_{x \rightarrow 0} \left(1 - \frac{1}{2}x^2\right) = 1$ , it follows from the Squeeze

### Contoh 4.2.8

(c)  $\lim_{x \rightarrow 0} \cos x = 1$ .

Ini akan dibuktikan nanti (lihat Teorema 8.4.8) bahwa

(1)  $1 - \frac{1}{2}x^2 \leq \cos x \leq 1$  untuk semua  $x \in \mathbb{R}$ .

Karena  $\lim_{x \rightarrow 0} \left(1 - \frac{1}{2}x^2\right) = 1$ , ini mengikuti dari Teorema Apit

## 4.2 Limits Theorem

Theorem that  $\lim_{x \rightarrow 0} \cos x = 1$ .

$$(d) \lim_{x \rightarrow 0} \left( \frac{\cos x - 1}{x} \right) = 0.$$

We cannot use Theorem 4.2.4 (b) to evaluate this limit. (Why not?) However, it follows from the inequality (1) in part (c) that

$$-\frac{1}{2}x \leq (\cos x - 1)/x \leq 0 \text{ for } x > 0$$

and that

$$0 \leq (\cos x - 1)/x \leq -\frac{1}{2}x \text{ for } x < 0.$$

Now let  $f(x) := -x/2$  for  $x \geq 0$  and  $f(x) := 0$  for  $x < 0$ , and let  $h(x) := 0$  for  $x \geq 0$  and  $h(x) := -x/2$  for  $x < 0$ . Then we have

$$f(x) \leq (\cos x - 1)/x \leq h(x) \text{ for } x \neq 0.$$

Since it is readily seen that  $\lim_{x \rightarrow 0} f = 0 = \lim_{x \rightarrow 0} h$ , it follows from the Squeeze Theorem that  $\lim_{x \rightarrow 0} (\cos x - 1)/x = 0$ .

## 4.2 Teorema Limit

bahwa  $\lim_{x \rightarrow 0} \cos x = 1$ .

$$(d) \lim_{x \rightarrow 0} \left( \frac{\cos x - 1}{x} \right) = 0.$$

Kita tidak dapat menggunakan Teorema 4.2.4 (b) untuk menghitung limit ini. (Mengapa tidak?) Namun, ini mengikuti dari ketidak samaan (1) pada bagian (c) bahwa

$$-\frac{1}{2}x \leq (\cos x - 1)/x \leq 0 \text{ untuk } x > 0$$

dan bahwa

$$0 \leq (\cos x - 1)/x \leq -\frac{1}{2}x \text{ untuk } x < 0.$$

Sekarang misalkan  $f(x) := -x/2$  untuk  $x \geq 0$  dan  $f(x) := 0$  untuk  $x < 0$ , dan misalkan  $h(x) := 0$  untuk  $x \geq 0$  dan  $h(x) := -x/2$  untuk  $x < 0$ .

$$f(x) \leq (\cos x - 1)/x \leq h(x) \text{ untuk } x \neq 0.$$

Karena ini mudah dilihat bahwa  $\lim_{x \rightarrow 0} f = 0 = \lim_{x \rightarrow 0} h$ , ini mengikuti dari Teorema Apit bahwa  $\lim_{x \rightarrow 0} (\cos x - 1)/x = 0$ .

### Alternatif Jawaban dari C. 4.2.8 (c)

$\lim_{x \rightarrow 0} \cos x = 1 \rightarrow$  Bukti?

#### Bukti:

Akan dibuktikan menggunakan T. 4.2.8

$$(viii) 1 - \frac{1}{2}x^2 \leq c(x) \leq 1$$

$$\inf \cos x = -1, \forall x \in \mathbb{R}$$

$$\sup \cos x = 1, \forall x \in \mathbb{R}.$$

Sehingga  $-1 \leq \cos x \leq 1, \forall x \in \mathbb{R} \Rightarrow 1 - \frac{1}{2}x^2 \leq 1, \forall x \in \mathbb{R}.$

Pembuktian asal mula  $1 - \frac{1}{2}x^2 \leq c(x) \leq 1$

### Poin Penting dari C. 4.2.8 (c)

$$1. 1 - \frac{1}{2}x^2 \leq c(x) \leq 1$$

$$2. \inf \cos x = -1, \forall x \in \mathbb{R}$$

$$3. \sup \cos x = 1, \forall x \in \mathbb{R}$$

$$4. -1 \leq \cos x \leq 1, \forall x \in \mathbb{R} \Rightarrow 1 - \frac{1}{2}x^2 \leq 1, \forall x \in \mathbb{R}$$

$$5. c(x) = \cos x$$

$$6. 1 - \frac{1}{2}x^2 \leq \cos x \leq 1$$

$$7. \lim_{x \rightarrow 0} \left( 1 - \frac{1}{2}x^2 \right) = 1$$

$$8. \sup \left( 1 - \frac{1}{2}x^2 \right) = 1$$

$1 - \frac{1}{2}x^2 = 0 \quad x = 0 \Rightarrow 1 - \frac{1}{2}(0)^2 = 1$ $\frac{1}{2}x^2 = 1 \quad x > 0 \Rightarrow 0 < x < \sqrt{2} \text{ sehingga } 1 - \frac{1}{2}x^2 > 0$ $x^2 = 2 \quad \Rightarrow x = \sqrt{2} \text{ sehingga } 1 - \frac{1}{2}x^2 = 0$ $x = \sqrt{2} \quad \Rightarrow x > \sqrt{2} \text{ sehingga } 1 - \frac{1}{2}x^2 < 0$ $x < 0 \Rightarrow -\sqrt{2} < x < 0 \text{ sehingga } 1 - \frac{1}{2}x^2 > 0$ $\Rightarrow x = \sqrt{2} \text{ sehingga } 1 - \frac{1}{2}x^2 = 0$ $\Rightarrow x < -\sqrt{2} \text{ sehingga } 1 - \frac{1}{2}x^2 < 0$ <p>Misalkan <math>c(x) = \cos x</math>, maka <math>1 - \frac{1}{2}x^2 \leq \cos x \leq 1</math>.</p> <p>Karena <math>\lim_{x \rightarrow 0} \left(1 - \frac{1}{2}x^2\right) = 1</math>, <math>\sup \left(1 - \frac{1}{2}x^2\right) = 1</math> akibatnya <math>1 \leq \cos x \leq 1</math>. Maka <math>\lim_{x \rightarrow 0} 1 \leq \lim_{x \rightarrow 0} \cos x \leq \lim_{x \rightarrow 0} 1</math> sehingga <math>1 \leq \lim_{x \rightarrow 0} \cos x \leq 1</math>.</p> <p>Jadi, berdasarkan Teorema Apit bahwa <math>\lim_{x \rightarrow 0} \cos x = 1</math>. ■</p>	<p>9. <math>1 \leq \cos x \leq 1</math></p> <p>10. <math>\lim_{x \rightarrow 0} 1 \leq \lim_{x \rightarrow 0} \cos x \leq \lim_{x \rightarrow 0} 1</math></p> <p>11. <math>1 \leq \lim_{x \rightarrow 0} \cos x \leq 1</math></p> <p>12. <math>\lim_{x \rightarrow 0} \cos x = 1</math></p>
<p><b>Alternatif Jawaban dari C. 4.2.8 (d)</b></p> <p><math>\lim_{x \rightarrow 0} \left(\frac{\cos x - 1}{x}\right) = 0 \rightarrow</math> Bukti?</p> <p><b>Bukti:</b></p> <p>Misalkan <math>c(x) = (\cos x - 1) / x</math>.</p> <p><math>f(x) := -x / 2, x \geq 0</math> dan <math>f(x) := 0, x &lt; 0</math>, dan <math>h(x) := 0, x \geq 0</math> dan <math>h(x) := -x / 2, x &lt; 0</math>.</p>	<p><b>Poin Penting dari C. 4.2.8 (d)</b></p> <ol style="list-style-type: none"> <li>1. <math>c(x) = (\cos x - 1) / x</math></li> <li>2. <math>f(x) := -x / 2, x \geq 0</math></li> <li>3. <math>f(x) := 0, x &lt; 0</math></li> <li>4. <math>h(x) := 0, x \geq 0</math></li> <li>5. <math>h(x) := -x / 2, x &lt; 0</math></li> <li>6. <math>f(x) \leq c(x) \leq h(x) \Rightarrow (-x / 2) \leq c(x) \leq 0</math>, untuk</li> </ol>

Karena $f(x) \leq c(x) \leq h(x) \Rightarrow (-x/2) \leq c(x) \leq 0$ , untuk $x > 0$ . Sehingga $\lim_{x \rightarrow 0} f = 0 = \lim_{x \rightarrow 0} h$ . Jadi, berdasarkan Teorema Apit bahwa $\lim_{x \rightarrow 0} (\cos x - 1) / x = 0$ . ■	$x > 0$ 7. $\lim_{x \rightarrow 0} f = 0 = \lim_{x \rightarrow 0} h$ 8. $\lim_{x \rightarrow 0} (\cos x - 1) / x = 0$
---	---

$$(e) \lim_{x \rightarrow 0} \left( \frac{\sin x}{x} \right) = 1$$

Again we cannot use Theorem 4.2.4 (b) to evaluate this limit. However, it will be proved later (see Theorem 8.4.8) that

$$x - \frac{1}{6}x^3 \leq \sin x \leq x \text{ for } x \geq 0$$

And that

$$x \leq \sin x \leq x - \frac{1}{6}x^3 \text{ for } x \leq 0$$

Therefore it follows (why?) that

$$1 - \frac{1}{6}x^2 \leq \frac{\sin x}{x} \leq 1 \text{ for all } x \neq 0$$

But since  $\lim_{x \rightarrow 0} \left( 1 - \frac{1}{6}x^2 \right) = 1 - \frac{1}{6} \lim_{x \rightarrow 0} x^2 = 1$ , we infer from the Squeeze Theorem that  $\lim_{x \rightarrow 0} \left( \frac{\sin x}{x} \right) = 1$ .

$$(e) \lim_{x \rightarrow 0} \left( \frac{\sin x}{x} \right) = 1$$

Lagi kita tidak dapat menggunakan Teorema 4.2.4 (b) untuk menghitung limit ini. Akan tetapi dapat dibuktikan nanti (lihat Teorema 4.8.8) bahwa

$$x - \frac{1}{6}x^3 \leq \sin x \leq x \text{ untuk } x \geq 0$$

Dan bahwa

$$x \leq \sin x \leq x - \frac{1}{6}x^3 \text{ untuk } x \leq 0$$

Oleh karena itu mengikuti (mengapa?) bahwa

$$1 - \frac{1}{6}x^2 \leq \frac{\sin x}{x} \leq 1 \text{ untuk semua } x \neq 0$$

Tetapi karena  $\lim_{x \rightarrow 0} \left( 1 - \frac{1}{6}x^2 \right) = 1 - \frac{1}{6} \lim_{x \rightarrow 0} x^2 = 1$ , kita simpulkan dari Teorema Apit bahwa  $\lim_{x \rightarrow 0} \left( \frac{\sin x}{x} \right) = 1$ .

#### Alternatif Jawaban dari C. 4.2.8 (e)

$$\lim_{x \rightarrow 0} \left( \frac{\sin x}{x} \right) = 1 \rightarrow \text{Bukti?}$$

#### Bukti:

Tidak bisa menggunakan teorema 4.2.4 (b).

Pembuktian nanti di teorema 8.4.8 bahwa

$$x - \frac{1}{6}x^3 \leq \sin x \leq x \text{ untuk } x \geq 0$$

dan

$$x \leq \sin x \leq x - \frac{1}{6}x^3 \text{ untuk } x \leq 0$$

Karena

#### Poin penting dari C. 4.2.8 (e)

1.  $x - \frac{1}{6}x^3 \leq \sin x \leq x$  untuk  $x \geq 0$  dari teorema 8.4.8.
2.  $1 - \frac{1}{6}x^2 \leq \frac{\sin x}{x} \leq 1$  untuk semua  $x \neq 0$ .
3.  $\lim_{x \rightarrow 0} \left( 1 - \frac{1}{6}x^2 \right) \leq \lim_{x \rightarrow 0} \left( \frac{\sin x}{x} \right) \leq \lim_{x \rightarrow 0} 1$ .
4.  $1 \leq \lim_{x \rightarrow 0} \left( \frac{\sin x}{x} \right) \leq 1$ .
5. dari teorema apit maka  $\lim_{x \rightarrow 0} \left( \frac{\sin x}{x} \right) = 1$  (terbukti).

$$x - \frac{1}{6}x^3 \leq x$$

$$\Leftrightarrow -\frac{1}{6}x^3 \leq 0$$

$$\Leftrightarrow x \geq 0$$

Dan

$$x \leq x - \frac{1}{6}x^3$$

$$\Leftrightarrow 0 \leq -\frac{1}{6}x^3$$

$$\Leftrightarrow 0 \geq x^3$$

Maka boleh pilih salah satu

$$x - \frac{1}{6}x^3 \leq \sin x \leq x \text{ untuk } x \geq 0$$

$$\Leftrightarrow x \left(1 - \frac{1}{6}x^2\right) \leq \sin x \leq x \text{ untuk } x \geq 0$$

$$\Leftrightarrow 1 - \frac{1}{6}x^2 \leq \frac{\sin x}{x} \leq 1 \text{ untuk semua } x \neq 0$$

$$\Leftrightarrow \lim_{x \rightarrow 0} \left(1 - \frac{1}{6}x^2\right) \leq \lim_{x \rightarrow 0} \left(\frac{\sin x}{x}\right) \leq \lim_{x \rightarrow 0} 1$$

$$\Leftrightarrow 1 - \frac{1}{6} \lim_{x \rightarrow 0} x^2 \leq \lim_{x \rightarrow 0} \left(\frac{\sin x}{x}\right) \leq 1$$

$$\Leftrightarrow 1 \leq \lim_{x \rightarrow 0} \left(\frac{\sin x}{x}\right) \leq 1$$

Karena  $1 \leq \lim_{x \rightarrow 0} \left(\frac{\sin x}{x}\right) \leq 1$  sehingga berdasarkan theorem

apit didapat  $\lim_{x \rightarrow 0} \left(\frac{\sin x}{x}\right) = 1$ .

Jadi,  $\lim_{x \rightarrow 0} \left(\frac{\sin x}{x}\right) = 1$  (Terbukti).

**4.2.9 Theorem** Let  $A \subseteq \mathbb{R}$ , let  $f: A \rightarrow \mathbb{R}$  and let  $c \in \mathbb{R}$  be a cluster point of  $A$ . If  $\lim_{x \rightarrow c} f > 0$  [respectively,  $\lim_{x \rightarrow c} f < 0$ ], then there exist a neighborhood  $V_\delta(c)$  of  $c$  such that  $f(x) > 0$  [respectively,  $f(x) < 0$ ] for all  $x \in A \cap V_\delta(c)$ ,  $x \neq c$ .

**Proof**

Let  $L := \lim_{x \rightarrow c} f$  and suppose that  $L > 0$ . We take  $\varepsilon = \frac{1}{2}L > 0$  in Definition 4.1.4, and obtain a number  $\delta > 0$  such that if  $0 < |x - c| < \delta$  and  $x \in A$ , then  $|f(x) - L| < \frac{1}{2}L$ . Therefore (why?) it follows that if  $x \in A \cap V_\delta(c)$ ,  $x \neq c$ , then  $f(x) > \frac{1}{2}L > 0$ .

If  $f < 0$ , a similar arguments applies.

**Teorema 4.2.9** Misalkan  $A \subseteq \mathbb{R}$ ,  $f: A \rightarrow \mathbb{R}$  dan  $c \in \mathbb{R}$  suatu titik kumpul dari  $A$ . Jika  $\lim_{x \rightarrow c} f > 0$  [atau,  $\lim_{x \rightarrow c} f < 0$ ], maka terdapat suatu persekitaran  $V_\delta(c)$  sedemikian sehingga  $f(x) > 0$  [atau,  $f(x) < 0$ ] untuk semua  $x \in A \cap V_\delta(c)$ ,  $x \neq c$ .

**Bukti**

Misalkan  $L := \lim_{x \rightarrow c} f$  dan anggaplah  $L > 0$ . Kita ambil  $\varepsilon = \frac{1}{2}L > 0$  dalam Definisi 4.1.4, dan diperoleh suatu bilangan  $\delta > 0$  sedemikian sehingga jika  $0 < |x - c| < \delta$  dan  $x \in A$ , maka  $|f(x) - L| < \frac{1}{2}L$ . oleh karena itu (mengapa?) berarti bahwa jika  $x \in A \cap V_\delta(c)$ ,  $x \neq c$ , maka  $f(x) > \frac{1}{2}L > 0$ .

Jika  $f < 0$ , dapat digunakan argumen serupa.

<p><b>Notasi Matematika dari T. 4.2.9</b>  <math>A \subseteq \mathbb{R}</math>, <math>f: A \rightarrow \mathbb{R}</math> dan <math>c \in \mathbb{R}</math> titik kumpul <math>A</math>.                  Lalu <math>\lim_{x \rightarrow c} f &gt; 0</math> [atau, <math>\lim_{x \rightarrow c} f &lt; 0</math>] <math>\Rightarrow \exists V_\delta(c) \ni f(x) &gt; 0</math> [atau, <math>f(x) &lt; 0</math>] <math>\forall x \in A \cap V_\delta(c)</math>, <math>x \neq c</math>.</p>	<p><b>Kontrapositif dari T. 4.2.9</b>  <math>A \subseteq \mathbb{R}</math>, <math>f: A \rightarrow \mathbb{R}</math> dan <math>c \in \mathbb{R}</math> bukan titik kumpul <math>A</math>.  <math>\forall V_\delta(c) \ni f(x) &gt; 0</math> [atau, <math>f(x) &lt; 0</math>], <math>\exists x \in A \cap V_\delta(c)</math>, <math>x = c \Rightarrow</math> lalu <math>\nexists \lim_{x \rightarrow c} f &gt; 0</math> [atau, <math>\lim_{x \rightarrow c} f &lt; 0</math>].</p>
<p><b>Poin Penting dari T. 4.2.9</b></p> <ol style="list-style-type: none"> <li><math>A \subseteq \mathbb{R}</math></li> <li><math>f: A \rightarrow \mathbb{R}</math></li> <li><math>c \in \mathbb{R}</math> titik kumpul <math>A</math></li> <li><math>\lim_{x \rightarrow c} f &gt; 0</math> [atau, <math>\lim_{x \rightarrow c} f &lt; 0</math>]</li> <li><math>\exists V_\delta(c) \ni f(x) &gt; 0</math> [atau, <math>f(x) &lt; 0</math>]</li> <li><math>\forall x \in A \cap V_\delta(c)</math></li> <li><math>x \neq c</math></li> </ol>	<p><b>Poin Penting dari Kontrapositif T. 4.2.9</b></p> <ol style="list-style-type: none"> <li><math>A \subseteq \mathbb{R}</math></li> <li><math>f: A \rightarrow \mathbb{R}</math></li> <li><math>c \in \mathbb{R}</math> bukan titik kumpul <math>A</math></li> <li><math>\forall V_\delta(c) \ni f(x) &gt; 0</math> [atau, <math>f(x) &lt; 0</math>]</li> <li><math>\exists \forall x \in A \cap V_\delta(c)</math></li> <li><math>x = c</math></li> <li><math>\nexists \lim_{x \rightarrow c} f &gt; 0</math> [atau, <math>\lim_{x \rightarrow c} f &lt; 0</math>]</li> </ol>



## Exercises for Section 4.2

## Exercise for Section 4.2

- Apply Theorem 4.2.4 to determine the following limits:
  - $\lim_{x \rightarrow 1} (x + 1)(2x + 3)$  ( $x \in \mathbb{R}$ ),
  - $\lim_{x \rightarrow 1} \frac{x^2 + 2}{x^2 - 2}$  ( $x > 0$ ),
  - $\lim_{x \rightarrow 2} \left( \frac{1}{x+1} - \frac{1}{2x} \right)$  ( $x > 0$ ),
  - $\lim_{x \rightarrow 0} \frac{x+1}{x^2+2}$  ( $x \in \mathbb{R}$ ).
- Determine the following limits and state which theorems are used in each case. (You may wish to use Exercise 15 below.)
  - $\lim_{x \rightarrow 2} \sqrt{\frac{2x+1}{x+3}}$  ( $x > 0$ ),
  - $\lim_{x \rightarrow 2} \frac{x^2-4}{x-2}$  ( $x > 0$ ),
  - $\lim_{x \rightarrow 0} \frac{(x+1)^2-1}{x}$  ( $x > 0$ ),
  - $\lim_{x \rightarrow 1} \frac{\sqrt{x}-1}{x-1}$  ( $x > 0$ ).
- Find  $\lim_{x \rightarrow 0} \frac{\sqrt{1+2x}-\sqrt{1+3x}}{x+2x^2}$  where  $x > 0$ .
- Prove that  $\lim_{x \rightarrow 0} \cos(1/x)$  does not exist but that  $\lim_{x \rightarrow 0} \cos(1/x) = 0$ .
- Let  $f, g$  be defined on  $A \subseteq \mathbb{R}$  to  $\mathbb{R}$ , and let  $c$  be a cluster point of  $A$ . Suppose that  $f$  is bounded on a neighborhood of  $c$  and that  $\lim_{x \rightarrow c} g = 0$ . Prove that  $\lim_{x \rightarrow c} fg = 0$ .
- Use the definition of the limit to prove the first assertion in Theorem 4.2.4 (a).
- Use the sequential formulation of the limit to prove Theorem 4.2.4 (b).
- Let  $n \in \mathbb{N}$  be such that  $n \geq 3$ . Derive the inequality  $-x^2 \leq$

## Latihan untuk Bagian 4.2

- Gunakan Teorema 4.2.4 untuk menentukan limit-limit berikut:
  - $\lim_{x \rightarrow 1} (x + 1)(2x + 3)$  ( $x \in \mathbb{R}$ ),
  - $\lim_{x \rightarrow 1} \frac{x^2 + 2}{x^2 - 2}$  ( $x > 0$ ),
  - $\lim_{x \rightarrow 2} \left( \frac{1}{x+1} - \frac{1}{2x} \right)$  ( $x > 0$ ),
  - $\lim_{x \rightarrow 0} \frac{x+1}{x^2+2}$  ( $x \in \mathbb{R}$ ).
- Tentukan limit-limit berikut dan nyatakan teorema mana yang digunakan dalam setiap kasus. (Kamu boleh menggunakan Latihan 15.)
  - $\lim_{x \rightarrow 2} \sqrt{\frac{2x+1}{x+3}}$  ( $x > 0$ ),
  - $\lim_{x \rightarrow 2} \frac{x^2-4}{x-2}$  ( $x > 0$ ),
  - $\lim_{x \rightarrow 0} \frac{(x+1)^2-1}{x}$  ( $x > 0$ ),
  - $\lim_{x \rightarrow 1} \frac{\sqrt{x}-1}{x-1}$  ( $x > 0$ ).
- Carilah  $\lim_{x \rightarrow 0} \frac{\sqrt{1+2x}-\sqrt{1+3x}}{x+2x^2}$  dimana  $x > 0$ .
- Buktikan bahwa  $\lim_{x \rightarrow 0} \cos(1/x)$  tidak ada tetapi  $\lim_{x \rightarrow 0} \cos(1/x) = 0$ .
- Misalkan  $f, g$  didefinisikan pada  $A \subseteq \mathbb{R}$  ke  $\mathbb{R}$ , dan misalkan  $c$  menjadi titik kumpul dari  $A$ . Anggaplah bahwa  $f$  terbatas pada lingkungan dari  $c$  dan  $\lim_{x \rightarrow c} g = 0$ . Buktikan bahwa  $\lim_{x \rightarrow c} fg = 0$ .
- Gunakan definisi limit untuk membuktikan pernyataan pertama dalam Teorema 4.2.4 (a).
- Gunakan rumus barisan limit untuk membuktikan Teorema 4.2.4 (b).

$$x^n \leq x^2$$

for  $-1 < x < 1$ . Then use the fact that  $\lim_{x \rightarrow 0} x^2 = 0$  to show that  $\lim_{x \rightarrow 0} x^n = 0$ .

9. Let  $f, g$  be defined on  $A$  to  $\mathbb{R}$  and let  $c$  be a cluster point of  $A$ .
  - (a) Show that if both  $\lim_{x \rightarrow c} f$  and  $\lim_{x \rightarrow c} (f + g)$  exist. Then  $\lim_{x \rightarrow c} g$  exists.
  - (b) If  $\lim_{x \rightarrow c} f$  and  $\lim_{x \rightarrow c} fg$  exist, does it follow that  $\lim_{x \rightarrow c} g$  exists?
10. Give examples functions  $f$  and  $g$  such that  $f$  and  $g$  do not have limits at a point  $c$ , but such that both  $f + g$  and  $fg$  have limits at  $c$ .
11. Determine whether the following limits exist in  $\mathbb{R}$ .
  - (a)  $\lim_{x \rightarrow 0} \sin\left(\frac{1}{x^2}\right)$  ( $x \neq 0$ ),
  - (b)  $\lim_{x \rightarrow 0} x \sin\left(\frac{1}{x^2}\right)$  ( $x \neq 0$ ),
  - (c)  $\lim_{x \rightarrow 0} \operatorname{sgn} \sin\left(\frac{1}{x}\right)$  ( $x \neq 0$ ),
  - (d)  $\lim_{x \rightarrow 0} \sqrt{x} \sin\left(\frac{1}{x^2}\right)$  ( $x > 0$ ).
12. Let  $f : \mathbb{R} \rightarrow \mathbb{R}$  be such that  $f(x + y) = f(x) + f(y)$  for all  $x, y$  in  $\mathbb{R}$ . Assume that  $\lim_{x \rightarrow 0} f = L$  exists. Prove that  $L = 0$ , and then prove that  $f$  has a limit at every point  $c \in \mathbb{R}$ . [*Hint*: First note that  $f(2x) = f(x) + f(x)$  for  $x \in \mathbb{R}$ . Also note that  $f(x) = f(x - c) + f(c)$  for  $x, c$  in  $\mathbb{R}$ .]
13. Function  $f$  and  $g$  are defined on  $\mathbb{R}$  by  $f(x) := x + 1$  and  $g(x) := 2$  if  $x \neq 1$  and  $g(1) := 0$ .
  - (a) Find  $\lim_{x \rightarrow 1} g(f(x))$  and compare with the value of  $g(\lim_{x \rightarrow 1} f(x))$ .
  - (b) Find  $\lim_{x \rightarrow 1} f(g(x))$  and compare with the value of  $f(\lim_{x \rightarrow 1} g(x))$ .
14. Let  $A \subseteq \mathbb{R}$ , let  $f : A \rightarrow \mathbb{R}$  and let  $c \in \mathbb{R}$  be a cluster point of  $A$ . If  $\lim_{x \rightarrow c} f$  exist, and if  $|f|$  denotes the function defined
  8. Misalkan  $n \in \mathbb{N}$  sedemikian sehingga  $n \geq 3$ . Buktikan ketaksamaan  $-x^2 \leq x^n \leq x^2$  untuk  $-1 < x < 1$ . Kemudian gunakan fakta bahwa  $\lim_{x \rightarrow 0} x^2 = 0$  untuk menunjukkan bahwa  $\lim_{x \rightarrow 0} x^n = 0$ .
  9. Misalkan  $f, g$  didefinisikan pada  $A$  ke  $\mathbb{R}$  dan  $c$  menjadi titik kumpul  $A$ .
    - (a) Tunjukkan bahwa jika keduanya  $\lim_{x \rightarrow c} f$  dan  $\lim_{x \rightarrow c} (f + g)$  ada. Kemudian  $\lim_{x \rightarrow c} g$  ada.
    - (b) Jika  $\lim_{x \rightarrow c} f$  dan  $\lim_{x \rightarrow c} fg$  ada, apakah  $\lim_{x \rightarrow c} g$  juga ada?
  10. Berikan contoh fungsi-fungsi  $c$  sedemikian sehingga  $f$  and  $g$  tidak mempunyai limit pada titik, tetapi sedemikian sehingga keduanya  $f + g$  dan  $fg$  mempunyai limit pada  $c$ .
  11. Tentukan apakah limit-limit berikut ada dalam  $\mathbb{R}$ .
    - (a)  $\lim_{x \rightarrow 0} \sin\left(\frac{1}{x^2}\right)$  ( $x \neq 0$ ),
    - (b)  $\lim_{x \rightarrow 0} x \sin\left(\frac{1}{x^2}\right)$  ( $x \neq 0$ ),
    - (c)  $\lim_{x \rightarrow 0} \operatorname{sgn} \sin\left(\frac{1}{x}\right)$  ( $x \neq 0$ ),
    - (d)  $\lim_{x \rightarrow 0} \sqrt{x} \sin\left(\frac{1}{x^2}\right)$  ( $x > 0$ ).
  12. Misalkan  $f : \mathbb{R} \rightarrow \mathbb{R}$  sedemikian sehingga  $f(x + y) = f(x) + f(y)$  untuk semua  $x, y$  dalam  $\mathbb{R}$ . Anggaplah bahwa  $\lim_{x \rightarrow 0} f = L$  ada. buktikan bahwa  $L = 0$ , dan kemudian buktikan bahwa  $f$  mempunyai suatu limit pada setiap titik  $c \in \mathbb{R}$ . [*Petunjuk*: Pertama-tama catat bahwa  $f(2x) = f(x) + f(x)$  untuk  $x \in \mathbb{R}$ . Juga perhatikan bahwa  $f(x) = f(x - c) + f(c)$  untuk  $x, c$  dalam  $\mathbb{R}$ .]
  13. Fungsi  $f$  dan  $g$  didefinisikan pada  $R$  untuk  $f(x) := x + 1$  dan  $g(x) := 2$  jika  $x \neq 1$  dan  $g(1) := 0$ .
    - (a) Cari  $\lim_{x \rightarrow 1} g(f(x))$  dan bandingkan dengan nilai  $g(\lim_{x \rightarrow 1} f(x))$ .
    - (b) Cari  $\lim_{x \rightarrow 1} f(g(x))$  dan bandingkan dengan nilai

## 4.2 Limits Theorem

for  $x \in A$  by  $|f|(x) := |f(x)|$ ,

prove that  $\lim_{x \rightarrow c} |f| = |\lim_{x \rightarrow c} f|$ .

15. Let  $A \subseteq \mathbb{R}$ , let  $f : A \rightarrow \mathbb{R}$ , and let  $c \in \mathbb{R}$  be a cluster point of  $A$ . In addition, suppose that  $f(x) \geq 0$  for all  $x \in A$ , and let  $\sqrt{f}$  be the function defined for  $x \in A$  by  $(\sqrt{f})(x) := \sqrt{f(x)}$ . If  $\lim_{x \rightarrow c} f$  exist, prove that  $\lim_{x \rightarrow c} \sqrt{f} = \sqrt{\lim_{x \rightarrow c} f}$ .

## 4.2 Teorema Limit

$f(\lim_{x \rightarrow 1} g(x))$ .

14. Misalkan  $A \subseteq \mathbb{R}$ ,  $f : A \rightarrow \mathbb{R}$  dan  $c \in \mathbb{R}$  suatu titik kumpul dari  $A$ . Jika  $\lim_{x \rightarrow c} f$  ada, dan jika  $|f|$  menyatakan fungsi yang terdefinisi untuk  $x \in A$  dengan  $|f|(x) := |f(x)|$ , buktikan bahwa  $\lim_{x \rightarrow c} |f| = |\lim_{x \rightarrow c} f|$ .
15. Misalkan  $A \subseteq \mathbb{R}$ ,  $f : A \rightarrow \mathbb{R}$ , dan  $c \in \mathbb{R}$  suatu titik kumpul dari  $A$ . Tambahan, anggaplah bahwa  $f(x) \geq 0$  untuk semua  $x \in A$ , dan misalkan  $\sqrt{f}$  suatu fungsi yang terdefinisi untuk  $x \in A$  dengan  $(\sqrt{f})(x) := \sqrt{f(x)}$ . Jika  $\lim_{x \rightarrow c} f$  ada, buktikan bahwa  $\lim_{x \rightarrow c} \sqrt{f} = \sqrt{\lim_{x \rightarrow c} f}$ .

**Section 4.3 Some Extensions of the Limit Concept**

In this section, we shall present three types of extensions of the notion of a limit of a function that often occur. Since all the ideas here are closely parallel to ones we have already encountered, this section can be read easily.

**One-Sides Limits**

There are times when a function  $f$  may not possess a limit at a point  $c$ , yet a limit does exist when the function is restricted to an interval on one side of the cluster point  $c$ .

For example, the signum function considered in example 4. 1. 10(b), and illustrated in figure 4. 1. 2, has no limit at  $c = 0$ . However, if we restrict the signum function the interval  $(0, \infty)$ , the resulting function has a limit of 1 at  $c = 0$ . Similarly, if we restrict the signum function the interval  $(-\infty, 0)$ , the resulting function has a limit of  $-1$  at  $c = 0$ . these are elementary examples of right-hand and left-hand limits at  $c = 0$ .

**4.3.1 Definition** Let  $A \in \mathbb{R}$  and let  $f : A \rightarrow \mathbb{R}$ .

- (i) If  $c \in \mathbb{R}$  is a cluster point of the set  $A \cap (c, \infty) = \{x \in A : x > c\}$ , then we say that  $L \in \mathbb{R}$  is a **right-hand limit of  $f$  at  $c$**  and we write

$$\lim_{x \rightarrow c^+} f = L \text{ or } \lim_{x \rightarrow c^+} f(x) = L$$

If given any  $\varepsilon > 0$  there exists a  $\delta = \delta(\varepsilon) > 0$  such that for

**Bagian 4.3 Beberapa Ekstensi dari Konsep Limit**

Pada bagian ini, kami akan menyajikan ekstensi dari pengertian batas fungsi limit yang sering terjadi. Karena ide disini sangat mirip dengan yang telah kita temui, bagian ini dapat di baca dengan mudah.

**Limit-limit Sepihak**

Ada kalanya fungsi  $f$  mungkin tidak memiliki batas pada titik  $c$ , namun batasnya ada apabila fungsi dibatasi pada interval di satu sisi pada titik kumpul  $c$ .

Sebagai contoh, fungsi signum yang dipertimbangkan pada contoh 4.1.10 (b), dan diilustrasikan pada gambar 4.1.2, tidak memiliki batas pada  $c = 0$ . Namun, jika kita membatasi fungsi signum ke interval  $(0, \infty)$ , fungsi yang dihasilkan memiliki batas 1 pada  $c = 0$ . Demikian pula, jika kita membatasi fungsi signum ke interval  $(-\infty, 0)$ , fungsi yang dihasilkan memiliki batas  $-1$  pada  $c = 0$ . Ini adalah contoh dasar dari batas kanan dan kiri pada  $c = 0$

**Definisi 4.3.1** Diberikan  $A \in \mathbb{R}$  jika  $f : A \rightarrow \mathbb{R}$ .

- (i) Jika  $c \in \mathbb{R}$  adalah titik kumpul dari  $A \cap (c, \infty) = \{x \in A : x > c\}$ , maka kita katakan bahwa  $L \in \mathbb{R}$  adalah limit kanan di  $c$  dan kita tulis

$$\lim_{x \rightarrow c^+} f = L \text{ or } \lim_{x \rightarrow c^+} f(x) = L$$

### 4.3 Some Extension of the Limit Concept

all  $x \in A$  with  $0 < x - c < \delta$ , then  $|f(x) - L| < \varepsilon$

- (ii) If  $c \in \mathbb{R}$  is a cluster point of the set  $A \cap (-\infty, 0) = \{x \in A : x > c\}$ , then we say that  $L \in \mathbb{R}$  is a **left-hand limit of  $f$  at  $c$**  and we write

$$\lim_{x \rightarrow c^-} f = L \text{ or } \lim_{x \rightarrow c^-} f(x) = L$$

If given any  $\varepsilon > 0$  there exists a  $\delta > 0$  such that for all  $x \in A$  with  $0 < c - x < \delta$ , then  $|f(x) - L| < \varepsilon$ .

**Notes** (1) The limits  $\lim_{x \rightarrow c^+} f$  and  $\lim_{x \rightarrow c^-} f$  are **called one-sided limits of  $f$  at  $c$** . It is possible that neither one-sided limits may exist. Also, one of them may exist without the other existing. Similarly, as is the case for  $f(x) := \text{sgn}(x)$  at  $c = 0$ , they may both exist and be different.

(2) If  $A$  is an interval with left endpoint  $c$ , then it is readily seen that  $f : A \rightarrow \mathbb{R}$  has a limit at  $c$  if and only if it has a right-hand limit at  $c$ . Moreover, in this case the limit  $\lim_{x \rightarrow c} f$  and the right-hand limit  $\lim_{x \rightarrow c^+} f$  are equal. (A similar situation occurs for the left-hand limit when  $A$  is an interval with right endpoint  $c$ ). The reader can show that  $f$  can have only one right-hand (respectively, left-hand) limit at a point. There are results analogous to those established in sections 4.1 and 4.2 for two-sided limits. In particular, the existence of one-sided limits can be reduced to sequential considerations.

### 4.3 Beberapa Ekstensi dari Konsep Limit

Jika diberi  $\varepsilon > 0$  terdapat sebuah  $\delta = \delta(\varepsilon) > 0$  sehingga  $x \in A$  dengan  $0 < x - c < \delta$ , maka  $|f(x) - L| < \varepsilon$

- (ii) Jika  $c \in \mathbb{R}$  adalah titik kumpul dari  $A \cap (-\infty, 0) = \{x \in A : x > c\}$ , maka kita katakan bahwa  $L \in \mathbb{R}$  adalah limit kiri di  $c$  dan kita tulis

$$\lim_{x \rightarrow c^-} f = L \text{ or } \lim_{x \rightarrow c^-} f(x) = L$$

Jika diberi  $\varepsilon > 0$  terdapat sebuah  $\delta > 0$  sehingga  $x \in A$  dengan  $0 < c - x < \delta$ , then  $|f(x) - L| < \varepsilon$ .

**Catatan** (1) Limit-limit  $\lim_{x \rightarrow c^+} f$  dan  $\lim_{x \rightarrow c^-} f$  disebut **limit-limit sepihak dari  $f$  pada  $c$** . Ini kemungkinan kedua limit sepihak dimaksud ada. juga mungkin salah satu saja yang ada. Serupa, seperti kasus pada fungsi  $f(x) := \text{sgn}(x)$  pada  $c = 0$ , limit-limit ini ada, meskipun berbeda.

(2) Jika  $A$  suatu interval dengan titik ujung kiri  $c$ , maka jelas nampak  $f : A \rightarrow \mathbb{R}$  mempunyai suatu limit pada  $c$  dan jika salah satu mempunyai suatu limit kanan di  $c$ . Selain itu dalam kasus ini limit  $\lim_{x \rightarrow c} f$  dan limit-limit kanan  $\lim_{x \rightarrow c^+} f$  sama. (situasi serupa akan berlaku untuk limit kiri suatu interval dengan titik ujung kanan adalah  $c$ . limit kanan (masing-masing, limit kiri) membatasi pada suatu titik. Ada hasil yang analog dengan bagian-bagian yang sudah ditetapkan 4.1 dan 4.2 untuk batas-batas kedua sisi. Khususnya, keberadaan batas satu sisi dapat dikurangi menjadi pertimbangan berurutan.

#### **Notasi Matematika dari D. 4.3.1**

$A \in \mathbb{R}$  dan  $f : A \rightarrow \mathbb{R}$ .

- (i)  $C \in \mathbb{R}$  adalah titik kumpul  $A \cap (c, \infty) = \{x \in A : x > c\} \rightarrow$

#### **Kontrapotif dari D. 4.3.1**

$A \in \mathbb{R}$  dan  $f : A \rightarrow \mathbb{R}$ .

- (i)  $L \in \mathbb{R}$  bukan limit kanan di  $c \rightarrow C \in \mathbb{R}$  bukan titik kumpul

### 4.3 Some Extension of the Limit Concept

### 4.3 Beberapa Ekstensi dari Konsep Limit

<p><math>L \in \mathbb{R}</math> adalah limit kanan di <math>c</math> dan kita tulis</p> $\lim_{x \rightarrow c^+} f = L \text{ or } \lim_{x \rightarrow c^+} f(x) = L$ <p><math>\varepsilon &gt; 0 \exists \delta = \delta(\varepsilon) &gt; 0 \exists x \in A, 0 &lt; x - c &lt; \delta, \rightarrow  f(x) - L  &lt; \varepsilon</math></p> <p>(ii) <math>C \in \mathbb{R}</math> adalah titik kumpul <math>A \cap (-\infty, 0) = \{x \in A: x &gt; c\} \rightarrow</math>  <math>L \in \mathbb{R}</math> adalah limit kiri di <math>c</math> dan kita tulis</p> $\lim_{x \rightarrow c^-} f = L \text{ or } \lim_{x \rightarrow c^-} f(x) = L$ <p><math>\varepsilon &gt; 0 \exists \delta &gt; 0 \exists x \in A, 0 &lt; c - x &lt; \delta \rightarrow  f(x) - L  &lt; \varepsilon.</math></p>	<p><math>A \cap (c, \infty) = \{x \in A: x &gt; c\}</math> dan kita tulis</p> $\lim_{x \rightarrow c^+} f \neq L \text{ or } \lim_{x \rightarrow c^+} f(x) \neq L$ <p><math>\varepsilon &gt; 0 \forall \delta \neq \delta(\varepsilon) &gt; 0 \exists x \in A, 0 &lt; x - c &lt; \delta, \rightarrow  f(x) - L  &lt; \varepsilon</math></p> <p>(ii) <math>L \in \mathbb{R}</math> bukan limit kiri di <math>c \rightarrow C \in \mathbb{R}</math> bukan titik kumpul  <math>A \cap (-\infty, 0) = \{x \in A: x &gt; c\}</math> dan kita tulis</p> $\lim_{x \rightarrow c^-} f \neq L \text{ or } \lim_{x \rightarrow c^-} f(x) \neq L$ <p><math>\varepsilon &gt; 0 \forall \delta &gt; 0 \exists x \in A, 0 &lt; c - x &lt; \delta \rightarrow  f(x) - L  &lt; \varepsilon.</math></p>
---	--

<b><u>Poin Penting dari D. 4.1.9</u></b>	<b><u>Poin Penting dari Kontrapositif D. 4.1.9</u></b>
<ol style="list-style-type: none"> <li>(1) <math>A \in \mathbb{R}</math></li> <li>(2) <math>f : A \rightarrow \mathbb{R}</math></li> <li>(3) <math>C \in \mathbb{R}</math> adalah titik kumpul <math>A \cap (c, \infty) = \{x \in A : x &gt; c\}</math></li> <li>(4) <math>L \in \mathbb{R}</math> adalah limit kanan di <math>c</math></li> <li>(5) <math>\lim_{x \rightarrow c^+} f = L</math></li> <li>(6) <math>\lim_{x \rightarrow c^+} f(x) = L</math></li> <li>(7) <math>\varepsilon &gt; 0</math></li> <li>(8) <math>\exists \delta = \delta(\varepsilon) &gt; 0 \exists x \in A</math></li> <li>(9) <math>0 &lt; x - c &lt; \delta</math></li> <li>(10) <math> f(x) - L  &lt; \varepsilon</math></li> <li>(11) <math>C \in \mathbb{R}</math> adalah titik kumpul <math>A \cap (-\infty, 0) = \{x \in A : x &gt; c\}</math></li> <li>(12) <math>L \in \mathbb{R}</math> adalah limit kiri di <math>c</math></li> <li>(13) <math>\lim_{x \rightarrow c^-} f = L</math></li> <li>(14) <math>\lim_{x \rightarrow c^-} f(x) = L</math></li> <li>(15) <math>\varepsilon &gt; 0 \exists \delta &gt; 0 \exists x \in A,</math></li> <li>(16) <math>0 &lt; c - x &lt; \delta</math></li> </ol>	<ol style="list-style-type: none"> <li>(1) <math>A \in \mathbb{R}</math></li> <li>(2) <math>f : A \rightarrow \mathbb{R}</math></li> <li>(3) <math>L \in \mathbb{R}</math> bukan limit kanan di <math>c</math></li> <li>(4) <math>C \in \mathbb{R}</math> bukan titik kumpul <math>A \cap (c, \infty) = \{x \in A : x &gt; c\}</math></li> <li>(5) <math>\lim_{x \rightarrow c^+} f \neq L</math></li> <li>(6) <math>\lim_{x \rightarrow c^+} f(x) \neq L</math></li> <li>(7) <math>\varepsilon &gt; 0</math></li> <li>(8) <math>\forall \delta \neq \delta(\varepsilon) &gt; 0 \exists x \in A</math></li> <li>(9) <math>0 &lt; x - c &lt; \delta</math></li> <li>(10) <math> f(x) - L  &lt; \varepsilon</math></li> <li>(11) <math>L \in \mathbb{R}</math> bukan limit kiri di <math>c</math></li> <li>(12) <math>C \in \mathbb{R}</math> bukan titik kumpul <math>A \cap (-\infty, 0) = \{x \in A : x &gt; c\}</math></li> <li>(13) <math>\lim_{x \rightarrow c^-} f \neq L</math></li> <li>(14) <math>\lim_{x \rightarrow c^-} f(x) \neq L</math></li> <li>(15) <math>\varepsilon &gt; 0 \forall \delta &gt; 0 \exists x \in A,</math></li> <li>(16) <math>0 &lt; c - x &lt; \delta</math></li> </ol>

**4.3.2 Theorem** *Let  $A \subseteq \mathbb{R}$ , let  $f : A \rightarrow \mathbb{R}$ , and let  $c \in \mathbb{R}$  be a cluster point of  $A \cap (c, \infty)$ . Then the following statements are equiuvalent:*

- (i)  $\lim_{x \rightarrow c^+} f = L.$
- (ii) *For every sequence  $(x_n)$  that converges to  $c$  such that  $x_n \in A$  and  $x_n > c$  for all  $n \in \mathbb{N}$ , the sequence  $(f(x_n))$  converges to  $L.$*

**Teorema 4.3.2** *Misalkan  $A \subseteq \mathbb{R}$ ,  $f : A \rightarrow \mathbb{R}$ , dan  $c \in \mathbb{R}$  menjadi titik kumpul dari  $A \cap (c, \infty)$ . Maka pernyataan-pernyataan berikut adalah equivalen:*

- (i)  $\lim_{x \rightarrow c^+} f = L.$
- (ii) *Untuk setiap barisan  $(x_n)$  yang konvergen ke  $c$  sedemikian sehingga  $x_n \in A$  dan  $x_n > c$  untuk semua  $n \in \mathbb{N}$ , barisan  $(f(x_n))$  konvergen ke  $L.$*

### 4.3 Some Extension of the Limit Concept

### 4.3 Beberapa Ekstensi dari Konsep Limit

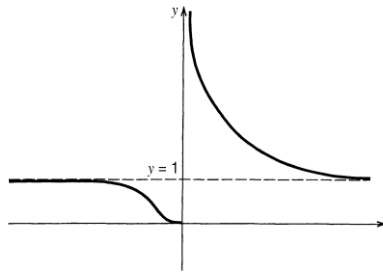

**Figure 4.3.1** Graph of  $g(x) = e^{1/x}$  ( $x \neq 0$ )

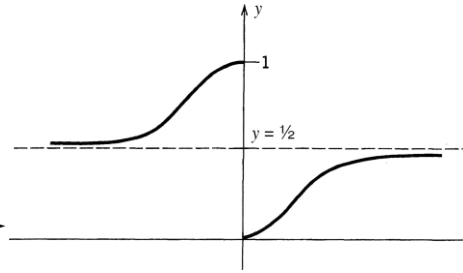

**Figure 4.3.2** Graph of  $h(x) = 1/(e^{1/x} + 1)$  ( $x \neq 0$ )

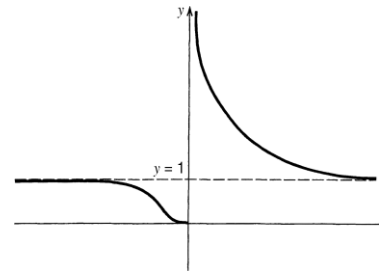

**Gambar 4.3.1** Grafik dari  $g(x) = e^{1/x}$  ( $x \neq 0$ )

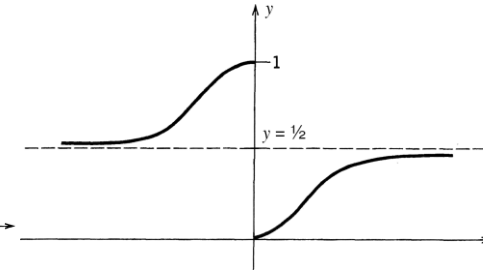

**Gambar 4.3.2** Grafik dari  $h(x) = 1/(e^{1/x} + 1)$  ( $x \neq 0$ )

We leave the proof of this result (and the formulation and proof of the analogous result for left-hand limits) to the reader. We will not take the space to write out the formulations of the one-sided version of the other results in Section 4.1 and 4.2.

The following result relates the notion of the limit of a function to one-sided limits. We leave its proof as an exercise.

Kita meninggalkan bukti hasil ini (dan perumusan dan bukti hasil analogi untuk limit kiri) kepada pembaca. Kita tidak akan mengambil ruang untuk menulis perumusan versi satu sisi dari hasil lain dalam Bagian 4.1 dan 4.2.

Hasil berikut ini berhubungan dengan pengertian limit fungsi ke limit satu sisi. Kita meninggalkan buktinya sebagai latihan.

<p><b>Notasi Matematika dari T. 4.3.2</b>  <math>A \subseteq \mathbb{R}</math>, <math>f : A \rightarrow \mathbb{R}</math>, <math>c \in \mathbb{R}</math> titik kumpul dari <math>A \cap (c, \infty)</math>. Lalu                      (i) <math>\lim_{x \rightarrow c^+} f = L \Leftrightarrow</math> (ii) <math>\forall (x_n) \rightarrow c \exists x_n \in A, x_n &gt; c \forall n \in \mathbb{N}</math>, sehingga <math>(f(x_n)) \rightarrow L</math>.</p>	<p><b>Kontrapositif dari T. 4.3.2</b>  <math>A \subseteq \mathbb{R}</math>, <math>f : A \rightarrow \mathbb{R}</math>, <math>c \in \mathbb{R}</math> bukan titik kumpul dari <math>A \cap (c, \infty)</math>, lalu                      (ii) <math>\exists (x_n) \nrightarrow c \exists x_n \in A, x_n \leq c \exists n \in \mathbb{N}</math>, sehingga <math>(f(x_n)) \nrightarrow L \Leftrightarrow</math> (i) <math>\lim_{x \rightarrow c^+} f \neq L</math>.</p>
<p><b>Poin Penting dari T. 4.3.2</b>                      1) <math>A \subseteq \mathbb{R}</math>                      2) <math>f : A \rightarrow \mathbb{R}</math>                      3) <math>c \in \mathbb{R}</math> titik kumpul dari <math>A \cap (c, \infty)</math>                      4) <math>\lim_{x \rightarrow c^+} f = L</math></p>	<p><b>Poin Penting Kontrapositif dari T. 4.3.2</b>                      1) <math>A \subseteq \mathbb{R}</math>                      2) <math>f : A \rightarrow \mathbb{R}</math>                      3) <math>c \in \mathbb{R}</math> bukan titik kumpul dari <math>A \cap (c, \infty)</math>                      4) <math>\exists (x_n) \nrightarrow c \exists x_n \in A</math></p>



<p>5) <math>\forall (x_n) \rightarrow c \exists x_n \in A</math>          6) <math>x_n &gt; c \forall n \in \mathbb{N}</math>          7) <math>(f(x_n)) \rightarrow L</math></p>	<p>5) <math>x_n \leq c \exists n \in \mathbb{N}</math>          6) <math>(f(x_n)) \nrightarrow L</math>          7) <math>\lim_{x \rightarrow c^+} f \neq L</math></p>
<p><b>Alternatif Bukti dari T. 4.3.2</b>  <math>A \subseteq \mathbb{R}, f : A \rightarrow \mathbb{R}, c \in \mathbb{R}</math> titik kumpul dari <math>A \cap (c, \infty)</math>. Lalu          (i) <math>\lim_{x \rightarrow c^+} f = L</math>          (ii) <math>\forall (x_n) \rightarrow c \exists x_n \in A, x_n &gt; c \forall n \in \mathbb{N}</math>, sehingga <math>(f(x_n)) \rightarrow L</math>.  <math>(i) \equiv (ii) \rightarrow</math> Bukti?  <b>Bukti:</b>  <math>(i) \rightarrow (ii)</math>          Karena <math>\lim_{x \rightarrow c^+} f = L</math>          Berdasarkan D. 4.3.1 maka <math>\forall \varepsilon &gt; 0, \exists \delta = \delta(\varepsilon) &gt; 0 \exists \forall x \in A, x &gt; c</math>.          Ambil sebarang <math>x_n</math> di <math>A, (x_n) \rightarrow c</math> sehingga berdasarkan T. 4.1.8 diperoleh <math>x_n \in A, x_n &gt; c, \forall n \in \mathbb{N}</math> mengakibatkan <math>(f(x_n)) \rightarrow L</math>.          Dengan demikian, <math>\forall (x_n) \rightarrow c \exists x_n \in A, x_n &gt; c \forall n \in \mathbb{N}</math>, sehingga <math>(f(x_n)) \rightarrow L</math>.  <math>(ii) \rightarrow (i)</math>          Ambil sebarang <math>\varepsilon &gt; 0, \exists \delta = \delta(\varepsilon) &gt; 0</math>          Berdasarkan D. 4.1.4 diperoleh <math>0 &lt;  x - c  &lt; \delta</math>          Karena <math>(f(x_n)) \rightarrow L</math> maka <math> f(x) - L  &lt; \varepsilon</math>          Dengan demikian  <math>\forall \varepsilon &gt; 0, \exists \delta = \delta(\varepsilon) &gt; 0 \exists \forall x \in A, 0 &lt; x - c &lt; \delta \Rightarrow  f(x) - L  &lt; \varepsilon</math>          Dan berdasarkan D. 4.3.1 diperoleh <math>\lim_{x \rightarrow c^+} f = L</math>.          Jadi, <math>(i) \equiv (ii)</math>. ■</p>	<p><b>Poin Penting dari T. 4.3.2</b>          1) <math>\lim_{x \rightarrow c^+} f = L</math>          2) <math>\forall \varepsilon &gt; 0, \exists \delta = \delta(\varepsilon) &gt; 0 \exists \forall x \in A, x &gt; c</math>          3) <math>(x_n) \rightarrow c</math>          4) <math>x_n \in A</math>          5) <math>x_n &gt; c</math>          6) <math>\forall n \in \mathbb{N}</math>          7) <math>(f(x_n)) \rightarrow L</math>          8) <math>\forall (x_n) \rightarrow c \exists x_n \in A, x_n &gt; c \forall n \in \mathbb{N}</math>          9) <math>\varepsilon &gt; 0</math>          10) <math>\exists \delta = \delta(\varepsilon) &gt; 0</math>          11) <math>0 &lt;  x - c  &lt; \delta</math>          12) <math> f(x) - L  &lt; \varepsilon</math>          13) <math>\forall \varepsilon &gt; 0, \exists \delta = \delta(\varepsilon) &gt; 0 \exists \forall x \in A, 0 &lt; x - c &lt; \delta \Rightarrow  f(x) - L  &lt; \varepsilon</math></p>

### 4.3 Some Extension of the Limit Concept

### 4.3 Beberapa Ekstensi dari Konsep Limit

**4.3.3 Theorem** Let  $A \subseteq \mathbb{R}$ , let  $f: A \rightarrow \mathbb{R}$ , and let  $c \in \mathbb{R}$  be a cluster point of both of the sets  $A \cap (c, \infty)$  and  $A \cap (-\infty, c)$ . Then  $\lim_{x \rightarrow c} f = L$  if and only if  $\lim_{x \rightarrow c^+} f = L = \lim_{x \rightarrow c^-} f$ .

**Teorema 4.3.3** Misalkan  $A \subseteq \mathbb{R}$ , misal  $f: A \rightarrow \mathbb{R}$ , dan misal  $c \in \mathbb{R}$  adalah titik kumpul dari kedua himpunan  $A \cap (c, \infty)$  dan  $A \cap (-\infty, c)$ . Maka  $\lim_{x \rightarrow c} f = L$  jika dan hanya jika  $\lim_{x \rightarrow c^+} f = L = \lim_{x \rightarrow c^-} f$ .

<p><b>Notasi Matematika dari T. 4.3.3</b>  <math>A \subseteq \mathbb{R}, f: A \rightarrow \mathbb{R}, c \in \mathbb{R}, c</math> titik kumpul, <math>c \in A \cap (c, \infty) \wedge A \cap (-\infty, c) \rightarrow \lim_{x \rightarrow c} f = L \Leftrightarrow \lim_{x \rightarrow c^+} f = L = \lim_{x \rightarrow c^-} f</math>.</p>	<p><b>Kontrapositif Matematika dari T. 4.3.3</b>  <math>A \subseteq \mathbb{R}, f: A \rightarrow \mathbb{R}, c \in \mathbb{R}, c</math> bukan titik kumpul, <math>c \notin A \cup (c, \infty) \vee A \cup (-\infty, c) \rightarrow \lim_{x \rightarrow c} f \neq L \Leftrightarrow \lim_{x \rightarrow c^+} f \neq L \neq \lim_{x \rightarrow c^-} f</math>.</p>
<p><b>Poin Penting dari T. 4.3.3</b></p> <ol style="list-style-type: none"> <li><math>A \subseteq \mathbb{R}</math></li> <li><math>f: A \rightarrow \mathbb{R}</math></li> <li><math>c \in \mathbb{R}</math></li> <li><math>c</math> titik kumpul</li> <li><math>c \in A \cap (c, \infty) \wedge A \cap (-\infty, c)</math></li> <li><math>\lim_{x \rightarrow c} f = L</math></li> <li><math>\lim_{x \rightarrow c^+} f = L</math></li> <li><math>\lim_{x \rightarrow c^-} f = L</math></li> </ol>	<p><b>Poin Penting Kontrapositif dari T. 4.3.3</b></p> <ol style="list-style-type: none"> <li><math>A \subseteq \mathbb{R}</math></li> <li><math>f: A \rightarrow \mathbb{R}</math></li> <li><math>c \in \mathbb{R}</math></li> <li><math>c</math> bukan titik kumpul</li> <li><math>c \notin A \cup (c, \infty) \vee A \cup (-\infty, c)</math></li> <li><math>\lim_{x \rightarrow c} f \neq L</math></li> <li><math>\lim_{x \rightarrow c^+} f \neq L</math></li> <li><math>\lim_{x \rightarrow c^-} f \neq L</math></li> </ol>
<p><b>Alternatif Bukti dari T. 4.3.3</b>  <math>A \subseteq \mathbb{R}, f: A \rightarrow \mathbb{R}, c \in \mathbb{R}, c</math> titik kumpul, <math>c \in A \cap (c, \infty) \wedge A \cap (-\infty, c) \rightarrow \lim_{x \rightarrow c} f = L \Leftrightarrow \lim_{x \rightarrow c^+} f = L = \lim_{x \rightarrow c^-} f</math>.</p> <p>(i) <math>\rightarrow</math> (ii) <math>\Rightarrow</math> Bukti?  (ii) <math>\rightarrow</math> (i) <math>\Rightarrow</math> Bukti?</p> <p><b>Bukti:</b>  Berdasarkan D. 4.1.4 sehingga  <math>A \subseteq \mathbb{R}, c</math> titik kumpul dari <math>A, f: A \rightarrow \mathbb{R}, L \in \mathbb{R}</math>.  Berdasarkan D. 4.3.1 didapat</p>	<p><b>Poin Penting Alternatif Bukti dari T. 4.3.3</b></p> <ol style="list-style-type: none"> <li><math>A \subseteq \mathbb{R}</math></li> <li><math>c</math> titik kumpul dari <math>A</math></li> <li><math>f: A \rightarrow \mathbb{R}</math></li> <li><math>L \in \mathbb{R}</math></li> <li><math>c \in \mathbb{R}</math></li> <li><math>c \in A \cap (c, \infty) = \{x \in A, x &gt; c\} \wedge c \in A \cap (-\infty, c)</math></li> <li><math>\{x \in A, x &lt; c\}</math></li> <li><math>\forall \varepsilon &gt; 0, \exists \delta = \delta(\varepsilon) &gt; 0 \ni \forall x \in A, 0 &lt;  x - c  &lt; \delta \rightarrow</math></li> </ol>

<p><math>A \subseteq \mathbb{R}, f: A \rightarrow \mathbb{R}, c \in \mathbb{R}, c</math> titik kumpul,  <math>c \in A \cap (c, \infty) = \{x \in A, x &gt; c\} \wedge c \in A \cap (-\infty, c)</math>  <math>= \{x \in A, x &lt; c\}, L \in \mathbb{R}</math></p> <p style="text-align: center;"><math>\lim_{x \rightarrow c^+} f = L</math></p> <p>Jika <math>\forall \varepsilon &gt; 0, \exists \delta = \delta(\varepsilon) &gt; 0 \ni \forall x \in A, 0 &lt;  x - c  &lt; \delta \rightarrow</math>  <math> f(x) - L  &lt; \varepsilon</math></p> <p style="text-align: center;"><math>\lim_{x \rightarrow c^-} f = L</math></p> <p>Jika <math>\forall \varepsilon &gt; 0, \exists \delta = \delta(\varepsilon) &gt; 0 \ni \forall x \in A, 0 &lt;  c - x  &lt; \delta \rightarrow</math>  <math> f(x) - L  &lt; \varepsilon</math></p> <p>Berdasarkan D. 2.2.1 didapat</p> $ x  \begin{cases} x, x > 0 \\ 0, x = 0 \\ -x, x < 0 \end{cases}$ $ x - c  \begin{cases} x - c, (x - c) > 0, x > c \\ c - x, (x - c) < 0, x < c \end{cases}$ <p><b>(i) <math>\rightarrow</math> (ii)</b></p> <p>Berdasarkan D. 4.1.4 dan <math>\lim_{x \rightarrow c} f = L</math> diperoleh  <math>\forall \varepsilon &gt; 0, \exists \delta = \delta(\varepsilon) &gt; 0 \ni \forall x \in A, 0 &lt;  x - c  &lt; \delta</math>  <math>\rightarrow  f(x) - L  &lt; \varepsilon</math></p> <p>Karena <math> x - c  &lt; \delta</math> dan berdasarkan D. 2.2.1 sehingga  <math>x - c &lt; \delta, (x - c) &gt; 0 \Leftrightarrow x &gt; c \wedge c - x &lt; \delta, (x - c) &lt; 0</math>  <math>\Leftrightarrow x &lt; c</math></p> <p>Kemudian <math>\forall \varepsilon &gt; 0, \exists \delta = \delta(\varepsilon) &gt; 0 \ni \forall x \in A, 0 &lt;  x - c  &lt;</math>  <math>\delta \rightarrow  f(x) - L  &lt; \varepsilon</math></p> <p>Sehingga berdasarkan D. 4.3.1 diperoleh <math>\lim_{x \rightarrow c^+} f = L</math></p> <p>Lalu <math>\forall \varepsilon &gt; 0, \exists \delta = \delta(\varepsilon) &gt; 0 \ni \forall x \in A, 0 &lt;  c - x  &lt; \delta \rightarrow</math>  <math> f(x) - L  &lt; \varepsilon</math></p> <p>Sehingga berdasarkan D. 4.3.1 diperoleh <math>\lim_{x \rightarrow c^-} f = L</math></p>	<p style="text-align: center;"><math> f(x) - L  &lt; \varepsilon</math></p> <p>9. <math>\forall \varepsilon &gt; 0, \exists \delta = \delta(\varepsilon) &gt; 0 \ni \forall x \in A, 0 &lt;  c - x  &lt; \delta \rightarrow</math>  <math> f(x) - L  &lt; \varepsilon</math></p> <p>10. <math> x  \begin{cases} x, x &gt; 0 \\ 0, x = 0 \\ -x, x &lt; 0 \end{cases}</math></p> <p>11. <math> x - c  \begin{cases} x - c, (x - c) &gt; 0, x &gt; c \\ c - x, (x - c) &lt; 0, x &lt; c \end{cases}</math></p> <p>12. <math>x - c &lt; \delta, (x - c) &gt; 0 \Leftrightarrow x &gt; c \wedge c - x &lt; \delta, (x - c) &lt;</math>  <math>0 \Leftrightarrow x &lt; c</math></p> <p>13. <math>0 &lt; x - c &lt; \delta \wedge 0 &lt; c - x &lt; \delta</math> sehingga <math>0 &lt;  x - c  &lt; \delta</math></p> <p>14. <math>\lim_{x \rightarrow c} f = L</math></p> <p>15. <math>\lim_{x \rightarrow c^+} f = L = \lim_{x \rightarrow c^-} f.</math></p>
---	--

<p>Dengan demikian, <math>\lim_{x \rightarrow c^+} f = L = \lim_{x \rightarrow c^-} f</math>                  Jadi, <math>\lim_{x \rightarrow c} f = L \rightarrow \lim_{x \rightarrow c^+} f = L = \lim_{x \rightarrow c^-} f</math>.  <b>(ii) <math>\rightarrow</math> (i)</b>                  Berdasarkan D. 4.3.1 dan <math>\lim_{x \rightarrow c^+} f = L = \lim_{x \rightarrow c^-} f</math> di peroleh  <math display="block">\forall \varepsilon &gt; 0, \exists \delta = \delta(\varepsilon) &gt; 0 \ni \forall x \in A, 0 &lt;  x - c  &lt; \delta</math> <math display="block">\rightarrow  f(x) - L  &lt; \varepsilon</math> <math display="block">\wedge \forall \varepsilon &gt; 0, \exists \delta = \delta(\varepsilon) &gt; 0 \ni \forall x \in A, 0 &lt;  c - x  &lt; \delta</math> <math display="block">\rightarrow  f(x) - L  &lt; \varepsilon</math>                 Karena <math>0 &lt; x - c &lt; \delta \wedge 0 &lt; c - x &lt; \delta</math> sehingga <math>0 &lt;  x - c  &lt; \delta</math>                  Kemudian, <math>\forall \varepsilon &gt; 0, \exists \delta = \delta(\varepsilon) &gt; 0 \ni \forall x \in A, 0 &lt;  x - c  &lt; \delta \rightarrow  f(x) - L  &lt; \varepsilon</math>                  Sehingga berdasarkan D. 4.1.4 diperoleh <math>\lim_{x \rightarrow c} f = L</math>                  Jadi, <math>\lim_{x \rightarrow c^+} f = L = \lim_{x \rightarrow c^-} f \rightarrow \lim_{x \rightarrow c} f = L</math>                  Jadi, <math>\lim_{x \rightarrow c} f = L \Leftrightarrow \lim_{x \rightarrow c^+} f = L = \lim_{x \rightarrow c^-} f</math>.</p>	
--	--

**4.3.4 Examples (a)** Let  $f(x) := \text{sgn}(x)$

We have seen in Example 4.1.10 (b) that  $\text{sgn}$  does not have a limit at 0. It is clear that  $\lim_{x \rightarrow 0^+} \text{sgn}(x) = +1$  and that  $\lim_{x \rightarrow 0^-} \text{sgn}(x) = -1$ . Since that one-sided limits are different, it also follows from Theorem 4.3.3 that  $\text{sgn}(x)$  does not have a limit at 0.

**(b)** Let  $g(x) = e^{\frac{1}{x}}$  for  $x \neq 0$ . (See figure 4.3.1)

We first show that  $g$  does not have a finite right-hand limit at  $c = 0$  since it is not bounded on any right-hand neighborhood  $(0, \delta)$  of 0. We shall make use of the inequality

**Contoh 4.3.4 (a)** Misalkan  $f(x) := \text{sgn}(x)$

Kita telah melihat pada contoh 4.1.10 (b) sehingga  $\text{sgn}$  tidak memiliki batas pada 0. Sehingga  $\lim_{x \rightarrow 0^+} \text{sgn}(x) = +1$  dan  $\lim_{x \rightarrow 0^-} \text{sgn}(x) = -1$  itu jelas. Karena batas satu sisi itu berbeda, itu juga mengikuti dari teorema 4.3.3 sehingga  $\text{sgn}(x)$  tidak memiliki batas pada 0.

**(b)** Misalkan  $g(x) = e^{\frac{1}{x}}$  untuk  $x \neq 0$ . (Lihat Figur 4.3.1)

Kita pertama kali menunjukkan bahwa  $g$  tidak memiliki batas limit sebelah kanan pada  $c = 0$  karena tidak dibatasi pada lingkungan sebelah kanan  $(0, \delta)$  dari 0. Kita akan menggunakan ketidaksetaraan ini

### 4.3 Some Extension of the Limit Concept

$$(1) \quad 0 < t < e^t \text{ for } t > 0.$$

which will be proved later (see Corollary 8.3.3). It follows from (1) that if  $x > 0$ , then  $0 < \frac{1}{x} < e^{\frac{1}{x}}$ . Hence, if we take  $x_n = \frac{1}{n}$ , then  $g(x_n) > n$  for all  $n \in \mathbb{N}$ . Therefore  $\lim_{x \rightarrow 0^+} e^{\frac{1}{x}}$  does not exist in  $\mathbb{R}$ .

However,  $\lim_{x \rightarrow 0^-} e^{\frac{1}{x}} = 0$ . Indeed, if  $x < 0$  and we take  $t = -\frac{1}{x}$  in (1) we obtain  $0 < -\frac{1}{x} < e^{-\frac{1}{x}}$ . Since  $x < 0$ , this implies that  $0 < e^{\frac{1}{x}} < -x$  for all  $x < 0$ . It follows from this inequality that  $\lim_{x \rightarrow 0^-} e^{\frac{1}{x}} = 0$ .

$$(c) \text{ Let } h(x) := \frac{1}{\left(\frac{1}{e^{\frac{1}{x}}+1}\right)} \text{ for } x \neq 0. \text{ (See Figure 4.3.2)}$$

We have seen in part (b) that  $0 < \frac{1}{x} < e^{\frac{1}{x}}$  for  $x > 0$ , whence

$$0 < \frac{1}{\left(\frac{1}{e^{\frac{1}{x}}+1}\right)} < \frac{1}{e^{\frac{1}{x}}} < x.$$

which implies that  $\lim_{x \rightarrow 0^+} h = 0$ .

Since we have seen in part (b) that  $\lim_{x \rightarrow 0^-} e^{\frac{1}{x}} = 0$ , it follows from the analogue of Theorem 4.2.4 (b) for left-hand limits that

$$\lim_{x \rightarrow 0^-} \left(\frac{1}{e^{\frac{1}{x}}+1}\right) = \frac{1}{\lim_{x \rightarrow 0^-} e^{\frac{1}{x}}+1} = \frac{1}{0+1} = 1.$$

Note that for this function, both one-sided limits exist in  $\mathbb{R}$ , but they are unequal. ■

#### Infinite Limits

### 4.3 Beberapa Ekstensi dari Konsep Limit

$$(1) \quad 0 < t < e^t \text{ untuk } t > 0.$$

yang akan dibuktikan nanti (Lihat Corollary 8.3.3). Mengikuti dari (1) sehingga jika  $x > 0$ , lalu  $0 < \frac{1}{x} < e^{\frac{1}{x}}$ . Karena, jika kita mengambil  $x_n = \frac{1}{n}$ , maka  $g(x_n) > n$  untuk semua  $n \in \mathbb{N}$ . Oleh karena itu  $\lim_{x \rightarrow 0^+} e^{\frac{1}{x}}$  tidak ada di  $\mathbb{R}$ .

Namun,  $\lim_{x \rightarrow 0^-} e^{\frac{1}{x}} = 0$ . Memang, jika  $x < 0$  dan kita mengambil  $t = -\frac{1}{x}$  dalam (1) kita memperoleh  $0 < -\frac{1}{x} < e^{-\frac{1}{x}}$ . Sejak  $x < 0$ , ini berarti sehingga  $0 < e^{\frac{1}{x}} < -x$  untuk semua  $x < 0$ . Itu mengikuti dari ketidaksetaraan sehingga  $\lim_{x \rightarrow 0^-} e^{\frac{1}{x}} = 0$ .

$$(c) \text{ Misalkan } h(x) := \frac{1}{\left(\frac{1}{e^{\frac{1}{x}}+1}\right)} \text{ untuk } x \neq 0. \text{ (Lihat Figur 4.3.2)}$$

Kita telah melihat bagian (b) sehingga  $0 < \frac{1}{x} < e^{\frac{1}{x}}$  untuk  $x > 0$ , dimana

$$0 < \frac{1}{\left(\frac{1}{e^{\frac{1}{x}}+1}\right)} < \frac{1}{e^{\frac{1}{x}}} < x.$$

yang berarti sehingga  $\lim_{x \rightarrow 0^+} h = 0$ .

Karena kita telah melihat bagian (b) sehingga  $\lim_{x \rightarrow 0^-} e^{\frac{1}{x}} = 0$ , itu mengikuti dari analog Teorema 4.2.4 (b) untuk sebelah kiri sehingga

$$\lim_{x \rightarrow 0^-} \left(\frac{1}{e^{\frac{1}{x}}+1}\right) = \frac{1}{\lim_{x \rightarrow 0^-} e^{\frac{1}{x}}+1} = \frac{1}{0+1} = 1.$$

Catat bahwa untuk fungsi ini, kedua batas satu sisi ada di  $\mathbb{R}$ , tetapi

### 4.3 Some Extension of the Limit Concept

The function  $f(x) := \frac{1}{x^2}$  for  $x \neq 0$  (see Figure 4.3.3) is not bounded on a neighborhood of 0, so it cannot have a limit in the sense of Definition 4.1.4. While the symbols  $\infty (= +\infty)$  and  $-\infty$  do not represent real numbers, it is sometimes useful to be able to say that “ $f(x) = \frac{1}{x^2}$  tends to  $\infty$  as  $x \rightarrow 0$ ”. This use of  $\pm\infty$  will not cause any difficulties, provided we exercise caution and never interpret  $\infty$  or  $-\infty$  as being real numbers.

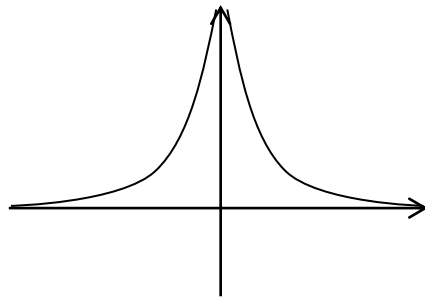

Figure 4.3.3 Graph of  $f(x) = \frac{1}{x^2} (x \neq 0)$

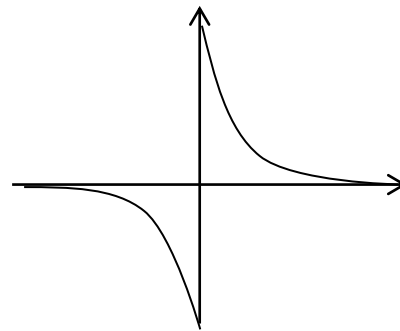
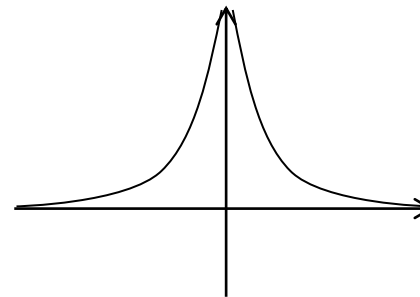
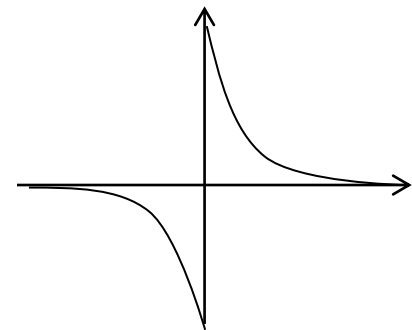

Figure 4.3.4 Graph of  $g(x) = \frac{1}{x} (x \neq 0)$



Figur 4.3.3 Grafik dari  $f(x) = \frac{1}{x^2} (x \neq 0)$



Figur 4.3.4 Grafik dari  $g(x) = \frac{1}{x} (x \neq 0)$

### 4.3 Beberapa Ekstensi dari Konsep Limit

keduanya tidak sama. ■

#### Limit-limit Tak Hingga

Fungsi  $f(x) := \frac{1}{x^2}$  untuk  $x \neq 0$  (Lihat Figur 4.3.3) tidak terbatas pada suatu lingkungan 0, dengan demikian fungsi tersebut tidak mempunyai suatu limit sesuai pengertian dalam Definisi 4.1.4. Sementara simbol-simbol  $\infty (= +\infty)$  dan  $-\infty$  tidak menyatakan suatu bilangan real, ini kadang-kadang menjadi bermakna dengan mengatakan bahwa “ $f(x) = \frac{1}{x^2}$  cenderung ke  $\infty$  apabila  $x \rightarrow 0$ ”. Kegunaan ini dari  $\pm\infty$  tidak menyebabkan kesulitan, menyediakan latihan-latihan dan tidak menafsirkan  $\infty$  atau  $-\infty$  menjadi bilangan real.

<p><b>Alternatif Jawaban dari C.4.3.4 (a)</b>                  Misal <math>f(x) := \operatorname{sgn}(x) \rightarrow</math> Bukti?  <b>Bukti:</b>                  Pada contoh 4.1.10 (b), sehingga <math>\operatorname{sgn}</math> tidak memiliki batas pada 0. Sehingga <math>\lim_{x \rightarrow 0^+} \operatorname{sgn}(x) = +1</math> dan <math>\lim_{x \rightarrow 0^-} \operatorname{sgn}(x) = -1</math>. Karena batas satu sisi berbeda, maka berdasarkan teorema 4.3.3. Sehingga <math>\operatorname{sgn}(x)</math> tidak memiliki batas pada 0.</p>	<p><b>Poin penting dari C.4.3.4 (a)</b>                  (1) <math>\operatorname{sgn}</math> tidak memiliki batas pada 0.                  (2) <math>\lim_{x \rightarrow 0^+} \operatorname{sgn}(x) = +1</math> dan <math>\lim_{x \rightarrow 0^-} \operatorname{sgn}(x) = -1</math>.                  (3) Berdasarkan teorema 4.3.3.                  (4) <math>\operatorname{sgn}(x)</math> tidak memiliki batas pada 0.</p>
<p><b>Alternatif Jawaban dari C.4.3.4 (b)</b>                  Misal <math>(x) = e^{\frac{1}{x}}, x \neq 0 \rightarrow</math> Bukti?  <b>Bukti:</b>                  Adit: bahwa <math>g</math> tidak memiliki batas limit sebelah kanan pada <math>c = 0</math>. Karena tidak dibatasi pada lingkungan sebelah kanan <math>(0, \delta)</math> dari 0. Kita menggunakan ketidaksetaraan ini (1) <math>0 &lt; t &lt; e^t, t &gt; 0</math>.                  Adib: dari (1) sehingga jika <math>x &gt; 0</math>, lalu <math>0 &lt; \frac{1}{x} &lt; e^{\frac{1}{x}}</math>.                  Asumsikan <math>x_n = \frac{1}{n}</math>, maka <math>g(x_n) &gt; n \forall n \in \mathbb{N}</math>.                  Karena <math>\lim_{x \rightarrow 0^+} e^{\frac{1}{x}}</math> tidak ada di <math>\mathbb{R}</math>.                  Sehingga <math>\lim_{x \rightarrow 0^-} e^{\frac{1}{x}} = 0, x &lt; 0</math>.                  Asumsikan <math>t = -\frac{1}{x}</math> dalam (1), maka diperoleh <math>0 &lt; -\frac{1}{x} &lt; e^{-\frac{1}{x}}</math>.                  Karena <math>x &lt; 0</math>, sehingga <math>0 &lt; e^{\frac{1}{x}} &lt; -x \forall x &lt; 0</math>.                  Dari ketidaksetaraan sehingga <math>\lim_{x \rightarrow 0^-} e^{\frac{1}{x}} = 0</math>.</p>	<p><b>Poin penting dari C.4.3.4 (b)</b>                  (1) <math>g</math> tidak memiliki batas limit sebelah kanan pada <math>c = 0</math>.                  (2) Tidak dibatasi pada lingkungan sebelah kanan <math>(0, \delta)</math> dari 0.                  (3) Ketidaksetaraan (1) <math>0 &lt; t &lt; e^t, t &gt; 0</math>.                  (4) <math>x &gt; 0</math>, lalu <math>0 &lt; \frac{1}{x} &lt; e^{\frac{1}{x}}</math>.                  (5) <math>x_n = \frac{1}{n}</math>, maka <math>g(x_n) &gt; n \forall n \in \mathbb{N}</math>.                  (6) <math>\lim_{x \rightarrow 0^+} e^{\frac{1}{x}}</math> tidak ada di <math>\mathbb{R}</math>.                  (7) <math>\lim_{x \rightarrow 0^-} e^{\frac{1}{x}} = 0, x &lt; 0</math>.                  (8) <math>t = -\frac{1}{x}</math> dalam (1), maka diperoleh <math>0 &lt; -\frac{1}{x} &lt; e^{-\frac{1}{x}}</math>.                  (9) <math>x &lt; 0</math>, sehingga <math>0 &lt; e^{\frac{1}{x}} &lt; -x \forall x &lt; 0</math>.                  (10) <math>\lim_{x \rightarrow 0^-} e^{\frac{1}{x}} = 0</math>.</p>
<p><b>Alternatif Jawaban dari C.4.3.4 (c)</b>                  Misal <math>h(x) := \frac{1}{\left(\frac{1}{e^x+1}\right)}, x \neq 0 \rightarrow</math> Bukti?  <b>Bukti:</b>                  Pada bagian (b) sehingga <math>0 &lt; \frac{1}{x} &lt; e^{\frac{1}{x}}, x &gt; 0</math>.                  Dimana <math>0 &lt; \frac{1}{\left(\frac{1}{e^x+1}\right)} &lt; \frac{1}{e^x} &lt; x</math>, sehingga <math>\lim_{x \rightarrow 0^+} h = 0</math>.</p>	<p><b>Poin penting dari C.4.3.4 (c)</b>                  (1) <math>0 &lt; \frac{1}{x} &lt; e^{\frac{1}{x}}, x &gt; 0</math>.                  (2) <math>0 &lt; \frac{1}{\left(\frac{1}{e^x+1}\right)} &lt; \frac{1}{e^x} &lt; x</math>.                  (3) <math>\lim_{x \rightarrow 0^+} h = 0</math>.                  (4) <math>\lim_{x \rightarrow 0^-} e^{\frac{1}{x}} = 0</math>.                  (5) Berdasarkan analog Teorema 4.2.4 (b).</p>

Karena telah melihat bagian (b) sehingga  $\lim_{x \rightarrow 0^-} e^{\frac{1}{x}} = 0$ . Berdasarkan analog Teorema 4.2.4 (b) untuk sebelah kiri, sehingga

$$\lim_{x \rightarrow 0^-} \left( \frac{1}{e^{\frac{1}{x}+1}} \right) = \frac{1}{\lim_{x \rightarrow 0^-} e^{\frac{1}{x}+1}} = \frac{1}{0+1} = 1.$$

(6) 
$$\lim_{x \rightarrow 0^-} \left( \frac{1}{e^{\frac{1}{x}+1}} \right) = \frac{1}{\lim_{x \rightarrow 0^-} e^{\frac{1}{x}+1}} = \frac{1}{0+1} = 1.$$

**Infinite Limits**

The function  $f(x) := 1/x^2$  for  $x \neq 0$  (see Figure 4.3.3) is not bounded a neighborhood of 0, so it cannot have a limit in the sense of Definition 4.1.4. while the symbols  $\infty (= +\infty)$  and  $-\infty$  do not represent real numbers, it is sometimes useful to be able to say that “ $f(x) = 1/x^2$  tends to  $\infty$  as  $x \rightarrow 0$ .” This use of  $\pm\infty$  will not cause any difficulties, provided we exercise caution and *never* interpret  $\infty$  or  $-\infty$  as being real numbers.

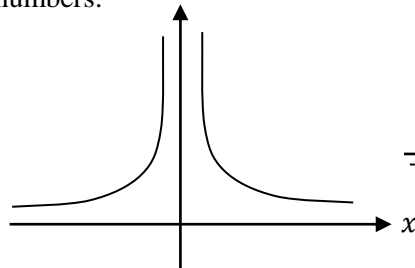

**Figure 4.3.3** Graph of  $f(x) = 1/x^2$  ( $x \neq 0$ )

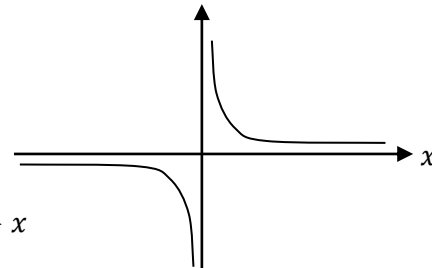

**Figure 4.3.3** Graph of  $g(x) = 1/x$  ( $x \neq 0$ )

**4.3.5 Definition** Let  $A \subseteq \mathbb{R}$ , let  $f: A \rightarrow \mathbb{R}$ , and let  $c \in \mathbb{R}$  be a cluster point of  $A$ .

(i) We say that  $f$  **tends to  $\infty$  as  $x \rightarrow c$** , and write 
$$\lim_{x \rightarrow c} f = \infty,$$

If for every  $\alpha \in \mathbb{R}$  there exists  $\delta = \delta(\alpha) > 0$  such that for all  $x \in A$  with  $0 < |x - c| < \delta$ , then  $f(x) > \alpha$ .

(ii) We say that  $f$  **tends to  $-\infty$  as  $x \rightarrow c$** , and write

**Limit-limit Tak Hingga**

Fungsi  $f(x) := 1/x^2$  untuk  $x \neq 0$  (lihat gambar 4.3.3) tidak terbatas pada suatu lingkungan 0, dengan demikian fungsi tersebut tidak mempunyai suatu limit sesuai pengertian dalam Definisi 4.1.4. sementara simbol-simbol  $\infty (= +\infty)$  dan  $-\infty$  tidak menyatakan suatu bilangan real, ini kadang-kadang menjadi bermakna dengan mengatakan “ $f(x) = 1/x^2$  cenderung ke  $\infty$  apabila  $x \rightarrow 0$ .” Kegunaan ini  $\pm\infty$  tidak menyebabkan kesulitan, menyediakan latihan-latihan dan tidak menafsirkan  $\infty$  atau  $-\infty$  menjadi bilangan real.

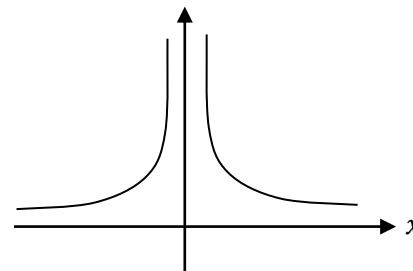

**Gambar 4.3.3** Grafik dari  $f(x) = 1/x^2$  ( $x \neq 0$ )

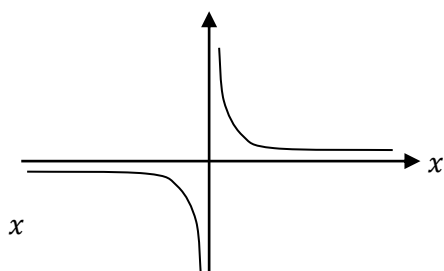

**Gambar 4.3.3** Grafik dari  $g(x) = 1/x$  ( $x \neq 0$ )

**Definisi 4.3.5** misalkan  $A \subseteq \mathbb{R}$ , misalkan  $f: A \rightarrow \mathbb{R}$ , dan misalkan  $c \in \mathbb{R}$  suatu titik kumpul dari  $A$ .

(i) kita katakan bahwa  $f$  menuju ke  $\infty$  apabila  $x \rightarrow c$ , dan ditulis 
$$\lim_{x \rightarrow c} f = \infty,$$

Jika untuk  $\alpha \in \mathbb{R}$  terdapat  $\delta = \delta(\alpha) > 0$  sedemikian sehingga



### 4.3 Some Extension of the Limit Concept

$$\lim_{x \rightarrow c} f = -\infty,$$

If for every  $\beta \in \mathbb{R}$  there exists  $\delta = \delta(\beta) > 0$  such that for all  $x \in A$  with  $0 < |x - c| < \delta$ , then  $f(x) < \beta$ .

### 4.3 Beberapa Ekstensi dari Konsep Limit

untuk semua  $x \in A$  dengan  $0 < |x - c| < \delta$ , maka  $f(x) > \alpha$ .

(ii) kita katakan bahwa  $f$  menuju ke  $-\infty$  apabila  $x \rightarrow c$ , dan ditulis

$$\lim_{x \rightarrow c} f = -\infty,$$

Jika untuk  $\beta \in \mathbb{R}$  terdapat  $\delta = \delta(\beta) > 0$  sedemikian sehingga untuk semua  $x \in A$  dengan  $0 < |x - c| < \delta$ , maka  $f(x) < \beta$ .

<p><b>Natasi Matematika dari D.4.3.5</b>  <math>A \subseteq \mathbb{R}</math>, <math>f: A \rightarrow \mathbb{R}</math>, <math>c \in \mathbb{R}</math> suatu titik kumpul dari <math>A</math>.</p> <p>(i) <math>f \rightarrow \infty</math>, <math>x \rightarrow c \ni \lim_{x \rightarrow c} f = \infty</math>,  <math>\forall \alpha \in \mathbb{R} \exists \delta = \delta(\alpha) &gt; 0 \ni \forall x \in A \text{ dg } 0 &lt;  x - c  &lt; \delta \Rightarrow f(x) &gt; \alpha</math>.</p> <p>(ii) <math>f \rightarrow -\infty</math>, <math>x \rightarrow c \ni \lim_{x \rightarrow c} f = -\infty</math>,  <math>\forall \beta \in \mathbb{R} \exists \delta = \delta(\beta) &gt; 0 \ni \forall x \in A \text{ dg } 0 &lt;  x - c  &lt; \delta \Rightarrow f(x) &lt; \beta</math>.</p>	<p><b>Kontrapositif dari D.4.3.5</b>  <math>A \not\subseteq \mathbb{R}</math>, <math>f: A \rightarrow \mathbb{R}</math>, <math>c \in \mathbb{R}</math> bukan titik kumpul dari <math>A</math>.</p> <p>(i) <math>f \rightarrow \infty</math>, <math>x \rightarrow c \ni \lim_{x \rightarrow c} f \neq \infty</math>,  <math>\forall \alpha \in \mathbb{R} \exists \delta \neq \delta(\alpha) &gt; 0 \ni \forall x \in A \text{ dg } 0 &lt;  x - c  &lt; \delta \Rightarrow f(x) &lt; \alpha</math>.</p> <p>(ii) <math>f \rightarrow -\infty</math>, <math>x \rightarrow c \ni \lim_{x \rightarrow c} f \neq -\infty</math>,  <math>\forall \beta \in \mathbb{R} \exists \delta \neq \delta(\beta) &gt; 0 \ni \forall x \in A \text{ dg } 0 &lt;  x - c  &lt; \delta \Rightarrow f(x) &gt; \beta</math>.</p>
<p><b>Poin Penting dari D.4.3.5</b></p> <ol style="list-style-type: none"> <li><math>A \subseteq \mathbb{R}</math></li> <li><math>f: A \rightarrow \mathbb{R}</math></li> <li><math>c \in \mathbb{R}</math> suatu titik kumpul dari <math>A</math>.</li> <li><math>f \rightarrow \infty</math></li> <li><math>x \rightarrow c</math></li> <li><math>\lim_{x \rightarrow c} f = \infty</math></li> <li><math>\alpha \in \mathbb{R}</math></li> <li><math>\delta = \delta(\alpha) &gt; 0</math></li> <li><math>x \in A</math></li> <li><math>0 &lt;  x - c  &lt; \delta</math></li> <li><math>f(x) &gt; \alpha</math>.</li> <li><math>f \rightarrow -\infty</math></li> <li><math>x \rightarrow c</math></li> <li><math>\lim_{x \rightarrow c} f = -\infty</math>,</li> <li><math>\beta \in \mathbb{R}</math></li> <li><math>\delta = \delta(\beta) &gt; 0</math></li> </ol>	<p><b>Poin Penting Kontrapositif dari D.3.4.5</b></p> <ol style="list-style-type: none"> <li><math>A \not\subseteq \mathbb{R}</math></li> <li><math>f: A \rightarrow \mathbb{R}</math></li> <li><math>c \in \mathbb{R}</math> bukan titik kumpul dari <math>A</math>.</li> <li><math>f \rightarrow \infty</math></li> <li><math>x \rightarrow c</math></li> <li><math>\lim_{x \rightarrow c} f \neq \infty</math></li> <li><math>\alpha \in \mathbb{R}</math></li> <li><math>\delta \neq \delta(\alpha) &gt; 0</math></li> <li><math>x \in A</math></li> <li><math>0 &lt;  x - c  &lt; \delta</math></li> <li><math>f(x) &lt; \alpha</math>.</li> <li><math>f \rightarrow -\infty</math></li> <li><math>x \rightarrow c</math></li> <li><math>\lim_{x \rightarrow c} f \neq -\infty</math>,</li> <li><math>\beta \in \mathbb{R}</math></li> <li><math>\delta \neq \delta(\beta) &gt; 0</math></li> </ol>

17. $x \in A$ 18. $0 <  x - c  < \delta$ 19. $f(x) < \beta$ .	17. $x \in A$ 18. $0 <  x - c  < \delta$ 19. $f(x) > \beta$ .
---	---

**4.3.6 Examples** (a)  $\lim_{x \rightarrow 0} 1/x^2 = \infty$

For, if  $\alpha > 0$  is given, let  $\delta := 1/\sqrt{\alpha}$ . It follows that if  $0 < |x| < \delta$ , then  $x^2 < 1/\alpha$  so that  $1/x^2 > \alpha$ .

(b) Let  $g(x) := 1/x$  for  $x \neq 0$ . (See Figure 4.3.4)

The function  $g$  does not tend to either  $\infty$  or  $-\infty$  as  $x \rightarrow 0$ . For, if  $\alpha > 0$  then  $g(x) < \alpha$  for all  $x < 0$ , so that  $g$  does not tend to  $\infty$  as  $x \rightarrow 0$ . Similarly, if  $\beta < 0$  then  $g(x) > \beta$  for all  $x > 0$ , so that  $g$  does not tend  $-\infty$  as  $x \rightarrow 0$ .

While many of the results in Sections 4.1 and 4.2 have extensions to this limiting notion, not all of them do since  $\pm\infty$  are not real numbers. The following result is an analogue of the Squeeze Theorem 4.2.7. (See also Theorem 3.6.4.)

**Contoh 4.3.6** (a)  $\lim_{x \rightarrow 0} 1/x^2 = \infty$

Diberikan sebarang  $\alpha > 0$ , misalkan  $\delta := 1/\sqrt{\alpha}$ . Ini berarti bahwa jika  $0 < |x| < \delta$ , maka  $x^2 < 1/\alpha$  jadi  $1/x^2 > \alpha$ .

(b) Misalkan  $g(x) := 1/x$  untuk  $x \neq 0$ . (Lihat Gambar 4.3.4).

Fungsi  $g$  tidak menuju ke  $\infty$  atau ke  $-\infty$  sebagaimana  $x \rightarrow 0$ . Karena jika  $\alpha > 0$  maka  $g(x) < \alpha$  untuk semua  $x < 0$ , dengan demikian  $g$  tidak menuju ke  $\infty$  apabila  $x \rightarrow 0$ . Serupa juga, jika  $\beta < 0$  maka  $g(x) > \beta$  untuk semua  $x > 0$ . Dengan demikian  $g$  tidak menuju ke  $-\infty$  apabila  $x \rightarrow 0$ .

Sementara banyak hasil di bagian 4.1 dan 4.2 memiliki ekstansi untuk pengertian yang membatasi ini, tidak semuanya dilakukan karena  $\pm\infty$  bukan bilangan real. Hasil berikut adalah analog dari Teorema Apit 4.2.7. (lihat juga Teorema 3.4.6)

<p><b>Alternatif Jawaban dari C. 4.3.6 (a)</b></p> <p><math>\lim_{x \rightarrow 0} 1/x^2 = \infty \rightarrow</math> Bukti?</p> <p><b>Bukti:</b></p> <p><math>\lim_{x \rightarrow 0} 1/x^2 = \infty</math></p> <p>Berdasarkan D. 4.3.5</p> <p>Diberikan sebarang <math>\alpha &gt; 0, \exists \delta(\alpha)</math>.</p> <p>Misalkan <math>\delta := 1/\sqrt{\alpha}</math>. Ini berarti bahwa jika <math>0 &lt;  x  &lt; \delta</math>, maka</p>	<p><b>Poin penting dari C. 4.3.6 (a)</b></p> <ol style="list-style-type: none"> <li><math>\lim_{x \rightarrow 0} 1/x^2 = \infty</math>.</li> <li>Diberikan sebarang <math>\alpha &gt; 0, \exists \delta(\alpha)</math>.</li> <li><math>\delta := 1/\sqrt{\alpha}</math>.</li> <li>Jika <math>0 &lt;  x  &lt; \delta \rightarrow 0 &lt;  x  &lt; \frac{1}{\sqrt{\alpha}}</math>.</li> <li><math>x^2 &lt; \frac{1}{\alpha}</math> (Berdasarkan T. 2.2.1) <math>\Leftrightarrow \frac{1}{x^2} &gt; \alpha</math>.</li> <li>Sehingga <math>f(x) &gt; \alpha</math>.</li> </ol>
---	--

$0 <  x  < \frac{1}{\sqrt{\alpha}}$ $\Leftrightarrow x^2 < \frac{1}{\alpha} \text{ (Berdasarkan T. 2.2.1)}$ $\Leftrightarrow \frac{1}{x^2} > \alpha$ <p>Sehingga <math>f(x) &gt; \alpha</math></p> <p>Jadi, <math>\lim_{x \rightarrow 0} \frac{1}{x^2} = \infty</math> (Terbukti)</p>	
<p><b>Alternatif Jawaban dari C. 4.3.6 (b)</b></p> <p>Misalkan <math>g(x) := \frac{1}{x}</math> untuk <math>x \neq 0 \rightarrow</math> Bukti?</p> <p><b>Bukti:</b></p> <p>Misalkan <math>g(x) := \frac{1}{x}</math> untuk <math>x \neq 0</math>. (Lihat gambar 4.3.4) fungsi <math>g</math> tidak menuju ke <math>\infty</math> atau ke <math>-\infty</math> sebagaimana <math>x \rightarrow 0</math>. Karena jika <math>\alpha &gt; 0</math> maka <math>g(x) &lt; \alpha</math> untuk semua <math>x &lt; 0</math>, dengan demikian <math>g</math> tidak menuju ke <math>\infty</math> apabila <math>x \rightarrow 0</math>.</p> <p>Serupa juga, jika <math>\beta &lt; 0</math> maka <math>g(x) &gt; \beta</math> untuk semua <math>x &gt; 0</math>. Dengan demikian <math>g</math> tidak menuju ke <math>-\infty</math> apabila <math>x \rightarrow 0</math>. Hasil berikut analog dengan teorema apit 4.2.7.</p>	<p><b>Poin penting dari C. 4.3.6 (b)</b></p> <ol style="list-style-type: none"> <li>Misalkan <math>g(x) := \frac{1}{x}</math> untuk <math>x \neq 0</math> (Lihat gambar 4.3.4).</li> <li>Fungsi <math>g</math> tidak menuju ke <math>\infty</math> atau ke <math>-\infty</math> sebagaimana <math>x \rightarrow 0</math>.</li> <li>Jika <math>\alpha &gt; 0</math> maka <math>g(x) &lt; \alpha</math> untuk semua <math>x &lt; 0 \rightarrow g</math> tidak menuju ke <math>\infty</math> apabila <math>x \rightarrow 0</math>.</li> <li>Jika <math>\beta &lt; 0</math> maka <math>g(x) &gt; \beta</math> untuk semua <math>x &gt; 0 \rightarrow g</math> tidak menuju ke <math>-\infty</math> apabila <math>x \rightarrow 0</math>.</li> </ol>

**4.3.7 Theorem** let  $A \subseteq \mathbb{R}$ , let  $f, g: A \rightarrow \mathbb{R}$ , and let  $c \in \mathbb{R}$  be a cluster point of  $A$ . Suppose that  $f(x) \leq g(x)$  for all  $x \in A, x \neq c$ .

- (a) if  $\lim_{x \rightarrow c} f = \infty$ , then  $\lim_{x \rightarrow c} g = \infty$ .
- (b) if  $\lim_{x \rightarrow c} g = -\infty$ , then  $\lim_{x \rightarrow c} f = -\infty$ .

**Proof.** (a) If  $\lim_{x \rightarrow c} f = \infty$  and  $\alpha \in \mathbb{R}$  is given, then there exist  $\delta(\alpha) > 0$  such that if  $0 < |x - c| < \delta(\alpha)$  and  $x \in A$ , then  $f(x) > \alpha$ . But since  $f(x) \leq g(x)$  for all  $x \in A, x \neq c$ , it follows that if  $0 < |x - c| < \delta(\alpha)$  and  $x \in A$ , then  $g(x) > \alpha$ . Therefore  $\lim_{x \rightarrow c} g = \infty$ .

**Teorema 4.3.7** ambil  $A \subseteq \mathbb{R}$ , ambil  $f, g: A \rightarrow \mathbb{R}$ , dan ambil  $c \in \mathbb{R}$  suatu titik kumpul dari  $A$ . Anggaplah bahwa  $f(x) \leq g(x)$  untuk setiap  $x \in A, x \neq c$ .

- (a) Jika  $\lim_{x \rightarrow c} f = \infty$ , maka  $\lim_{x \rightarrow c} g = \infty$ .
- (b) Jika  $\lim_{x \rightarrow c} g = -\infty$ , maka  $\lim_{x \rightarrow c} f = -\infty$ .

**Proof.** (a) Jika  $\lim_{x \rightarrow c} f = \infty$  dan  $\alpha \in \mathbb{R}$  diberikan, maka terdapat  $\delta(\alpha) > 0$  sedemikian sehingga jika  $0 < |x - c| < \delta(\alpha)$  dan  $x \in A$ , maka  $f(x) > \alpha$ . Akan tetapi  $f(x) \leq g(x)$  untuk semua  $x \in A, x \neq c$ , perhatikan bahwa jika  $0 < |x - c| < \delta(\alpha)$

### 4.3 Some Extension of the Limit Concept

### 4.3 Beberapa Ekstensi dari Konsep Limit

The proof of (b) is similar.

Q.E.D.

The function  $g(x) = \frac{1}{x}$  considered in Example 4.3.6 (b) suggests that it might be useful to consider one-sided infinite limits. We will define only right-hand infinite limits.

dan  $x \in A$ , maka  $g(x) > \alpha$ . Oleh karena itu  $\lim_{x \rightarrow c} g = \infty$ .

Pada bukti (b) adalah sama.  
Q.E.D.

Pada fungsi  $g(x) = \frac{1}{x}$  dalam contoh 4.3.6 (b) menyampaikan bahwa itu dapat berguna untuk limit tak terbatas. Kita akan menetapkan batas kanan limit tak terbatas.

<p><b>Notasi Matematika dari T 4.3.7</b>  <math>A \subseteq \mathbb{R}</math>, <math>f, g: A \rightarrow \mathbb{R}</math>, <math>c \in \mathbb{R}</math> titik kumpul dari <math>A</math>. <math>f(x) \leq g(x)</math>  <math>\forall x \in A, x \neq c</math>                      (a) <math>\lim_{x \rightarrow c} f = \infty \rightarrow \lim_{x \rightarrow c} g = \infty</math>.                      (b) <math>\lim_{x \rightarrow c} g = -\infty \rightarrow \lim_{x \rightarrow c} f = -\infty</math>.</p>	<p><b>Kontrapositif dari T 4.3.7</b>  <math>A \subseteq \mathbb{R}</math>, <math>f, g: A \rightarrow \mathbb{R}</math>, <math>c \in \mathbb{R}</math> bukan titik kumpul dari <math>A</math>. <math>f(x) \leq g(x) \exists x \in A, x \neq c</math>                      (a) <math>\lim_{x \rightarrow c} f = \infty \rightarrow \lim_{x \rightarrow c} g = \infty</math>.                      (b) <math>\lim_{x \rightarrow c} g = -\infty \rightarrow \lim_{x \rightarrow c} f = -\infty</math>.</p>
<p><b>Poin Penting dari T 4.3.7</b></p> <ol style="list-style-type: none"> <li><math>A \subseteq \mathbb{R}</math></li> <li><math>f, g: A \rightarrow \mathbb{R}</math></li> <li><math>c \in \mathbb{R}</math> titik kumpul dari <math>A</math></li> <li><math>f(x) \leq g(x) \forall x \in A</math></li> <li><math>x \neq c</math></li> <li><math>\lim_{x \rightarrow c} f = \infty \rightarrow \lim_{x \rightarrow c} g = \infty</math></li> <li><math>\lim_{x \rightarrow c} g = -\infty \rightarrow \lim_{x \rightarrow c} f = -\infty</math></li> </ol>	<p><b>Poin Penting dari Kontrapositif T 4.3.7</b></p> <ol style="list-style-type: none"> <li><math>A \subseteq \mathbb{R}</math></li> <li><math>f, g: A \rightarrow \mathbb{R}</math></li> <li><math>c \in \mathbb{R}</math> bukan titik kumpul dari <math>A</math></li> <li><math>f(x) \leq g(x) \exists x \in A</math></li> <li><math>x \neq c</math></li> <li><math>\lim_{x \rightarrow c} f = \infty \rightarrow \lim_{x \rightarrow c} g = \infty</math></li> <li><math>\lim_{x \rightarrow c} g = -\infty \rightarrow \lim_{x \rightarrow c} f = -\infty</math></li> </ol>
<p><b>Alternatif Bukti dari T 4.3.7 (a)</b>                      Jika <math>\lim_{x \rightarrow c} f = \infty</math> dan <math>a \in \mathbb{R}</math> diberikan, maka ada <math>\delta(a) &gt; 0</math> sedemikian sehingga jika <math>0 &lt;  x - c  &lt; \delta(a)</math> dan <math>x \in A</math> maka <math>f(x) &gt; a</math>, tetapi karena <math>f(x) \leq g(x) \forall x \in A, x \neq c</math>, berarti jika <math>0 &lt;  x - c  &lt; \delta(a)</math> dan <math>x \in A</math> maka <math>g(x) \in a</math>. Terbukti <math>\lim_{x \rightarrow c} g = \infty</math>. <math>\square</math></p>	<p><b>Poin Penting Alternatif Bukti dari T. 4.3.7 (a)</b></p> <ol style="list-style-type: none"> <li><math>\lim_{x \rightarrow c} f = \infty</math></li> <li><math>a \in \mathbb{R}</math></li> <li><math>\exists \delta(a) &gt; 0</math></li> <li><math>0 &lt;  x - c  &lt; \delta(a), x \in A \rightarrow f(x) &gt; a</math></li> <li><math>f(x) \leq g(x) \forall x \in A, x \neq c</math></li> </ol>

<p><b>Alternatif Bukti dari T 4.3.7 (b)</b>                  Jika <math>\lim_{x \rightarrow c} g = -\infty</math> dan <math>\beta \in \mathbb{R}</math> diberikan, maka ada <math>\delta(\beta) &gt; 0</math> sedemikian sehingga jika <math>0 &lt;  x - c  &lt; \delta(\beta)</math> dan <math>x \in A</math> maka <math>g(x) &gt; \beta</math>, tetapi karena <math>f(x) \leq g(x) \forall x \in A, x \neq c</math>, berarti jika <math>0 &lt;  x - c  &lt; \delta(\beta)</math> dan <math>x \in A</math> maka <math>f(x) \in a</math>. Terbukti <math>\lim_{x \rightarrow c} f = -\infty</math>. <math>\square</math></p>	<p>6. <math>0 &lt;  x - c  &lt; \delta(a), x \in A \rightarrow g(x) \in a</math></p> <p><b>Poin Penting Alternatif Bukti dari T. 4.3.7 (b)</b></p> <ol style="list-style-type: none"> <li><math>\lim_{x \rightarrow c} g = -\infty</math></li> <li><math>\beta \in \mathbb{R}</math></li> <li><math>\exists \delta(\beta) &gt; 0</math></li> <li><math>0 &lt;  x - c  &lt; \delta(\beta), x \in A \rightarrow g(x) &gt; \beta</math></li> <li><math>f(x) \leq g(x) \forall x \in A, x \neq c</math></li> <li><math>0 &lt;  x - c  &lt; \delta(\beta), x \in A \rightarrow f(x) \in a</math></li> </ol>
--	--

**4.3.8 Definition** Let  $A \subseteq \mathbb{R}$  and let  $f: A \rightarrow \mathbb{R}$ . If  $c \in \mathbb{R}$  is a cluster point of the set  $A \cap (c, \infty) = \{x \in A : x > c\}$ , then we say that  $f$  tends to  $\infty$  [respectively,  $-\infty$ ] as  $x \rightarrow c+$ , and we write

$$\lim_{x \rightarrow c+} f = \infty \left[ \text{respectively, } \lim_{x \rightarrow c+} f = -\infty \right],$$

if for every  $\alpha \in \mathbb{R}$  there is  $\delta = \delta(\alpha) > 0$  such that for all  $x \in A$  with  $0 < x - c < \delta$ , then  $f(x) > \alpha$  [respectively,  $f(x) < \alpha$ ].

**4.3.8 Definisi** Misalkan  $A \subseteq \mathbb{R}$  dan  $f: A \rightarrow \mathbb{R}$ . Jika  $c \in \mathbb{R}$  adalah titik cluster dari set  $A \cap (c, \infty) = \{x \in A : x > c\}$ , maka kita katakan bahwa  $f$  cenderung  $\infty$  [atau,  $-\infty$ ] sebagai  $x \rightarrow c+$ , dan kita tulis

$$\lim_{x \rightarrow c+} f = \infty \left[ \text{atau, } \lim_{x \rightarrow c+} f = -\infty \right],$$

Jika untuk setiap  $\alpha \in \mathbb{R}$  ada  $\delta = \delta(\alpha) > 0$  sehingga untuk semua  $x \in A$  dengan  $0 < x - c < \delta$ , maka  $f(x) > \alpha$  [atau,  $f(x) < \alpha$ ].

<p><b>Notasi Matematika D.4.3.8</b>  <math>A \subseteq \mathbb{R}</math> dan <math>f: A \rightarrow \mathbb{R}</math>. <math>c \in \mathbb{R}</math> adalah titik clustert dari <math>A \cap (c, \infty) = \{x \in A : x &gt; c\}</math>, <math>f \rightarrow \infty</math> [atau, <math>-\infty</math>], <math>x \rightarrow c+</math>, ditulis <math>\lim_{x \rightarrow c+} f = \infty</math> [atau, <math>\lim_{x \rightarrow c+} f = -\infty</math>], <math>\forall \alpha \in \mathbb{R}</math>, <math>\delta = \delta(\alpha) &gt; 0 \rightarrow x \in A</math>, <math>0 &lt; x - c &lt; \delta</math>, <math>f(x) &gt; \alpha</math> [atau, <math>f(x) &lt; \alpha</math>].</p>	<p><b>Kontraposisi dari D.4.3.8</b>  <math>A \not\subseteq \mathbb{R}</math> dan <math>f: A \not\rightarrow \mathbb{R}</math>. <math>c \notin \mathbb{R}</math> adalah bukan titik clustert dari <math>A \cap (c, \infty) \neq \{x \notin A : x &lt; c\}</math>, <math>f \not\rightarrow \infty</math> [atau, <math>-\infty</math>], <math>x \not\rightarrow c+</math>, ditulis <math>\lim_{x \rightarrow c+} f \neq \infty</math> [atau, <math>\lim_{x \rightarrow c+} f \neq -\infty</math>], <math>\forall \alpha \notin \mathbb{R}</math>, <math>\delta \neq \delta(\alpha) &lt; 0 \rightarrow x \notin A</math>, <math>0 &gt; x - c &gt; \delta</math>, <math>f(x) &lt; \alpha</math> [atau, <math>f(x) &gt; \alpha</math>].</p>
<p><b>Poin Penting dari D.4.3.8</b></p> <ol style="list-style-type: none"> <li><math>A \subseteq \mathbb{R}</math></li> <li><math>f: A \rightarrow \mathbb{R}</math></li> <li><math>c \in \mathbb{R}</math> adalah titik clustert</li> <li><math>A \cap (c, \infty) = \{x \in A : x &gt; c\}</math></li> <li><math>f \rightarrow \infty</math> [atau, <math>-\infty</math>]</li> <li><math>x \rightarrow c+</math></li> <li><math>\lim_{x \rightarrow c+} f = \infty</math> [atau, <math>\lim_{x \rightarrow c+} f = -\infty</math>]</li> <li><math>\forall \alpha \in \mathbb{R}</math></li> <li><math>\delta = \delta(\alpha) &gt; 0 \rightarrow x \in A</math></li> </ol>	<p><b>Poin Penting Kontraposisi dari D.4.3.8</b></p> <ol style="list-style-type: none"> <li><math>A \not\subseteq \mathbb{R}</math></li> <li><math>f: A \not\rightarrow \mathbb{R}</math></li> <li><math>c \notin \mathbb{R}</math> adalah bukan titik clustert</li> <li><math>A \cap (c, \infty) \neq \{x \notin A : x &lt; c\}</math></li> <li><math>f \not\rightarrow \infty</math> [atau, <math>-\infty</math>]</li> <li><math>x \not\rightarrow c+</math></li> <li><math>\lim_{x \rightarrow c+} f \neq \infty</math> [atau, <math>\lim_{x \rightarrow c+} f \neq -\infty</math>]</li> <li><math>\forall \alpha \notin \mathbb{R}</math></li> <li><math>\delta \neq \delta(\alpha) &lt; 0 \rightarrow x \notin A</math></li> </ol>

10. $0 < x - c < \delta$ 11. $f(x) > \alpha$ [atau, $f(x) < \alpha$ ].	10. $0 > x - c > \delta$ 11. $f(x) < \alpha$ [atau, $f(x) > \alpha$ ].
---	---

**4.3.9 Example** (a) Let  $g(x) := \frac{1}{x}$  for  $x \neq 0$ . We have noted in example 4.3.6(b) that  $\lim_{x \rightarrow 0} g$  does not exist. However, it is an easy exercise to show that

$$\lim_{x \rightarrow 0^+} \left(\frac{1}{x}\right) = \infty \text{ and } \lim_{x \rightarrow 0^-} \left(\frac{1}{x}\right) = -\infty.$$

(b) It was seen in example 4.3.4(b) that the function  $g(x) := e^{\frac{1}{x}}$  for  $x \neq 0$  is not bounded on any interval  $(0, \delta)$ ,  $\delta > 0$ . Hence the right-hand limit of  $e^{\frac{1}{x}}$  as  $x \rightarrow 0^+$  does not exist in the sense of Definition 4.3.1(i). However, since

$$\frac{1}{x} < e^{\frac{1}{x}}, \text{ for } x > 0,$$

It is readily seen that  $\lim_{x \rightarrow 0^+} e^{\frac{1}{x}} = \infty$  in the sense of Definition 4.3.8

■

**Limits at Infinity**

It is also desirable to define the notion of the limit of a function as  $x \rightarrow \infty$ . The definition as  $x \rightarrow -\infty$ . Is similar.

**Contoh 4.3.9** (a) Misalkan  $g(x) := \frac{1}{x}$  untuk  $x \neq 0$ . Kita telah menjelaskan pada contoh 4.3.6(b) bahwa  $\lim_{x \rightarrow 0} g$  tidak ada. Namun, hal tersebut merupakan latihan yang mudah untuk menunjukkan bahwa

$$\lim_{x \rightarrow 0^+} \left(\frac{1}{x}\right) = \infty \text{ dan } \lim_{x \rightarrow 0^-} \left(\frac{1}{x}\right) = -\infty.$$

(b) Hal tersebut telah dilihat pada contoh 4.3.4(b) bahwa fungsi  $g(x) := e^{\frac{1}{x}}$  untuk  $x \neq 0$  tidak dibatasi pada beberapa interval  $(0, \delta)$ ,  $\delta > 0$ . Oleh karena ruas kanan pada limit  $e^{\frac{1}{x}}$  dengan  $x \rightarrow 0^+$  tidak ada dalam pengertian Definisi 4.3.1(i). Namun, karena

$$\frac{1}{x} < e^{\frac{1}{x}}, \text{ untuk } x > 0,$$

Ini dengan mudah bahwa  $\lim_{x \rightarrow 0^+} e^{\frac{1}{x}} = \infty$  dalam pengertian Definisi

4.3.8 ■

**Limit tak Hingga**

Juga diinginkan untuk mendefisikan pengertian batas limit fungsi sebagai  $x \rightarrow \infty$ . Definisi sebagai  $x \rightarrow -\infty$ . Sama.

<p><b>Alternatif Jawaban dari C. 4.3.9 (a)</b>  <math>\lim_{x \rightarrow 0^+} \left(\frac{1}{x}\right) = \infty</math> dan <math>\lim_{x \rightarrow 0^-} \left(\frac{1}{x}\right) = -\infty \rightarrow</math> Bukti?  <b>Bukti:</b>                  Misalkan <math>g(x) := \frac{1}{x}</math> untuk <math>x \neq 0</math>. (lihat contoh 4.3.6(b)).                  Fungsi <math>g</math> tidak menuju ke <math>\infty</math> atau <math>-\infty</math> untuk <math>\lim_{x \rightarrow 0} g</math> tidak ada.                  Maka <math>\lim_{x \rightarrow 0^+} \left(\frac{1}{x}\right) = \infty</math>                  Diberikan sebarang <math>a &gt; 0^+, \exists \delta(a)</math>                  Misalkan <math>\delta := \frac{1}{\sqrt{a}}</math>. Ini berarti bahwa jika <math>0^+ &lt;  x  &lt; \delta</math>, maka  <math>0^+ &lt;  x  &lt; \frac{1}{\sqrt{a}}</math>  <math>\Leftrightarrow x &lt; \frac{1}{a}</math> (Berdasarkan T. 2.2.1) <math>\Leftrightarrow \frac{1}{x} &gt; a</math>                  Jadi, <math>\lim_{x \rightarrow 0^+} \left(\frac{1}{x}\right) = \infty</math> (Terbukti).                  Dan <math>\lim_{x \rightarrow 0^-} \left(\frac{1}{x}\right) = -\infty</math>                  Diberikan sebarang <math>a &gt; 0^-, \exists \delta(a)</math>                  Misalkan <math>\delta := \frac{1}{\sqrt{a}}</math>. Ini berarti bahwa jika <math>0^- &lt;  x  &lt; \delta</math>, maka  <math>0^- &lt;  x  &lt; \frac{1}{\sqrt{a}}</math>  <math>\Leftrightarrow x &lt; \frac{1}{a}</math> (Berdasarkan T. 2.2.1) <math>\Leftrightarrow \frac{1}{x} &gt; a</math>                  Sehingga <math>g(x) &gt; a</math>                  Jadi, <math>\lim_{x \rightarrow 0^-} \left(\frac{1}{x}\right) = -\infty</math> (Terbukti).</p>	<p><b>Poin Penting dari C. 4.3.9 (a)</b></p> <ol style="list-style-type: none"> <li><math>g(x) := \frac{1}{x}</math> untuk <math>x \neq 0</math>.</li> <li>Fungsi <math>g</math> tidak menuju ke <math>\infty</math> atau <math>-\infty</math> untuk <math>\lim_{x \rightarrow 0} g</math> tidak ada</li> <li><math>\lim_{x \rightarrow 0^+} \left(\frac{1}{x}\right) = \infty</math></li> <li><math>a &gt; 0^+, \exists \delta(a)</math></li> <li><math>\delta := \frac{1}{\sqrt{a}}</math></li> <li><math>0^+ &lt;  x  &lt; \delta</math></li> <li><math>0^+ &lt;  x  &lt; \frac{1}{\sqrt{a}}</math></li> <li><math>x &lt; \frac{1}{a}</math> (Berdasarkan T. 2.2.1) <math>\Leftrightarrow \frac{1}{x} &gt; a</math></li> <li><math>\lim_{x \rightarrow 0^-} \left(\frac{1}{x}\right) = -\infty</math></li> <li><math>a &gt; 0^-, \exists \delta(a)</math></li> <li><math>\delta := \frac{1}{\sqrt{a}}</math></li> <li><math>0^- &lt;  x  &lt; \delta</math></li> <li><math>0^- &lt;  x  &lt; \frac{1}{\sqrt{a}}</math></li> </ol>
<p><b>Alternatif Jawaban dari C. 4.3.9 (b)</b>  <math>\lim_{x \rightarrow 0^+} e^{\frac{1}{x}} = \infty \rightarrow</math> Bukti?  <b>Bukti:</b>                  Berdasarkan D. 4.3.8                  Misalkan <math>g(x) := e^{\frac{1}{x}}</math> untuk <math>x \neq 0</math>  <math>A \subseteq \mathbb{R}</math> dan <math>g: A \rightarrow \mathbb{R}</math>. Jika <math>0 \in \mathbb{R}</math> suatu titik kumpul dari  <math>A \cap (0, \infty) = \{x \in A: x &gt; 0\}</math>, Maka kita mengatakan bahwa <math>g</math></p>	<p><b>Poin Penting dari C. 4.3.9 (b)</b></p> <ol style="list-style-type: none"> <li><math>\lim_{x \rightarrow 0^+} e^{\frac{1}{x}} = \infty</math></li> <li><math>g(x) := e^{\frac{1}{x}}</math> untuk <math>x \neq 0</math></li> <li><math>A \subseteq \mathbb{R}</math> dan <math>g: A \rightarrow \mathbb{R}</math></li> <li><math>0 \in \mathbb{R}</math> suatu titik kumpul dari <math>A \cap (0, \infty) = \{x \in A: x &gt; 0\}</math></li> <li><math>g</math> menuju <math>\infty</math> apabila <math>x \rightarrow 0^+</math></li> <li><math>\lim_{x \rightarrow 0^+} g(x) = \infty</math></li> </ol>

<p>menuju <math>\infty</math> apabila <math>x \rightarrow 0^+</math>, dan dapat ditulis</p> $\lim_{x \rightarrow 0^+} g(x) = \infty$ $\lim_{x \rightarrow 0^+} e^{\frac{1}{x}} = \infty$ <p>Jika <math>\forall a \in \mathbb{R} \exists \delta = \delta(a) &gt; 0 \ni \forall x \in A</math> dengan <math>0^+ &lt; x &lt; \delta</math>, maka</p> $g(x) > a$ <p>Jadi, <math>\lim_{x \rightarrow 0^+} e^{\frac{1}{x}} = \infty</math> (Terbukti).</p>	<p>7. <math>\forall a \in \mathbb{R} \exists \delta = \delta(a) &gt; 0 \ni \forall x \in A</math></p> <p>8. <math>0^+ &lt; x &lt; \delta</math></p> <p>9. <math>g(x) &gt; a</math></p>
--	--

**4.3.10 Definition** Let  $A \subseteq \mathbb{R}$  and let  $f: A \rightarrow \mathbb{R}$ . Suppose that  $(a, \infty) \subseteq A$  for some  $a \in \mathbb{R}$ . We say that  $L \in \mathbb{R}$  is a **limit of  $f$  as  $x \rightarrow \infty$** , and write

$$\lim_{x \rightarrow \infty} f = L \text{ or } \lim_{x \rightarrow \infty} f(x) = L$$

If given any  $\varepsilon > 0$  there exists  $K = K(\varepsilon) > a$  such that for any  $x > K$ , then  $|f(x) - L| < \varepsilon$ .

The reader should note the close resemblance between 4.3.10 and the definition of a limit of a sequence.

We leave it to the reader to show that the limits of  $f$  as  $x \rightarrow \pm\infty$ , are unique whenever they exist. We also have sequential criteria for these limits; we shall only state the criterion as  $x \rightarrow \infty$ . This uses the notion of the limit of a properly divergent sequence (see Definition 3.6.1).

**4.3.10 Definisi**

Misalkan  $A \subseteq \mathbb{R}$  dan  $f: A \rightarrow \mathbb{R}$ . Dibuktikan bahwa  $(a, \infty) \subseteq A$  untuk beberapa  $a \in \mathbb{R}$ . Kita katakan bahwa  $L \in \mathbb{R}$  adalah sebuah limit dari  $f$  sebagaimana  $x \rightarrow \infty$ , dan ditulis

$$\lim_{x \rightarrow \infty} f = L \text{ atau } \lim_{x \rightarrow \infty} f(x) = L$$

Jika diberikan sebarang  $\varepsilon > 0$  ada  $K = K(\varepsilon) > a$  demikian bahwa sebarang  $x > K$ , kemudian  $|f(x) - L| < \varepsilon$ .

Pembaca diharuskan mencatat persamaan definisi 4.3.10 dan definisi dari limit sebuah barisan.

Pembaca agar bisa menunjukkan bahwa limit dari  $x \rightarrow \pm\infty$ , ada kekhususan sendiri apabila mereka ada. Kita juga memiliki kriteria berturut-turut untuk limit ini, kita hanya akan menyatakan  $x \rightarrow \infty$ . Ini menggunakan pengertian dari limit dari sebuah layaknya barisan divergen (*lihat Definisi 3.6.1*).

Definisi 3.6.1

Misalkan  $(x_n)$  menjadi sebuah barisan dari bilangan real.

- i. Kita katakan bahwa  $(x_n)$  cenderung kepada  $\pm\infty$ , dan ditulis  $\lim (x_n) = +\infty$ , jika untuk setiap  $a \in \mathbb{R}$  ada sebarang bilangan asli  $K(a)$  demikian bahwa jika  $n \geq K(a)$ , maka  $x_n \geq a$ .



- ii. Kita katakan bahwa  $(x_n)$  cenderung kepada  $-\infty$ , dan ditulis  $\lim (x_n) = -\infty$ , jika untuk setiap  $\beta \in \mathbb{R}$  ada sebarang bilangan asli  $K(\beta)$  demikian bahwa jika  $n \geq K(\beta)$ , maka  $x_n \geq \beta$ .

Kita katakan bahwa  $(x_n)$  adalah layakanya divergen dalam kasus ini kita mempunyai salah satu  $\lim (x_n) = +\infty$  atau  $\lim (x_n) = -\infty$ .

Pembaca harus merealisasikan bahwa menggunakan symbol  $+\infty$  dan  $-\infty$  secara murni sebagai notasi yang mudah digunakan khususnya untuk ekspresi diatas. Mengakibatkan bahwa memiliki bukti untuk bagian limit tadi yang biasa  $\lim (x_n) = L$  untuk  $L \in \mathbb{R}$  sejatinya tidak boleh tersisa (tetap) ketika  $\lim (x_n) = \pm\infty$ .

<p><b>Notasi Matematika dari D. 4.3.10</b>  <math>A \subseteq \mathbb{R}</math> dan <math>f: A \rightarrow \mathbb{R}</math>, <math>(a, \infty) \subseteq A \forall a \in \mathbb{R}</math>. <math>L \in \mathbb{R}</math> limit dari <math>f</math>, <math>x \rightarrow \infty</math>, <math>\lim_{x \rightarrow \infty} f = L</math> atau <math>\lim_{x \rightarrow \infty} f(x) = L</math>, <math>\varepsilon &gt; 0</math> ada <math>K = K(\varepsilon) &gt; a</math>, <math>x &gt; K</math>, <math> f(x) - L  &lt; \varepsilon</math>.</p>	<p><b>Poin Penting Notasi Matematika dari D. 4.3.10</b></p> <ol style="list-style-type: none"> <li>1. <math>A \subseteq \mathbb{R}</math></li> <li>2. <math>f: A \rightarrow \mathbb{R}</math></li> <li>3. <math>(a, \infty) \subseteq A \forall a \in \mathbb{R}</math></li> <li>4. <math>L \in \mathbb{R}</math> limit dari <math>f</math>, <math>x \rightarrow \infty</math></li> <li>5. <math>\lim_{x \rightarrow \infty} f = L</math> atau <math>\lim_{x \rightarrow \infty} f(x) = L</math></li> <li>6. <math>\varepsilon &gt; 0</math></li> <li>7. <math>K = K(\varepsilon) &gt; a</math></li> <li>8. <math>x &gt; K</math></li> <li>9. <math> f(x) - L  &lt; \varepsilon</math></li> </ol>
<p><b>Kontrapositif dari D. 4.3.10</b>  <math>A \subseteq \mathbb{R}</math> dan <math>f: A \rightarrow \mathbb{R}</math>, <math>(a, \infty) \subseteq A \exists a \in \mathbb{R}</math>. <math>L \in \mathbb{R}</math> bukan limit dari <math>f</math>, <math>x \rightarrow \infty</math>, <math>\lim_{x \rightarrow \infty} f \neq L</math> atau <math>\lim_{x \rightarrow \infty} f(x) \neq L</math>, <math>\varepsilon &gt; 0</math> tidak ada <math>K = K(\varepsilon) &gt; a</math>, <math>x &gt; K</math>, <math> f(x) - L  &lt; \varepsilon</math>.</p>	<p><b>Poin Penting Kontrapositif dari D. 4.3.10</b></p> <ol style="list-style-type: none"> <li>1. <math>A \subseteq \mathbb{R}</math></li> <li>2. <math>f: A \rightarrow \mathbb{R}</math></li> <li>3. <math>(a, \infty) \subseteq A \exists a \in \mathbb{R}</math></li> <li>4. <math>L \in \mathbb{R}</math> bukan limit dari <math>f</math>, <math>x \rightarrow \infty</math></li> <li>5. <math>\lim_{x \rightarrow \infty} f \neq L</math> atau <math>\lim_{x \rightarrow \infty} f(x) \neq L</math></li> <li>6. <math>\varepsilon &gt; 0</math></li> </ol>

	7. $K = K(\varepsilon) > a$ 8. $x > K$ 9. $ f(x) - L  < \varepsilon$
--	--

**4.3.11 Theorem** *Let  $A \subseteq \mathbb{R}$ , let  $f: A \rightarrow \mathbb{R}$ , and suppose that  $(a, \infty) \subseteq A$  for some  $a \in \mathbb{R}$ . Then the following statements are equivalent:*

- (i)  $L = \lim_{x \rightarrow \infty} f$ .
- (ii) For every sequence  $(x_n)$  in  $A \cap (a, \infty)$  such that  $\lim(x_n) = \infty$ , the sequence  $(f(x_n))$  converges to  $L$ .

We leave it to the reader to prove this theorem and to formulate and prove the companion result concerning the limit as  $x \rightarrow -\infty$ .

**Teorema 4.3.11** *Misalkan  $A \subseteq \mathbb{R}$ , misalkan  $f: A \rightarrow \mathbb{R}$ , dan anggaplah bahwa  $(a, \infty) \subseteq A$  untuk suatu  $a \in \mathbb{R}$ . Maka pernyataan-pernyataan berikut ini ekuivalen:*

- (i)  $L = \lim_{x \rightarrow \infty} f$ .
- (ii) Untuk setiap barisan  $(x_n)$  dalam  $A \cap (a, \infty)$  sedemikian sehingga  $\lim(x_n) = \infty$ , barisan  $(f(x_n))$  konvergen ke  $L$ .

Kita tinggalkan bagi pembaca untuk membuktiksn teorema ini dan untuk merumuskan dan membuktikan pendamping tentang hasil limit dimana  $x \rightarrow -\infty$ .

<p><b>Notasi Matematika dari T 4.3.11</b>  <math>A \subseteq \mathbb{R}, f: A \rightarrow \mathbb{R}, (a, \infty) \subseteq A \forall a \in \mathbb{R} \rightarrow</math>equivalen:</p> <ul style="list-style-type: none"> <li>(i) <math>L = \lim_{x \rightarrow \infty} f</math>.</li> <li>(ii) <math>\forall (x_n)</math> dalam <math>A \cap (a, \infty) \ni \lim(x_n) = \infty</math>, barisan <math>(f(x_n))</math> konvergen ke <math>L</math>.</li> </ul>	<p><b>Kontrapositif dari T 4.3.11</b>  <math>A \not\subseteq \mathbb{R}, f: A \not\rightarrow \mathbb{R}, (a, \infty) \not\subseteq A \exists a \in \mathbb{R} \rightarrow</math>tidak equivalen:</p> <ul style="list-style-type: none"> <li>(i) <math>L \neq \lim_{x \rightarrow \infty} f</math>.</li> <li>(ii) <math>\exists (x_n)</math> dalam <math>A \cap (a, \infty) \ni \lim(x_n) \neq \infty</math>, barisan <math>(f(x_n))</math> tidak konvergen ke <math>L</math>.</li> </ul>
---	---

<p><b>Poin Penting dari T 4.3.11</b></p> <ol style="list-style-type: none"> <li><math>A \subseteq \mathbb{R}</math></li> <li><math>f: A \rightarrow \mathbb{R}</math></li> <li><math>(a, \infty) \subseteq A \forall a \in \mathbb{R}</math></li> <li><math>L = \lim_{x \rightarrow \infty} f</math></li> <li><math>\forall (x_n)</math> di <math>A \cap (a, \infty)</math></li> <li><math>\lim(x_n) = \infty</math></li> <li>Barisan <math>(f(x_n))</math> konvergen ke <math>L</math></li> </ol>	<p><b>Poin Penting dari Kontrapositif T 4.3.11</b></p> <ol style="list-style-type: none"> <li><math>A \not\subseteq \mathbb{R}</math></li> <li><math>f: A \not\rightarrow \mathbb{R}</math></li> <li><math>(a, \infty) \not\subseteq A \exists a \in \mathbb{R}</math></li> <li><math>L \neq \lim_{x \rightarrow \infty} f</math></li> <li><math>\exists (x_n)</math> di <math>A \cap (a, \infty)</math></li> <li><math>\lim(x_n) \neq \infty</math></li> <li>Barisan <math>(f(x_n))</math> tidak konvergen ke <math>L</math></li> </ol>
<p><b>Alternatif Bukti dari T 4.3.11</b>  <math>A \subseteq \mathbb{R}, f: A \rightarrow \mathbb{R}, (a, \infty) \subseteq A \forall a \in \mathbb{R} \rightarrow \text{equivalen:}</math></p> <p>(i) <math>L = \lim_{x \rightarrow \infty} f.</math>  (ii) <math>\forall (x_n)</math> dalam <math>A \cap (a, \infty) \ni \lim(x_n) = \infty</math>, barisan <math>(f(x_n))</math> konvergen ke <math>L.</math></p> <p>(i) <math>\rightarrow</math> (ii) <math>\Rightarrow</math> Bukti?  (ii) <math>\rightarrow</math> (i) <math>\Rightarrow</math> Bukti?</p> <p><b>Bukti:</b>  (i) <math>\rightarrow</math> (ii)  Anggaplah <math>f</math> mempunyai limit <math>L</math> pada <math>\infty</math>, dan asumsikan <math>(x_n)</math> barisan dalam <math>A \cap (a, \infty)</math> dengan <math>\lim(x_n) = \infty</math> dan <math>x_n \neq \infty \forall n \in \mathbb{N}</math>. Akan ditunjukkan bahwa barisan <math>(f(x_n))</math> konvergen ke <math>L</math>.  Berdasarkan D. 4.3.10 untuk sebarang <math>\varepsilon &gt; 0</math> maka terdapat <math>K = K(\varepsilon) &gt; a</math> sedemikian sehingga untuk setiap <math>x &gt; K</math>, maka <math> f(x) - L  &lt; \varepsilon</math>, dimana <math>x \in \mathbb{A}</math> sehingga <math>f(x)</math> memenuhi <math> f(x) - L  &lt; \varepsilon</math>. Berdasarkan definisi konvergenan barisan untuk <math>\delta</math> yang diberikan maka terdapat bilangan asli <math>K(\delta)</math> sedemikian sehingga jika <math>n &gt; K(\delta)</math> maka <math> x_n - \infty  &lt; \delta</math>. Tetapi untuk setiap <math>x_n</math> yang demikian kita mempunyai <math> f(x) - L  &lt; \varepsilon</math>. Jadi, jika <math>n &gt; K(\delta)</math></p>	<p><b>Poin Penting Alternatif Bukti dari T. 4.3.11 (i) <math>\rightarrow</math> (ii)</b></p> <ol style="list-style-type: none"> <li><math>f</math> mempunyai limit <math>L</math> pada <math>\infty</math></li> <li><math>(x_n)</math> barisan dalam <math>A \cap (a, \infty)</math> dengan <math>\lim(x_n) = \infty</math> dan <math>x_n \neq \infty \forall n \in \mathbb{N}</math></li> <li><math>\varepsilon &gt; 0</math></li> <li><math>K = K(\varepsilon) &gt; a</math></li> <li><math>\forall x &gt; K</math>, maka <math> f(x) - L  &lt; \varepsilon</math>, dimana <math>x \in \mathbb{A}</math> sehingga <math>f(x)</math> memenuhi <math> f(x) - L  &lt; \varepsilon</math>.</li> <li>Jika <math>n &gt; K(\delta)</math> maka <math> x_n - \infty  &lt; \delta</math></li> <li>Jika <math>n &gt; K(\delta)</math> maka <math> f(x) - L  &lt; \varepsilon</math></li> <li>Barisan <math>(f(x_n))</math> konvergen ke <math>L</math></li> </ol>

<p>maka <math> f(x) - L  &lt; \varepsilon</math>. Terbukti, barisan <math>(f(x_n))</math> konvergen ke <math>L</math>.</p>	
<p><b>(ii) <math>\rightarrow</math> (i)</b>                  Jika (i) tidak benar, maka terdapat <math>V_{\varepsilon_0}(L)</math> sedemikian sehingga <math>V_\delta</math> apapun yang kita pilih, akan selalu terdapat paling tidak satu <math>x_\delta</math> dalam <math>A \cap V_{\delta(c)}</math> dengan <math>x_\delta \neq c</math> sedemikian sehingga <math>f(x_\delta) \notin V_{\varepsilon_0}(L)</math>. Dari sini untuk setiap <math>n \in \mathbb{N}</math>, persekitaran <math>(\frac{1}{n})</math> dari <math>\infty</math> memuat suatu bilangan <math>x_n</math> sedemikian sehingga <math>0 &lt;  x_n - c  &lt; \frac{1}{n}</math> dan <math>x_n \in A</math>.                  Tetapi sedemikian sehingga <math> f(x_n) - L  \geq \varepsilon_0 \forall n \in \mathbb{N}</math>. Kita menyimpulkan bahwa barisan <math>(x_n)</math> dalam <math>A \setminus \{\infty\}</math> konvergen ke <math>\infty</math>, tetapi barisan <math>(f(x_n))</math> tidak konvergen ke <math>L</math>. Oleh karena itu kita telah menunjukkan bahwa jika (i) tidak benar, maka (ii) tidak benar. Jadi, kita simpulkan bahwa (ii) menyebabkan (i).</p>	<p><b>Poin Penting Alternatif Bukti dari T. 4.3.11 (ii) <math>\rightarrow</math> (i)</b></p> <ol style="list-style-type: none"> <li>1. Jika (i) tidak benar, maka terdapat <math>V_{\varepsilon_0}(L)</math></li> <li>2. <math>V_\delta</math> apapun yang kita pilih, akan selalu terdapat paling tidak satu <math>x_\delta</math> dalam <math>A \cap V_{\delta(c)}</math> dengan <math>x_\delta \neq c</math></li> <li>3. <math>f(x_\delta) \notin V_{\varepsilon_0}(L)</math></li> <li>4. <math>0 &lt;  x_n - c  &lt; \frac{1}{n}</math> dan <math>x_n \in A</math></li> <li>5. <math> f(x_n) - L  \geq \varepsilon_0 \forall n \in \mathbb{N}</math></li> <li>6. Barisan <math>(x_n)</math> dalam <math>A \setminus \{\infty\}</math> konvergen ke <math>\infty</math></li> <li>7. Tetapi barisan <math>(f(x_n))</math> tidak konvergen ke <math>L</math></li> <li>8. (ii) menyebabkan (i)</li> </ol>

**4.3.12 Examples (a)** Let  $g(x) := 1/x$  for  $x \neq 0$ .

It is an elementary exercise to show that  $\lim_{x \rightarrow \infty} (1/x) = 0 = \lim_{x \rightarrow -\infty} (1/x)$ . (See Figure 4.3.4.)

**(b)** Let  $f(x) := 1/x^2$  for  $x \neq 0$ .

The reader may show that  $\lim_{x \rightarrow \infty} (\frac{1}{x^2}) = 0 = \lim_{x \rightarrow -\infty} (\frac{1}{x^2})$ . (See Figure 4.3.3.) One way to do this is to show that if  $x \geq 1$  then  $0 \leq \frac{1}{x^2} \leq \frac{1}{x}$ . In view of part (a), this implies that  $\lim_{x \rightarrow \infty} (\frac{1}{x^2}) = 0$ .

Just as it is convenient to be able to say that  $f(x) \rightarrow \pm\infty$  as

**4.3.12 Contoh (a)** Misalkan  $g(x) := 1/x$  untuk  $x \neq 0$ .

Itu adalah latihan dasar untuk menunjukkan bahwa  $\lim_{x \rightarrow \infty} (1/x) = 0 = \lim_{x \rightarrow -\infty} (1/x)$ . (Lihat gambar 4.3.4.)

**(b)** Misalkan  $f(x) := 1/x^2$  untuk  $x \neq 0$ .

Pembaca boleh menunjukkan bahwa  $\lim_{x \rightarrow \infty} (\frac{1}{x^2}) = 0 = \lim_{x \rightarrow -\infty} (\frac{1}{x^2})$ . (Lihat gambar 4.3.3.) Salah satu cara untuk melakukan ini adalah untuk menunjukkan bahwa jika  $x \geq 1$  maka  $0 \leq \frac{1}{x^2} \leq \frac{1}{x}$ . Berdasarkan bagian (a), ini mengakibatkan bahwa

■  $\lim_{x \rightarrow \infty} (\frac{1}{x^2}) = 0$ . ■

### 4.3 Some Extension of the Limit Concept

$x \rightarrow c$  for  $c \in \mathbb{R}$ , it is convenient to have the corresponding notion as  $x \rightarrow \pm\infty$ . We will treat the case where  $x \rightarrow \infty$ .

### 4.3 Beberapa Ekstensi dari Konsep Limit

Seperti itu mudah untuk dapat dikatakan bahwa  $f(x) \rightarrow \pm\infty$  ketika  $x \rightarrow c$  untuk  $c \in \mathbb{R}$ , itu sangat mudah untuk memperoleh nilai yang sesuai untuk  $x \rightarrow \pm\infty$ . Kita akan menghilangkan kasus dimana  $x \rightarrow \infty$ .

#### Alternatif Jawaban dari C. 4.3.12 (a)

$\lim_{x \rightarrow \infty}(1/x) = 0 = \lim_{x \rightarrow -\infty}(1/x) \rightarrow$  Bukti?

#### Bukti:

Misalkan  $g(x) := 1/x$  untuk  $x \neq 0$

Menunjukkan bahwa  $\lim_{x \rightarrow \infty}(1/x) = 0 = \lim_{x \rightarrow -\infty}(1/x)$ . (Lihat gambar 4.3.4.)

Dengan menggunakan D.4.3.10 sehingga  $\forall \varepsilon > 0, \exists k \in \mathbb{N} \rightarrow \left| \frac{1}{x} - 0 \right| < \varepsilon, x \geq k$

Disederhanakan ekspresi harga mutlaknya menjadi  $\frac{1}{x} < \varepsilon$ . Karena  $x \geq k$  maka menurut Teorema ketidaksamaan, berlaku  $\frac{1}{x} \leq \frac{1}{k}$ .

Maka  $\lim_{x \rightarrow \infty} \left( \frac{1}{x} \right) = 0$

Ambil sebarang  $\varepsilon > 0 \exists \frac{1}{\varepsilon} > 0$  karena  $\varepsilon \in \mathbb{R}$  maka berdasarkan

2.4.3 terdapat  $k \in \mathbb{N} \exists \frac{1}{\varepsilon} < k \rightarrow \frac{1}{k} < \varepsilon \rightarrow \left| \frac{1}{k} - 0 \right| < \varepsilon$  digunakan

$\frac{1}{x} \leq \frac{1}{k}$  maka diperoleh  $\frac{1}{x} \leq \frac{1}{k} < \varepsilon \exists \left| \frac{1}{x} - 0 \right| < \varepsilon$  yang tepat sesuai dengan definisi tersebut.

Jadi  $\lim_{x \rightarrow \infty}(1/x) = 0$  terbukti

Sehingga  $\lim_{x \rightarrow \infty}(1/x) = 0 = \lim_{x \rightarrow -\infty}(1/x) \rightarrow \lim_{x \rightarrow \infty}(1/x) = 0$

Jadi,  $\lim_{x \rightarrow \infty}(1/x) = 0 \leftrightarrow \lim_{x \rightarrow \infty}(1/x) = 0 = \lim_{x \rightarrow -\infty}(1/x)$  terbukti

#### Poin Penting dari C. 4.3.12 (a)

1.  $g(x) := 1/x$  untuk  $x \neq 0$

2.  $\lim_{x \rightarrow \infty} \left( \frac{1}{x} \right) = 0 = \lim_{x \rightarrow -\infty} \left( \frac{1}{x} \right)$

3.  $\forall \varepsilon > 0$

4.  $\exists k \in \mathbb{N} \rightarrow \left| \frac{1}{x} - 0 \right| < \varepsilon$

5.  $x \geq k$

6.  $\frac{1}{x} < \varepsilon$

7.  $\frac{1}{x} \leq \frac{1}{k}$

8.  $\varepsilon > 0 \exists \frac{1}{\varepsilon} < 0$

9.  $\varepsilon \in \mathbb{R}$

10.  $k \in \mathbb{N} \exists \frac{1}{\varepsilon} < k \rightarrow \frac{1}{k} < \varepsilon \rightarrow \left| \frac{1}{k} - 0 \right| < \varepsilon$

11.  $\frac{1}{x} \leq \frac{1}{k} < \varepsilon \exists \left| \frac{1}{x} - 0 \right| < \varepsilon$

12.  $\lim_{x \rightarrow \infty}(1/x) = 0$  terbukti

13.  $\lim_{x \rightarrow \infty}(1/x) = 0 = \lim_{x \rightarrow -\infty}(1/x) \rightarrow \lim_{x \rightarrow \infty}(1/x) = 0$

14.  $\lim_{x \rightarrow \infty}(1/x) = 0 \leftrightarrow \lim_{x \rightarrow \infty}(1/x) = 0 = \lim_{x \rightarrow -\infty}(1/x)$

**Alternatif Jawaban dari C. 4.3.12 (b)**

$$\lim_{x \rightarrow \infty} \left( \frac{1}{x^2} \right) = 0 = \lim_{x \rightarrow -\infty} \left( \frac{1}{x^2} \right) \rightarrow \text{Bukti?}$$

**Bukti:**

$$f(x) := 1/x^2 \text{ untuk } x \neq 0$$

$$\lim_{x \rightarrow \infty} \left( \frac{1}{x^2} \right) = 0$$

$$\text{Jika } \forall \varepsilon > 0, \exists \delta = \delta(\varepsilon) > 0 \ni \forall x \in A, 0 < |x - \infty| < \delta \rightarrow \left| \frac{1}{x^2} - 0 \right| < \varepsilon$$

$$\lim_{x \rightarrow -\infty} \left( \frac{1}{x^2} \right) = 0$$

$$\text{Jika } \forall \varepsilon > 0, \exists \delta = \delta(\varepsilon) > 0 \ni \forall x \in A, 0 < |\infty - x| < \delta \rightarrow \left| \frac{1}{x^2} - 0 \right| < \varepsilon$$

Karena  $0 < x - \infty < \delta$  dan  $0 < \infty - x < \delta$  sehingga  $0 < |x - \infty| < \delta$  kemudian  $\forall \varepsilon > 0, \exists \delta = \delta(\varepsilon) > 0 \ni \forall x \in A, 0 < |x - \infty| < \delta \rightarrow \left| \frac{1}{x^2} - 0 \right| < \varepsilon$

Sehingga berdasarkan D.4.1.4 diperoleh  $\lim_{x \rightarrow \infty} \left( \frac{1}{x^2} \right) = 0$

$$\text{Jadi, } \lim_{x \rightarrow \infty} \left( \frac{1}{x^2} \right) = 0 = \lim_{x \rightarrow -\infty} \left( \frac{1}{x^2} \right) \rightarrow \lim_{x \rightarrow \infty} \left( \frac{1}{x^2} \right) = 0$$

$$\text{atau } \lim_{x \rightarrow \infty} \left( \frac{1}{x^2} \right) = 0 \leftrightarrow \lim_{x \rightarrow \infty} \left( \frac{1}{x^2} \right) = 0 = \lim_{x \rightarrow -\infty} \left( \frac{1}{x^2} \right)$$

terbukti

**Poin Penting dari C. 4.3.12 (b)**

1.  $f(x) := 1/x^2$  untuk  $x \neq 0$
2.  $\lim_{x \rightarrow \infty} \left( \frac{1}{x^2} \right) = 0$
3.  $\forall \varepsilon > 0$
4.  $\exists \delta = \delta(\varepsilon) > 0 \ni \forall x \in A$
5.  $0 < |x - \infty| < \delta \rightarrow \left| \frac{1}{x^2} - 0 \right| < \varepsilon$
6.  $\lim_{x \rightarrow -\infty} \left( \frac{1}{x^2} \right) = 0$
7.  $0 < |\infty - x| < \delta \rightarrow \left| \frac{1}{x^2} - 0 \right| < \varepsilon$
8.  $0 < x - \infty < \delta$
9.  $0 < \infty - x < \delta$
10.  $0 < |x - \infty| < \delta \rightarrow \left| \frac{1}{x^2} - 0 \right| < \varepsilon$
11.  $\lim_{x \rightarrow \infty} \left( \frac{1}{x^2} \right) = 0$
12.  $\lim_{x \rightarrow \infty} \left( \frac{1}{x^2} \right) = 0 = \lim_{x \rightarrow -\infty} \left( \frac{1}{x^2} \right) \rightarrow \lim_{x \rightarrow \infty} \left( \frac{1}{x^2} \right) = 0$
13.  $\lim_{x \rightarrow \infty} \left( \frac{1}{x^2} \right) = 0 \leftrightarrow \lim_{x \rightarrow \infty} \left( \frac{1}{x^2} \right) = 0 = \lim_{x \rightarrow -\infty} \left( \frac{1}{x^2} \right)$

**4.3.13 Definition** Let  $A \subseteq \mathbb{R}$  and let  $f: A \rightarrow \mathbb{R}$ . Suppose that  $(a, \infty) \subseteq A$  for some  $a \in A$ . We say that  $f$  **tends to**  $\infty$  [respectively,  $-\infty$ ] **as**  $x \rightarrow \infty$ , and write

$$\lim_{x \rightarrow \infty} f = \infty \text{ [respectively, } \lim_{x \rightarrow \infty} f = -\infty \text{]}$$

if given any  $\alpha \in \mathbb{R}$  there exists  $K = K(\alpha) > a$  such that for any  $x > K$ , then  $f(x) > \alpha$  [respectively,  $f(x) < \alpha$ ].

As before there is a sequential criterion for this limit.

**Definisi 4.3.13** Misalkan  $A \subseteq \mathbb{R}$  dan  $f: A \rightarrow \mathbb{R}$ . Anggaplah bahwa  $(a, \infty) \subseteq A$  Untuk semua  $a \in A$ . Kita mengatakan bahwa  $f$  **menuju ke**  $\infty$  [atau,  $-\infty$ ] **apabila**  $x \rightarrow \infty$ , dan ditulis

$$\lim_{x \rightarrow \infty} f = \infty \text{ [atau, } \lim_{x \rightarrow \infty} f = -\infty \text{]}$$

Jika diberikan sebarang  $\alpha \in \mathbb{R}$  terdapat  $K = K(\alpha) > a$  sedemikian sehingga untuk sebarang  $x > K$ , maka  $f(x) > \alpha$

[atau,  $f(x) < \alpha$ ].

Sebagaimana sebelumnya, terdapat kriteria sekuensial untuk limit ini.

<p><b>Notasi Matematika D.4.3.13</b>  <math>A \subseteq \mathbb{R}</math> dan <math>f: A \rightarrow \mathbb{R}</math>. <math>(a, \infty) \subseteq A, \forall a \in A</math>. <math>f \rightarrow \infty</math> [atau, <math>-\infty</math>], <math>x \rightarrow \infty</math> ditulis <math>\lim_{x \rightarrow \infty} f = \infty</math> [atau, <math>\lim_{x \rightarrow \infty} f = -\infty</math>]. Ambil <math>\alpha \in \mathbb{R}</math>, <math>K = K(\alpha) &gt; a \ni \forall x &gt; K</math>, maka <math>f(x) &gt; \alpha</math> [atau, <math>f(x) &lt; \alpha</math>].</p>	<p><b>Poin Penting Dari D.4.3.13</b></p> <ol style="list-style-type: none"> <li>1. <math>A \subseteq \mathbb{R}</math></li> <li>2. <math>f: A \rightarrow \mathbb{R}</math></li> <li>3. <math>(a, \infty) \subseteq A, \forall a \in A</math></li> <li>4. <math>f \rightarrow \infty</math> [atau, <math>-\infty</math>]</li> <li>5. <math>x \rightarrow \infty</math></li> <li>6. <math>\lim_{x \rightarrow \infty} f = \infty</math> [atau, <math>\lim_{x \rightarrow \infty} f = -\infty</math>]</li> <li>7. <math>\alpha \in \mathbb{R}</math></li> <li>8. <math>K = K(\alpha) &gt; a</math></li> <li>9. <math>\ni \forall x &gt; K</math></li> <li>10. <math>f(x) &gt; \alpha</math> [atau, <math>f(x) &lt; \alpha</math>].</li> </ol>
<p><b>Kontrapositif Dari D.4.3.13</b>  <math>A \not\subseteq \mathbb{R}</math> dan <math>f: A \rightarrow \mathbb{R}</math>. <math>(a, \infty) \not\subseteq A, \forall a \in A</math>. <math>f \not\rightarrow \infty</math> [atau, <math>-\infty</math>], <math>x \not\rightarrow \infty</math> ditulis <math>\lim_{x \rightarrow \infty} f \neq \infty</math> [atau, <math>\lim_{x \rightarrow \infty} f \neq -\infty</math>]. Ambil <math>f(x) \leq \alpha</math> [atau, <math>f(x) \geq \alpha</math>], maka <math>\alpha \in \mathbb{R}</math>, <math>K \neq K(\alpha) \leq a \ni \forall x \leq K</math>.</p>	<p><b>Poin Penting Kontrapositif Dari D.4.3.13</b></p> <ol style="list-style-type: none"> <li>1. <math>A \not\subseteq \mathbb{R}</math></li> <li>2. <math>f: A \rightarrow \mathbb{R}</math></li> <li>3. <math>(a, \infty) \not\subseteq A, \forall a \in A</math></li> <li>4. <math>f \not\rightarrow \infty</math> [atau, <math>-\infty</math>]</li> <li>5. <math>x \not\rightarrow \infty</math></li> <li>6. <math>\lim_{x \rightarrow \infty} f \neq \infty</math> [atau, <math>\lim_{x \rightarrow \infty} f \neq -\infty</math>]</li> <li>7. <math>f(x) \leq \alpha</math> [atau, <math>f(x) \geq \alpha</math>].</li> <li>8. <math>\alpha \in \mathbb{R}</math></li> <li>9. <math>K \neq K(\alpha) \leq a</math></li> <li>10. <math>\ni \forall x \leq K</math></li> </ol>

**4.3.14 Theorem** Let  $A \in \mathbb{R}$ , let  $f: A \rightarrow \mathbb{R}$ , and suppose that  $(a, \infty) \subseteq A$ . for some  $\alpha \in \mathbb{R}$ . Then the following statements are equivalent:

(i)  $\lim_{x \rightarrow \infty} f = \infty$  [respectively;  $\lim_{x \rightarrow \infty} f = -\infty$ ].

**Teorema 4.3.14** Ambil  $A \in \mathbb{R}$ , jika  $f: A \rightarrow \mathbb{R}$ , dan ada  $(a, \infty) \subseteq A$ . Untuk semua  $\alpha \in \mathbb{R}$ . Pernyataan dibawah ini ekuivalen:

(i)  $\lim_{x \rightarrow \infty} f = L$

### 4.3 Some Extension of the Limit Concept

### 4.3 Beberapa Ekstensi dari Konsep Limit

(ii) For every sequence  $(x_n)$  in  $(a, \infty)$  such that  $\lim(x_n) = \infty$ , then  $\lim \lim(f(x_n)) = \infty$  [respectively;  $\lim_{x \rightarrow \infty} f = -\infty$ ].

(ii) Untuk barisan  $(x_n)$  di  $(a, \infty)$  sedemikian sehingga  $\lim(x_n) = \infty$ , maka  $\lim(f(x_n)) = \infty$ .

The next result is an analogue of Theorem 3.6.5

Selanjutnya melihat dari Teorema 3.6.5

<p><b>Notasi Matematika dari T. 4.3.2</b>  <math>A \in \mathbb{R}, f : A \rightarrow \mathbb{R}, (a, \infty) \subseteq A</math>. Lalu                      (i) <math>\lim_{x \rightarrow \infty} f = L \Leftrightarrow</math> (ii) <math>\forall (x_n) \rightarrow a \exists x_n \in \mathbb{R}, x_n &gt; a \forall n \in \mathbb{N}</math>, sehingga <math>(f(x_n)) \rightarrow L</math>.</p>	<p><b>Kontrapositif dari T. 4.3.2</b>  <math>A \in \mathbb{R}, f : A \rightarrow \mathbb{R}, (a, \infty) \subseteq A</math>. Lalu                      (ii) <math>\exists (x_n) \nrightarrow a \exists x_n \in \mathbb{R}, x_n \leq a \exists n \in \mathbb{N}</math>, sehingga <math>(f(x_n)) \nrightarrow L \Leftrightarrow</math> (i) <math>\lim_{x \rightarrow \infty} f \neq L</math>.</p>
<p><b>Poin Penting dari T. 4.3.2</b></p> <ol style="list-style-type: none"> <li>1) <math>A \in \mathbb{R}</math></li> <li>2) <math>f : A \rightarrow \mathbb{R}</math></li> <li>3) <math>(a, \infty) \subseteq A</math></li> <li>4) <math>\lim_{x \rightarrow \infty} f = L</math></li> <li>5) <math>\forall (x_n) \rightarrow a \exists x_n \in \mathbb{R}</math></li> <li>6) <math>x_n &gt; c \forall n \in \mathbb{N}</math></li> <li>7) <math>(f(x_n)) \rightarrow L</math></li> </ol>	<p><b>Poin Penting Kontrapositif dari T. 4.3.2</b></p> <ol style="list-style-type: none"> <li>1) <math>A \in \mathbb{R}</math></li> <li>2) <math>f : A \rightarrow \mathbb{R}</math></li> <li>3) <math>(a, \infty) \subseteq A</math></li> <li>4) <math>\exists (x_n) \nrightarrow a \exists x_n \in \mathbb{R}</math></li> <li>5) <math>x_n \leq a \exists n \in \mathbb{N}</math></li> <li>6) <math>(f(x_n)) \nrightarrow L</math></li> <li>7) <math>\lim_{x \rightarrow \infty} f \neq L</math></li> </ol>
<p><b>Alternatif Bukti dari T. 4.3.2</b>  <math>A \in \mathbb{R}, f : A \rightarrow \mathbb{R}, (a, \infty) \subseteq A</math>. Lalu                      (i) <math>\lim_{x \rightarrow \infty} f = L</math>                      (ii) <math>\forall (x_n) \rightarrow a \exists x_n \in \mathbb{R}, x_n &gt; a \forall n \in \mathbb{N}</math>, sehingga <math>(f(x_n)) \rightarrow L</math>.                      (i) <math>\equiv</math> (ii) <math>\rightarrow</math> Bukti?  <b>Bukti:</b>                      (i) <math>\rightarrow</math> (ii)                      Karena <math>\lim_{x \rightarrow \infty} f = L</math>                      Berdasarkan D. 4.3.1 maka <math>\forall \varepsilon &gt; 0, \exists \delta = \delta(\varepsilon) &gt; 0 \exists \forall x \in A, x &gt; c</math>.</p>	<p><b>Poin Penting dari T. 4.3.2</b></p> <ol style="list-style-type: none"> <li>1) <math>\lim_{x \rightarrow \infty} f = L</math></li> <li>2) <math>\forall (x_n) \rightarrow a</math></li> <li>4) <math>x_n \in \mathbb{R}</math></li> <li>5) <math>x_n &gt; a</math></li> <li>6) <math>\forall n \in \mathbb{N}</math></li> <li>7) <math>(f(x_n)) \rightarrow L</math></li> <li>8) <math>\forall (x_n) \rightarrow a \exists x_n \in \mathbb{R}, x_n &gt; a \forall n \in \mathbb{N}</math></li> <li>9) <math>\varepsilon &gt; 0</math></li> <li>10) <math>\exists \delta = \delta(\varepsilon) &gt; 0</math></li> <li>11) <math>0 &lt;  x - c  &lt; \delta</math></li> </ol>



<p>Ambil sebarang <math>x_n</math> di <math>A</math>, <math>(x_n) \rightarrow a</math> sehingga berdasarkan T. 4.1.8 diperoleh <math>x_n \in A</math>, <math>x_n &gt; a</math>, <math>\forall n \in \mathbb{N}</math> mengakibatkan <math>(f(x_n)) \rightarrow L</math>. Dengan demikian, <math>\forall (x_n) \rightarrow a \exists x_n \in A, x_n &gt; a \forall n \in \mathbb{N}</math>, sehingga <math>(f(x_n)) \rightarrow L</math>.  <b>(ii) <math>\rightarrow</math> (i)</b>                  Ambil sebarang <math>\varepsilon &gt; 0</math>, <math>\exists \delta = \delta(\varepsilon) &gt; 0</math>                  Berdasarkan D. 4.1.4 diperoleh <math>0 &lt;  x - c  &lt; \delta</math>                  Karena <math>(f(x_n)) \rightarrow L</math> maka <math> f(x) - L  &lt; \varepsilon</math>                  Dengan demikian  <math>\forall \varepsilon &gt; 0, \exists \delta = \delta(\varepsilon) &gt; 0 \ni \forall x \in A, 0 &lt; x - a &lt; \delta \Rightarrow  f(x) - L  &lt; \varepsilon</math>                  Dan berdasarkan T 3.6.5 diperoleh <math>\lim_{x \rightarrow \infty} f = L</math>.                  Jadi, <b>(i) <math>\equiv</math> (ii).</b> ■</p>	<p>12) <math> f(x) - L  &lt; \varepsilon</math>                  13) <math>\forall \varepsilon &gt; 0, \exists \delta = \delta(\varepsilon) &gt; 0 \ni \forall x \in A, 0 &lt; x - a &lt; \delta \Rightarrow  f(x) - L  &lt; \varepsilon</math></p>
--	---

**4.3.15 Theorem** Let  $A \subseteq \mathbb{R}$ , let  $f, g : A \rightarrow \mathbb{R}$ , and suppose that  $(a, \infty) \subseteq A$  for some  $a \in \mathbb{R}$ . Suppose further that  $g(x) > 0$  for all  $x > a$  and that for some  $L \in \mathbb{R}, L \neq 0$ , we have

$$\lim_{x \rightarrow \infty} \frac{f(x)}{g(x)} = L.$$

- (i) If  $L > 0$ , then  $\lim_{x \rightarrow \infty} f = \infty$  if and only if  $\lim_{x \rightarrow \infty} g = \infty$ .
- (ii) If  $L < 0$ , then  $\lim_{x \rightarrow \infty} f = -\infty$  if and only if  $\lim_{x \rightarrow \infty} g = \infty$ .

**Proof.** (i) Since  $L > 0$ , the hypothesis implies that there exists  $a_1 > a$  such that

$$0 < \frac{1}{2}L \leq \frac{f(x)}{g(x)} < \frac{3}{2}L \text{ for } x > a_1.$$

Therefore we have  $(\frac{1}{2}L)g(x) < f(x) < (\frac{3}{2}L)g(x)$  for all

**Teorema 4.3.15** Diberikan  $A \subseteq \mathbb{R}$ ,  $f, g : A \rightarrow \mathbb{R}$  dan misal ada  $(a, \infty) \subseteq A$  untuk setiap  $a \in \mathbb{R}$ . Selanjutnya misal ada  $g(x) > 0$  untuk semua  $x > a$  dan untuk setiap  $L \in \mathbb{R}, L \neq 0$ , kita punya

$$\lim_{x \rightarrow \infty} \frac{f(x)}{g(x)} = L.$$

- (i) Jika  $L > 0$ , kemudian  $\lim_{x \rightarrow \infty} f = \infty$  jika dan hanya jika  $\lim_{x \rightarrow \infty} g = \infty$ .
- (ii) Jika  $L < 0$ , kemudian  $\lim_{x \rightarrow \infty} f = -\infty$  jika dan hanya jika  $\lim_{x \rightarrow \infty} g = \infty$ .

**Bukti.** (i) Karena  $L > 0$ , hipotesisnya mengimplikasikan bahwa ada  $a_1 > a$  seperti

$$0 < \frac{1}{2}L \leq \frac{f(x)}{g(x)} < \frac{3}{2}L \text{ untuk } x > a_1.$$

Oleh karena itu kita punya  $(\frac{1}{2}L)g(x) < f(x) < (\frac{3}{2}L)g(x)$

### 4.3 Some Extension of the Limit Concept

$x > a_1$ , from which the conclusion follows readily.

The proof of (ii) is similar. Q.E.D.

We leave it to the reader to formulate the analogous result as  $x \rightarrow -\infty$ .

### 4.3 Beberapa Ekstensi dari Konsep Limit

untuk semua  $x > a_1$ , dari kesimpulan tersebut maka terbukti.

Bukti dari (ii) adalah serupa.

Kita menyewakannya kepada pembaca untuk menemukan hasil analog seperti  $x \rightarrow -\infty$ .

<p><b>Notasi Matematika dari T 4.3.15</b>  <math>A \subseteq \mathbb{R}, f: A \rightarrow \mathbb{R}, \exists(a, \infty) \subseteq A \forall a \in \mathbb{R}. g(x) &gt; 0 \forall x &gt; a, \forall L \in \mathbb{R}, L \neq 0 \exists \lim_{x \rightarrow \infty} \frac{f(x)}{g(x)} = L.</math>                      (i) <math>L &gt; 0, \lim_{x \rightarrow \infty} f = \infty \Leftrightarrow \lim_{x \rightarrow \infty} g = \infty</math>                      (ii) <math>L &lt; 0, \lim_{x \rightarrow \infty} f = -\infty \Leftrightarrow \lim_{x \rightarrow \infty} g = \infty</math></p>	<p><b>Kontrapositif dari T 4.3.15</b>  <math>A \subseteq \mathbb{R}, f: A \rightarrow \mathbb{R}, \exists(a, \infty) \subseteq A \forall a \in \mathbb{R}. g(x) &gt; 0 \forall x &gt; a, \forall L \in \mathbb{R}, L \neq 0 \exists \lim_{x \rightarrow \infty} \frac{f(x)}{g(x)} \neq L.</math>                      (i) <math>L &gt; 0, \lim_{x \rightarrow \infty} f = \infty \Leftrightarrow \lim_{x \rightarrow \infty} g = \infty</math>                      (ii) <math>L &lt; 0, \lim_{x \rightarrow \infty} f = -\infty \Leftrightarrow \lim_{x \rightarrow \infty} g = \infty</math></p>
<p><b>Poin Penting dari T 4.3.15</b></p> <ol style="list-style-type: none"> <li>1. <math>A \subseteq \mathbb{R}</math></li> <li>2. <math>f: A \rightarrow \mathbb{R}</math></li> <li>3. <math>(a, \infty) \subseteq A</math></li> <li>4. <math>\forall a \in \mathbb{R}</math></li> <li>5. <math>g(x) &gt; 0</math></li> <li>6. <math>\forall x &gt; a</math></li> <li>7. <math>\forall L \in \mathbb{R}</math></li> <li>8. <math>L \neq 0</math></li> <li>9. <math>\exists \lim_{x \rightarrow \infty} \frac{f(x)}{g(x)} = L</math></li> <li>10. <math>L &gt; 0, \lim_{x \rightarrow \infty} f = \infty \Leftrightarrow \lim_{x \rightarrow \infty} g = \infty</math></li> <li>11. <math>L &lt; 0, \lim_{x \rightarrow \infty} f = -\infty \Leftrightarrow \lim_{x \rightarrow \infty} g = \infty</math></li> </ol>	<p><b>Poin Penting Kontrapositif dari T 4.3.15</b></p> <ol style="list-style-type: none"> <li>1. <math>A \subseteq \mathbb{R}</math></li> <li>2. <math>f: A \rightarrow \mathbb{R}</math></li> <li>3. <math>(a, \infty) \subseteq A</math></li> <li>4. <math>\forall a \in \mathbb{R}</math></li> <li>5. <math>g(x) &gt; 0</math></li> <li>6. <math>\forall x &gt; a</math></li> <li>7. <math>\forall L \in \mathbb{R}</math></li> <li>8. <math>L \neq 0</math></li> <li>9. <math>\exists \lim_{x \rightarrow \infty} \frac{f(x)}{g(x)} \neq L</math></li> <li>10. <math>L &gt; 0, \lim_{x \rightarrow \infty} f = \infty \Leftrightarrow \lim_{x \rightarrow \infty} g = \infty</math></li> <li>11. <math>L &lt; 0, \lim_{x \rightarrow \infty} f = -\infty \Leftrightarrow \lim_{x \rightarrow \infty} g = \infty</math></li> </ol>
<p><b>Alternatif Bukti dari T 4.3.15 (i)</b>  <math>L \neq 0, L &gt; 0</math>, hipotesisnya mengimplikasikan bahwa ada <math>a_1 &gt; a</math> seperti</p>	<p><b>Poin Penting Alternatif Bukti dari T 4.3.15 (i)</b></p> <ol style="list-style-type: none"> <li>1. <math>L \neq 0</math></li> <li>2. <math>L &gt; 0</math></li> <li>3. <math>a_1 &gt; a</math></li> </ol>

### 4.3 Some Extension of the Limit Concept

### 4.3 Beberapa Ekstensi dari Konsep Limit

<p><math>0 &lt; \frac{1}{2}L \leq \frac{f(x)}{g(x)} &lt; \frac{3}{2}L</math> (dikali dengan <math>g(x)</math>) untuk <math>x &gt; a_1</math>.</p> <p>Sehingga <math>(\frac{1}{2}L)g(x) &lt; f(x) &lt; (\frac{3}{2}L)g(x)</math> untuk semua <math>x &gt; a_1</math>,</p> <p>Jadi, <math>L &gt; 0, \lim_{x \rightarrow \infty} f = \infty \Leftrightarrow \lim_{x \rightarrow \infty} g = \infty</math> terbukti.</p>	<p>4. <math>0 &lt; \frac{1}{2}L \leq \frac{f(x)}{g(x)} &lt; \frac{3}{2}L</math></p> <p>5. <math>x &gt; a_1</math></p> <p>6. <math>(\frac{1}{2}L)g(x) &lt; f(x) &lt; (\frac{3}{2}L)g(x)</math></p>
<p><b>Alternatif Bukti dari T 4.3.15 (ii)</b></p> <p><math>L \neq 0, L &lt; 0</math>, hipotesisnya mengimplikasikan bahwa ada <math>a_1 &gt; a</math> seperti</p> <p><math>0 &gt; \frac{1}{2}L \geq \frac{f(x)}{g(x)} &gt; \frac{3}{2}L</math> (dikali dengan <math>g(x)</math>) untuk <math>x &gt; a_1</math>.</p> <p>Sehingga <math>(\frac{1}{2}L)g(x) &gt; f(x) &gt; (\frac{3}{2}L)g(x)</math> untuk semua <math>x &gt; a_1</math>,</p> <p>Jadi, <math>L &lt; 0, \lim_{x \rightarrow \infty} f = -\infty \Leftrightarrow \lim_{x \rightarrow \infty} g = \infty</math> terbukti.</p>	<p><b>Poin Penting Alternatif Bukti dari T 4.3.15 (ii)</b></p> <ol style="list-style-type: none"> <li>1. <math>L \neq 0</math></li> <li>2. <math>L &lt; 0</math></li> <li>3. <math>a_1 &gt; a</math></li> <li>4. <math>0 &gt; \frac{1}{2}L \geq \frac{f(x)}{g(x)} &gt; \frac{3}{2}L</math></li> <li>5. <math>x &gt; a_1</math></li> <li>6. <math>(\frac{1}{2}L)g(x) &gt; f(x) &gt; (\frac{3}{2}L)g(x)</math></li> </ol>

#### 4.3.16 Examples (a) $\lim_{x \rightarrow \infty} x^n = \infty$ for $n \in \mathbb{N}$ .

Let  $g(x) := x^n$  for  $x \in (0, \infty)$ . Given  $\alpha \in \mathbb{R}$ , let  $K := \sup\{1, \alpha\}$ . Then for all  $x > K$ , we have  $g(x) = x^n \geq x \geq \alpha$ . Since  $\alpha \in \mathbb{R}$  is arbitrary, it follows that  $\lim_{x \rightarrow \infty} g = \infty$ .

(b)  $\lim_{x \rightarrow -\infty} x^n = \infty$  for  $n \in \mathbb{N}$ ,  $n$  even, and  $\lim_{x \rightarrow -\infty} x^n = -\infty$  for  $n \in \mathbb{N}$ ,  $n$  odd.

We will treat the case  $n$  odd, say  $n = 2k + 1$  with  $k = 0, 1, \dots$ . Given  $\alpha \in \mathbb{R}$ , let  $K := \inf\{\alpha, -1\}$ . For any  $x < K$ , then since  $(x^2)^k \geq 1$ , we have  $x^n = (x^2)^k x \leq x < \alpha$ . Since  $\alpha \in \mathbb{R}$  is arbitrary, it follows that  $\lim_{x \rightarrow -\infty} x^n = -\infty$ .

(c) Let  $p : \mathbb{R} \rightarrow \mathbb{R}$  be the polynomial function

$$p(x) = a_n x^n + a_{n-1} x^{n-1} + \dots + a_1 x + a_0.$$

#### Contoh 4.3.16 (a) $\lim_{x \rightarrow \infty} x^n = \infty$ untuk $n \in \mathbb{N}$ .

Misalkan  $g(x) := x^n$  untuk  $x \in (0, \infty)$ . Diberikan  $\alpha \in \mathbb{R}$ , misalkan  $K := \sup\{1, \alpha\}$ . Maka untuk semua  $x > K$ , kita mempunyai  $g(x) = x^n \geq x \geq \alpha$ . Karena  $\alpha \in \mathbb{R}$  sebarang, maka ini berarti  $\lim_{x \rightarrow \infty} g = \infty$ .

(b)  $\lim_{x \rightarrow -\infty} x^n = \infty$  untuk  $n \in \mathbb{N}$ ,  $n$  genap, dan  $\lim_{x \rightarrow -\infty} x^n = -\infty$  untuk  $n \in \mathbb{N}$ ,  $n$  ganjil.

Kita akan mencoba kasus  $n$  ganjil, katakanlah  $n = 2k + 1$  dengan  $k = 0, 1, \dots$ . Diberikan  $\alpha \in \mathbb{R}$ , misalkan  $K := \inf\{\alpha, -1\}$ . Untuk sebarang  $x < K$ , maka karena  $(x^2)^k \geq 1$ , kita mempunyai  $x^n = (x^2)^k x \leq x < \alpha$ . Karena  $\alpha \in \mathbb{R}$  sebarang, maka  $\lim_{x \rightarrow -\infty} x^n = -\infty$ .

(c) Misalkan  $p : \mathbb{R} \rightarrow \mathbb{R}$  menjadi fungsi polynomial

$$p(x) := a_n x^n + a_{n-1} x^{n-1} + \dots + a_1 x + a_0.$$

### 4.3 Some Extension of the Limit Concept

Then  $\lim_{x \rightarrow \infty} p = \infty$  if  $a_n > 0$ , and  $\lim_{x \rightarrow \infty} p = -\infty$  if  $a_n < 0$ .  
Indeed, let  $g(x) := x^n$  and apply Theorem 4.3.15. Since

$$\frac{p(x)}{g(x)} = a_n + a_{n-1} \left(\frac{1}{x}\right) + \cdots + a_1 \left(\frac{1}{x^{n-1}}\right) + a_0 \left(\frac{1}{x^n}\right),$$

it follows that  $\lim_{x \rightarrow \infty} (p(x)/g(x)) = a_n$ . Since  $\lim_{x \rightarrow \infty} g = \infty$ , the assertion follows from Theorem 4.3.15.

(d) Let  $p$  be the polynomial function in part (c). Then  $\lim_{x \rightarrow \infty} p = \infty$  [respectively,  $-\infty$ ] if  $n$  is even [respectively, odd] and  $a_n > 0$ .

We leave the details to the reader.

### 4.3 Beberapa Ekstensi dari Konsep Limit

Kemudian  $\lim_{x \rightarrow \infty} p = \infty$  jika  $a_n > 0$ , dan  $\lim_{x \rightarrow \infty} p = -\infty$  jika  $a_n < 0$ .

Memang, misalkan  $g(x) := x^n$  dan gunakan teorema 4.3.15. Karena

$$\frac{p(x)}{g(x)} = a_n + a_{n-1} \left(\frac{1}{x}\right) + \cdots + a_1 \left(\frac{1}{x^{n-1}}\right) + a_0 \left(\frac{1}{x^n}\right),$$

Itu mengikuti bahwa  $\lim_{x \rightarrow \infty} (p(x)/g(x)) = a_n$ . Karena  $\lim_{x \rightarrow \infty} g = \infty$ , pernyataan tersebut mengikuti dari teorema 4.3.15.

(d) Misalkan  $p$  menjadi fungsi polinomial dalam bagian (c).  
■ Kemudian  $\lim_{x \rightarrow \infty} p = \infty$  [atau,  $-\infty$ ] jika  $n$  adalah genap [atau, ganjil] dan  $a_n > 0$ .

Kami memberikan detailnya kepada pembaca. ■

<p><b>Alternatif Jawaban dari C. 4.3.16 (a)</b>  <math>\lim_{x \rightarrow \infty} x^n = \infty, \forall n \in \mathbb{N} \rightarrow</math> Bukti?  <u>Bukti:</u>                      Misal <math>g(x) := x^n, x \in (0, \infty)</math>                      Asumsikan <math>\alpha \in \mathbb{R}</math>, maka <math>K := \sup\{1, \alpha\}</math>                      Karena <math>\forall x &gt; K</math>, kita mempunyai <math>g(x) = x^n \geq x \geq \alpha</math>                      Karena <math>\alpha \in \mathbb{R}</math> sebarang, maka <math>\lim_{x \rightarrow \infty} g = \infty</math></p>	<p><b>Point Penting dari C. 4.3.16 (a)</b></p> <ol style="list-style-type: none"> <li><math>g(x) := x^n, x \in (0, \infty)</math></li> <li><math>\alpha \in \mathbb{R}</math></li> <li><math>K := \sup\{1, \alpha\}</math></li> <li><math>g(x) = x^n \geq x \geq \alpha, \forall x &gt; K</math></li> <li><math>\alpha \in \mathbb{R}</math></li> <li><math>\lim_{x \rightarrow \infty} g = \infty</math></li> </ol>
<p><b>Alternatif Jawaban dari C. 4.3.16 (b)</b>  <math>\lim_{x \rightarrow -\infty} x^n = \infty, \forall n \in \mathbb{N}, n</math> genap }  <math>\lim_{x \rightarrow -\infty} x^n = -\infty, \forall n \in \mathbb{N}, n</math> ganjil } <math>\rightarrow</math> Bukti?  <u>Bukti:</u>                      Misal <math>n = 2k + 1</math> dengan <math>k = 0, 1, \dots</math> untuk <math>n</math> ganjil</p>	<ol style="list-style-type: none"> <li><math>n = 2k + 1</math> dengan <math>k = 0, 1, \dots</math> untuk <math>n</math> ganjil</li> <li><math>\alpha \in \mathbb{R}</math></li> <li><math>K := \inf\{\alpha, -1\}</math></li> <li><math>(x^2)^k \geq 1, \forall x &gt; K</math></li> <li><math>x^n = (x^2)^k x \leq x &lt; \alpha</math></li> </ol>

<p>Asumsikan <math>\alpha \in \mathbb{R}</math>, maka <math>K := \inf\{\alpha, -1\}</math>                  karena <math>(x^2)^k \geq 1, \forall x &gt; K</math>                  Karena <math>(x^2)^k \geq 1</math>, kita mempunyai <math>x^n = (x^2)^k x \leq x &lt; \alpha</math>                  Karena <math>\alpha \in \mathbb{R}</math> sebarang, maka <math>\lim_{x \rightarrow -\infty} x^n = -\infty</math></p>	<p>6. <math>\alpha \in \mathbb{R}</math>                  7. <math>\lim_{x \rightarrow -\infty} x^n = -\infty</math></p>
<p><b>Alternatif Jawaban dari C.4.3.16 (c)</b>                  (c) Misalkan <math>p : \mathbb{R} \rightarrow \mathbb{R}</math> fungsi polinomial                  Jawab:  <math>p : \mathbb{R} \rightarrow \mathbb{R}</math> fungsi polinomial <math>\rightarrow</math> Bukti?  <b>Bukti:</b>                  Ambil <math>p : \mathbb{R} \rightarrow \mathbb{R}</math> adalah fungsi polinomial:  <math>p(x) := a_n x^n + a_{n-1} x^{n-1} + \dots + a_1 x + a_0</math>                  Kemudian <math>\lim_{x \rightarrow \infty} p = \infty, a_n &gt; 0</math> dan <math>\lim_{x \rightarrow \infty} p = -\infty, a_n &lt; 0</math>                  Ambil <math>g(x) := x^n</math> dan gunakan teorema 4.3.15 karena  <math>\frac{p(x)}{g(x)} = a_n + a_{n-1} \left(\frac{1}{x}\right) + \dots + a_1 \left(\frac{1}{x^{n-1}}\right) + a_0 \left(\frac{1}{x^n}\right)</math>  <math>\exists \lim_{x \rightarrow \infty} (p(x)/g(x)) = a_n</math> karena <math>\lim_{x \rightarrow \infty} g = \infty \rightarrow</math> berlaku teorema 4.3.15.</p>	<p><b>Poin Penting dari C.4.3.16 (c)</b>                  1) <math>p : \mathbb{R} \rightarrow \mathbb{R}</math>                  2) <math>\lim_{x \rightarrow \infty} p = \infty</math>                  3) <math>a_n &gt; 0</math>                  4) <math>\lim_{x \rightarrow \infty} p = -\infty</math>                  5) <math>a_n &lt; 0</math>                  6) <math>g(x) := x^n</math>                  7) <math>\lim_{x \rightarrow \infty} (p(x)/g(x)) = a_n</math>                  8) <math>\lim_{x \rightarrow \infty} g = \infty</math></p>
<p><b>Alternatif Jawaban dari C.4.3.16 (d)</b>                  (d) Misalkan <math>p</math> fungsi polinomial                  Jawab:  <math>p</math> fungsi polinomial <math>\rightarrow</math> Bukti?  <b>Bukti:</b>                  Ambil <math>p</math> fungsi polinomial dari bagian (c)  <math>\exists \lim_{x \rightarrow \infty} p = \infty</math> [atau, <math>-\infty</math>]                  jika <math>n</math> genap [atau, ganjil] dan <math>a_n &gt; 0</math>.</p>	<p><b>Poin Penting dari C.4.3.16 (d)</b>                  1) <math>p</math> fungsi polinomial                  2) <math>\exists \lim_{x \rightarrow \infty} p = \infty</math>                  3) [atau, <math>-\infty</math>]                  4) <math>n</math> genap                  5) [atau, ganjil]                  6) <math>a_n &gt; 0</math></p>

## Exercises for Section 4.3

## Exercises for Section 4.3

1. Prove Theorem 4.3.2.
2. Give an example of a function that has a right-hand limit but not a left-hand limit at a point.
3. Let  $f(x) := |x|^{-\frac{1}{2}}$  for  $x \neq 0$ . Show that  $\lim_{x \rightarrow 0^+} f(x) = \lim_{x \rightarrow 0^-} f(x) = +\infty$ .
4. Let  $c \in \mathbb{R}$  and let  $f$  be defined for  $x \in (c, \infty)$  and  $f(x) > 0$  for all  $x \in (c, \infty)$ . Show that  $\lim_{x \rightarrow c} f = \infty$  if and only if  $\lim_{x \rightarrow c} 1/f = 0$ .
5. Evaluate the following limits, or show that they do not exist.
 

(a) $\lim_{x \rightarrow 1^+} \frac{x}{x-1}$ ( $x \neq 1$ ),	(b) $\lim_{x \rightarrow 1} \frac{x}{x-1}$ ( $x \neq 1$ ),
(c) $\lim_{x \rightarrow 0^+} \frac{(x+2)}{\sqrt{x}}$ ( $x > 0$ ),	(d) $\lim_{x \rightarrow \infty} \frac{(x+2)}{\sqrt{x}}$ ( $x > 0$ ),
(e) $\lim_{x \rightarrow 0} \frac{(x+1)}{\sqrt{x}}$ ( $x > -1$ ),	(f) $\lim_{x \rightarrow \infty} \frac{(x+1)}{\sqrt{x}}$ ( $x > 0$ ),
(g) $\lim_{x \rightarrow \infty} \frac{\sqrt{x}-5}{\sqrt{x}+3}$ ( $x > 0$ ),	(h) $\lim_{x \rightarrow \infty} \frac{\sqrt{x}-x}{\sqrt{x}+x}$ ( $x > 0$ ),
6. Prove theorem 4.3.11
7. Suppose that  $f$  and  $g$  have in  $\mathbb{R}$  as  $x \rightarrow \infty$  and that  $f(x) \leq g(x)$  for all  $x \in (a, \infty)$ . Prove that  $\lim_{x \rightarrow \infty} f \leq \lim_{x \rightarrow \infty} g$ .
8. Let  $f$  be defined in  $(0, \infty)$  to  $\mathbb{R}$ . Prove that  $\lim_{x \rightarrow \infty} f(x) = L$  if and only  $L \in \mathbb{R}$ , then  $\lim_{x \rightarrow 0^-} f\left(\frac{1}{x}\right) = L$ .
9. Show that if  $f: (a, \infty) \rightarrow \mathbb{R}$  is such that  $\lim_{x \rightarrow \infty} x f(x) = L$  where  $L \in \mathbb{R}$ , then  $\lim_{x \rightarrow \infty} f(x) = 0$ .
10. Prove theorem 4.3.14.
11. Suppose that  $\lim_{x \rightarrow c} f(x) = L$  where  $L > 0$ , and that

## Latihan untuk bagian 4.3

1. Buktikan teorema 4.3.2.
2. Berikan sebuah contoh fungsi yang mempunyai limit pihak kanan tetapi tidak ada titik limit pihak kiri.
3. Diberikan  $f(x) := |x|^{-\frac{1}{2}}$  untuk  $x \neq 0$ . Tunjukkan bahwa  $\lim_{x \rightarrow 0^+} f(x) = \lim_{x \rightarrow 0^-} f(x) = +\infty$ .
4. Diberikan  $c \in \mathbb{R}$  dan diberikan  $f$  didefinisikan sebagai  $x \in (c, \infty)$  dan  $f(x) > 0 \forall x \in (c, \infty)$ . Tunjukkan bahwa  $\lim_{x \rightarrow c} f = \infty$  jika dan hanya jika  $\lim_{x \rightarrow c} 1/f = 0$ .
5. Evaluasikan limit dibawah ini, atau tunjukkan yang tidak benar.
 

(a) $\lim_{x \rightarrow 1^+} \frac{x}{x-1}$ ( $x \neq 1$ ),	(b) $\lim_{x \rightarrow 1} \frac{x}{x-1}$ ( $x \neq 1$ ),
(c) $\lim_{x \rightarrow 0^+} \frac{(x+2)}{\sqrt{x}}$ ( $x > 0$ ),	(d) $\lim_{x \rightarrow \infty} \frac{(x+2)}{\sqrt{x}}$ ( $x > 0$ ),
(e) $\lim_{x \rightarrow 0} \frac{(x+1)}{\sqrt{x}}$ ( $x > -1$ ),	(f) $\lim_{x \rightarrow \infty} \frac{(x+1)}{\sqrt{x}}$ ( $x > 0$ ),
(g) $\lim_{x \rightarrow \infty} \frac{\sqrt{x}-5}{\sqrt{x}+3}$ ( $x > 0$ ),	(h) $\lim_{x \rightarrow \infty} \frac{\sqrt{x}-x}{\sqrt{x}+x}$ ( $x > 0$ ),
6. Buktikan teorema 4.3.11.
7. Tunjukkan bahwa  $f$  dan  $g$  mempunyai limit di  $\mathbb{R}$  sebagai  $x \rightarrow \infty$  dan  $f(x) \leq g(x) \forall x \in (a, \infty)$ . Buktikan bahwa  $\lim_{x \rightarrow \infty} f \leq \lim_{x \rightarrow \infty} g$ .
8. Misalkan  $f$  didefinisikan sebagai  $(0, \infty)$  di  $\mathbb{R}$ . Buktikan bahwa  $\lim_{x \rightarrow \infty} f(x) = L$  jika dan hanya jika  $L \in \mathbb{R}$ , maka

### 4.3 Some Extension of the Limit Concept

$\lim_{x \rightarrow c} g(x) = \infty$ . If  $L = 0$ , Show by example that this conclusion may fail.

12. Find functions  $f$  and  $g$  defined on  $(0, \infty)$  such that  $\lim_{x \rightarrow \infty} f = \infty$  and  $\lim_{x \rightarrow \infty} g = \infty$ , and  $\lim_{x \rightarrow \infty} (f - g) = 0$ . Can you find such functions, with  $g(x) > 0$  for all  $x \in (0, \infty)$ , Such that  $\lim_{x \rightarrow \infty} f/g = 0$ ?
13. Let  $f$  and  $g$  be defined on  $(\alpha, \infty)$  and suppose  $\lim_{x \rightarrow \infty} f = L$  and  $\lim_{x \rightarrow \infty} g = \infty$ . Prove that  $\lim_{x \rightarrow \infty} f \circ g = L$ .

### 4.3 Beberapa Ekstensi dari Konsep Limit

$$\lim_{x \rightarrow 0^-} f\left(\frac{1}{x}\right) = L.$$

9. Tunjukkan bahwa jika  $f: (\alpha, \infty) \rightarrow \mathbb{R}$  adalah  $\lim_{x \rightarrow \infty} x f(x) = L$  dimana  $L \in \mathbb{R}$ , maka  $\lim_{x \rightarrow \infty} f(x) = 0$ .
10. Buktikan teorema 4.3.14.
11. Tunjukkan bahwa  $\lim_{x \rightarrow c} f(x) = L$  dimana  $L > 0$ , dan  $\lim_{x \rightarrow c} g(x) = \infty$ . Jika  $L = 0$ , tunjukkan dengan contoh bahwa ini dapat menarik kesimpulan.
12. Temukan fungsi  $f$  dan  $g$  definisi pada  $(0, \infty)$  adalah  $\lim_{x \rightarrow \infty} f = \infty$  dan  $\lim_{x \rightarrow \infty} g = \infty$ , dan  $\lim_{x \rightarrow \infty} (f - g) = 0$ . Kamu bisa menemukan beberapa fungsi, dengan  $g(x) > 0$  untuk setiap  $x \in (\alpha, \infty)$ , Seperti  $\lim_{x \rightarrow \infty} f/g = 0$ ?
13. Diberikan  $f$  dan  $g$  didefinisikan sebagai  $(\alpha, \infty)$  dan tunjukkan  $\lim_{x \rightarrow \infty} f = L$  dan  $\lim_{x \rightarrow \infty} g = \infty$ . Buktikan bahwa  $\lim_{x \rightarrow \infty} f \circ g = L$ .

## Daftar Pustaka

Bartle, R. G & Sherbert, D. R. (2010). *Introduction to Real Analysis (Fourth Edition)*. Urbana: John & Sons, Inc.





**FAKULTAS KEGURUAN DAN ILMU PENDIDIKAN  
PROGRAM STUDI MATEMATIKA  
UNIVERSITAS ISLAM DARUL' ULUM LAMONGAN**