

## AN ASSESSMENT OF THE NEWMARK METHOD FOR SOLVING CHAOTIC VIBRATIONS OF IMPACTING OSCILLATORS

R. I. K. MOORTHY,† A. KAKODKAR,‡ H. R. SRIRANGARAJAN§ and S. SURYANARAYAN¶

†Reactor Engineering Division, ‡Reactor Design and Development Group,  
Bhabha Atomic Research Centre, Bombay-400 085, India

§Department of Mechanical Engineering, ¶Department of Aeronautical Engineering,  
Indian Institute of Technology, Bombay-400 076, India

(Received 14 July 1992)

**Abstract**—The fourth-order Runge–Kutta method has been the preferred numerical integration scheme for solving chaotic problems in non-linear systems. This method is very accurate, but requires very small time-steps and four equation solutions per time-step. These drawbacks hinder the solution of chaotic problems in multi-degree-of-freedom (MDOF) systems. This paper presents the solution of the chaotic problem of impacting single-degree-of-freedom (SDOF) oscillators, using the Newmark method which is computationally efficient and unconditionally stable. The scheme incorporates an equilibrium iteration and variable time-stepping algorithm based on a convergence criteria which ensures that solution errors are minimized at each step. The results are compared with those obtained from the fourth-order Runge–Kutta method. It is concluded that the Newmark method with an adequate check on the solution accuracy could give qualitatively the same results as the Runge–Kutta method. The method has the advantage of an extension to MDOF real-life problems of chaos which could be solved using numerical techniques like FEM with limited computing effort. Such an extension is being pursued separately.

### 1. INTRODUCTION

The solution of the chaotic vibration of non-linear mechanical systems involves the numerical integration of the governing equations of motion over a large time duration. This time duration should be adequately large to ensure that the transients die down and the solution captures the steady-state chaos. This demands that the integration scheme be stable and accurate without rendering the time-step too small.

Almost all the chaotic vibration problems reported in the literature use the fourth-order Runge–Kutta numerical integration scheme for solution [1, 2]. This has been the preferred algorithm since the scheme gives an accuracy of the order of  $(\Delta t)^4$ . However, this requires rather small time-steps. Normally this is of the order of 1/100th the forcing period or even smaller for the solution of single-degree-of-freedom (SDOF) systems. The solution scheme also calls for four equation solutions per time-step.

Mathematical models of engineering structures generally produce 'stiff equations', i.e. the highest natural frequency is much higher than the lowest one. So, the solution of multi-degree-of-freedom (MDOF) real-life structures would need time-steps which are a small fraction of the lowest natural period. This makes the solution of MDOF chaotic problems a very formidable task and so this has restricted the study of chaos to single or limited degrees-of-freedom models.

This paper is the result of our attempt to identify a more efficient integration scheme which would render the long duration solution of MDOF problems of chaos in impacting oscillators within easy reach. The actual solution of MDOF problems is being presented separately.

#### 1.1. Choice of the scheme

A number of integration schemes are in use in the finite element method (FEM) solution of dynamic problems [3–6]. Belytschko [5] has made an excellent review of the various numerical algorithms used in the FEM and has also described the advantages and disadvantages, and the stability and accuracy of these schemes. The paper also gives guidelines for choosing the appropriate integration method for a problem. The problem of chaos in impacting oscillators clearly falls into the category of 'inertial problems' (the other category being the wave propagation problem) and so an implicit time integration scheme would be appropriate. Of the many implicit schemes in common use, the Newmark method [7] with operator constants of  $\delta = 0.5$  and  $\alpha = 0.25$  has been found to be unconditionally stable [5, 6, 10, 12]. There are many successful applications of this technique for impacting problems [9–11]. There have also been attempts to use the technique for continuous non-linear problems. Reinhall *et al.* [8] have studied the applicability and the errors introduced in solving a continuous Duffing equation.

The authors have studied the applicability of the Newmark method with an error control scheme for SDOF impact oscillators. This has been a natural corollary of the scheme proposed earlier [9-11]. The earlier studies on this scheme have been to estimate the impact forces in systems. It appears that no long duration solution was attempted to study the response of the structures themselves especially when excited by a harmonic force.

2. SIMULATION OF A SDOF IMPACT OSCILLATOR

A typical model of a SDOF impacting oscillator is shown in Fig. 1.

2.1. Governing equations of motion for a linear SDOF system

The dynamic equilibrium equation for a linear SDOF system can be written as

$$Ky + C\dot{y} + M\ddot{y} = P(t), \quad (1)$$

where  $K$  is the stiffness,  $C$  is the damping coefficient, and  $M$  the mass.  $y, \dot{y}, \ddot{y}$  are the displacement, velocity and acceleration, respectively, of the mass, and  $P(t)$  is the external load.

2.2. Simulation of impact

Restraints with gaps are simulated by a piecewise linear spring as illustrated in Fig. 2.

Any energy loss during impact could be simulated by a local damper in parallel to the non-linear spring in Fig. 1.

2.3. Equations of motion of impacting oscillator

The equation of motion (1) can now be written as

$$M\ddot{y} + C\dot{y} + C_{NL}\dot{y} + Ky + K_{NL}y = P(t), \quad (2)$$

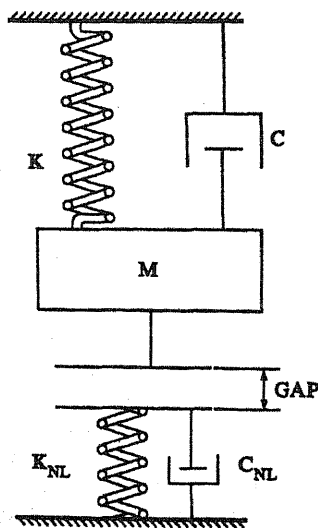

Fig. 1. SDOF impacting oscillator.

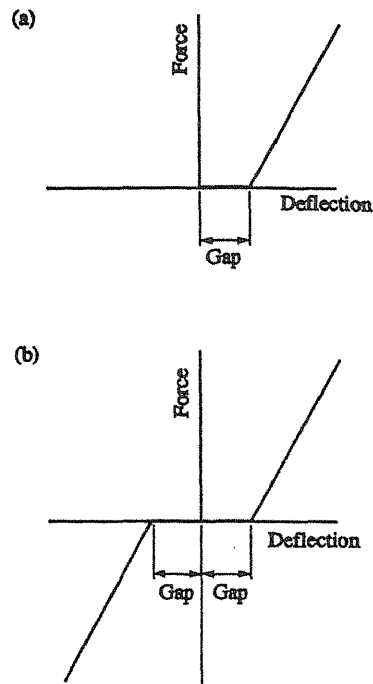

Fig. 2. (a) Single-sided restraint. (b) Double-sided restraint.

where  $K_{NL}$  and  $C_{NL}$  are the local stiffness and damping shown in Fig. 1. The characteristics of the spring with stiffness  $K_{NL}$  are as shown in Fig. 2.

3. NUMERICAL INTEGRATION SCHEME USING THE NEWMARK METHOD

The solution of eqn (2) has to be carried out numerically. The Newmark method [7] with operator constants of  $\delta = 0.5$  and  $\alpha = 0.25$  which is an unconditionally stable scheme, is used for the solution.

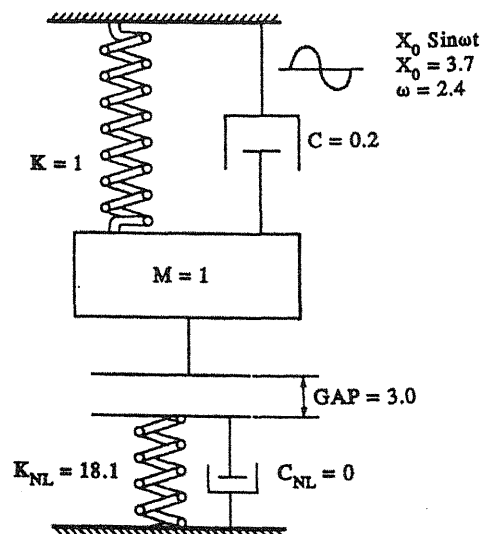

Fig. 3. Sample problem.

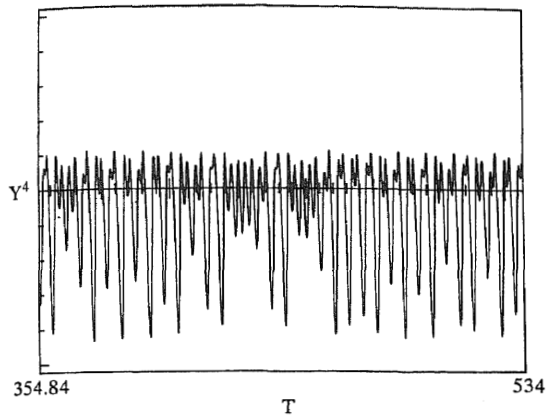

Fig. 4. Time history of the response of mass as solved by the Newmark method.

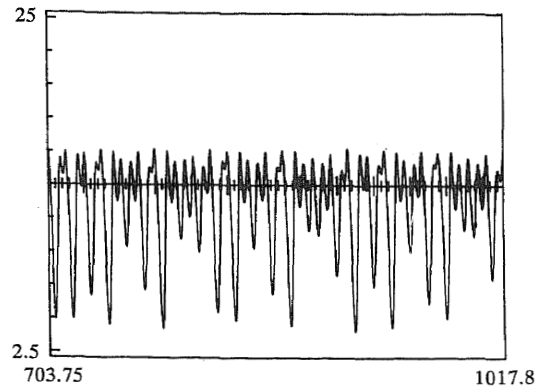

Fig. 6. Time history with Runge-Kutta simulation.

The integration scheme can be summarized as follows. Assume

$$\dot{y}_{t+\Delta t} = \dot{y}_t + [(1 - \delta)\dot{y}_t + \delta\dot{y}_{t+\Delta t}] \cdot \Delta t \quad (3)$$

$$y_{t+\Delta t} = y_t + \dot{y}_t \cdot \Delta t + [(\frac{1}{2} - \alpha)\ddot{y}_t + \alpha\ddot{y}_{t+\Delta t}] \cdot \Delta t^2, \quad (4)$$

where  $\delta$  and  $\alpha$  are parameters chosen by the analyst. These parameters determine the accuracy and stability of the scheme. For unconditional stability

$$\delta \geq 0.5 \quad \text{and} \quad \alpha \geq (2\delta + 1)^2/16.$$

Artificial positive damping is introduced if  $\delta > 0.5$  and negative damping of  $\delta < 0.5$ . If  $\delta = 0.5$  and  $\alpha = 0$ , the method reduces to the central difference method, another integration scheme used for solving wave propagation problems and other non-linear

problems by the FEM. If  $\delta = 0.5$  and  $\alpha = 1/6$ , the scheme becomes the linear acceleration scheme which is conditionally stable. If  $\delta = 0.5$  and  $\alpha = 0.25$ , the method is found to be unconditionally stable. The scheme with these values for the parameters is also called the constant acceleration scheme or the trapezoidal method. It is also seen that with these values of  $\delta$  and  $\alpha$ , there are no amplitude errors introduced for linear problems.

### 3.1. Implementation of the Newmark scheme for the solution of SDOF impacting oscillator

The equation of motion (2) can be written for any time  $t + \Delta t$  as

$$M\ddot{y}_{t+\Delta t} + C\dot{y}_{t+\Delta t} + C_{NL}\dot{y}_{t+\Delta t} + Ky_{t+\Delta t} + K_{NL}y_{t+\Delta t} = P_{t+\Delta t}. \quad (5)$$

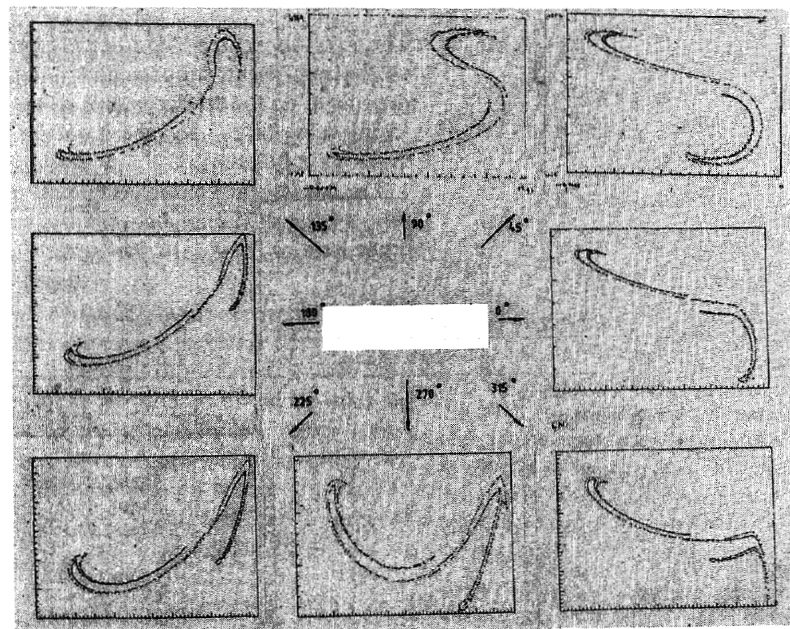

Fig. 5. Poincaré map with Newmark method of solution.

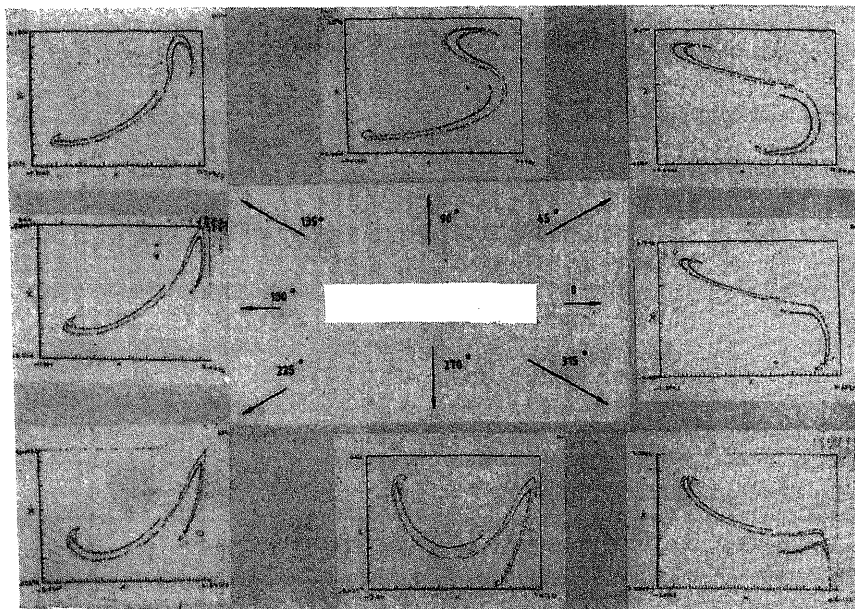

Fig. 7. Poincaré map with Runge-Kutta simulation.

Transferring the non-linear contributions to the right-hand side (RHS), the equation could be written as

$$M\ddot{y}_{t+\Delta t} + C\dot{y}_{t+\Delta t} + Ky_{t+\Delta t} = P_{t+\Delta t} - F_{NL,t+\Delta t}. \quad (6)$$

There is an advantage of computation in transferring the non-linear terms on the RHS as equivalent load. While solving MDOF problems, this would eliminate the need for reforming of  $K$  matrix. The above equation (5) can be represented as [3, 9]

$$\bar{K}y_{t+\Delta t} = \bar{P}_{t+\Delta t} - F_{NL,t+\Delta t} \quad (7)$$

where

$$\begin{aligned} \bar{K} &= \text{equivalent stiffness} \\ &= K + \frac{1}{\alpha\Delta t^2} \cdot M + \frac{\delta}{\alpha\Delta t} \cdot C \end{aligned}$$

$\bar{P}_{t+\Delta t}$  = equivalent load

$$\begin{aligned} &= P_{t+\Delta t} + M \left[ \frac{1}{\alpha\Delta t^2} \cdot y_t + \frac{1}{\alpha\Delta t} \dot{y}_t + \frac{1-2\alpha}{2\alpha} \ddot{y}_t \right] \\ &+ C \left[ \frac{\delta}{\alpha\Delta t} \cdot y_t + \frac{\delta-\alpha}{\alpha} \dot{y}_t + \frac{\delta-2\alpha}{\alpha} \frac{\Delta t}{2} \cdot \ddot{y}_t \right] \end{aligned}$$

$$F_{NL,t+\Delta t} = K_{NL}y_{t+\Delta t} + \frac{\delta}{\alpha\Delta t} C_{NL}y_{t+\Delta t}$$

$$- C_{NL} \left[ \frac{\delta}{\alpha\Delta t} y_t + \frac{\delta-\alpha}{\alpha} \dot{y}_t + \frac{\delta-2\alpha}{\alpha} \frac{\Delta t}{2} \ddot{y}_t \right].$$

The solution at time-step  $t + \Delta t$  is iterative in nature as the non-linear stiffness and damping forces are dependent on the displacements being computed. The initial value of  $F_{NL}$  for the iteration is obtained by linear extrapolation of  $F_{NL}$  at  $t$  and  $t - \Delta t$ .

The convergence of the iteration is measured by the ratio of the difference between the current and previous iterates for  $F_{NL}$  to the current value of  $F_{NL}$ . A

Table 1

Method	No. of load cycles	Execution time†
1. Newmark method with non-linear force and equilibrium iterations with allowable half-step error of		
(a) 1% of external load	1111	4 min, 02 sec
(b) 2% of ext. load	1111	3 min, 44 sec
(c) 10% of ext. load	1111	3 min, 05 sec
2. Fourth-order, Runge-Kutta Gill method with 200 time-steps per load cycle	1111	11 min, 12 sec

† On an HP-micro 1000 A700 computer system.

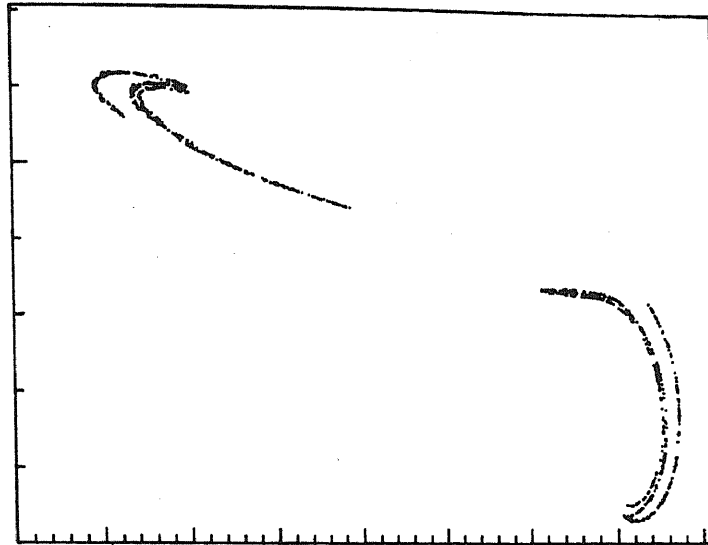

Fig. 8. Poincaré map using Newmark method with half step error tolerance of 10% of excitation.

mathematical treatment to prove that such an iterative scheme converges is dealt with in [9]. It is shown that as long as  $KNL/\bar{K}$  is kept much less than one the solution converges. (For the solution reported in the paper, a value of 0.01 has been used for  $KNL/\bar{K}$ .) It is seen that convergence of the order of  $1 \times 10^{-6}$  is normally achieved within a few iterations. If not, the time-step is halved to increase the value of  $\bar{K}$  [refer to eqn (7)] which accelerates convergence.

From the solution obtained for  $y_{t+\Delta t}$ , the  $\dot{y}_{t+\Delta t}$  and  $\ddot{y}_{t+\Delta t}$  could be calculated from eqns (3) and (4).

### 3.2. Time-step error control

In addition to the control on step length to ensure convergence of  $F_{NL}$ , the errors associated with a time-stepping solution need to be controlled. Ma and Bathe [10] and Belytschko and Schoeberle [12] have used an energy balance criteria to check and improve the accuracy of the solution. However, both the methods apply the error correction on the displacements keeping the time-step constant. However, Hibbit and Karlsson [11] and Sauvé and Teper [9] used a variable time-stepping algorithm based on the error in the equations of motion at half-time-step. The concept is as follows.

By solving the dynamic equilibrium equations at discrete steps, it has been ensured that the system is in equilibrium at either end of any step, i.e. at  $t$  and  $t + \Delta t$ . The Newmark method (trapezoidal rule) allows one to obtain the displacement, velocity and acceleration at any intermediate point assuming linear variation of the acceleration within a step. For any intermediate point  $t + \lambda\Delta t$ , they can be derived as

$$\ddot{y}_{t+\lambda\Delta t} = \frac{(y_{t+\Delta t} - y_t) \cdot \lambda - \dot{y}_t \cdot \lambda}{\alpha \Delta t^2} + \ddot{y}_t \left(1 - \frac{\alpha \lambda}{2}\right)$$

$$y_{t+\lambda\Delta t} = y_t + (y_{t+\Delta t} - y_t) \cdot \lambda^3 + \dot{y}_t(1 - \lambda^2) \cdot \lambda \Delta t + \ddot{y}_t(1 - \lambda) \cdot \lambda^2 \cdot \frac{\Delta t^2}{2}$$

$$\dot{y}_{t+\lambda\Delta t} = \frac{(y_{t+\Delta t} - y_t)}{\alpha \Delta t} \cdot \delta \lambda^2 + \dot{y}_t \left(1 - \frac{\delta}{\alpha} \lambda^2\right) + \ddot{y}_t \left(1 - \frac{\delta \lambda}{2\alpha}\right) \lambda \Delta t.$$

These could be used to calculate a 'residual' at any time within the time-step. That is

$$\text{RES} = K y_{t+\lambda\Delta t} + M \ddot{y}_{t+\lambda\Delta t} + C_L \dot{y}_{t+\lambda\Delta t} - P_{t+\lambda\Delta t} + F_{NL_{t+\lambda\Delta t}}.$$

Based on numerical experiments, it has been reported [9, 11] that this residual increases at a fast rate when the error associated with the time stepping solution becomes significant. Hibbit and Karlsson [11] have found that if the half-step residual is of the order of  $0.01P$ , the time stepping solution has high accuracy. Sauvé and Teper [9] have used a tolerance on the residual based on the maximum forces that occur in the solution. They also caution about too small a tolerance on the residual as they feel that the tolerance may be related to the terms higher than second order in the Taylor series expansion for displacement and acceleration. So, too small a tolerance could result in no satisfaction of the criteria of the algorithm even though the solution could have high accuracy.

The effect of this tolerance has been studied by the authors while solving the sample problem reported in this paper. It is found that specifying the tolerance based on the forces at the particular step gives

excellent results. Accordingly, the solutions reported here have been carried out with a tolerance of  $0.02P$  with  $\lambda = 0.5$ .

A tolerance as high as even  $0.1P$  gives qualitatively the same results as above. This could be explained by the fact that increasing the tolerance and hence the time-step is equivalent to providing higher damping at higher frequencies [13] when solution is carried out using the Newmark method with  $\delta = 1/2$  and  $\alpha = 1/4$ .

#### 4. NUMERICAL INTEGRATION SCHEME BASED ON THE FOURTH-ORDER RUNGE-KUTTA METHOD

To assess the Newmark method, the same problem of SDOF impact oscillator was solved using the Runge-Kutta methods.

##### 4.1. Formulation of the SDOF impact oscillator

The governing equation of motion (2) could be written as three first-order differential equations as

$$\dot{x}_1 = x_2; \quad \dot{x}_2 = -Kx_1 - Cx_2 + P_0 - P_{NL}; \quad \dot{\tau} = \omega,$$

where

$$P_0 = -m\omega^2 x_0 \sin \tau$$

$$P_{NL} = 0 \quad \text{for } x_1 \leq \text{gap}$$

$$= K_{NL}(x_1 - \text{gap}) \quad \text{for } x_1 > \text{gap}.$$

##### 4.2. Solution scheme

There have been many adaptations of the classical Runge-Kutta method to gain different advantages. The sample problem presented in the subsequent section has been solved by the classical Runge-Kutta method and the Gill method with comparable results. The Gill method is said to have additional advantages of less storage registers, control of the growth of rounding off errors, stability and economical computation [14]. So this has been used for comparing with the Newmark method.

##### 4.3. Choice of step length

Since there is stiffness change at a particular value of displacement, the time-step has been chosen as  $1/200$ th of the loading period. It could have also been solved using different time-steps at the different stiffness regions. However, since the aim of the study has been to confirm the ability of Newmark's method to solve chaotic problems, such a simplified but small time-step solution would provide an adequate basis for comparison.

#### 5. SAMPLE PROBLEM: RESULTS AND DISCUSSIONS

For the purpose of relative assessment of the two methods, the SDOF impact oscillator shown in Fig. 3 was solved by both Newmark and Runge-Kutta

methods. Since the response is chaotic, the solutions cannot be compared numerically. However, graphical comparison of the two solutions can be made [15].

Figure 4 shows the time history response and Fig. 5 shows the Poincaré map at every  $45^\circ$  phase increment for the Newmark solution. Figures 6 and 7 show the corresponding solution by the Runge-Kutta Method. Both the results are for values of  $\omega = 2.4$  and  $x_0 = 3.7$ .

On a scrutiny of Figs 4-7, the following could be observed:

(a) The Newmark method produces results which are comparable qualitatively with the results obtained by Runge-Kutta simulation.

(b) There could be considerable saving of the computer effort by the use of the Newmark method for this class of problems. For completeness, Table 1 gives the execution time for the two methods. It could be argued that Runge-Kutta solution scheme could have been carried out with larger time-steps. However, the present study is to assess the Newmark method's ability to solve chaotic problems. Such an assessment would be the first step towards solving actual chaotic problems through techniques like FEM, for which integration schemes like the Runge-Kutta method are known to be not very efficient [4].

(c) As brought out in Sec. 3.3, the error tolerance on the Newmark method could be perceived as higher damping at higher frequencies [13]. Figure 8 shows the Poincaré map at  $\theta = 0$  when solved using a half-step tolerance of 10% confirming such a perception.

#### 6. CONCLUSIONS

Solution of the chaotic vibration problems in non-linear systems involves the numerical integration of the governing equations of motion over a large time duration. To capture the characteristics of chaotic motion, it is necessary to solve for a large number of load cycles after the transients have died down. This study shows that computationally efficient integration schemes like the Newmark method could be adopted for the class of impacting oscillators. The results from this solution scheme are qualitatively the same as the fourth-order Runge-Kutta scheme. Such efficient schemes are expected to ease the solution of chaos in continuous and multi-degree-of-freedom systems, which are currently being attempted by the authors.

#### REFERENCES

1. F. C. Moon and S. W. Shaw, Chaotic vibration of a beam with non-linear boundary conditions. *Int. J. Non-linear Mech.* 8, 465-477 (1983).
2. E. H. Dowell and C. Pezeshki, On understanding of chaos in Duffing's equation including a comparison with experiment. *J. appl. Mech.* 53, 5-9 (1986).

3. K. J. Bathe and E. L. Wilson, *Numerical Methods in Finite Element Techniques*. Prentice-Hall (1978).
4. R. D. Cook, *Concepts and Application of Finite Element Analysis*. John Wiley (1981).
5. T. Belytschko, A survey of numerical methods and computer programs for dynamic structural analysis. *Nucl. Engng Des.* **37**, 23–34 (1976).
6. T. J. R. Hughes and T. Belytschko, A precis of developments in computational methods for transient analysis. *ASME J. appl. Mech.* **50**, 1033–1040 (1983).
7. N. Newmark, A method for computation for structural dynamics. *ASCE, J. Engng Mech. Div.* **85**, No. EM3 (1959).
8. P. G. Reinhall, T. K. Caughey and D. W. Storti, Order and chaos in a discrete duffing oscillator. Implications of numerical integration. *ASME J. appl. Mech.* **56**, 162–167 (1989).
9. R. G. Sauvé and W. W. Teper, Impact simulation of process equipment tubes and support plate—a numerical algorithm. *ASME J. Pressure Vessel Technol.* **109**, 70–79 (1987).
10. S. M. Ma and K. J. Bathe, On finite element analysis of pipe whip problems. *Nucl. Engng Des.* **37**, 413–430 (1976).
11. H. D. Hibbit and B. I. Karlsson, Analysis of pipe whip. EPRI report No. NP-1208 (1979).
12. T. Belytschko and D. F. Schoeberle, On unconditional stability of an implicit algorithm for non-linear structural dynamics. *ASME J. appl. Mech.* 865–869 (1975).
13. B. J. Dobson, The Newmark and mode superposition methods for transient analysis of a linear structure—a case study. *International Conference on Numerical Methods for Transient and Coupled Problems*, Venice, 9–13 July (1984).
14. E. V. Krishnamurthy and S. K. Sen, *Computer Based Numerical Algorithms*. East-West Press, New Delhi (1976).
15. F. C. Moon, *Chaotic Vibrations*. John Wiley (1987).