

1 Port PS/2 USB VGA Server Remote Control IP KVM with Virtual Media and RS232

SV1108IPEXT

SV1108IPEXGB

SV1108IPEXEU

SV1108IPPOW

SV1108IPPWGB

SV1108IPPWEU



*actual product may vary from photos

DE: Bedienungsanleitung - de.startech.com

FR: Guide de l'utilisateur - fr.startech.com

ES: Guía del usuario - es.startech.com

IT: Guida per l'uso - it.startech.com

NL: Gebruiksaanwijzing - nl.startech.com

PT: Guia do usuário - pt.startech.com

For the most up-to-date information, please visit: www.startech.com

FCC Compliance Statement

This equipment has been tested and found to comply with the limits for a Class B digital device, pursuant to part 15 of the FCC Rules. These limits are designed to provide reasonable protection against harmful interference in a residential installation. This equipment generates, uses and can radiate radio frequency energy and, if not installed and used in accordance with the instructions, may cause harmful interference to radio communications. However, there is no guarantee that interference will not occur in a particular installation. If this equipment does cause harmful interference to radio or television reception, which can be determined by turning the equipment off and on, the user is encouraged to try to correct the interference by one or more of the following measures:

- Reorient or relocate the receiving antenna.
- Increase the separation between the equipment and receiver.
- Connect the equipment into an outlet on a circuit different from that to which the receiver is connected.
- Consult the dealer or an experienced radio/TV technician for help.

Use of Trademarks, Registered Trademarks, and other Protected Names and Symbols

This manual may make reference to trademarks, registered trademarks, and other protected names and/or symbols of third-party companies not related in any way to StarTech.com. Where they occur these references are for illustrative purposes only and do not represent an endorsement of a product or service by StarTech.com, or an endorsement of the product(s) to which this manual applies by the third-party company in question. Regardless of any direct acknowledgement elsewhere in the body of this document, StarTech.com hereby acknowledges that all trademarks, registered trademarks, service marks, and other protected names and/or symbols contained in this manual and related documents are the property of their respective holders.

Table of Contents

Introduction	1
System Requirements	1
Video	2
Operating Systems	2
Servers	3
Package Contents	3
Conventions	4
Terminology	4
Components	5
Front View	5
Rear View.....	6
Custom KVM Cables	7
Custom Console Cable	8
Hardware Setup.....	8
Rack Mounting	9
DIN Rail Mounting	11
Installation	12
Browser Login	14
Logging In	15
Main Webpage Elements	17
Administrative Function Icons	19
Exit Macro	20
Managing Power (SV1108IPPOW only).....	21
Schedule (SV1108IPPOW only)	25

Auto Ping (SV1108IPPOW only)	27
User Preferences	29
Administration	31
Device Information.....	32
Network	34
IP Address	35
SMTP Settings.....	37
Syslog Server.....	39
DDNS	39
RADIUS Settings	40
LDAP Settings.....	42
Security	45
Login String.....	47
Account Policy	48
Encryption	50
Virtual Media	51
Private Certificate.....	51
User Management	54
Console Management	57
Serial Console	58
Sessions	66
Customization	66
Date/Time	69
Maintenance	70
Firmware Upgrade.....	71
Backup	72
Restore	72

The WinClient Viewer	74
Navigation	75
The WinClient Control Panel	76
Hotkeys	80
Macros	82
Video Settings	89
The Message Board	94
Virtual Media	97
The On-Screen Keyboard	101
Mouse Pointer Type.....	102
Automatic Mouse Synchronization (DynaSync)	103
Mac and Linux Considerations	103
Manual Mouse Synchronization	104
The JavaClient Viewer	107
Introduction	107
Navigation	108
The JavaClient Control Panel	109
Hotkeys	113
Macros.....	113
Message Board.....	116
Virtual Media.....	118
Zoom	118
The On-Screen Keyboard	119
Mouse Pointer Type.....	119
Control Panel Configuration	120
The Log File Screen	121

The Log Server	122
Installation	122
Starting Up	123
The Menu Bar	124
Configure	124
Search	125
Maintenance	127
The Log Server Main Screen.....	128
The List Panel	129
The Tick Panel	130
AP Operation	131
The Windows Client AP	131
The Administrator Utility	136
The Java Client AP	146
Appendix	149
Safety Instructions	149
Rack Mounting	151
IP Address Determination	152
Browser	153
AP Windows Client	153
IPv6	154
Port Forwarding	155
Keyboard Emulation	156
PPP Modem Operation	158
Trusted Certificates.....	160
Troubleshooting.....	165
General Operation	165
Java.....	167
Sun Systems	168

Mac Systems	170
The Log Server	170
Additional Mouse Synchronization Procedures.....	171
Virtual Media Support	173
Administrator Login Failure	174
Specifications.....	175
Technical Support	176
Warranty Information.....	176

Introduction

The SV1108IPEXT/POW 1 Port Remote Control IP KVM Switch with Virtual Media lets you control a USB or PS/2 server remotely over a LAN or the Internet.

The 1 port KVM over IP includes all necessary KVM cables, and offers KVM control from the BIOS-level onward. Reboot, monitor the entire boot process, and interact with your connected system easily, while the integrated single-port power switch allows you to power the server on or off remotely. RS232 support also lets you connect to a serial console device via Telnet or SSH.

Virtual Media lets you execute files via USB from the remote console as if they were local to the connected server. Perfect for remote driver updates, patches, application or OS installation.

The Java-based browser utility ensures the IP remote control unit is compatible with many current web browsers, and almost any operating system on the market.

Multiple integrated security features ensure a reliable single port IP KVM connection, including password-protection, IP/MAC address filtering, external authentication (RADIUS, LDAP, LDAPS, Active Directory) and advanced encryption (56-bit DES, 168-bit 3DES, 256-bit AES, 128-bit RC4).

The integrated remote power switch (SV1108IPPOW only) lets you Power the server on or off remotely as necessary.

Backed by a StarTech.com 2-year warranty and free lifetime technical support.

System Requirements

Remote User Computers

Remote user computers (also referred to as client computers) are the ones the users log into the switch with from remote locations over the internet. The following equipment must be installed on these computers:

For best results we recommend that the computers used to access the switch have at least a P III 1 GHz processor, with their screen resolution set to 1024 x 768.

Browsers must support 128 bit SSL encryption.

For best results, a network transfer speed of at least 128 kbps is recommended.

For the Log Server, you must have the Microsoft Jet OLEDB 4.0 or higher driver installed.

For Safe Shutdown:

The computer must be running Windows (Windows 2000 or higher), or Linux.

The Safe Shutdown program (available by download from our website), must be installed and running on the computer.

Video

Only the following non-interlaced video signals are supported:

Resolution	Refresh Rates
640 x 480	60, 72, 75, 85, 90, 100, 120
720 x 400	70
800 x 600	56, 60, 72, 75, 85, 90, 100, 120
1024 x 768	60, 70, 75, 85, 90, 100
1152 x 864	60, 70, 75, 85
1280 x 720	60
1280 x 1024	60, 70, 75, 85
1600 x 1200	60

Operating Systems

Supported operating systems for remote user computers that log into the SV1108IPEXT/POW include Windows 2000 and higher, and other systems capable of running Sun's Java Runtime Environment (JRE) 6, Update 3, or higher (Linux, Mac, Sun, etc.).

Browsers

Supported browsers for users that log into the SV1108IPEXT/POW include the following:

Browser	Version
Internet Explorer	6 and higher
Chrome	8.0 and higher
Firefox	3.5 and higher
Safari	3.0 and higher
Opera	4.0 and higher
Windows	3.1 and higher
Linux	10.0 and higher
Windows	1.7 and higher
Mac	1.7 and higher
Mozilla	1.7 and higher
Sun	9.0 and higher
Netscape	

Servers

Servers are the computers connected to the switch via KVM Cables. The following equipment must be installed on these servers:

A VGA, SVGA or multisync port

For USB KVM Cable Connections: a Type A USB port and USB host controller

For PS/2 KVM Cable Connections: 6-pin Mini-DIN keyboard and mouse ports

Package Contents

SV1108IPEXT

- IP KVM Switch
- Console Cable
- PS/2 KVM Cable
- USB 2.0 Virtual Media Cable
- USB KVM Cable
- Rack Mount Kit
- Software CD
- Instruction Manual (on CD)
- Quick Start Guide

SV1108IPPOW

- IP KVM Switch
- Console Cable
- PS/2 KVM Cable
- USB 2.0 Virtual Media Cable
- USB KVM Cable
- Rack Mount Kit
- Software CD
- Instruction Manual (on CD)
- Quick Start Guide

Conventions

This manual uses the following conventions:

Monospaced Indicates text that you should key in.

[] Indicates keys you should press. For example, [Enter] means to press the Enter key. If keys need to be chorded, they appear together in the same bracket with a plus sign between them: [Ctrl+Alt].

1. Numbered lists represent procedures with sequential steps.

◆ Bullet lists provide information, but do not involve sequential steps.

➔ Indicates selecting the option (on a menu or dialog box, for

Terminology

Throughout the manual we make reference to the terms Local and Remote in regard to the operators and equipment deployed in a SV1108IPEXT/POW installation. Depending on the point of view, users and servers can be considered Local under some circumstances, and Remote under others:

Switch's Point of View

Remote users – We refer to a user as a Remote user when we think of him as someone who logs into the switch over the net from a location that is remote from the switch.

Local Console – The keyboard mouse and monitor connected directly to the switch.

Servers – The servers attached to the switch via custom KVM cables.

User's Point of View

Local client users – We refer to a user as a Local client user when we think of him as sitting at his computer performing operations on the servers connected to the switch that is remote from him.

Remote servers – We refer to the servers as Remote servers when we think of them from the Local Client User's point of view – since, although they are locally attached to the switch, they are remote from him.

When we describe the overall system architecture we are usually speaking from the switch's point of view – in which case the users are considered remote. When we speak about operations users perform via the browser, viewers, and AP programs over the net, we are usually speaking from the user's point of view – in which case the switch and the servers connected to it are considered remote.

Components

Front View



No.	Component	Description
1	LAN Port	The Cat 5e cable that connects the SV1108IPEXT/POW to the LAN, WAN, or Internet plugs in here.
2	Firmware Upgrade/Reset Switch	<ol style="list-style-type: none">Pressing and releasing this switch performs a SV1108IPEXT/POW system reset.Pressing and holding this switch for more than three seconds returns the SV1108IPEXT/POW to its factory default configuration settings.Pressing and holding this switch while powering on the switch returns the SV1108IPEXT/POW to its factory default firmware level. This operation should only be performed in the event of a firmware upgrade failure that results in the device becoming inoperable. <p>NOTE: This switch is recessed and must be pushed with a thin object - such as the end of a paper clip, or a ballpoint pen.</p>
3	10/100 Mbps LED	The LED lights ORANGE to indicate 10 Mbps data transmission speed. It lights GREEN to indicate 100 Mbps data transmission speed.
4	Link LED	Flashes GREEN to indicate that a Client program is accessing the device.
5	Power LED	Lights ORANGE when the SV1108IPEXT/POW is powered up and ready to operate.
6	Power Outlet LED	Lights ORANGE when the server attached to the SV1108IPPOW's power outlet is powered on (SV1108IPPOW only)

Rear View

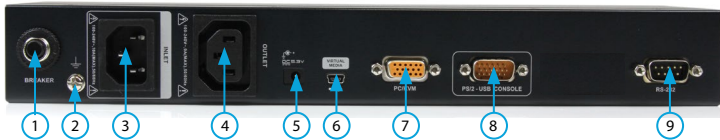

No.	Component	Description
1	Circuit Breaker	As a safety measure, if there is an overcurrent situation, the circuit breaker will trip. Press this button to recover normal operation. (SV1108IPPOW Only)
2	Grounding Terminal	The wire used to ground the unit connects here. (SV1108IPPOW Only)
3	Power Inlet	The power cord that connects the SV1108IPPOW to an AC power source for power management functionality plugs in here. (SV1108IPPOW Only)
4	Power Outlet	The power cord provided with the SV1108IPPOW package that connects to the server for power management plugs in here. (SV1108IPPOW Only)
5	Power Jack	The power adapter cable plugs in here.
6	Virtual Media Port	The cable that connects the SV1108IPEXT/POW to a USB port on your server or KVM switch plugs in here.
7	PC/KVM Port	The KVM cable provided with this package that links the SV1108IPEXT/POW to your server / KVM switch plugs in here.
8	Console Port	The cable for the local console (keyboard, monitor, and mouse) plugs in here. The console can use either a PS/2 or USB keyboard and mouse. Each connector is color coded and marked with an appropriate icon.
9	RS-232 Port	This serial port is provided for: 1. Serial console management or 2. Out-of-band modem operation

Custom KVM Cables

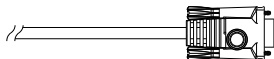
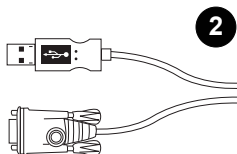
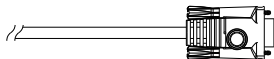
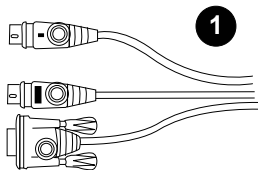

No.	Description
1	For use with PS/2 configuration servers or KVM switches.
2	For use with USB configuration servers or KVM switches.

NOTE: The advantage of using a USB cable is that it allows automatic locked-in mouse synchronization.

Custom Console Cable

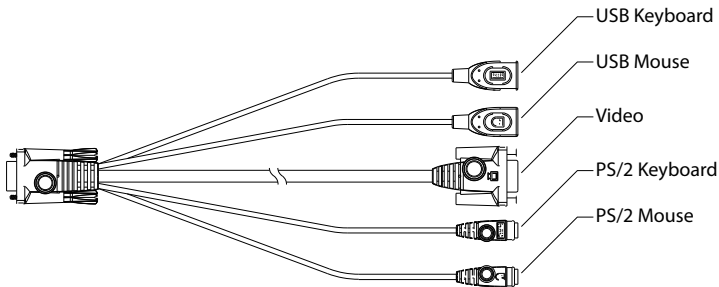

NOTE: You can use any combination of keyboard and mouse connections. For example, you can use a PS/2 keyboard with a USB mouse.

Hardware Setup

1. Important safety information regarding the placement of this device is provided on page 149. Please review it before proceeding.
2. Make sure that the power to any device that you connect to the installation has been turned off. You must unplug the power cords of any computers that have the Keyboard Power On function.
3. Any installation that does not follow the instructions in this guide may be hazardous.

Rack Mounting

For convenience and flexibility, the SV1108IPEXT/POW can be mounted on a system rack.

To rack mount the unit do the following:

1. Remove the two original screws from the top/bottom of the unit (near the rear of the unit).
2. Using the screws provided with the rack mount kit, screw the mounting bracket into the SV1108IPEXT/POW – as shown in the diagram below:

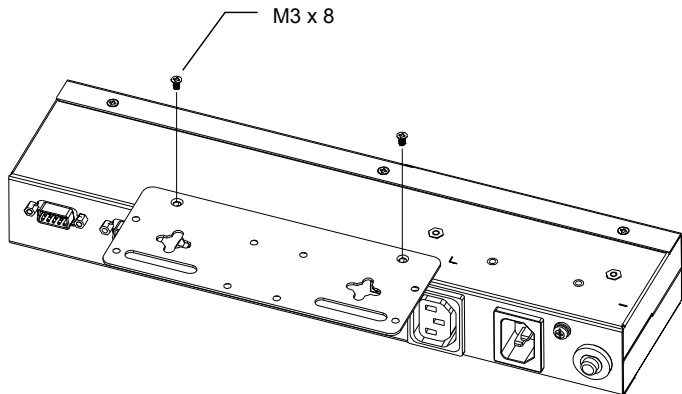

NOTE: The illustrations show the mounting bracket attached to the bottom of the unit; it can also be attached to the top.

3. Screw the bracket into any convenient location on the rack

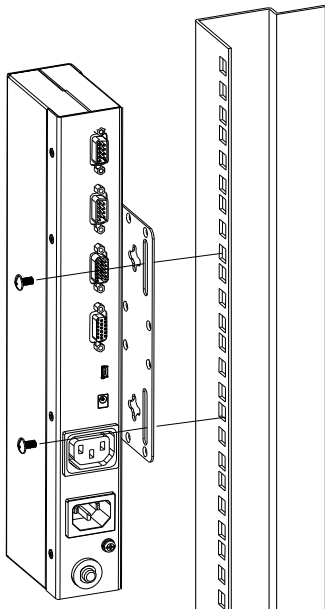

NOTE: Rack screws are not provided. Use screws that are appropriate for your rack.

DIN Rail Mounting

To mount the SV1108IPEXT/POW on a DIN rail:

1. Screw the mounting bracket to the back of the SV1108IPEXT/POW as described in steps 1 and 2 of the wall mounting procedure.
2. Use the larger screws supplied with the Rack Mount Kit to screw the DIN rail brackets to the mounting bracket – as shown in the diagram, below:

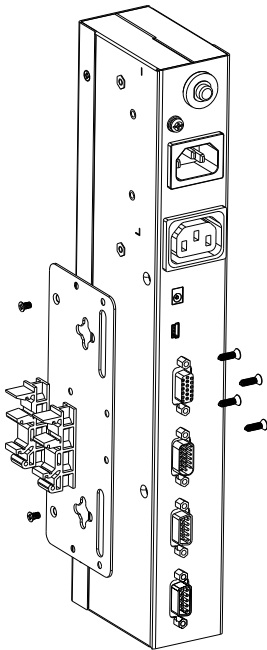

3. Hang the unit on the DIN rail.

Installation

To install the SV1108IPEXT/POW, refer to the installation diagrams on the following pages (the numbers correspond to the numbers of the steps), and do the following:

1. Ground the unit using a grounding wire. (SV1108IPPOW Only)
2. Use the Console cable provided with this package to connect the SV1108IPEXT/POW's Console port, to the local console keyboard, monitor and mouse.
NOTE: 1. The Console cable comes with connectors for both PS/2 and USB mice and keyboards – use the ones appropriate for your installation.
2. You can use any combination of keyboard and mouse connections. For example, you can use a PS/2 keyboard with a USB mouse.
3. Use the KVM cable provided with this package to connect the SV1108IPEXT/POW's PC port, to the keyboard, video and mouse ports of the server that you are installing.
4. (Optional) If you want to use the virtual media function, use the USB 2.0 Virtual Media Cable provided with this package to connect a USB port on the server to the SV1108IPEXT/POW's Virtual Media port.
5. (Optional) If you want to connect a serial console device or modem, plug its cable into the RS-232 port.
6. Plug the LAN or WAN cable into the SV1108IPEXT/POW's LAN port.
7. (SV1108IPPOW only) Use the outlet power cord provided with the package to connect the SV1108IPPOW's Power Outlet to the attached server for power management.
8. (SV1108IPPOW only) Use the power cord from the server to connect the SV1108IPPOW's Power Inlet to an AC power source.
9. Plug the power adapter cable into the SV1108IPEXT/POW's power jack, then plug the power adapter into an AC power source. This completes the hardware installation, and you are ready to start up.

NOTE: When starting up, be sure to first power on the SV1108IPEXT/POW, then power on the connected server.

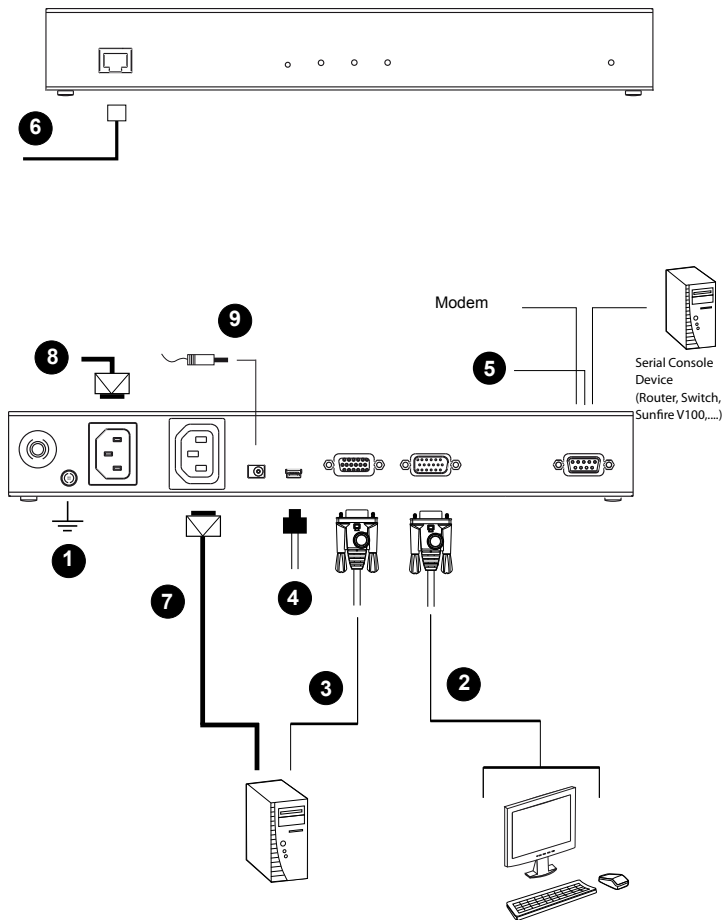

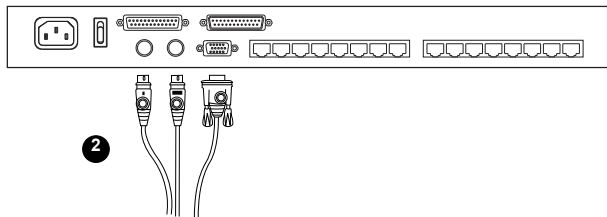
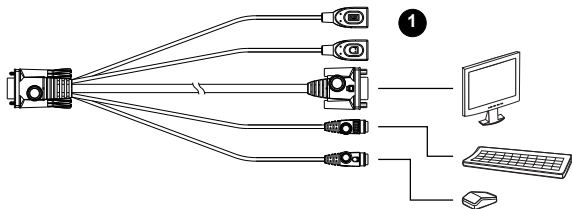

Browser Login

The SV1108IPEXT/POW can be accessed either from an internet type browser, via Windows and Java application (AP) program, or by PPP modem dial-in. The next several chapters describe browser-based operations.

NOTE: Windows Vista/7 users who want to use the SV1108IPEXT/POW's Virtual Media feature must run the internet browser as an Administrator.

Logging In

To operate the SV1108IPEXT/POW from an Internet browser, begin by logging in:

1. Open your browser and specify the IP address of the SV1108IPEXT/POW you want to access in the browser's URL location bar.

NOTE: For security purposes, a login string may have been set by the administrator. If so, you must include a forward slash and the login string along with the IP address when you log in. For example:

192.168.0.60/SV1108IPEXT

If you don't know the IP address and login string, ask your Administrator.

If you are the administrator, and are logging in for the first time, the various ways to determine the SV1108IPEXT/POW's IP address are described in the Appendix on page 152. A Security Alert dialog box appears.



Accept the certificate – it can be trusted. If a second certificate appears, accept it as well.

The SV1108IPEXT/POW login page appears:

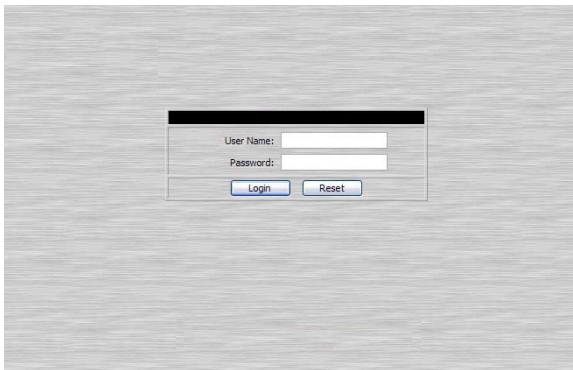

3. Provide a valid Username and Password (set by the SV1108IPEXT/POW administrator), then click Login to continue.

NOTE:

1. If you are the administrator, and are logging in for the first time, use the default Username: administrator; and the default Password: password. For security purposes, we strongly recommend you remove these and give yourself a unique Username and Password.
2. If you supplied an invalid login, the authentication routine will return this message: Invalid Username or Password. Please try again. If you see this message, log in again being careful with the Username and Password.

After you have successfully logged in, the SV1108IPEXT/POW Main Screen appears:

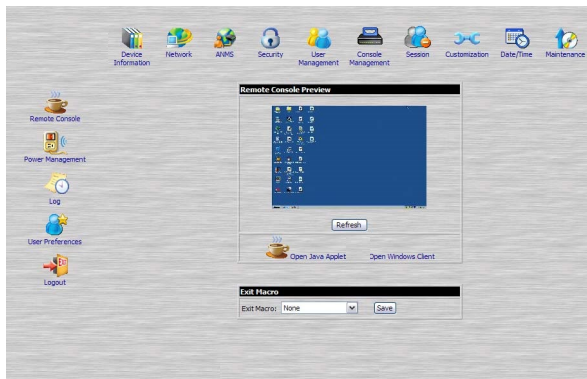





Main Webpage Elements

The Main page consists of user access icons arranged vertically down the left side; administrative function icons arranged across the top; a Remote Console Preview window with an icon to launch the Java or WinClient Viewer displayed in the center; and an Exit Macro list box just below the Remote Console Preview

NOTE: If a user doesn't have permission to perform a particular activity, the icon for that activity doesn't appear.

Utility Icons

The icons arranged down the left side perform the following functions:

Icon	Purpose
	<p>Remote Console: Clicking this icon closes whatever is displayed on the Main Screen, and brings back the Remote Console Preview.</p>
	<p>(SV1108IPPOW only) Power Management: If you have the proper permission, clicking this icon will bring up the SV1108IPPOW's power control interface, allowing you to reset power over the network and use the Wake on LAN feature.</p>
	<p>Log: All the events that take place on the SV1108IPEXT/POW are recorded in a log file. If you have the proper permission, clicking this icon displays the contents of the log file.</p>
	<p>User Preferences: Click this icon to set up your own, individual, browsing environment. The switch stores a separate configuration record for each user profile, and sets up the browser configuration according to the Username that you key into the Login dialog box.</p>
	<p>Logout: Click this icon to log out and end your SV1108IPEXT/POW session. It is important to log out when you end your session. Otherwise, you must wait until the timeout setting has expired before the SV1108IPEXT/POW can be accessed again.</p>

Administrative Function Icons

The icons arranged horizontally across the top of the page are linked to the administration utilities, which are used to configure the SV1108IPEXT/POW.

Remote Console Preview

The main portion of the panel shows a snapshot of the server's display.

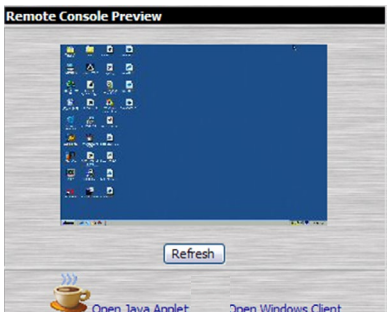

Clicking Refresh updates the snapshot of the remote display.

The links that appear below the Refresh button depend on the browser you are using, and your User Preferences Viewer choice:

If you are logging in with a browser other than Windows Internet Explorer, a Java Applet Viewer icon (a steaming cup of coffee), and the link words "Open Viewer" display.

If you are logging in with IE as your browser, and you chose Auto Detect as your Viewer choice (the default), The WinClient icon and the link words "Open Viewer" display.

If you are logging in with IE as your browser, and you chose Java as your Viewer choice a Java Applet Viewer icon (a steaming cup of coffee), and the link words "Open Viewer" display.

If you are logging in with IE as your browser, and you chose User Select as your Viewer choice, both the Java Applet Viewer and WinClient Viewer icons appear.

Click the appropriate link to have the viewer open the remote server's display on your desktop.

NOTE: If you selected Auto Detect or Java, you can also open the remote server's display by clicking on the snapshot window directly.

Exit Macro

The Exit Macro panel contains a dropdown list box of user created System macros:



You can select a macro from the list that will execute when exiting the remote server.

Telnet/SSH Viewer

If Serial Console Management has been enabled (see Serial Console, page 58), a Telnet/SSH Viewer panel displays directly below the Exit Macro panel:



These viewers allow users to open a Telnet or SSH session to the SV1108IPEXT/POW from the browser. Depending on the user's permissions, the Telnet Viewer link or SSH Viewer link, or both links are shown.

Click the appropriate link to have the viewer open the session.

Managing Power (SV1108IPPOW only)

To help you manage and control your entire data center environment, a built-in single-port power switch allows remote power management of a server/ installation connected locally to the SV1108IPPOW

If you have the proper permission, clicking this icon will bring up the SV1108IPPOW's power control interface, allowing you to reset power over the network, use the Wake on LAN feature, schedule routines, use the Auto Ping function. These are all detailed in the sections that follow:

Power Management



Confirmation Required Enable

Power On Delay: 0 seconds

Power Off Delay: 0 seconds

Shutdown Method: Wake on LAN

MAC: 000000000000

Schedule

Select	Routine Type	Start Date	End Date	Day	Shutdown Time(HH:MM)	Restart Time(HH:MM)
<input type="button" value="Add"/> <input type="button" value="Delete"/>						

Auto Ping

Enable

Ping Address: IP Address of device to be tested

Interval: 1 (1-255) seconds

Fail Count: 1 1-99

Action: Send Email

PON Port Setting

PON Device Enable 2-Wire RS232

Power Management (SV1108IPPOW only)

This section lets you set up the power management for the SV1108IPPOW's power switch.

Power Management	
Confirmation Required	<input type="checkbox"/> Enable
Power On Delay:	0 seconds
Power Off Delay: :	0 seconds
Shutdown Method:	Wake on LAN
MAC:	000000000000

The meanings of the field headings are given in the following table:

	Click the Outlet icon to power operations on and off. A green outlet icon indicates that the power is currently On.
Confirmation Required	If this option is enabled (there is a check in the checkbox), a dialog box comes up asking you to confirm a power operation before it is performed. If it is disabled (there is no check in the checkbox), the operation is performed without confirmation.
Power On Delay	Sets the amount of time the SV1108IPPOW waits after the Power Button is clicked before it turns on the power to the outlet. NOTE: The default delay time is 0 seconds; the maximum is 999 seconds.
Power Off Delay	Sets the amount of time the SV1108IPPOW waits after the Power Button is clicked before it turns off the power to the outlet. For the System after AC Back option (see below), after the delay time expires, the SV1108IPPOW waits another fifteen seconds, then shuts the computer down. The default delay time is 15 seconds. The maximum delay time is 999 seconds.

Shutdown Method

There are three choices for the Shutdown method. Drop down the list to select a choice. The meaning of each choice is described, below:

Wake on LAN: This is a Safe Shutdown and Restart option. If this is selected, when an Outlet is turned Off, the SV1108IPPOW first sends a message to the computer telling it to prepare for a shutdown; it then waits for the amount time set in the Power Off Delay field to give the OS time to close down before the computer is powered down to standby mode.

Likewise, when the Outlet is turned On, the SV1108IPPOW waits for the amount time set in the Power On Delay field, then sends an Ethernet message to the computer connected to the Outlet telling the computer to turn itself On.

NOTE: For Safe Shutdown and Restart, the computer must be running Windows (98 or higher), or Linux, and the Safe Shutdown program (available by download from our website), must be installed and running on the computer.

System after AC Back: This is a Safe Shutdown and Restart option. If this is selected, when an Outlet is turned Off, the SV1108IPPOW first sends a message to the computer telling it to prepare for a shutdown; it then waits for the amount time set in the Power Off Delay field to give the OS time to close down before the computer is powered down.

Shutdown Method (Continued)

When the Outlet is turned On, the SV1108IPPOW waits for the amount time set in the Power On Delay field, then sends power to the server. When the server receives the power, it turns itself on.

NOTE: For Safe Shutdown and Reboot, the computer must be running Windows (98 or higher), or Linux, and the Safe Shutdown program (available by download from our website), must be installed and running on the computer.

Kill the Power: If this option is selected, the SV1108IPPOW waits for the amount time set in the Power Off Delay field, and then turns the Outlet's power Off. Turning the power off performs a cold (non-safe) shutdown.

MAC

In order to use either of the Safe Shutdown methods the MAC address of the computer connected to the outlet must be filled in here.

Schedule (SV1108IPPOW only)

Clicking the *Add* button in the Schedule section brings up a page that lets you set up a scheduled power On/Off configuration for the selected outlet:

The screenshot shows a configuration window with the following fields and options:

- Routine Type:** A dropdown menu set to "Once".
- Weekday:** A dropdown menu set to "Sunday".
- Date:** A dropdown menu set to "1".
- Start Date:** A text input field with a calendar icon and "(YYYY-MM-DD)" placeholder.
- End Date:** A text input field with a calendar icon and "(YYYY-MM-DD)" placeholder.
- Shutdown Time:** Two input fields for hours and minutes, followed by "(HH:MM)" and a "Disable" checkbox.
- Restart Time:** Two input fields for hours and minutes, followed by "(HH:MM)" and a "Disable" checkbox.
- Every:** A text input field followed by "day(s)".
- Buttons:** "Add" and "Cancel" buttons at the bottom right.

NOTE: Since the SV1108IPPOW has no RTC (real time clock) circuit, the unit will get time from the NTP server or from the client PC (sync time from client PC after a system reset or losing power).

The meanings of the field headings are given in the table, below:

Heading	Meaning
Routine Type	Drop down the list to select whether the scheduled power configuration should take place just Once, or on a Daily, Weekly, or Monthly basis.
Week Day	This field only becomes active if you choose Weekly as the routine type. If you choose Weekly, drop down the list to choose which day of the week you want the power management routine to take place on.
Date	This field only becomes active if you choose Monthly as the routine type. If you choose Monthly, drop down the list to choose which day of the month you want the power management routine to take place on.

Heading	Meaning
Start Date	<p>If you want to limit the power management routine to a particular time period, either click the calendar icon to select the date that the routine will start at, or key in a start date using the YYYY-MM-DD format</p>
End Date	<p>If you want to limit the power management routine to a particular time period, either click the calendar icon to select the date that the routine will end at, or key in an end date using the YYYY-MM-DD format</p>
Shutdown Time	<p>Key in the time of day you want the shutdown to take place using the HH:MM format.</p> <p>If you want to temporarily suspend this function without deleting the entry, click to put a check in the Disable checkbox at the right of this field. You can reinstate the function by unchecking the checkbox.</p>
Restart Time	<p>Key in the time of day you want the restart to take place using the HH:MM format.</p> <p>If you want to temporarily suspend this function without deleting the entry, click to put a check in the Disable checkbox at the right of this field. You can reinstate the function by unchecking the checkbox.</p>
Every	<p>For added flexibility, you can use this field to refine the Daily, Weekly, and Monthly routines. For example, if you chose Daily as your routine type, you could have the routine take place every 3 days (instead of every day), by keying a 3 in this field.</p>

After you have made your schedule settings, click **Add**. The schedule is summarized in the list at the bottom of the panel. To remove the outlet's schedule, select it in the list and click **Delete**.

Select	Routine Type	Start Date	End Date	Day	Shutdown Time(HH:MM)	Restart Time(HH:MM)
<input checked="" type="radio"/>	Once	2011-05-12	-----	-	02:02	03:03
<input type="radio"/>	Once	2011-05-12	-----	-	02:02	03:03
<input type="radio"/>	Once	2011-07-08	-----	-	11:22	-- : --
<input type="radio"/>	Once	2011-05-12	-----	-	-- :--	03:05

Auto Ping (SV1108IPPOW only)

The section allows you to use an ICMP ping command to check if the attached device is functioning properly. This function is detailed in the following table:

Enable	Put a check in the checkbox to enable this function.
Ping Address	Enter the IP address of the device to be pinged in this field.
Interval	This field sets how often the specified device is pinged, in second intervals. Enter a value between 1 and 255.
Fail Count	This field sets how many times the device is allowed to fail to respond to the ping before an action is taken (see below). Enter a value between 1 and 99.

Action

This field sets what action is taken if the device fails to respond to a specified number of pings. Select one of the following actions from the drop-down menu:

Send email: This sends an email using the SMTP server setting. For this function to work, you must also enable reports from the SMTP server.

Outlet Power Off/On: This resets the power at the SV1108IPPOW's power outlet.

NOTE: This action must be confirmed before saving.

No action: Select this option to do nothing if the specified device fails to respond.

NOTE: If Auto Ping fails, after power on, the SV1108IPEXT/POW waits five minutes before

User Preferences

The User Preferences page allows the user to set three parameters: Viewer, Language, and Password:

The screenshot displays a web interface for user preferences, organized into three distinct sections:

- Viewer:** This section contains three radio button options: "Auto Detect" (which is selected), "Java", and "User Select".
- Set Language:** This section features a dropdown menu currently set to "English".
- Change Password:** This section includes three input fields: "Old Password:" (filled with ten dots), "New Password:", and "Confirm New Password:". A "Change Password" button is positioned below these fields.

An "Apply" button is also present, centered between the "Set Language" and "Change Password" sections.

The page settings are explained in the following table:

Setting	Function
Viewer	<p>You can choose which viewer is used when accessing a server:</p> <p>Auto Detect will select the appropriate viewer based on the web browser used; WinClient for Windows Internet Explorer; Java Client for other web browsers (Firefox, etc.).</p> <p>Java will open the Java based viewer regardless of the web browser being used.</p> <p>User Select lets IE users bypass the Auto Detect choice and choose for themselves whether to use the WinClient or Java Applet Viewer. After making your choice, click Apply. Selects the language that the interface displays in. Drop down the list to make your selection.</p>
Language	<p>Selecting Auto causes the SV1108IPEXT/POW to display the pages in the same language that the browser is set to.</p> <p>NOTE: If your browser is set to a non-supported language, the SV1108IPEXT/POW looks to what your server's operating system is set to. If the operating system is set to a supported language it will use that language to display its pages. If the operating system is set to a non-supported language, the SV1108IPEXT/POW defaults to English. After making your choice, click Apply.</p>
Change Password	<p>To change your password, key the new password into the <i>New Password</i> input box; key the exact same characters into the <i>Confirm New Password</i> input box; then click Change Password to set the new password.</p>

Administration

Introduction

The administration utilities, represented by the icons located across the top of the SV1108IPEXT/POW web page, are used to configure the SV1108IPEXT/POW's operating environment.

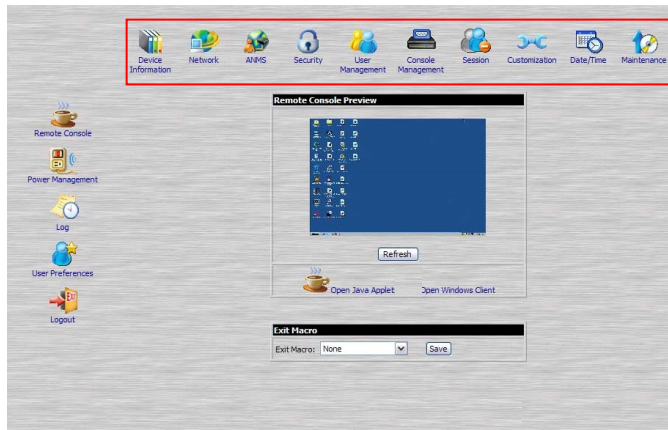

This chapter discusses each of them in turn.

NOTE:

1. As you make your configuration changes in each dialog box, click **Apply** to save them.
2. Some configuration changes only take effect after a SV1108IPEXT/POW reset. For those changes, a check is automatically put in the *Reset on Exit* box. To have the changes take effect, log out and then log back in again.
3. If you don't have Configuration privileges, the Administration configuration dialogs are not available.

Device Information

The Device Information page is the first of the Administration pages, and provides information about the SV1108IPEXT/POW's status.

Device Name:	KN1000
MAC Address:	00-10-74-61-01-EF
Firmware Version:	V1.0.060
IPv4 address:	172.17.17.10
DNS:	0.0.0.0
IPv6 address:	fe80::210:74ff:fe61:1ef
<input type="button" value="Apply"/>	

An explanation of each of the fields is given in the table below:

Field	Explanation
Device Name	To make it easier to manage installations that have more than one SV1108IPEXT/POW, each one can be given a name. To assign a name for the SV1108IPEXT/POW, key in one of your choosing here (16 characters max.), then click Apply.
MAC Address	The SV1108IPEXT/POW's MAC Address displays here.

Firmware Version	Indicates the SV1108IPEXT/POW's current firmware version level. New versions of the SV1108IPEXT/POW's firmware can be downloaded from our website as they become available. You can reference this number to see if there are newer versions available on the website.
IPV4 Address	Displays the SV1108IPEXT/POW's Internet Protocol Version 4 (32 bit) address (in the legacy format).
DNS	The IP address of the Domain Name Server.
IPV6 Address	Displays the SV1108IPEXT/POW's Internet Protocol Version 6 (128 bit) address (in the new format).

Network

The Network dialog is used to specify the SV1108IPEXT/POW's network environment.

The screenshot shows a 'Network' dialog box with three main sections: 'Service Ports', 'IP Address', and 'DNS Server'.
- **Service Ports:** HTTP: 80, Program: 9000, HTTPS: 443, Virtual Media: 9003, Telnet Port: 23, SSH Port: 22.
- **IP Address:** Radio buttons for 'Obtain IP address automatically [DHCP]' (unselected) and 'Set IP address manually [Fixed IP]' (selected). Fields: IP Address: 172.17.17.10, Subnet Mask: 255.255.255.0, Default Gateway: 172.17.17.1.
- **DNS Server:** Radio buttons for 'Obtain DNS server address automatically' (unselected) and 'Set DNS server address manually' (selected). Fields: Preferred DNS server: 172.17.1.23, Alternate DNS server: (empty).
- **Network Transfer Rate:** 99999 KBps.
- **Apply** button at the bottom right.

Service Ports

If a firewall is being used, the Administrator can specify the port numbers that the firewall will allow (and set the firewall accordingly). If a port other than the default is set, users must specify the port number as part of the IP address when they log in. If not, an invalid port number (or no port number) is specified, the SV1108IPEXT/POW will not be found.

An explanation of the fields is given in the table below:

Field	Explanation
HTTP	The port number for a browser login. The default is 80.
HTTPS	The port number for a secure browser login. The default is 443.
Telnet Port	The port for Telnet access. The default is 23.

Program	This is the port number for connecting to the SV1108IPEXT/POW from the Windows Client and Java Applet Viewers, and from the Windows and Java AP programs. The default is 9000.
Virtual Media	This is the port number used for data transfer using the SV1108IPEXT/POW's virtual media feature. Valid entries are from 1–65535. The default is 9003.
SSH Port	The port for SSH access. The default is 22.

NOTE:

1. Valid entries for all of the Service Ports are from 1–65535.
2. The service ports cannot have the same value. You must set a different value for each one.
3. If there is no firewall (on an Intranet, for example), it doesn't matter what these numbers are set to, since they have no effect.

IP Address

The SV1108IPEXT/POW can either have its IP address assigned dynamically at bootup (DHCP), or it can be given a fixed IP address.

For dynamic IP address assignment, select the *Obtain an IP address automatically*, radio button. (This is the default setting.)

To specify a fixed IP address, select the *Set IP address manually*, radio button and fill in the IP address.

NOTE:

1. If you choose Obtain IP address automatically, when the switch startups it waits to get its IP address from the DHCP server. If it hasn't obtained the address after one minute, it automatically reverts to its factory default IP address (192.168.0.60.)
2. If the SV1108IPEXT/POW is on a network that uses DHCP to assign network addresses, and you need to ascertain its IP address, see IP Address Determination, page 152, for information.

DNS Server

The SV1108IPEXT/POW can either have its DNS server address assigned automatically, or a fixed address can be specified.

For automatic DNS Server address assignment, select the Obtain DNS server address automatically, radio button.

To specify a fixed address, select the Use the following DNS server address, radio button and fill in the required information.

NOTE: Specifying at the alternate DNS Server address is optional.

Network Transfer Rate

This setting allows you to tailor the size of the data transfer stream to match network traffic conditions by setting the rate at which the SV1108IPEXT/POW transfers data to remote computers. The range is from 4–99999 Kilobytes per second (KBps).

Finishing Up

After making any network changes, be sure Reset on exit on the Customization page has been enabled (there is a check in the checkbox), before logging out. This allows network changes to take effect without having to power the SV1108IPEXT/POW off and on.

ANMS (Advanced Network Management)

The Advanced Network Management Settings page allows you to set up login authentication and authorization management from external sources. It is divided into several sections, each of which is described in the sections that follow.

IP Installer

The IP Installer is an external Windows-based utility for assigning IP addresses to the SV1108IPEXT/POW.



Click one of the radio buttons to select Enable, View Only, or Disable for the IP Installer utility.

NOTE:

1. If you select View Only, you will be able to see the SV1108IPEXT/POW in the IP Installer's Device List, but you will not be able to change the IP address.
2. For security, we strongly recommend that you set this to View Only or Disable after using it.

SMTP Settings

Enable report from the following SMTP server

SMTP Server:

Server requires authentication

Account Name:

Password:

From:

To:

Report IP address Report system reboot

Report user login Report user logout

To have the SV1108IPEXT/POW email reports from the SMTP server to you, do the following:

1. Enable the *Enable report from the following SMTP server*, and key in the IP address of your SMTP server.
2. If your server requires authentication, put a check in the *Server requires authentication* checkbox, and key in the appropriate account information in the *Account Name* and *Password* fields.
3. Key in the email address of where the report is being sent from in the *From* field.

NOTE:

1. Only one email address is allowed in the *From* field, and it cannot exceed 64 Bytes.
2. 1 Byte = 1 English alphanumeric character.
4. Key in the email address (addresses) of where you want the SMTP reports sent to in the *To* field.

NOTE:

1. If you are sending the report to more than one email address, separate the addresses with a semicolon. The total cannot exceed 256 Bytes.
2. 1 Byte = 1 English alphanumeric character.
5. Select the report options you would like sent. Choices include: Report IP address, Report system reboot, Report user login and Report user logout.

Log Server

Important transactions that occur on the SV1108IPEXT/POW, such as logins and internal status messages, are kept in an automatically generated log file

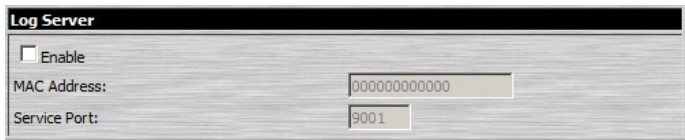

Log Server	
<input type="checkbox"/> Enable	
MAC Address:	000000000000
Service Port:	9001

Specify the MAC address of the computer that the Log Server runs on in the *MAC address* field.

Specify the port used by the computer that the Log Server runs on to listen for log details in the Port field. The valid port range is 1–65535. The default port number is 9001.

NOTE: The port number must be different than the one used for the Program port

SNMP Server



SNMP Server	
<input type="checkbox"/> Enable SNMP Agent	
Server IP:	
Service Port:	162

To be notified of SNMP trap events, do the following:

1. Check Enable SNMP Agent.
2. Key in the IP address and the port number of the computer to be notified of SNMP trap events. The valid port range is 1-65535.

NOTE: The following SNMP trap events are sent: System Power On, Login Failure, and System Reset.

Syslog Server

Syslog Server

Enable

Server IP:

Service Port:

To record all the events that take place on the SV1108IPEXT/POW and write them to a Syslog server, do the following:

1. Check Enable.
2. Key in the IP address and the port number of the Syslog server. The valid port range is 1-65535.

DDNS

DDNS

Enable

Host Name:

DDNS:

Username:

Password:

DDNS Retry Time: hours

DDNS allows the mapping of a dynamic IP address assigned by a DHCP server to a hostname. To provide DDNS capability for the SV1108IPEXT/POW, do the following:

1. Check Enable.
2. Enter the hostname that you registered with your DDNS service provider.
3. Drop down the list to select the DDNS service you are registered with.
4. Key in the Username and Password that authenticates you with your DDNS service.
5. If the SV1108IPEXT/POW's IP address changes, it must update the DDNS server so that the new address is properly associated with its hostname. If it fails to update the DDNS server, it must try again at a later time. Key in the amount of time (in hours) to wait before trying to update the DHCP server again.

Disable Local Authentication

Selecting this option will disable login authentication locally on the SV1108IPEXT/POW. The switch can only be accessed using LDAP, LDAPS, MS Active Directory, RADIUS or CC Management authentication.

RADIUS Settings

RADIUS Settings

Enable

Primary RADIUS Server IP: Port:

Alternate RADIUS Server IP: Port:

Timeout (seconds): Retries:

Shared Secret (at least 6 characters):

To allow authentication and authorization for the SV1108IPEXT/POW through a RADIUS server, do the following:

1. Check Enable.
2. Fill in the IP addresses and port numbers for the Preferred and Alternate RADIUS servers.
3. In the Timeout field, set the time in seconds that the SV1108IPEXT/POW waits for a RADIUS server reply before it times out.
4. In the Retries field, set the number of allowed RADIUS retries.
5. In the Shared Secret field, key in the character string that you want to use for authentication between the SV1108IPEXT/POW and the RADIUS Server.
6. On the RADIUS server, set the access rights for each user according to the information in the table below:

Character	Meaning
C	Grants the user administrator privileges, allowing the user to configure the system.
W	Allows the user to access the system via the Windows Client program.

Character	Meaning
J	Allows the user to access the system via the Java applet.
P	Allows the user to Power On/Off, Reset devices via an attached PN0108.
L	Allows the user to access log information via the user's browser.
V	Limits the user's access to only viewing the video display.
S	Allows the user to use the Virtual Media function in Read Only mode.
M	Allows the user to use the Virtual Media function in Read/Write mode.
T	Allows the user to access the system via a Telnet session.
H	Allows the user to access the system via an SSH session.
A	Allows the user to access the system via a Telnet or SSH session
SU/USER	Where user represents the Username of a SV1108IPEXT/POW user whose permissions reflect the permissions you want the RADIUS authorized user to have.

NOTE:

1. The characters are not case sensitive. Capitals or lower case work equally well.
2. Characters are comma delimited.

RADIUS Examples

RADIUS Server access rights examples are given in the table, below:

String	Meaning
C,W,P	User has administrator privileges; user can access the system via the Windows Client; user can access the attached PN0108
W,J,L	User can access the system via the Windows Client; user can access the system via the Java Applet; user can access log information via the user's browser.

LDAP Settings

The SV1108IPEXT/POW allows log in authentication and authorization through external programs. To allow authentication and authorization via LDAP or LDAPS, the Active Directory's LDAP Schema must be extended so that an extended attribute name for the SV1108IPEXT/POW – **SV1108IPEXT/POW-accessRight** – is added as an optional attribute to the person class.

NOTE: *Authentication* refers to determining the authenticity of the person logging in; *authorization* refers to assigning permission to use the device's various functions.

In order to configure the LDAP server, you will have to complete the following procedures: 1) Install the Windows Server Support Tools; 2) Install the Active Directory Schema Snap-in; and 3) Extend and Update the Active Directory Schema.

LDAP Settings

Enable

LDAP LDAPS Enable Authorization

LDAP Server IP: Port:

Timeout (seconds):

LDAP Administrator DN:

LDAP Administrator Password:

Search DN:

Admin Group:

To allow authentication and authorization for the SV1108IPEXT/POW via LDAP / LDAPS, refer to the information in the following table.

Item	Action
Enable	Put a check in the <i>Enable</i> checkbox to allow LDAP / LDAPS authentication and authorization.
LDAP/LDAPS	Click a radio button to specify whether to use LDAP or LDAPS.

Item	Action
<p>Enable Authorization</p>	<p>Select whether to enable <i>Enable Authorization</i>, or not.</p> <ol style="list-style-type: none"> 1. If enabled (the box is checked), the LDAP / LDAPS server directly returns a 'permission' attribute and authorization for the user that is logging in. With this selection the LDAP schema must be extended. 2. If not enabled (no check in the box), the result the server returns indicates whether the user that is logging in belongs to the 'SV1108IPEXT/POW Admin Group'. If the result is 'yes' the user has full access rights; if the result is 'no', the user only has limited access rights. <p>NOTE: Consult the LDAP / LDAPS administrator to ascertain whether to enable the Enable Authorization function, or not.</p>
<p>LDAP Server IP and Port</p>	<p>Fill in the IP address and port number for the LDAP or LDAPS server. For LDAP, the default port number is 389; for LDAPS, the default port number is 636.</p>
<p>Timeout</p>	<p>Set the time in seconds that the SV1108IPEXT/POW waits for an LDAP or LDAPS server reply before it times out.</p>
<p>LDAP Administrator DN</p>	<p>Consult the LDAP / LDAPS administrator to ascertain the appropriate entry for this field. For example, the entry might look like this:</p> <pre>kn=LDAPAdmin,ou=SV1108IPPOW,dc=aten,dc=com</pre>
<p>LDAP Administrator Password</p>	<p>Key in the LDAP administrator's password.</p>

Item	Action
<p>Search DN</p>	<p>Set the distinguished name of the search base. This is the domain name where the search starts for user names.</p> <p>NOTE: If <i>Enable Authorization</i> is not checked, this field must include the entry where the <i>SV1108IPEXT/POW Admin Group</i> is created. Consult the LDAP / LDAPS administrator to ascertain the appropriate value.</p>
<p>SV1108IPEXT/POW</p>	<p>Key in the Group Name for SV1108IPEXT/POW administrator users.</p> <p>NOTE: If <i>Enable Authorization</i> is not checked, this field is used to authorize users that are logging in. If a user is in this group, the user receives full access rights. If a user is not in this group, the user only receives limited access rights. Consult the LDAP / LDAPS administrator to ascertain the appropriate value.</p>

Security

The Security page controls access to the SV1108IPEXT/POW.

The screenshot displays the 'User Station Filters' configuration window. It is divided into two main sections for filtering users based on IP address and MAC address.

- IP Filter Section:**
 - Checkbox: IP Filter Enable
 - Radio buttons: Include, Exclude
 - A list box for IP addresses with up and down arrows.
 - Buttons: Add, Edit, Delete
- MAC Filter Section:**
 - Checkbox: MAC Filter Enable
 - Radio buttons: Include, Exclude
 - A list box for MAC addresses with up and down arrows.
 - Buttons: Add, Edit, Delete
- Login String:** A text input field at the bottom of the window.

User Station Filters

If any filters have been configured, they appear in the IP Filter and/or MAC Filter list boxes.

IP and MAC Filters control access to the SV1108IPEXT/POW based on the IP and/or MAC addresses of the computers attempting to connect. A maximum of 100 IP filters and 100 MAC filters are allowed.

To enable IP and/or MAC filtering, **click** to put a check mark in the *IP Filter Enable* and/or *MAC Filter Enable* checkbox.

If the include button is checked, all the addresses within the filter range are allowed access; all other addresses are denied access.

If the exclude button is checked, all the addresses within the filter range are denied access; all other addresses are allowed access.

Adding Filters

To add an IP filter, do the following:

1. Click Add. A dialog box similar to the one below appears:

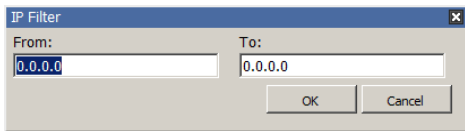

2. Key the address you want to filter in the From: field. To filter a single IP address, key the same address in the To: field. To filter a continuous range of addresses, key in the end number of the range in the To: field.
3. After filling in the address, click OK.
4. Repeat these steps for any additional IP addresses you want to filter.

To add a MAC filter, do the following:

1. Click Add. A dialog box similar to the one below appears:

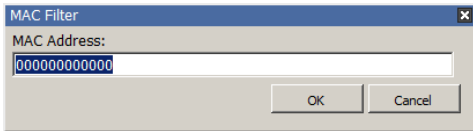

2. Specify the MAC address in the dialog box, then click OK.
3. Repeat these steps for any additional MAC addresses you want to filter.

IP Filter / MAC Filter Conflict

If there is a conflict between an IP filter and a MAC filter – for example, where a computer's IP address is allowed by the IP filter but its MAC address is excluded by the MAC filter – then that computer's access is blocked. In other words, if either filter blocks a computer, then the computer is blocked, no matter what the other filter is set to.

Modifying Filters

To modify a filter, select it in the IP Filter or MAC Filter list box and click **Modify**. The **Modify** dialog box is similar to the **Add** dialog box. When it comes up, simply delete the old address(es) and replace it with the new one(s).

Deleting Filters

To delete a filter, select it in the IP Filter or MAC Filter list box and click **Delete**.

Login String

The *Login String* lets the Administrator specify a login string that users must include (in addition to the IP address) when they access the SV1108IPEXT/POW with a browser.

For example:

192.168.0.60/SV1108IPEXT

The following characters are allowed:

0–9 a–z A–Z ~ ! @ \$ ^ & * () _ + ' - = [] { } ; ' < > , . |

The following characters are not allowed:

% " : / ? # \ [Space] Compound characters (É Ç ñ ... etc.)

NOTE:

1. There must be a forward slash between the IP address and the string.
2. If no login string is specified here, anyone will be able to access the SV1108IPEXT/POW login page using the IP address alone. This makes your installation less secure.

For security purposes, we recommend that you change this string occasionally.

Account Policy

In the Account Policy section, system administrators can set policies governing usernames and passwords.

Account Policy

Minimum Username Length:

Minimum Password Length:

Password must contain at least:

- One upper case letter
- One lower case letter
- One number

Disable Duplicate Login

The meanings of the Account Policy entries are explained in the table below:

Entry	Explanation
Minimum Username Length	Sets the minimum number of characters required for a username. Acceptable values are from 1–16. The default is 6.
Minimum Password Length	Sets the minimum number of characters required for a password. Acceptable values are from 0–16. A setting of 0 means that no password is required. Users can login with only a Username. The default is 6.
Password Must Contain At Least	Checking any of these items requires users to include at least one uppercase letter, one lowercase letter or one number in their password. NOTE: This policy does not affect existing user accounts. Only new user accounts created after this policy has been enabled, and users required to change their passwords are affected.

Entry	Explanation
Disable Duplicate Login	Check this to prevent users from logging in with the same account at the same time.

Login Failures

For increased security, the Login Failures section allows administrators to set policies governing what happens when a user fails to log in successfully.

To set the Login Failures policies, check the *Enable* checkbox (the default is for Login Failures to be enabled). The meanings of the entries are explained in the table below:

Entry	Explanation
Allowed	Sets the number of consecutive failed login attempts that are permitted from a remote computer. The default is 5 times.
Timeout	Sets the amount of time a remote computer must wait before attempting to login again after it has exceeded the number of allowed failures. The default is 3 minutes.
Lock Client PC	<p>If this is enabled, after the allowed number of failures have been exceeded, the computer attempting to log in is automatically locked out. No logins from that computer will be accepted. The default is enabled.</p> <p>NOTE: This function relates to the client computer's IP. If the IP is changed, the computer will no longer be locked out.</p>

Entry	Explanation
<p style="text-align: center;">Lock Account</p>	<p>If this is enabled, after the allowed number of failures have been exceeded, the user attempting to log in is automatically locked out. No logins from the username and password that have failed will be accepted. The default is enabled.</p>

NOTE: If you don't enable Login Failures, users can attempt to log in an unlimited number of times with no restrictions. For security purposes, we recommend that you enable this function and enable the lockout policies.

Encryption

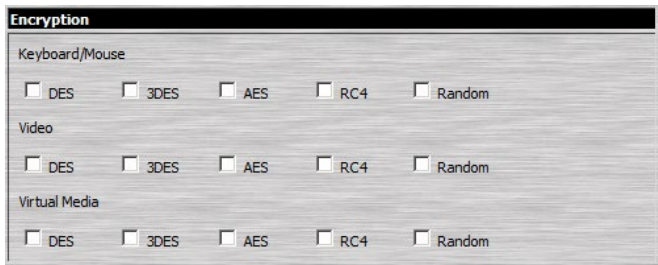

These flexible encryption alternatives for keyboard/mouse, video, and virtual media data let you choose any combination of DES; 3DES; AES; RC4; or a Random cycle of any or all of them.

Enabling encryption will affect system performance – no encryption offers the best performance; the greater the encryption the greater the adverse effect. If you enable encryption, the performance considerations (going from best to worst) are as follows:

RC4 offers the least performance impact; DES is next; then 3DES or AES. The RC4 + DES combination offers the least impact of any combination.

Virtual Media

The SV1108IPEXT/POW's *Virtual Media* feature allows a drive, folder, image file, removable disk, or smart card reader on a user's system to appear and act as if it were installed on the remote server.

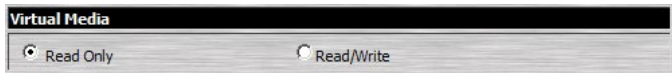

Read Only refers to the redirected device being able to send data to the remote server, but not to have data from the remote server written to it. If *Read Only* is selected, even users with *Read/Write* permissions will only be able to read – they will not be able to write.

Read/Write refers to the redirected device being able to send data to the remote server, as well as being able to have data from the remote server written to it.

The default is for *Read Only*. If you want the redirected device to be writable as well as readable, click to put a check in the *Enable Write* checkbox.

NOTE:

1. This policy operates on the device level. If *Read Only* is selected, the device will only be able to be read – regardless of a user's *Read/Write* user account permissions.
2. If *Read/Write* is selected, the ability of a user to write depends on the user's *Read/Write* user account permissions.

Private Certificate

When logging in over a secure (SSL) connection, a signed certificate is used to verify that the user is logging in to the intended site. For enhanced security, the *Private Certificate* section allows you to use your own private encryption key and signed certificate, rather than the default ATEN certificate.



There are two methods for establishing your private certificate: generating a self-signed certificate; and importing a third-party certificate authority (CA) signed certificate.

Generating a Self-Signed Certificate

If you wish to create your own self-signed certificate, a free utility – openssl.exe – is available for download over the web. See Self-Signed Private Certificates, page 164 for details about using OpenSSL to generate your own private key and SSL certificate.

Obtaining a CA Signed SSL Server Certificate

For the greatest security, we recommend using a third party certificate authority (CA) signed certificate. To obtain a third party signed certificate, go to a CA (Certificate Authority) website to apply for an SSL certificate. After the CA sends you the certificate, save it to a convenient location on your computer.

Importing the Private Certificate

To import the private certificate, do the following:

1. Click **Browse** to the right of *Private Key*; browse to where your private encryption key file is located; and select it.
2. Click **Browse** to the right of *Certificate*; browse to where your certificate file is located; and select it.
3. Click **Upload** to complete the procedure.

NOTE: Both the private encryption key and the signed certificate must be imported at the same time.

Others



Browser Service allows the administrator to limit the scope of browser access to the SV1108IPEXT/POW. Put a check in the checkbox to enable this function, then select the browser limitation in the drop down list box. Choices are explained in the following table:

Item	Explanation
Disable Browser	If this is selected, the SV1108IPEXT/POW cannot be accessed via a browser. It can only be accessed from the AP programs
Disable HTTP	If this is selected, the SV1108IPEXT/POW can be accessed via a browser, but not from an ordinary (HTTP) login connection – it can only be accessed over a secure HTTPS (SSL) connection.
Disable HTTPS (SSL)	If this is selected, the SV1108IPEXT/POW can be accessed via a browser over an ordinary (HTTP) login connection, but not via a secure HTTPS (SSL) connection.

If *Disable Authentication* is checked, no authentication procedures are used to check users attempting to log in. Users gain **Administrator** access to the SV1108IPEXT/POW simply by entering the correct IP address in their browser.

NOTE: Enabling this setting creates an extremely dangerous result as far as security goes, and should only be used under very special circumstances.

User Management

The User Management page is used to create and manage user profiles. Up to 64 user profiles can be established.

The screenshot shows a web-based user management interface. It features a list of users on the left and a detailed form on the right for editing or adding a user. The form includes fields for username, password, and description, as well as radio buttons for user roles and checkboxes for various permissions. There are also dropdown menus for enabling Telnet/SSH and Virtual Media. Action buttons like 'Add', 'Update', 'Remove', and 'Apply' are located at the bottom.

To add a user profile, fill in the information asked for in the right panel, then click **Add**. The new user's name appears in the left panel.

To delete a user profile, select it from the names displayed in the left panel, and click **Remove**. The user's name is removed from the panel.

To modify a user profile, first select it from the list in the left panel; change the information that appears in the right panel; then click **Update**.

NOTE: The user's password is not displayed – the *Password* and *Confirm password* fields are filled with round bullets. If you do not want to change the user's password, simply leave the two fields as is. If you do want to change the user's password, key the new password in the *Password* and *Confirm password* fields.

The *Admin* and *User* radio buttons select automatically configured permissions. If you wish to modify these permissions, choose the *Select* radio button, then specify the permissions individually.

An explanation of the profile items is given in the table below:

Item	Explanation
Username	From 1 to16 characters are allowed depending on the Account Policy settings.
Password	From 0 to16 characters are allowed depending on the Account Policy settings.
Confirm Password	To be sure there is no mistake in the password you are asked to enter it again. The two entries must match.
Description	Additional information about the user that you may wish to include.
Admin	Gives the user Administrator level access to the SV1108IPEXT/POW. All permissions (except View Only) are granted.
User	Gives the user User level access to the SV1108IPEXT/POW. Windows Client, Power Manager, and Java Client permissions are granted.
Select	Select is the default account type. It allows the administrator to select which permissions the user will be allowed.

Item	Explanation
<p data-bbox="211 588 350 612">Permissions</p>	<p data-bbox="560 107 946 215">Click to place/remove a check mark next to an item to grant/withhold access to that aspect of the SV1108IPEXT/POW's operation.</p> <p data-bbox="536 230 964 310">Win Client: Checking Win Client allows a user to access the SV1108IPEXT/POW via the Windows Client software.</p> <p data-bbox="531 324 969 404">Java Client: Checking Java Client allows a user to access the SV1108IPEXT/POW via the Java Client software.</p> <p data-bbox="539 419 961 612">View Only: Checking View Only allows a user to view the video of the display of the computers attached to the ports of the KVM switch connected to the SV1108IPEXT/POW, but they are not allowed to perform any operations on the computers.</p> <p data-bbox="531 627 967 765">Configure: Checking Configure gives a user Administrator privileges, and allows the user to set up and modify the SV1108IPEXT/POW's operating environment.</p> <p data-bbox="536 780 964 1027">Power Management: Checking Power Management allows a user to use the SV1108IPEXT/POW's built-in single port power switch for remote power management of a server/installation connected locally to the SV1108IPEXT/POW, as well as Power On / Power Off / Reset devices via an attached Power Over the NET™ unit.</p> <p data-bbox="531 1042 967 1093">Log: Checking Log allows a user to view the contents of the log file.</p>

Item	Explanation
<p>Permissions (Continued)</p>	<p>Enable Telnet/SSH: If Serial Console management is enabled, checking Enable Telnet/SSH allows a user to open a Telnet and/or SSH session. Drop down the list to select the type of login allowed.</p> <p>Enable Virtual Media: Checking Enable Virtual Media allows a user to utilize the SV1108IPEXT/POW's Virtual Media capabilities. Drop down the list to select whether the user has Read/Write, or Read Only permission.</p>

The **Reset** button clears all the information shown in the right panel. When you have made all your changes, click **Apply**.

Console Management

The Console Management page consists of two sub-pages – Serial Console and OOB – that are used to set up the operating parameters for the SV1108IPEXT/POW's RS-232 (serial) port. An explanation of the parameters and how to set them are given in the sections that follow.

NOTE: Only one of these functions can be active at a time. Selecting one automatically disables the other.

Serial Console

When the Console Management radio button (at the top of the page), is selected, the screen looks similar to the one in the screenshot below:

Serial Port Setting

Serial Console OOB

Enable

Port Property Settings:

Baud Rate:

Data Bits:

Parity:

Stop Bits:

Flow Control:

Enable Toggle DTR:

Online Detect:

Out CRLF Translation:

Suspend Character:

Port Alert Settings

Alert String 1:

Alert String 2:

Alert String 3:

Alert String 4:

Alert String 5:

Alert String 6:

Alert String 7:

Alert String 8:

Alert String 9:

Alert String 10:

To set up the serial communications parameters, put a check in the Enable checkbox, and make your parameter selections according to the information provided in the table below.

Port Property Settings

The meanings of the property settings are given in the following table:

Setting	Meaning
Baud Rate	This sets the port's data transfer speed. Choices are from 300— 115200 (drop down the list to see them all). Set this to match the baud rate setting of the connected device. Default is 9600 (which is a basic setting for many serial devices).
Data Bits	This sets the number of bits used to transmit one character of data. Choices are: 5, 6, 7 and 8. Set this to match the data bit setting of the connected device. Default is 8 (which is the default for the majority of serial devices).
Parity	This bit checks the integrity of the transmitted data. Choices are: None; Odd; Even; Mark; Space. Set this to match the parity setting of the connected device. Default is None (which is the default for the majority of serial devices).
Stop Bits	This indicates that a character has been transmitted. Set this to match the stop bit setting of the connected device. Choices are: 1 and 2. Default is 1 (which is the default for the majority of serial devices).
Flow Control	This allows you to choose how the data flow will be controlled. Choices are: None, Hardware (RTS/CTS), and XON/XOFF. Set this to match the flow control setting of the connected device. Default is None.

Setting	Meaning
<p>Enable Toggle DTR</p>	<p>Enabling this parameter allows the DTR signal to toggle between disabled and enabled when the port is occupied. Choices are: No and Yes. Default is No.</p> <p>NOTE: For some devices, in order for Enabled to work correctly, you must first disable DTR (select No, then click Update), then Enable it (select Yes, then click Update).</p>
<p>Online Detect</p>	<p>This allows you to set the DSR signal to detect online status or not. Choices are: None and DSR. Default is DSR.</p>
<p>Out CRLF Translation</p>	<p>This allows you to select whether to send a Carriage Return and Line Feed signal (CRLF), or only a Carriage Return signal (CR).</p> <p>Choices are: None (which sends CRLF) and CRLF → CR (which only sends CR), Default is None.</p> <p>NOTE: If your device outputs double spaced lines, it means that a line feed is automatically added to a carriage return signal. In that case, choose CRLF → CR.</p>
<p>Suspend Character</p>	<p>The Suspend character is used to bring up the Suspend Menu in Telnet sessions</p> <p>NOTE: Valid characters are from A–Z, except H, I, J, and M. Those four characters may not be used.</p>

Port Alert Settings

The Port Alert Settings dialog box provides a way for you to be informed about events that occur on the devices connected to the SV1108IPEXT/POW's ports.

You can specify up to 10 types of events (e.g., Power On) in the *Alert String* fields. When a specified alert occurs during the serial console session, the SV1108IPEXT/POW writes the event information to the log file.

OOBC

In case the SV1108IPEXT/POW cannot be accessed with the usual LAN-based methods, it can be accessed with an external modem via the switch's RS-232 port. To enable support for PPP (modem) operation, click to put a checkmark in the Enable Out of Band Access checkbox.

NOTE:

1. Enabling out of band access automatically enables Dial In operation. See PPP Modem Operation, page 158, for set up and operation details.
2. For the modem session, the SV1108IPEXT/POW has an IP address of 192.168.0.60; the user side has an IP address of 192.168.192.101.

When you enable out of band access, the *Enable Dial Back*, and *Enable Dial Out* functions become available, as described in the sections that follow.

Enable Dial Back

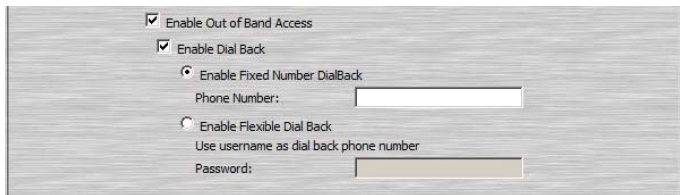

The screenshot shows a configuration dialog box with the following options and fields:

- Enable Out of Band Access
- Enable Dial Back
 - Enable Fixed Number DialBack
 - Phone Number:
 - Enable Flexible Dial Back
 - Use username as dial back phone number
 - Password:

As an added security feature, if this function is enabled, the switch disconnects the connections that dial in to it, and dials back to one of the entries described in the table below:

Item	Action
Enable Fixed Number Dial Back	<p>If Fixed Number Dial Back is enabled, when there is an incoming call, the SV1108IPEXT/POW hangs up the modem and dials back to the modem whose phone number is specified in the Phone Number field.</p> <p>Key the phone number of the modem that you want the SV1108IPEXT/POW to dial back to in the Phone Number field.</p>
Enable Flexible Dial Back	<p>If Flexible Dial Back is enabled, the modem that the SV1108IPEXT/POW dials back to doesn't have to be fixed. It can dial back to any modem that is convenient for the user, as follows:</p> <ol style="list-style-type: none">1. Key the password that the users must specify in the Pass-word field.2. When connecting to the SV1108IPEXT/POW's modem, users specify the phone number of the modem that they want the SV1108IPEXT/POW to dial back to as their Username, and specify the password set in the Password field for their password.

Enable Dial Out

Enable Dial Out

ISP Settings

Phone Number:

Account Name:

Password:

Dial Out Schedule

Every:

Daily at:

PPP online time: minute(s)

Emergency dial out

PPP stays online until network recovery

PPP online time: minute(s)

Dial Out Mail Configuration

SMTP Server IP Address:

Email From:

To:

SMTP server requires authentication

Account Name:

Password:

For the dial out function, you must establish an account with an Internet Service Provider, and then use a modem to dial up to your ISP account. An explanation of the items in the Enable Dial Back section is given in the table below:

Item	Action
ISP Settings	Specify the telephone number, account name (username), and password that you use to connect to your ISP.

Item	Action
<p>Dial Out Schedule</p>	<p>This entry sets up the times you want the SV1108IPEXT/POW to dial out over the ISP connection.</p> <p>Every provides a listing of fixed times from every hour to every four hours.</p> <p>If you select Every two hours (for example), the SV1108IPEXT/POW will start dialing out every two hours beginning at the next complete hour (if it is now 13:10, it will start dialling at 14:00).</p> <p>If you don't want the SV1108IPEXT/POW to dial out on a fixed schedule, select Never from the list.</p> <p>Daily at will dial out once a day at a specified time. Use the hh:mm format to specify the time.</p> <p>PPP online time specifies how long you want the ISP connection to last before terminating the session and hanging up the modem. A setting of zero means it is always on line.</p>
<p>Emergency Dial Out</p>	<p>If the SV1108IPEXT/POW gets disconnected from the network, or the network goes down, this function puts the SV1108IPEXT/POW on line via the ISP dial up connection.</p> <p>If you choose PPP stays online until network recovery, the PPP connection to the ISP will last until the network comes back up or the SV1108IPEXT/POW reconnects to it.</p> <p>If you choose PPP online time the connection to the ISP will terminate after the amount of time that you specify is up. A setting of zero means it is always on line.</p>

Item	Action
<p>Dial Out Mail Configuration</p>	<p>This section provides email notification of problems that occur on the devices connected to the SV1108IPEXT/POW's ports.</p> <p>Key in the IP address or domain name of your SMTP server in the SMTP Server IP Address field.</p> <p>Key in the email address of the person responsible for the SMTP server (or some other equally responsible administrator), in the Email From field.</p> <p>Key in the email address (addresses) of where you want the report sent to in the To field. If you are sending the report to more than one email address, separate the addresses with a comma or a semicolon.</p> <p>If your server requires authentication, put a check in the My server requires authentication checkbox, then key in the appropriate account name and password in the fields, below.</p>

When you have finished making your settings on this page, click **Apply**.

Sessions

The *Session* page lets the administrator see at a glance all the users currently logged into the SV1108IPEXT/POW, and provides information about each of their sessions.

Active Sessions						
Select	Login Name	Client IP	Login Time	Service	Category	Idle Time
<input type="checkbox"/>	trevor	172.17.17.1	21:30:20	Browser	Select	444
<input type="checkbox"/>	jonman	172.17.17.1	21:32:07	Browser	Select	360
<input type="checkbox"/>	rjf111	172.17.17.1	21:32:36	Browser	Admin	250
<input checked="" type="checkbox"/>	administrator	172.17.17.1	21:36:18	Browser	Select	0
<input type="checkbox"/>	kelly-l	172.17.17.1	21:37:49	Browser	Select	17

The meanings of the headings at the top of the page are fairly straight forward.

The Client IP heading refers to the IP address that the user has logged in from.

The Service heading refers to the means the user employed to connect to the SV1108IPEXT/POW (Browser, WinClient AP, JavaClient AP, etc.).

The Category heading lists the type of user who has logged in: Admin (Administrator), User, or Select.

This page also gives the administrator the option of forcing a user logout by selecting the user and clicking End Session.

Customization

The *Customization* page allows the Administrator to set *Timeout*, *Login failure*, and *Working mode* parameters.

The screenshot shows a configuration interface with several sections:

- Client Timeout Control:** Timeout: 3 minutes
- Working Mode:**
 - Enable ICMP
 - Enable Device List
 - Enable Multiuser
 - Force All to Grayscale
- USB IO Settings:**
 - OS: Win
 - Language: English
- Multuser Mode:** Multuser Mode: Share
- Reset:** Reset on exit

An explanation of the Customization parameters is given in the table below:

Parameter	Explanation	
Timeout	If there is no user input for the amount of time specified here, the user is automatically logged out, and must log in again before the SV1108IPEXT/POW can be accessed. The default is 3 minutes.	
Working Mode	Enable ICMP	If ICMP is enabled, the SV1108IPEXT/POW can be pinged. If it is not enabled, the device cannot be pinged. The default is Enabled.
	Enable Device List	If this item is enabled, the device will show up in the list of local SV1108IPEXT/POW units on the AP Client Connection screen. If it is not enabled, it will not show up. The default is Enabled,
	Enable Multiuser	Enabling Multiuser operation permits more than one user to log into the SV1108IPEXT/POW at the same time. The default is Enabled,
	Force All to Grayscale	If Force All to Grayscale is enabled, the remote display for all users is changed to grayscale. This can speed up I/O transfer in low bandwidth situations. The default is Disabled.

Parameter	Explanation
USB IO Settings	OS Specifies the operating system that the server on the connected port is using. Choices are Win, Mac, Sun, and Other. The default is Win.
	Language Specifies the OS language being used by the server on the connected port. Drop down the list to see the available choices. The default is English US.
Multuser Mode	<p>Defines how a port is to be accessed when multiple users have logged on, as follows:</p> <p>Exclusive: The first user to switch to the port has exclusive control over the port. No other users can view the port.</p> <p>Occupy: The first user to switch to the port has control over the port. However, additional users may view the port's video display.</p> <p>Share: Users simultaneously share control over the port. Input from the users is placed in a queue and executed chronologically. Under these circumstances, users can take advantage of the Message Board, which allows a user to take control of the keyboard and mouse or keyboard, mouse, and video of a Share port.</p>

Parameter

Explanation

Reset

Some configuration changes only take effect after a SV1108IPEXT/POW reset. These include changes on the Network page; a Log Server port change; enabling/disabling browser access; and upgrading the firmware.

For those changes, a check is automatically put in the *Reset on Exit* box.

To have the changes take effect, log out and then log back in again. A wait of approximately 30 to 60 seconds is necessary before logging in following the reset.

NOTE: If the SV1108IPEXT/POW's performance degrades, reset it by putting a check in the Reset on Exit box, and then log out / log in.

Date/Time

The Date/Time dialog page sets the SV1108IPEXT/POW time parameters:

Time Zone

(GMT+08:00) Taipei

Daylight Savings Time

Date

February < 2011 >

February 2011

Su	Mo	Tu	We	Th	Fr	Sa
		1	2	3	4	5
6	7	8	9	10	11	12
13	14	15	16	17	18	19
20	21	22	23	24	25	26
27	28					

Time

15:01:41

Network Time

Enable auto adjustment

Preferred time server

AU | ntp1.cs.mu.OZ.AU

Preferred custom server IP 0.0.0.0

Alternate time server

AU | ntp1.cs.mu.OZ.AU

Alternate custom server IP 0.0.0.0

Adjust time every 1 days

Set the parameters according to the information below.

Time Zone

To establish the time zone that the SV1108IPEXT/POW is located in, drop down the Time Zone list and choose the city that most closely corresponds to where it is at.

If your country or region employs Daylight Saving Time (Summer Time), check the corresponding checkbox.

Date

Select the month from the dropdown listbox.

Click < or > to move backward or forward by one year increments.

In the calendar, click on the day.

To set the time, key in the numbers using the 24 hour HH:MM:SS format.

Click Set to save your settings.

Network Time

To have the time automatically synchronized to a network time server, do the following:

1. Check the Enable auto adjustment checkbox.
2. Drop down the time server list to select your preferred time server
or
Check the Preferred custom server IP checkbox, and key in the IP address of the time server of your choice.
3. If you want to configure an alternate time server, check the Alternate time server checkbox, and repeat step 2 for the alternate time server entries.
4. Key in your choice for the number of days between synchronization procedures.
5. If you want to synchronize immediately, click Adjust Time Now.

NOTE: After checking the Enable auto adjustment checkbox, you must click **Adjust Time Now** or Set to save the change. Otherwise, the setting will be lost.

Maintenance

The *Maintenance* page allows the Administrator to upgrade the SV1108IPEXT/POW's firmware, and to backup and restore configuration settings / user profile information.

Firmware Upgrade

As new versions of the SV1108IPEXT/POW firmware become available, they can be downloaded from our website. Check the website regularly to find the latest information and packages.

www.StarTech.com/Downloads

To upgrade the firmware, do the following:

1. Download the new firmware file to your computer.
2. Open your browser; log in to the SV1108IPEXT/POW; and click the Firmware icon to bring up the Firmware File dialog box:



3. Click Browse; navigate to the directory that the new firmware file is in and select the file.
4. Click **Upgrade Firmware**.
If *Check Firmware Version* is enabled (the default), when you perform an upgrade the current firmware level is compared with that of the upgrade file. If the current version is higher than the upgrade version, a message appears informing you of the fact and the procedure stops.

NOTE: If you want to install an older firmware version, you must uncheck the *Check Firmware Version* checkbox before clicking **Upgrade Firmware**.

5. After the upload completes, a message appears on the screen to inform you that the operations succeeded. Click **Logout** at the bottom left of the Main web page.
6. In the screen that comes up click **Yes** to confirm that you want to exit and reset the switch.

NOTE: You will need to wait a bit before logging back in.

Backup

The *Backup* section of the page gives you the ability to back up the SV1108IPEXT/POW's configuration and user profile information.

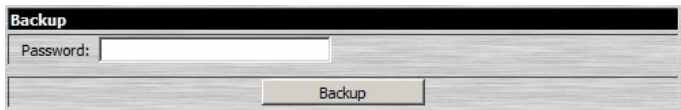

The screenshot shows a web form titled "Backup". It features a "Password:" label followed by a text input field. Below the input field is a "Backup" button.

To perform a backup, do the following:

1. (Optional) In the *Password* field, key in a password for the file.

NOTE: If you set a password, make a note of it, since you will need it to be able to perform restore operations with the file.

2. Click **Backup**.

3. When the browser asks what you want to do with the file, select *Save to disk*; then save it in a convenient location.

NOTE: The SV1108IPEXT/POW saves all its backup files as *SV1108IPEXT/POWBKUP.conf*. If you want to save more than one backup file, simply rename the file to something convenient when you save it.

Restore

Backed up User Account and Configuration information can be restored with the *Restore* section of the page. Information currently configured on the SV1108IPEXT/POW will be replaced with the information that you restore.

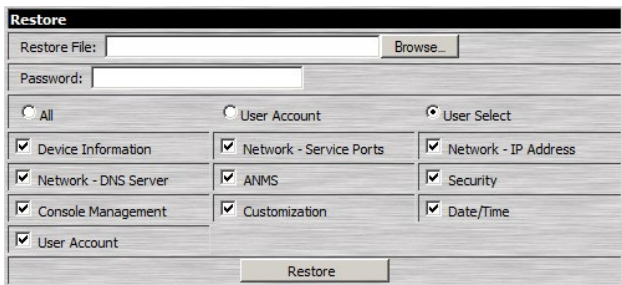

The screenshot shows a web form titled "Restore". It includes a "Restore File:" label with a text input field and a "Browse..." button. Below this is a "Password:" label with a text input field. There are three radio buttons for selection: "All", "User Account", and "User Select". The "User Select" option is selected. Below the radio buttons is a table of checkboxes for various configuration items:

<input checked="" type="checkbox"/> Device Information	<input checked="" type="checkbox"/> Network - Service Ports	<input checked="" type="checkbox"/> Network - IP Address
<input checked="" type="checkbox"/> Network - DNS Server	<input checked="" type="checkbox"/> ANMS	<input checked="" type="checkbox"/> Security
<input checked="" type="checkbox"/> Console Management	<input checked="" type="checkbox"/> Customization	<input checked="" type="checkbox"/> Date/Time
<input checked="" type="checkbox"/> User Account		

At the bottom of the form is a "Restore" button.

To restore a previous backup, do the following:

1. If a password was set when the backup was made, key the same password that you used to save the backup file in the Password field. If a password wasn't set, you can leave this field blank.
2. Click Browse; navigate to the file and select it.
NOTE: If you renamed the file, you can leave the new name. There is no need to return it to its original name.
3. Select which parts of the backup you wish to restore:
Select the *All* radio button to restore both User Account and all Configuration information
Select the *User Account* radio button to only restore User Account information
Select the *User Select* radio button to choose which parts of the backed up information you wish to restore, then click the checkboxes to select/deselect the restore elements.
4. When you have made your selections, click **Restore**.
After the file is restored, a message appears to inform you that the procedure succeeded.

The WinClient Viewer

Starting Up

The WinClient Viewer is only available when you log in using the Microsoft Internet Explorer (IE) browser. After you log in, click the Open Windows Client link on the Remote Console Preview panel.



NOTE: The links that appear below the *Refresh* button depend on the browser you are using, and your User Preferences **Viewer** choice.

A second or two after you click the Open Windows Client link, the remote server's display appears as a window on your desktop:

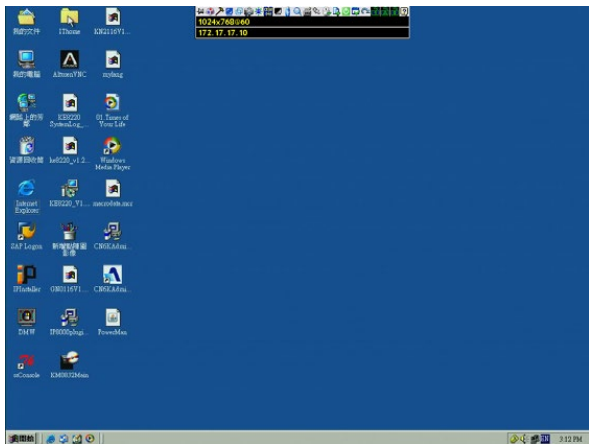

Navigation

You can work on the remote system via the screen display on your monitor just as if it were your local system.

You can maximize the window, drag the borders to resize the window; or use the scrollbars to move around the screen.

You can switch between your local and remote programs with [Alt + Tab].

NOTE:

1. Due to *net lag*, there might be a slight delay before your keystrokes show up. You may also have to wait a bit for the remote mouse to catch up to your local mouse before you click.
2. Due to *net lag*, or insufficient computing power on the local machine, some images, especially motion images, may display poorly.

The WinClient Control Panel

The WinClient control panel is hidden at the upper or lower center of the screen (the default is up). It becomes visible when you move the mouse pointer over it:

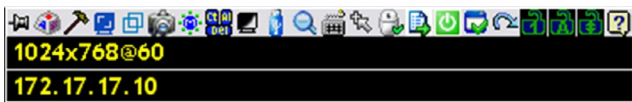

NOTE:

1. The above image shows the complete Control Panel. The icons that appear can be customized.
2. To move the Control Panel to a different location on the screen, place the mouse pointer over the text bar area, then click and drag.

By default, the left of the top text row shows the video resolution of the remote display. As the mouse pointer moves over the icons in the icon bar, however, the information in the top text row changes to describe the icon's function. In addition, if a message from another user is entered in the message board, and you have not opened the message board in your session, the message will appear in the top row.

If the *User Info* function has been enabled under *Control Panel Configuration*, the total number of users currently logged in displays in the center of the upper text row.



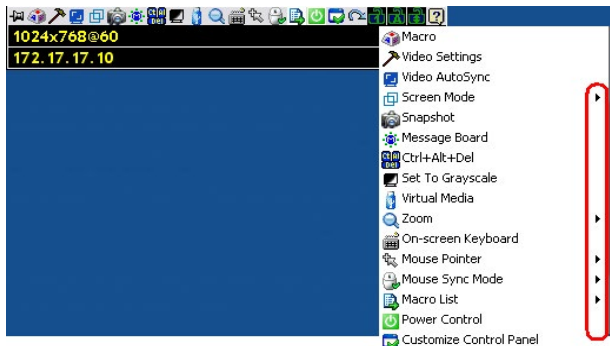



Right clicking in the text row area brings up a menu that allows you to select options for the *Screen Mode*, *Zoom*, *Mouse Pointer* type, *Mouse Sync Mode* and *Macro List*. These functions are discussed in the sections that follow.















Control Panel Functions

The Control Panel functions are described in the table below.

NOTE: Clicking the **T** button at the top right of the dialog boxes that appear for the control panel functions brings up a slider to adjust the transparency of the dialog box. After making your adjustment, click anywhere in the dialog box to dismiss the slider.

Icon	Function
	This is a toggle. Click to make the Control Panel persistent – i.e., it always displays on top of other screen elements. Click again to have it display normally.
	Click to bring up the Macros dialog box
 Video Settings	Click to bring up the Video Options dialog box. Right-click to perform a quick Auto Sync
 Video Autosync	Click to perform a video and mouse autosync operation. It is the same as clicking the Auto-sync button in the Video Options dialog box.
	Toggles the display between Full Screen Mode and Windowed Mode.
	Click to take a snapshot (screen capture) of the remote display.
	Click to bring up the Message Board

Icon	Function
	<p>Click to send a Ctrl+Alt+Del signal to the remote system.</p>
	<p>Click to toggle the remote display between color and grayscale.</p>
	<p>Click to bring up the Virtual Media dialog box. The icon changes when a virtual media device is started on the port.</p> <p>NOTE: This icon displays in gray when the function is disabled or not available to the user.</p>
	<p>Click to zoom the remote display window.</p> <p>NOTE: This feature is only available in windowed mode (Full Screen Mode is off).</p>
	<p>Click to bring up the on-screen keyboard</p>
	<p>Click to select the mouse pointer type.</p> <p>NOTE: This icon changes depending on which mouse pointer type is selected</p>
	<p>Click to toggle Automatic or Manual mouse sync.</p> <p>When the selection is Automatic, a green ✓ appears on the icon.</p> <p>When the selection is Manual, a red X appears on the icon.</p>
	<p>Click to display a dropdown Macro List of User macros. Access and run macros more conveniently rather than using the Macros dialog box Macro List</p>

Icon	Function
	<p>Click to power on/off the server connected to the SV1108IPEXT/POW's built-in power switch inlet/outlet ports.</p>
	<p>Click to bring up the Control Panel Configuration dialog box.</p>
	<p>Click to exit the remote view and go back to the web browser Main Page.</p>
	<p>These icons show the Num Lock, Caps Lock, and Scroll Lock status of the remote computer.</p> <p>When the lock state is On, the LED is bright green and the lock hasp is closed.</p> <p>When the lock state is Off, the LED is dull green and the lock hasp is open.</p> <p>Click on the icon to toggle the status.</p> <p>NOTE: These icons and your local keyboard icons are in sync. Clicking an icon causes the corresponding LED on your keyboard to change accordingly. Likewise, pressing a Lock key on your keyboard causes the icon's color to change accordingly.</p>
	<p>Click to display information about the Windows Client version.</p>

Hotkeys

Various actions, corresponding to clicking the Control Panel icons, can be accomplished directly from the keyboard with hotkeys. Selecting the Hotkeys radio button lets you configure which hotkeys perform the actions. The actions are listed to the left; their hotkeys are shown to the right. Use the checkbox to the left of an action's name to enable or disable its hotkey.

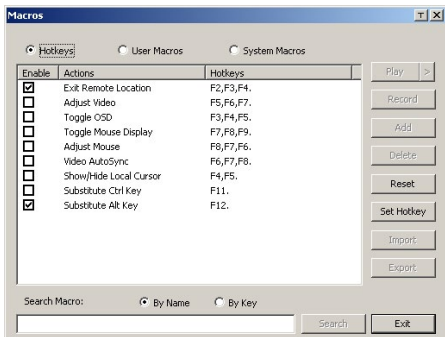

If you find the default Hotkey combinations inconvenient, you can reconfigure them as follows:

1. Highlight an *Action*, then click **Set Hotkey**.
2. Press your selected Function keys (one at a time). The key names appear in the *Hotkeys* field as you press them.

You can use the same function keys for more than one action, as long as the key sequence is not the same.

To cancel setting a hotkey value, click **Cancel**; to clear an action's Hotkeys field, click **Clear**.
3. When you have finished keying in your sequence, click **Save**. To reset all the hotkeys to their default values, click **Reset**.

An explanation of the Hotkey actions is given in the table below:

Action	Explanation
Exit Remote Location	Exits the remote view and goes back to the web browser Main Page. This is equivalent to clicking the Exit icon on the Control Panel. The default keys are F2, F3, F4.
Adjust Video	Brings up the Video Settings dialog box. This is equivalent to clicking the Video Settings icon on the Control Panel. The default keys are F5, F6, F7.
Toggle OSD	Toggles the Control Panel Off and On. The default keys are F3, F4, F5.
Toggle Mouse Display	<p>If you find the display of the two mouse pointers (local and remote) to be confusing or annoying, you can use this function to shrink the non-functioning pointer down to a barely noticeable tiny circle, which can be ignored. Since this function is a toggle, use the hotkeys again to bring the mouse display back to its original configuration. This is equivalent to selecting the Dot pointer type from the Mouse Pointer icon on the Control Panel. The default keys are F7, F8, F9.</p> <p>NOTE: The Java Control Panel does not have this feature.</p>
Adjust Mouse	This synchronizes the local and remote mouse movements. The default keys are F7, F8, F9.
Video Auto-Sync	This combination performs an auto-sync operation. It is equivalent to clicking the Video Autosync icon on the Control Panel. The default keys are F6, F7, F8.

Action	Explanation
<p>Show/Hide Local Cursor</p>	<p>Toggles the display of your local mouse pointer off and on. This is equivalent to selecting the Null pointer type from the Mouse Pointer icon on the Control Panel. The default keys are F4,F5.</p>
<p>Substitute Ctrl Key</p>	<p>If your local computer captures Ctrl key combinations, preventing them from being sent to the remote system, you can implement their effects on the remote system by specifying a function key to substitute for the Ctrl key. If you substitute the F11 key, for example, pressing [F11 + 5] would appear to the remote system as [Ctrl + 5]. The default key is F11.</p>
<p>Substitute Alt Key</p>	<p>Although all other keyboard input is captured and sent to the remote system, [Alt + Tab] and [Ctrl + Alt + Del] work on your local computer. In order to implement their effects on the remote system, another key may be substituted for the Alt key. If you substitute the F12 key, for example, you would use [F12 + Tab] and [Ctrl + F12 + Del]. The default key is F11.</p>

Macros



The Macros icon provides access to three functions found in the Macros dialog box: Hotkeys, User Macros, and System Macros. Each of these functions is described in the following sections.

User Macros

User Macros are used to perform specific actions on the remote server. To create the macro, do the following:

1. Select the *User Macros* radio button, then click **Add**.

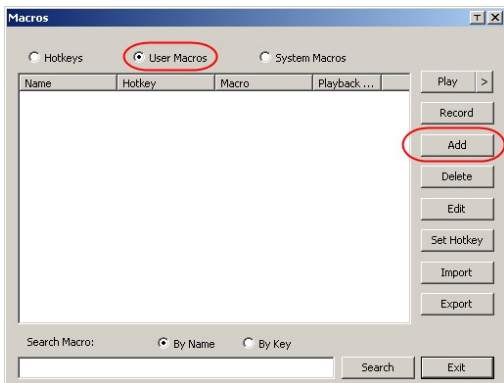

2. In the dialog box that comes up, replace the "New Macro" text with a name of your choice for the macro:

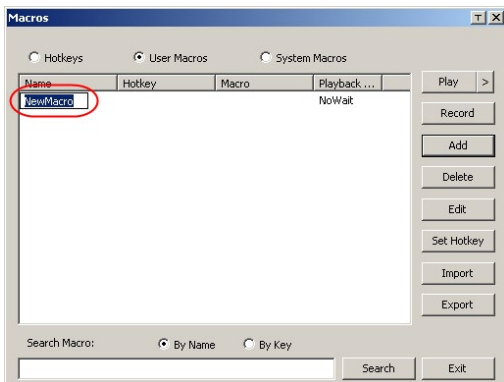

- Click **Record**. The dialog box disappears, and a small panel appears at the top left of the screen:

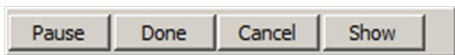

- Press the keys for the macro. To pause macro recording, click **Pause**. To resume, click **Pause** again. Clicking **Show** brings up a dialog box that lists each keystroke that you make, together with the amount of time each one takes:

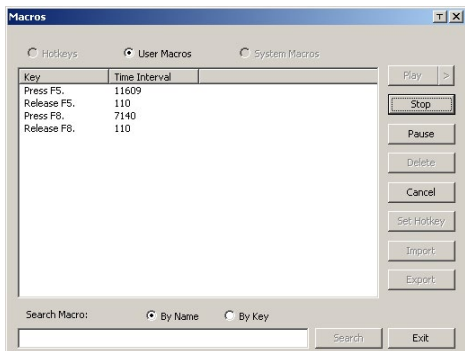

Clicking **Cancel** cancels all keystrokes. When you have finished, click **Stop**. This is the equivalent of clicking *Done* in Step 5.

NOTE:

- Case is not considered – typing **A** or **a** has the same effect.
- When recording the macro the focus must be on the remote screen. It cannot be in the macro dialog box.
- Only the default keyboard characters may be used. Alternate characters cannot be used. For example, if the keyboard is Traditional Chinese and default character is **A** the alternate Chinese character obtained via keyboard switching is not recorded.

5. If you haven't brought up the Show dialog, click **Done** when you have finished recording your macro. You return to the Macros dialog box with your system macro key presses displayed in the Macro column:

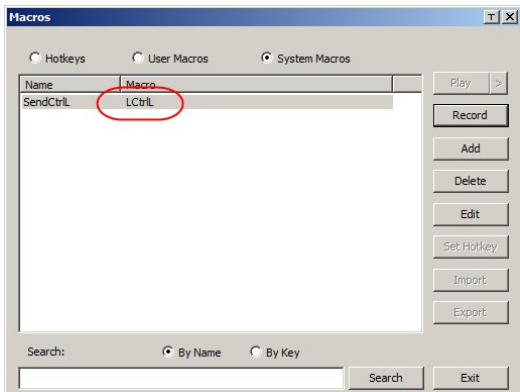

6. If you want to change any of the keystrokes, select the macro and click **Edit**. This brings up a dialog box similar to the one for Show. You can change the content of your keystrokes, change their order, etc.
7. Repeat the procedure for any other macros you wish to create.

After creating your macros, you can run them in any of three ways:

1. By using the hotkey (if one was assigned).
2. By opening the Macro List on the Control Panel and clicking the one you want.
3. By opening this dialog box and clicking Play.

If you run the macro from this dialog box, you have the option of specifying how the macro runs.

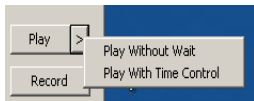

If you choose Play Without Wait, the macro runs the keypresses one after another with no time delay between them.

If you choose Play With Time Control, the macro waits for the amount of time between key presses that you took when you created it. Click on the arrow next to Play to make your choice.

If you click Play without opening the list, the macro runs with the default choice. The default choice (NoWait or TimeCtrl), is shown in the Playback column.

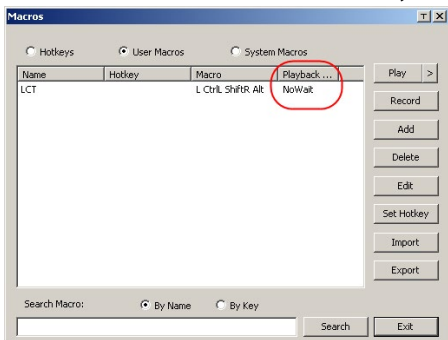

You can change the default choice by clicking on the current choice (NoWait in the screenshot above), and selecting the alternative choice.

NOTE:

1. Information about the Search function is given on page 87.
2. User Macros are stored on the Local Client computer of each user. Therefore there is no limitation on the number of macros, the size of the macro names, or makeup of the hotkey combinations that invoke them

Search

Search, at the bottom of the dialog box, lets you filter the list of macros that appear in the large upper panel for you to play or edit. Click a radio button to choose whether you want to search by name or by key; key in a string for the search; then click **Search**. All instances that match your search string appear in the upper panel.

System Macros

System Macros are used to create exit macros for when you close a session. For example, as an added measure of security, you could create a macro that sends the Winkey-L combination which would cause the remote device's log in page to come up the next time the device was accessed. To create the macro, do the following:

1. Select *System Macros*, then click **Add**.

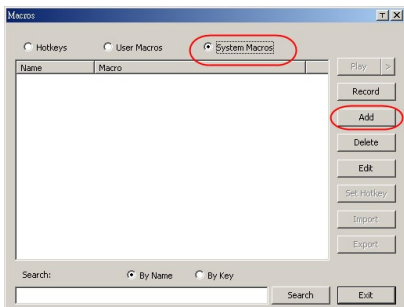

2. In the dialog box that comes up, replace the "New Macro" text with a name of your choice for the macro:

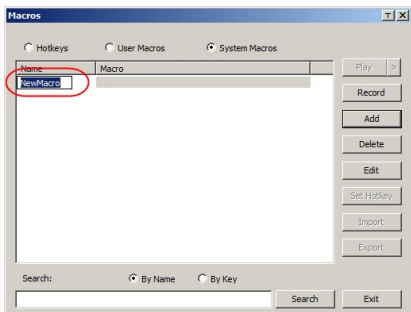

- Click Record. The dialog box disappears, and a small panel appears at the top left of the screen:

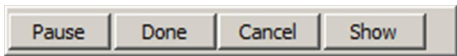

- Press the keys for the macro. To pause macro recording, click **Pause**. To resume, click **Pause** again. Clicking **Show** brings up a dialog box that lists each keystroke that you make, together with the amount of time each one takes.

NOTE:

- Case is not considered – typing **A** or **a** has the same effect.
- When recording the macro the focus must be on the remote screen. It cannot be in the macro dialog box.
- Only the default keyboard characters may be used. Alternate characters cannot be used. For example, if the keyboard is Traditional Chinese and default character is **A** the alternate Chinese character obtained via keyboard switching is not recorded.
- If you haven't brought up the Show dialog, click **Done** when you have finished recording your macro. You return to the Macros dialog box with your system macro key presses displayed in the Macro column:

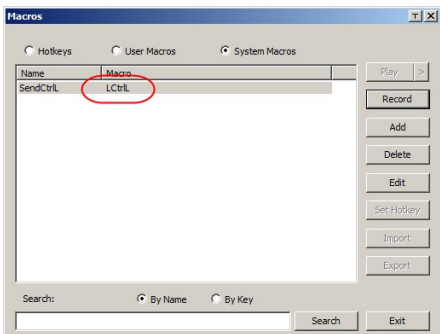

- If you want to change any of the keystrokes, select the macro and click **Edit**. This brings up a dialog box similar to the one for Show. You can change the content of your keystrokes, change their order, etc.

7. Repeat the procedure for any other macros you wish to create. Once the system macros have been created, you can choose to run any one of them upon logging out of the SV1108IPEXT/POW.

NOTE:

1. Information about the Search function is given on page 87.
2. Systems macros are stored on the SV1108IPEXT/POW, therefore macro names may not exceed 64 Bytes (1 Byte = 1 English alphanumeric character), and hotkey combinations may not exceed 256 Bytes (each key usually takes 3–5 Bytes).

Video Settings



The *Video Settings* dialog box allows you to adjust the placement and picture quality of the remote screen display on your monitor.

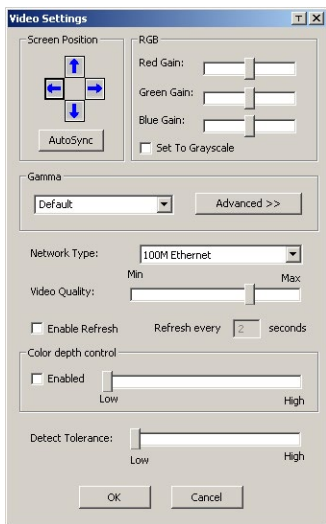

The meanings of the adjustment options are given in the table below:

Option	Usage
Screen Position	Adjust the horizontal and vertical position of the remote computer window by Clicking the Arrow buttons.
Auto-Sync	<p>Click Auto-Sync to have the vertical and horizontal offset values of the remote screen detected and automatically synchronized with the local screen.</p> <p>NOTE:</p> <ol style="list-style-type: none">1. If the local and remote mouse pointers are out of sync, in most cases, performing this function will bring them back into sync.2. This function works best with a bright screen.3. If you are not satisfied with the results, use the Screen Position arrows to position the remote display manually.
RGB	<p>Drag the slider bars to adjust the RGB (Red, Green, Blue) values. When an RGB value is increased, the RGB component of the image is correspondingly increased.</p> <p>If you enable Set to Grayscale, the remote video display is changed to grayscale.</p>
Gamma	This section allows you to adjust the video display's gamma level. This function is discussed in detail in the next section, Gamma Adjustment.

Option	Usage
<p>NetworkType</p>	<p>Select the type of internet connection that exists between the Local Client computer and the SV1108IPEXT/POW, which will be used to automatically adjust the Video Quality and Detect Tolerance settings to optimize the quality of the video display.</p> <p>Since network conditions vary, if none of the pre-set choices seem to work well, you can select Customize and use the Video Quality and Detect Tolerance slider bars to adjust the settings to suit your conditions.</p>
<p>Video Quality</p>	<p>Drag the slider bar to adjust the overall Video Quality. The larger the value, the clearer the picture and the more video data goes through the network. Depending on the network bandwidth, a high value may adversely effect response time.</p>
<p>Enable Refresh</p>	<p>The SV1108IPEXT/POW can redraw the screen every 1 to 99 seconds, eliminating unwanted artifacts from the screen. Select Enable Refresh and enter a number from 1 through 99. The SV1108IPEXT/POW will redraw the screen at the interval you specify. This feature is disabled by default. Click to put a check mark in the box next to Enable Refresh to enable this feature.</p> <p>NOTE:</p> <ol style="list-style-type: none"> 1. The switch starts counting the time interval when mouse movement stops. 2. Enabling this feature increases the volume of video data transmitted over the network. The lower the number specified, the more often the video data is transmitted. Setting too low a value may adversely affect overall operating responsiveness.

Option	Usage
Color Depth Control	This setting determines the richness of the video display by adjusting the amount of color information.
Detect Tolerance	This setting also relates to video quality. It governs detecting or ignoring pixel changes. A high setting can result in a lower quality display due to less data transfer. A lower setting will result in better video quality, but setting the threshold too low may allow too much data to be transferred, negatively impacting network performance.

Gamma Adjustment

If it is necessary to correct the gamma level for the remote video display, use the Gamma function of the Video Adjustment dialog box.

Under Basic configuration, there are ten preset and four user-defined levels to choose from. Drop down the list box and choose the most suitable one.

For greater control, clicking the Advanced button brings up the following dialog box:

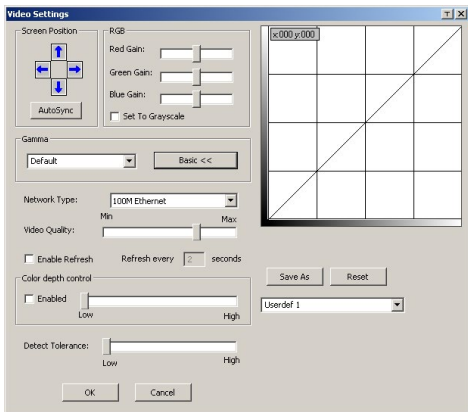

Click and drag the diagonal line at as many points as you wish to achieve the display output you desire.

Click **Save As** to save up to four user-defined configurations derived from this method. Saved configurations can be recalled from the list box at a future time.

Click **Reset** to abandon any changes and return the gamma line to its original diagonal position.

Click **OK** to save your changes and close the dialog box.

Click **Cancel** to abandon your changes and close the dialog box.

NOTE: For best results, change the gamma while viewing a remote computer.

The Message Board



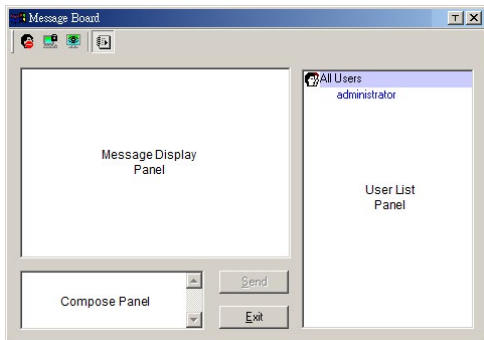

To alleviate the possibility of access conflicts resulting from multiple user logins, the SV1108IPEXT/POW provides a message board that allows users to communicate with each other:



The Button Bar

The buttons on the Button Bar are toggles. Their actions are described in the table below:

Button	Action
	Enable/Disable Chat. When disabled, messages posted to the board are not displayed. The button is shadowed when Chat is disabled. The icon displays next to the user's name in the User List panel when the user has disabled Chat.

Button	Action
	<p>Occupy/Release Keyboard/Video/ Mouse. When a port is set to Occupy mode, you can use this button to occupy the KVM. When you Occupy the KVM, other users cannot see the video, and cannot input keyboard or mouse data. The button is shadowed when the KVM is occupied. The icon displays next to the user's name in the User List panel when the user has occupied the KVM.</p>
	<p>Occupy/Release Keyboard/Mouse. When a port is set to Occupy mode, you can use this button to occupy the KM. When you Occupy the KM, other users can see the video, but cannot input keyboard or mouse data. The button is shadowed when the KM is occupied. The icon displays next to the user's name in the User List panel when the user has occupied the KM.</p>
	<p>Show/Hide User List. When you Hide the User List, the User List panel closes. The button is shadowed when the User List is open.</p>

Message Display Panel

Messages that users post to the board - as well as system messages - display in this panel. If you disable Chat, however, messages that get posted to the board won't appear.

Compose Panel

Key in the messages that you want to post to the board in this panel. Click **Send**, or press **[Enter]** to post the message to the board.

User List Panel

The names of all the logged in users are listed in this panel.

Your name appears in blue; other users' names appear in black. By default, messages are posted to all users. To post a message to one individual user, select the user's name before sending your message.

If a user's name is selected, and you want to post a message to all users, select All Users before sending your message.

If a user has disabled Chat, its icon displays before the user's name to indicate so.

If a user has occupied the KVM or the KM, its icon displays before the user's name to indicate so.

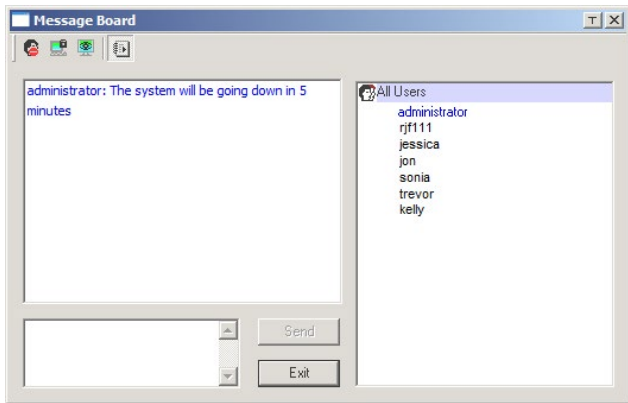

Virtual Media

The *Virtual Media* feature allows a drive, folder, image file, or removable disk on a local client computer to appear and act as if it were installed on the remote server. Virtual Media also supports a smart card reader function that allows a reader plugged into a local client computer to appear as if it were plugged into the remote server.

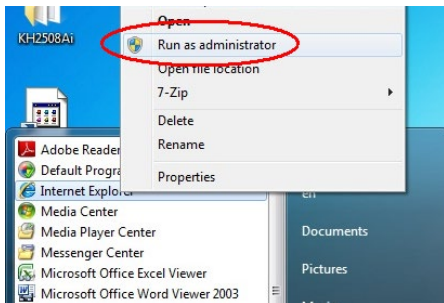

Windows Vista / 7

Windows Vista/7 users who want to use the SV1108IPEXT/POW's Virtual Media feature should be logged into their browser as an administrator. To do so, right click on your browser name and select "Run as administrator", as shown below:



Virtual Media Icons

The Virtual Media icon on the WinClient Control Panel changes, to indicate whether the virtual media function is available, or if a virtual media device has already been mounted on the remote server, as shown in the table below:

Icon	Function
	The icon displays in blue to indicate that the virtual media function is available. Click the icon to bring up the virtual media dialog box.
	The icon displays in blue with a red X to indicate that a virtual media device has been mounted on the remote server. Click the icon to unmount all redirected devices.

Virtual Media Redirection

To implement the virtual media redirection feature, do the following:

1. Click the Virtual Media icon to bring up the *Virtual Media* dialog box:

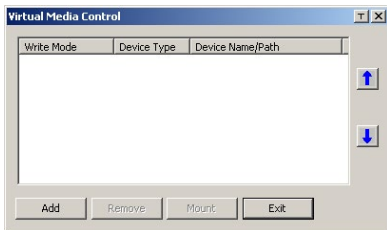

2. Click **Add**; then select the media source.

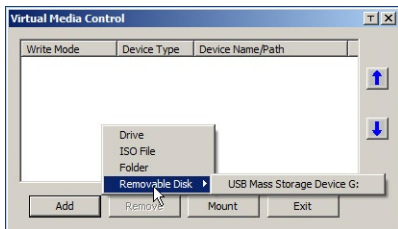

Depending on your selection, additional dialog boxes appear enabling you to select the drive, file, folder, or removable disk you desire.

3. To add additional media sources, click Add, and select the source as many times as you require.

Up to three virtual media choices can be mounted. The top three in the list are the ones that are selected. To rearrange the selection order, highlight the device you want to move, then click the Up or Down Arrow button to promote or demote it in the list.

4. Read refers to the redirected device being able to send data to the remote server; Write refers to the redirected device being able to have data from the remote server written to it. The default is for Write to not be enabled (Read only). If you want the redirected device to be writable as well as readable, click to put a check in the Enable Write checkbox:

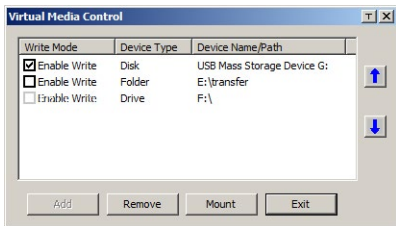

NOTE:

1. If a redirected device cannot be written to, or if a user does not have write permissions, it appears in gray and cannot be selected.
2. See *Virtual Media Support*, page 173, for a list of supported virtual media types.
3. To remove an entry from the list, select it and click **Remove**.
4. After you have made your media source selections, click **Mount**. The dialog box closes. The virtual media devices that you have selected are redirected to the remote system, where they show up as drives, files and folders on the remote system's file system.

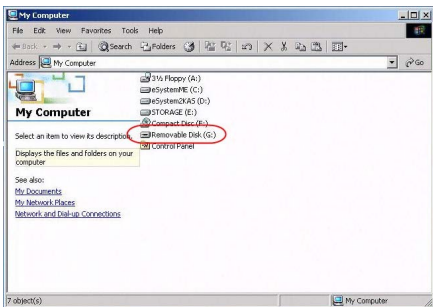

Once mounted, you can treat the virtual media as if they were really on the remote server – drag and drop files to/from them; open files on the remote system for editing and save them to the redirected media, etc. Files that you save to the redirected media, will actually be saved on your local system. Files that you drag from the redirected media will actually come from your local system.

5. To end the redirection, bring up the Control Panel and click on the Virtual Media icon. All mounted devices are automatically unmounted.

Smart Card Reader

The smart card reader function allows a reader plugged into a local client computer's USB port to be redirected, and appear as if it were plugged into the remote server. One purpose of smart cards (Common Access Cards, for example), is to allow authentication to the remote server from the local client.

When a smart card reader is connected to the local client computer, an entry for it appears when you bring up the Virtual Media dialog box and click **Add**:



Make your selection; then click **Mount** to complete the redirection.

NOTE: If you mount a smart card reader, you cannot mount any other virtual media device. If any virtual media devices are already mounted, you must unmount them before you can mount the smart card reader.



Zoom

The Zoom icon controls the zoom factor for the remote view window.

Setting	Description
100%	Sizes and displays the remote view window at 100%.
75%	Sizes and displays the remote view window at 75%.
50%	Sizes and displays the remote view window at 50%.
25%	Sizes and displays the remote view window at 25%.
1:1	Sizes and displays the remote view window at 100%. The difference between this setting and the 100% setting is that when the remote view window is resized its contents don't resize – they remain at the size they were. To see any objects that are outside of the viewing area move the mouse to the window edge, to have the screen scroll.

The On-Screen Keyboard



The SV1108IPEXT/POW supports an on-screen keyboard, available in multiple languages, with all the standard keys for each supported language. Click this icon to pop up the on-screen keyboard:

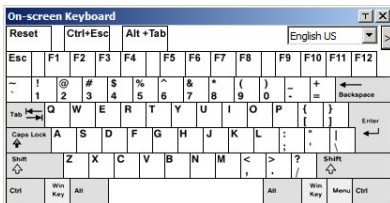

One of the major advantages of the on-screen keyboard is that if the keyboard languages of the remote and local systems aren't the same, you don't have to change the configuration settings for either system. The user just has to bring up the on-screen keyboard; select the language used by the computer on the port he is accessing; and use the on-screen keyboard to communicate with it.

NOTE: You must use your mouse to click on the keys. You cannot use your actual keyboard.

To change languages, do the following:

1. Click the down arrow next to the currently selected language to drop down the language list.

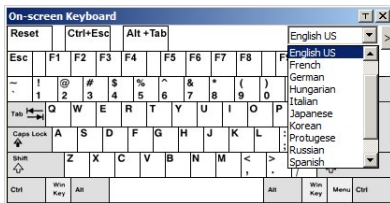

2. Select the new language from the list.

To display/hide the expanded keyboard keys, click the arrow to the right of the language list arrow.

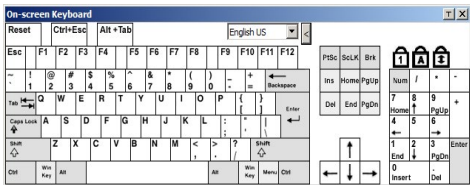

Mouse Pointer Type

The SV1108IPEXT/POW offers a number of mouse pointer options when working in the remote display. Click this icon to select the type that you would like to work with:



NOTE: The icon on the Control Panel changes to match your choice.





Mouse DynaSync Mode

Clicking this icon selects whether synchronization of the local and remote mouse pointers is accomplished either automatically or manually.

Automatic Mouse Synchronization (DynaSync)

Mouse DynaSync provides automatic locked-in syncing of the remote and local mouse pointers – eliminating the need to constantly resync the two movements.

The icon on the toolbar indicates the synchronization mode status as follows:

Icon	Function
	The green check mark on this icon indicates that Mouse DynaSync is available and is enabled. This is the default setting when Mouse DynaSync is available. (See the Note, above.)
	The red X on this icon indicates that Mouse DynaSync is available but is not enabled.

When *Mouse DynaSync* is available, clicking the icon toggles its status between enabled and /disabled. If you choose to disable Mouse DynaSync mode, you must use the manual syncing procedures described in the next section.

Mac and Linux Considerations

For Mac systems, there is a second DynaSync setting to choose from. If the default synchronization result is not satisfactory, you can try the **Mac 2** setting. To select Mac 2, right click in the text area of the Control Panel

and select *Mouse Sync Mode* → *Automatic for Mac 2*:

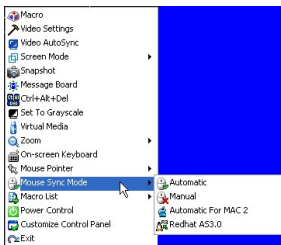

There is also an additional setting for Linux on the Mouse Sync Mode menu. If the default synchronization result is not satisfactory, you can try the Redhat AS3.0 setting.

Manual Mouse Synchronization

If you are using Manual mouse synchronization instead of automatic DynaSync and the local mouse pointer goes out of sync with the remote system's mouse pointer, there are a number of methods to bring them back into sync:

1. Perform a video and mouse auto sync by clicking the *Video Settings* icon on the Control Panel.
2. Perform an *Auto Sync* with the Video Adjustment function.
3. Invoke the *Adjust Mouse* function with the *Adjust Mouse* hotkeys.
4. Move the pointer into all 4 corners of the screen (in any order).
5. Drag the Control Panel to a different position on the screen.
6. Set the mouse speed and acceleration for each problematic computer attached to the switch.

Control Panel Configuration



Clicking the *Control Panel* icon brings up a dialog box that allows you to configure the items that appear on the Control Panel, as well as its graphical settings:

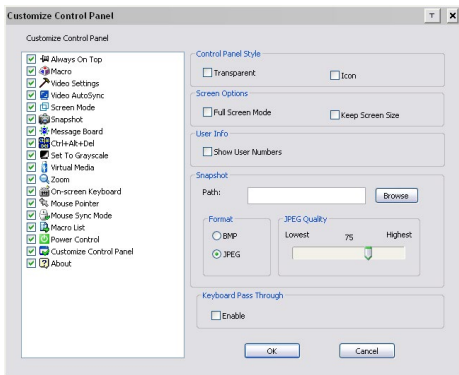

The dialog box is organized into six main sections as described in the table, below:

Item	Description
Customize Control Panel	Allows you to select which icons display in the Control Panel
Control Panel Style	Enabling Transparent makes the Control Panel semi-transparent, so that you can see through it to the display underneath.
	Enabling Icon causes the Control Panel to display as an icon until you mouse over it. When you mouse over the icon, the full panel comes up.
Screen Options	<p>If Full Screen Mode is enabled, the remote display fills the entire screen.</p> <p>If Full Screen Mode is not enabled, the remote display appears as a window on the local desktop. If the remote screen is larger than what is able to fit in the window, scrollbars will appear.</p> <p>If Keep Screen Size is enabled, the remote screen is not resized. If the remote resolution is smaller than that of the local monitor, its display appears like a window centered on the screen.</p> <p>If the remote resolution is larger than that of the local monitor, its display is scaled to the local size.</p> <p>If Keep Screen Size is not enabled, the remote screen is resized to fit the local monitor's resolution.</p>
User Info	<p>If User Info is enabled, the total number of users logged into the SV1108IPEXT/POW displays in the center of the upper text row of the Control Panel</p>

Item	Description
<p data-bbox="225 346 336 372">Snapshot</p>	<p data-bbox="536 107 971 186">These settings let the user configure the SV1108IPEXT/POW's screen capture parameters:</p> <p data-bbox="536 205 971 365">Path lets you select a directory that the captured screens automatically get saved to. Click Browse; navigate to the directory of your choice; then click OK. If you don't specify a directory here, the snapshot is saved to your desktop.</p> <p data-bbox="536 384 971 463">Click a radio button to choose whether you want the captured screen to be saved as a BMP or a JPEG (JPG) file.</p> <p data-bbox="536 481 971 612">If you choose JPEG, you can select the quality of the captured file with the slider bar. The higher the quality, the better looking the image, but the larger the file size.</p>

The JavaClient Viewer

Introduction

The JavaClient Viewer makes the SV1108IPEXT/POW accessible to all platforms that have the Java Runtime Environment (JRE) installed. The JRE is available for free download from the Java web site (<http://java.com>).

To run the JavaClient Viewer, after you log in, Click the *Open Java Applet* link on the *Remote Console Preview* panel.



NOTE: The links that appear below the *Refresh* button depend on the browser you are using, and your User Preferences *Viewer* choice.

A second or two after you click the Open Java Applet (or Open Viewer) link, the remote server's display appears as a window on your desktop:

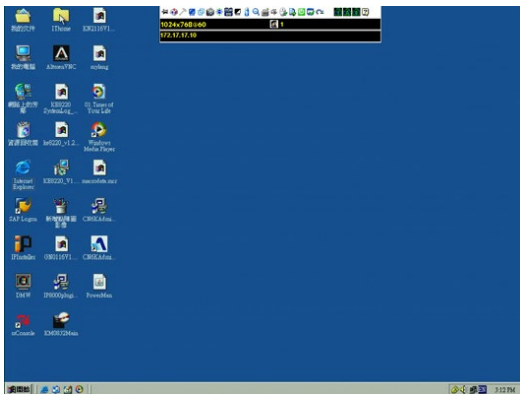

Navigation

You can work on the remote system via the screen display on your monitor just as if it were your local system. You can maximize the window, drag the borders to resize the window; or use the scrollbars to move around the screen.

You can switch between your local and remote programs with [Alt + Tab].

NOTE:

1. Due to *net lag*, there might be a slight delay before your keystrokes show up. You may also have to wait a bit for the remote mouse to catch up to your local mouse before you click.
2. Due to *net lag*, or insufficient computing power on the local machine, some images, especially motion images, may display poorly.

The JavaClient Control Panel

The JavaClient control panel is hidden at the top center of the screen. It becomes visible when you move the mouse pointer into that area:



NOTE:

1. The above image shows the complete Control Panel. The icons that appear can be customized.
2. To place the control panel anywhere on the screen, move the mouse pointer over the text bar area and drag the panel to the new position.

By default, the left of the top text row shows the video resolution of the remote display. As the mouse pointer moves over the icons in the icon bar, however, the information in the top text row changes to describe the icon's function.



If the User Info function has been enabled under Control Panel Configuration, the total number of users currently logged into the SV1108IPEXT/POW displays in the center of the upper text row.

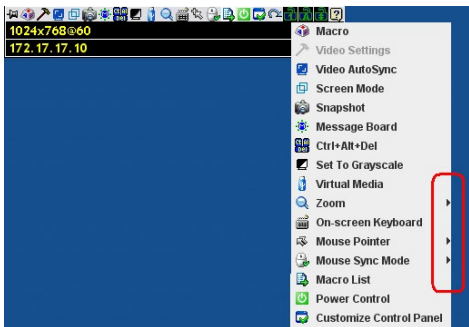





Right clicking in the text row area brings up a menu that allows you to select options for the Zoom, Mouse Pointer type, and Mouse Sync Mode. These functions are discussed in the sections that follow.





Control Panel Functions

The Control Panel functions are described in the table below:

Icon	Function
	This is a toggle. Click to make the Control Panel persistent – i.e., it always displays on top of other screen elements. Click again to have it display normally.
	Click to bring up the Macros dialog box.
	Click to bring up the Video settings dialog box. Right-click to perform a quick Auto Sync.
	Click to perform a video and mouse autosync operation. It is the same as clicking the Auto-sync button in the Video Options dialog box.
	Toggles the display between Full Screen Mode and Windowed Mode.
	Click to take a snapshot (screen capture) of the remote display.
	Click to bring up the Message board.
	Click to send a Ctrl+Alt+Del signal to the remote system.
	Click to toggle the remote display between grayscale and color.

Icon	Function
	<p>Click to bring up the Virtual Media dialog box. The red X indicates that the function has not been started. The icon changes when a virtual media device is started to indicate the type of device being used.</p>
	<p>Click to bring up the on-screen keyboard.</p>
	<p>Click to select the mouse pointer type. NOTE: This icon changes depending on which mouse pointer type is selected.</p>
	<p>Click to toggle Automatic or Manual mouse sync. When the selection is Automatic, a green ✓ appears on the icon. When the selection is Manual, a red X appears on the icon.</p>
	<p>Click to display a dropdown list of User macros. Access and run macros more conveniently rather than using the Macros dialog box.</p>
	<p>Click to power on/off the server connected to the SV1108IPEXT/POW's built-in power switch inlet/outlet ports.</p>
	<p>Click to bring up the Control Panel Configuration dialog box.</p>
	<p>Click to exit the remote view.</p>

Icon	Function
	<p>These icons show the Num Lock, Caps Lock, and Scroll Lock status of the remote computer.</p> <p>When the lock state is On, the LED is bright green and the lock hasp is closed.</p> <p>When the lock state is Off, the LED is dull green and the lock hasp is open. Click on the icon to toggle the status.</p> <p>NOTE: When you first connect, the LED display may not be accurate.</p> <p>To be sure, click on the LEDs to set them.</p>
	<p>Click to display information about the JavaClient Viewer version.</p>

Hotkeys

Various actions related to manipulating the remote server can be accomplished with hotkeys. Selecting the *Hotkeys* radio button lets you configure which hotkeys perform the actions.

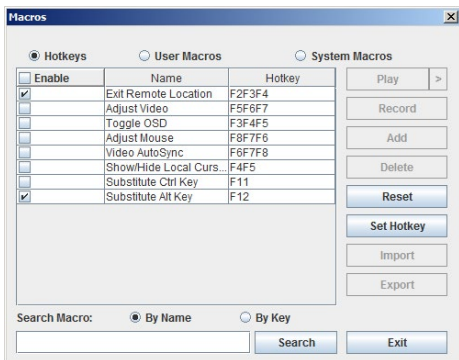

Hotkey operation is the same under the JavaClient as it is under the WinClient.

NOTE: *Toggle Mouse Display* is not available in the JavaViewer version.



Macros

The Macros icon provides access to three functions found in the Macros dialog box: Hotkeys, User Macros, and System Macros. Each of these functions is described in the following sections.

User Macros

User Macros are used to perform specific actions on the remote server. To create the macro, do the following:

1. Select the *User Macros* radio button, then click **Add**.

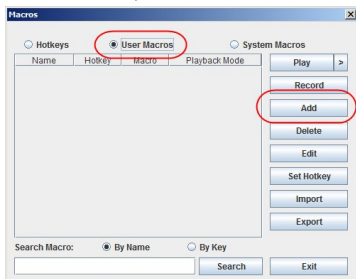

User Macro operation is the same under the JavaClient as it is under the WinClient.

System Macros

System Macros are used to create exit macros for when you close a session. For example, as an added measure of security, you could create a macro that sends the Winkey-L combination which would cause the remote device's log in page to come up the next time the device was accessed. To create the macro, do the following:

1. Select *System Macros*, then click **Add**.

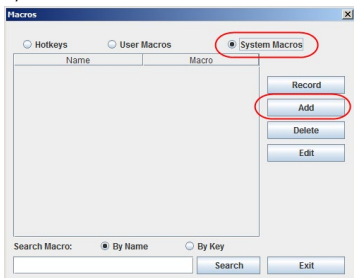

System Macro operation is the same under the JavaClient as it is under the WinClient.

Search

Search allows you to find previously created macros and have them listed in the large upper panel for you to play or edit.

The Search operation is the same under the JavaClient as it is under the WinClient.

Video Settings



The *Video settings* dialog box allows you to adjust the placement and picture quality of the remote screen display on your monitor.

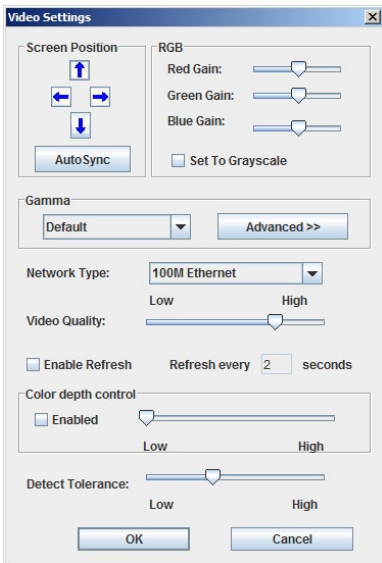

Video Settings operation is the same under the JavaClient as it is under the WinClient.

Message Board



The SV1108IPEXT/POW supports multiple user logins, which can possibly give rise to access conflicts. To alleviate this problem, a message board feature, similar to an internet chat program, allows users to communicate with each other:

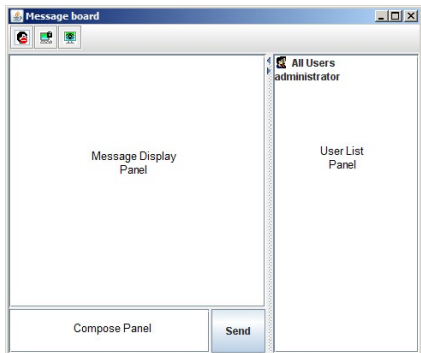

The buttons on the Button Bar are toggles. Their actions are described in the table below:



Enable/Disable Chat. When disabled, messages posted to the board are not displayed. The button is shadowed when Chat is disabled. The icon displays next to the user's name in the User List panel when he has disabled Chat.



Occupy/Release Keyboard/Video/Mouse. When you Occupy the KVM, other users cannot see the video, and cannot input keyboard or mouse data. The button is shadowed when the KVM is occupied.

The icon displays next to the user's name in the User List panel when he has occupied the KVM.



Occupy/Release Keyboard/Mouse.
When you Occupy the KVM, other users can see the video, but cannot input keyboard or mouse data. The button is shadowed when the KVM is occupied. The icon displays next to the user's name in the User List panel when he has occupied the KVM.

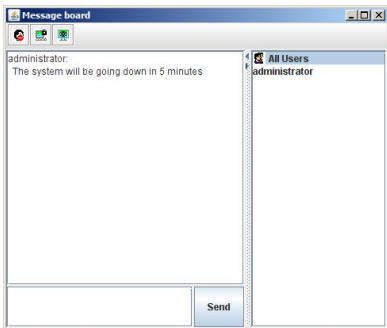

The names of all the logged in users appear in the User List panel. Select the users that you want to post to before sending your message.

Users that aren't selected won't see the message.

To Hide/Unhide the User List panel, click on the arrows in the panel separator.

If a user has disabled Chat, the Disabled Chat icon displays before the user's name to indicate so.

If a user has occupied the KVM or the KM, the corresponding icon displays before the user's name to indicate so.

Key in the messages that you want to post to the board in the Compose panel. Click Send, to post the message to the board.

Messages that users post to the board – as well as system messages – display in the Message Display panel. If you disable Chat, however, messages that get posted to the board do not appear.

If another user sends a message to the message board and your message board is not open, a window showing the message pops up on your screen.

Virtual Media



The *Virtual Media* feature allows a folder or image file on a local client computer to appear and act as if it were installed on the remote server. Virtual Media also supports a smart card reader function that allows a reader plugged into a local client computer to appear as if it were plugged into the remote server.

To implement this redirection feature, do the following:

1. Click the Virtual Media icon to bring up the *Virtual Media* dialog box:

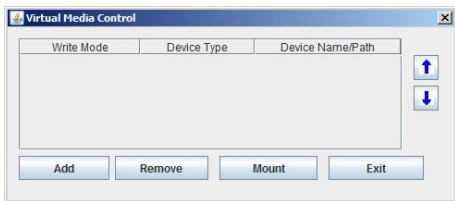

Virtual Media operation is the same under the JavaClient as it is under the WinClient. See *Virtual Media*, page 97, for details.

NOTE: Only the *ISO File* and *Folder* virtual media functions are supported with the Java Viewer.



Zoom

The Zoom icon controls the zoom factor for the remote view window. Settings are as follows:

Setting	Description
100%	Sizes and displays the remote view window at 100%.
75%	Sizes and displays the remote view window at 75%.
50%	Sizes and displays the remote view window at 50%.
25%	Sizes and displays the remote view window at 25%.
1:1	Sizes and displays the remote view window at 100%. The difference between this setting and the 100% setting is that when the remote view window is resized its contents don't resize – they remain at the size they were. To see any objects that are outside of the viewing area move the mouse to the window edge, to have the screen scroll.



The On-Screen Keyboard

The SV1108IPEXT/POW supports an on-screen keyboard, available in multiple languages, with all the standard keys for each supported language.

Click this icon to pop up the on-screen keyboard:

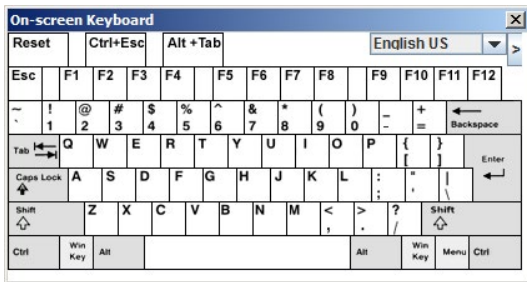

On-Screen Keyboard operation is the same under the JavaClient as it is under the WinClient. See *The On-Screen Keyboard*, page 101, for details.



Mouse Pointer Type

The SV1108IPEXT/POW offers a number of mouse pointer options when working in the remote display. Click this icon to select the type that you would like to work with:

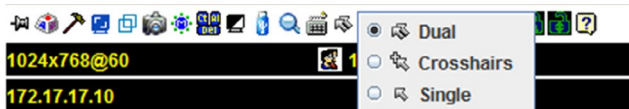

NOTE: The icon on the Control Panel changes to match your choice.



Mouse DynaSync Mode

Clicking this icon selects whether synchronization of the local and remote mouse pointers is accomplished either automatically or manually.

DynaSync operation is the same under the JavaClient as it is under the WinClient. See Mouse DynaSync Mode, page 103, for details.



Control Panel Configuration

Clicking the Control Panel icon brings up a dialog box that allows you to configure the items that appear on the Control Panel, as well as its graphical settings:

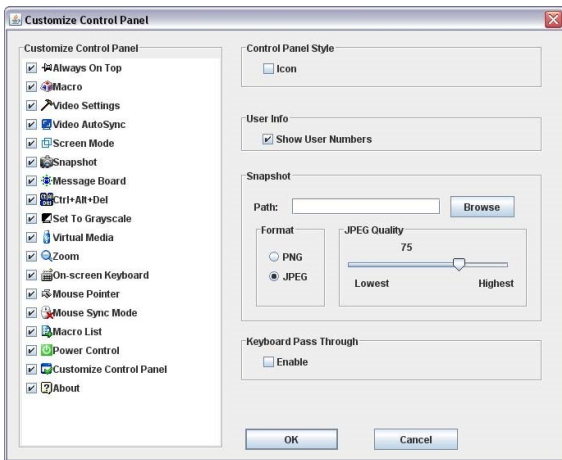

Control Panel Configuration is almost the same under the JavaClient as it is under the WinClient.

NOTE: The following functions found with the WinClient are not available with the JavaClient: the *Transparent* control panel style; and *Screen Options*. In addition, the BMP graphics format (in the Snapshot section), has been replaced by PNG.

The Log File Screen

The SV1108IPEXT/POW logs all the events that take place on it. Following a reset, it writes them to a log file, which is a searchable database. To view the contents of the log file, click the Log icon at the center left of the page. A screen similar to the one below appears:

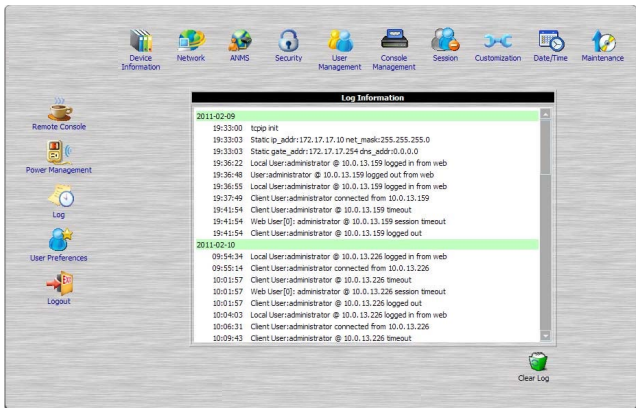

A maximum of 512 events are kept in the log file. As new events are recorded, they are placed at the bottom of the list. When a new event is recorded after there are 512 events in the log file, the earliest event in the list is discarded.

NOTE: To maintain and view a record of all the events that take place (not just the most recent 512), set up the Log Server AP program.

To clear the log file, click on the Clear Log icon at the lower right of the page.

The Log Server

The Log Server is a Windows-based administrative utility that records all the events that take place on selected SV1108IPEXT/POW units and writes them to a searchable database. This chapter describes how to install and configure the Log Server.

Installation

1. With Windows running, put the SV1108IPEXT/POW software CD that came with this product into the CD (DVD) drive.
2. Navigate to the *Log Server AP Installer* folder on the CD.
3. Click the Log Server icon to execute LogServerSetup.exe and start the installation.

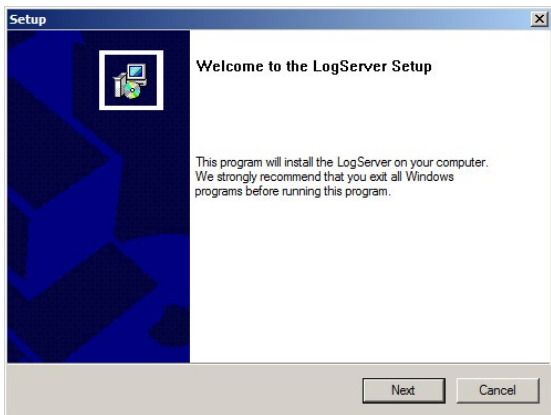

4. Click **Next**. Then follow the on-screen instructions to complete the installation and have the Log Server program icon placed on your desktop.

Starting Up

To bring up the Log Server, either double click the program icon, or key in the full path to the program on the command line. The first time you run it, a screen similar to the one below appears:

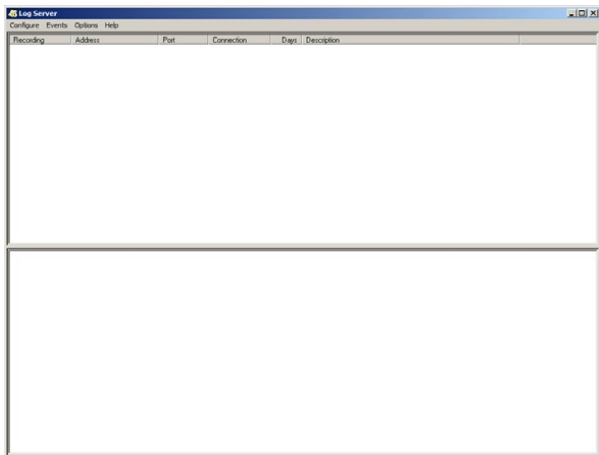

NOTE:

1. The MAC address of the Log Server computer must be specified in the ANMS settings.
2. The Log Server requires the Microsoft Jet OLEDB 4.0 driver.

The screen is divided into three components:

A *Menu Bar* at the top

A panel that will contain a list of SV1108IPEXT/POW units in the middle.

A panel that will contain an Events List at the bottom Each of the components is explained in the sections that follow.

The Menu Bar

The Menu bar consists of four items:

- Configure
- Events
- Options
- Help

These are discussed in the sections that follow.

NOTE: If the Menu Bar appears to be disabled, click in the SV1108IPEXT/POW List window to enable it.

Configure

The Configure menu contains three items: Add, Edit, and Delete. They are used to add new SV1108IPEXT/POW units to the server list, edit the information for units already on the list, or delete units from the list. To add a SV1108IPEXT/POW to the list, click **Add**.

To edit or delete a listed SV1108IPEXT/POW, first select the one you want in the SV1108IPEXT/POW List window, then open this menu and click **Edit** or **Delete**.

When you choose *Add* or *Edit*, a dialog box, similar to the one below appears:

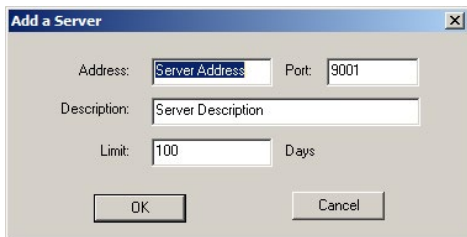

The screenshot shows a dialog box titled "Add a Server" with a close button (X) in the top right corner. The dialog contains the following fields and controls:

- Address:** A text input field containing "Server Address".
- Port:** A text input field containing "9001".
- Description:** A larger text input field containing "Server Description".
- Limit:** A text input field containing "100", followed by the label "Days".
- Buttons:** "OK" and "Cancel" buttons at the bottom.

A description of the fields is given in the table, below:

Field	Explanation
Address	This can either be the IP address of the SV1108IPEXT/POW or its DNS name (if the network administrator has assigned it a DNS name). Key in the value specified for the SV1108IPEXT/POW in the ANMS settings.
Port	Key in the port number that was specified for the Log Server's Service Port in the ANMS settings.
Description	This field is provided so that you can put in a descriptive reference for the unit to help identify it.
Limit	This specifies the number of days that an event should be kept in the Log Server's database before it expires and it is cleared out.

Fill in or modify the fields, then click **OK** to finish.

Events

The Events Menu has two items: *Search* and *Maintenance*.

Search

Search allows you to search for events containing specific words or strings. When you access this function, a screen similar to the one below appears:

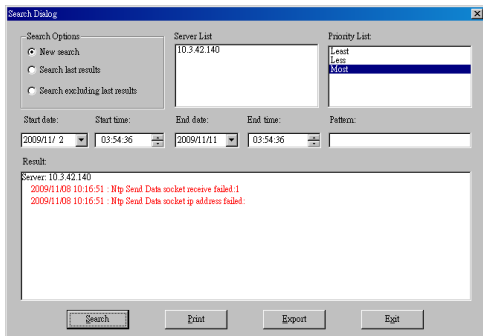

A description of the items is given in the table below:

Item	Explanation
New Search	This is one of three radio buttons that define the scope of the search. If it is selected, the search is performed on all the events in the database for the selected SV1108IPEXT/POW.
Search Last Results	This is a secondary search performed on the events that resulted from the last search.
Search Excluding Last Results	This is a secondary search performed on all the events in the database for the selected SV1108IPEXT/POW excluding the events that resulted from the last search.
Server List	SV1108IPEXT/POW units are listed according to their IP address. Select the unit that you want to perform the search on from this list. You can select more than one unit for the search. If no units are selected, the search is performed on all of them.
Priority List	Sets the level for how detailed the search results display should be. Least is the most general; Most is the most specific. Least results appear in black; Less results appear in blue; Most results appear in red.
Start Date	Select the date that you want the search to start from. The format follows the YYYY/MM/DD convention, as follows: 2009/11/04
Start Time	Select the time that you want the search to start from.
End Date	Select the date that you want the search to end at.
End Time	Select the time that you want the search to end at.
Pattern	Key in the pattern that you are searching for here. The multiple character wildcard (*) is supported. E.g., h*ds would match hands and hoods.
Results	Lists the events that contained matches for the search.
Search	Click this button to start the search.
Print	Click this button to print the search results.
Export	Click this button to write the search results to a .txt file.
Exit	Click this button to exit the Search dialog box.

Maintenance

This function allows the administrator to perform manual maintenance of the database, such as erasing specified records before the expiration time that was set with the *Limit* setting of the Edit function

Options

Network Retry allows you to set the number of seconds that the Log Server should wait before attempting to connect if the previous attempt to connect failed. When you click this item, a dialog box, similar to the one below appears:

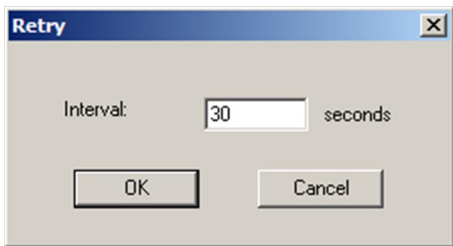

Key in the number of seconds, then click **OK** to finish.

Help

From the Help Menu, click Contents to access the online Windows Help file. The help file contains instructions about how to setup, operation and troubleshoot the Log Server.

The Log Server Main Screen

The Log Server Main Screen is divided into two main panels.

The upper (List) panel lists the SV1108IPEXT/POW units that have been selected for the Log Server to track

The lower (Event) panel displays the log events for the currently selected SV1108IPEXT/POW (the highlighted one - if there are more than one). To select a SV1108IPEXT/POW unit in the list, simply click on it.

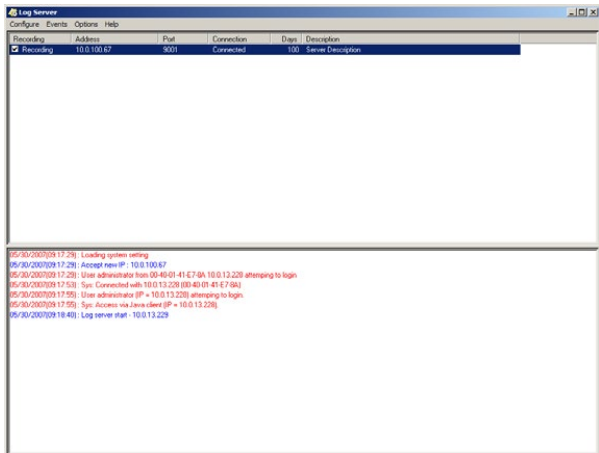

The List Panel

The List panel contains six fields:

Field	Explanation
Recording	<p>Determines whether the Log Server records log events for this SV1108IPEXT/POW or not. If the Recording check box is checked, the field displays <i>Recording</i>, and log events are recorded. If the Recording check box is not checked, the field displays <i>Paused</i>, and log events are not recorded.</p> <p>NOTE: Even though a SV1108IPEXT/POW is not the currently selected one, if its Recording check box is checked, the Log Server will still record its log events.</p>
Address	<p>This is the IP Address or DNS name that was given to the SV1108IPEXT/POW when it was added to the Log Server.</p>
Port	<p>This is the port number that was assigned to the SV1108IPEXT/POW when it was added to the Log Server.</p>
Connection	<p>If the Log Server is connected to the SV1108IPEXT/POW, this field displays <i>Connected</i>.</p> <p>If it is not connected, this field displays <i>Waiting</i>. This means that the Log Server's MAC address and/or port number has not been set properly. It needs to be set in the <i>ANMS</i> settings and specified in the <i>Configure</i> dialog box.</p>
Days	<p>This field displays the number of days that the SV1108IPEXT/POW's log events are to be kept in the Log Server's database before expiration.</p>

Field	Explanation
Description	This field displays the descriptive information given for the SV1108IPEXT/POW when it was added to the Log Server.

The Tick Panel

The lower panel displays tick information for the currently selected SV1108IPEXT/POW. Note that if the installation contains more than one switch, even though a switch isn't currently selected, if its Recording checkbox is checked, the Log Server records its tick information and keeps it in its database.

AP Operation

In addition to the browser based client viewers, the SV1108IPEXT/POW also provides stand-alone Windows and Java applications that can be used without a browser. The applications can be found on the SV1108IPEXT/POW software CD. The Windows Client AP is called SV1108IPEXT/POWwinclient.exe; the Java Client AP is called iClient.jar.

The Windows Client AP

Installation

To install the stand-alone Windows Client program, do the following:

1. Copy SV1108IPEXT/POWwinclient.exe from the software CD to a convenient location on your hard disk.
2. Run the program and follow along with the installation dialog boxes. When the installation completes, an icon – SV1108IPEXT/POW WinClient – is placed on your desktop and a program entry is made in the Windows Start menu: (Start ► All Programs ► SV1108IPEXT/POW ► WinClient).

Starting Up

To connect to the SV1108IPEXT/POW, either click its icon on the desktop or click its entry on the Start menu.

If this is the first time that you are running the utility, a dialog box appears requesting you to input your serial number.



The serial number can be found on the SV1108IPEXT/POW's CD case. Key in the serial number – 5 characters per box – then click OK to bring up the SV1108IPEXT/POW Connection Screen.

NOTE:

1. Letters in the serial number must be entered in capitals.
2. This dialog box only appears the first time you run the program. In the future, you go directly to the Windows Client Connection screen.

The Windows Client Connection Screen

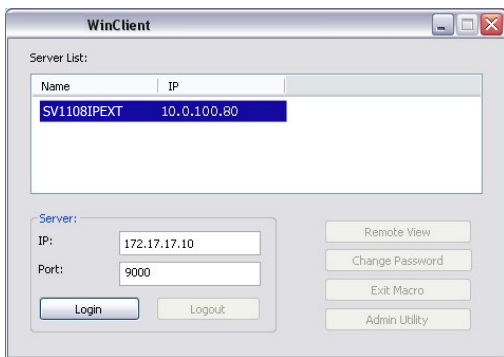

A description of the Connection Screen is given in the following table:

Item	Description
Server List	Each time the SV1108IPEXT/POW iClient program is run, it searches the user's local LAN segment for SV1108IPEXT/POW units, and lists whichever ones it finds in this box. If you want to connect to one of these units, select it, then click Login. When you have finished with your session, Click Logout to end the connection.

Item	Description
Server	<p>This area is used when you want to connect to a SV1108IPEXT/POW at a remote location. If the IP address that appears isn't the one you want, or if there is no entry at all, key in the IP address you want.</p> <p>Next, key in the Port number in the Port field. If you don't know the Port number, contact the Administrator.</p> <p>When the IP address and Port number for the unit you wish to connect to have been specified, click Login to start the connection. When you have finished with your session, Click Logout to end the connection.</p>
Login	Starts the connection to the SV1108IPEXT/POW.
Logout	
Remote View	
Change Password	These buttons become active once you log into the SV1108IPEXT/POW.
Exit Macro	
Admin Utility	

Logging In

Once the SV1108IPEXT/POW connects to the unit you specified, a login window appears:

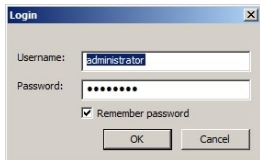

Provide a valid Username and Password, then Click OK to continue.

NOTE: The default Username is administrator; the default Password is password. For security, we strongly recommend that you change these to something unique. After you have successfully logged in, the Connection screen reappears:

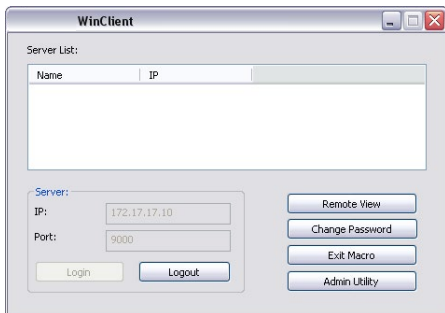

At this time there are five active buttons, as described in the table, below:

Button	Action
Logout	Breaks the connection to the SV1108IPEXT/POW.
Remote View	In some cases, administrator's do not wish to have users connect to the SV1108IPEXT/POW with a browser. Remote View solves this problem. It opens a window on the user's desktop containing the remote server's display that is the same as the one that appears with the browser-based Windows client.
Change Password	Allows users to change their passwords without administrator intervention.
Exit Macro	Exit Macro provides administrators with a non-browser based method for creating exit macros.
Admin Utility	The Administrator Utility provides administrators with a non-browser based method for configuring and controlling SV1108IPEXT/POW operations. The Administrator Utility is discussed in the sections that follow.

The Administrator Utility

The Administrator Utility appears as a tabbed notebook. Each tab represents a different administrative function. A description of the functions and how to configure their settings is provided in the sections that follow.

Device Information

The Settings notebook opens with the *Device Info* page displayed:

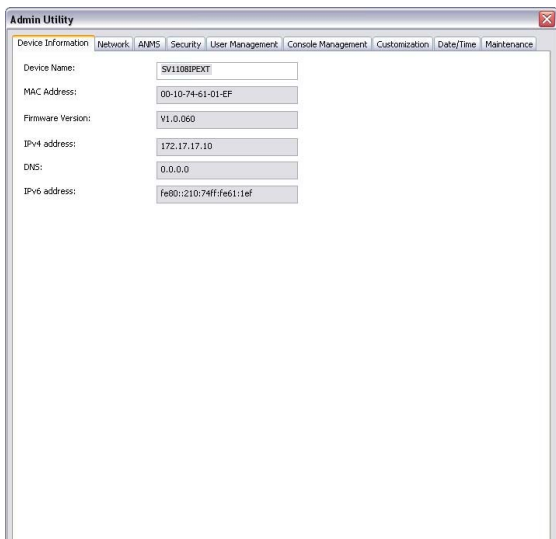

The screenshot shows a window titled "Admin Utility" with a tabbed interface. The "Device Information" tab is selected. The page contains several fields for device configuration:

Field	Value
Device Name:	SV1108IPEXT
MAC Address:	00-10-74-61-01-EF
Firmware Version:	V1.0.060
IPv4 address:	172.17.17.10
DNS:	0.0.0.0
IPv6 address:	fe80::210:74ff:fe61:1ef

This page is essentially the same as the browser-based version.

Network

This page is used to specify the SV1108IPEXT/POW's network environment.

The screenshot shows the 'Admin Utility' window with the 'Network' tab selected. The window has a title bar with a close button and a menu bar with options: Device Information, Network, ANMS, Security, User Management, Console Management, Customization, Date/Time, and Maintenance. The main content area is divided into three sections: Service Ports, IP Address, and DNS Server. The Service Ports section contains input fields for HTTP (80), HTTPS (443), Telnet Port (23), Program (9000), Virtual Media (9003), and SSH Port (22). The IP Address section has radio buttons for 'Obtain IP address automatically [DHCP]' and 'Set IP address manually [Fixed IP]', with the latter selected. Below are input fields for IP Address (172 . 17 . 17 . 10), Subnet Mask (255 . 255 . 255 . 0), and Default Gateway (172 . 17 . 17 . 254). The DNS Server section has radio buttons for 'Obtain DNS server address automatically' and 'Set DNS server address manually', with the latter selected. Below are input fields for Preferred DNS server (0 . 0 . 0 . 0) and Alternate DNS server (0 . 0 . 0 . 0). At the bottom, there is a 'Network Transfer Rate' field set to 99999 Kbps. 'OK' and 'Cancel' buttons are located at the bottom right of the window.

Service Ports	
HTTP:	80
Program:	9000
HTTPS:	443
Virtual Media:	9003
Telnet Port:	23
SSH Port:	22

IP Address

Obtain IP address automatically [DHCP]
 Set IP address manually [Fixed IP]

IP Address:	172 . 17 . 17 . 10
Subnet Mask:	255 . 255 . 255 . 0
Default Gateway:	172 . 17 . 17 . 254

DNS Server

Obtain DNS server address automatically
 Set DNS server address manually

Preferred DNS server:	0 . 0 . 0 . 0
Alternate DNS server:	0 . 0 . 0 . 0

Network Transfer Rate: 99999 Kbps

OK Cancel

This page is essentially the same as the browser-based version.

ANMS

The Advanced Network Management Settings dialog box allows you to set up login authorization management from a external sources.

The screenshot shows the 'Admin Utility' dialog box with the 'ANMS' tab selected. The 'Security' sub-tab is active, displaying various configuration options:

- IP Installer:** Enabled, View Only, Disabled
- SMTP Settings:**
 - Enable report from the following SMTP server
 - SMTP Server: [text box]
 - Server requires authentication
 - Account Name: [text box]
 - Password: [text box]
 - From: [text box]
 - To: [text box]
 - Report IP address
 - Report system reboot
 - Report user login
 - Report user logout
- Log Server:**
 - Enable
 - MAC Address: [text box] (000000000000)
 - Service Port: [text box] (9001)
- SNMP Server:**
 - Enable SNMP Agent
 - Server IP: [text box]
 - Service Port: [text box] (162)
- Syslog Server:**
 - Enable
 - Server IP: [text box]
 - Service Port: [text box] (514)
- DONS:**
 - Enable
 - Host Name: [text box]
 - User Name: [text box]
 - DDNS: [text box] (dyndns.org)
 - Password: [text box]
 - DONS Retry Time: [text box] (0) hours
- RADIUS Settings:**
 - Enable
 - Primary RADIUS Server IP: [text box]
 - Port: [text box] (1812)
 - Alternate RADIUS Server IP: [text box]
 - Port: [text box] (1812)
 - Timeout (seconds): [text box] (5)
 - Retries: [text box] (3)
 - Shared Secret (at least 6 characters): [text box]
- LDAP Settings:**
 - Enable
 - LDAP, LDAPS, Enable Authorization
 - LDAP Server IP: [text box]
 - Port: [text box] (636)
 - Timeout (seconds): [text box] (10)
 - LDAP Administrator DN: [text box]
 - LDAP Administrator Password: [text box]
 - Search DN: [text box]
 - Admin Group: [text box]
- CC Management:**
 - Enable
 - CC Server IP: [text box]
 - Port: [text box]

Buttons: OK, Cancel

The settings on this page are essentially the same as that of the browser-based version.

Security

The Security page is used to control access to the SV1108IPEXT/POW.

Admin Utility

Device Information Network ANMS **Security** User Management Console Management Customization Date/Time Maintenance

User Station Filters

IP Filter Enable Include Exclude
Add
Edit
Delete

MAC Filter Enable Include Exclude
Add
Edit
Delete

Login String:

Encryption

Keyboard/Mouse
 DES 3DES AES RC4 Random

Video
 DES 3DES AES RC4 Random

Virtual Media
 Read Only Read/Write

Account Policy

Minimum Username Length:

Minimum Password Length:

Password Must Contain At Least

One Upper Case
 One Lower Case
 One Number Case

Disable Duplicate Login

Private Certificate

Private Key:

Certificate:

Login Failures

Enable

Allowed: Timeout: minutes

Lock Client PC
 Lock Account

Others

Browser Service:

Disable Authentication

The settings on this page are essentially the same as that of the browser-based version.

User Management

This page is used to set up and manage user profiles. It defines the access rights of each user. Up to 64 user profiles can be established

The screenshot shows the 'Admin Utility' window with the 'User Management' tab selected. The 'User list' on the left contains the entry 'administrator'. The 'User Info' section on the right includes input fields for 'User Name', 'Password', 'Confirm password', and 'Description'. Below these fields are radio buttons for 'Admin', 'User', and 'Select' (which is selected). The 'Permissions' section contains several checkboxes: 'Win Client', 'View Only', 'Power Management', 'Enable Telnet/SSH', 'Enable Virtual Media', 'Java Client', 'Configure', and 'Log'. There are also two dropdown menus: 'Telnet' (set to 'Telnet') and 'Read Only' (set to 'Read Only'). A 'Reset' button is located at the bottom right of the form area. At the bottom of the window, there are three buttons: 'Add', 'Update', and 'Remove'. At the very bottom of the window are 'OK' and 'Cancel' buttons.

The settings on this page are essentially the same as that of the browser-based version.

Console Management

This page is used to set up the operating parameters for the SV1108IPEXT/POW's RS-232 (serial) port.

Serial Console

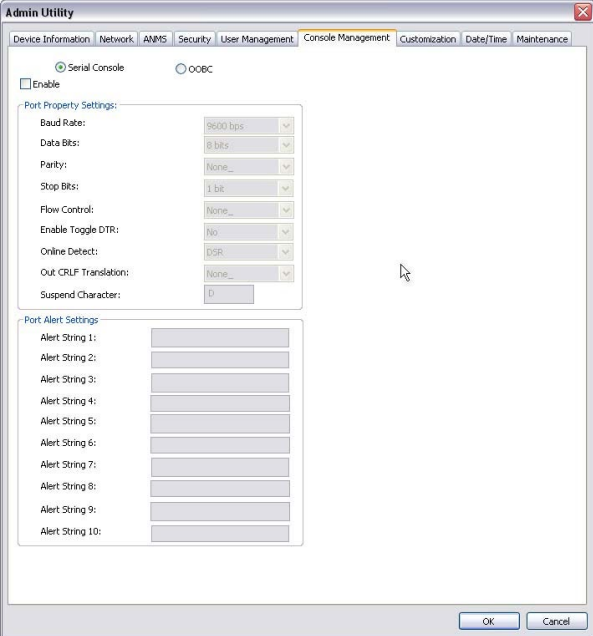

The screenshot shows the 'Admin Utility' window with the 'Console Management' tab selected. The 'Serial Console' radio button is selected, and the 'Enable' checkbox is checked. The 'Port Property Settings' section includes dropdown menus for Baud Rate (9600 bps), Data Bits (8 bits), Parity (None), Stop Bits (1 bit), Flow Control (None), Enable Toggle DTR (No), Online Detect (DSR), and Out CRLF Translation (None), along with a text input for Suspend Character (D). The 'Port Alert Settings' section contains ten text input fields for Alert String 1 through Alert String 10. 'OK' and 'Cancel' buttons are at the bottom right.

Setting	Value
Enable	<input checked="" type="checkbox"/>
Baud Rate	9600 bps
Data Bits	8 bits
Parity	None
Stop Bits	1 bit
Flow Control	None
Enable Toggle DTR	No
Online Detect	DSR
Out CRLF Translation	None
Suspend Character	D
Alert String 1	
Alert String 2	
Alert String 3	
Alert String 4	
Alert String 5	
Alert String 6	
Alert String 7	
Alert String 8	
Alert String 9	
Alert String 10	

The settings on this page are essentially the same as that of the browser-based version.

Admin Utility

Device Information | Network | ANMS | Security | User Management | **Console Management** | Customization | Date/Time | Maintenance

Serial Console OOBC

PPP Settings

Enable Out of Band Access

Enable Dial Back

Enable Fixed Number DialBack

 Phone Number:

Enable Flexible Dial Back

 Use username as dial back phone number

 Password:

Enable Dial Out

ISP Settings

 Phone Number:

 User Name:

 Password:

Dial Out Schedule

Every:

Daily at:

 PPP online time: minute(s)

Emergency dial out

PPP keeps online until network: recovery

PPP online time: minute(s)

Dial Out Mail Configuration

 SMTP Server IP Address:

 Email From:

 To:

SMTP server requires authentication

 Account Name:

 Password:

OK Cancel

The settings on this page are essentially the same as that of the browser-based version.

Customization

This page allows the Administrator to upgrade the firmware and to set to set *Timeout*, *Login failure*, and *Working mode* parameters.

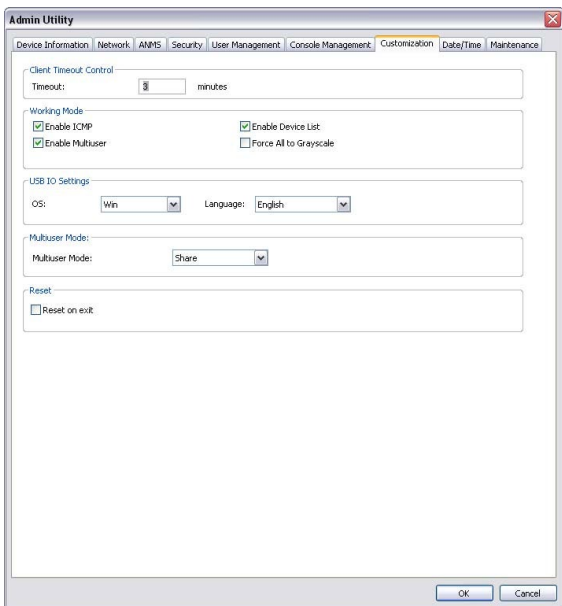

The screenshot shows the 'Admin Utility' window with the 'Customization' tab selected. The window contains several sections for configuration:

- Client Timeout Control:** A text input field for 'Timeout' containing the value '3', followed by the text 'minutes'.
- Working Mode:** A section with four checkboxes: 'Enable ICMP' (checked), 'Enable Multuser' (checked), 'Enable Device List' (checked), and 'Force All to Grayscale' (unchecked).
- USB IO Settings:** A section with two dropdown menus: 'OS' set to 'Win' and 'Language' set to 'English'.
- Multuser Mode:** A section with a dropdown menu for 'Multuser Mode' set to 'Share'.
- Reset:** A section with a checkbox for 'Reset on exit' which is currently unchecked.

At the bottom right of the window are 'OK' and 'Cancel' buttons.

The settings on this page are essentially the same as that of the browser-based version.

Date/Time

This page sets the SV1108IPEXT/POW time parameters:

The screenshot shows the 'Admin Utility' window with the 'Date/Time' tab selected. The configuration is as follows:

- Time Zone:** (GMT+08:00) Taipei
- Daylight Savings Time
- Date:** A calendar for February 2011, with the 14th selected.
- Time:** 13:58:31, with a 'Set' button.
- Network Time:**
 - Enable auto adjustment
 - Preferred time server:** AU | ntp1.cs.mu.OZ.AU
 - Preferred custom server IP: 0 . 0 . 0 . 0
 - Alternate time server: AU | ntp1.cs.mu.OZ.AU
 - Alternate custom server IP: 0 . 0 . 0 . 0
 - Adjust time every: 1 days
 - Adjust Time Now button

Buttons for 'OK' and 'Cancel' are located at the bottom right of the window.

The settings on this page are essentially the same as that of the browser-based version.

Maintenance

This page allows the Administrator to upgrade the SV1108IPEXT/POW's firmware, and to backup and restore the SV1108IPEXT/POW's configuration settings and user profile information.

The screenshot shows the 'Admin Utility' window with the 'Maintenance' tab selected. The window contains three main sections: 'Firmware Upgrade', 'Backup', and 'Restore'.
1. **Firmware Upgrade:** Includes a checked checkbox for 'Check Firmware Version', a text field for 'Firmware File', a 'Browse...' button, and an 'Upgrade Firmware' button.
2. **Backup:** Includes a 'Password:' text field and a 'Backup' button.
3. **Restore:** Includes a 'Restore File:' text field, a 'Browse...' button, a 'Password:' text field, and a 'Restore' button. Below these are radio buttons for 'All', 'User Account', and 'Configuration'. The 'Configuration' radio button is selected. Underneath are several checked checkboxes for various settings: Device Information, Network - DNS Server, Console Management, User Account, Network - Service Ports, ANMS, Customization, Network - IP Address, Security, and Date/Time.
At the bottom right of the window are 'OK' and 'Cancel' buttons.

The settings on this page are essentially the same as that of the browser-based version.

The Java Client AP

The Java Client AP is provided to make the SV1108IPEXT/POW accessible to all platforms. Systems that have JRE 6 Update 3 or higher installed can connect. If you don't already have Java, it is available for free download from Sun's Java web site (<http://java.sun.com>).

Starting Up

To connect to the SV1108IPEXT/POW with the stand-alone Java Client program, copy iClientJ.jar to a convenient location on your hard disk; then double-click its icon – or key in the full path to the program on the command line – to bring up the Java Client Connection screen.

NOTE: If this is the first time that you are running the program a dialog box appears requesting you to input your serial number.

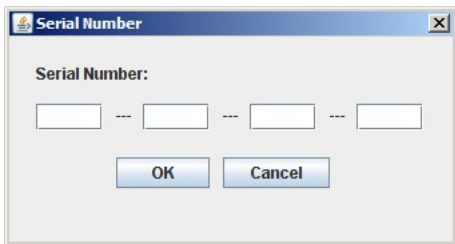

The serial number can be found on the SV1108IPEXT/POW's CD case. Key in the serial number - 5 characters per box - then click **OK** to bring up the SV1108IPEXT/POW Connection Screen.

After performing this operation the first time you run the program, this dialog box doesn't appear again – you go directly to the Java Client Connection screen.

The Java Client Connection Screen

Name	IP
SV1108IPEXT	10.0.1.214

Server IP:

Port:

To connect to the SV1108IPEXT/POW

1. Key in its IP address in the Server field.
2. If the port number shown isn't correct, key in the correct number.
3. Click **Connect**.

Logging In

Once the SV1108IPEXT/POW connects to the unit you specified, a login window appears:

Username:

Password:

Remember password

Provide a valid Username and Password, then Click **OK**.

NOTE: The default Username is *administrator*; the default Password is *password*. For security, we strongly recommend that you change these to something unique.

After you have successfully logged in, the Connection screen reappears – this time with 5 active buttons:

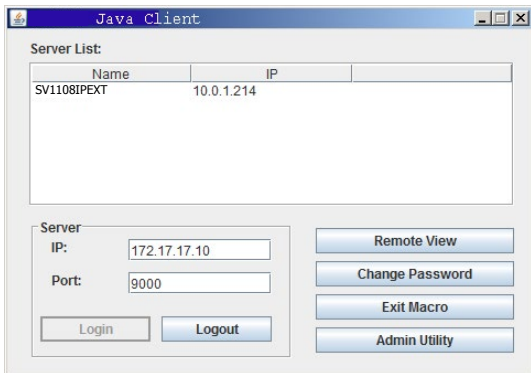

These function the same way as the ones described in the Windows Client AP section.

Java Client AP operation is essentially the same as Windows Client AP operation. Refer to the relevant Windows Client AP sections for operation details.

Appendix

Safety Instructions

General

Read all of these instructions. Save them for future reference.

Follow all warnings and instructions marked on the device.

Do not place the device on any unstable surface (cart, stand, table, etc.). If the device falls, serious damage will result.

Do not use the device near water.

Do not place the device near, or over, radiators or heat registers. The device cabinet is provided with slots and openings to allow for adequate ventilation. To ensure reliable operation, and to protect against overheating, these openings must never be blocked or covered.

The device should never be placed on a soft surface (bed, sofa, rug, etc.) as this will block its ventilation openings. Likewise, the device should not be placed in a built in enclosure unless adequate ventilation has been provided.

Never spill liquid of any kind on the device.

Unplug the device from the wall outlet before cleaning. Do not use liquid or aerosol cleaners. Use a damp cloth for cleaning.

The device should be operated from the type of power source indicated on the marking label. If you are not sure of the type of power available, consult your dealer or local power company.

To prevent damage to your installation it is important that all devices are properly grounded.

The device is equipped with a 3-wire grounding type plug. This is a safety feature. If you are unable to insert the plug into the outlet, contact your electrician to replace your obsolete outlet. Do not attempt to defeat the purpose of the grounding-type plug. Always follow your local/national wiring codes.

Do not allow anything to rest on the power cord or cables. Route the power cord and cables so that they cannot be stepped on or tripped over.

If an extension cord is used with this device make sure that the total of the ampere ratings of all products used on this cord does not exceed the

extension cord ampere rating. Make sure that the total of all products plugged into the wall outlet does not exceed 15 amperes.

To help protect your system from sudden, transient increases and decreases in electrical power, use a surge suppressor, line conditioner, or un-interruptible power supply (UPS).

Position system cables and power cables carefully; Be sure that nothing rests on any cables.

When connecting or disconnecting power to hot-pluggable power supplies, observe the following guidelines:

- Install the power supply before connecting the power cable to the power supply.

- Unplug the power cable before removing the power supply.

- If the system has multiple sources of power, disconnect power from the system by unplugging all power cables from the power supplies.

Never push objects of any kind into or through cabinet slots. They may touch dangerous voltage points or short out parts resulting in a risk of fire or electrical shock.

Do not attempt to service the device yourself. Refer all servicing to qualified service personnel.

If the following conditions occur, unplug the device from the wall outlet and bring it to qualified service personnel for repair. The power cord or plug has become damaged or frayed.

- Liquid has been spilled into the device.

- The device has been exposed to rain or water.

- The device has been dropped, or the cabinet has been damaged. The device exhibits a distinct change in performance, indicating a need for service.

- The device does not operate normally when the operating instructions are followed.

Only adjust those controls that are covered in the operating instructions. Improper adjustment of other controls may result in damage that will require extensive work by a qualified technician to repair.

The socket-outlet shall be installed near the equipment and shall be easily accessible.

Inlet power cord selection: Detachable, maximum 2.0 m long, 18 AWG, flexible cord (125V, 10A, 3C, NEMA 5-15P). Or, 0.75mm², 3G, flexible cord (E.g.: H05VV-F, 250V 10A).

Rack Mounting

Before working on the rack, make sure that the stabilizers are secured to the rack, extended to the floor, and that the full weight of the rack rests on the floor. Install front and side stabilizers on a single rack or front stabilizers for joined multiple racks before working on the rack.

Always load the rack from the bottom up, and load the heaviest item in the rack first.

Make sure that the rack is level and stable before extending a device from the rack.

Use caution when pressing the device rail release latches and sliding a device into or out of a rack; the slide rails can pinch your fingers.

After a device is inserted into the rack, carefully extend the rail into a locking position, and then slide the device into the rack.

Do not overload the AC supply branch circuit that provides power to the rack. The total rack load should not exceed 80 percent of the branch circuit rating.

Make sure that all equipment used on the rack – including power strips and other electrical connectors – is properly grounded.

Ensure that proper airflow is provided to devices in the rack.

Ensure that the operating ambient temperature of the rack environment does not exceed the maximum ambient temperature specified for the equipment by the manufacturer

Do not step on or stand on any device when servicing other devices in a rack.



CAUTION: Slide/rail mounted equipment is not to be used as a shelf or a workspace.

IP Address Determination

If you are an administrator logging in for the first time, you will need to access the SV1108IPEXT/POW in order to give it an IP address that users can connect to. There are three methods to choose from. In each case, your computer must be on the same network segment as the SV1108IPEXT/POW. After you have connected and logged in you can enter its fixed network address.

IP Installer

For computers running Windows, an IP address can be assigned with the IP Installer utility:

1. On the Software CD that came with your SV1108IPEXT/POW package, go to the directory that the IPInstaller program resides in, and run *IPInstaller.exe*. A dialog box similar to the one below appears:

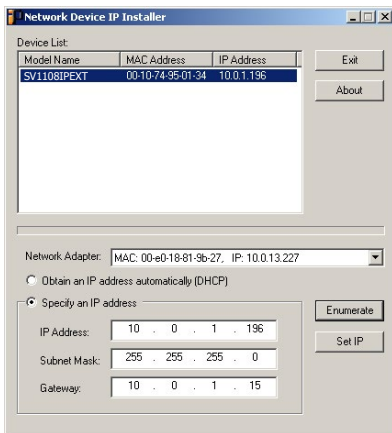

2. Select your device in the Device List.

NOTE:

1. If the list is empty, or your device doesn't appear, click Enumerate to refresh the Device List.
2. If there is more than one device in the list, use the MAC address to pick the one you want. The SV1108IPEXT/POW's MAC address is located on its bottom panel.

3. Select either *Obtain an IP address automatically* (DHCP), or *Specify an IP address*. If you chose the latter, fill the IP Address, Subnet Mask, and Gateway fields with the information appropriate to your network.
4. Click **Set IP**.
5. After the IP address shows up in the Device List, click **Exit**.

Browser

1. Set your computer's IP address to 192.168.0.XXX Where XXX represents any number or numbers except 60. (192.168.0.60 is the default address of the SV1108IPEXT/POW.)
2. Specify the switch's default IP address (192.168.0.60) in your browser, and you will be able to connect.
3. Assign a fixed IP address for the SV1108IPEXT/POW that is suitable for the network segment that it resides on.
4. After you log out, reset your computer's IP address to its original value.

AP Windows Client

For computers running Windows, the SV1108IPEXT/POW's IP address can be determined with the Windows AP program. When you run the program it searches the network segment for SV1108IPEXT/POW devices, and displays the results in a dialog box similar to the one below:

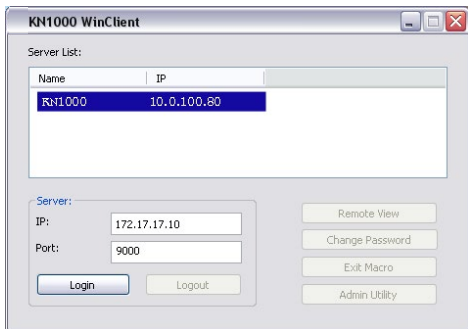

You can now use this network address, or you can change it by clicking Login, logging in, clicking Admin Utility, and clicking the Network tab.

IPv6

At present, the SV1108IPEXT/POW supports two IPv6 address protocols: *Link Local IPv6 Address*, and *IPv6 Stateless Autoconfiguration*

Link Local IPv6 Address

At power on, the SV1108IPEXT/POW is automatically configured with a Link Local IPv6 Address (for example, fe80::210:74ff:fe61:1ef). To find out what the Link Local IPv6 Address is, log in with the SV1108IPEXT/POW's IPv4 address and click the *Device Information* icon. The address is displayed at the bottom of the *Device Information* page (see page 32).

Once you have determined what the IPv6 address is, you can use it when logging in from a browser or the Win and Java Client AP programs.

For Example:

If you are logging in from a browser, you would key in

http://[fe80::2001:74ff:fe6e:59%5] for the URL bar.

If you are logging in with the AP program, you would key:

fe80::2001:74ff:fe6e:59%5

for the IP field of the Server panel (see The Windows Client Connection Screen, page 132).

NOTE:

1. To log in with the Link Local IPv6 Address, the client computer must be on the same local network segment as the SV1108IPEXT/POW
2. The %5 is the %interface used by the client computer. To see your client computer's IPv6 address: from the command line issue the following command: `ipconfig /all`. The % value appears at the end of the IPv6 address.

IPv6 Stateless Autoconfiguration

If the SV1108IPEXT/POW's network environment contains a device (such as a router) that supports the IPv6 Stateless Autoconfiguration function, the SV1108IPEXT/POW can obtain its prefix information from that device in order to generate its IPv6 address. For example, 2001::74ff:fe6e:59.

As above, the address is displayed at the bottom of the *Device Information* page.

Once you have determined what the IPv6 address is, you can use it when logging in from a browser or the Win and Java Client AP programs.

For Example:

If you are logging in from a browser, you would key in

http://[2001::74ff:fe6e:59] for the URL bar.

If you are logging in with the AP program, you would key:

2001::74ff:fe6e:59

Port Forwarding







For devices located behind a router, port forwarding allows the router to pass data coming in over a specific port to a specific device. By setting the port forwarding parameters, you tell the router which device to send the data coming in over a particular port to.







For example, if the SV1108IPEXT/POW connected to a particular router has an IP address of 192.168.1.180, you would log into your router's setup program and access the Port Forwarding (sometimes referred to as *Virtual Server*) configuration page. You would then specify 192.168.1.180 for the IP address and the port number you want opened for it (9000 for internet access, for example).

Since configuration setup can vary somewhat for each brand of router, refer to the router's User Manual for specific information on configuring port forwarding for it.

Keyboard Emulation

The PC compatible (101/104 key) keyboard can emulate the functions of the Sun and Mac keyboards. The emulation mappings are listed in the table below.

PC Keyboard	Sun Keyboard
[Ctrl] [I]	Stop
[Ctrl] [F2]	Again
[Ctrl] [F3]	Props
[Ctrl] [F4]	Undo
[Ctrl] [F5]	Front
[Ctrl] [F6]	Copy
[Ctrl] [F7]	Open
[Ctrl] [F8]	Paste
[Ctrl] [F9]	Find
[Ctrl] [F10]	Cut
[Ctrl] [1]	
[Ctrl] [2]	
[Ctrl] [3]	
[Ctrl] [4]	
[Ctrl] [H]	Help
	Compose
	

PC Keyboard	Mac Keyboard
[Shift]	Shift
[Ctrl]	Ctrl
	
[Ctrl] [1]	
[Ctrl] [2]	
[Ctrl] [3]	
[Ctrl] [4]	
[Alt]	Alt
[Print Screen]	F13
[Scroll Lock]	F14
	=
[Enter]	Return
[Backspace]	Delete
[Insert]	Help
[Ctrl] 	F15

NOTE: When using key combinations, press and release the first key (Ctrl), then press and release the activation key.

PPP Modem Operation

Basic Setup

In addition to the browser and AP methods, the SV1108IPEXT/POW can also be accessed through its RS-232 port using a PPP dial-in connection, as follows:

1. Set up your hardware configuration to match the diagram, below:



2. From your computer, use your modem terminal program to dial into the SV1108IPEXT/POW's modem.

NOTE:

1. If you don't know the SV1108IPEXT/POW modem's serial parameters, get them from the SV1108IPEXT/POW administrator.
2. An example of setting up a modem terminal program under Windows XP is provided on the next page.
3. Once the connection is established, open your browser, and specify **192.168.0.60** in the URL box.

From here, operation is the same as if you had logged in from a browser or with the AP programs.

Connection Setup Example (Windows XP)

To set up a dial-in connection to the SV1108IPEXT/POW under Windows XP, do the following:

1. From the *Start* menu, select Control Panel ► Network Connections ► Create a New Connection.
2. When the *Welcome to the New Connection Wizard dialog box* appears, click **Next** to move on.
3. In the *Network Connection Type dialog box*, select *Connect to the network at my workplace*, then click **Next**.
4. In the *Network Connection dialog box*, select *Dial-up connection*, then click **Next**.
5. In the *Connection Name dialog box*, key in a name for the connection (for example, TPE-SV1108IPEXT/POW-01), then click **Next**.
6. In the *Connection Availability dialog box*, you can select either *Anyone's use* or *My use only*, depending on your preferences, then click **Next**.

NOTE: If you are the only user on this computer, this dialog box won't appear.

7. In the *Phone Number to dial dialog box*, key in the phone number of the modem connected to the SV1108IPEXT/POW (be sure to include country and area codes, if necessary), then click **Next**.
8. In the *Completing the New Connection Wizard dialog box*, check **Add a shortcut to this connection on my desktop**, then click **Finish**.

This completes the connection setup. Double click the desktop shortcut icon to make a PPP connection to the SV1108IPEXT/POW.

Trusted Certificates

When you try to log in to the device from your browser, a Security Alert message appears to inform you that the device's certificate is not trusted, and asks if you want to proceed.

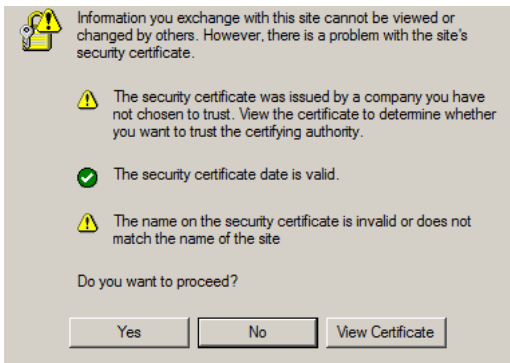

The certificate can be trusted, but the alert is triggered because the certificate's name is not found on Microsoft's list of Trusted Authorities.

You have two options:

1. You can ignore the warning and click **Yes** to go on;

or

2. You can install the certificate and have it be recognized as trusted.

If you are working on a computer at another location, accept the certificate for just this session by clicking **Yes**.

If you are working at your own computer, install the certificate on your computer (see below for details). After the certificate is installed, it will be recognized as trusted.

Installing the Certificate

To install the certificate, do the following:

1. In the Security Alert dialog box, click **View Certificate**. The Certificate Information dialog box appears:

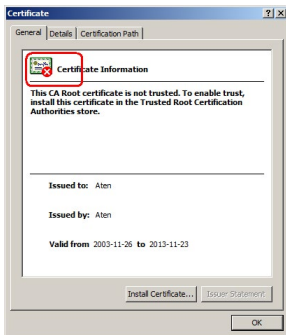

NOTE: There is a red and white X logo over the certificate to indicate that it is not trusted.

2. Click **Install Certificate**.
3. Follow the Installation Wizard to complete the installation. Unless you have a specific reason to choose otherwise, accept the default options.
4. When the Wizard presents a caution screen: Click **Yes**.



5. Next, click **Finish** to complete the installation; then click **OK** to close the dialog box.

Certificate Trusted

The certificate is now trusted:



When you click *View Certificate*, you can see that the red and white X logo is no longer present – further indication that the certificate is trusted:

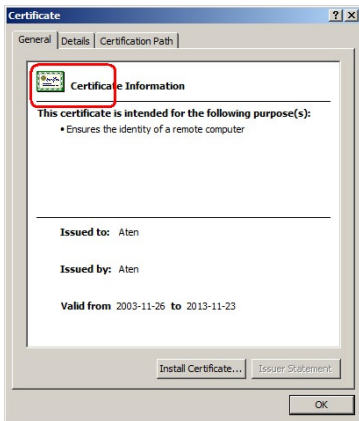

Mismatch Considerations

If the site name or IP address used for generating the certificate no longer matches the current address of the SV1108IPEXT/POW a mismatch warning occurs:



You can click Yes to go on, or you can disable mismatch checking.

To disable mismatch checking, do the following:

1. After the page you are logging in to comes up open the browser's Tools menu; Select *Internet Options* ► *Advanced*.
2. Scroll to the bottom of the list and uncheck *Warn about trusted certificates*:

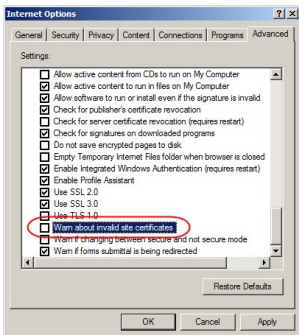

3. Click **OK**. The next time you run the browser the change will be in effect.

Self-Signed Private Certificates

If you wish to create your own self-signed encryption key and certificate, a free utility – `openssl.exe` – is available for download over the web at www.openssl.org. To create your private key and certificate do the following:

1. Go to the directory where you downloaded and extracted `openssl.exe` to.
2. Run `openssl.exe` with the following parameters:

```
openssl req -new -newkey rsa:1024 -days 3653 -nodes -x509 -keyout CA.key -out CA.cer -config openssl.cnf
```

NOTE:

1. The command should be entered all on one line (i.e., do not press [Enter] until all the parameters have been keyed in).
2. If there are spaces in the input, surround the entry in quotes (e.g., "ATEN International").

To avoid having to input information during key generation the following additional parameters can be used:

`/C /ST /L /O /OU /CN /emailAddress.`

Examples

```
openssl req -new -newkey rsa:1024 -days 3653 -nodes -x509 -keyout CA.key  
-out CA.cer -config openssl.cnf -subj /C=yourcountry/ST=yourstateorprovince/  
L=yourlocationor city/O=yourorganiztion/OU=yourorganizationalunit/  
CN=yourcommonname/emailAddress=name@yourcompany.com
```

```
openssl req -new -newkey rsa:1024 -days 3653 -nodes -x509 -keyout CA.key -out  
CA.cer -config openssl.cnf -subj /C=CA/ST=BC/L=Richmond/O="ATEN International"/  
OU=ATEN
```

```
/CN=ATEN/emailAddress=eservice@aten.com.tw
```

Importing the Files

After the `openssl.exe` program completes, two files – `CA.key` (the private key) and `CA.cer` (the self-signed SSL certificate) – are created in the directory that you ran the program from. These are the files that you upload in the *Private Certificate* panel of the Security page.

Troubleshooting

General Operation

Problem	Resolution
I can't access the SV1108IPEXT/POW, even though I have specified the IP address and port number correctly.	<p>The SV1108IPEXT/POW needs to be reset.</p> <p>If the SV1108IPEXT/POW is behind a router, the router's Port Forwarding (also referred to as Virtual Server) feature must be configured.</p>
Mouse pointer confusion	<p>If you find the display of two mouse pointers (local and remote) to be confusing or annoying, you can use the Toggle Mouse Display function to shrink the non-functioning pointer.</p>
Mouse movement extremely slow	<p>There is too much data being transferred for your connection to keep up with. Lower the video quality so that less video data is transmitted.</p>
Changing Mouse Sync Mode to Manual makes the SV1108IPEXT/POW crash.	<p>The SV1108IPEXT/POW hasn't crashed. You can wait approximately 5 minutes for normal operations to resume, or you can reset the SV1108IPEXT/POW to get it going right away.</p>
When I am in a web browser session, and making configuration changes, and I am timed out, the settings changes I have made are lost.	<p>If you don't click Apply, the SV1108IPEXT/POW isn't aware that you are working, and times you out. Without clicking Apply, none of your changes are recognized. You must click Apply as you go along in order to have the settings saved on the SV1108IPEXT/POW and reset the timeout counter.</p>
The Windows Client link doesn't appear in the Remote Console Display when I log in with Firefox.	<p>The Windows Client link requires ActiveX. Since Firefox doesn't support ActiveX only the Java Applet is available.</p>

Problem	Resolution
<p>When the remote server is running Fedora the mouse pointer on the remote server does not move, whether I am accessing it from the local console or a local client computer.</p>	<p>If the remote server is connected with a PS/2 cable, log into the SV1108IPEXT/POW with a browser; open a viewer; on the control panel set Mouse DynaSync to Manual.</p>
<p>When I log in, the browser generates a CA Root certificate is not trusted, or a Certificate Error response.</p>	<ol style="list-style-type: none"> 1. The certificate's name is not found on Microsoft's list of Trusted Authorities. The certificate can be trusted. 2. You can eliminate this message by importing a certificate issued by a recognized third party certificate authority.
<p>After I import the site's certificate, I still get a message warning me about the site when I log in.</p>	<p>Certificate security checking noticed a certificate address mismatch – however the certificate can be trusted. You can click Continue to the website (not recommended) to go on, or you can disable mismatch checking.</p>
<p>Remote mouse pointer is out of step.</p>	<ol style="list-style-type: none"> 1. Check the status of the Mouse DynaSync Mode setting. If it is set to Automatic, change the setting to Manual and refer to the information provided. 2. If you are in Manual mode, use the AutoSync feature, to sync the local and remote monitors. 3. If that doesn't resolve the problem, use the Adjust Mouse feature to bring the pointers back in step.
<p>Part of remote window is off my monitor.</p>	<p>Use the AutoSync feature, to sync the local and remote monitors.</p>
<p>Virtual Media doesn't work.</p>	<p>This problem sometimes arises on older computers. Get the latest firmware version for your mainboard from the manufacturer and upgrade your mainboard firmware.</p>

Problem	Resolution
<p>Under Virtual Media, I can mount an ISO file, but I cannot access it.</p>	<p>Virtual Media under the WindowsClient only supports ISO files less than 4G.Bytes. If the ISO file is 4GBytes or greater it cannot be accessed.</p>
<p>My antivirus program reports that there is a trojan after I access the SV1108IPEXT/POW with my browser and then open the Windows Client Viewer.</p>	<p>The Windows Client Viewer uses an ActiveX plugin (windows.ocx) that some antivirus programs mistakenly see as a virus or trojan. We have tested our firmware extensively and found no evidence of a virus or trojan. You can add the plugin to your antivirus program's White List and use the Viewer safely. If you are reluctant to use the Windows Client Viewer, however, you can simply use the Java Client Viewer, instead.</p>

Java

For mouse synchronization problems, see Macros, page 113, Mouse DynaSync Mode, page 120, and Sun / Linux, page 172. For other problems, see the table below:

Problem	Resolution
<p>Java Applet won't connect to the SV1108IPEXT/POW</p>	<ol style="list-style-type: none"> 1. Java 6 Update 3 or higher must be installed on your computer. 2. Make sure to include the correct login string when you specify the SV1108IPEXT/POW's IP address. 3. Close the Java Applet, reopen it, and try again.
<p>I have installed the latest Java JRE, but I am having performance and stability problems.</p>	<p>There may be issues with the latest version because it is so new. Try using a Java version that is one or two updates earlier than the latest one.</p>
<p>Java Applet performance deteriorates</p>	<p>Exit the program and start again.</p>

Problem	Resolution
<p>National language characters don't appear.</p>	<p>Use the SV1108IPEXT/POW's On-Screen Keyboard and be sure that the local and remote computers are set to the same language.</p>
<p>When I log in, the browser generates a CA Root certificate is not trusted, or a Certificate Error response.</p>	<p>The certificate's name is not found on Microsoft's list of Trusted Authorities. The certificate can be trusted.</p>
<p>There is no Virtual Media icon on my Control Panel.</p>	<p>The virtual media function only supports the Windows Client programs.</p>

Sun Systems

Problem	Resolution
<p>Video display problems with HDB15 interface systems (e.g., Sun Blade 1000 servers).1</p>	<p>The display resolution should be set to 1024 x 768:</p> <p>Under Text Mode:</p> <ol style="list-style-type: none"> Go to OK mode and issue the following com-mands: <pre>setenv output-device screen:r1024x768x60 reset-all</pre> <p>Under XWindow:</p> <ol style="list-style-type: none"> Open a console and issue the following command: <pre>m64config -res 1024x768x60</pre> Log out Log in

Problem	Resolution
<p>Video display problems with 13W3 interface systems (e.g., Sun Ultra servers).*</p>	<p>The display resolution should be set to 1024 x 768:</p> <p>Under Text Mode:</p> <ol style="list-style-type: none"> 1. Go to OK mode and issue the following commands: <code>setenv output-device screen:r1024x768x60 reset-all</code> <p>Under XWindow:</p> <ol style="list-style-type: none"> 1. Open a console and issue the following command: <code>m64config -res 1024x768x60</code> 2. Log out 3. Log in
<p>The local and remote mouse pointers do not sync</p>	<p>The default configuration is for the local and remote mouse pointers to automatically sync when you connect. Automatic mouse sync only supports USB mice on Windows and Mac (G4 or higher) systems, however. You must select Manual as the Mouse DynaSync Mode choice, and sync the pointers manually.</p>

NOTE: These solutions work for most common Sun VGA cards. If using them fails to resolve the problem, consult the Sun VGA card's manual.

Mac Systems

Problem	Resolution
The local and remote mouse pointers do not sync.	There are two USB I/O settings for the Mac: Mac 1, and Mac 2 (see Customization, page 66). In general, Mac 1 works with older operating system versions, whereas Mac 2 works with the newer ones. In some cases, however, the reverse is true. If you experience pointer sync problems, try selecting the other mode.
When I log in to the switch with my Safari browser, it hangs when I use the Snapshot feature.	Force close Safari, then reopen it. Don't use the Snapshot feature in the future. To use the Snapshot feature with Safari, upgrade to Mac OS 10.4.11 and Safari 3.0.4.

The Log Server

Problem	Resolution
The Log Server program does not run.	<p>The Log Server requires the Microsoft Jet OLEDB 4.0 driver in order to access the database.</p> <p>This driver is automatically installed with Windows ME, 2000 and XP.</p> <p>For Windows 98 or NT, you will have to go to the Microsoft download site: http://www.microsoft.com/data/download.htm to retrieve the driver file: MDAC 2.7 RTM Refresh (2.70.9001.0)</p> <p>Since this driver is used in Windows Office Suite, an alternate method of obtaining it is to install Windows Office Suite. Once the driver file or Suite has been installed, the Log Server will run.</p>

Additional Mouse Synchronization Procedures

If the mouse synchronization procedures mentioned in the manual fail to resolve mouse pointer problems for particular computers, try the following:

Windows:

NOTE: In order for the local and remote mice to synchronize, you must use the generic mouse driver supplied with the MS operating system. If you have a third party driver installed - such as one supplied by the mouse manufacturer - you must remove it.

1. Windows 2000:

- a) Open the Mouse Properties dialog box
(Control Panel → Mouse → Mouse Properties)
- b) Click the *Motion* tab
- c) Set the mouse speed to the middle position (6 units in from the left)
- d) Set the mouse acceleration to *None*

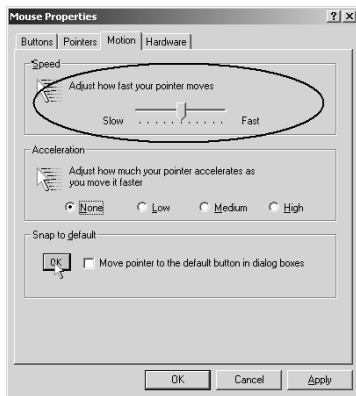

2. Windows XP / Windows Server 2003:

- a) Open the Mouse Properties dialog box (Control Panel → Mouse)
- b) Click the *Pointer Options* tab
- c) Set the mouse speed to the middle position (6 units in from the left)
- d) Disable *Enhance Pointer Precision*

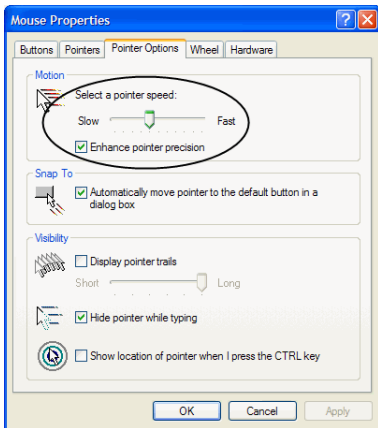

3. Windows ME:

Set the mouse speed to the middle position; disable mouse acceleration (click Advanced to get the dialog box for this).

4. Windows NT / Windows 98 / Windows 95:

Set the mouse speed to the slowest position.

Sun / Linux

Open a terminal session and issue the following command:

Sun: xset m 1

Linux: xset m 0 or xset m 1

(If one doesn't help, try the other.)

Virtual Media Support

WinClient ActiveX Viewer / WinClient AP

IDE CDROM/DVD-ROM Drives – Read Only

IDE Hard Drives – Read Only

USB CDROM/DVD-ROM Drives – Read Only

USB Hard Drives – Read/Write*

USB Flash Drives – Read/Write*

USB Floppy Drives – Read/Write

NOTE: These drives can be mounted either as Drives or Removable Disks. Mounting them as removable disks allow booting the remote server if the disk contains a bootable OS. In addition, if the disk contains more than one partition, the remote server can access all the partitions.

ISO Files – Read Only

Folders – Read/Write

Smart Card Readers

Java Applet Viewer / Java Client AP

ISO Files – Read Only

Folders – Read/Write

Administrator Login Failure

If you are unable to perform an Administrator login (because the Username and Password information has become corrupted, or you have forgotten it, for example), there is a procedure you can use to clear the login information.

To clear the login information do the following:

1. Power off the SV1108IPEXT/POW, disconnect the power cord from its inlet, and remove its housing.
2. Use a jumper cap to short the jumper on the mainboard labeled J6.

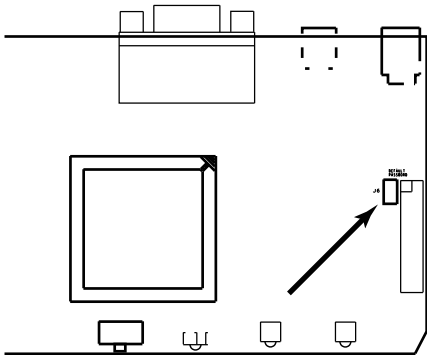

3. Power on the switch.
4. When the front panel LEDs flash, power off the switch.
5. Remove the jumper cap from J6.
6. Close the housing and power on the SV1108IPEXT/POW.
After you start back up, you can use the default Username and Password.

Specifications

	SV1108IPEXT	SV1108IPPOW
KVM Ports		1
Console Connectors (w/ included cable connected)		1 x VGA Male 2 x USB type A Female 2 x PS/2 Female
PC Connectors		1 x VGA Male 1 x USB type A Male 2 x PS/2 Male
Other Connectors	1 x DB9 Serial	1 x DB9 Serial 1 x IEC320 C14 Inlet 1 x IEC320 C13 Outlet
LEDs	3 (Power, Link, 10/100Mbps)	4 (Power, Power Outlet, Link, 10/100Mbps)
Max Resolution		1600x1200 @ 60Hz
Audio Support		No
Security		SSL, IP/Mac Filtering, 56-bit DES, 168-bit 3DES, 256-bit AES, 128-bit RC4
Supported Protocols		RADIUS, LDAP, LDAPS, Active Directory, TCP/IP, HTTP, HTTPS, UDP, DHCP, SSL, ARP, DNS, ICMP, CHAP, PPP
Cascadable		No
Rack Mountable		Yes
Enclosure Material		Metal
Power Consumption		6.3 W
Operating Temp.		0°C to 50°C (32°F to 122°F)
Storage Temp.		-20°C to 60°C (-4°F to 140°F)
Humidity		0~80% RH (Non-Condensing)
Dimensions (LxWxH)	200x81x25 mm	308x81x42 mm
Weight	490g	860g

Technical Support

StarTech.com's lifetime technical support is an integral part of our commitment to provide industry-leading solutions. If you ever need help with your product, visit www.startech.com/support and access our comprehensive selection of online tools, documentation, and downloads.

For the latest drivers/software, please visit www.startech.com/downloads

Warranty Information

This product is backed by a two year warranty.

In addition, StarTech.com warrants its products against defects in materials and workmanship for the periods noted, following the initial date of purchase. During this period, the products may be returned for repair, or replacement with equivalent products at our discretion. The warranty covers parts and labor costs only. StarTech.com does not warrant its products from defects or damages arising from misuse, abuse, alteration, or normal wear and tear.

Limitation of Liability

In no event shall the liability of StarTech.com Ltd. and StarTech.com USA LLP (or their officers, directors, employees or agents) for any damages (whether direct or indirect, special, punitive, incidental, consequential, or otherwise), loss of profits, loss of business, or any pecuniary loss, arising out of or related to the use of the product exceed the actual price paid for the product. Some states do not allow the exclusion or limitation of incidental or consequential damages. If such laws apply, the limitations or exclusions contained in this statement may not apply to you.

Hard-to-find made easy. At StarTech.com, that isn't a slogan. It's a promise.

StarTech.com is your one-stop source for every connectivity part you need. From the latest technology to legacy products — and all the parts that bridge the old and new — we can help you find the parts that connect your solutions.

We make it easy to locate the parts, and we quickly deliver them wherever they need to go. Just talk to one of our tech advisors or visit our website. You'll be connected to the products you need in no time.

Visit www.startech.com for complete information on all StarTech.com products and to access exclusive resources and time-saving tools.

StarTech.com is an ISO 9001 Registered manufacturer of connectivity and technology parts. StarTech.com was founded in 1985 and has operations in the United States, Canada, the United Kingdom and Taiwan servicing a worldwide market.